



FCC TEST REPORT

FCC ID: 2BGOP-N16U2-TU

On Behalf of

Shenzhen Dianye Technology Co., Ltd.

Notebook computer

Model No.: N16U2-TU, N16***** (“*” =0-9, A-Z, a-z, -, +, blank
or any character)

Prepared for : Shenzhen Dianye Technology Co., Ltd.
Address : 506, Building 1, Yibaolai Industrial City, Qiaotou Community, Fuhai
Street, Bao'an District, Shenzhen

Prepared By : Shenzhen PSI Testing Co., Ltd.
Address : 1-2/F., Building 5, Yudafu Industrial Park, No.10, Xingye West Road,
Shajing Subdistrict, Bao'an District, Shenzhen, Guangdong, China

Report Number : psi2502124-C01-R02
Date of Receipt : February 28, 2025
Date of Test : February 28, 2025-March 10, 2025
Date of Report : March 11, 2025
Version Number : V0

TABLE OF CONTENTS

Description	Page
1. Summary Of Standards And Results -----	6
1.1. Description of Standards and Results -----	6
2. General Information -----	7
2.1. Description of Device (EUT) -----	7
2.2. Accessories of Device (EUT) -----	8
2.3. Tested Supporting System Details-----	8
2.4. Block Diagram of Connection Between EUT and Simulators -----	8
2.5. Test Mode Description-----	8
2.6. Software test version and power setting information-----	9
2.7. Test Conditions-----	10
2.8. Test Facility-----	10
2.9. Measurement Uncertainty -----	10
2.10. Test Equipment List -----	11
3. Spurious Emission -----	12
3.1. Test Limits -----	12
3.2. Block Diagram of Test setup -----	15
3.3. Test Procedure -----	16
3.4. Test Results -----	17
4. Power Line Conducted Emission -----	22
4.1. Test Limits -----	22
4.2. Test Procedure -----	22
4.3. Test Setup -----	22
4.4. Test Results -----	23
5. Out-of-band Emissions -----	26
5.1. Test Limits -----	26
5.2. Test Procedure -----	26
5.3. Test Setup -----	26
5.4. Test Results -----	26
6. Conducted Maximum Output Power -----	32
6.1. Test limits -----	32
6.2. Test Procedure -----	32
6.3. Test Setup -----	32
6.4. Test Results -----	32
7. Peak Power Spectral Density -----	35
7.1. Test limits -----	35
7.2. Test Procedure -----	35
7.3. Test Setup -----	35
7.4. Test Results -----	36
8. Bandwidth -----	38
8.1. Test limits -----	38
8.2. Test Procedure -----	38
8.3. Test Setup -----	38
8.4. Test Results -----	38
9. Band Edge Test -----	43
9.1. Block Diagram of Test Setup-----	43
9.2. Test Limit-----	43
9.3. Test Procedure -----	43
9.4. Test Results -----	44
10. Frequency stability -----	45
10.1. Test limit-----	45
10.2. Test Procedure -----	45

10.3. Test Setup ----- 45
10.4. Test Results ----- 45
11. Antenna Requirement----- 46
11.1. Standard Requirement ----- 46
11.2. Antenna Connected Construction ----- 46
11.3. Results ----- 46
12. Photos of test setup ----- 47
13. Photos of EUT ----- 47



TEST REPORT DECLARATION

Applicant : Shenzhen Dianye Technology Co., Ltd.
 Address : 506, Building 1, Yibaolai Industrial City, Qiaotou Community, Fuhai Street, Bao'an District, Shenzhen
 Manufacturer : Shenzhen Dianye Technology Co., Ltd.
 Address : 506, Building 1, Yibaolai Industrial City, Qiaotou Community, Fuhai Street, Bao'an District, Shenzhen
 EUT Description : Notebook computer
 (A) Model No. : N16U2-TU, N16*****("*" =0-9, A-Z, a-z, -, +, blank or any character)
 (B) Trademark : N/A

Measurement Standard Used:

FCC Rules and Regulations Part 15 Subpart C Section 15.247

ANSI C63.10:2013

Test Result: PASS

The device described above is tested by Shenzhen PSI Testing Co., Ltd. to determine the maximum emission levels emanating from the device and the severe levels of the device can endure and its performance criterion. The test results are contained in this test report and Shenzhen PSI Testing Co., Ltd. is assumed full responsibility for the accuracy and completeness of test. Also, this report shows that the EUT is technically compliant with the FCC Part 15C requirements.

This report applies to above tested sample only. This report shall not be reproduced in parts without written approval of Shenzhen PSI Testing Co., Ltd.

Tested by (name + signature).....: Felix Pang
 Test Engineer 

Approved by (name + signature).....: Simple Guan
 Project Manager 

Date of issue.....: March 11, 2025

Revision History

Revision	Issue Date	Revisions	Revised By
V0	March 11, 2025	Initial released Issue	Felix Pang



1. Summary Of Standards And Results

1.1. Description of Standards and Results

The EUT have been tested according to the applicable standards as referenced below:

Test Item	Standards Paragraph	Result
Conducted Emission	FCC Part 15: 15.207 RSS-GEN(8.8), ANSI C63.10 :2013	P
6dB Bandwidth	FCC PART 15:15.247(a)(2) RSS-247(5.2 a), ANSI C63.10 :2013	P
Output Power	FCC Part 15: 15.247(b)(3) RSS-247(5.4 d), ANSI C63.10 :2013	P
Radiated Spurious Emission	FCC Part 15: 15.209 FCC Part 15: 15.247(d) RSS-Gen(8.9), RSS-247(5.5) ANSI C63.10 :2013	P
Conducted Spurious & Band Edge Emission	FCC Part 15: 15.247(d) RSS-Gen(8.9), RSS-247(5.5) ANSI C63.10 :2013	P
Power Spectral Density	FCC PART 15:15.247(e) RSS-247(5.2 b), ANSI C63.10 :2013	P
Radiated Band Edge Emission	FCC Part 15: 15.247(d) RSS-GEN(6.13), ANSI C63.10 :2013	P
Frequency stability	RSS-GEN(6.11)	N/A
Antenna Requirement	FCC Part 15: 15.203 RSS-GEN(6.8)	P
<p>Note: 1. P is an abbreviation for Pass. 2. F is an abbreviation for Fail. 3. N/A is an abbreviation for Not Applicable. 4. Conclusion determination rules of this report: Unless there are clear provisions on measurement uncertainty in the standard or customer requirements, decision by actual test data without considering measurement uncertainty. 5. Measurement method usage KDB 558074 D01 15.247 Meas Guidance v05r02.</p>		

2. General Information

2.1. Description of Device (EUT)

Product Name : Notebook computer
 Model No. : N16U2-TU, N16*****("*" =0-9, A-Z, a-z, -, +, blank or any character)
 Diff : There is no difference except the name of the model. All tests are made with the N16U2-TU model.
 Power supply : DC 12V from adapter, DC 7.6V from battery.

Radio Technology	: Bluetooth V4.0 LE
Operation frequency	: 2402-2480MHz
Channel No.	: 40 channels
Channel Separation	: 2MHz
Rate	: 1Mbps
Modulation	: GFSK
Antenna Type	: Internal antenna, maximum gain is 1.90dBi.
PMN	: N/A
HVIN	: N/A
Software version	: N/A
Hardware version/FVIN	: N/A
Note	: Antenna information is provided by applicant. Testing lab is not responsible for the accuracy of the information.

2.2. Accessories of Device (EUT)

Accessories 1	:	POWER ADAPTER
Manufacturer	:	SHENZHEN FUSHIGANG TECHNOLOGY CO., LTD
Model	:	AS3603A-1203000US
Rating	:	Input: 100-240V~50/60Hz 1.0A Output: DC 12.0V/3.0A

2.3. Tested Supporting System Details

No.	Description	Manufacturer	Model	Serial Number
1	N/A	N/A	N/A	N/A
2	N/A	N/A	N/A	N/A

2.4. Block Diagram of Connection Between EUT and Simulators

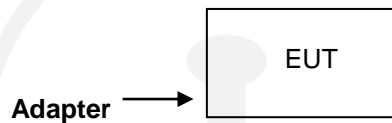

2.5. Test Mode Description

The test software was used to control EUT work in Continuous TX mode, and select test channel, wireless mode

Tested mode, channel, and data rate information		
Mode	Channel	Frequency (MHz)
GFSK Tx Mode 1Mbps	CH0	2402
	CH19	2440
	CH39	2480

Channel list:					
Channel	Frequency (MHz)	Channel	Frequency (MHz)	Channel	Frequency (MHz)
CH0	2402	CH14	2430	CH28	2458
CH1	2404	CH15	2432	CH29	2460
CH2	2406	CH16	2434	CH30	2462
CH3	2408	CH17	2436	CH31	2464
CH4	2410	CH18	2438	CH32	2466
CH5	2412	CH19	2440	CH33	2468
CH6	2414	CH20	2442	CH34	2470
CH7	2416	CH21	2444	CH35	2472
CH8	2418	CH22	2446	CH36	2474
CH9	2420	CH23	2448	CH37	2476
CH10	2422	CH24	2450	CH38	2478
CH11	2424	CH25	2452	CH39	2480
CH12	2426	CH26	2454	--	--
CH13	2428	CH27	2456	--	--

2.6. Software test version and power setting information

Software testing version	Bluetooth MP Tool.exe		
Mode	The client 's preset testing software is used to control the operation of EUT in continuous transmission mode and select the testing channel, wireless mode:		
Power level setup by client			
Mode	Channel	Frequency (MHz)	Soft Set
GFSK Tx Mode 1Mbps	CH0	2402	TX level is set as defaults value.
	CH39	2441	TX level is set as defaults value.
	CH78	2480	TX level is set as defaults value.

2.7. Test Conditions

Items	Required	Actual
Temperature range:	15-35°C	26°C
Humidity range:	25-75%	54%
Pressure range:	86-106kPa	101kPa

2.8. Test Facility

Shenzhen PSI Testing Co., Ltd.

1-2/F., Building 5, Yudafu Industrial Park, No.10, Xingye West Road, Shajing Subdistrict, Bao'an District, Shenzhen, Guangdong, China

September 13, 2023 File on Federal Communication Commission
Registration Number: 916281

2.9. Measurement Uncertainty

(95% confidence levels, k=2)

Item	Uncertainty
Uncertainty for Power point Conducted Emissions Test	2.17dB
Uncertainty for Radiation Emission test in 3m chamber (below 30MHz)	3.5dB
Uncertainty for Radiation Emission test in 3m chamber (30MHz to 1GHz)	2.74dB(Polarize: V)
	2.76dB(Polarize: H)
Uncertainty for Radiation Emission test in 3m chamber (1GHz to 18GHz)	4.29dB(Polarize: V)
	4.82dB(Polarize: H)
Uncertainty for Radiation Emission test in 3m chamber (18GHz to 40GHz)	4.31dB(Polarize: V)
	4.30dB(Polarize: H)
Uncertainty for radio frequency	48.24KHz
Uncertainty for conducted RF Power	0.41dB
Uncertainty for Power Spectral Density	0.39 dB

2.10. Test Equipment List

Item	Equipment	Manufacturer	Model No.	Serial No.	Firmware Version	Last Cal.	Cal. Interval
1.	9*6*6 anechoic chamber	SKET	9*6*6	N/A	/	2022.12.20	3 Year
2.	Test Receiver	Rohde&Schwarz	ESCI 7	101032/003	4.42 SP3	2024.12.18	1 Year
3.	L.I.S.N.#1	Rohde&Schwarz	ENV216	102282	/	2024.12.18	1 Year
4.	L.I.S.N.#2	RFT	NNB111	13835240	/	2024.12.18	1 Year
5.	Loop Antenna	Schwarz beck	FMZB 1519B	00128	/	2025.01.02	2 Year
6.	Bilog Antenna	Schwarz beck	VULB 9168	01448	/	2025.01.02	2 Year
7.	Spectrum Analyzer	Rohde&Schwarz	FSV-40N	101648	3.70	2024.12.18	1 Year
8.	Horn Antenna	Schwarz beck	BBHA 9120 D	02706	/	2025.01.02	2 Year
9.	Amplifier	SKET	LAPA_01G1 8G-45dB	SK20220329 01	/	2024.12.18	1 Year
10.	Horn Antenna	Schwarz beck	BBHA 9170	00946	/	2024.12.31	2 Year
11.	Amplifier	SKET	LNPA_0118 G-45	SK20200108 01	/	2024.12.18	1 Year
12.	RF Power Probe	Rohde&Schwarz	NRP-Z11	1138.3004.0 2-1111533-Fz	/	2024.12.18	1 Year
13.	RF Sensor Unit	Tachoy	TR1029-2	20220428P0 08	/	2024.12.18	1 Year
14.	Spectrum Analyzer	Agilent	N9020A	MY51281067	A.14.03	2024.12.18	1 Year
15.	Temp. & Humid Chamber	Auchno	9606	/	/	2024.12.18	1 Year
16.	Regulated DC Power Supply	Xinouhua	ADC120V10 A	2022112516 38		2024.12.18	1 Year

For Test Software Information

Item	Software Name	Manufacturer	Version
RE	EZ EMC	Farad	PSI-3A1
CE	EZ EMC	Farad	PSI-3A1
RF	RTS	TACHOY	V1.0.0

3. Spurious Emission

3.1. Test Limits

All the emissions appearing within 15.205 restricted frequency bands shall not exceed the limits shown in 15.209, all the other emissions shall be at least 20dB below the fundamental emissions, or comply with 15.209 limits.

15.205 Restricted frequency band

MHz	MHz	MHz	GHz
0.090 - 0.110	16.42 - 16.423	399.9 - 410	4.5 - 5.15
¹ 0.495 - 0.505	16.69475 - 16.69525	608 - 614	5.35 - 5.46
2.1735 - 2.1905	16.80425 - 16.80475	960 - 1240	7.25 - 7.75
4.125 - 4.128	25.5 - 25.67	1300 - 1427	8.025 - 8.5
4.17725 - 4.17775	37.5 - 38.25	1435 - 1626.5	9.0 - 9.2
4.20725 - 4.20775	73 - 74.6	1645.5 - 1646.5	9.3 - 9.5
6.215 - 6.218	74.8 - 75.2	1660 - 1710	10.6 - 12.7
6.26775 - 6.26825	108 - 121.94	1718.8 - 1722.2	13.25 - 13.4
6.31175 - 6.31225	123 - 138	2200 - 2300	14.47 - 14.5
8.291 - 8.294	149.9 - 150.05	2310 - 2390	15.35 - 16.2
8.362 - 8.366	156.52475 - 156.52525	2483.5 - 2500	17.7 - 21.4
8.37625 - 8.38675	156.7 - 156.9	2690 - 2900	22.01 - 23.12
8.41425 - 8.41475	162.0125 - 167.17	3260 - 3267	23.6 - 24.0
12.29 - 12.293	167.72 - 173.2	3332 - 3339	31.2 - 31.8
12.51975 - 12.52025	240 - 285	3345.8 - 3358	36.43 - 36.5
12.57675 - 12.57725	322 - 335.4	3600 - 4400	(²)

RSS-GEN Restricted frequency band

Table 7 – Restricted frequency bands^{Note 1}

MHz	MHz	GHz
0.090 - 0.110	149.9 - 150.05	9.0 - 9.2
0.495 - 0.505	156.52475 - 156.52525	9.3 - 9.5
2.1735 - 2.1905	156.7 - 156.9	10.6 - 12.7
3.020 - 3.026	162.0125 - 167.17	13.25 - 13.4
4.125 - 4.128	167.72 - 173.2	14.47 - 14.5
4.17725 - 4.17775	240 - 285	15.35 - 16.2
4.20725 - 4.20775	322 - 335.4	17.7 - 21.4
5.677 - 5.683	399.9 - 410	22.01 - 23.12
6.215 - 6.218	608 - 614	23.6 - 24.0
6.26775 - 6.26825	960 - 1427	31.2 - 31.8

6.31175 - 6.31225	1435 - 1626.5	36.43 - 36.5
8.291 - 8.294	1645.5 - 1646.5	Above 38.6
8.362 - 8.366	1660 - 1710	
8.37625 - 8.38675	1718.8 - 1722.2	
8.41425 - 8.41475	2200 - 2300	
12.29 - 12.293	2310 - 2390	
12.51975 - 12.52025	2483.5 - 2500	
12.57675 - 12.57725	2655 - 2900	
13.36 - 13.41	3260 – 3267	
16.42 - 16.423	3332 - 3339	
16.69475 - 16.69525	3345.8 - 3358	
16.80425 - 16.80475	3500 - 4400	
25.5 - 25.67	4500 - 5150	
37.5 - 38.25	5350 - 5460	
73 - 74.6	7250 - 7750	
74.8 - 75.2	8025 – 8500	
108 – 138		

Note 1: Certain frequency bands listed in table 7 and in bands above 38.6 GHz are designated for licence-exempt applications. These frequency bands and the requirements that apply to related devices are set out in the 200 and 300 series of RSS.

15.209 Limit

FREQUENCY MHz	DISTANCE Meters	FIELD STRENGTHS LIMIT	
		$\mu\text{V}/\text{m}$	$\text{dB}(\mu\text{V})/\text{m}$
0.009-0.490	300	$2400/\text{F}(\text{KHz})$	/
0.490-1.705	30	$24000/\text{F}(\text{KHz})$	/
1.705-30	30	30	29.5
30 ~ 88	3	100	40.0
88 ~ 216	3	150	43.5
216 ~ 960	3	200	46.0
960 ~ 1000	3	500	54.0
Above 1000	3	74.0 $\text{dB}(\mu\text{V})/\text{m}$ (Peak) 54.0 $\text{dB}(\mu\text{V})/\text{m}$ (Average)	

Note: The peak limit is 20 dB higher than the average limit

Table 5 – General field strength limits at frequencies above 30 MHz

Frequency (MHz)	Field strength ($\mu\text{V}/\text{m}$ at 3 m)
30 – 88	100
88 – 216	150
216 – 960	200
Above 960	500

Table 6 – General field strength limits at frequencies below 30 MHz

Frequency	Magnetic field strength (H-Field) ($\mu\text{A}/\text{m}$)	Measurement distance (m)
9 - 490 kHz ^{Note 1}	$6.37/\text{F}$ (F in kHz)	300
490 - 1705 kHz	$63.7/\text{F}$ (F in kHz)	30
1.705 - 30 MHz	0.08	30

Note 1: The emission limits for the ranges 9-90 kHz and 110-490 kHz are based on measurements employing a linear average detector.

3.2. Block Diagram of Test setup

3.2.1 In 3m Anechoic Chamber Test Setup Diagram for below 30MHz

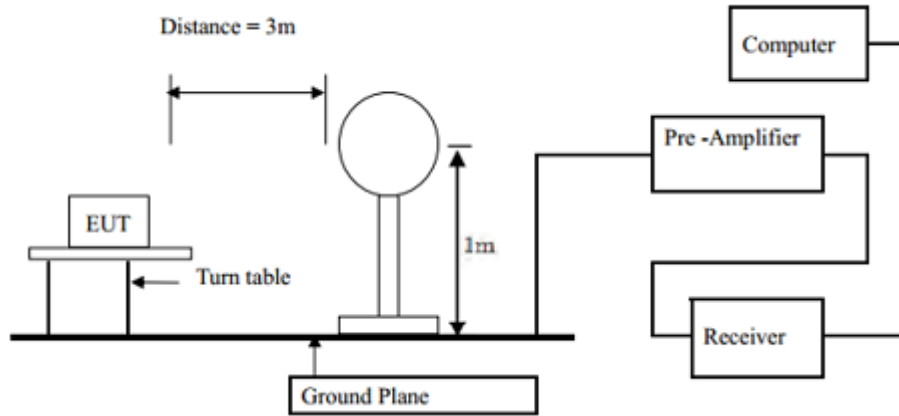

3.2.2 In 3m Anechoic Chamber Test Setup Diagram for below 1GHz

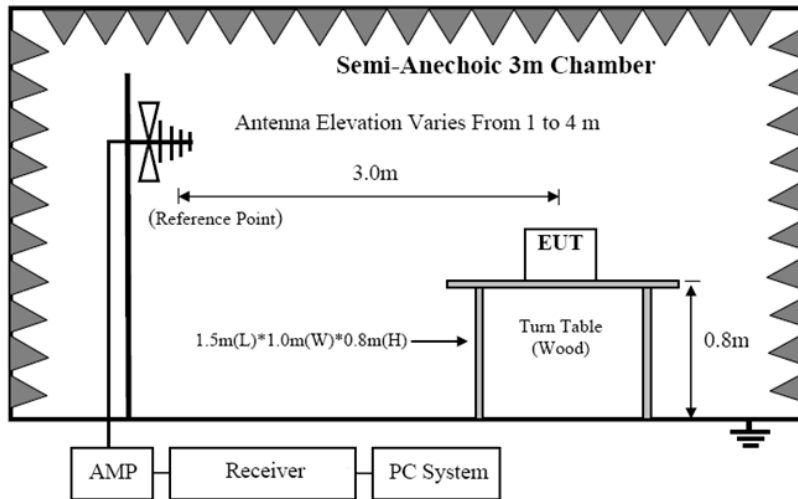

3.2.3 In 3m Anechoic Chamber Test Setup Diagram for frequency above 1GHz

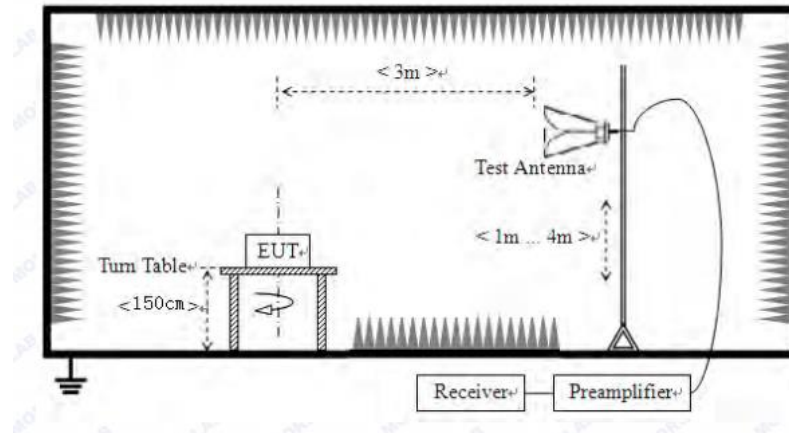

3.3. Test Procedure

- (1) EUT was placed on a non-metallic table, 80 cm above the ground plane inside a semi-anechoic chamber.
- (2) Setup EUT and simulator
- (3) Test antenna was located 3m from the EUT on an adjustable mast. Below pre-scan procedure was first performed in order to find prominent radiated emissions.
 - (a) Change work frequency or channel of device if practicable.
 - (b) Change modulation type of device if practicable.
 - (c) Rotated EUT though three orthogonal axes to determine the attitude of EUT arrangement produces highest emissions
- (4) Spectrum frequency from 9KHz to 25GHz (tenth harmonic of fundamental frequency) was investigated
- (5) For final emissions measurements at each frequency of interest, the EUT were rotated and the antenna height was varied between 1m and 4m in order to maximize the emission. Measurements in both horizontal and vertical polarities were made and the data was recorded. In order to find the maximum emission, the relative positions of equipments and all of the interface cables were changed according to ANSI C63.10:2013on Radiated Emission test.
- (6) For emissions above 1GHz, both Peak and Average level were measured with Spectrum Analyzer, and the RBW is set at 1MHz, VBW is set at 3MHz for Peak measure; RBW is set at 1MHz, VBW is set at 10Hz for Average measure.

Test setup information:

9KHz~150KHz	RBW200Hz	VBW1KHz
150KHz~30MHz	RBW9KHz	VBW 30KHz
30MHz~1GHz	RBW120KHz	VBW 300KHz
Above1GHz	RBW1MHz	VBW 3MHz

3.4. Test Results

We have scanned from 9kHz to the 10th harmonic of the EUT's highest frequency.
Detailed information please see the following page.

From 9KHz to 30MHz:	
Test Date : 2025.03.03	Temperature : 26°C
Test Engineer : Felix Pang	Humidity : 54%
Test Mode : GFSK mode	
Test Results : PASS	
Note:	The amplitude of spurious emissions which are attenuated by more than 20dB below the permissible value has no need to be reported.

From 30MHz to 1000MHz:	
Test Date : 2025.03.03	Temperature : 26°C
Test Engineer : Felix Pang	Humidity : 54%
Test Mode : GFSK mode	
Test Results : PASS	
Note:	<ol style="list-style-type: none"> 1. The test results are listed in next pages. 2. If the limits for the measurement with the average detector are met when using a receiver with a peak detector, the test unit shall be deemed to meet both limits and the measurement with the average detector and quasi-peak detector need not be carried out. 3. All modes have been tested, and only worst data of 1Mbps GFSK 2402MHz mode was listed in this report.

Polarization: Vertical

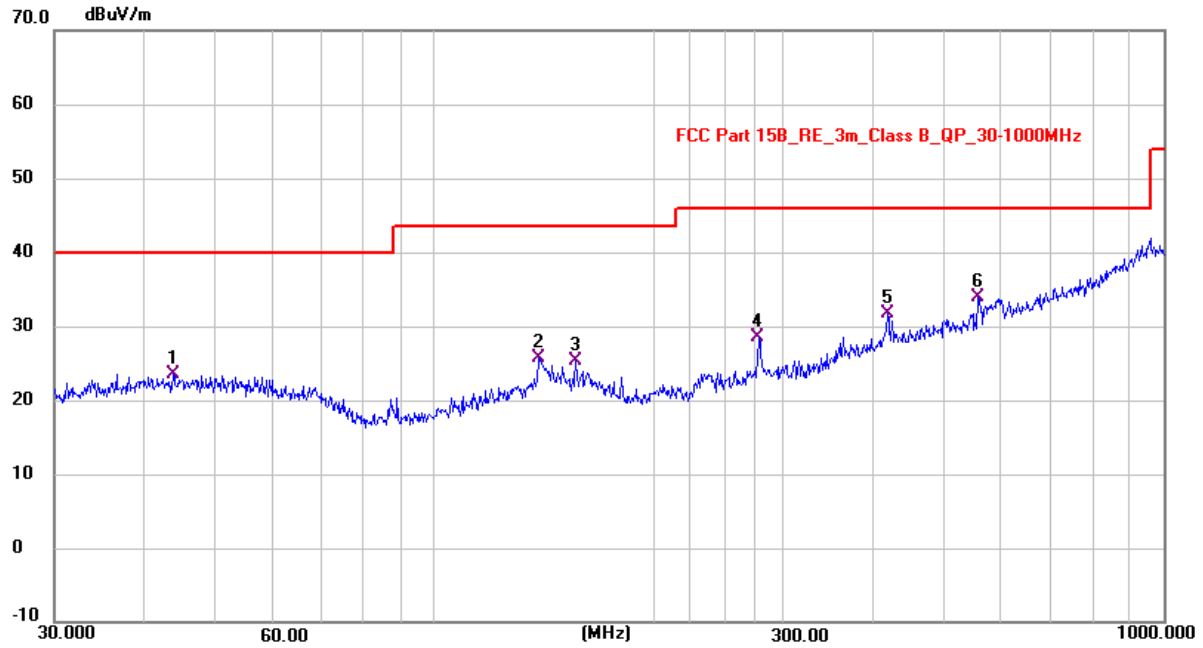

No.	Frequency (MHz)	Reading (dBuV)	Factor (dB/m)	Level (dBuV/m)	Limit (dBuV/m)	Margin (dB)	Detector
1	43.7160	9.16	14.41	23.57	40.00	-16.43	QP
2	139.3002	11.85	13.85	25.70	43.50	-17.80	QP
3	156.0468	11.03	14.26	25.29	43.50	-18.21	QP
4	278.5547	13.96	14.48	28.44	46.00	-17.56	QP
5	418.7407	13.49	18.18	31.67	46.00	-14.33	QP
6 *	556.7743	12.12	21.71	33.83	46.00	-12.17	QP

Note: Level = Reading + Factor Margin = Level - Limit

Polarization: Horizontal

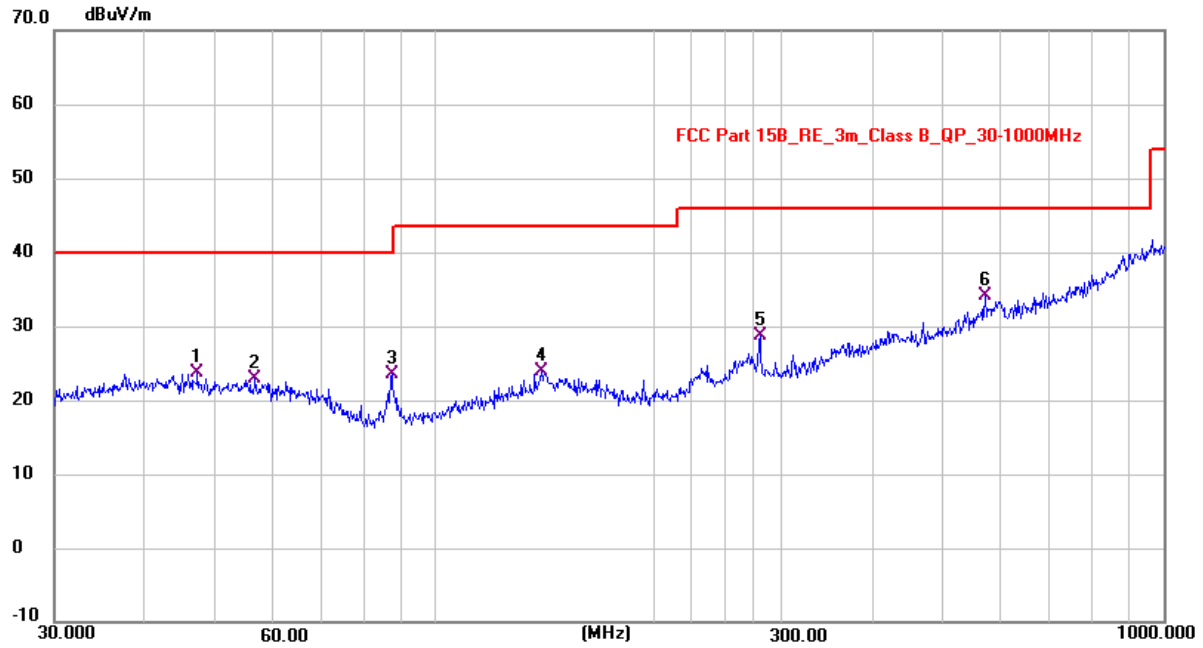

No.	Frequency (MHz)	Reading (dBuV)	Factor (dB/m)	Level (dBuV/m)	Limit (dBuV/m)	Margin (dB)	Detector
1	47.1805	9.35	14.26	23.61	40.00	-16.39	QP
2	56.6674	9.48	13.46	22.94	40.00	-17.06	QP
3	87.4177	13.80	9.66	23.46	40.00	-16.54	QP
4	140.0348	10.02	13.90	23.92	43.50	-19.58	QP
5	279.6559	14.08	14.53	28.61	46.00	-17.39	QP
6 *	569.3609	12.07	22.05	34.12	46.00	-11.88	QP

Note: Level = Reading + Factor Margin = Level - Limit

From 1GHz to 25GHz:	
Test Date : 2025.03.03	Temperature : 26°C
Test Engineer : Felix Pang	Humidity : 54%
Test Mode : GFSK mode	
Test Results : PASS	
Note:	<ol style="list-style-type: none">1. The test results are listed in next pages.2. If the limits for the measurement with the average detector are met when using a receiver with a peak detector, the test unit shall be deemed to meet both limits and the measurement with the average detector and quasi-peak detector need not be carried out.3. If the limits for the measurement with the average detector are met when using a receiver with a quasi-peak detector, the test unit shall be deemed to meet both limits and the measurement with the average detector need not be carried out.



1Mbps:

Test Mode : GFSK TX Low								
No.	Freq MHz	Polarity	Reading (dBuV/m)	Correct Factor	Result (dBuV/m)	Limit (dBuV/m)	Margin	Remark
1	4804	V	59.12	-13.25	45.87	74.00	-28.13	Peak
2	4804	V	48.39	-13.25	35.14	54.00	-18.86	Avg
3	7206	--	--	--	--	--	--	--
4	9608	--	--	--	--	--	--	--
5	4804	H	56.99	-13.25	43.74	74.00	-30.26	Peak
6	4804	H	44.76	-13.25	31.51	54.00	-22.49	Avg
7	7206	--	--	--	--	--	--	--
8	9608	--	--	--	--	--	--	--
Test Mode : GFSK TX Mid								
1	4880	V	60.06	-12.98	47.08	74.00	-26.92	Peak
2	4880	V	48.96	-12.98	35.98	54.00	-18.02	Avg
3	7320	--	--	--	--	--	--	--
4	9760	--	--	--	--	--	--	--
5	4880	H	56.80	-12.98	43.82	74.00	-30.18	Peak
6	4880	H	46.38	-12.98	33.40	54.00	-20.60	Avg
7	7320	--	--	--	--	--	--	--
8	9760	--	--	--	--	--	--	--
Test Mode : GFSK TX High								
1	4960	V	57.81	-12.70	45.11	74.00	-28.89	Peak
2	4960	V	47.94	-12.70	35.24	54.00	-18.76	Avg
3	7440	--	--	--	--	--	--	--
4	9920	--	--	--	--	--	--	--
5	4960	H	55.51	-12.70	42.81	74.00	-31.19	Peak
6	4960	H	46.67	-12.70	33.97	54.00	-20.03	Avg
7	7440	--	--	--	--	--	--	--
8	9920	--	--	--	--	--	--	--
Note:	1. Means other frequency and mode comply with standard requirements and at least have 20dB margin. 2. Correct Factor=Cable Loss+ Antenna Factor-Amplifier Gain. Result=Reading + Correct Factor. Margin= Result-Limit.							

4. Power Line Conducted Emission

4.1. Test Limits

Frequency MHz	Limits dB(μ V)	
	Quasi-peak Level	Average Level
0.15 -0.50	66 -56*	56 - 46*
0.50 -5.00	56	46
5.00 -30.00	60	50

Notes: 1. *Decreasing linearly with logarithm of frequency.

2. The lower limit shall apply at the transition frequencies.

3. The limit decreases in line with the logarithm of the frequency in the range of 0.15 to 0.50 MHz.

4.2. Test Procedure

The EUT is put on the plane 0.8m high above the ground by insulating support and is connected to the power mains through a line impedance stabilization network (L.I.S.N.). This provides a 50ohm coupling impedance for the EUT system. Please refer the block diagram of the test setup and photographs.

Both sides of AC lines are checked to find out the maximum conducted emission. In order to find the maximum emission levels, the relative positions of equipment and all of the interface cables shall be changed according to ANSI C63.10:2013 on Conducted Emission Measurement.

The bandwidth of test receiver is set at 9 kHz.

4.3. Test Setup

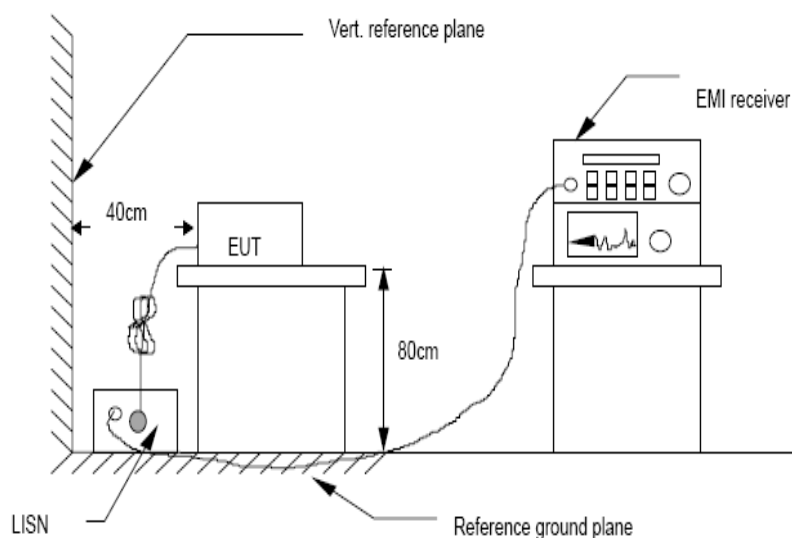

4.4. Test Results

Test Date	: 2025.03.05	Temperature	: 26°C
Test Engineer	: Felix Pang	Humidity	: 54%
Test Mode	: GFSK mode		
Test Results	: PASS		
Note:	<ol style="list-style-type: none">1. The test results are listed in next pages.2. If the limits for the measurement with the average detector are met when using a receiver with a peak detector, the test unit shall be deemed to meet both limits and the measurement with the average detector and quasi-peak detector need not be carried out.3. If the limits for the measurement with the average detector are met when using a receiver with a quasi-peak detector, the test unit shall be deemed to meet both limits and the measurement with the average detector need not be carried out.4. All modes have been tested, and only worst data of 1Mbps GFSK 2402MHz mode was listed in this report.		



Polarization: L

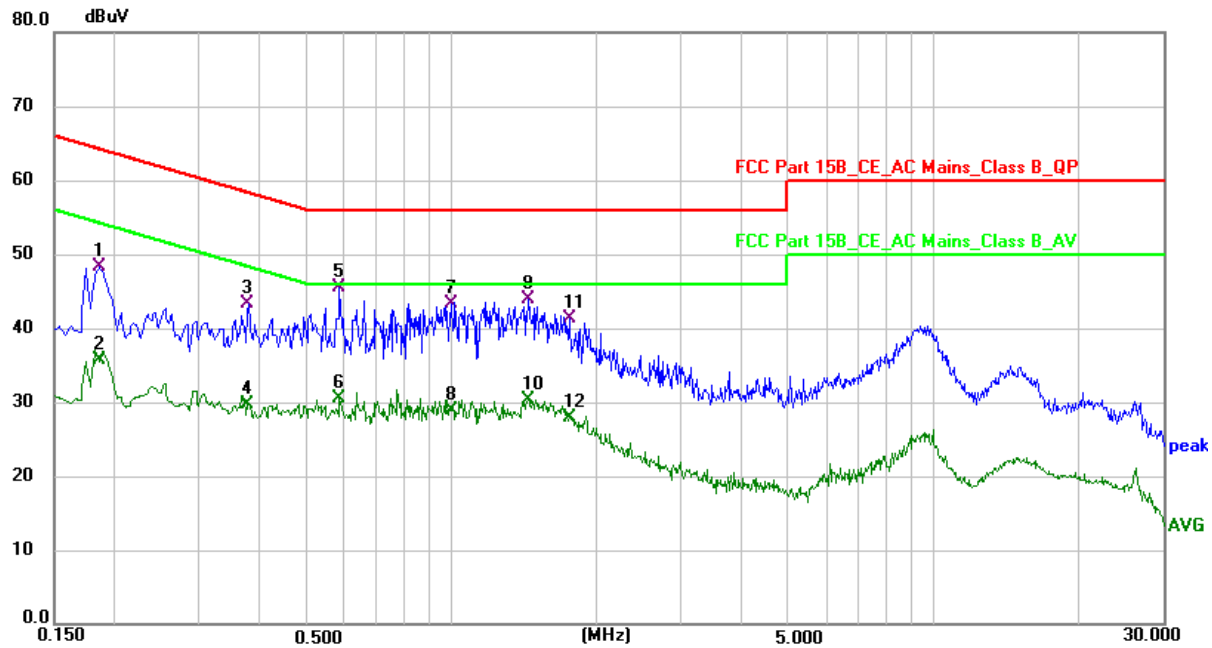

No.	Frequency (MHz)	Reading (dBuV)	Factor (dB)	Level (dBuV)	Limit (dBuV)	Margin (dB)	Detector	P/F
1	0.1860	38.29	9.97	48.26	64.21	-15.95	QP	P
2	0.1860	25.70	9.97	35.67	54.21	-18.54	AVG	P
3	0.3780	33.63	9.60	43.23	58.32	-15.09	QP	P
4	0.3780	20.01	9.60	29.61	48.32	-18.71	AVG	P
5 *	0.5860	35.75	9.78	45.53	56.00	-10.47	QP	P
6	0.5860	20.72	9.78	30.50	46.00	-15.50	AVG	P
7	1.0020	33.81	9.51	43.32	56.00	-12.68	QP	P
8	1.0020	19.42	9.51	28.93	46.00	-17.07	AVG	P
9	1.4420	34.54	9.40	43.94	56.00	-12.06	QP	P
10	1.4420	20.95	9.40	30.35	46.00	-15.65	AVG	P
11	1.7540	31.98	9.32	41.30	56.00	-14.70	QP	P
12	1.7540	18.49	9.32	27.81	46.00	-18.19	AVG	P

Note: Level = Reading + Factor Margin = Level - Limit

Polarization: N

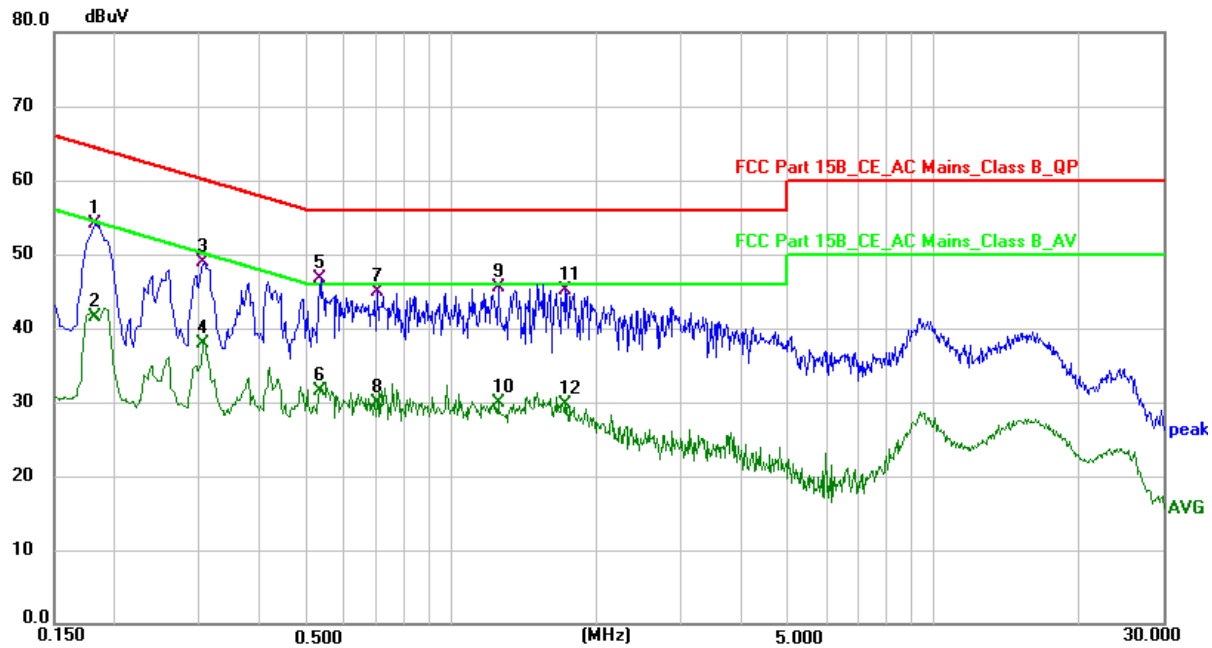

No.	Frequency (MHz)	Reading (dBuV)	Factor (dB)	Level (dBuV)	Limit (dBuV)	Margin (dB)	Detector	P/F
1	0.1819	44.11	9.95	54.06	64.40	-10.34	QP	P
2	0.1819	31.56	9.95	41.51	54.40	-12.89	AVG	P
3	0.3060	39.00	9.97	48.97	60.08	-11.11	QP	P
4	0.3060	27.94	9.97	37.91	50.08	-12.17	AVG	P
5 *	0.5340	36.83	9.83	46.66	56.00	-9.34	QP	P
6	0.5340	21.74	9.83	31.57	46.00	-14.43	AVG	P
7	0.7019	35.52	9.43	44.95	56.00	-11.05	QP	P
8	0.7019	20.56	9.43	29.99	46.00	-16.01	AVG	P
9	1.2500	36.02	9.41	45.43	56.00	-10.57	QP	P
10	1.2500	20.50	9.41	29.91	46.00	-16.09	AVG	P
11	1.7340	35.67	9.40	45.07	56.00	-10.93	QP	P
12	1.7340	20.32	9.40	29.72	46.00	-16.28	AVG	P

Note: Level = Reading + Factor Margin = Level - Limit

5. Out-of-band Emissions

5.1. Test Limits

In any 100 kHz bandwidth outside the frequency band in which the spread spectrum or digitally modulated intentional radiator is operating, the radio frequency power that is produced by the intentional radiator shall be at least 20 dB below that in the 100 kHz bandwidth within the band that contains the highest level of the desired power, based on either an RF conducted or a radiated measurement, provided the transmitter demonstrates compliance with the peak conducted power limits. If the transmitter complies with the conducted power limits based on the use of RMS averaging over a time interval, as permitted under paragraph (b)(3) of this section, the attenuation required under this paragraph shall be 30 dB instead of 20 dB. Attenuation below the general limits specified in FCC Part 15.209(a) is not required. Please refer section RSS-GEN&15.247.

5.2. Test Procedure

Connect the transmitter output to spectrum analyzer using a low loss RF cable, and set the spectrum analyzer to RBW=100 kHz, VBW= 300 kHz, peak detector, and max hold. Measurements utilizing these settings are made of the in-band reference level, band edge and out-of-band emissions.

5.3. Test Setup



5.4. Test Results

PASS.

The test results are listed in next pages.

Band edge: Pass

Condition	Antenna	Modulation	TX_Frequency (MHz)	Max. Mark_freq(MHz)	Ref_level(dBm)	Spurious level(dBm)	limit(dBm)	Result
NVNT	ANT1	1Mbps	2402.00	2399.680	11.006	-39.329	-8.994	Pass
NVNT	ANT1	1Mbps	2480.00	2484.675	11.920	-42.580	-8.080	Pass

1 Reference_Level_NVNT_ANT1_1Mbps_2402

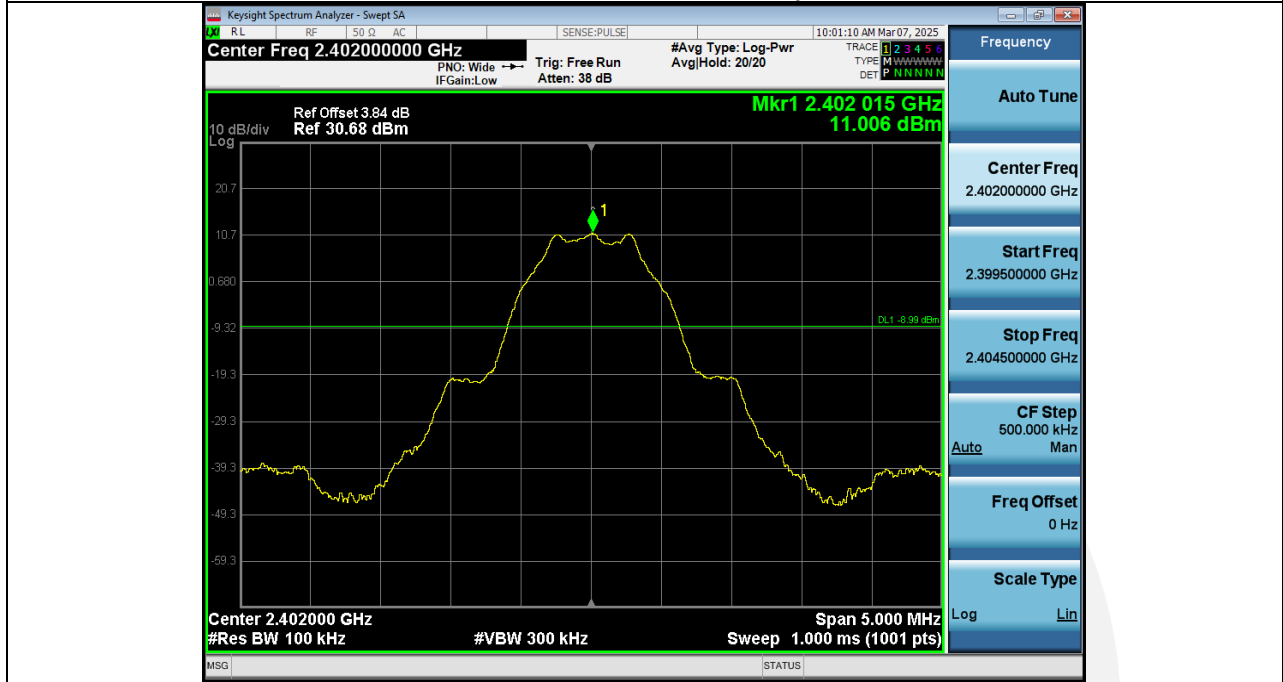

2 Bandedge_NVNT_ANT1_1Mbps_2402

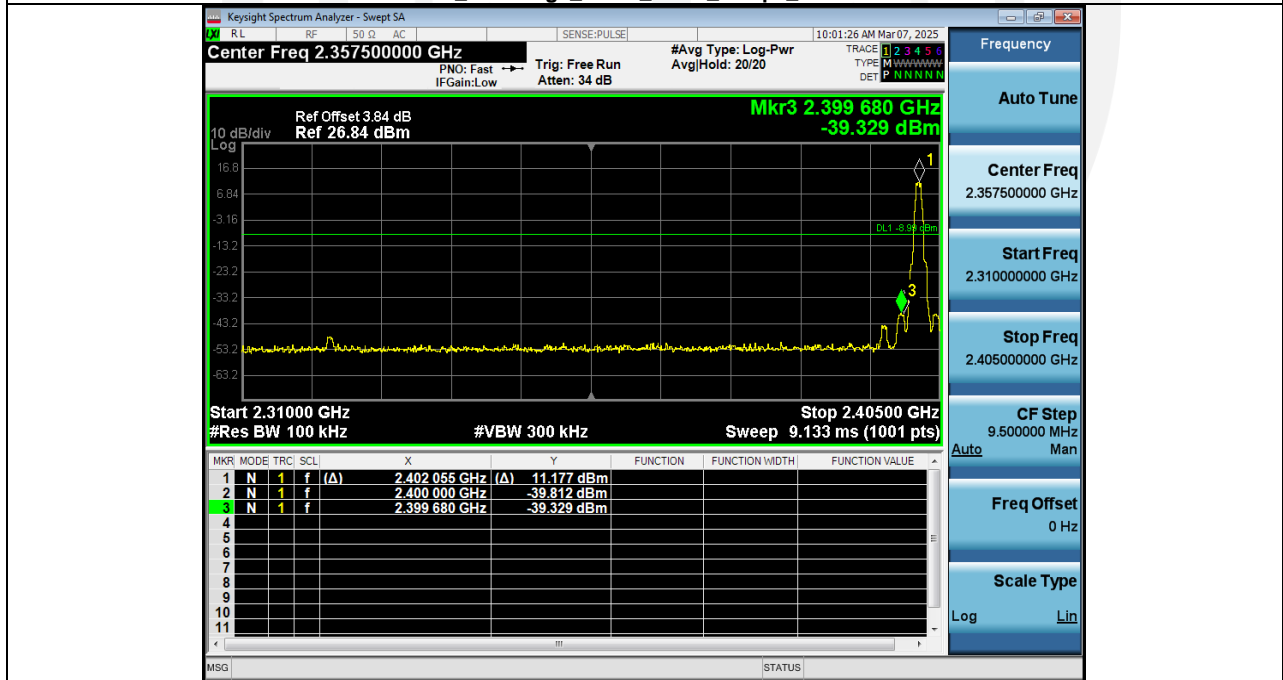

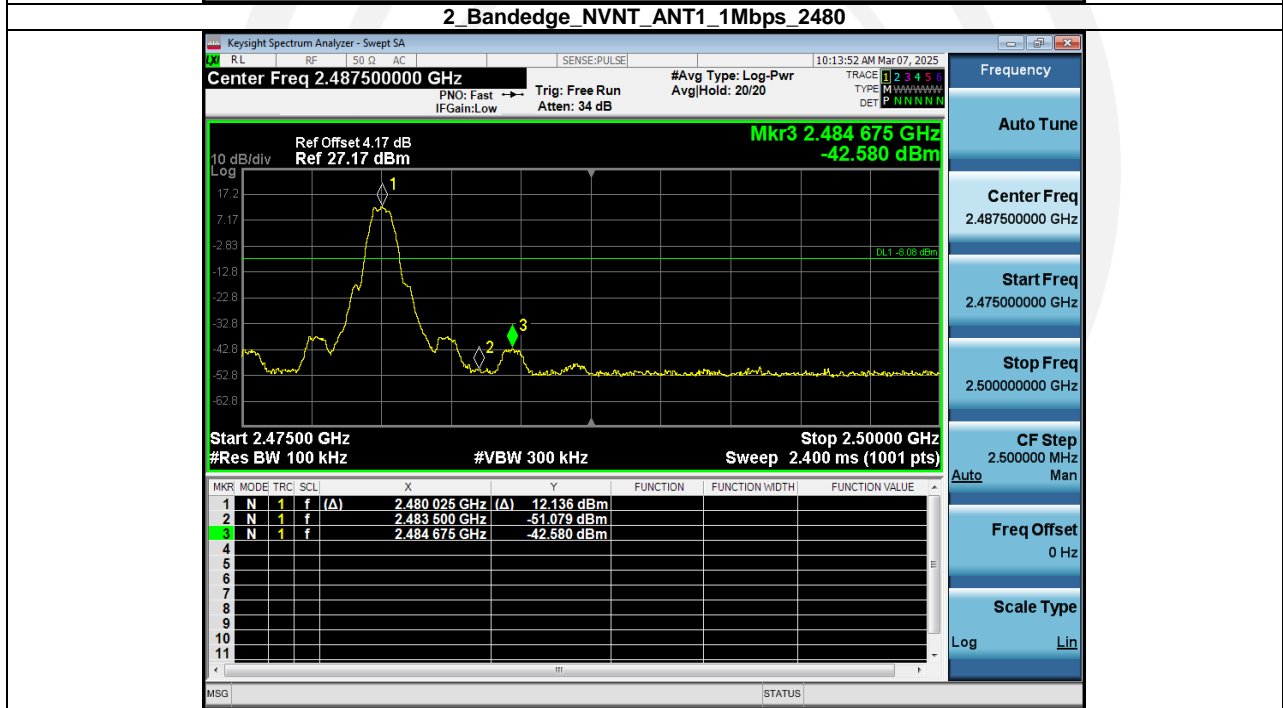
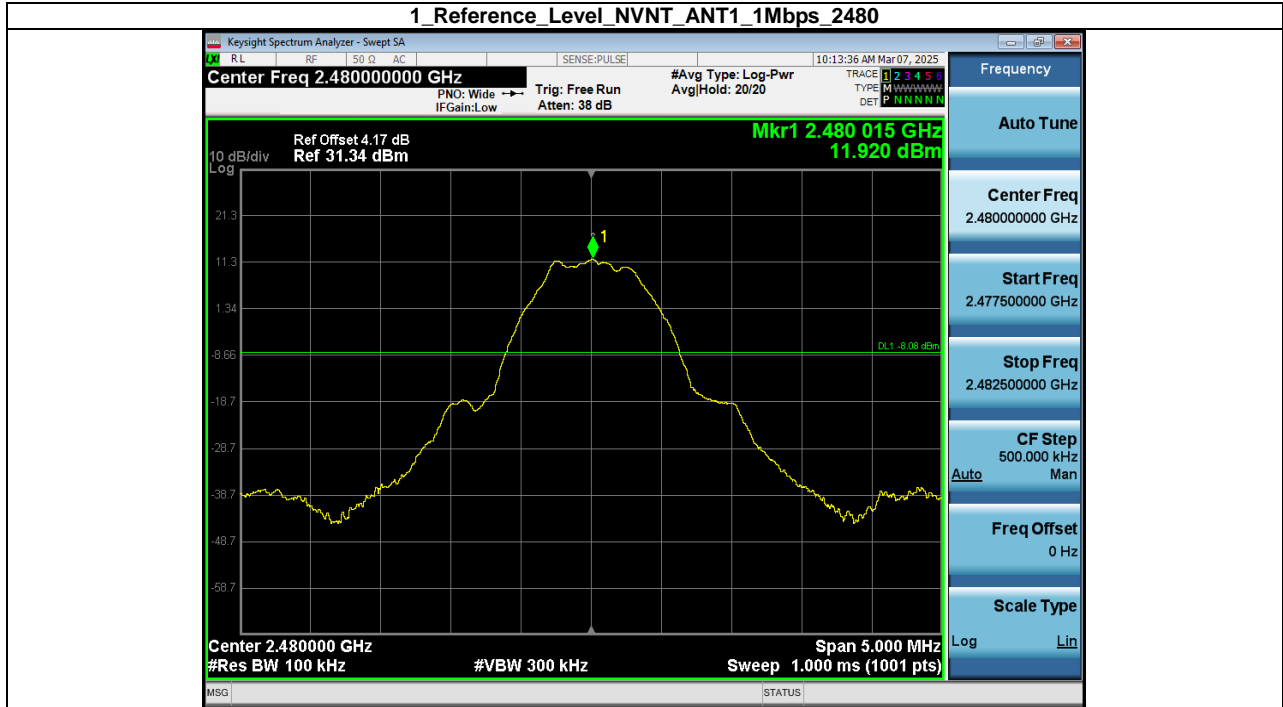

Spurious Emission: Pass

Condition	Antenna	Modulation	TX_Frequency (MHz)	Ref_level(dBm)	Spurious level(dBm)	limit(dBm)	Result
NVNT	ANT1	1Mbps	2402.00	11.006	-39.083	-8.994	Pass
NVNT	ANT1	1Mbps	2440.00	11.525	-38.621	-8.475	Pass
NVNT	ANT1	1Mbps	2480.00	11.920	-39.283	-8.080	Pass

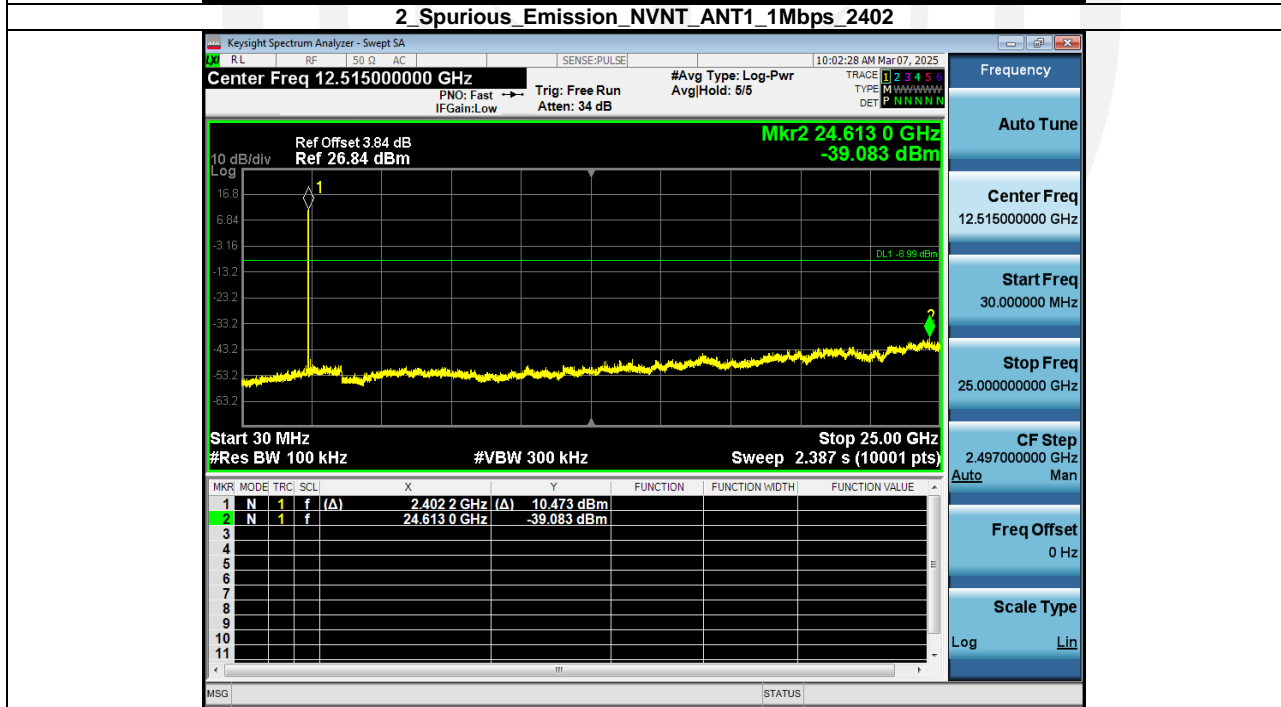
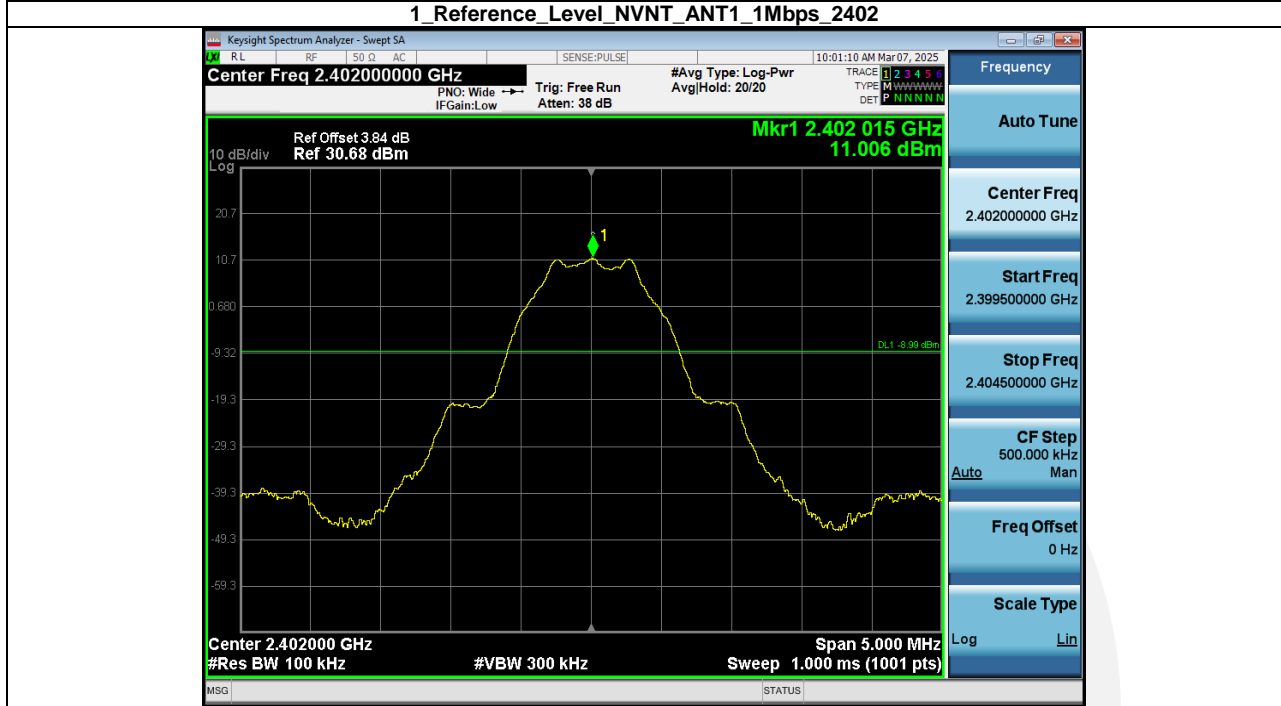

1_Reference_Level_NVNT_ANT1_1Mbps_2440

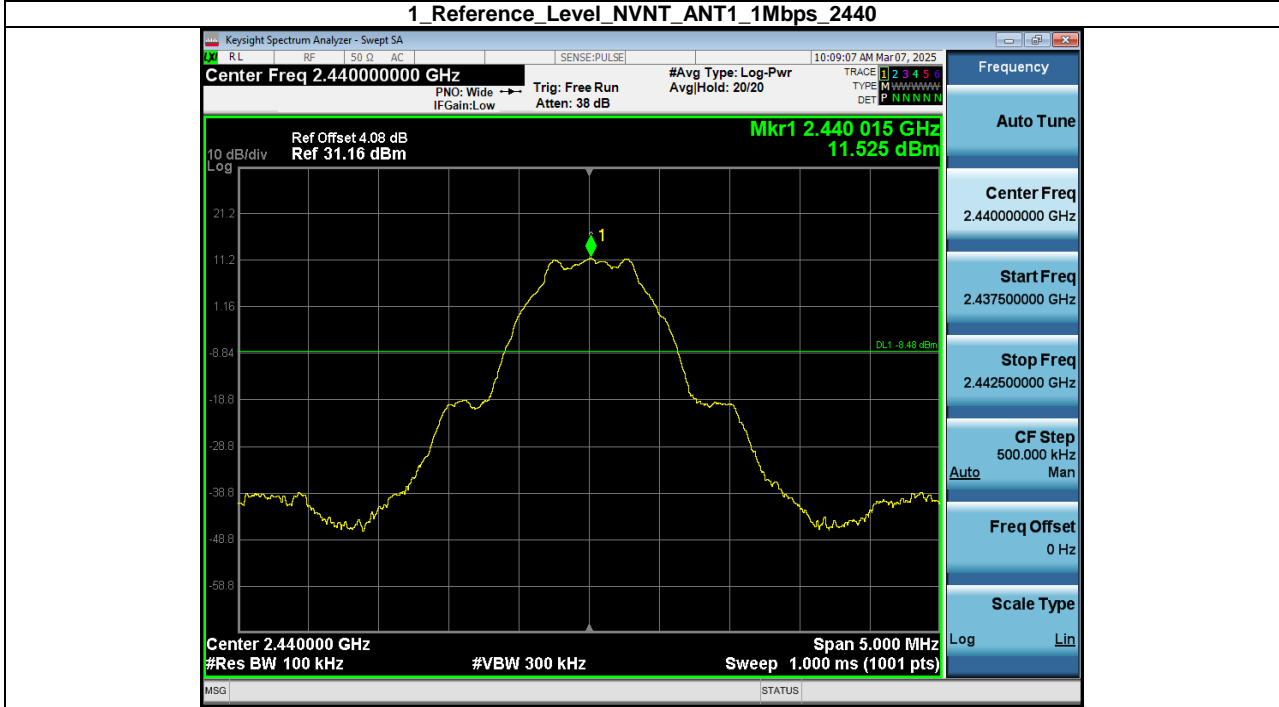

2_Spurious_Emission_NVNT_ANT1_1Mbps_2440

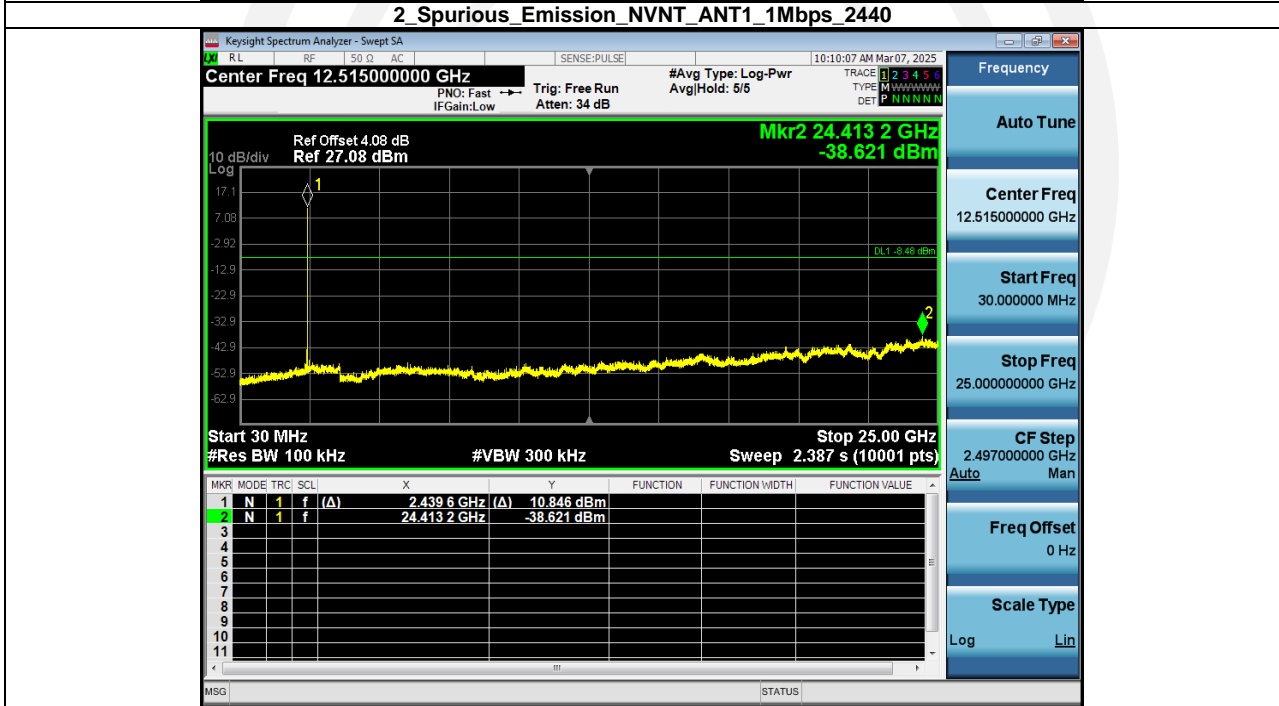

1_Reference_Level_NVNT_ANT1_1Mbps_2480

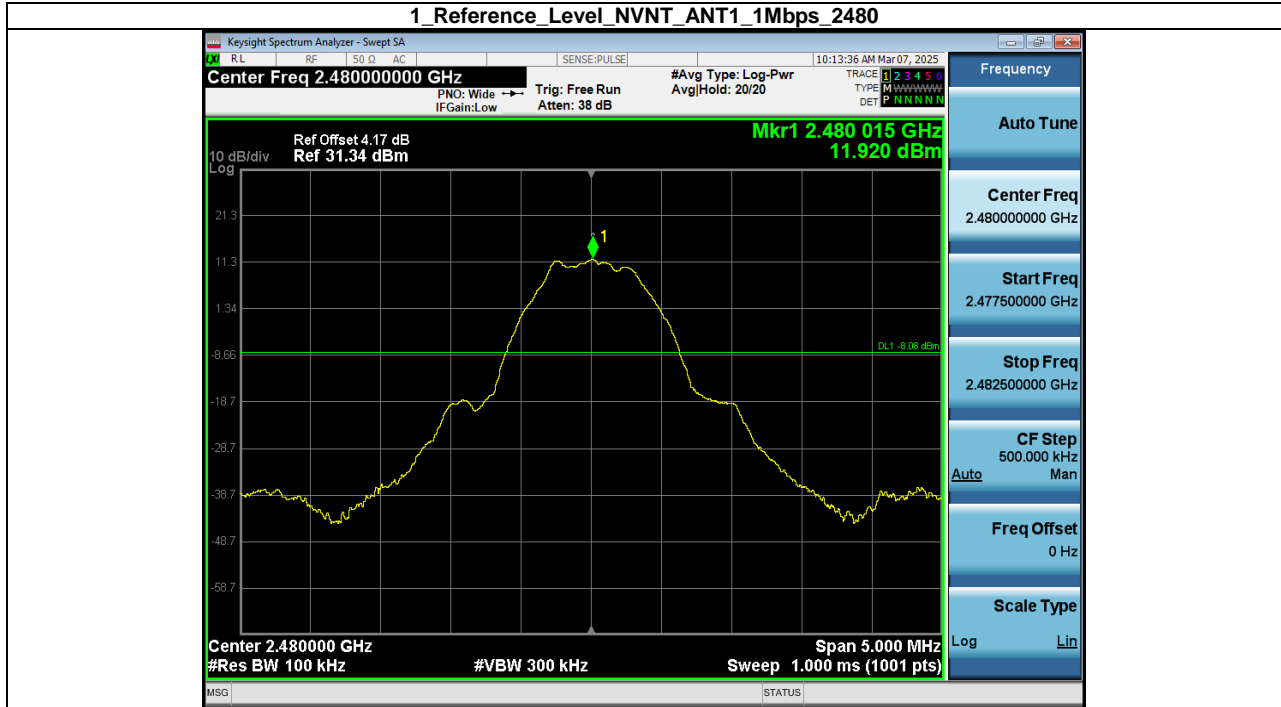

2_Spurious_Emission_NVNT_ANT1_1Mbps_2480

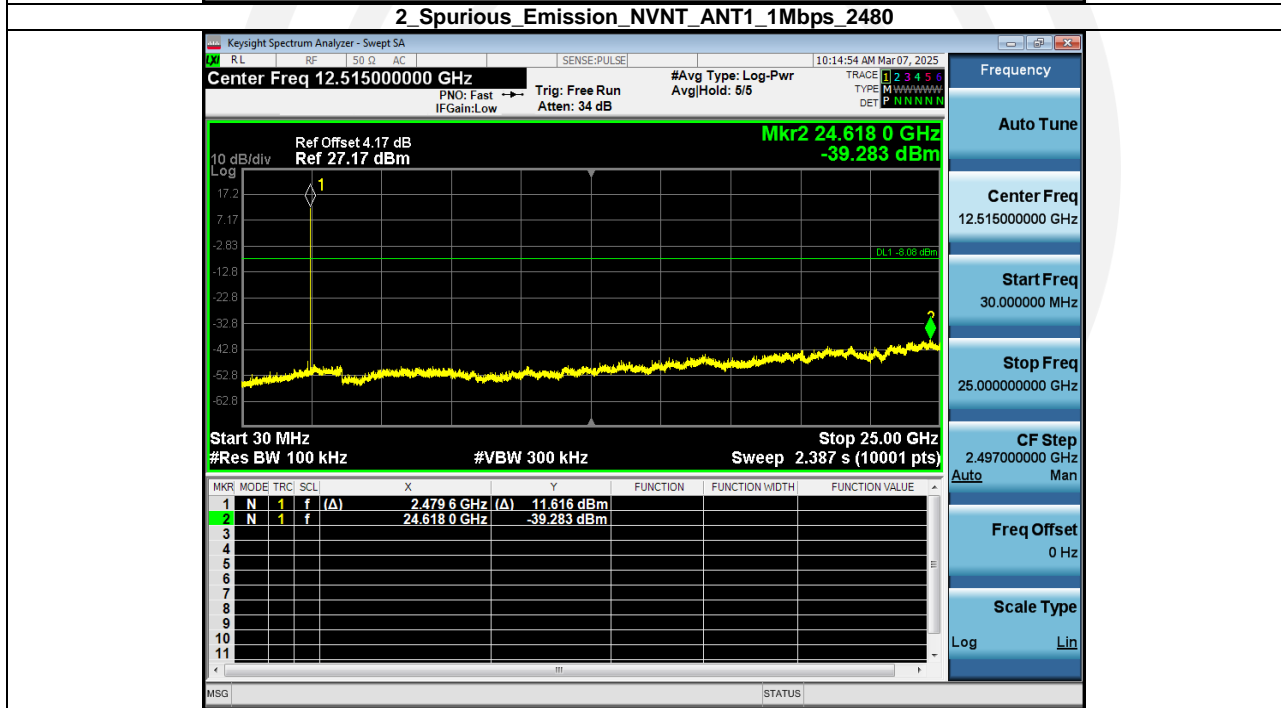

6. Conducted Maximum Output Power

6.1. Test limits

Please refer RSS-247 & FCC PART 15: 15.247.

Regulation 15.247(b) The limit of Maximum Peak Output Power Measurement is 1 W(30dBm)

6.2. Test Procedure

Details see the KDB558074 D01 Meas Guidance v05r02

- 1 Place the EUT on the table and set it in transmitting mode.
- 2 Connected the EUT's antenna port to peak power meter by 20dB attenuator.
- 3 Measure out each mode and each bands Peak output power of EUT.

Note: The cable loss and attenuator loss were offset into measure device as amplitude offset.

6.3. Test Setup

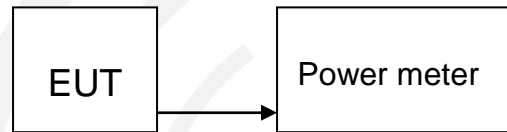

6.4. Test Results

Condition	Antenna	Rate	Frequency (MHz)	Max. Conducted Power(dBm)	Max. Conducted Power(mW)	Limit(mW)	Result
NVNT	ANT1	1Mbps	2402.00	11.77	15.02	1000	Pass
NVNT	ANT1	1Mbps	2440.00	12.29	16.94	1000	Pass
NVNT	ANT1	1Mbps	2480.00	12.59	18.16	1000	Pass

Condition	Antenna	Rate	Frequency (MHz)	Dutycycle(%)	Duty_factor
NVNT	ANT1	1Mbps	2402.00	64.52	1.90
NVNT	ANT1	1Mbps	2440.00	62.50	2.04
NVNT	ANT1	1Mbps	2480.00	64.52	1.90

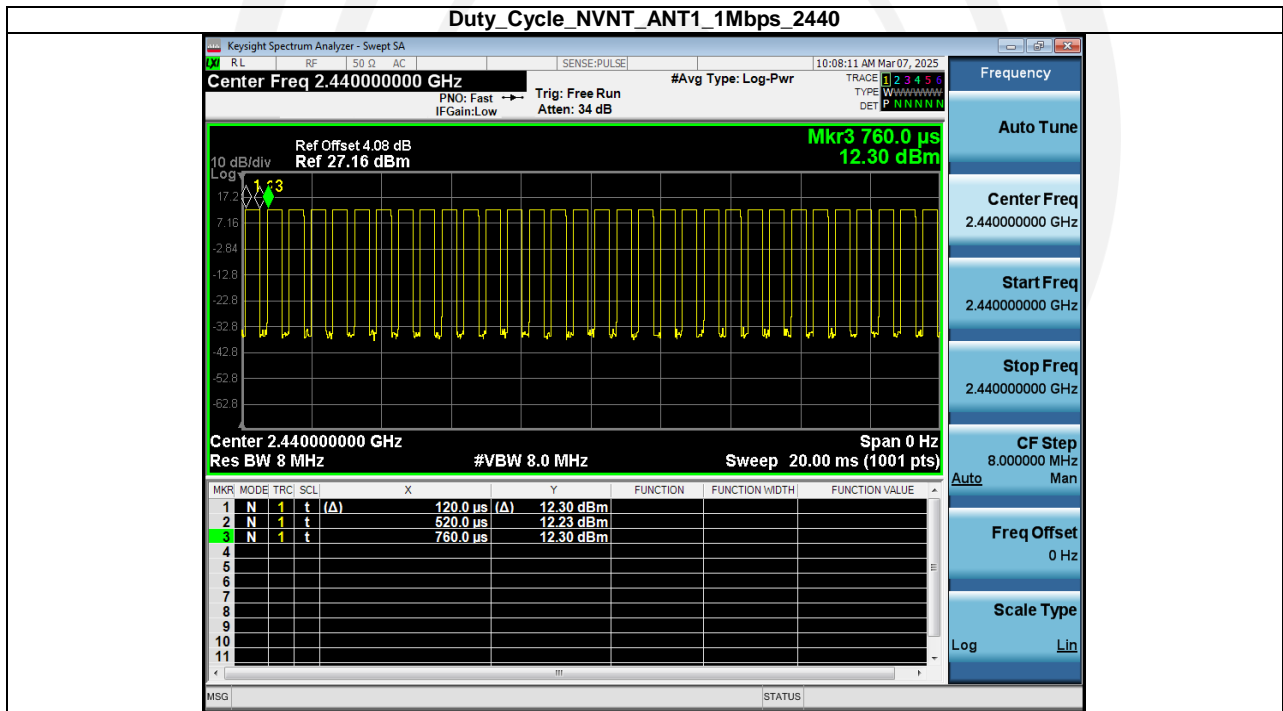
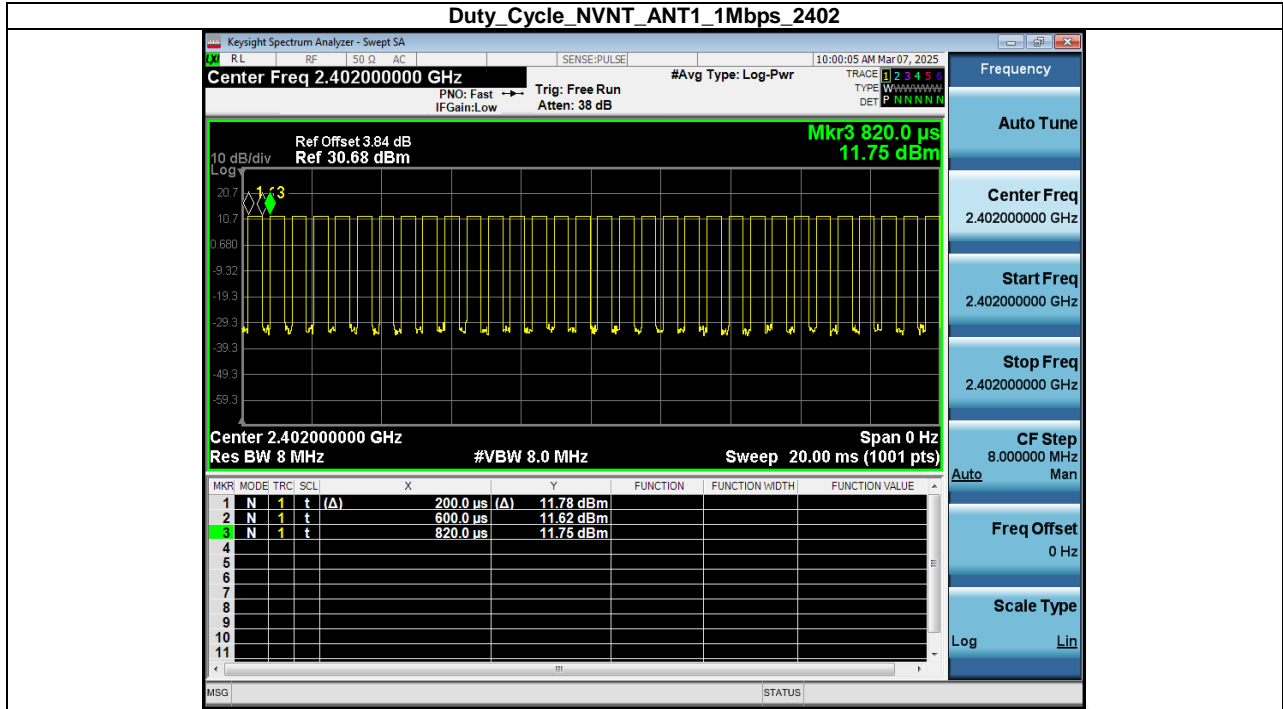

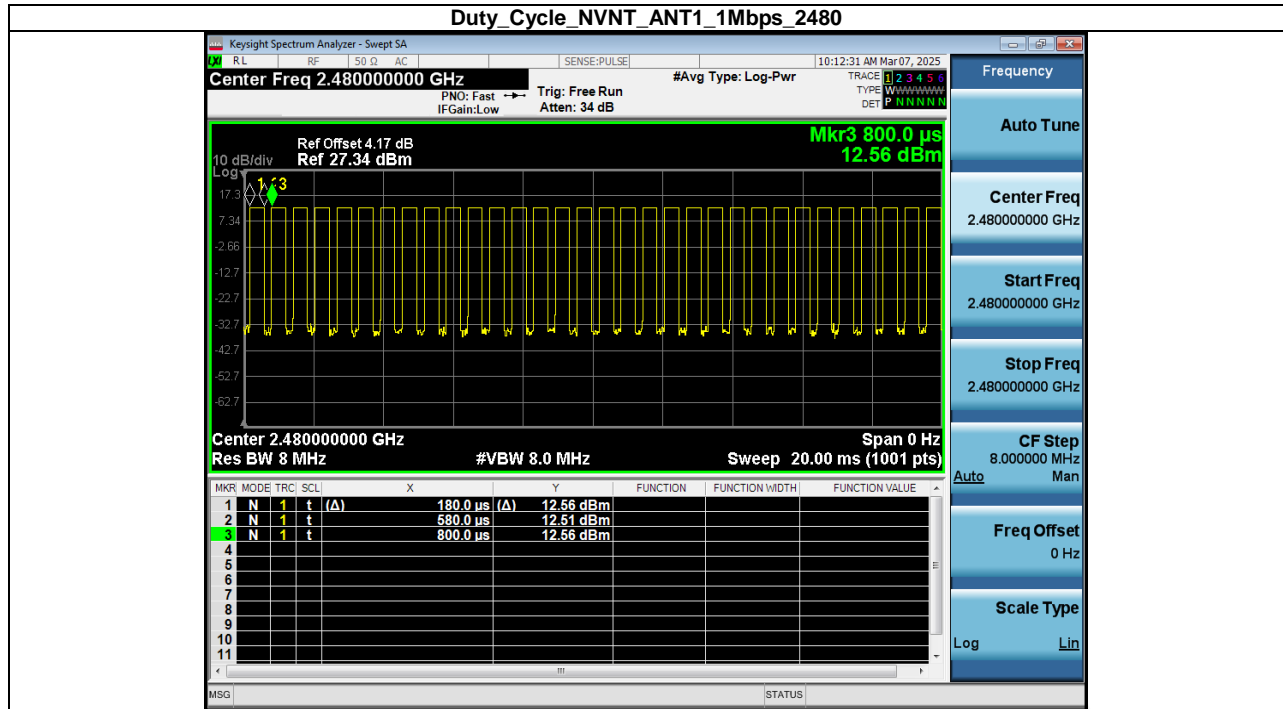

7. Peak Power Spectral Density

7.1. Test limits

- 1 Please refer RSS-247 & FCC PART 15: 15.247.
- 2 For direct sequence systems, the peak power spectral density conducted from the intentional radiator to the antenna shall not be greater than 8dBm in any 3kHz band during any time interval of continuous transmission.
- 3 The direct sequence operating of the hybrid system, with the frequency hopping operation turned off, shall comply with the power density requirements of paragraph (d) of this section.

7.2. Test Procedure

Details see the KDB558074 D01 Meas Guidance v05r02

- 1 Place the EUT on the table and set it in transmitting mode.
- 2 Remove the antenna from the EUT and then connect a low loss RF cable from the antenna port to the spectrum analyzer.
- 3 Set the spectrum analyzer as $RBW = 100\text{kHz}$ (Set the RBW to: $3\text{ kHz} \leq RBW \leq 100\text{ kHz}$.), $VBW = 300\text{kHz}$ (Set the $VBW \geq 3 \times RBW$), $\text{span} \geq 1.5 \times \text{DTS bandwidth}$., detail see the test plot.
- 4 Record the max reading.
- 5 Repeat the above procedure until the measurements for all frequencies are completed.

7.3. Test Setup



7.4. Test Results

Condition	Antenna	Rate	Frequency (MHz)	Power Spectral Density(dBm/3kHz)	Limit(dBm/3kHz)	Result
NVNT	ANT1	1Mbps	2402.00	-2.98	8	Pass
NVNT	ANT1	1Mbps	2440.00	-2.52	8	Pass
NVNT	ANT1	1Mbps	2480.00	-2.42	8	Pass

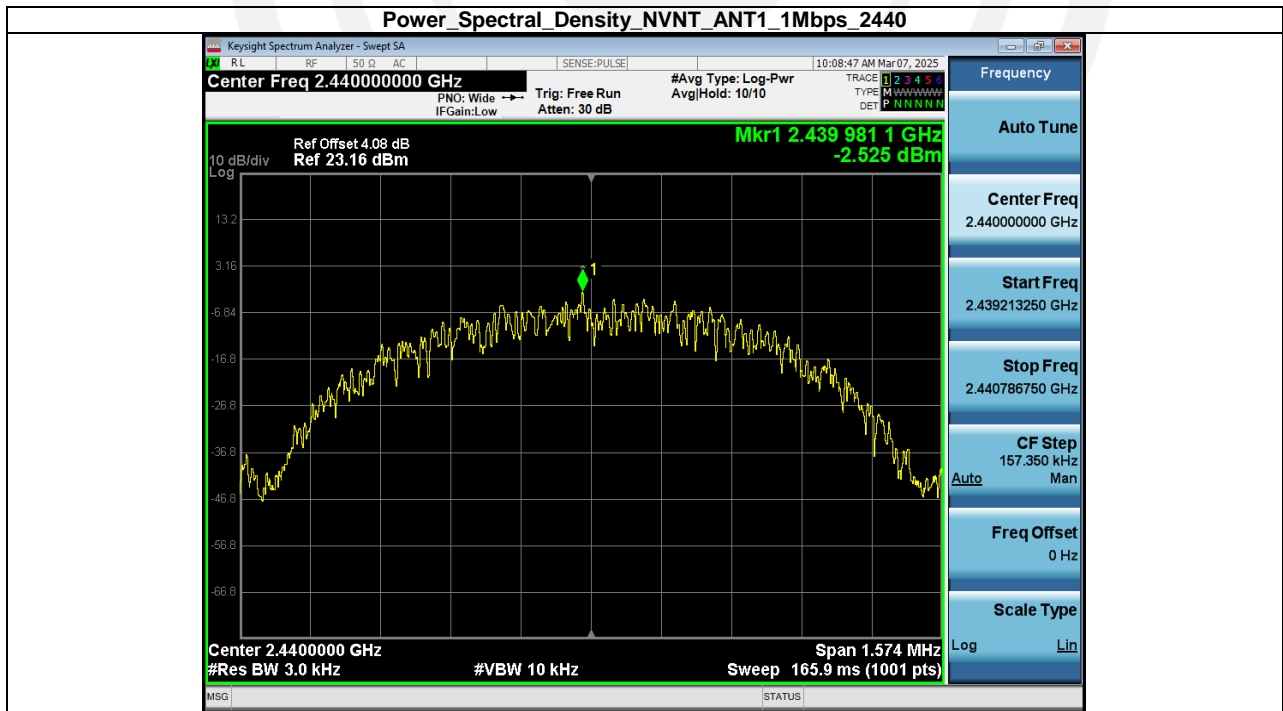
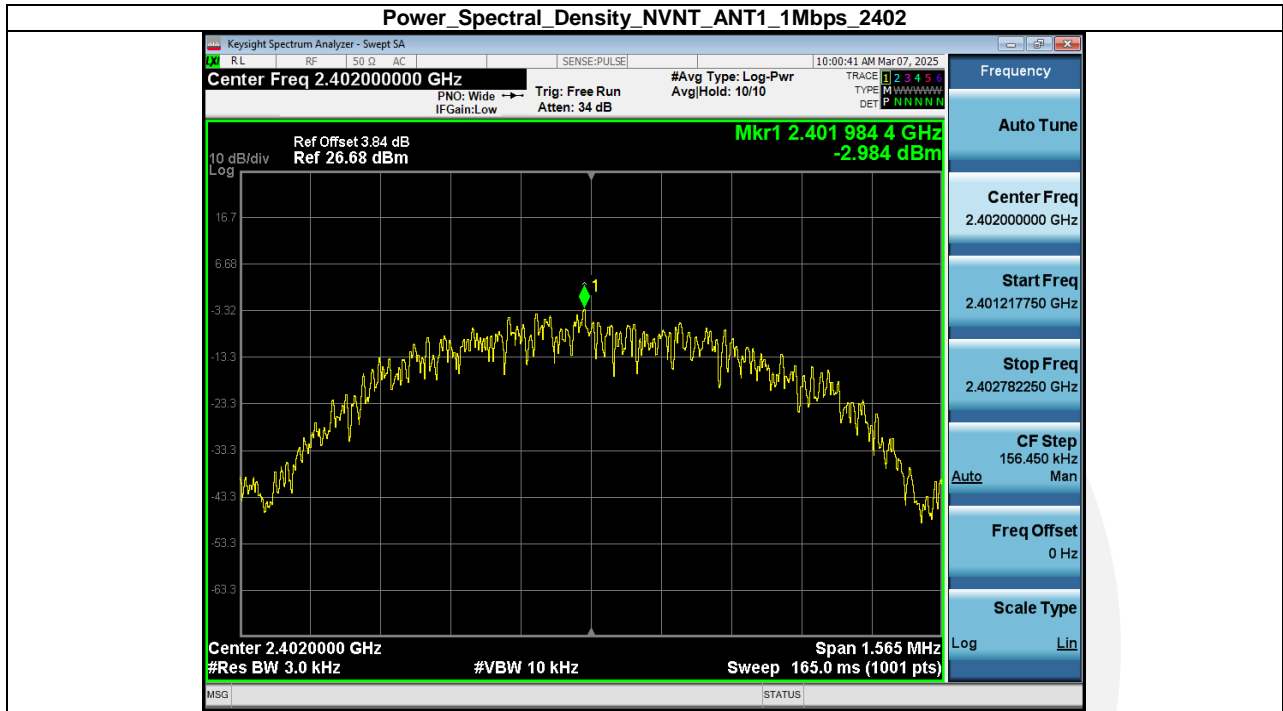

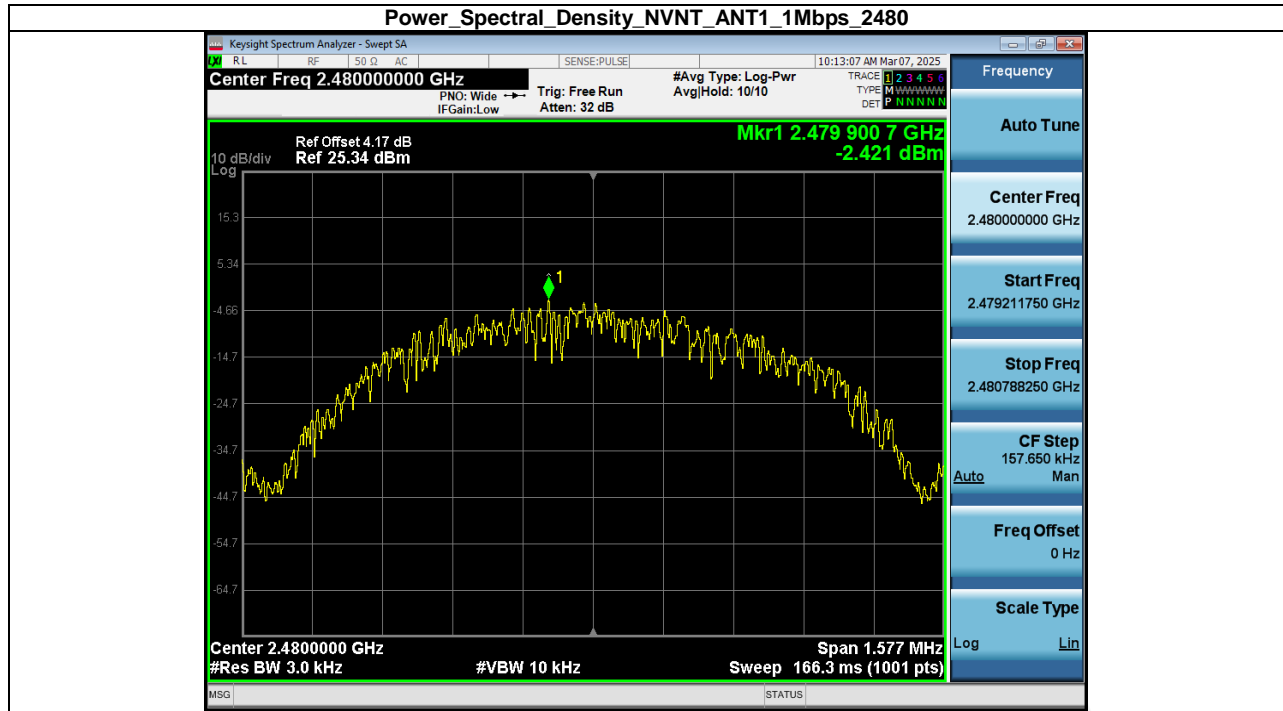

8. Bandwidth

8.1. Test limits

Please refer RSS-247 & FCC PART 15.247

For direct sequence systems, the minimum 6dB bandwidth shall be at least 500 kHz.

8.2. Test Procedure

Details see the KDB558074 D01 Meas Guidance v05r02

- a) The bandwidth is measured at an amplitude level reduced 6dB from the reference level. The reference level is the level of the highest amplitude signal observed from the transmitter at the fundamental frequency. Once the reference level is established, the equipment is conditioned with typical modulating signal to produce the worst-case (i.e. the widest) bandwidth.
- b) The test receiver set RBW = 100kHz, VBW \geq 3*RBW =300kHz,, Peak Detector, Sweep time set auto, detail see the test plot.

8.3. Test Setup

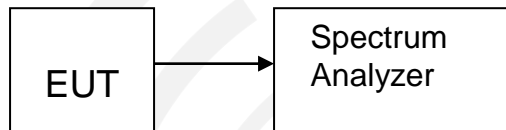

8.4. Test Results

Condition	Antenna	Rate	Frequency (MHz)	-6dB BW(kHz)	limit(kHz)	Result
NVNT	ANT1	1Mbps	2402.00	723.48	500	Pass
NVNT	ANT1	1Mbps	2440.00	721.01	500	Pass
NVNT	ANT1	1Mbps	2480.00	731.30	500	Pass

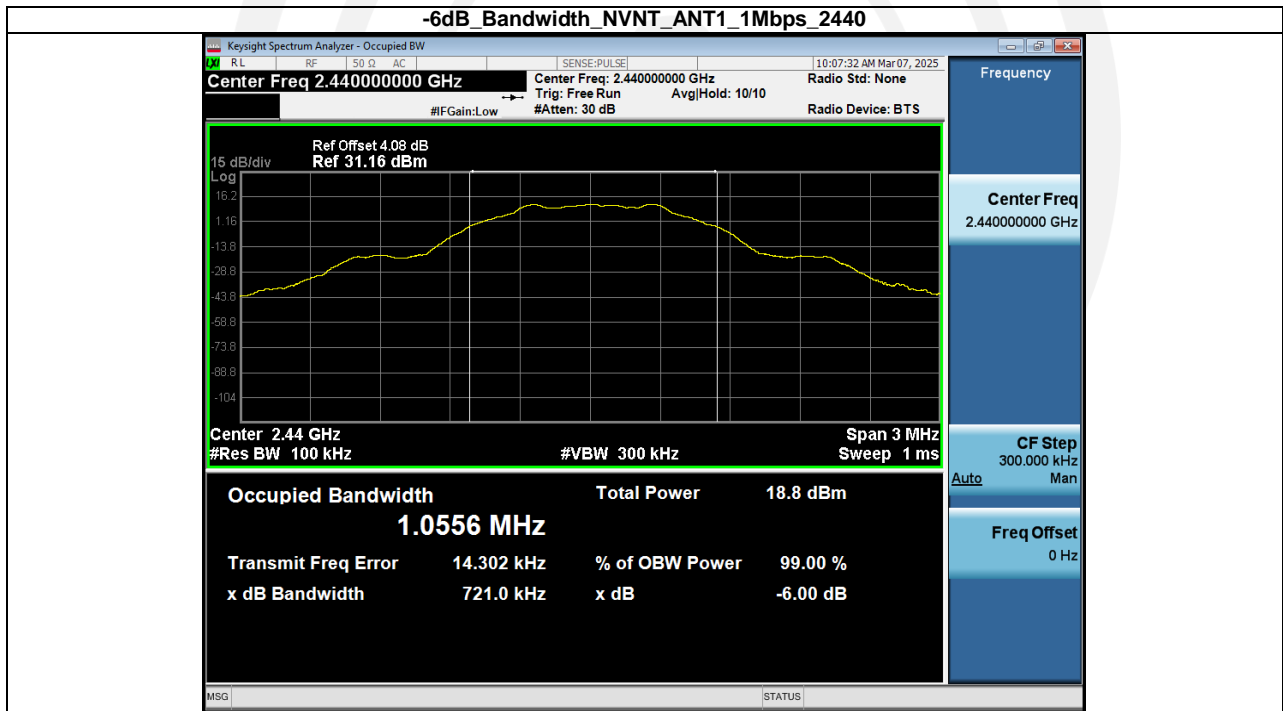
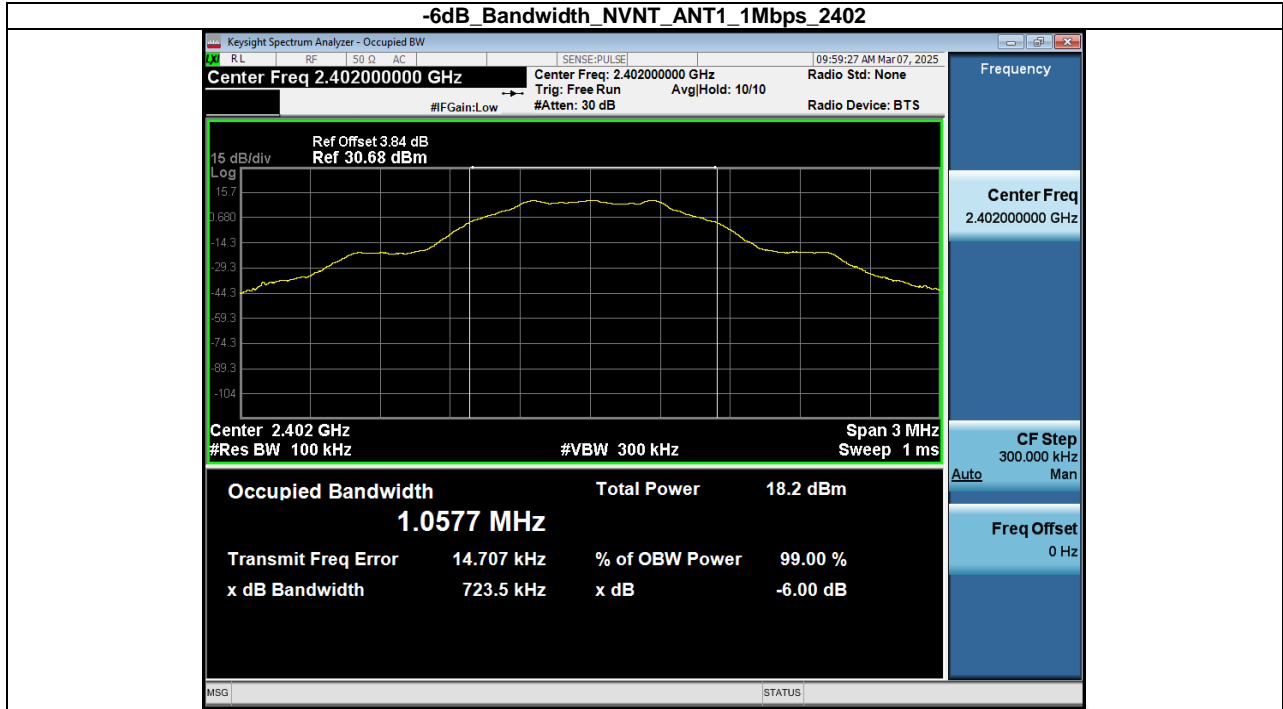

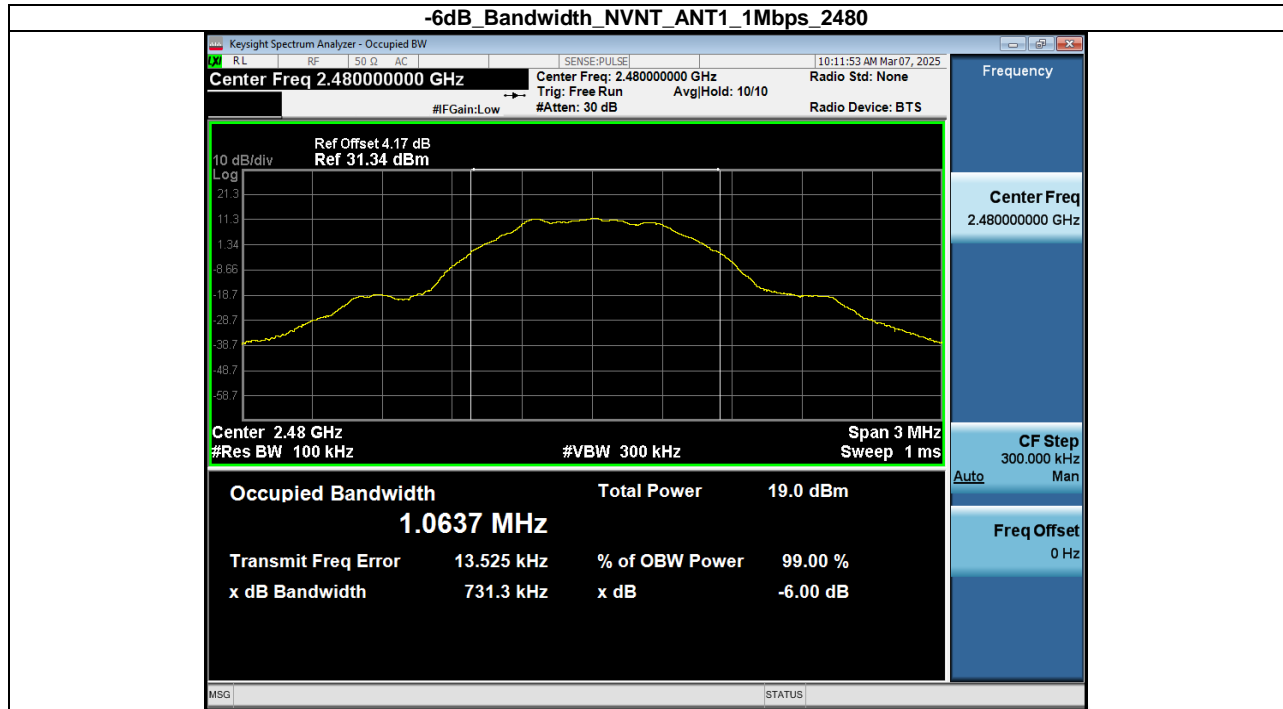

Condition	Antenna	Rate	Frequency (MHz)	99% BW (MHz)
NVNT	ANT1	1Mbps	2402.00	1.043
NVNT	ANT1	1Mbps	2440.00	1.049
NVNT	ANT1	1Mbps	2480.00	1.051

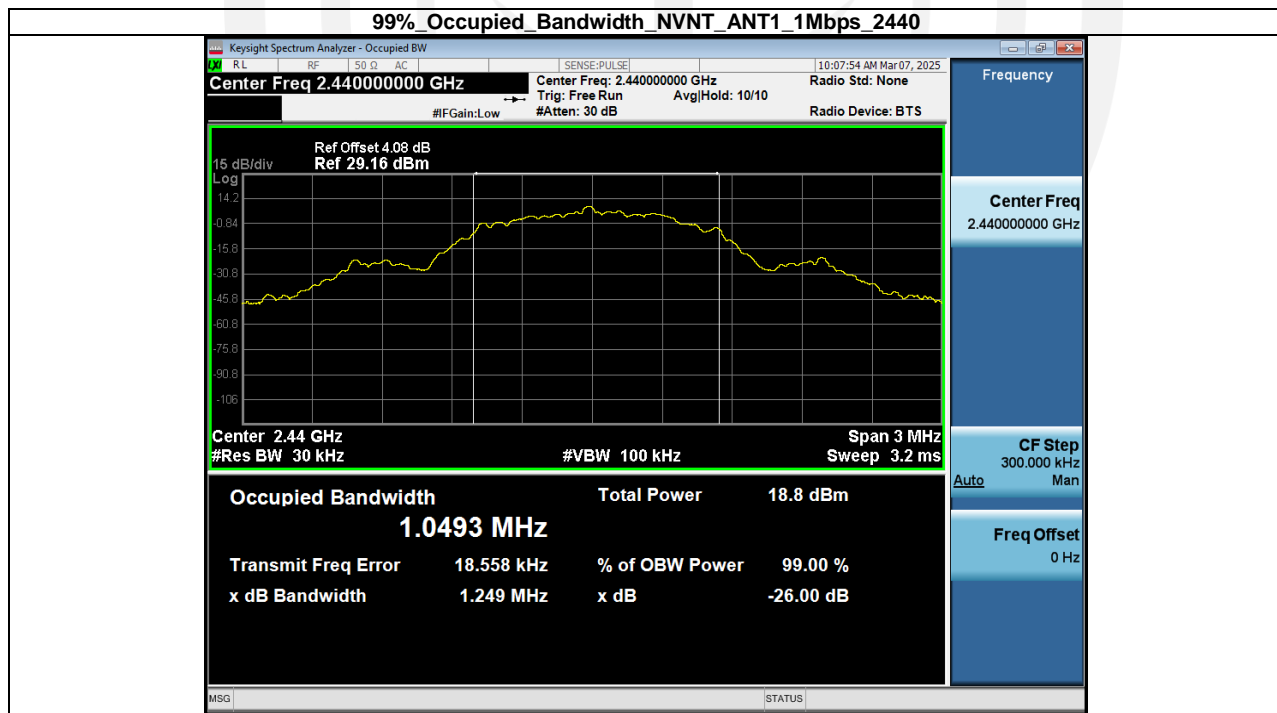
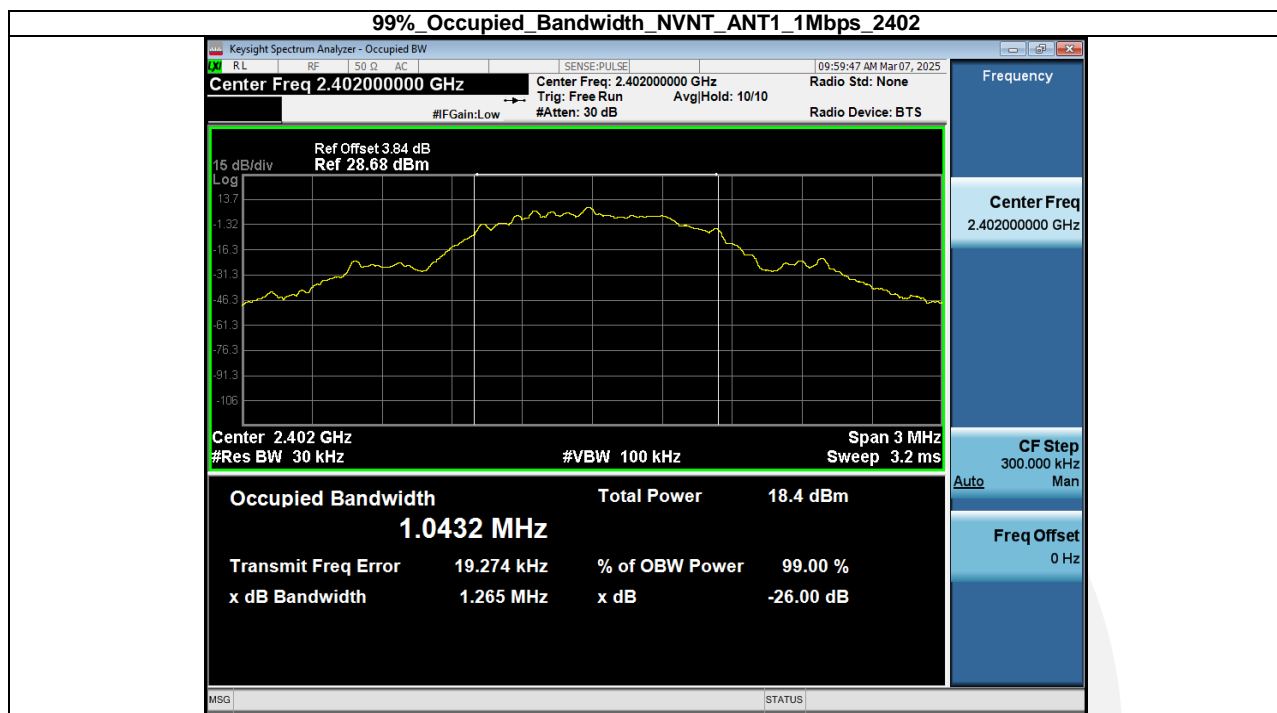

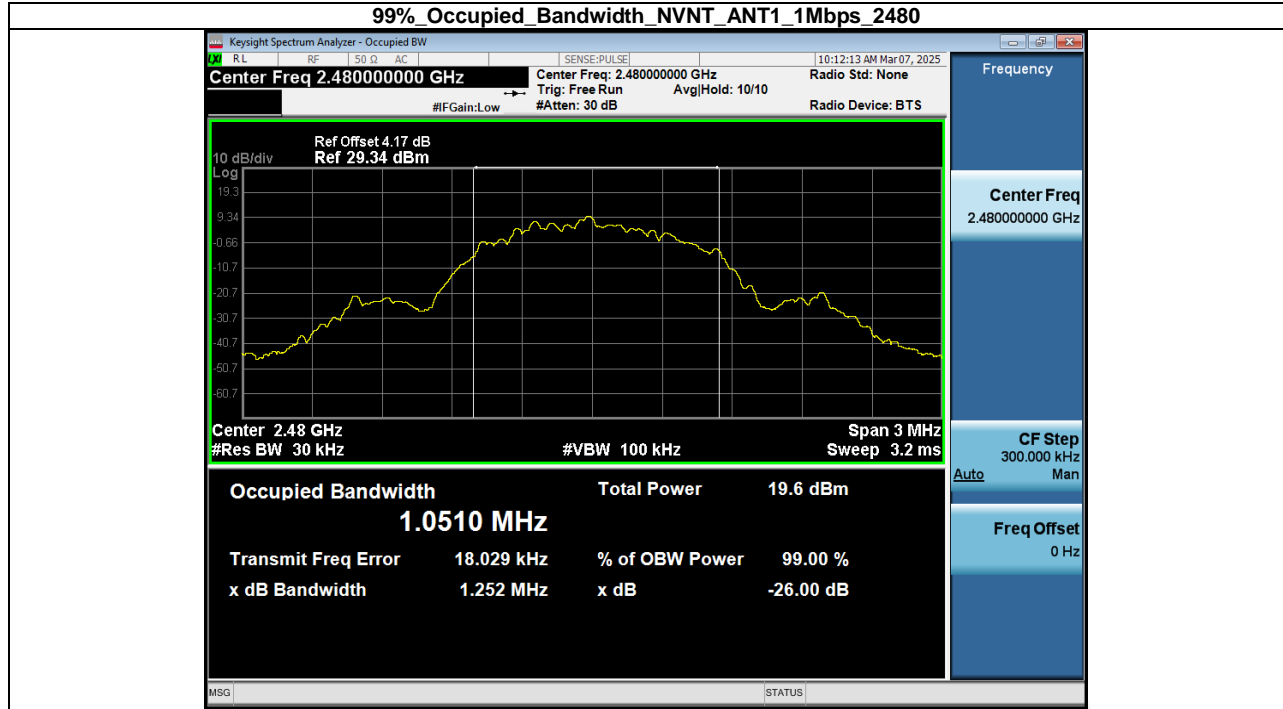

9. Band Edge Test

9.1. Block Diagram of Test Setup

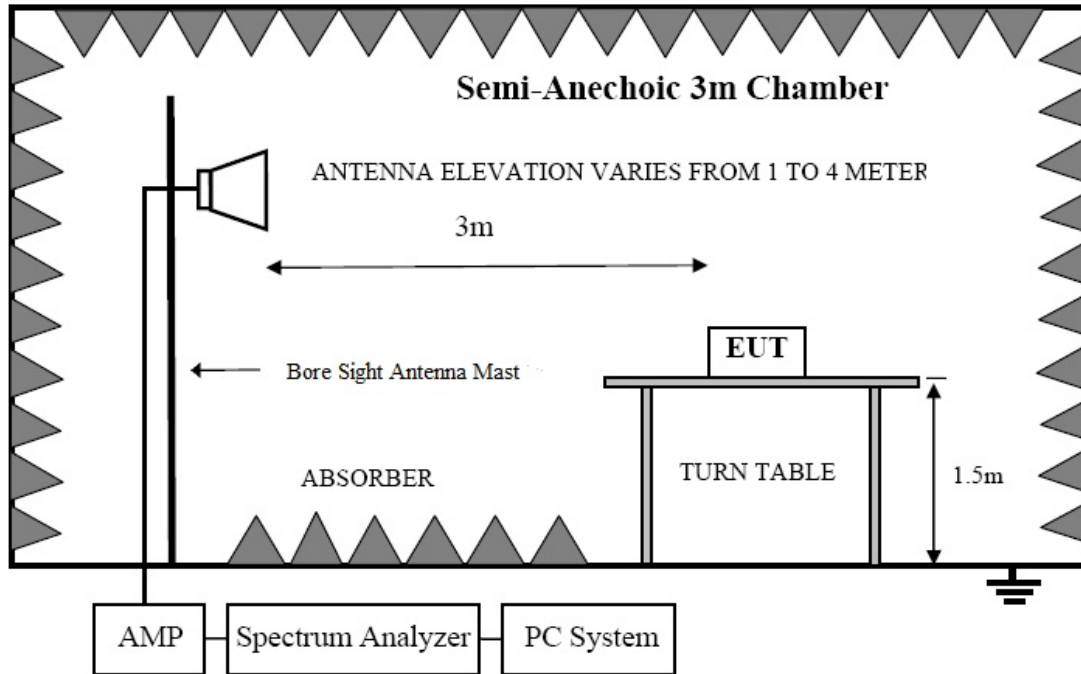

9.2. Test Limit

radiated emissions which fall in the restricted bands, as defined in § 15.205(a), must also comply with the radiated emission limits specified in § 15.209(a) (see § 15.205(c))

Please refer section RSS-GEN&15.247.

9.3. Test Procedure

Refer to ANSI C 63.10, Clause 6.10.

All restriction band and non- restriction band have been tested, only worse case is reported.

Details see the KDB558074 D01 Meas Guidance v05r02

1. Put the EUT on a 0.1m high table, power on the EUT. Emissions were scanned and measured rotating the EUT to 360 degrees, Find the maximum Emission
2. Check the spurious emissions out of band.
3. RBW 1MHz, VBW 3MHz, peak detector for peak value, RBW 1MHz, VBW 10Hz, RMS detector for AV value.

9.4. Test Results

Test Date : 2025.03.03						Temperature : 26°C		
Test Engineer : Felix Pang						Humidity : 54%		
Test Results : PASS								
Frequency Range : 2310MHz~2410MHz								
Test Mode : 1Mbps: GFSK TX 2402MHz								
No.	Freq MHz	Polarity	Reading (dBuV/m)	Correct Factor	Result (dBuV/m)	Limit (dBuV/m)	Margin	Remark
1	2390	H	59.92	-20.45	39.47	74.00	-34.53	Peak
2	2390	H	--	-20.45	--	54.00	--	Avg
3	2400	H	63.97	-20.41	43.56	74.00	-30.44	Peak
4	2400	H	--	-20.41	--	54.00	--	Avg
1	2390	V	63.62	-20.45	43.17	74.00	-30.83	Peak
2	2390	V	--	-20.45	--	54.00	--	Avg
3	2400	V	62.99	-20.41	42.58	74.00	-31.42	Peak
4	2400	V	--	-20.41	--	54.00	--	Avg
Frequency Range : 2450MHz~2550MHz								
Test Mode : 1Mbps: GFSK TX 2480MHz								
1	2483.5	H	63.91	-20.15	43.76	74.00	-30.24	Peak
2	2483.5	H	--	-20.15	--	54.00	--	Avg
1	2483.5	V	64.07	-20.15	43.92	74.00	-30.08	Peak
2	2483.5	V	--	-20.15	--	54.00	--	Avg
Note:	<p>1. Means other frequency and mode comply with standard requirements and at least have 20dB margin.</p> <p>2. Correct Factor=Cable Loss+ Antenna Factor-Amplifier Gain. Result=Reading + Correct Factor. Margin= Result-Limit.</p> <p>3. If the limits for the measurement with the average detector are met when using a receiver with a peak detector, the test unit shall be deemed to meet both limits and the measurement with the average detector need not be carried out.</p>							

10. Frequency stability

10.1. Test limit

Please refer section RSS-Gen.

Regulation RSS-Gen If the frequency stability of the licence-exempt radio apparatus is not specified in the applicable RSS, the fundamental emissions of the radio apparatus should be kept within at least the central 80% of its permitted operating frequency band in order to minimize the possibility of out-of-band operation. In addition, its occupied bandwidth shall be entirely outside the restricted bands and the prohibited TV bands of 54-72 MHz, 76-88 MHz, 174-216 MHz, and 470-602 MHz, unless otherwise indicated.

10.2. Test Procedure

The following equipment are installed on the emission measurement to meet the commission requirements and operating regulations in a manner which tends to maximize its emission characteristics in normal application.

10.3. Test Setup

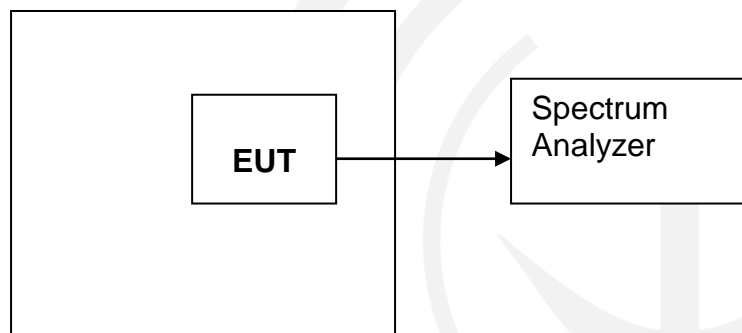

Temperature controller

10.4. Test Results

Not Applicable.

11. Antenna Requirement

11.1. Standard Requirement

An intentional radiator shall be designed to ensure that no antenna other than that furnished by the responsible party shall be used with the device. The use of a permanently attached antenna or of an antenna that uses a unique coupling to the intentional radiator shall be considered sufficient to comply with the provisions of this Section. The manufacturer may design the unit so that a broken antenna can be replaced by the user, but the use of a standard antenna jack or electrical connector is prohibited.

11.2. Antenna Connected Construction

The antenna connector is unique antenna and no consideration of replacement. Please see EUT photo for details.

11.3. Results

The EUT antenna is internal antenna. It complies with the standard requirement.

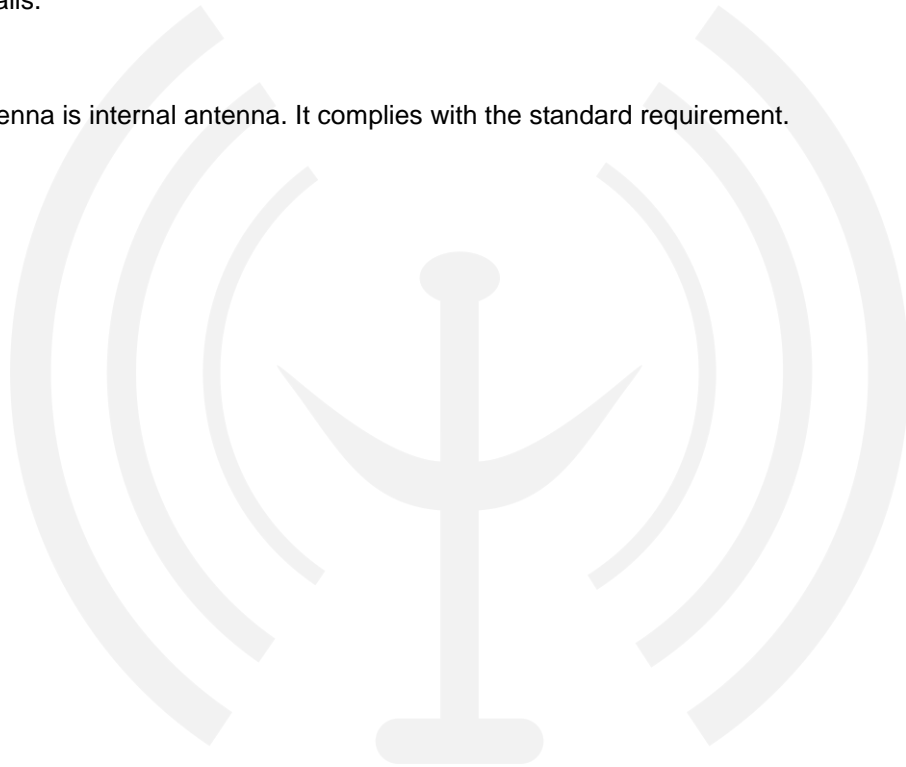

12. Photos of test setup

Reference to the **appendix I Test Setup Photo** for details.

13. Photos of EUT

Reference to the **appendix II external photos** and **appendix III internal photos** for details.

----- END OF REPORT-----

