

Dongle Antenna Specification

Antenna overview

1. Antenna Type and Model:
Type: PCB Antenna
Model: PIFA Antenna
2. Gain: about 3.36dBi (peak)
3. Antenna Directivity Coefficient: about -1 @2450MHz
4. Antenna Polarization characteristic: elliptical polarization
5. Inside or outside: Inside
6. Name of Manufacturer: Shenzhen Bailihe Technology Co., LTD(深圳市百里和科技有限公司)
7. Name of Laboratory: Shenzhen Bailihe Technology Co., LTD (深圳市百里和科技有限公司)

Dongle PIFA Antenna

The Dongle antenna adopts the ultra-small PIFA antenna, and because of the limited area of PCB, the gain of antenna will be smaller than that of the other antennas. The communication distance can reach about 15 ~ 20 meters. The size of the Dongle Module PCB antenna is 8.8 * 3.0mm, and the thickness of PCB is 1mm. The specific size of the antenna is shown in figure 1, the physical object is shown in figure 2.

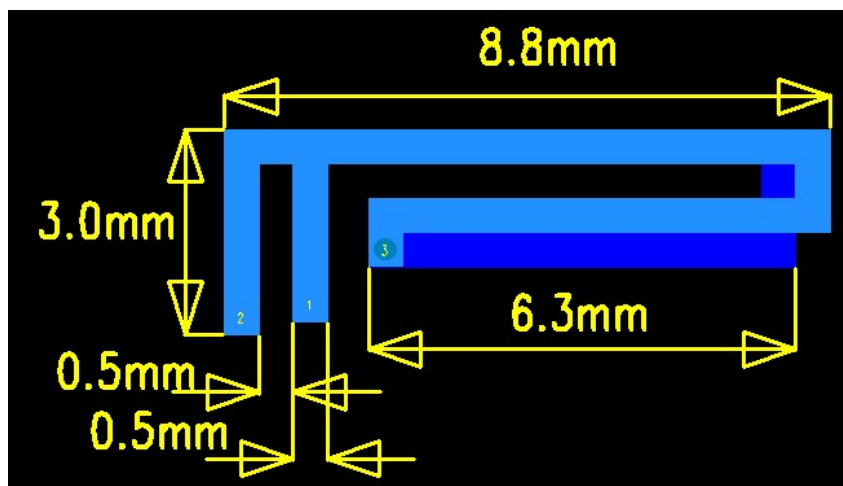

Figure 1 :Dongle Antenna

The antenna's S11 test data is shown in figure 3, covering the entire 2.4 G frequency band.

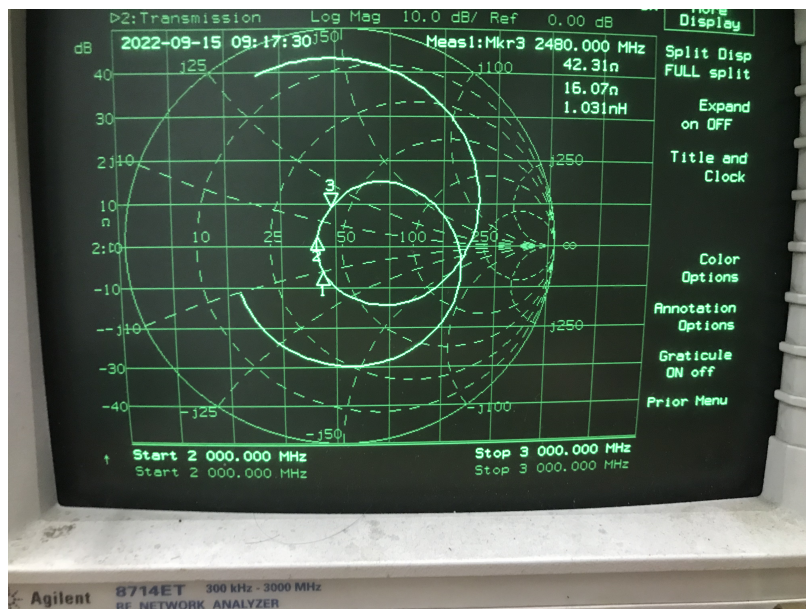

Figure 2 Dongle Antenna S11

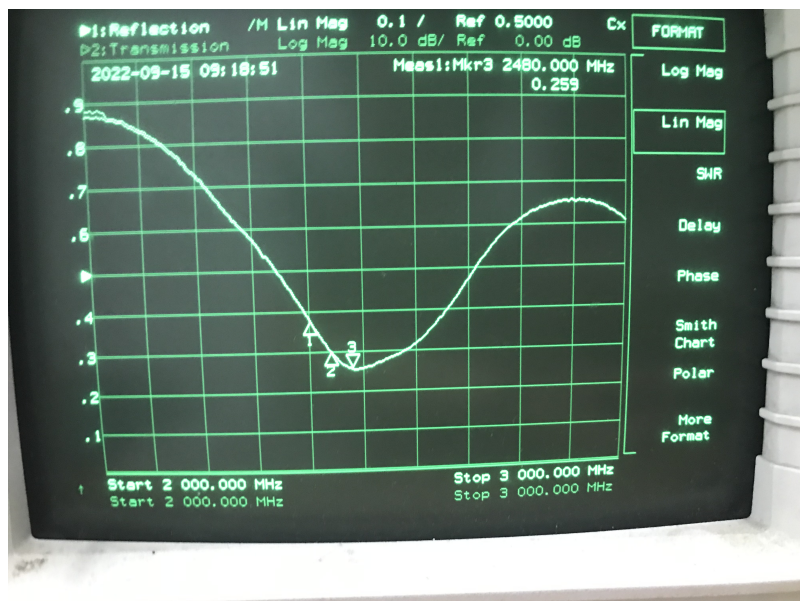
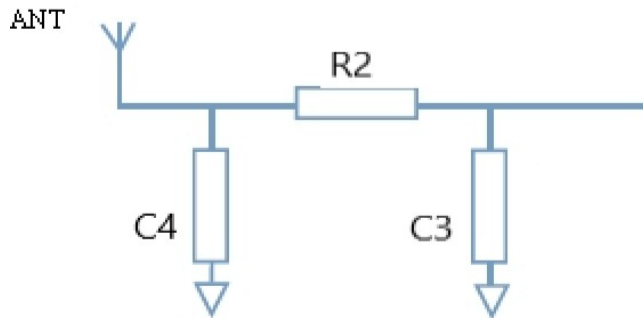

Figure 3 Dongle Antenna S11

The gain simulation data of the antenna is shown in figure 4



Number	Brand	Value
R2	Yageo	0.5pF
C3		NC
C4		NC

Channel List-2.4G(MHz)

2402	2404	2406	2408	2410	2412	2414	2416	2418	2420
2422	2424	2426	2428	2430	2432	2434	2436	2438	2440
2442	2444	2446	2448	2450	2452	2454	2456	2458	2460
2462	2464	2466	2468	2470	2472	2474	2476	2478	2480

ANNEX A TEST RESULTS

A.1 Gain and Efficiency

Frequency	Gain (dBi)	Efficiency (%)
2400MHz	3.22	57
2410MHz	3.14	58
2420MHz	3.08	57
2430MHz	3.27	56
2440MHz	3.29	56
2450MHz	3.36	56
2460MHz	3.10	54
2470MHz	2.87	53
2480MHz	2.96	54
2490MHz	2.89	53
2500MHz	2.45	52

1D Radiation Pattern

PHI=0

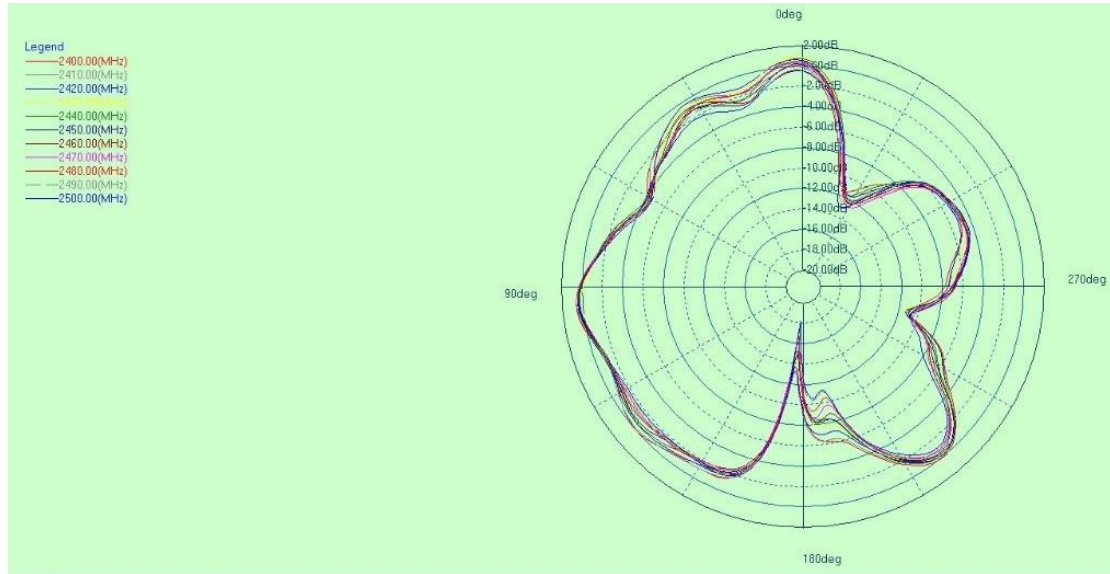

PHI=90

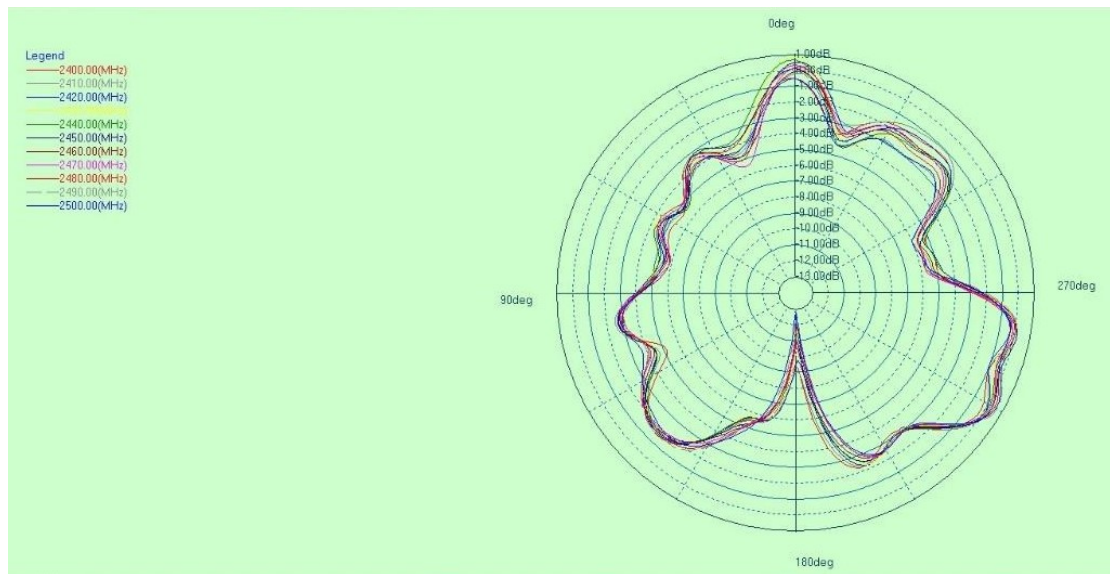

THETA=90

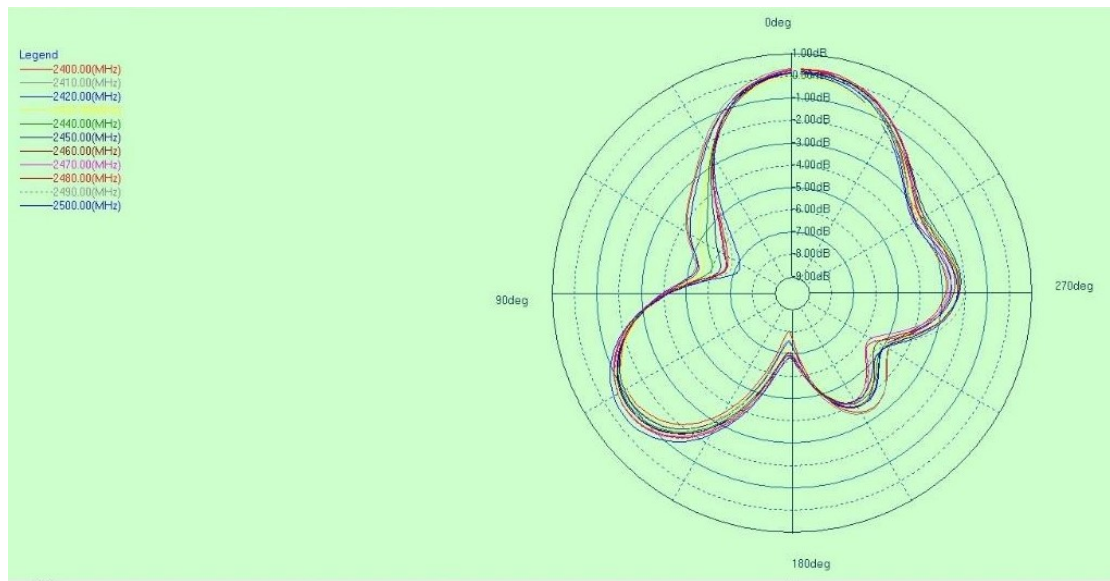

ANNEX B RADIATION PATTERN

B.1 3D Pattern

B1.1 3D Pattern for 2400MHz

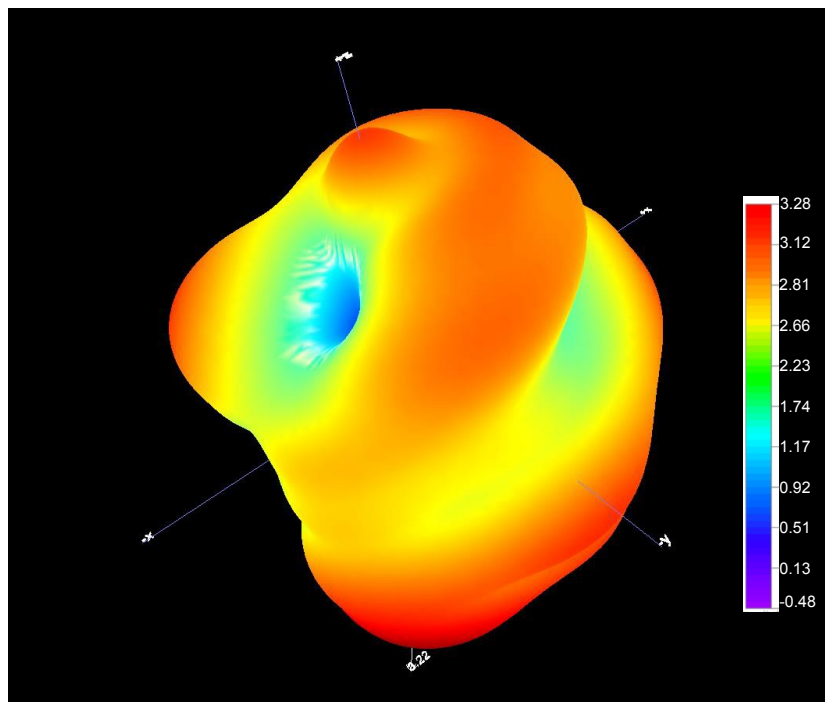

B1.2 3D Pattern for 2450MHz

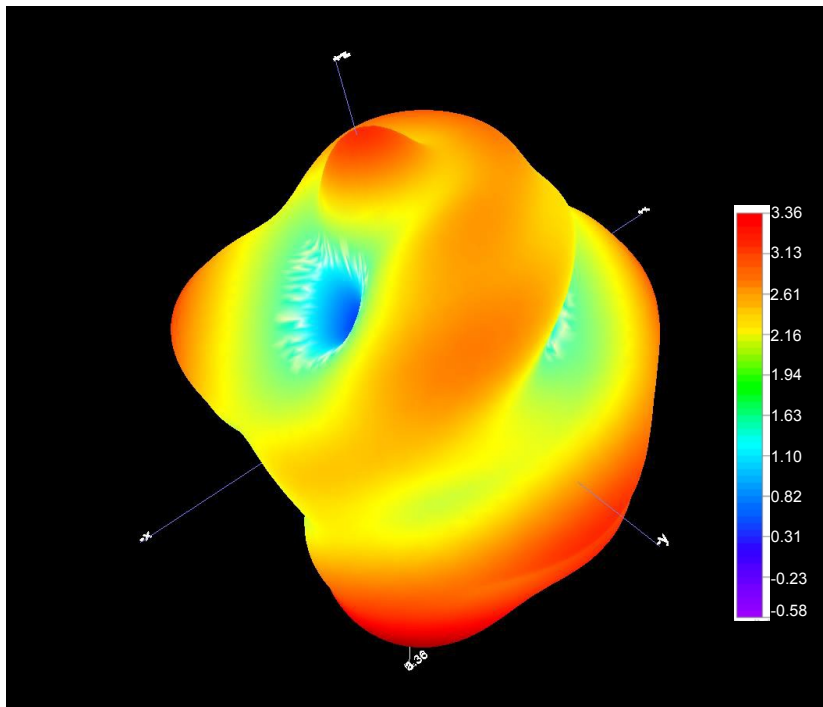

B1.3 3D Pattern for 2500MHz

