

Smart vacuum cleaner User Manual

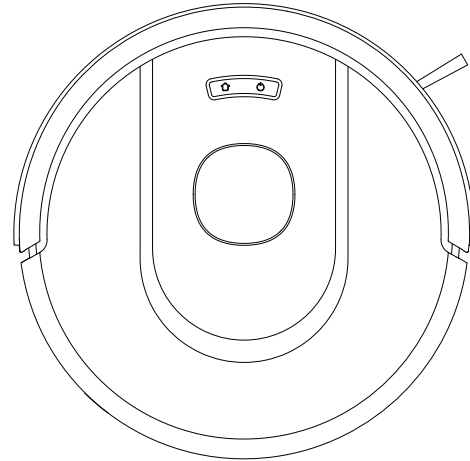

Safety Instructions

Usage Restrictions

- This product is intended for floor cleaning in a domestic environment only and should not be used in an outdoor, off-ground, commercial or industrial environment. This product should not be used by handicapped or inexperienced persons (including children) unless supervised or instructed by a guardian to ensure safe use of the product.
- Do not allow children to use this product as a toy, and supervise children and pets to keep them as far away as possible while working.
- If the power adapter is damaged, it must be replaced with specialized components purchased from its manufacturer's repair department.
- Do not place children or pets and any objects on the stopped or running main unit.
- Do not place the cleaning brush in an area accessible to children.
- Do not use in overhanging environments (e.g. duplex floors, open balconies, tops of furniture) without a guardrail.
- Do not use the product in an environment higher than 35°C, lower than 0°C, or where there are any wave bodies and sticky substances on the ground.
- Do not use to sweep up any burning objects.
- Please organize and put away the cables on the floor of your home before use to avoid dragging when the main unit is running.
- Please put away the ground fragile products and sundries (such as vases, plastic bags, etc.), to avoid the mainframe in the operation of the obstruction or slight collision caused by the home valuables damage.
- Do not allow the main unit to pick up hard or sharp objects (e.g., decoration waste, glass, nails, etc.).
- Do not use the mopping mode on carpet.
- Please clean and maintain the main unit and the charging cradle in the power-off state.
- Do not leave the main unit upside down on the floor for a long time.
- Do not use the laser distance sensor as a carrying handle to carry the main unit.
- Please use this product in accordance with the instructions of the manual, if any loss caused by improper use of the user shall be borne by the user.
- If you need to transport the product, please make sure that the main unit is turned off, and it is recommended to use the original box for packaging protection.

Battery & Charging

- Do not use any third-party batteries or charging cradles, the main unit is limited to use with the original power adapter.
- Do not disassemble, repair, or modify the battery or charging cradle privately.
- Do not place the charging cradle near a heat source (e.g., radiator, etc.).
- Before scrapping the main unit, the power supply must be disconnected and the battery removed from the main unit for environmental scrapping.
- If it is not used for a long time, please turn off the main unit after it is fully charged and put it in a cool and dry place. In addition, it is recommended to recharge the battery at least once every 3 months to avoid battery damage.

Battery Removal Procedure

1. For environmental protection purposes, the user should dispose of this product in accordance with current national or regional laws and regulations on the disposal of WEEE, or transfer this product to a local approved recycling/disposal facility.
2. Only qualified full-time engineers from approved recycling/disposal organizations can safely dismantle and dispose of the robot's batteries in accordance with the following procedures.

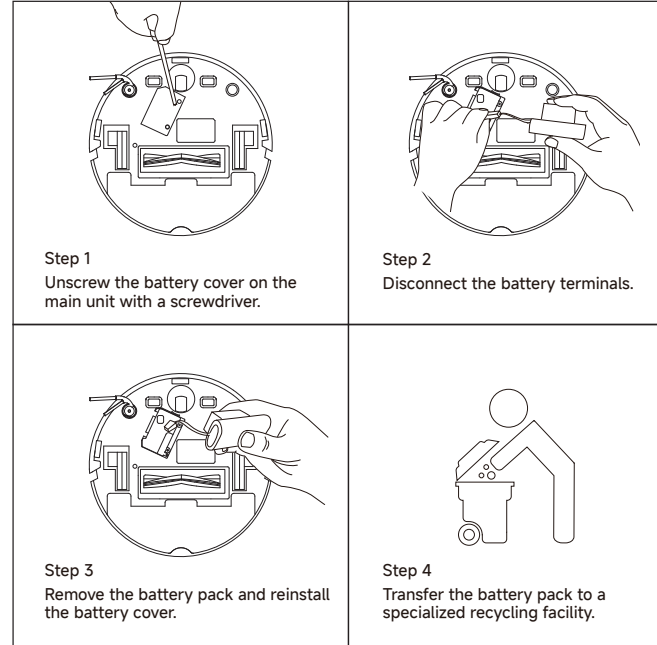

Environmental notes

The chemical substances in the built-in lithium-ion battery of this product can pollute the environment. Before scrapping, the battery should be removed by professionals and handed over to a professional battery recycling agency for centralized disposal.

Products

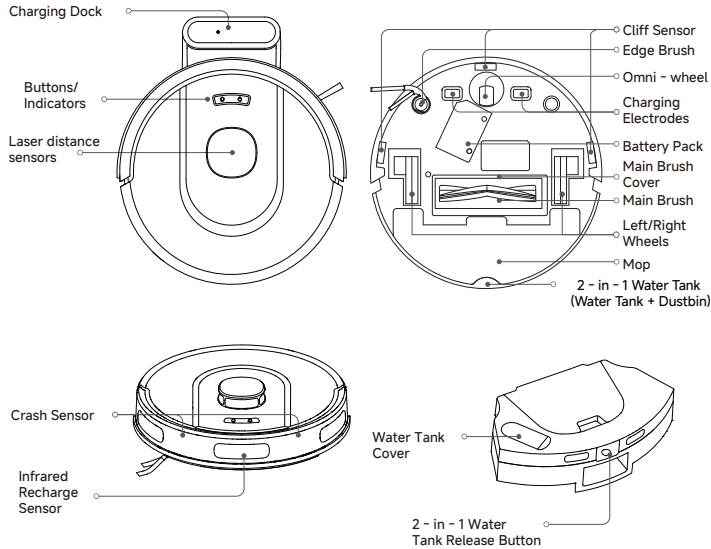

· Press and hold for 3 seconds to turn on or off the device.
· Short - press to start or pause.

· Working: short press to pause;
· Paused: short press to resume charging;
· Charging: short press to stop charging.

Host Indicator Status Description

- White light is always on: The main unit is in normal condition.
- Red light breathing: Charging.
- White light is always on: The battery is fully charged.
- White light flashing: Firmware upgrade in progress/network connection in progress/ searching for the robot.
- Red light flashing: The main unit is in an abnormal state.
- Lights out: The device is turned off or in standby mode.

Preparation Before Use

Removal and Installation

- Please remove the anti - collision strips on both sides of the main unit.
- Remove the side brush and install it into the indicated buckle position. A "click" sound indicates proper installation.

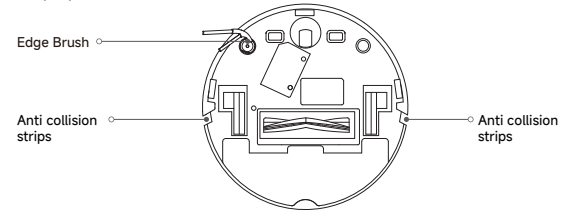

Charging

Tear off the protective film of the charging dock, place it against the wall, and connect to the power supply. Place the main unit on the charging dock for charging.

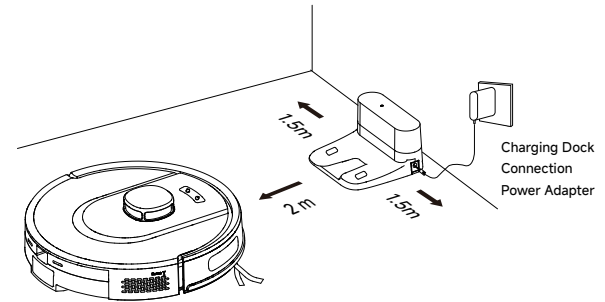

Notes

- Do not place the charging dock in direct sunlight.
- Ensure that no objects are placed within 1.5 meters on the left and right sides and 2 meters in front of the charging dock.
- For the first charge, it is recommended to fully charge the device before use to protect the battery performance.
- When the charging electrodes of the main unit are aligned with the spring - loaded contacts of the charging dock, the device will automatically turn on. It cannot be turned off during charging.

Network Configuration

This product is connected to Smart Life and can be controlled through the Smart Life APP, enabling interconnection with other products.

Connect to the "Smart Life" APP

1. Scan the QR code to download and install "Smart Life". Users who have already installed the "Smart Life" APP will directly enter the device connection page. Alternatively, search for "Smart Life" in the app store and download and install the "Smart Life" APP.
2. Open the home page of the "Smart Life" APP, click "+" in the upper - right corner, and add the device according to the APP prompts.



Tips

- This product only supports connecting to 2.4GHz Wi - Fi networks.
- Due to the upgrade and update of the Smart Life APP, the actual operation may slightly differ from the above description. Please follow the instructions within the current Smart Life APP.

Reset Wi - Fi

Press and hold the  for 3 seconds while the device is on. After hearing the voice prompt, the Wi - Fi reset is successful.

Usage

Tips: For the first use, complete the quick mapping according to the APP prompts. It is recommended to follow the main unit throughout the process and assist in cleaning up items that may affect the operation of the main unit. Ensure that the main unit starts from the charging dock and remove obstacles on the floor to ensure accurate mapping. If certain areas may trap the main unit or the main unit may scratch the surface of furniture during operation, set no - go zones in the mobile APP to prevent the main unit from entering these areas.

Start sweeping and mopping

1. Press and hold the 2-in-1 water tank release button, remove the 2-in-1 water tank, open the tank cover, fill with fresh water and fasten the tank cover.

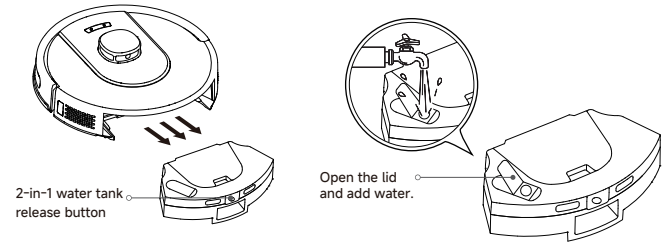

Note: Please remove the two-in-one water tank for filling. Do not add hot water, detergents, disinfectants, etc., to avoid damaging the machine.

2. Install the two-in-one water tank onto the main unit in the direction shown, and then install the mop bracket assembly. A "click" sound indicates that the mop bracket assembly is installed in place.

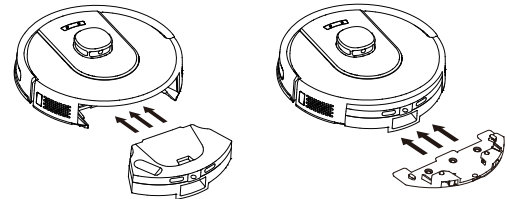

Usage

3. Short press the  to start sweeping and mopping.

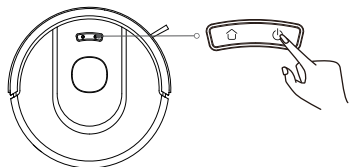

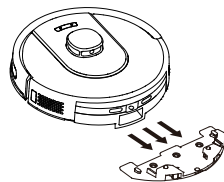

4. If only the sweeping function is required, remove the mop assembly as shown in the illustration.





5. Add water or clean the mop cloth:

When the mainframe is working, please pause and remove the 2-in-1 water tank to add water or clean the mop, then load it back and press the  briefly to continue working.

6. Pause:

When the mainframe is working, press the  briefly to pause, and then press the  briefly to continue working. When the host is paused or standby for 10 minutes, it will automatically enter the hibernation state, short press the  to wake up the machine.

7. Recharge:

When the host is working, short press the  to pause the work, short press the  again to start recharging; standby and not connected to the charging seat, short press the , the host will start recharging, and the host will automatically recharge at the end of the work or when the power is too low.

8. Do Not Disturb Mode

When the host is in this mode, it does not perform breakpoint renewal sweeping, reservation sweeping and active voice broadcasting, and the indicator light goes out after 10 seconds of charging. This mode can be turned on or off in APP.

Note:

- After mopping, please pour out the remaining water in the 2-in-1 water tank in time and wash and dry the mop to avoid odour and mould.
- When the main unit is running, please set up a virtual wall or no-go zone in the carpeted area of your home to avoid carpet entanglement.

Tip: Please refer to the APP for more functions, and the specifics of each function are subject to the APP.

Maintenance and Care

Cleaning the Side Brush and Main Brush

- Pull out the side brush upwards.
- Pinch the two buckles of the main brush cover, remove the main brush cover, take out the main brush, and pull out the end cap of the main brush.
- Use a cleaning brush to clean the side brush and the main brush.

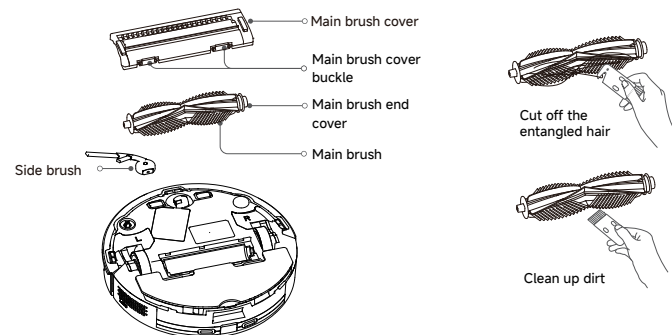



Tips:

- For the cleaning and maintenance of the two-in-one water tank and the mop component, please refer to the reminder labels on the two-in-one water tank and the mop bracket.
- Clean each sensor and the charging electrode plate with a soft cloth once every three months.
- The replacement frequencies are for reference only. If any accessories are damaged, please replace them in a timely manner to ensure the cleaning effect.



Component	Cleaning Frequency	Replacement Frequency
Side Brush	Every two weeks	3 - 6 months
Main Brush	Weekly	6 - 12 months
Filter	Weekly	3 - 6 months
Main Brush Cover	/	3 - 6 months (or when there is wear)
Mop	After each use	3 - 6 months (or when there is wear)

Parameters

Host

Name	Robot vacuum cleaner
Model	X51
Size	Φ320 x95mm
Weight	2.6kg
Rated Power	40W
Rated Voltage	14.4V 
Charging Voltage	19V 
Battery Capacity	2600mAh
Wireless Connection	Wi-Fi IEEE 802.11b/g/n 2.4GHz Wi-Fi IEEE 802.11a/n/ac 5.2GHz Bluetooth Low Energy
Execution Standards	GB 4706.1-2005, GB 4706.7-2014. GB 4343.1-2018, GB 17625.1-2022
CMIIT ID	2020DP6462

Charging Dock

Model	V02
Rated Input	19V  0.6A
Rated Output	19V  0.6A
Size	140x134x75mm

Power Adapter

Rated Input	100V-240V-50/60Hz
Rated Output	19V  0.6A

Troubleshooting

Voice prompts description

When the main machine fails, the home button will be flashing red light or stays on, and voice alarm will be heard. Please refer to the following table to inquire the cause of the failure.

No.	Voice prompt	Cause of failure	Solution
1	Battery is low, please charge the robot vacuum cleaner	Battery below 12V	Charge the machine
2	The main brush is stuck	The main brush is entangled with foreign matter	Remove the foreign matter from the main brush
3	Caster off the ground	The machine is lifted during operation	Put it back on the ground
4	Please check if the caster is stuck	Caster blocking	Remove foreign matter
5	Please check if the side brush is stuck	Side brush blocking	Remove foreign matter
6	Cliff sensor fails	The cliff sensor is dirty	Clean the cliff sensor with a soft cloth
7	Please check if the bumper is stuck	Infrared bumper or universal caster stuck	Remove foreign matter
8	The main machine is stuck	Please move the machine to an open area	Move the machine to another place and then restart it.
9	The laser head is stuck	The laser head is dirty or is entangled with foreign matter	Clean the laser head with a wet swab

Note: The illustrations of the product, accessories, and user interface in the manual are for reference only. Due to product updates and upgrades, there may be slight differences between the actual product and the illustrations. Please refer to the actual product.

List of hazardous substances in products

Component Name	Hazardous substance					
	Lead (Pb)	Mercury (Hg)	Cadmium (Cd)	Chromium VI (Cr(VI))	Polybrominated biphenyls (PBB)	Polybrominated diphenyl ethers (PBDE)
Outer Plastic Parts	○	○	○	○	○	○
Outer Metal Parts	○	○	○	○	○	○
Inner Plastic Parts	○	○	○	○	○	○
Inner Wiring Harness	○	○	○	○	○	○
Motor	×	○	○	○	○	○
Inner Electrical Components	×	○	○	○	○	○
Circuit Board	×	○	○	○	○	○
Adapter	×	○	○	○	○	○
Accessories and Others	×	○	○	○	○	○

This table is compiled in accordance with the provisions of SJ/T 11364.

○ : Indicates that the content of the hazardous substance in all homogeneous materials of the part exceeds the limit stipulated in the current effective version of GB/T26572.

× : It indicates that the content of the harmful substance in at least a homogeneous material of the component exceeds the limit requirements specified in GB/T26572.



FCC Statement

This device complies with Part 15 of the FCC rules. Operation is subject to the following two conditions: 1) this device may not cause harmful interference, and 2) this device must accept any interference received, including interference that may cause undesired operation.

Note: This equipment has been tested and found to comply with the limits for a Class B digital device, pursuant to part 15 of the FCC Rules. These limits are designed to provide reasonable protection against harmful interference in a residential installation.

This equipment generates uses and can radiate radio frequency energy and, if not installed and used in accordance with the instructions, may cause harmful interference to radio communications. However, there is no guarantee that interference will not occur in particular installation. If this equipment does cause harmful interference to radio or television reception, which can be determined by turning the equipment off and on, the user is encouraged to try to correct the interference by one or more of the following measures:

- Reorient or relocate the receiving antenna.
 - Increase the separation between the equipment and receiver.
 - Connect the equipment into an outlet on a circuit different from that to which the receiver is connected.
 - Consult the dealer or an experienced radio/TV technician for help.
- Changes or modifications not expressly approved by the party responsible for compliance could void the user's authority to operate the equipment.

FCC Radiation Exposure Statement

This device complies with FCC RF radiation exposure limits set forth for an uncontrolled environment. This transmitter must not be co-located or operating in conjunction with any other antenna or transmitter.

This device must operate with a minimum distance of 20 cm between the radiator and user body.