

FCC PART 15 SUBPART C TEST REPORT

FCC PART 15.247

Report Reference No..... : MAX25050153P01-R04

FCC ID..... : 2BD8P-BT-15

Compiled by
(position+printed name+signature)..: Engineer/ Cindy Zheng

Cindy Zheng

Supervised by
(position+printed name+signature)..: Manager/Haley Wen

Haley Wen

Approved by
(position+printed name+signature)..: RF Manager/ Vivian Jiang

Vivian Jiang

Date of issue.....: June 28, 2025

Testing Laboratory Name..... : MAXLAB Testing Co.,Ltd.

Address.....: 1/F, Building B, Xinshidai GR Park,Shiyan Street, Bao'an District,
Shenzhen,Guangdong, 518052, People's Republic of China

Applicant's name..... : Shenzhen Zhenpin Technology Co.,Ltd

Address.....: South 3F Block 2, Tongfuyu Industrial Park, Zhenmei Community,
Xinhu Street, Guanming District,Shenzhen City

Test specification..... :

Standard.....: **FCC Part 15.247**

MAXLAB Testing Co.,Ltd. All rights reserved.

This publication may be reproduced in whole or in part for non-commercial purposes as long as the MAXLAB Testing Co.,Ltd. is acknowledged as copyright owner and source of the material. MAXLAB Testing Co.,Ltd. takes no responsibility for and will not assume liability for damages resulting from the reader's interpretation of the reproduced material due to its placement and context.

Equipment description..... : Bluetooth Audio adapter

Trade Mark.....: N/A

Manufacturer.....: Shenzhen Zhenpin Technology Co.,Ltd

Model/Type reference..... : BT-15

Listed Models : N/A

Modulation : GFSK

Frequency..... From 2402MHz to 2480MHz

Rating.....: DC 3.7V From Battery or DC 5V by USB port

Result.....: **PASS**

TEST REPORT

Equipment under Test : **Bluetooth Audio adapter**

Model /Type : **BT-15**

Listed Models : **N/A**

Model Declaration : **N/A**

Applicant : **Shenzhen Zhenpin Technology Co.,Ltd**

Address : **South 3F Block 2, Tongfuyu Industrial Park, Zhenmei Community,
Xinhu Street, Guanming District,Shenzhen City**

Manufacturer : **Shenzhen Zhenpin Technology Co.,Ltd**

Address : **South 3F Block 2, Tongfuyu Industrial Park, Zhenmei Community,
Xinhu Street, Guanming District,Shenzhen City**

Test Result:	PASS
---------------------	-------------

The test report merely corresponds to the test sample.
It is not permitted to copy extracts of these test result without the written permission of the test laboratory.

Contents

1	TEST STANDARDS	4
2	SUMMARY	5
2.1	General Remarks	5
2.2	Product Description	5
2.3	Equipment Under Test	5
2.4	Short description of the Equipment under Test (EUT)	5
2.5	EUT operation mode	6
2.6	Block Diagram of Test Setup	6
2.7	Related Submittal(s) / Grant (s)	6
2.8	Modifications	6
3	TEST ENVIRONMENT	7
3.1	Address of the test laboratory	7
3.2	Test Facility	7
3.3	Environmental conditions	7
3.4	Summary of measurement results	8
3.5	Statement of the measurement uncertainty	8
3.6	Equipments Used during the Test	9
4	TEST CONDITIONS AND RESULTS	11
4.1	AC Power Conducted Emission	11
4.2	Radiated Emissions and Band Edge	14
4.3	Maximum Peak Output Power	21
4.4	Power Spectral Density	22
4.5	6dB Bandwidth	24
4.6	Out-of-band Emissions	26
4.7	Antenna Requirement	29
5	TEST SETUP PHOTOS OF THE EUT	30
6	PHOTOS OF THE EUT	31

1 TEST STANDARDS

The tests were performed according to following standards:

[FCC Rules Part 15.247](#): Frequency Hopping, Direct Spread Spectrum and Hybrid Systems that are in operation within the bands of 902-928 MHz, 2400-2483.5 MHz, and 5725-5850 MHz.

[ANSI C63.10-2020](#): American National Standard for Testing Unlicensed Wireless Devices

[KDB558074 D01 V05r02](#): Guidance for Performing Compliance Measurements on Digital Transmission Systems (DTS) Operating Under §15.247

2 SUMMARY

2.1 General Remarks

Date of receipt of test sample	:	May 6, 2025
Testing commenced on	:	May 6, 2025
Testing concluded on	:	May 15, 2025

2.2 Product Description

Product Description:	Bluetooth Audio adapter
Model/Type reference:	BT-15
Power supply:	DC 3.7V From Battery or DC 5V by USB port
Hardware Version:	/
Software Version:	/
Adapter information (Auxiliary test supplied by testing Lab)	Model: EP-TA20CBC Input: AC 100-240V 50/60Hz Output: DC 5V 2A Firmware Version: EPTA5.14.2 Manufacture: Huizhou Dongyang Yienbi Electronics Co., Ltd
Testing sample ID:	MAX25050153P01-R04-1# (Engineer sample), MAX25050153P01-R04-2# (Normal sample)
Bluetooth BLE	
Supported type:	Bluetooth low Energy
Modulation:	GFSK
Operation frequency:	2402MHz to 2480MHz
Channel number:	40
Channel separation:	2 MHz
Antenna type:	PCB Antenna
Antenna gain:	-0.58 dBi

2.3 Equipment Under Test

Power supply system utilised

Power supply voltage	:	<input type="radio"/> 230V / 50 Hz	<input type="radio"/> 120V / 60Hz
		<input type="radio"/> 12 V DC	<input type="radio"/> 24 V DC
		<input checked="" type="radio"/> Other (specified in blank below) DC 3.7V from battery	

2.4 Short description of the Equipment under Test (EUT)

This is a Bluetooth Audio adapter.
For more details, refer to the user's manual of the EUT.

2.5 EUT operation mode

The Applicant provides communication tools software(Engineer mode) to control the EUT for staying in continuous transmitting (Duty Cycle more than 98%) and receiving mode for testing .There are 40 channels provided to the EUT and Channel 00/19/39 were selected to test.

Operation Frequency:

Channel	Frequency (MHz)
00	2402
01	2404
02	2406
:	:
19	2440
:	:
37	2476
38	2478
39	2480

2.6 Block Diagram of Test Setup

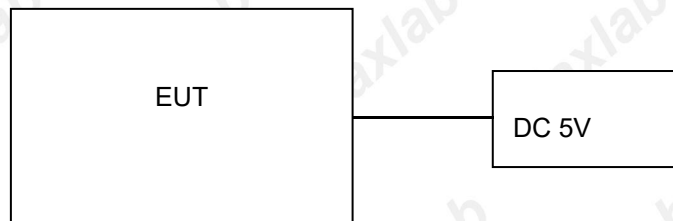

2.7 Related Submittal(s) / Grant (s)

This submittal(s) (test report) is intended for the device filing to comply with Section 15.247 of the FCC Part 15, Subpart C Rules.

2.8 Modifications

No modifications were implemented to meet testing criteria.

3 TEST ENVIRONMENT

3.1 Address of the test laboratory

MAXLAB Testing Co.,Ltd.

1/F, Building B, Xinshidai GR Park, Shiyan Street, Bao'an District, Shenzhen, Guangdong, 518052, People's Republic of China

3.2 Test Facility

FCC-Registration No.: 562200 Designation Number: CN1338

MAXLAB Testing Co.,Ltd. has been listed on the US Federal Communications Commission list of test facilities recognized to perform electromagnetic emissions measurements.

Industry Canada Registration Number. Is: 11093A CAB identifier: CN0019

The Laboratory has been registered by Certification and Engineering Bureau of Industry Canada for radio equipment testing.

A2LA-Lab Cert. No.: 4707.01

MAXLAB Testing Co.,Ltd. has been listed by American Association for Laboratory Accreditation to perform electromagnetic emission measurement.

The 3m-Semi anechoic test site fulfils CISPR 16-1-4 according to ANSI C63.10 and CISPR 16-1-4:2010.

3.3 Environmental conditions

During the measurement the environmental conditions were within the listed ranges:

Radiated Emission:

Temperature:	23 ° C
Humidity:	44 %
Atmospheric pressure:	950-1050mbar

AC Main Conducted testing:

Temperature:	24 ° C
Humidity:	47 %
Atmospheric pressure:	950-1050mbar

Conducted testing:

Temperature:	24 ° C
Humidity:	46 %
Atmospheric pressure:	950-1050mbar

3.4 Summary of measurement results

Test Specification clause	Test case	Test Mode	Test Channel	Recorded In Report		Test result
§15.247(e)	Power spectral density	BLE 1Mbps	<input checked="" type="checkbox"/> Lowest <input checked="" type="checkbox"/> Middle <input checked="" type="checkbox"/> Highest	BLE 1Mbps	<input checked="" type="checkbox"/> Lowest <input checked="" type="checkbox"/> Middle <input checked="" type="checkbox"/> Highest	complies
§15.247(a)(2)	Spectrum bandwidth – 6 dB bandwidth	BLE 1Mbps	<input checked="" type="checkbox"/> Lowest <input checked="" type="checkbox"/> Middle <input checked="" type="checkbox"/> Highest	BLE 1Mbps	<input checked="" type="checkbox"/> Lowest <input checked="" type="checkbox"/> Middle <input checked="" type="checkbox"/> Highest	complies
§15.247(b)(3)	Maximum output Peak power	BLE 1Mbps	<input checked="" type="checkbox"/> Lowest <input checked="" type="checkbox"/> Middle <input checked="" type="checkbox"/> Highest	BLE 1Mbps	<input checked="" type="checkbox"/> Lowest <input checked="" type="checkbox"/> Middle <input checked="" type="checkbox"/> Highest	complies
§15.247(d)	Band edge compliance conducted	BLE 1Mbps	<input checked="" type="checkbox"/> Lowest <input checked="" type="checkbox"/> Highest	BLE 1Mbps	<input checked="" type="checkbox"/> Lowest <input checked="" type="checkbox"/> Highest	complies
§15.205	Band edge compliance radiated	BLE 1Mbps	<input checked="" type="checkbox"/> Lowest <input checked="" type="checkbox"/> Highest	BLE 1Mbps	<input checked="" type="checkbox"/> Lowest <input checked="" type="checkbox"/> Highest	complies
§15.247(d)	TX spurious emissions conducted	BLE 1Mbps	<input checked="" type="checkbox"/> Lowest <input checked="" type="checkbox"/> Middle <input checked="" type="checkbox"/> Highest	BLE 1Mbps	<input checked="" type="checkbox"/> Lowest <input checked="" type="checkbox"/> Middle <input checked="" type="checkbox"/> Highest	complies
§15.247(d)	TX spurious emissions radiated	BLE 1Mbps	<input checked="" type="checkbox"/> Lowest <input checked="" type="checkbox"/> Middle <input checked="" type="checkbox"/> Highest	BLE 1Mbps	<input checked="" type="checkbox"/> Lowest <input checked="" type="checkbox"/> Middle <input checked="" type="checkbox"/> Highest	complies
§15.209(a)	TX spurious Emissions radiated Below 1GHz	BLE 1Mbps	-/-	BLE 1Mbps	-/-	complies
§15.107(a) §15.207	Conducted Emissions < 30 MHz	BLE 1Mbps	-/-	BLE 1Mbps	-/-	complies

Remark:

1. The measurement uncertainty is not included in the test result.
2. We tested all test mode and recorded worst case in report

3.5 Statement of the measurement uncertainty

The data and results referenced in this document are true and accurate. The reader is cautioned that there may be errors within the calibration limits of the equipment and facilities. The measurement uncertainty was calculated for all measurements listed in this test report acc. to TR-100028-01” Electromagnetic compatibility and Radio spectrum Matters (ERM);Uncertainties in the measurement of mobile radio equipment characteristics; Part 1” and TR-100028-02 “Electromagnetic compatibility and Radio spectrum Matters (ERM);Uncertainties in the measurement of mobile radio equipment characteristics; Part 2 “ and is documented in the MAXLAB Testing Co.,Ltd. quality system acc. to DIN EN ISO/IEC 17025. Furthermore, component and process variability of devices similar to that tested may result in additional deviation. The manufacturer has the sole responsibility of continued compliance of the device.

Hereafter the best measurement capability for MAXLAB Testing Co.,Ltd. :

Test	Range	Measurement Uncertainty	Notes
Radiated Emission	9KHz~30MHz	3.82 dB	(1)
Radiated Emission	30~1000MHz	4.06 dB	(1)
Radiated Emission	1~18GHz	5.14 dB	(1)
Radiated Emission	18-40GHz	5.38 dB	(1)
Conducted Disturbance	0.15~30MHz	2.14 dB	(1)
Transmitter power conducted	1~40GHz	0.57 dB	(1)
Conducted spurious emission	1~40GHz	1.60 dB	(1)
OBW	1~40GHz	25 Hz	(1)
PSD	1~40GHz	0.01 dBm/3KHz	(1)

- (1) This uncertainty represents an expanded uncertainty expressed at approximately the 95% confidence level using a coverage factor of k=2.

3.6 Equipments Used during the Test

Conducted Emission					
Test Equipment	Manufacturer	Model	Serial No.	Date of Cal.	Due Date
Shielding Room	ZhongYu Electron	7.3(L)x3.1(W)x2.9(H)	MAX252	2024-10-28	2025-10-27
EMI Test Receiver	R&S	ESCI 7	MAX552	2024-10-28	2025-10-27
Coaxial Switch	ANRITSU CORP	MP59B	MAX225	2024-10-28	2025-10-27
ENV216 2-L-V-NETZNACHB.DE	ROHDE&SCHWARZ	ENV216	MAX226	2024-10-28	2025-10-27
Coaxial Cable	MAX	N/A	MAX227	N/A	N/A
EMI Test Software	AUDIX	E3	N/A	N/A	N/A
Thermo meter	KTJ	TA328	MAX233	2024-10-28	2025-10-27
Absorbing clamp	Elektronik-Feinmechanik	MDS21	MAX229	2024-10-28	2025-10-27
LISN	R&S	ENV216	308	2024-10-28	2025-10-27
LISN	R&S	ENV216	314	2024-10-28	2025-10-27

Radiation Test equipment					
Test Equipment	Manufacturer	Model	Serial No.	Date of Cal.	Due Date
3m Semi- Anechoic Chamber	ZhongYu Electron	9.2(L)*6.2(W)* 6.4(H)	MAX250	2024-10-28	2025-10-27
Control Room	ZhongYu Electron	6.2(L)*2.5(W)* 2.4(H)	MAX251	N/A	N/A
EMI Test Receiver	Rohde & Schwarz	ESU26	MAX203	2024-10-28	2025-10-27
BiConiLog Antenna	SCHWARZBECK MESS-ELEKTRONIK	VULB9163	MAX214	2024-10-28	2025-10-27
Double -ridged waveguide horn	SCHWARZBECK MESS-ELEKTRONIK	BBHA 9120 D	MAX208	2024-10-28	2025-10-27
Horn Antenna	ETS-LINDGREN	3160	MAX217	2024-10-28	2025-10-27
EMI Test Software	AUDIX	E3	N/A	N/A	N/A
Coaxial Cable	MAX	N/A	MAX213	2024-10-28	2025-10-27
Coaxial Cable	MAX	N/A	MAX211	2024-10-28	2025-10-27
Coaxial cable	MAX	N/A	MAX210	2024-10-28	2025-10-27
Coaxial Cable	MAX	N/A	MAX212	2024-10-28	2025-10-27
Amplifier(100kHz-3GHz)	HP	8347A	MAX204	2024-10-28	2025-10-27
Amplifier(2GHz-20GHz)	HP	84722A	MAX206	2024-10-28	2025-10-27
Amplifier (18-26GHz)	Rohde & Schwarz	AFS33-18002 650-30-8P-44	MAX218	2024-10-28	2025-10-27
Band filter	Amindeon	82346	MAX219	2024-10-28	2025-10-27
Power Meter	Anritsu	ML2495A	MAX540	2024-10-28	2025-10-27
Power Sensor	Anritsu	MA2411B	MAX541	2024-10-28	2025-10-27
Wideband Radio Communication Tester	Rohde & Schwarz	CMW500	MAX575	2024-10-28	2025-10-27
Splitter	Agilent	11636B	MAX237	2024-10-28	2025-10-27

Loop Antenna	ZHINAN	ZN30900A	MAX534	2024-10-28	2025-10-27
Breitband hornantenne	SCHWARZBECK	BBHA 9170	MAX579	2024-10-28	2025-10-27
Amplifier	TDK	PA-02-02	MAX574	2024-10-28	2025-10-27
Amplifier	TDK	PA-02-03	MAX576	2024-10-28	2025-10-27
PSA Series Spectrum Analyzer	Rohde & Schwarz	FSP	MAX578	2024-10-28	2025-10-27

RF Conducted Test:

Test Equipment	Manufacturer	Model	Serial No.	Date of Cal.	Due Date
MXA Signal Analyzer	Agilent	N9020A	MAX566	2024-10-28	2025-10-27
EMI Test Receiver	R&S	ESCI 7	MAX552	2024-10-28	2025-10-27
Spectrum Analyzer	Agilent	E4440A	MAX533	2024-10-28	2025-10-27
MXG vector Signal Generator	Agilent	N5182A	MAX567	2024-10-28	2025-10-27
ESG Analog Signal Generator	Agilent	E4428C	MAX568	2024-10-28	2025-10-27
USB RF Power Sensor	DARE	RPR3006W	MAX569	2024-10-28	2025-10-27
RF Switch Box	Shongyi	RFSW3003328	MAX571	2024-10-28	2025-10-27
Programmable Constant Temp & Humi Test Chamber	WEWON	WHTH-150L-40-880	MAX572	2024-10-28	2025-10-27

4 TEST CONDITIONS AND RESULTS

4.1 AC Power Conducted Emission

TEST CONFIGURATION

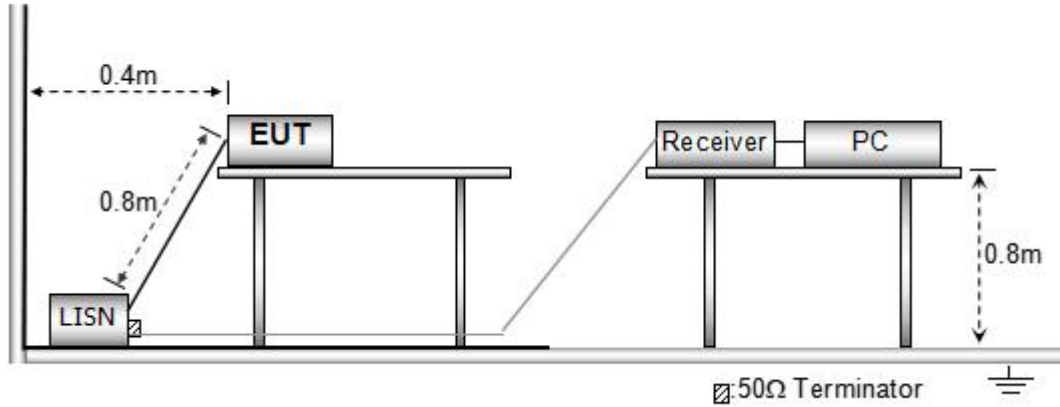

TEST PROCEDURE

- 1 The equipment was set up as per the test configuration to simulate typical actual usage per the user's manual. The EUT is a tabletop system, a wooden table with a height of 0.8 meters is used and is placed on the ground plane as per ANSI C63.10-2020.
- 2 Support equipment, if needed, was placed as per ANSI C63.10-2020
- 3 All I/O cables were positioned to simulate typical actual usage as per ANSI C63.10-2020
- 4 The EUT received power from adapter, the adapter received AC120V/60Hz and AC 240V/60Hz power through a Line Impedance Stabilization Network (LISN) which supplied power source and was grounded to the ground plane.
- 5 All support equipments received AC power from a second LISN, if any.
- 6 The EUT test program was started. Emissions were measured on each current carrying line of the EUT using a spectrum Analyzer / Receiver connected to the LISN powering the EUT. The LISN has two monitoring points: Line 1 (Hot Side) and Line 2 (Neutral Side). Two scans were taken: one with Line 1 connected to Analyzer / Receiver and Line 2 connected to a 50 ohm load; the second scan had Line 1 connected to a 50 ohm load and Line 2 connected to the Analyzer / Receiver.
- 7 Analyzer / Receiver scanned from 150 KHz to 30MHz for emissions in each of the test modes.
- 8 During the above scans, the emissions were maximized by cable manipulation.

AC Power Conducted Emission Limit

For intentional device, according to § 15.207(a) AC Power Conducted Emission Limits is as following:

Frequency range (MHz)	Limit (dBuV)	
	Quasi-peak	Average
0.15-0.5	66 to 56*	56 to 46*
0.5-5	56	46
5-30	60	50

* Decreases with the logarithm of the frequency.

TEST RESULTS

Remark:

This mode is for testing data in the charging state.

Power supply:

DC 5V from Adapter AC
120V/60Hz

Polarization

L

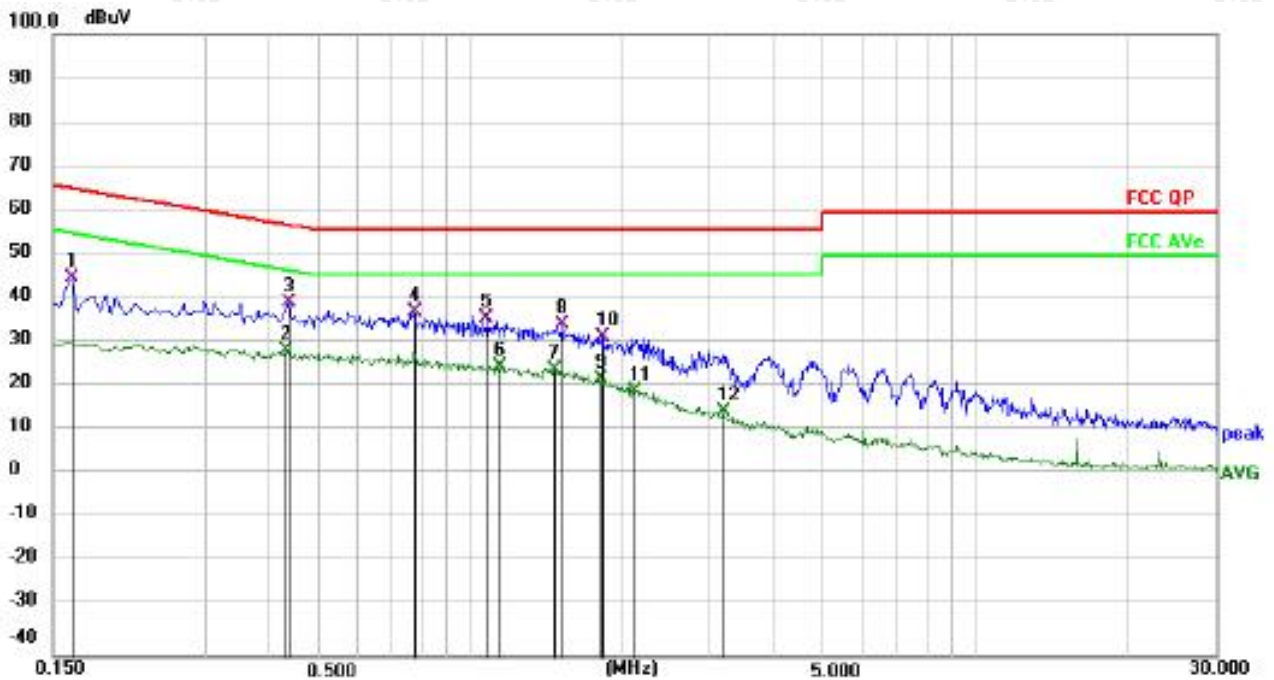

No.	Frequency (MHz)	Reading (dBuV)	Factor (dB)	Level (dBuV)	Limit (dBuV)	Margin (dB)	Detector	P/F
1	0.1635	28.38	16.68	45.06	65.28	-20.22	QP	P
2	0.4334	12.15	16.69	28.84	47.19	-18.35	AVG	P
3 *	0.4380	22.79	16.69	39.48	57.10	-17.62	QP	P
4	0.7755	21.01	16.65	37.66	56.00	-18.34	QP	P
5	1.0859	19.36	16.61	35.97	56.00	-20.03	QP	P
6	1.1490	8.76	16.60	25.36	46.00	-20.64	AVG	P
7	1.4775	8.06	16.55	24.61	46.00	-21.39	AVG	P
8	1.5315	18.04	16.55	34.59	56.00	-21.41	QP	P
9	1.8105	5.82	16.51	22.33	46.00	-23.67	AVG	P
10	1.8375	15.26	16.51	31.77	56.00	-24.23	QP	P
11	2.1255	3.36	16.47	19.83	46.00	-26.17	AVG	P
12	3.1785	-1.34	16.32	14.98	46.00	-31.02	AVG	P

Note:1).Level (dBuV)= Reading (dBuV)+ Factor (dB)

2). Factor (dB)=insertion loss of LISN (dB) + Cable loss (dB)

3). Margin(dB) = Limit (dBuV) - Level (dBuV)

Power supply:	DC 5V from Adapter AC 120V/60Hz	Polarization	N
---------------	------------------------------------	--------------	---

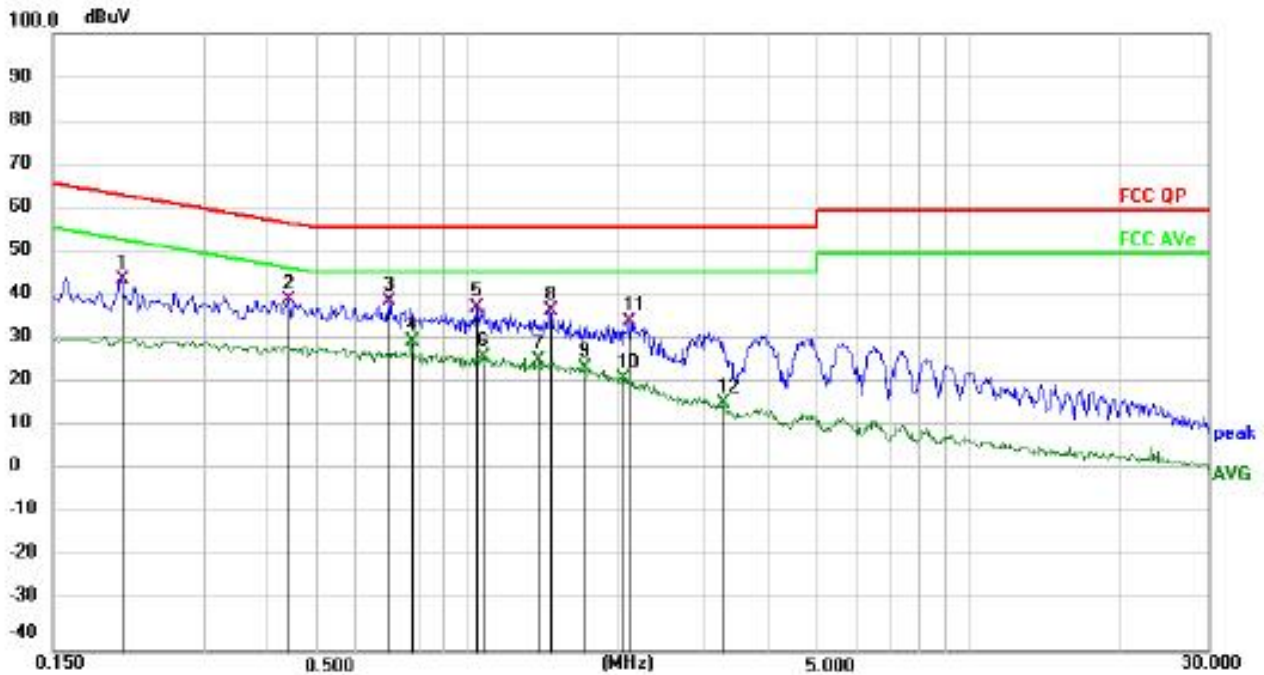

No.	Frequency (MHz)	Reading (dBuV)	Factor (dB)	Level (dBuV)	Limit (dBuV)	Margin (dB)	Detector	P/F
1	0.2040	26.56	17.53	44.09	63.45	-19.36	QP	P
2	0.4425	22.14	17.52	39.66	57.01	-17.35	QP	P
3	0.7035	21.75	17.51	39.26	56.00	-16.74	QP	P
4 *	0.7755	12.60	17.51	30.11	46.00	-15.89	AVG	P
5	1.0500	20.54	17.50	38.04	56.00	-17.96	QP	P
6	1.0859	9.27	17.50	26.77	46.00	-19.23	AVG	P
7	1.4010	8.62	17.49	26.11	46.00	-19.89	AVG	P
8	1.4640	19.60	17.49	37.09	56.00	-18.91	QP	P
9	1.7250	6.72	17.49	24.21	46.00	-21.79	AVG	P
10	2.0490	4.19	17.47	21.66	46.00	-24.34	AVG	P
11	2.1075	17.23	17.47	34.70	56.00	-21.30	QP	P
12	3.2415	-1.10	17.43	16.33	46.00	-29.67	AVG	P

Note:1).Level (dBuV)= Reading (dBuV)+ Factor (dB)

2). Factor (dB)=insertion loss of LISN (dB) + Cable loss (dB)

3). Margin(dB) = Limit (dBuV) - Level (dBuV)

4.2 Radiated Emissions and Band Edge

TEST CONFIGURATION

Frequency range 9 KHz – 30MHz

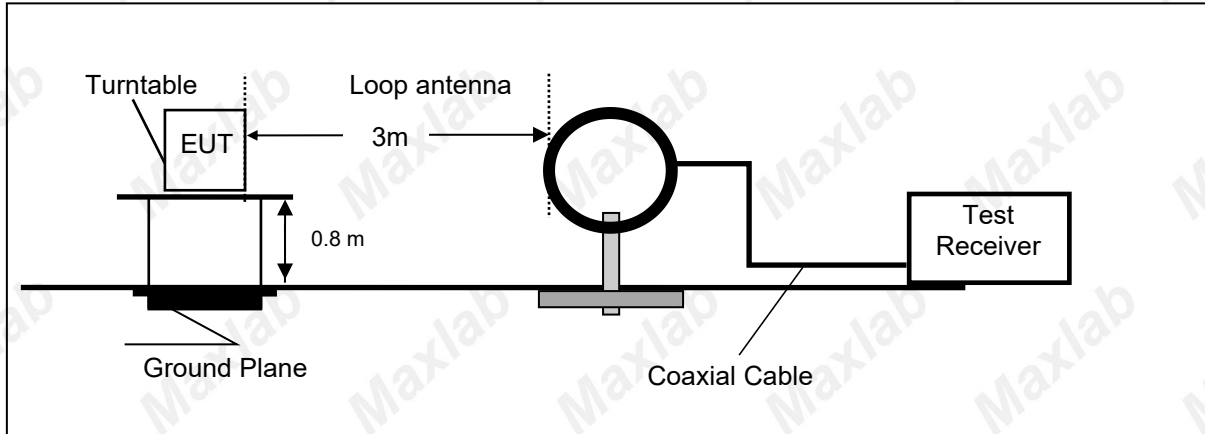

Frequency range 30MHz – 1000MHz

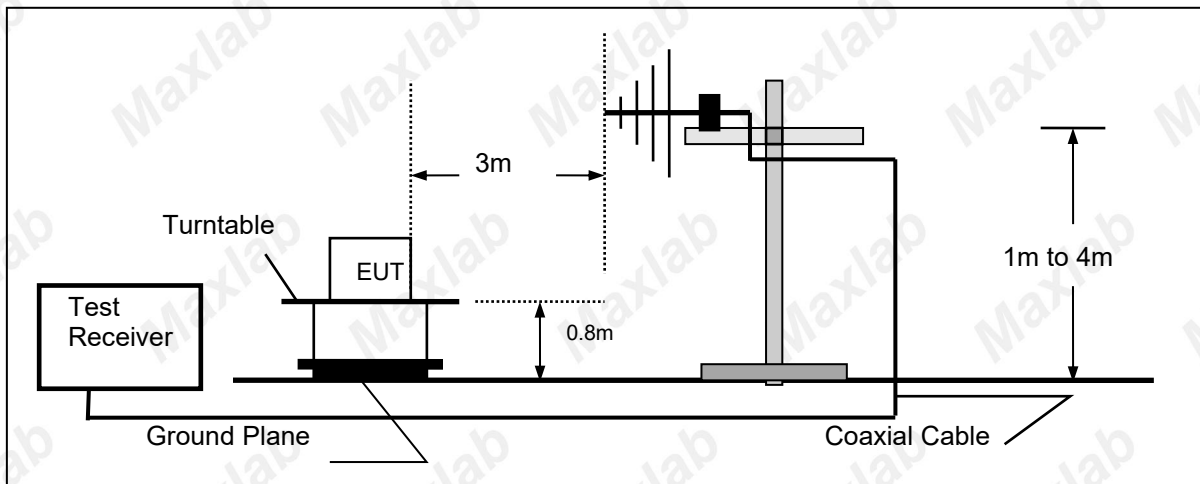

Frequency range above 1GHz-25GHz

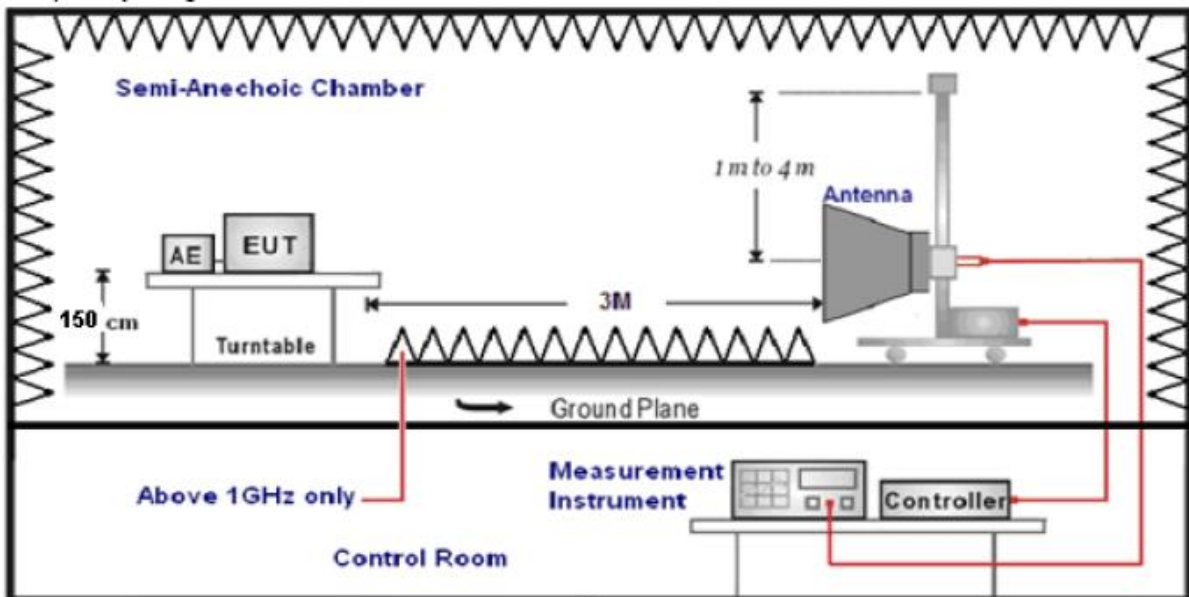

TEST PROCEDURE

1. The EUT was placed on a turn table which is 0.8m above ground plane when testing frequency range 9 KHz –1GHz;the EUT was placed on a turn table which is 1.5m above ground plane when testing frequency range 1GHz – 25GHz.
2. Maximum procedure was performed by raising the receiving antenna from 1m to 4m and rotating the turn table from 0°C to 360°C to acquire the highest emissions from EUT.
3. And also, each emission was to be maximized by changing the polarization of receiving antenna both horizontal and vertical.
4. Repeat above procedures until all frequency measurements have been completed.
5. Radiated emission test frequency band from 9KHz to 25GHz.
6. The distance between test antenna and EUT as following table states:

Test Frequency range	Test Antenna Type	Test Distance
9KHz-30MHz	Active Loop Antenna	3
30MHz-1GHz	Ultra-Broadband Antenna	3
1GHz-18GHz	Double Ridged Horn Antenna	3
18GHz-25GHz	Horn Antenna	1

7. Setting test receiver/spectrum as following table states:

Test Frequency range	Test Receiver/Spectrum Setting	Detector
9KHz-150KHz	RBW=200Hz/VBW=3KHz, Sweep time=Auto	QP
150KHz-30MHz	RBW=9KHz/VBW=100KHz, Sweep time=Auto	QP
30MHz-1GHz	RBW=120KHz/VBW=1000KHz, Sweep time=Auto	QP
1GHz-40GHz	Peak Value: RBW=1MHz/VBW=3MHz, Sweep time=Auto Average Value: RBW=1MHz/VBW=10Hz, Sweep time=Auto	Peak

Field Strength Calculation

The field strength is calculated by adding the Antenna Factor and Cable Factor and subtracting the Amplifier Gain and Duty Cycle Correction Factor(if any) from the measured reading. The basic equation with a sample calculation is as follows:

FS = RA + AF + CL - AG

Where FS = Field Strength	CL = Cable Attenuation Factor (Cable Loss)
RA = Reading Amplitude	AG = Amplifier Gain
AF = Antenna Factor	

Transd=AF +CL-AG

RADIATION LIMIT

For intentional device, according to § 15.209(a), the general requirement of field strength of radiated emission from intentional radiators at a distance of 3 meters shall not exceed the following table. According to § 15.247(d), in any 100kHz bandwidth outside the frequency band in which the EUT is operating, the radio frequency power that is produced by the intentional radiator shall be at least 20dB below that in the100kHz bandwidth within the band that contains the highest level of desired power.

The pre-test have done for the EUT in three axes and found the worst emission at position shown in test setup photos.

Frequency (MHz)	Distance (Meters)	Radiated (dBµV/m)	Radiated (µV/m)
0.009-0.49	3	20log(2400/F(KHz))+40log(300/3)	2400/F(KHz)
0.49-1.705	3	20log(24000/F(KHz))+ 40log(30/3)	24000/F(KHz)
1.705-30	3	20log(30)+ 40log(30/3)	30
30-88	3	40.0	100
88-216	3	43.5	150
216-960	3	46.0	200
Above 960	3	54.0	500

TEST RESULTS

Remark:

1. This test was performed with EUT in X, Y, Z position and the worse case was found when EUT in X position.
2. BLE 1Mbps were tested at Low, Middle, and High channel and recorded worst mode at BLE 1Mbps.
3. Radiated emission test from 9 KHz to 10th harmonic of fundamental was verified, and no emission found except system noise floor in 9 KHz to 30MHz and not recorded in this report.

For 30MHz-1GHz

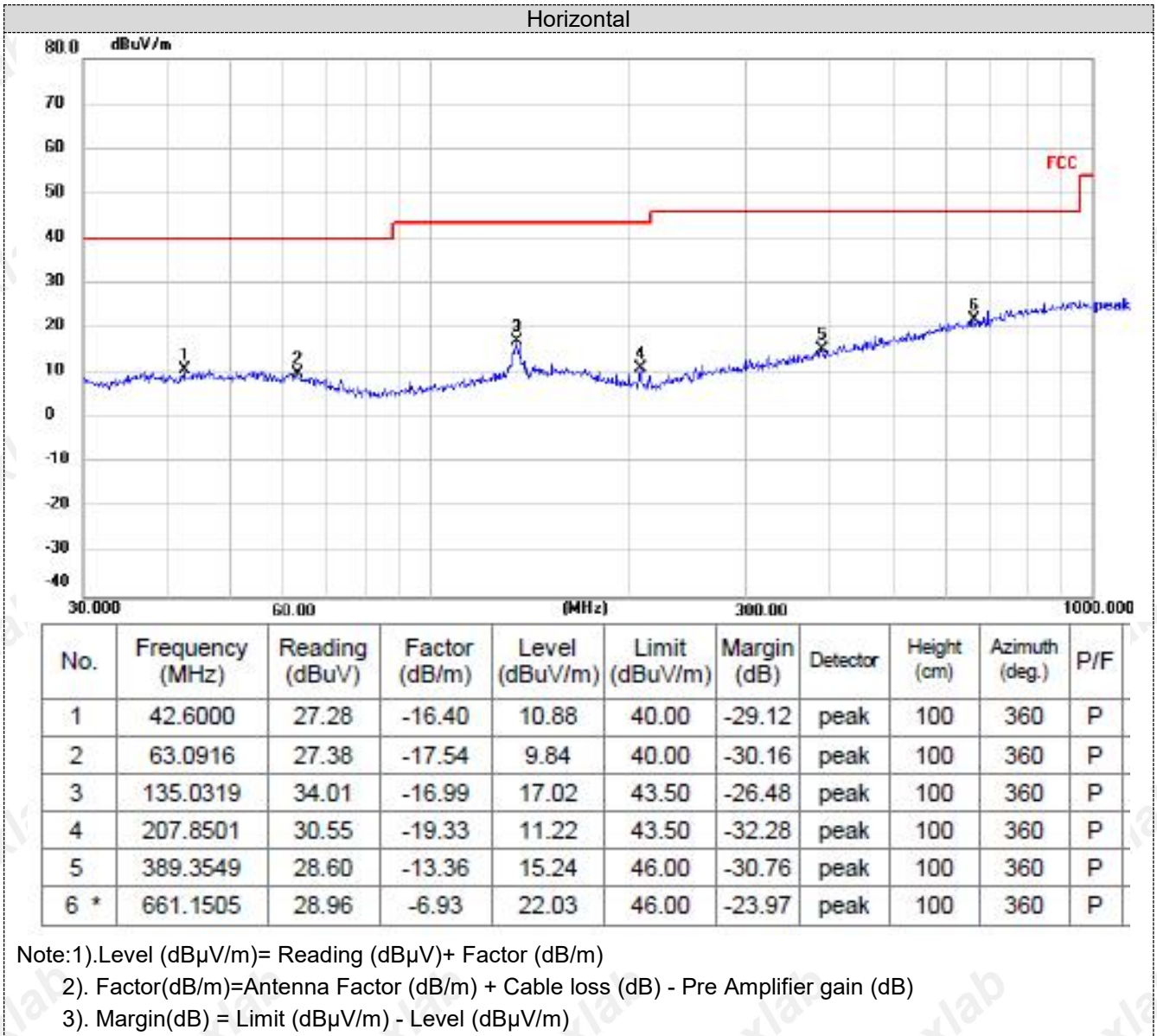

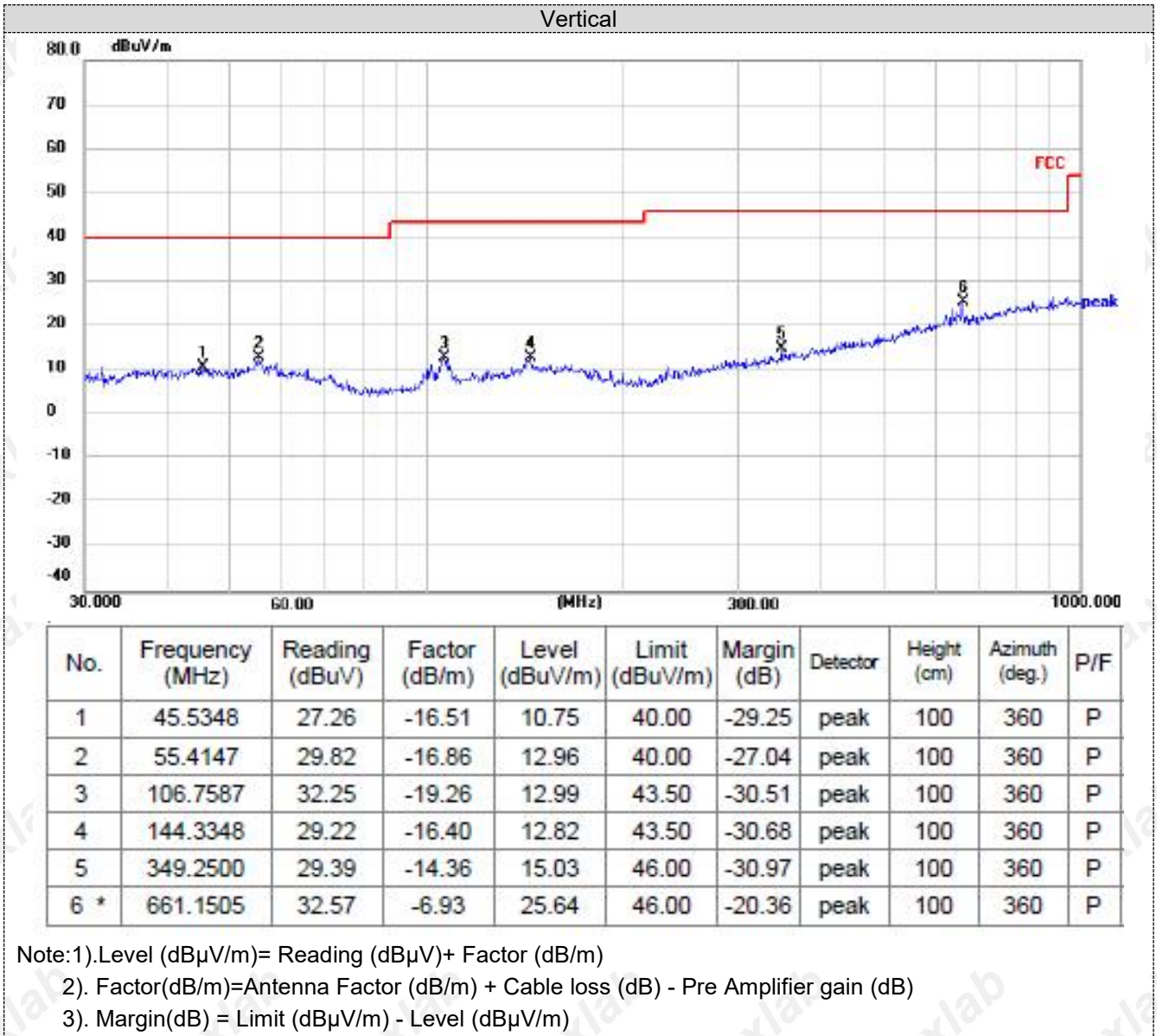

GFSK (above 1GHz)

Frequency(MHz):			2402		Polarity:		HORIZONTAL		
Frequency (MHz)	Emission Level (dBuV/m)		Limit (dBuV/m)	Margin (dB)	Raw Value (dBuV)	Antenna Factor (dB/m)	Cable Factor (dB)	Pre-amplifier (dB)	Correction Factor (dB/m)
4804.00	56.06	PK	74	17.94	60.42	32.40	5.11	41.87	-4.36
4804.00	45.98	AV	54	8.02	50.34	32.40	5.11	41.87	-4.36
7206.00	54.83	PK	74	19.17	55.46	36.58	6.43	43.64	-0.63
7206.00	45.23	AV	54	8.77	45.86	36.58	6.43	43.64	-0.63

Frequency(MHz):			2402		Polarity:		VERTICAL		
Frequency (MHz)	Emission Level (dBuV/m)		Limit (dBuV/m)	Margin (dB)	Raw Value (dBuV)	Antenna Factor (dB/m)	Cable Factor (dB)	Pre-amplifier (dB)	Correction Factor (dB/m)
4804.00	56.38	PK	74	17.62	60.74	32.40	5.11	41.87	-4.36
4804.00	45.89	AV	54	8.11	50.25	32.40	5.11	41.87	-4.36
7206.00	54.53	PK	74	19.47	55.16	36.58	6.43	43.64	-0.63
7206.00	45.02	AV	54	8.98	45.65	36.58	6.43	43.64	-0.63

Frequency(MHz):			2440		Polarity:		HORIZONTAL		
Frequency (MHz)	Emission Level (dBuV/m)		Limit (dBuV/m)	Margin (dB)	Raw Value (dBuV)	Antenna Factor (dB/m)	Cable Factor (dB)	Pre-amplifier (dB)	Correction Factor (dB/m)
4880.00	56.73	PK	74	17.27	60.68	32.56	5.34	41.85	-3.95
4880.00	46.54	AV	54	7.46	50.49	32.56	5.34	41.85	-3.95
7320.00	55.29	PK	74	18.71	55.65	36.54	6.81	43.71	-0.36
7320.00	45.16	AV	54	8.84	45.52	36.54	6.81	43.71	-0.36

Frequency(MHz):			2440		Polarity:		VERTICAL		
Frequency (MHz)	Emission Level (dBuV/m)		Limit (dBuV/m)	Margin (dB)	Raw Value (dBuV)	Antenna Factor (dB/m)	Cable Factor (dB)	Pre-amplifier (dB)	Correction Factor (dB/m)
4880.00	56.57	PK	74	17.43	60.52	32.56	5.34	41.85	-3.95
4880.00	46.39	AV	54	7.61	50.34	32.56	5.34	41.85	-3.95
7320.00	55.09	PK	74	18.91	55.45	36.54	6.81	43.71	-0.36
7320.00	45.29	AV	54	8.71	45.65	36.54	6.81	43.71	-0.36

Frequency(MHz):			2480		Polarity:		HORIZONTAL		
Frequency (MHz)	Emission Level (dBuV/m)		Limit (dBuV/m)	Margin (dB)	Raw Value (dBuV)	Antenna Factor (dB/m)	Cable Factor (dB)	Pre-amplifier (dB)	Correction Factor (dB/m)
4960.00	57.06	PK	74	16.94	60.52	32.73	5.64	41.83	-3.46
4960.00	46.80	AV	54	7.20	50.26	32.73	5.64	41.83	-3.46
7440.00	55.36	PK	74	18.64	55.42	36.50	7.23	43.79	-0.06
7440.00	45.20	AV	54	8.80	45.26	36.50	7.23	43.79	-0.06

Frequency(MHz):			2480		Polarity:		VERTICAL		
Frequency (MHz)	Emission Level (dBuV/m)		Limit (dBuV/m)	Margin (dB)	Raw Value (dBuV)	Antenna Factor (dB/m)	Cable Factor (dB)	Pre-amplifier (dB)	Correction Factor (dB/m)
4960.00	57.06	PK	74	16.94	60.52	32.73	5.64	41.83	-3.46
4960.00	46.96	AV	54	7.04	50.42	32.73	5.64	41.83	-3.46
7440.00	55.20	PK	74	18.80	55.26	36.50	7.23	43.79	-0.06
7440.00	45.28	AV	54	8.72	45.34	36.50	7.23	43.79	-0.06

REMARKS:

1. Emission level (dBuV/m) = Raw Value (dBuV) + Correction Factor (dB/m)
2. Correction Factor (dB/m) = Antenna Factor (dB/m) + Cable Factor (dB) - Pre-amplifier
3. Margin value = Limit value - Emission level.
4. -- Mean the PK detector measured value is below average limit.
5. The other emission levels were very low against the limit.

Results of Band Edges Test (Radiated)

GFSK

Test Frequency(MHz):			Lowest channel		Polarity:		HORIZONTAL		
Frequency (MHz)	Emission Level (dBuV/m)		Limit (dBuV/m)	Margin (dB)	Raw Value (dBuV)	Antenna Factor (dB/m)	Cable Factor (dB)	Pre-amplifier (dB)	Correction Factor (dB/m)
2310.00	50.10	PK	74	23.90	60.52	27.42	4.31	42.15	-10.42
2310.00	40.00	AV	54	14.00	50.42	27.42	4.31	42.15	-10.42
2390.00	47.97	PK	74	26.03	58.26	27.55	4.35	42.19	-10.29
2390.00	38.34	AV	54	15.66	48.63	27.55	4.35	42.19	-10.29
2400.00	46.07	PK	74	27.93	56.26	27.70	4.39	42.28	-10.19
2400.00	35.67	AV	54	18.33	45.86	27.70	4.39	42.28	-10.19

Test Frequency(MHz):			Lowest channel		Polarity:		VERTICAL		
Frequency (MHz)	Emission Level (dBuV/m)		Limit (dBuV/m)	Margin (dB)	Raw Value (dBuV)	Antenna Factor (dB/m)	Cable Factor (dB)	Pre-amplifier (dB)	Correction Factor (dB/m)
2310.00	47.84	PK	74	26.16	58.26	27.42	4.31	42.15	-10.42
2310.00	37.92	AV	54	16.08	48.34	27.42	4.31	42.15	-10.42
2390.00	46.23	PK	74	27.77	56.52	27.55	4.35	42.19	-10.29
2390.00	35.86	AV	54	18.14	46.15	27.55	4.35	42.19	-10.29
2400.00	43.06	PK	74	30.94	53.25	27.70	4.39	42.28	-10.19
2400.00	33.02	AV	54	20.98	43.21	27.70	4.39	42.28	-10.19

Test Frequency(MHz):			Highest channel		Polarity:		HORIZONTAL		
Frequency (MHz)	Emission Level (dBuV/m)		Limit (dBuV/m)	Margin (dB)	Raw Value (dBuV)	Antenna Factor (dB/m)	Cable Factor (dB)	Pre-amplifier (dB)	Correction Factor (dB/m)
2483.50	44.82	PK	74	29.18	55.45	27.55	4.38	42.56	-10.63
2483.50	34.63	AV	54	19.37	45.26	27.55	4.38	42.56	-10.63
2500.00	42.39	PK	74	31.61	53.12	27.69	4.46	42.88	-10.73
2500.00	32.51	AV	54	21.49	43.24	27.69	4.46	42.88	-10.73

Test Frequency(MHz):			Highest channel		Polarity:		VERTICAL		
Frequency (MHz)	Emission Level (dBuV/m)		Limit (dBuV/m)	Margin (dB)	Raw Value (dBuV)	Antenna Factor (dB/m)	Cable Factor (dB)	Pre-amplifier (dB)	Correction Factor (dB/m)
2483.50	39.61	PK	74	34.39	50.24	27.55	4.38	42.56	-10.63
2483.50	29.53	AV	54	24.47	40.16	27.55	4.38	42.56	-10.63
2500.00	37.90	PK	74	36.10	48.63	27.69	4.46	42.88	-10.73
2500.00	27.51	AV	54	26.49	38.24	27.69	4.46	42.88	-10.73

REMARKS:

1. Emission level (dBuV/m) = Raw Value (dBuV) + Correction Factor (dB/m)
2. Correction Factor (dB/m) = Antenna Factor (dB/m) + Cable Factor (dB) - Pre-amplifier
3. Margin value = Limit value - Emission level.
4. -- Mean the PK detector measured value is below average limit.
5. The other emission levels were very low against the limit.

4.3 Maximum Peak Output Power

Limit

The Maximum Peak Output Power Measurement is 30dBm.

Test Procedure

Remove the antenna from the EUT and then connect a low loss RF cable from the antenna port to the power sensor.

Test Configuration



Test Results

Type	Channel	Output power (dBm)	Limit (dBm)	Result
GFSK 1Mbps	00	1.241	30.00	Pass
	19	1.056		
	39	0.968		

Note: 1.The test results including the cable lose.

4.4 Power Spectral Density

Limit

For digitally modulated systems, the power spectral density conducted from the intentional radiator to the antenna shall not be greater than 8 dBm in any 3 kHz band during any time interval of continuous transmission.

Test Procedure

1. Use this procedure when the maximum peak conducted output power in the fundamental emission is used to demonstrate compliance.
2. Set the RBW \geq 3 kHz.
3. Set the VBW \geq 3 \times RBW.
4. Set the span to 1.5 times the DTS channel bandwidth.
5. Detector = peak.
6. Sweep time = auto couple.
7. Trace mode = max hold.
8. Allow trace to fully stabilize.
9. Use the peak marker function to determine the maximum power level.
10. If measured value exceeds limit, reduce RBW (no less than 3 kHz) and repeat.
11. The resulting peak PSD level must be 8dBm.

Test Configuration



Test Results

Type	Channel	Power Spectral Density (dBm/3KHz)	Limit (dBm/3KHz)	Result
GFSK 1Mbps	00	-18.856	8.00	Pass
	19	-18.736		
	39	-19.017		

Test plot as follows:

BLE GFSK 1Mbps

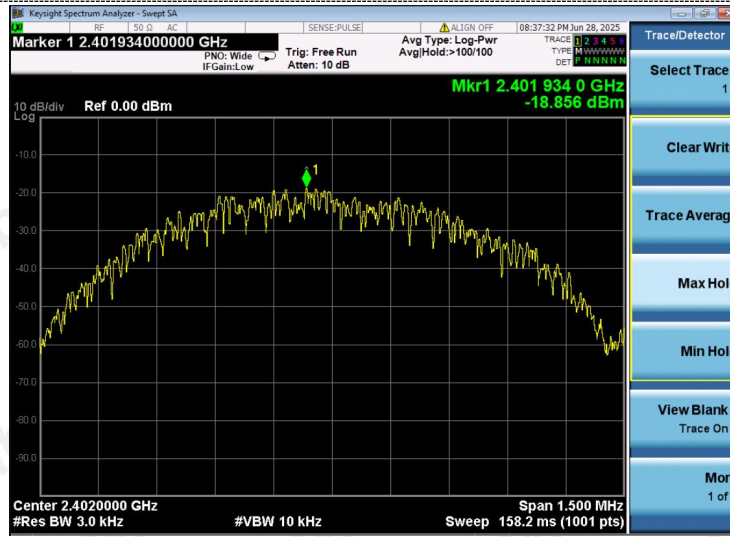

CH00

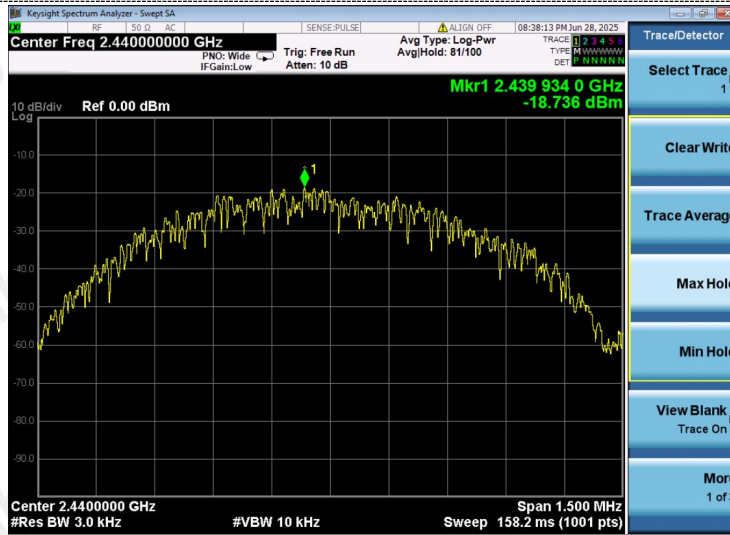

CH19

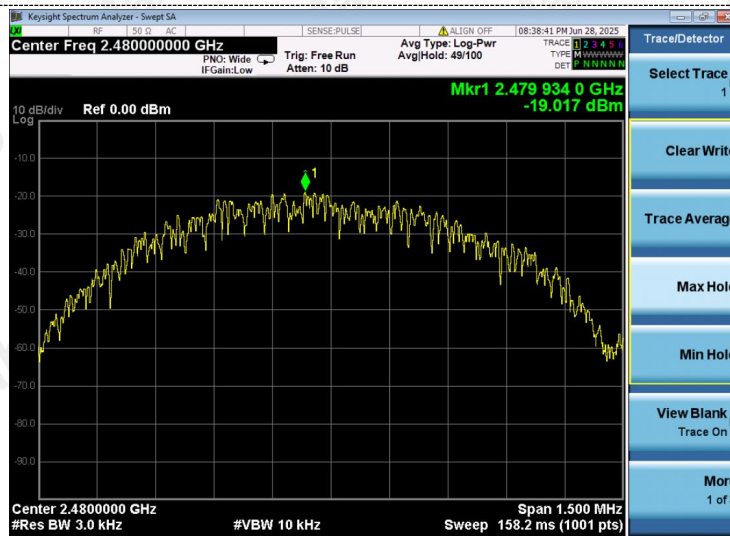

CH39

4.5 6dB Bandwidth

Limit

For digital modulation systems, the minimum 6 dB bandwidth shall be at least 500 kHz

Test Procedure

The transmitter output was connected to the spectrum analyzer through an attenuator. The bandwidth of the fundamental frequency was measured by spectrum analyzer with 100 KHz RBW and 300 KHz VBW. The 6dB bandwidth is defined as the total spectrum the power of which is higher than peak power minus 6dB.

Test Configuration



Test Results

Type	Channel	6dB Bandwidth (MHz)	Limit (KHz)	Result
GFSK 1Mbps	00	0.662	≥500	Pass
	19	0.662		
	39	0.663		

Test plot as follows:

BLE GFSK 1Mbps

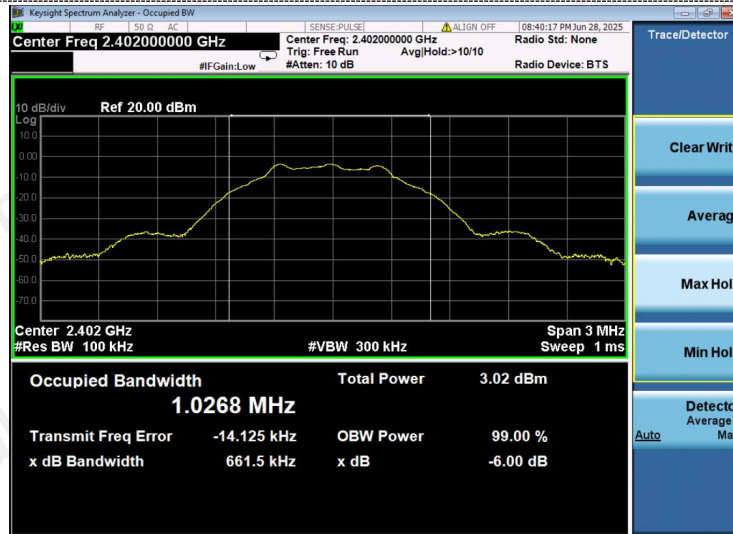

CH00

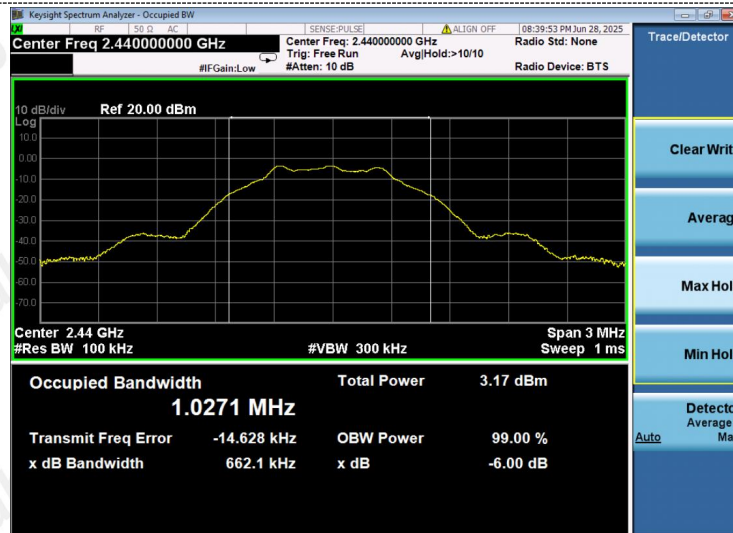

CH19

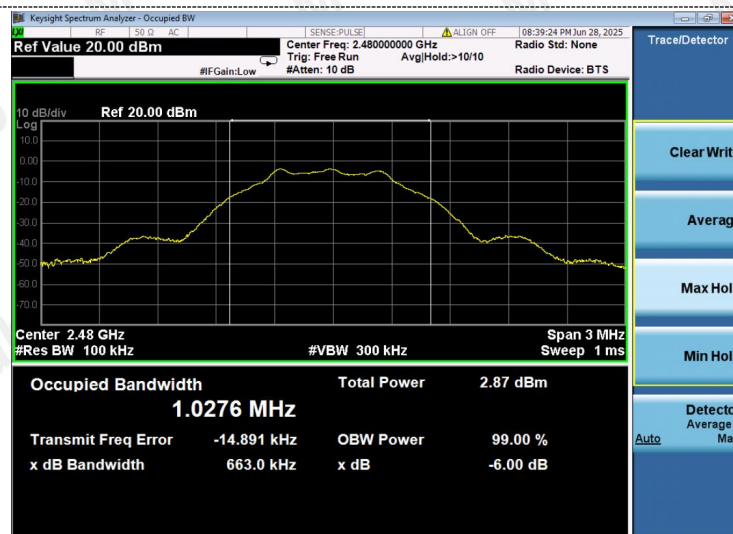

CH39

4.6 Out-of-band Emissions

Limit

In any 100 kHz bandwidth outside the frequency band in which the spread spectrum or digitally modulated intentional radiator is operating, the radio frequency power that is produced by the intentional radiator shall be at least 20 dB below that in the 100 kHz bandwidth within the band that contains the highest level of the desired power, based on either an RF conducted or a radiated measurement, provided the transmitter demonstrates compliance with the peak conducted power limits. If the transmitter complies with the conducted power limits based on the use of RMS averaging over a time interval, as permitted under paragraph (b)(3) of this section, the attenuation required under this paragraph shall be 30 dB instead of 20 dB. Attenuation below the general limits specified in §15.209(a) is not required.

Test Procedure

Connect the transmitter output to spectrum analyzer using a low loss RF cable, and set the spectrum analyzer to RBW=100 kHz, VBW= 300 kHz, peak detector, and max hold. Measurements utilizing these settings are made of the in-band reference level, bandedge and out-of-band emissions.

Test Configuration



Test Results

Remark: The measurement frequency range is from 30MHz to the 10th harmonic of the fundamental frequency. The lowest, middle and highest channels are tested to verify the spurious emissions and bandedge measurement data.

Test plot as follows:

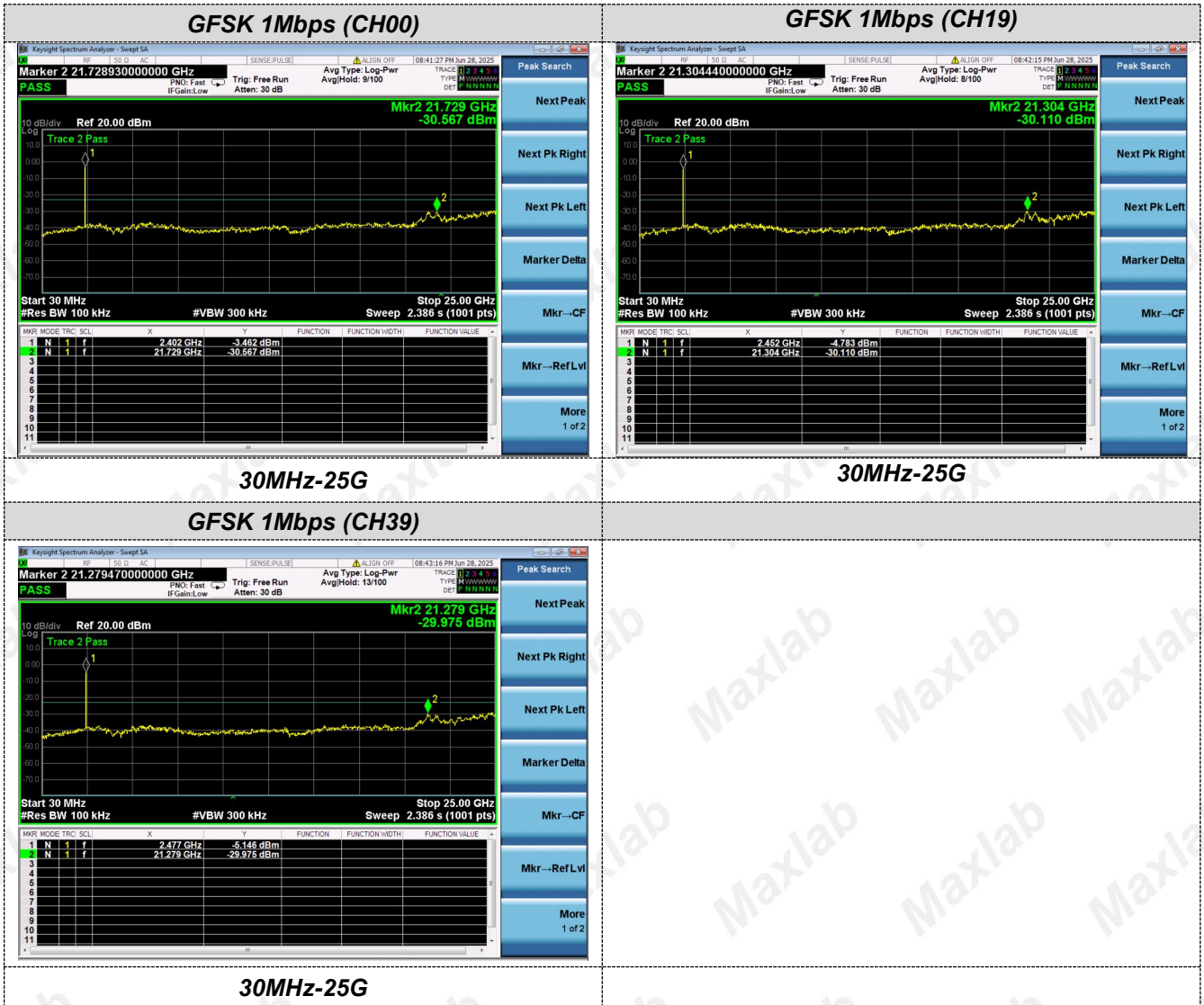

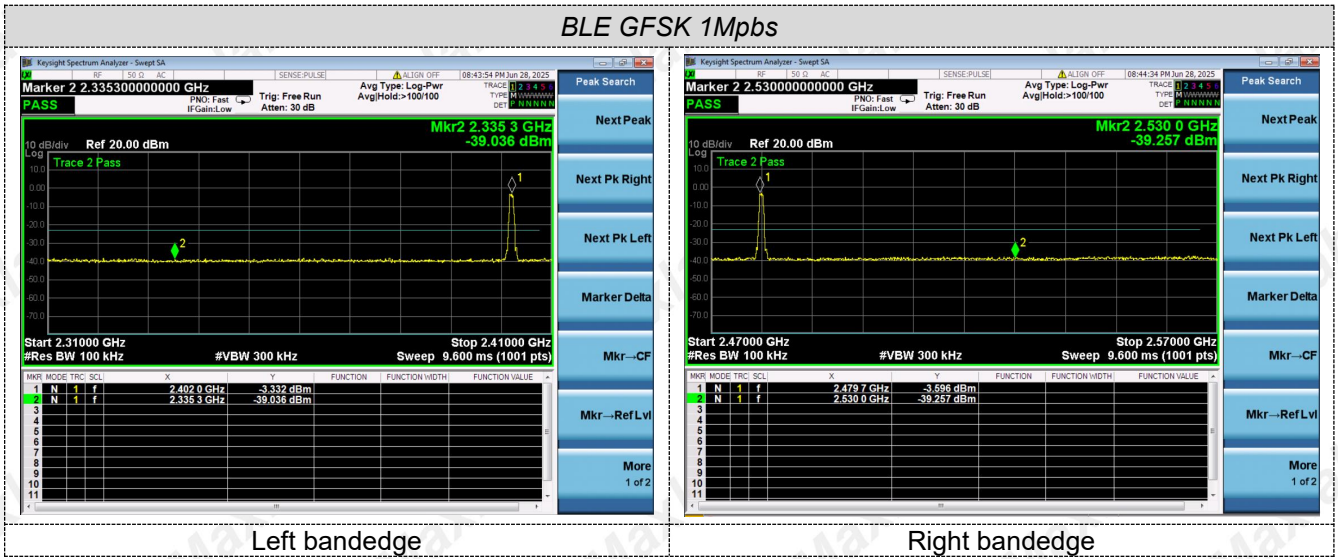

4.7 Antenna Requirement

Standard Applicable

For intentional device, according to FCC 47 CFR Section 15.203:

An intentional radiator shall be designed to ensure that no antenna other than that furnished by the responsible party shall be used with the device. The use of a permanently attached antenna or of an antenna that uses a unique coupling to the intentional radiator, the manufacturer may design the unit so that a broken antenna can be replaced by the user, but the use of a standard antenna jack or electrical connector is prohibited

FCC CFR Title 47 Part 15 Subpart C Section 15.247(c) (1) (I):

(i) Systems operating in the 2400-2483.5 MHz band that is used exclusively for fixed. Point-to-point operations may employ transmitting antennas with directional gain greater than 6dBi provided the maximum conducted output power of the intentional radiator is reduced by 1 dB for every 3 dB that the directional gain of the antenna exceeds 6dBi.

Antenna Connected Construction

The maximum gain of antenna was -0.58 dBi .

Remark: The antenna gain is provided by the customer, if the data provided by the customer is not accurate, MAXLAB Testing Co.,Ltd. does not assume any responsibility.

5 Test Setup Photos of the EUT

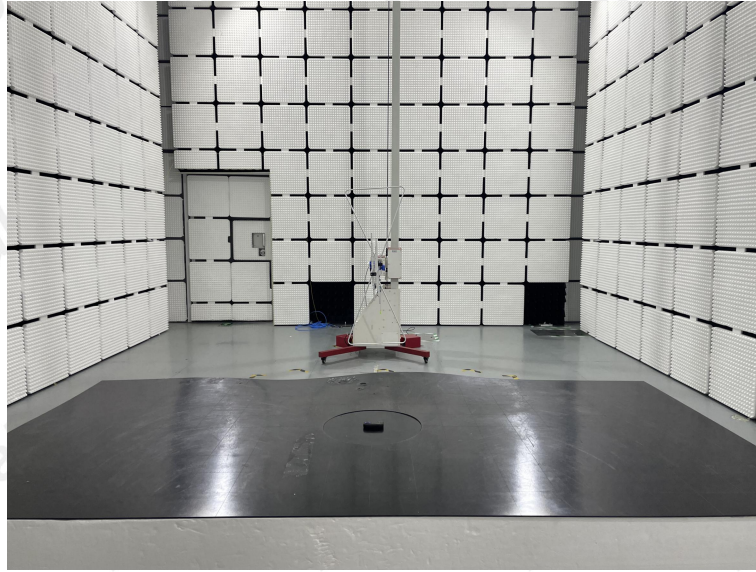

6 Photos of the EUT

Reference to the report ANNEX A of external photos and ANNEX B of internal photos.

***** End of Report *****