



## FCC TEST REPORT

**FCC ID: 2BCNM-NY-08**

On Behalf of

Shenzhen Hewei Technology Co.,Ltd

Laptop

Model No.: NY-08, NY-01, NY-02, NY-03, NY-04, NY-05, NY-09, NY-10, NY-11, NY-12, NY-13, NY-14, NY-15, NY-16, NY-17, NY-18, NY-19, NY-20, NY-21, NY-22, NY-23, NY-24, NY-25, NY-26, NY-27, NY-28, NY-29, NY-30, NY-31, NY-32, NY-33, NY-34, NY-35, NY-36, NY-37, NY-38, NY-39, NY-40, NY-41, NY-42, NY-43, NY-44, NY-45, NY-46, NY-27, NY-48, NY-49, NY-50, AM01, AM02, LAITMIN G5, MagBook, TigBook

Prepared for : Shenzhen Hewei Technology Co.,Ltd  
705,706, Factory Building 3, Shanglilang Zhichuangyuan, No.61  
Address : Pingji Avenue, Shanglilang Community, Nanwan Street, Longgang District, Shenzhen, China

Prepared By : Shenzhen PSI Testing Co., Ltd.  
Address : 1-2/F., Building 5, Yudafu Industrial Park, No.10, Xingye West Road, Shajing Subdistrict, Bao'an District, Shenzhen, Guangdong, China

Report Number : psi2504229-C01-R07  
Date of Receipt : April 29, 2025  
Date of Test : April 29, 2025 – May 30, 2025  
Date of Report : May 30, 2025  
Version Number : V0

## TABLE OF CONTENTS

<u>Description</u>	<u>Page</u>
<b>1. Summary Of Standards And Results.....</b>	<b>6</b>
1.1. Description of Standards and Results .....	6
<b>2. General Information.....</b>	<b>7</b>
2.1. Description of Device (EUT) .....	7
2.2. Accessories of Device (EUT) .....	8
2.3. Tested Supporting System Details .....	8
2.4. Block Diagram of connection between EUT and simulators .....	8
2.5. Test Mode Description .....	8
2.6. Software test version and power setting information .....	9
2.7. Test Conditions .....	10
2.8. Test Facility.....	10
2.9. Measurement Uncertainty .....	10
2.10. Test Equipment List .....	11
<b>3. Maximum Peak Output Power .....</b>	<b>12</b>
3.1. Limit .....	12
3.2. Test Procedure .....	12
3.3. Test Setup.....	12
3.4. Test Result.....	12
<b>4. Bandwidth .....</b>	<b>13</b>
4.1. Limit .....	13
4.2. Test Procedure .....	13
4.3. Test Result.....	13
<b>5. Carrier Frequency Separation .....</b>	<b>24</b>
5.1. Limit .....	24
5.2. Test Procedure .....	24
5.3. Test Result.....	24
<b>6. Number Of Hopping Channel .....</b>	<b>26</b>
6.1. Limit .....	26
6.2. Test Procedure .....	26
6.3. Test Result.....	26
<b>7. Dwell Time .....</b>	<b>28</b>
7.1. Test limit.....	28
7.2. Test Procedure .....	28
7.3. Test Result.....	28
<b>8. Out-of-band Emissions .....</b>	<b>38</b>
8.1. Test Limits.....	38
8.2. Test Procedure .....	38
8.3. Test Setup.....	38
8.4. Test Results .....	38
<b>9. Radiated Emissions.....</b>	<b>62</b>
9.1. Limit .....	62
9.2. Block Diagram of Test setup.....	65

9.3. Test Procedure .....	66
9.4. Test Results .....	66
<b>10. Band Edge Test.....</b>	<b>74</b>
10.1. Block Diagram of Test Setup .....	74
10.2. Test Limit .....	74
10.3. Test Procedure .....	74
10.4. Test Results .....	75
<b>11. Power Line Conducted Emissions.....</b>	<b>78</b>
11.1. Block Diagram of Test Setup .....	78
11.2. Limit .....	78
11.3. Test Procedure .....	78
11.4. Test Results .....	79
<b>12. Frequency stability .....</b>	<b>82</b>
12.1. Test limit.....	82
12.2. Test Procedure .....	82
12.3. Test Setup.....	82
12.4. Test Results .....	82
<b>13. Antenna Requirements .....</b>	<b>83</b>
13.1. Limit.....	83
13.2. Result .....	83
<b>14. Photos of test setup .....</b>	<b>84</b>
<b>15. Photos of EUT .....</b>	<b>84</b>

### TEST REPORT DECLARATION

Applicant : Shenzhen Hewei Technology Co.,Ltd  
 Address : 705,706, Factory Building 3, Shanglilang Zhichuangyuan, No.61 Pingji Avenue, Shanglilang Community, Nanwan Street, Longgang District, Shenzhen, China  
 Manufacturer : Shenzhen Jiuzhou Yunhai Technology Co.  
 Address : 701, Factory Building 3, Shanglilang Zhichuangyuan, No.61, Pingji Avenue, Shanglilang Community, Nanwan Street, Longgang District, Shenzhen, China.  
 EUT Description : Laptop

(A) Model No. : NY-08, NY-01, NY-02, NY-03, NY-04, NY-05, NY-09, NY-10, NY-11, NY-12, NY-13, NY-14, NY-15, NY-16, NY-17, NY-18, NY-19, NY-20, NY-21, NY-22, NY-23, NY-24, NY-25, NY-26, NY-27, NY-28, NY-29, NY-30, NY-31, NY-32, NY-33, NY-34, NY-35, NY-36, NY-37, NY-38, NY-39, NY-40, NY-41, NY-42, NY-43, NY-44, NY-45, NY-46, NY-27, NY-48, NY-49, NY-50, AM01, AM02, LAITMIN G5, MagBook, TigBook  
 (B) Trademark : N/A

Measurement Standard Used:

**FCC Rules and Regulations Part 15 Subpart C Section 15.247**  
**ANSI C63.10:2013**  
**Test Result: PASS**

The device described above is tested by Shenzhen PSI Testing Co., Ltd. to determine the maximum emission levels emanating from the device and the severe levels of the device can endure and its performance criterion. The test results are contained in this test report and Shenzhen PSI Testing Co., Ltd. is assumed full responsibility for the accuracy and completeness of test. Also, this report shows that the EUT is technically compliant with the FCC Part 15C requirements.

This report applies to above tested sample only. This report shall not be reproduced in parts without written approval of Shenzhen PSI Testing Co., Ltd.

Tested by (name + signature).....: Jensen Wang  
 Test Engineer *Jensen Wang*

Approved by (name + signature).....: Simple Guan  
 Project Manager *Simple Guan*

Date of issue.....: May 30, 2025

## Revision History

Revision	Issue Date	Revisions	Revised By
V0	May 30, 2025	Initial released Issue	Jensen Wang



# 1. Summary Of Standards And Results

## 1.1. Description of Standards and Results

The EUT have been tested according to the applicable standards as referenced below:

Test Item	Standards Paragraph	Result
Maximum Peak Output Power	FCC Part 15: 15.247(b)(1), RSS-247(5.4 b), ANSI C63.10 :2013	P
Bandwidth	FCC Part 15: 15.215, RSS-247(5.1 a), ANSI C63.10 :2013	P
Carrier Frequency Separation	FCC Part 15: 15.247(a)(1), RSS-247(5.1 b), ANSI C63.10 :2013	P
Number Of Hopping Channel	FCC Part 15: 15.247(a)(1), RSS-247(5.1 d),ANSI C63.10 :2013	P
Dwell Time	FCC Part 15: 15.247(a)(1), RSS-247(5.1 d),ANSI C63.10 :2013	P
Radiated Spurious Emission	FCC Part 15: 15.209, FCC Part 15: 15.247(d), RSS-Gen(8.9), RSS-247(5.5), ANSI C63.10 :2013	P
Out-of-band Emissions	FCC Part 15: 15.247(d), RSS-Gen(8.9), RSS-247(5.5), ANSI C63.10 :2013	P
Radiated Band Edge Emission	FCC Part 15: 15.247(d), RSS-Gen(6.13), RSS-247(5.5), ANSI C63.10 :2013	P
Power Line Conducted Emissions	FCC Part 15: 15.207, RSS-GEN(8.8),ANSI C63.10 :2013	P
Frequency stability	RSS-GEN(6.11)	N/A
Antenna requirement	FCC Part 15: 15.203, RSS-GEN(6.8)	P
<p>Note: 1. P is an abbreviation for Pass.            2. F is an abbreviation for Fail.            3. N/A is an abbreviation for Not Applicable.            4. Conclusion determination rules of this report: Unless there are clear provisions on measurement uncertainty in the standard or customer requirements, decision by actual test data without considering measurement uncertainty.            5. Measurement method usage KDB 558074 D01 15.247 Meas Guidance v05r02.</p>		

## 2. General Information

### 2.1. Description of Device (EUT)

Product Name	:	Laptop NY-08, NY-01, NY-02, NY-03, NY-04, NY-05, NY-09, NY-10, NY-11, NY-12, NY-13, NY-14, NY-15, NY-16, NY-17, NY-18, NY-19, NY-20, NY-21, NY-22, NY-23, NY-24, NY-25, NY-26, NY-27, NY-28, NY-29, NY-30, NY-31, NY-32, NY-33, NY-34, NY-35, NY-36, NY-37, NY-38, NY-39, NY-40, NY-41, NY-42, NY-43, NY-44, NY-45, NY-46, NY-27, NY-48, NY-49, NY-50, AM01, AM02, LAITMIN G5, MagBook, TigBook
Model No.	:	
Diff	:	There is no difference except the name of the model. All tests are made with the NY-08 model.
Power supply	:	DC 12V from adapter, DC 7.7V from battery
Radio Technology	:	Bluetooth V5.0 EDR
Operation frequency	:	2402-2480MHz
Channel No.	:	79 channels
Channel Separation	:	1MHz
Modulation	:	GFSK, $\pi/4$ -DQPSK, 8DPSK
Antenna Type	:	Internal antenna, maximum gain is 2.65dBi.
PMN	:	N/A
HVIN	:	N/A
Software version	:	N/A
Hardware version/FVIN	:	N/A
Note	:	Antenna information is provided by applicant. Testing lab is not responsible for the accuracy of the information.

## 2.2. Accessories of Device (EUT)

Accessories 1 : AC ADAPTER  
 Manufacturer : Guangdong Qingliu Electronics Co.,LTD  
 Model : QL036GaN-1203000U  
 Rating : Input: 100-240V~50/60Hz 1.5A  
           Output: DC 12.0V/3.0A

Accessories 2 :  
 Manufacturer :  
 Model :  
 Rating :

## 2.3. Tested Supporting System Details

No.	Description	Manufacturer	Model	Serial Number
1	N/A	N/A	N/A	N/A
2	N/A	N/A	N/A	N/A

## 2.4. Block Diagram of connection between EUT and simulators

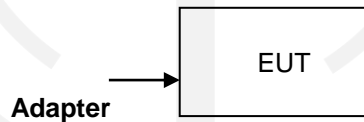

## 2.5. Test Mode Description

The test software used to control EUT work in Continuous TX mode, and select test channel, wireless mode

Tested mode, channel, and data rate information		
Mode	Channel	Frequency (MHz)
GFSK / Pi/4-DQPSK / 8DPSK Carrier Tx Mode	CH0	2402
	CH39	2441
	CH78	2480
GFSK / Pi/4-DQPSK / 8DPSK hopping on Tx Mode	CH0 to CH78	2402 to 2480
GFSK / Pi/4-DQPSK / 8DPSK hopping off Tx Mode	CH0	2402
	CH39	2441
	CH78	2480



## 2.6. Software test version and power setting information

Software testing version	cmd.exe		
Mode	The client 's preset testing software is used to control the operation of EUT in continuous transmission mode and select the testing channel, wireless mode:		
Power level setup by client			
Mode	Channel	Frequency (MHz)	Soft Set
GFSK, Pi/4-DQPSK, 8DPSK	CH0	2402	TX level is set as defaults value.
	CH39	2441	TX level is set as defaults value.
	CH78	2480	TX level is set as defaults value.



## 2.7. Test Conditions

Items	Required	Actual
Temperature range:	15-35°C	26°C
Humidity range:	25-75%	54%
Pressure range:	86-106kPa	101kPa

## 2.8. Test Facility

Shenzhen PSI Testing Co., Ltd.

1-2/F., Building 5, Yudafu Industrial Park, No.10, Xingye West Road, Shajing Subdistrict, Bao'an District, Shenzhen, Guangdong, China

September 13, 2023 File on Federal Communication Commission

Registration Number: 916281

## 2.9. Measurement Uncertainty

(95% confidence levels, k=2)

Item	Uncertainty
Uncertainty for Power point Conducted Emissions Test	2.17dB
Uncertainty for Radiation Emission test in 3m chamber (below 30MHz)	3.5dB
Uncertainty for Radiation Emission test in 3m chamber (30MHz to 1GHz)	2.74dB(Polarize: V)
	2.76dB(Polarize: H)
Uncertainty for Radiation Emission test in 3m chamber (1GHz to 18GHz)	4.29dB(Polarize: V)
	4.82dB(Polarize: H)
Uncertainty for Radiation Emission test in 3m chamber (18GHz to 40GHz)	4.31 dB(Polarize: V)
	4.30 dB(Polarize: H)
Uncertainty for radio frequency	48.24KHz
Uncertainty for conducted RF Power	0.41dB

## 2.10.Test Equipment List

Item	Equipment	Manufacturer	Model No.	Serial No.	Firmware Version	Last Cal.	Cal. Interval
1.	9*6*6 anechoic chamber	SKET	9*6*6	N/A	/	2022.12.20	3 Year
2.	Test Receiver	Rohde&Schwarz	ESCI 7	101032/003	4.42 SP3	2024.12.18	1 Year
3.	L.I.S.N.#1	Rohde&Schwarz	ENV216	102282	/	2024.12.18	1 Year
4.	L.I.S.N.#2	RFT	NNB111	13835240	/	2024.12.18	1 Year
5.	Loop Antenna	Schwarz beck	FMZB 1519B	00128	/	2025.01.02	2 Year
6.	Bilog Antenna	Schwarz beck	VULB 9168	01448	/	2025.01.02	2 Year
7.	Spectrum Analyzer	Rohde&Schwarz	FSV-40N	101648	3.70	2024.12.18	1 Year
8.	Horn Antenna	Schwarz beck	BBHA 9120 D	02706	/	2025.01.02	2 Year
9.	Amplifier	SKET	LAPA_01G1 8G-45dB	SK20220329 01	/	2024.12.18	1 Year
10.	Horn Antenna	Schwarz beck	BBHA 9170	00946	/	2024.12.31	2 Year
11.	Amplifier	SKET	LNPA_0118 G-45	SK20200108 01	/	2024.12.18	1 Year
12	RF Power Probe	Rohde&Schwarz	NRP-Z11	1138.3004.0 2-1111533-F z	/	2024.12.18	1 Year
13	RF Sensor Unit	Tachoy	TR1029-2	20220428P0 08	/	2024.12.18	1 Year
14	Spectrum Analyzer	Agilent	N9020A	MY51281067	A.14.03	2024.12.18	1 Year
15	Temp. & Humid Chamber	Auchno	9606	/	/	2024.12.18	1 Year
16	Regulated DC Power Supply	Xinouhua	ADC120V10 A	2022112516 38		2024.12.18	1 Year
For Test Software Information							
Item	Software Name	Manufacturer			Version		
RE	EZ_EMG	Farad			PSI-3A1		
CE	EZ_EMG	Farad			PSI-3A1		
RF	RTS	TACHOY			V1.0.0		

### 3. Maximum Peak Output Power

#### 3.1. Limit

Please refer FCC part 15.247 & RSS-247.

For frequency hopping systems operating in the 2400-2483.5 MHz band employing at least 75 non-overlapping hopping channels, and all frequency hopping systems in the 5725-5850 MHz band: 1 watt. For all other frequency hopping systems in the 2400-2483.5 MHz band: 0.125 watts, the e.i.r.p shall not exceed 4W

#### 3.2. Test Procedure

The transmitter output is connected to the RF Power meter. The Power meter is set to the peak power detection.

#### 3.3. Test Setup

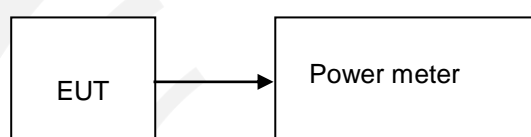

#### 3.4. Test Result

Condition	Antenna	Modulation	Frequency (MHz)	Max. Conducted Power(dBm)	Max. Conducted Power(mW)	Limit(mW)	Result
NVNT	ANT1	1-DH1	2402.00	1.44	1.39	125	Pass
NVNT	ANT1	1-DH1	2441.00	1.77	1.50	125	Pass
NVNT	ANT1	1-DH1	2480.00	<b>2.76</b>	1.89	125	Pass
NVNT	ANT1	2-DH1	2402.00	2.26	1.68	125	Pass
NVNT	ANT1	2-DH1	2441.00	2.43	1.75	125	Pass
NVNT	ANT1	2-DH1	2480.00	2.28	1.69	125	Pass
NVNT	ANT1	3-DH1	2402.00	2.62	1.83	125	Pass
NVNT	ANT1	3-DH1	2441.00	2.46	1.76	125	Pass
NVNT	ANT1	3-DH1	2480.00	2.23	1.67	125	Pass

## 4. Bandwidth

### 4.1. Limit

Intentional radiators operating under the alternative provisions to the general emission limits, as contained in RSS-GEN, FCC Section 15.247(a)(1), must be designed to ensure that the 20 dB bandwidth of the emission, or whatever bandwidth may otherwise be specified in the specific rule section under which the equipment operates, is contained within the frequency band designated in the rule section under which the equipment is operated.

### 4.2. Test Procedure

The RF output of EUT was connected to the spectrum analyzer by RF cable and attenuator. The bandwidth of the fundamental frequency was measured by spectrum analyzer with 30kHz RBW and 100kHz VBW. The 20dB bandwidth is defined as the total spectrum the power of which is higher than peak power minus 20dB.

### 4.3. Test Result

Condition	Antenna	Modulation	Frequency (MHz)	-20dB BW(MHz)	if larger than CFS
NVNT	ANT1	1-DH1	2402.00	0.801	No
NVNT	ANT1	1-DH1	2441.00	0.798	No
NVNT	ANT1	1-DH1	2480.00	0.802	No
NVNT	ANT1	2-DH1	2402.00	1.114	Yes
NVNT	ANT1	2-DH1	2441.00	1.114	Yes
NVNT	ANT1	2-DH1	2480.00	1.114	Yes
NVNT	ANT1	3-DH1	2402.00	1.170	Yes
NVNT	ANT1	3-DH1	2441.00	1.170	Yes
NVNT	ANT1	3-DH1	2480.00	1.169	Yes

-20dB\_Bandwidth\_NVNT\_ANT1\_1-DH1\_2402\_00

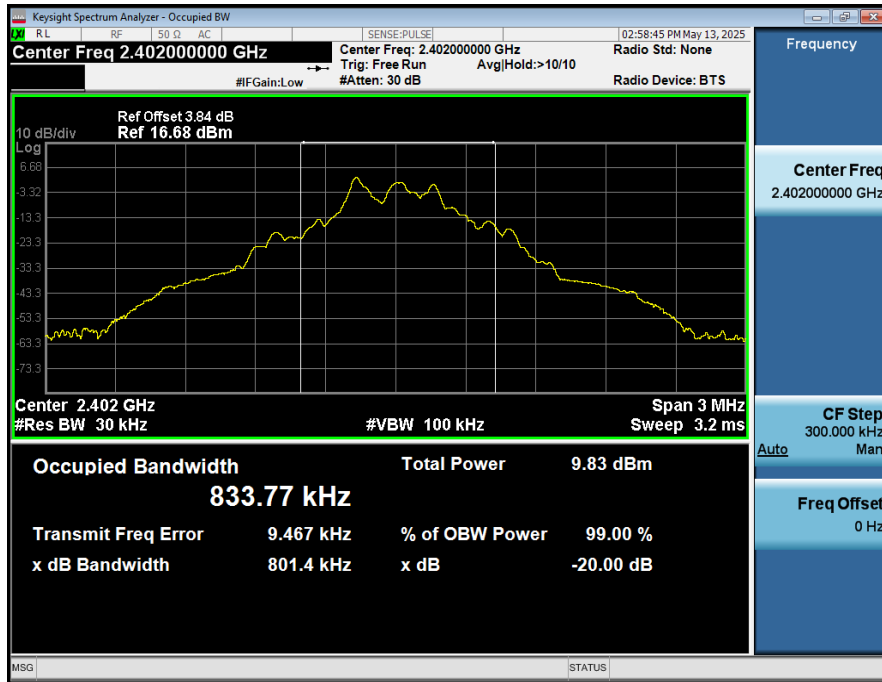

-20dB\_Bandwidth\_NVNT\_ANT1\_1-DH1\_2441\_00

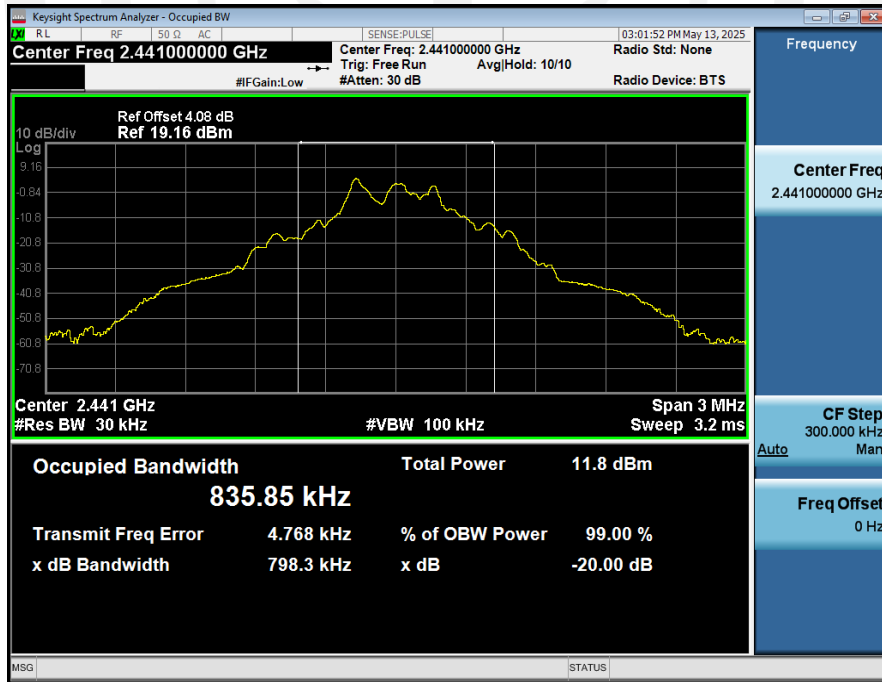

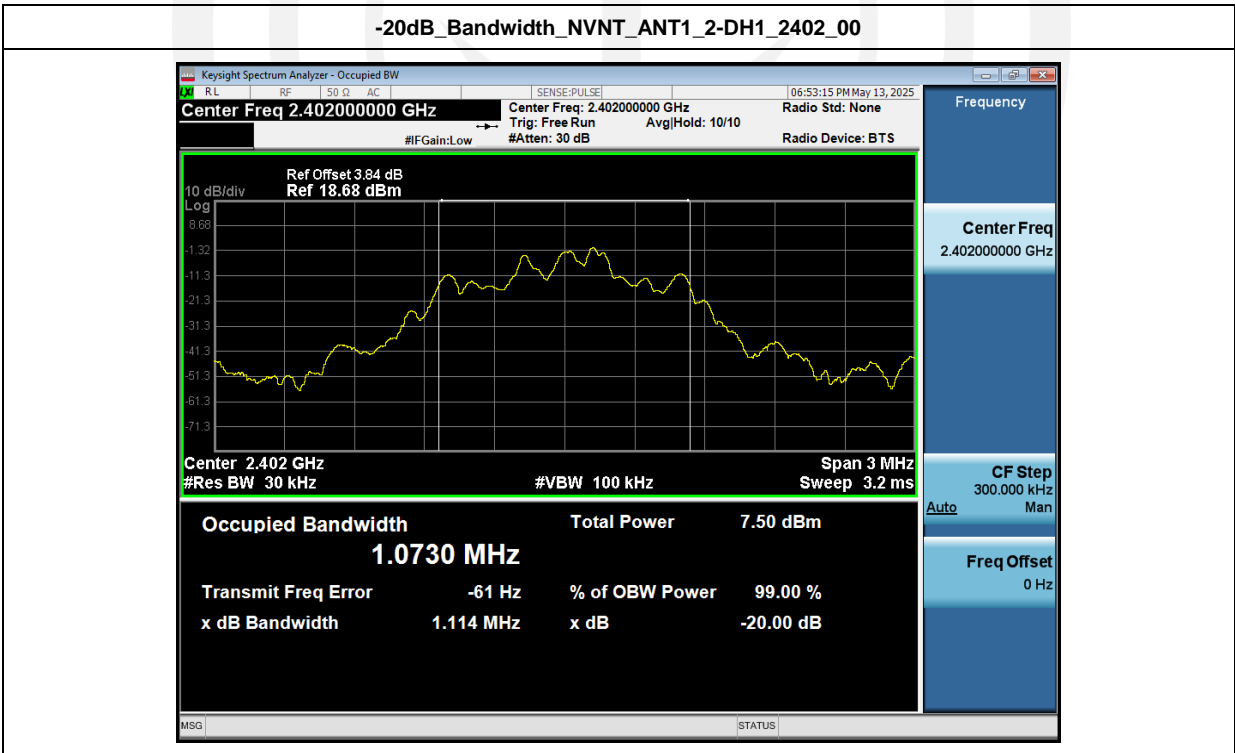
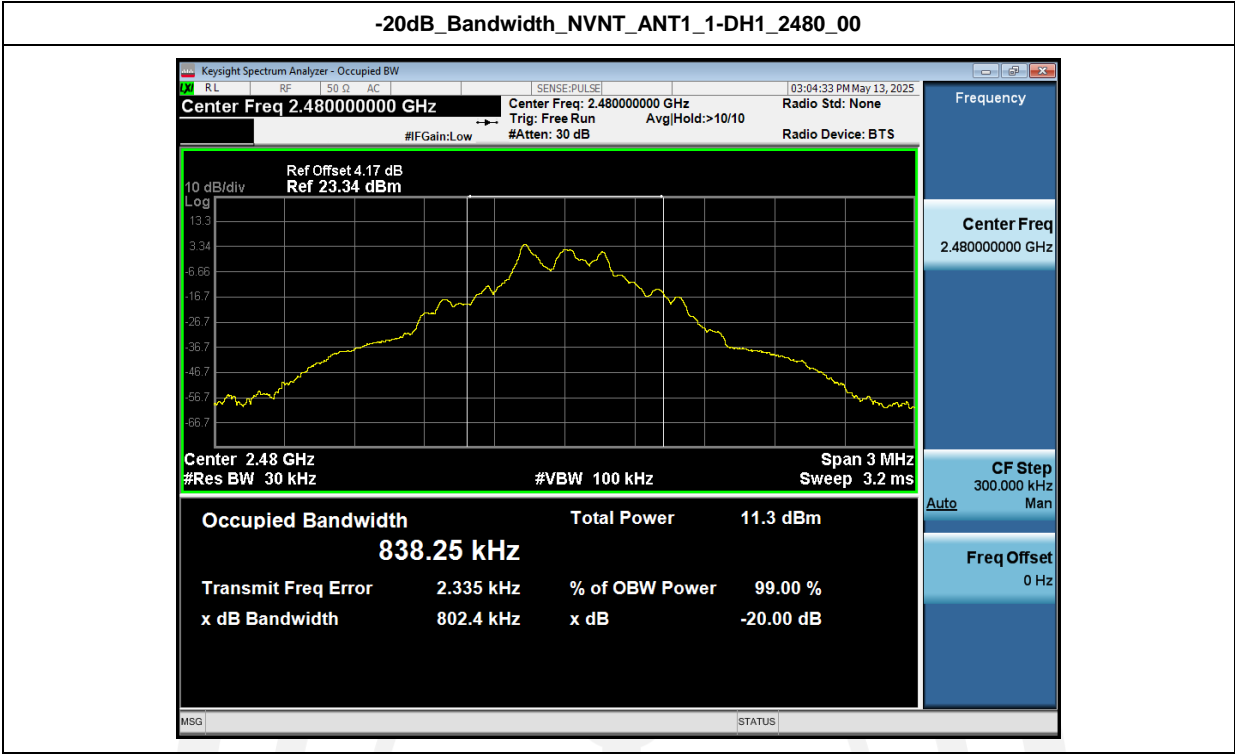

-20dB\_Bandwidth\_NVNT\_ANT1\_2-DH1\_2441\_00



-20dB\_Bandwidth\_NVNT\_ANT1\_2-DH1\_2480\_00





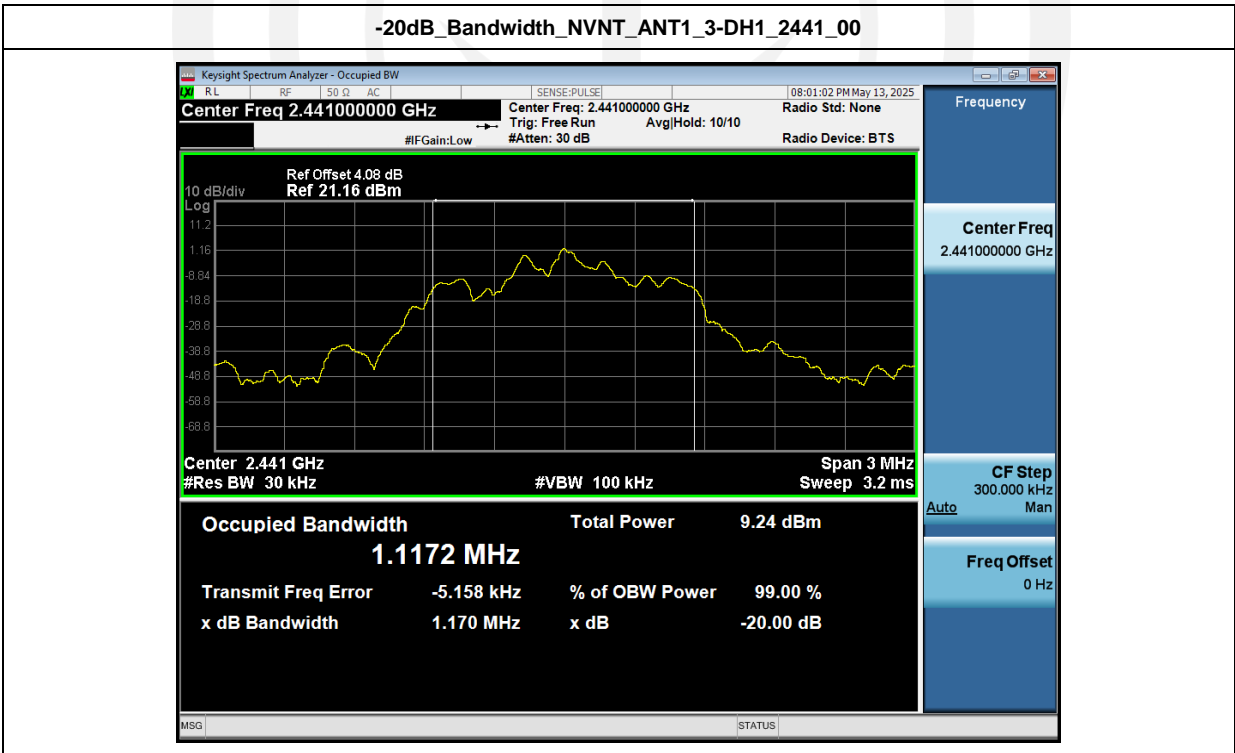
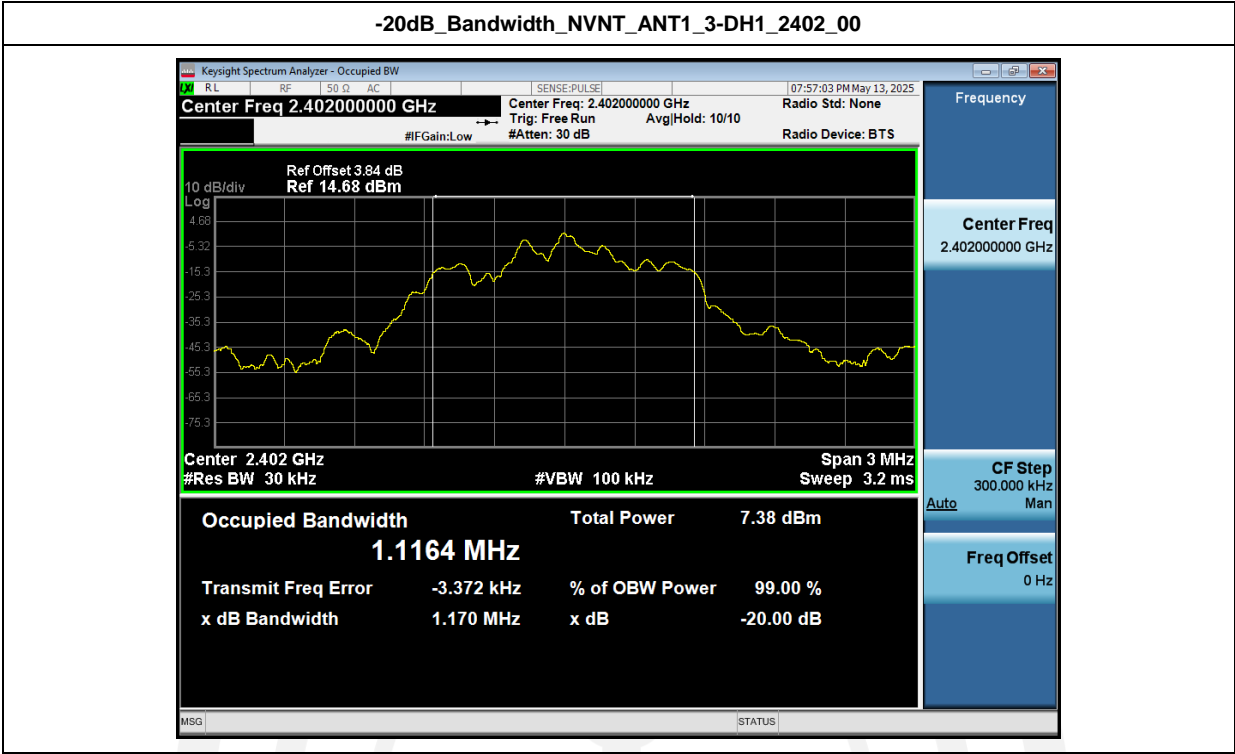

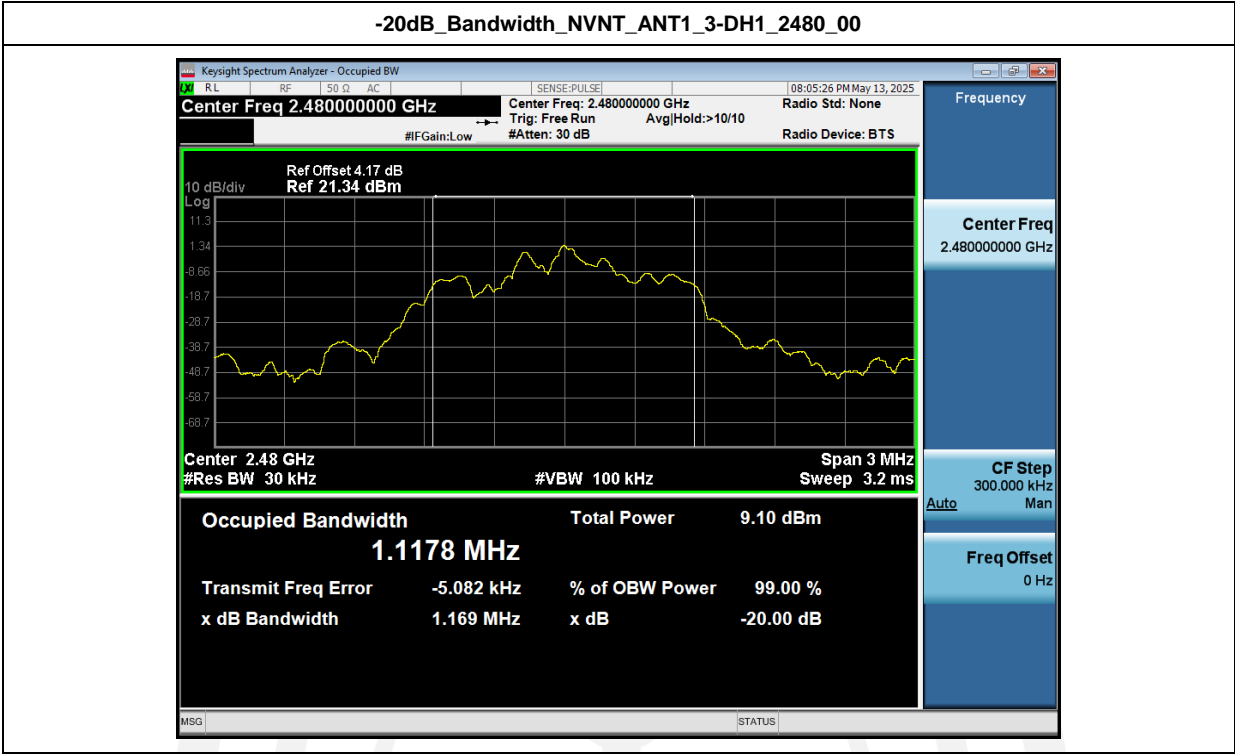

Condition	Antenna	Modulation	Frequency (MHz)	99% BW (MHz)
NVNT	ANT1	1-DH1	2402.00	0.834
NVNT	ANT1	1-DH1	2441.00	0.836
NVNT	ANT1	1-DH1	2480.00	0.838
NVNT	ANT1	2-DH1	2402.00	1.072
NVNT	ANT1	2-DH1	2441.00	1.072
NVNT	ANT1	2-DH1	2480.00	1.072
NVNT	ANT1	3-DH1	2402.00	1.117
NVNT	ANT1	3-DH1	2441.00	1.117
NVNT	ANT1	3-DH1	2480.00	1.118

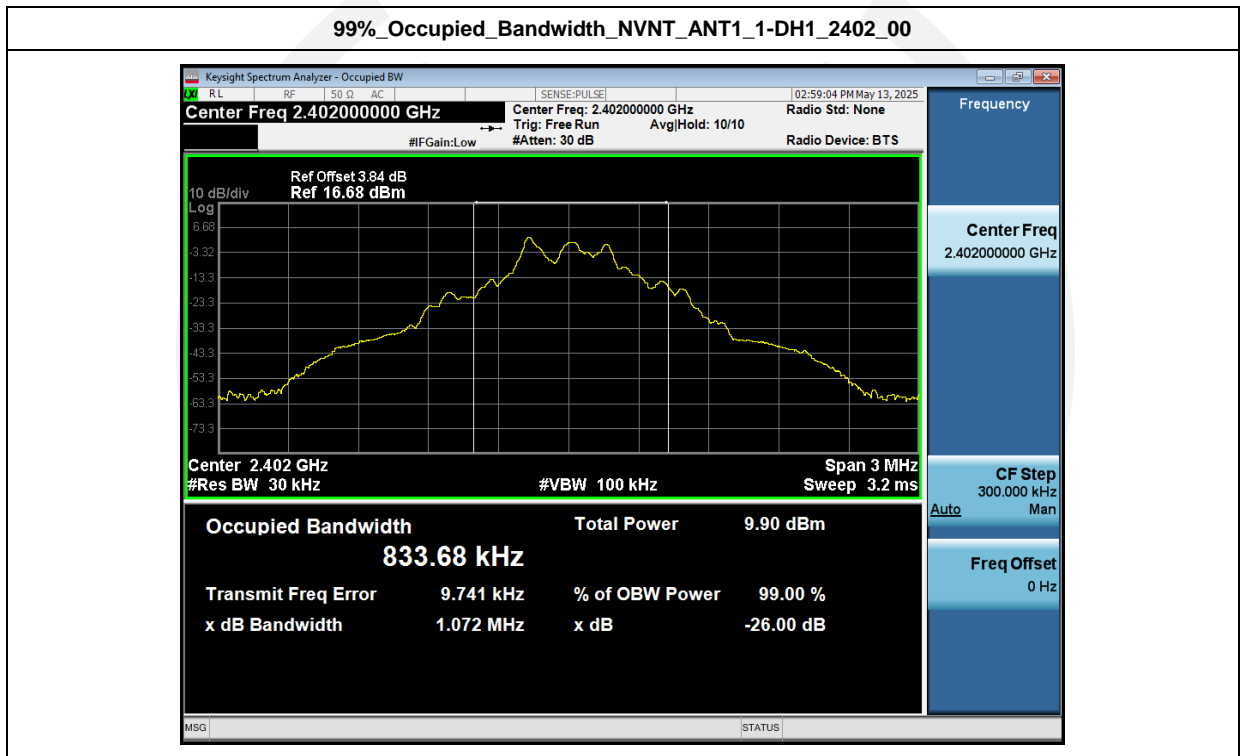

99%\_Occupied\_Bandwidth\_NVNT\_ANT1\_1-DH1\_2441\_00



99%\_Occupied\_Bandwidth\_NVNT\_ANT1\_1-DH1\_2480\_00



99%\_Occupied\_Bandwidth\_NVNT\_ANT1\_2-DH1\_2402\_00



99%\_Occupied\_Bandwidth\_NVNT\_ANT1\_2-DH1\_2441\_00



99%\_Occupied\_Bandwidth\_NVNT\_ANT1\_2-DH1\_2480\_00



99%\_Occupied\_Bandwidth\_NVNT\_ANT1\_3-DH1\_2402\_00



99%\_Occupied\_Bandwidth\_NVNT\_ANT1\_3-DH1\_2441\_00



99%\_Occupied\_Bandwidth\_NVNT\_ANT1\_3-DH1\_2480\_00



## 5. Carrier Frequency Separation

### 5.1. Limit

Frequency hopping systems shall have hopping channel carrier frequencies separated by a minimum of 25 kHz or the 20 dB bandwidth of the hopping channel, whichever is greater.

Alternatively, frequency hopping systems operating in the 2400-2483.5 MHz band may have hopping channel carrier frequencies that are separated by 25 kHz or two-thirds of the 20 dB bandwidth of the hopping channel, whichever is greater, provided the systems operate with an output power no greater than 125 mW

Please refer FCC part 15.247 & RSS-247.

### 5.2. Test Procedure

The RF output of EUT was connected to the spectrum analyzer by RF cable and attenuator. The carrier frequency was measured by spectrum analyzer with 100kHz RBW and 300kHz VBW.

### 5.3. Test Result

Condition	Antenna	Modulation	Frequency(MHz)	Hopping NO.0 (MHz)	Hopping NO.1 (MHz)	Carrier Frequencies Separation(MHz)	Limit(MHz)	Result
NVNT	ANT1	1-DH1	2441.00	2441.164	2442.169	1.00	0.798	Pass
NVNT	ANT1	2-DH1	2441.00	2441.164	2442.154	0.99	0.742	Pass
NVNT	ANT1	3-DH1	2441.00	2441.152	2442.151	1.00	0.780	Pass

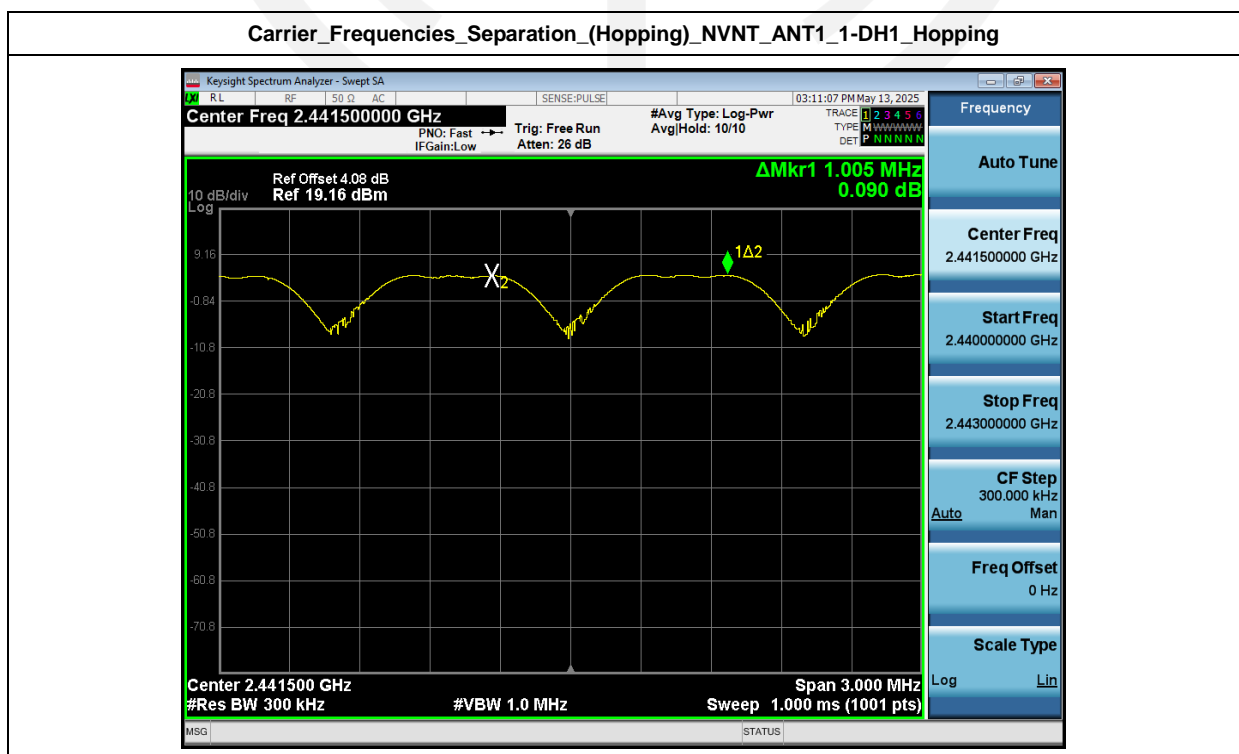



### Carrier\_Frequencies\_Separation\_(Hopping)\_NVNT\_ANT1\_2-DH1\_Hopping



### Carrier\_Frequencies\_Separation\_(Hopping)\_NVNT\_ANT1\_3-DH1\_Hopping



## 6. Number Of Hopping Channel

### 6.1. Limit

Frequency hopping systems in the 2400-2483.5 MHz band shall use at least 15 channels.

Please refer FCC part 15.247 & RSS-247.

### 6.2. Test Procedure

The RF output of EUT was connected to the spectrum analyzer by RF cable and attenuator. The number of hopping channel was measured by spectrum analyzer with 100kHz RBW and 300KHz VBW.

### 6.3. Test Result

Condition	Antenna	Modulation	Hopping Num	Limit	Result
NVNT	ANT1	1-DH1	79	15	Pass
NVNT	ANT1	2-DH1	79	15	Pass
NVNT	ANT1	3-DH1	79	15	Pass

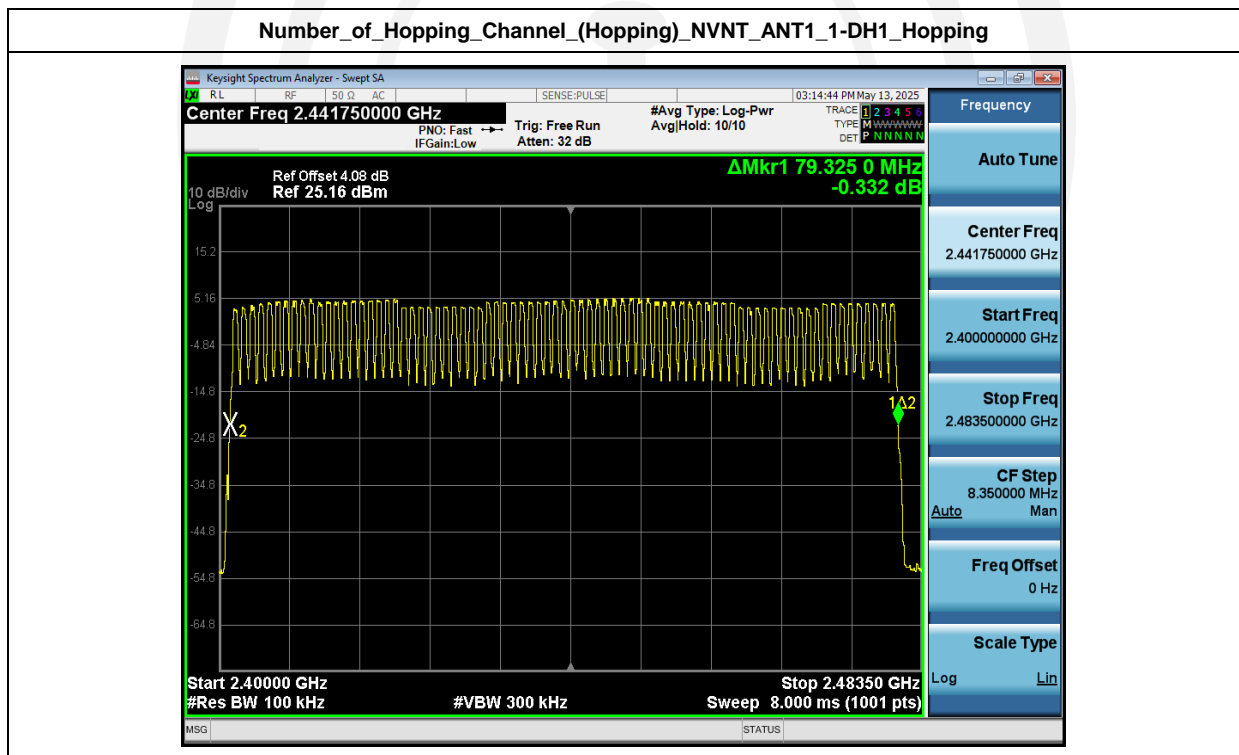

Number\_of\_Hopping\_Channel\_(Hopping)\_NVNT\_ANT1\_2-DH1\_Hopping

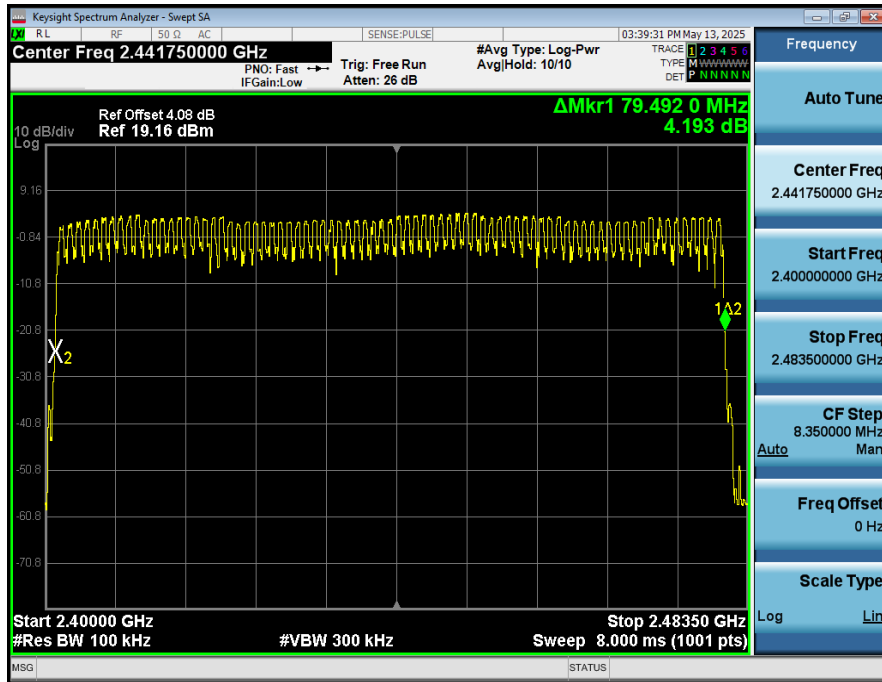

Number\_of\_Hopping\_Channel\_(Hopping)\_NVNT\_ANT1\_3-DH1\_Hopping

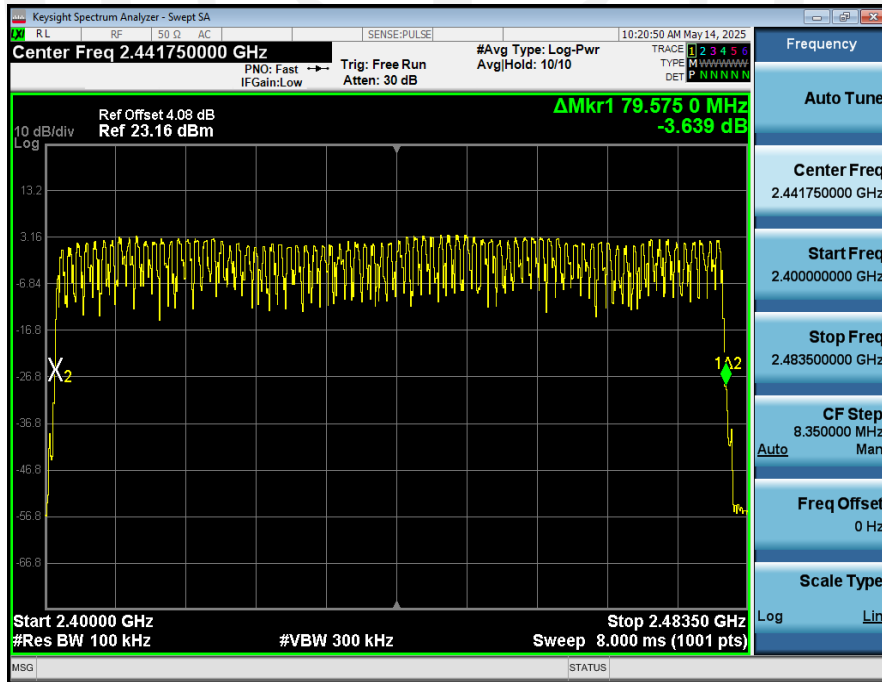

## 7. Dwell Time

### 7.1. Test limit

Please refer FCC part 15.247 & RSS-247.

Frequency hopping systems operating in the 2400MHz-2483.5MHz. The average time of occupancy on any frequency shall not greater than 0.4 s within period of 0.4 sec- onds multiplied by the number of hopping channel employed.

### 7.2. Test Procedure

7.2.1. Place the EUT on the table and set it in transmitting mode.

7.2.2. Remove the antenna from the EUT and then connect a low loss RF cable from the antenna port to the spectrum analyzer.

7.2.3. Set center frequency of spectrum analyzer = operating frequency.

7.2.4. Set the spectrum analyzer as RBW=1MHz, VBW=3MHz, Span = 0Hz, Sweep = auto.

7.2.5. Repeat above procedures until all frequency measured were complete.

7.2.6. The test period:  $T = 0.4 \text{ Second/Channel} \times 79 \text{ Channel} = 31.6 \text{ s}$

7.2.7. Dwell Time=Pulse Time\* Hops Number

### 7.3. Test Result

Condition	Antenna	Packet Type	Pulse Time(ms)	Hops	Dwell Time(ms)	Limit(s)	Result
NVNT	ANT1	1-DH1	0.420	320.00	134.400	0.40	Pass
NVNT	ANT1	2-DH1	0.410	320.00	131.200	0.40	Pass
NVNT	ANT1	3-DH1	0.410	320.00	131.200	0.40	Pass
NVNT	ANT1	1-DH3	1.680	156.00	262.080	0.40	Pass
NVNT	ANT1	1-DH5	2.920	106.00	309.520	0.40	Pass
NVNT	ANT1	2-DH3	1.670	150.00	250.500	0.40	Pass
NVNT	ANT1	2-DH5	2.920	98.00	286.160	0.40	Pass
NVNT	ANT1	3-DH3	1.670	170.00	283.900	0.40	Pass
NVNT	ANT1	3-DH5	2.920	101.00	294.920	0.40	Pass

Dwell\_Time\_(Hopping)\_NVNT\_ANT1\_1-DH1\_2441\_00\_One\_Burst\_Time

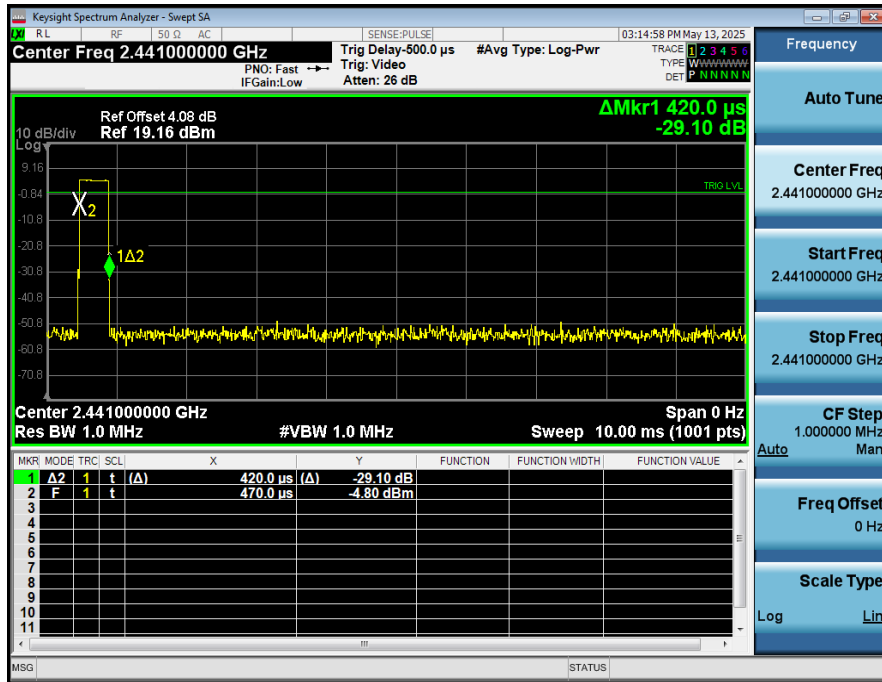

Dwell\_Time\_(Hopping)\_NVNT\_ANT1\_1-DH1\_2441\_00\_Accumulated

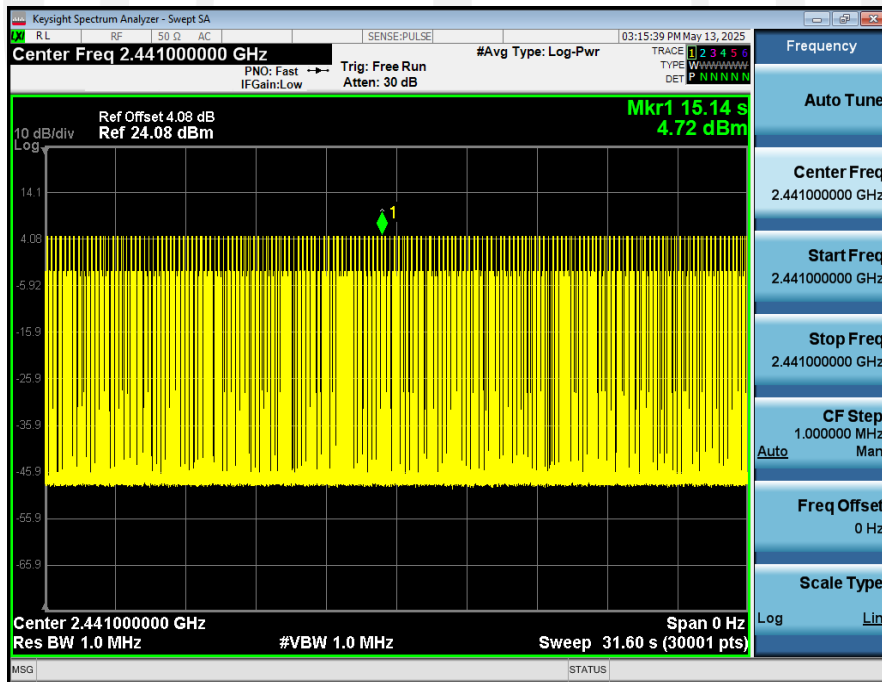

Dwell\_Time\_(Hopping)\_NVNT\_ANT1\_2-DH1\_2441\_00\_One\_Burst\_Time

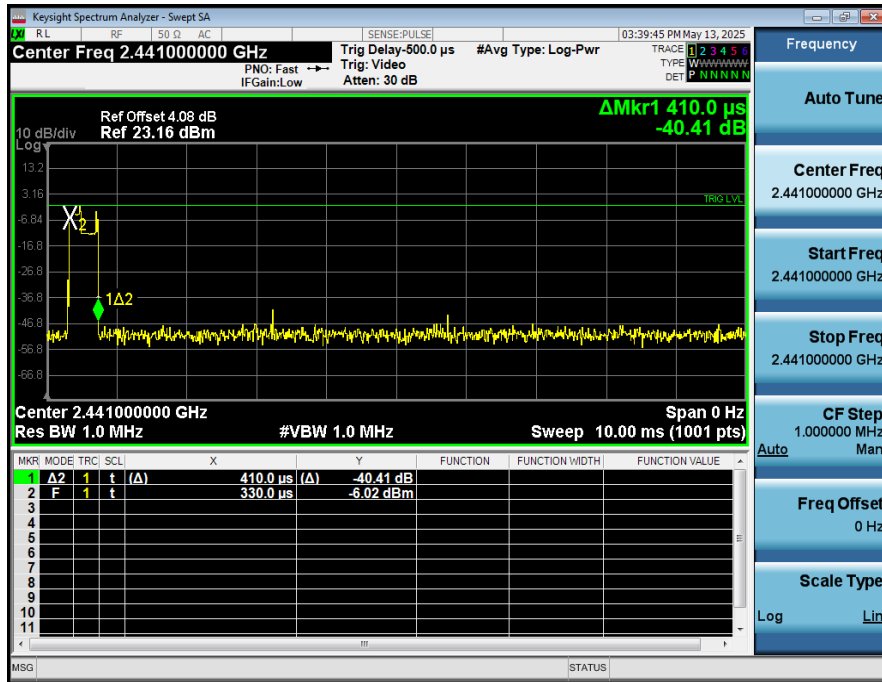

Dwell\_Time\_(Hopping)\_NVNT\_ANT1\_2-DH1\_2441\_00\_Accumulated

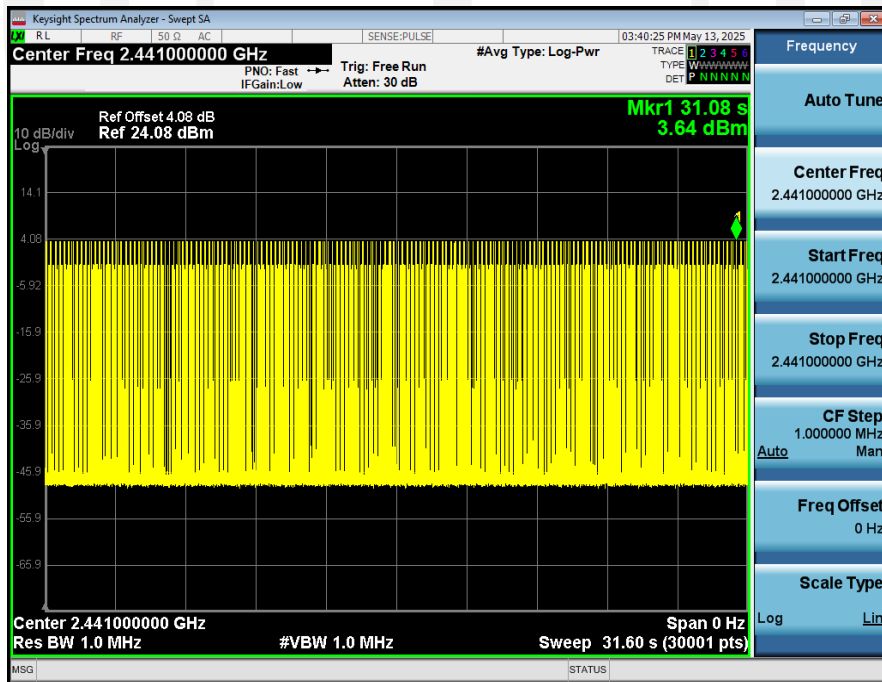

Dwell\_Time\_(Hopping)\_NVNT\_ANT1\_3-DH1\_2441\_00\_One\_Burst\_Time

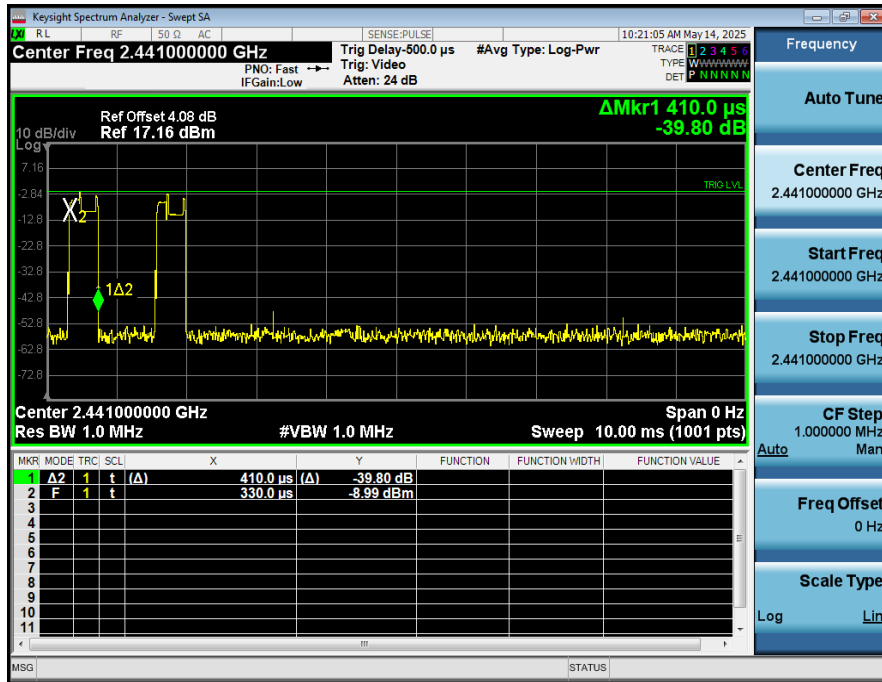

Dwell\_Time\_(Hopping)\_NVNT\_ANT1\_3-DH1\_2441\_00\_Accumulated

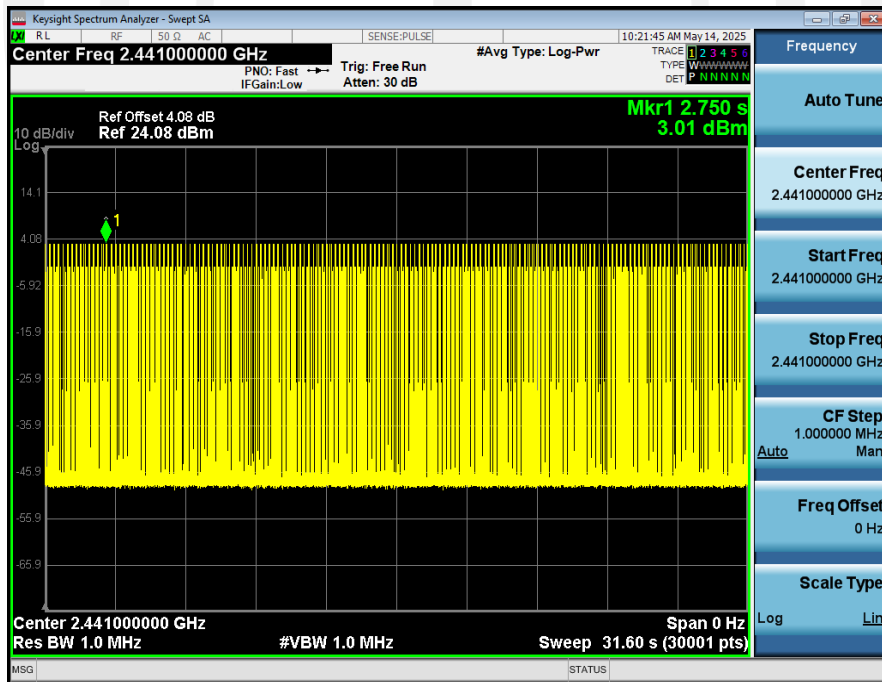

Dwell\_Time\_(Hopping)\_NVNT\_ANT1\_1-DH3\_2441\_00\_One\_Burst\_Time

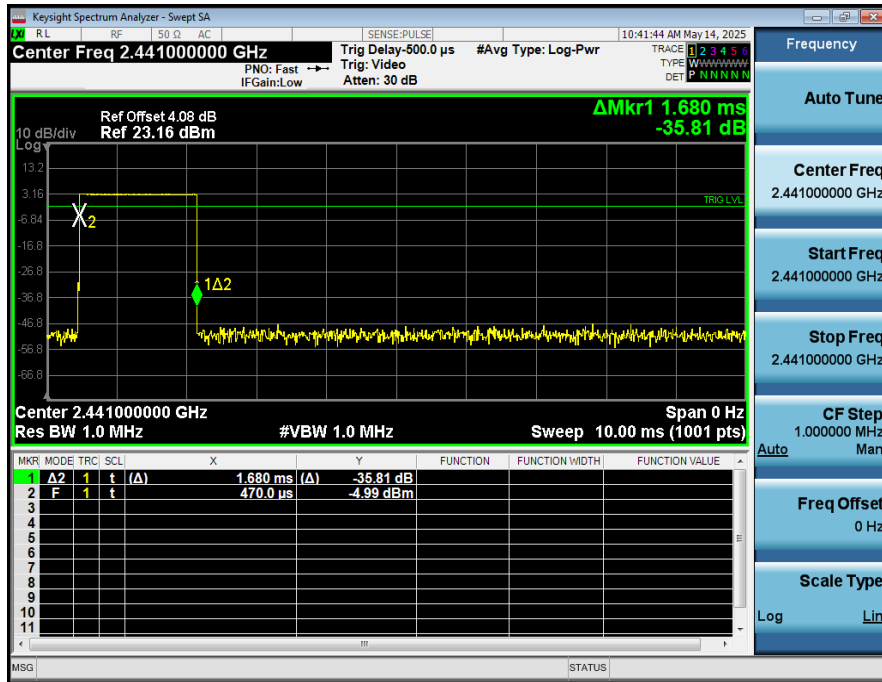

Dwell\_Time\_(Hopping)\_NVNT\_ANT1\_1-DH3\_2441\_00\_Accumulated

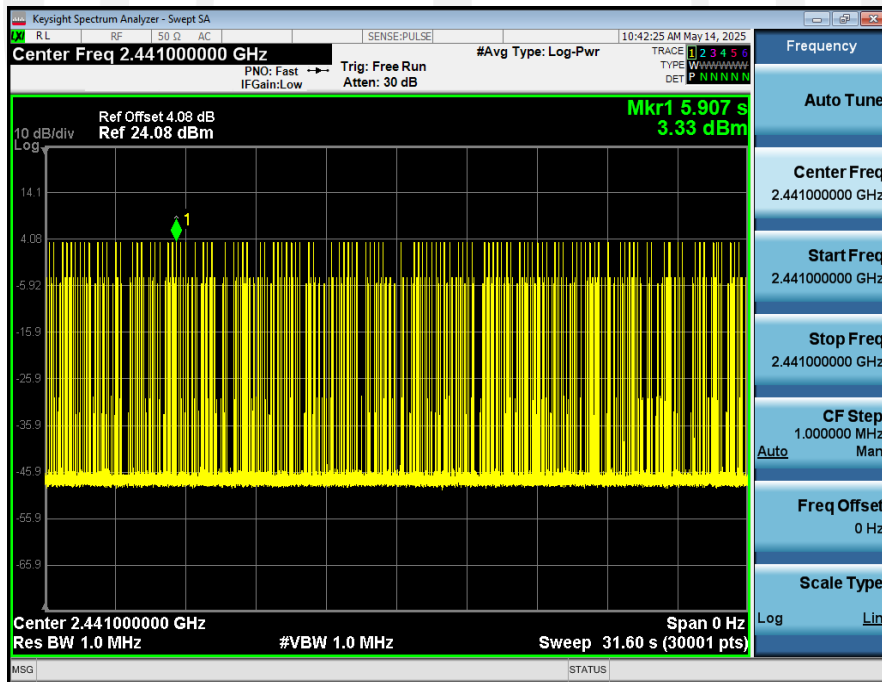



Dwell\_Time\_(Hopping)\_NVNT\_ANT1\_1-DH5\_2441\_00\_One\_Burst\_Time

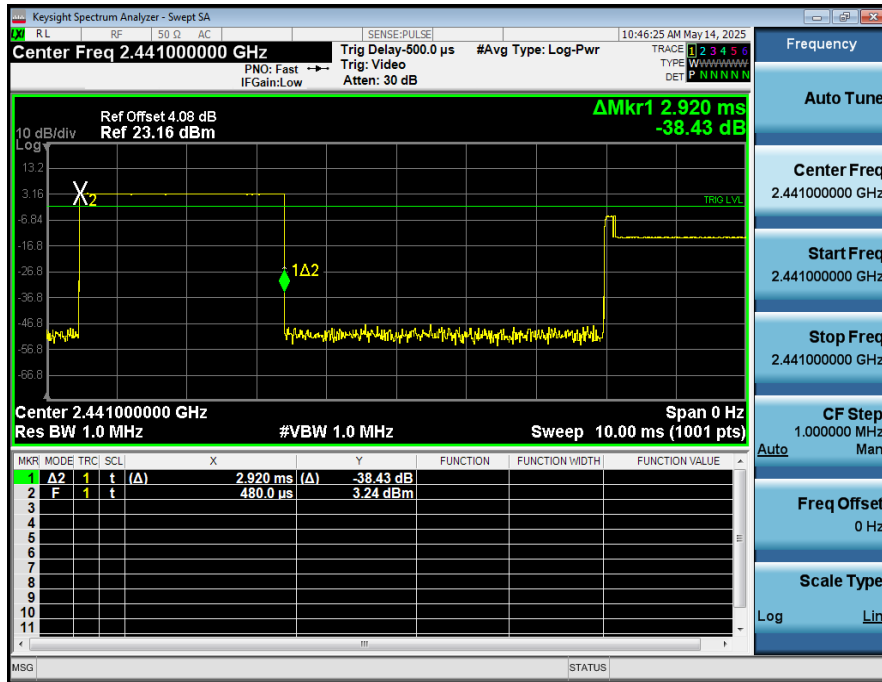

Dwell\_Time\_(Hopping)\_NVNT\_ANT1\_1-DH5\_2441\_00\_Accumulated

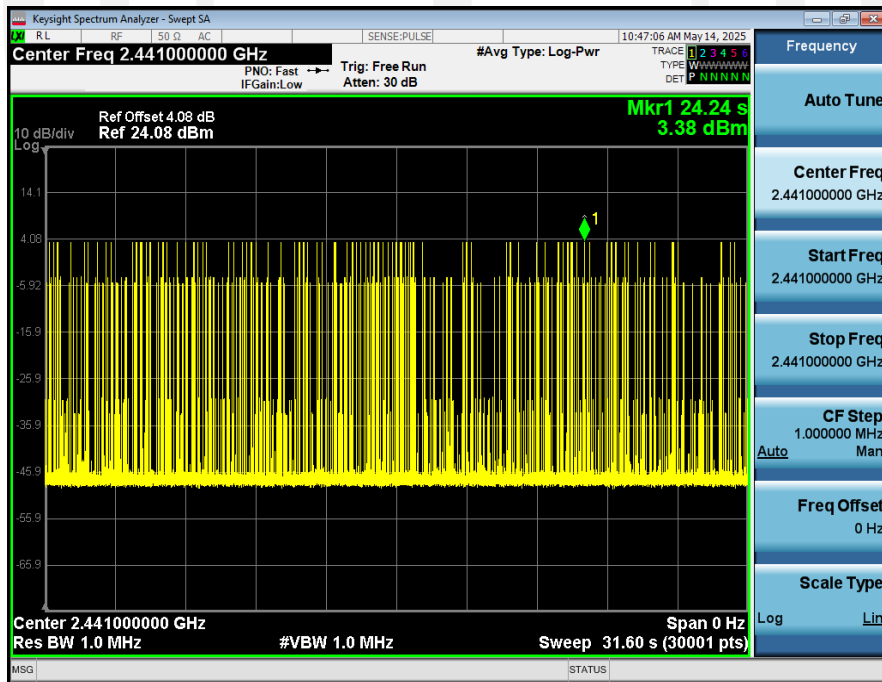

Dwell\_Time\_(Hopping)\_NVNT\_ANT1\_2-DH3\_2441\_00\_One\_Burst\_Time

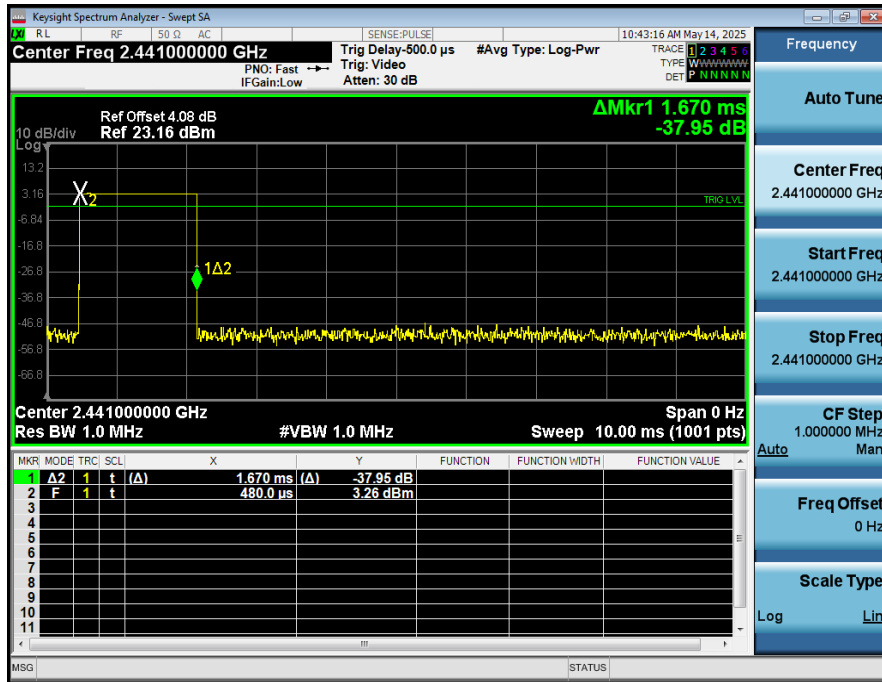

Dwell\_Time\_(Hopping)\_NVNT\_ANT1\_2-DH3\_2441\_00\_Accumulated

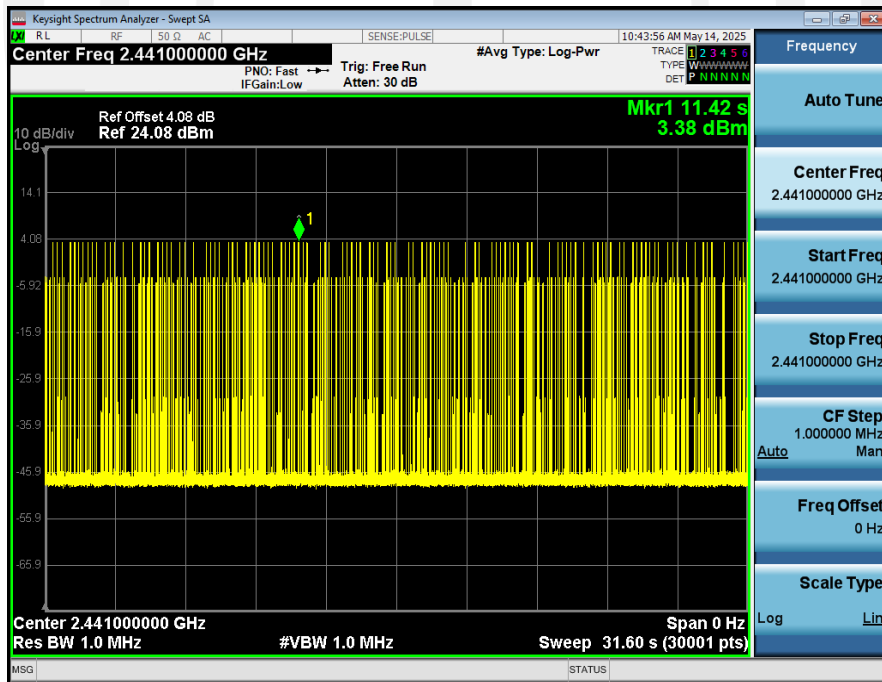

Dwell\_Time\_(Hopping)\_NVNT\_ANT1\_2-DH5\_2441\_00\_One\_Burst\_Time

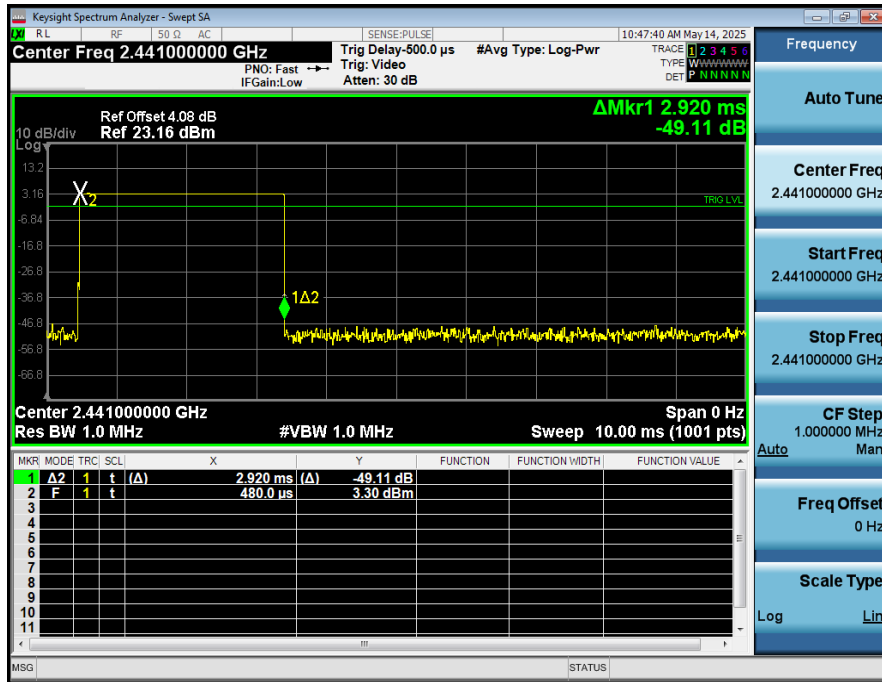

Dwell\_Time\_(Hopping)\_NVNT\_ANT1\_2-DH5\_2441\_00\_Accumulated

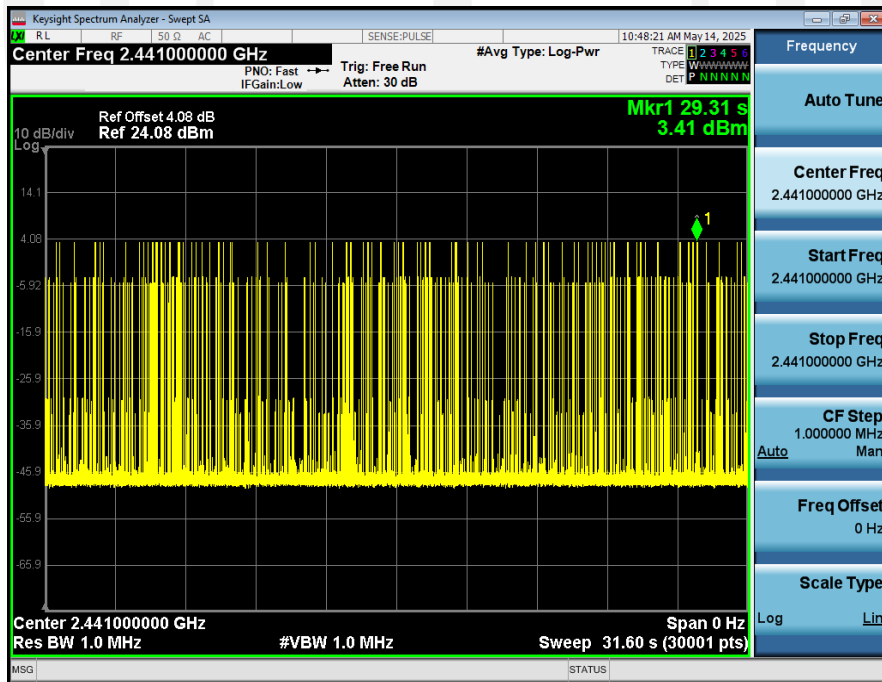

Dwell\_Time\_(Hopping)\_NVNT\_ANT1\_3-DH3\_2441\_00\_One\_Burst\_Time

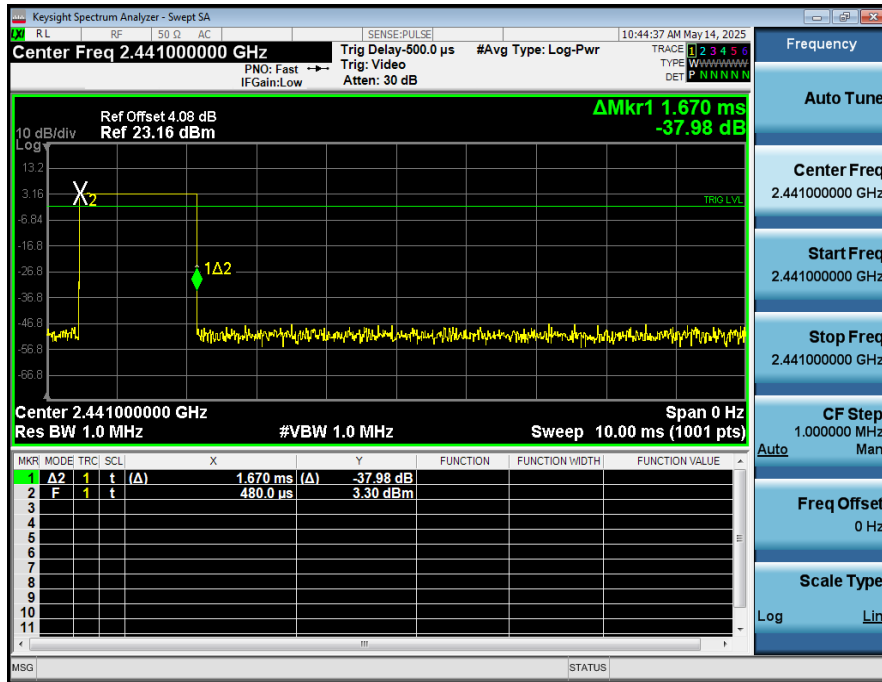

Dwell\_Time\_(Hopping)\_NVNT\_ANT1\_3-DH3\_2441\_00\_Accumulated

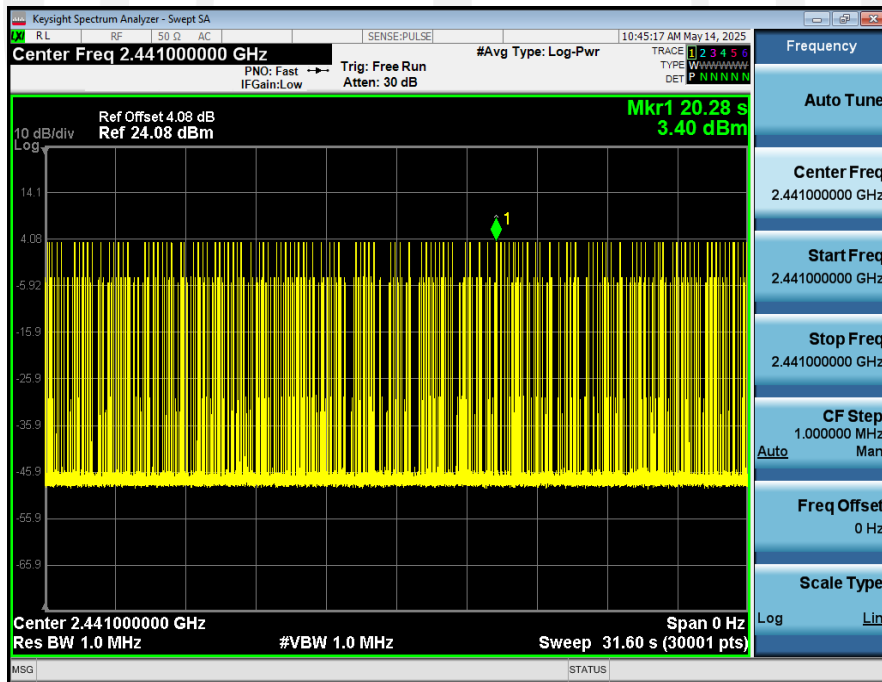

Dwell\_Time\_(Hopping)\_NVNT\_ANT1\_3-DH5\_2441\_00\_One\_Burst\_Time

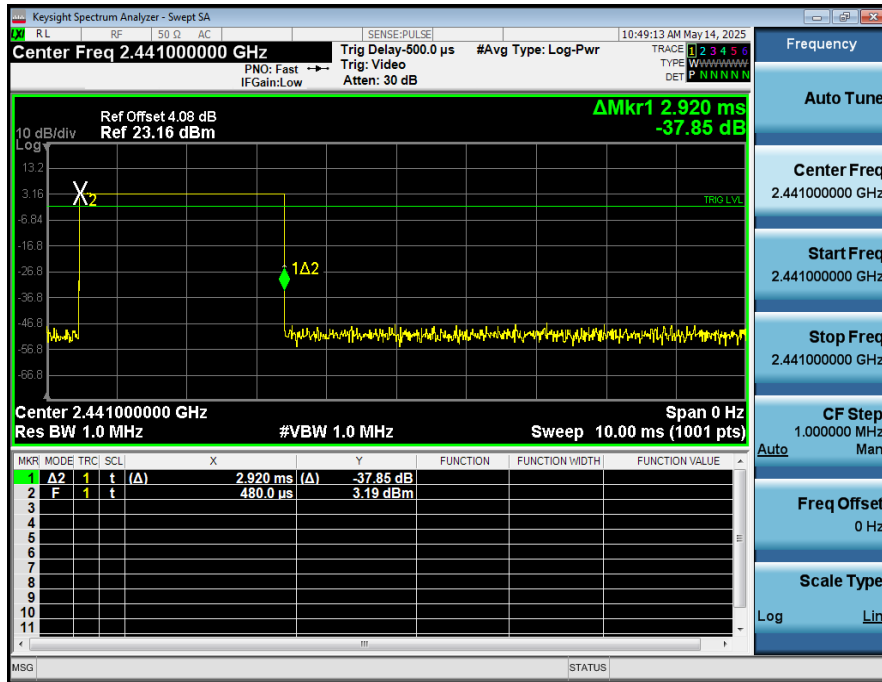

Dwell\_Time\_(Hopping)\_NVNT\_ANT1\_3-DH5\_2441\_00\_Accumulated

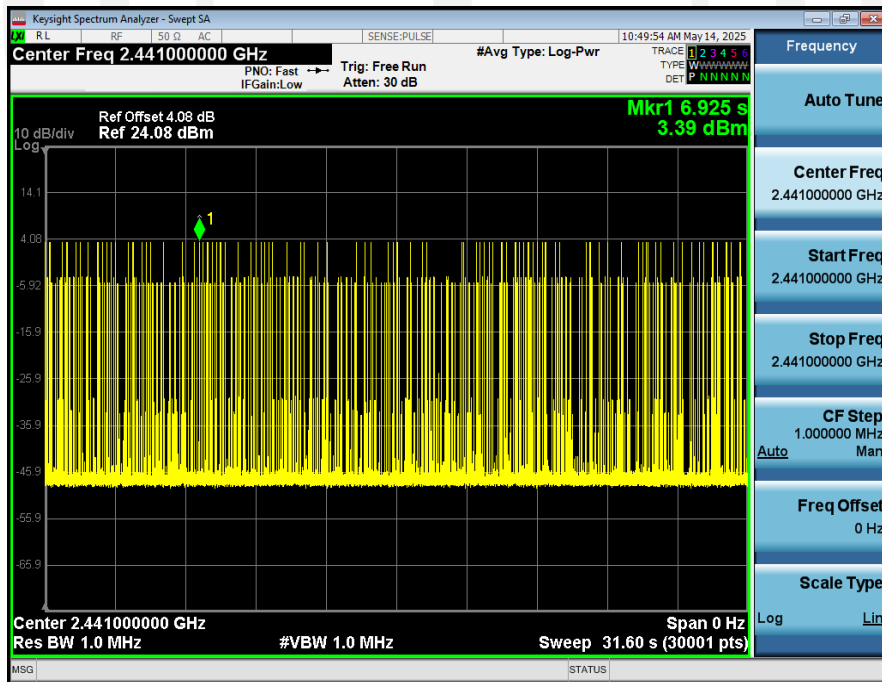

## 8. Out-of-band Emissions

### 8.1. Test Limits

In any 100 kHz bandwidth outside the frequency band in which the spread spectrum or digitally modulated intentional radiator is operating, the radio frequency power that is produced by the intentional radiator shall be at least 20 dB below that in the 100 kHz bandwidth within the band that contains the highest level of the desired power, based on either an RF conducted or a radiated measurement, provided the transmitter demonstrates compliance with the peak conducted power limits. If the transmitter complies with the conducted power limits based on the use of RMS averaging over a time interval, as permitted under paragraph (b)(3) of this section, the attenuation required under this paragraph shall be 30 dB instead of 20 dB. Attenuation below the general limits specified in FCC Part 15.209(a) is not required. Please refer section RSS-GEN&15.247.

### 8.2. Test Procedure

Connect the transmitter output to spectrum analyzer using a low loss RF cable, and set the spectrum analyzer to RBW=100 kHz, VBW= 300 kHz, peak detector, and max hold. Measurements utilizing these settings are made of the in-band reference level, band edge and out-of-band emissions.

### 8.3. Test Setup

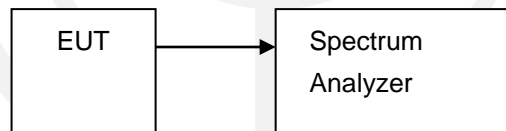

### 8.4. Test Results

PASS.

The test results are listed in next pages.

**Band Edge: Pass**

Condition	Antenna	Modulation	TX Mode	Ref_level(dBm)	Bandedge MAX.Value	Limit	Result
NVNT	ANT1	1-DH1	2402.00	2.743	-58.722	-17.257	Pass
NVNT	ANT1	1-DH1	Hopping_LCH	4.984	-56.576	-15.016	Pass
NVNT	ANT1	1-DH1	2480.00	4.144	-56.057	-15.856	Pass
NVNT	ANT1	1-DH1	Hopping_HCH	5.437	-53.401	-14.563	Pass
NVNT	ANT1	2-DH1	2402.00	0.399	-55.666	-19.601	Pass
NVNT	ANT1	2-DH1	Hopping_LCH	4.055	-48.299	-15.945	Pass
NVNT	ANT1	2-DH1	2480.00	2.626	-59.174	-17.374	Pass
NVNT	ANT1	2-DH1	Hopping_HCH	4.458	-41.053	-15.542	Pass
NVNT	ANT1	3-DH1	2402.00	0.726	-55.515	-19.274	Pass
NVNT	ANT1	3-DH1	Hopping_LCH	3.448	-57.461	-16.552	Pass
NVNT	ANT1	3-DH1	2480.00	2.582	-59.048	-17.418	Pass
NVNT	ANT1	3-DH1	Hopping_HCH	3.772	-56.443	-16.228	Pass



1\_Reference\_Level\_NVNT\_ANT1\_1-DH1\_2402\_00

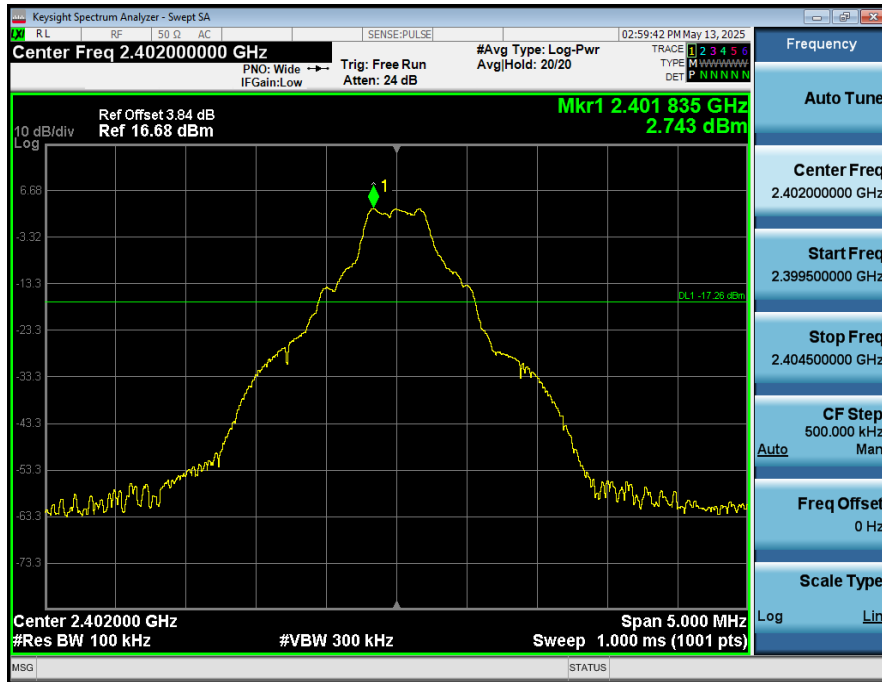

2\_Bandedge\_NVNT\_ANT1\_1-DH1\_2402\_00

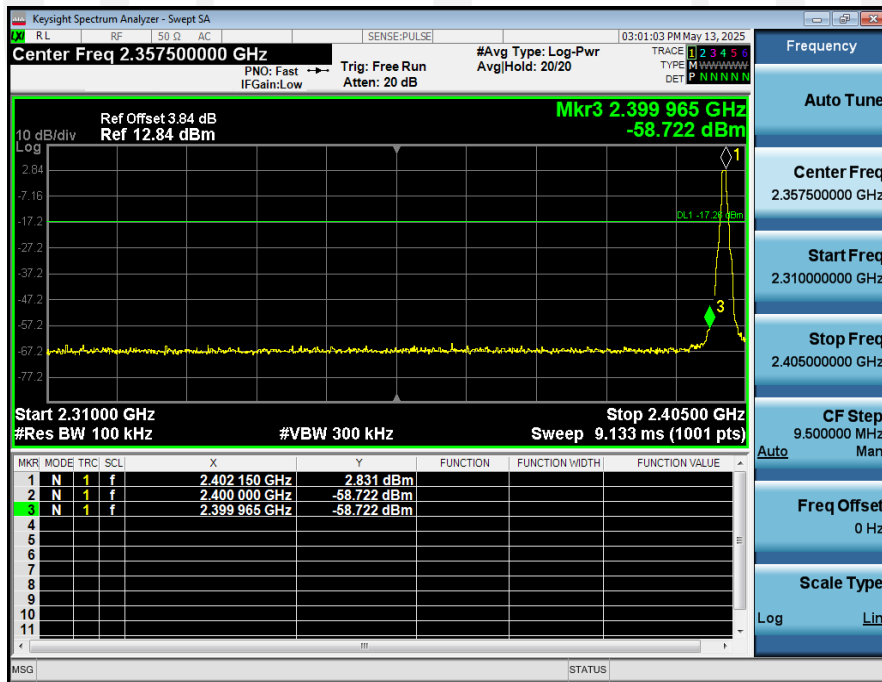



1\_Reference\_Level\_Hopping\_NVNT\_ANT1\_1-DH1\_Hopping

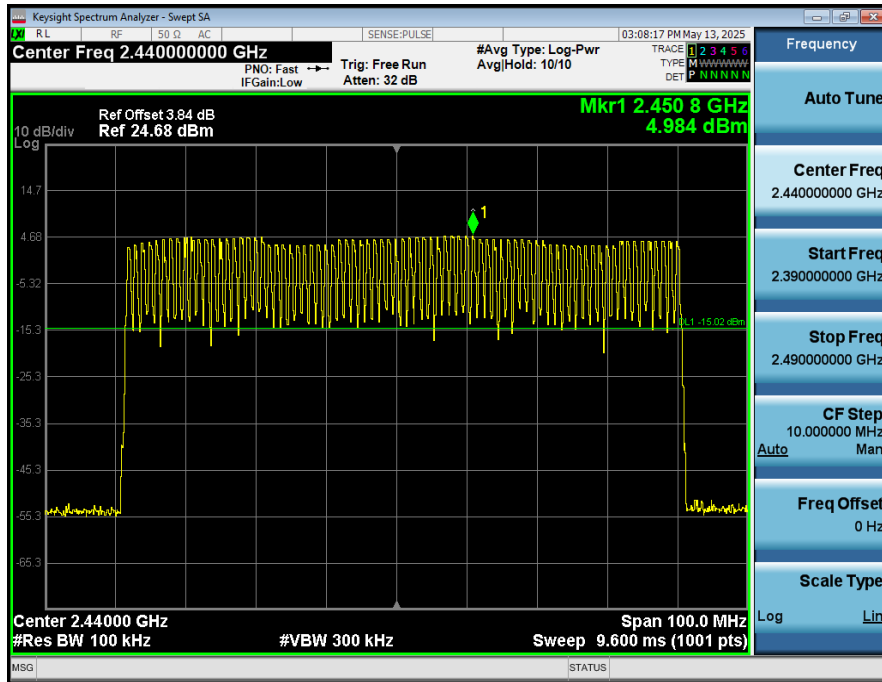

2\_Band\_Edge\_(Hopping)\_NVNT\_ANT1\_1-DH1\_Hopping

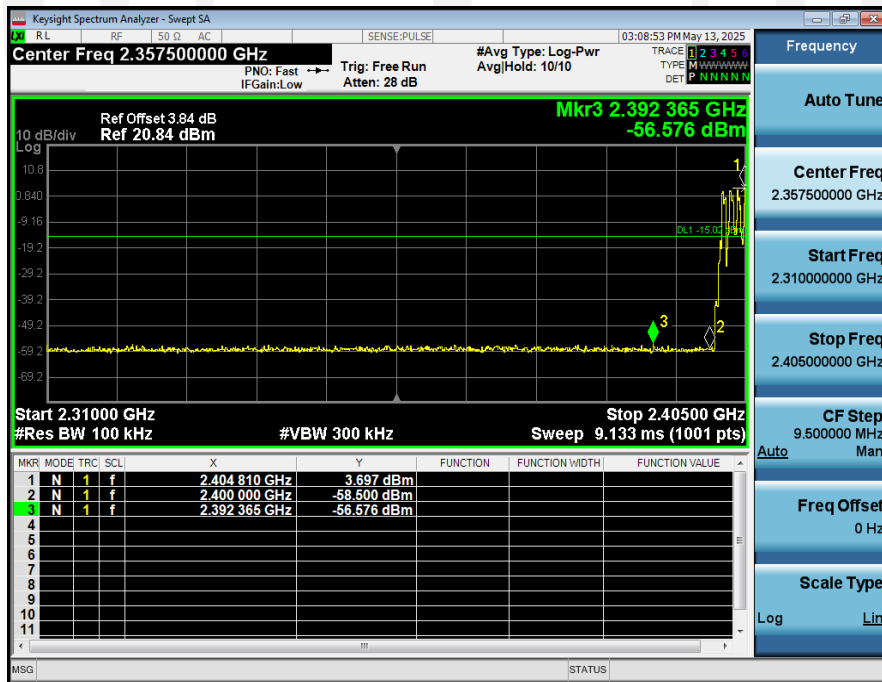

1\_Reference\_Level\_NVNT\_ANT1\_1-DH1\_2480\_00

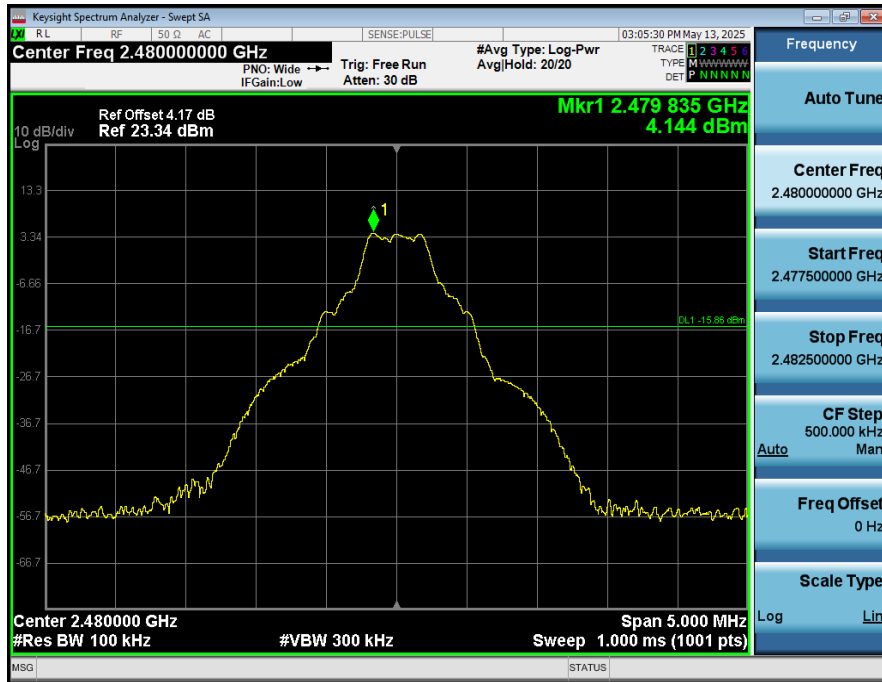

2\_Bandedge\_NVNT\_ANT1\_1-DH1\_2480\_00

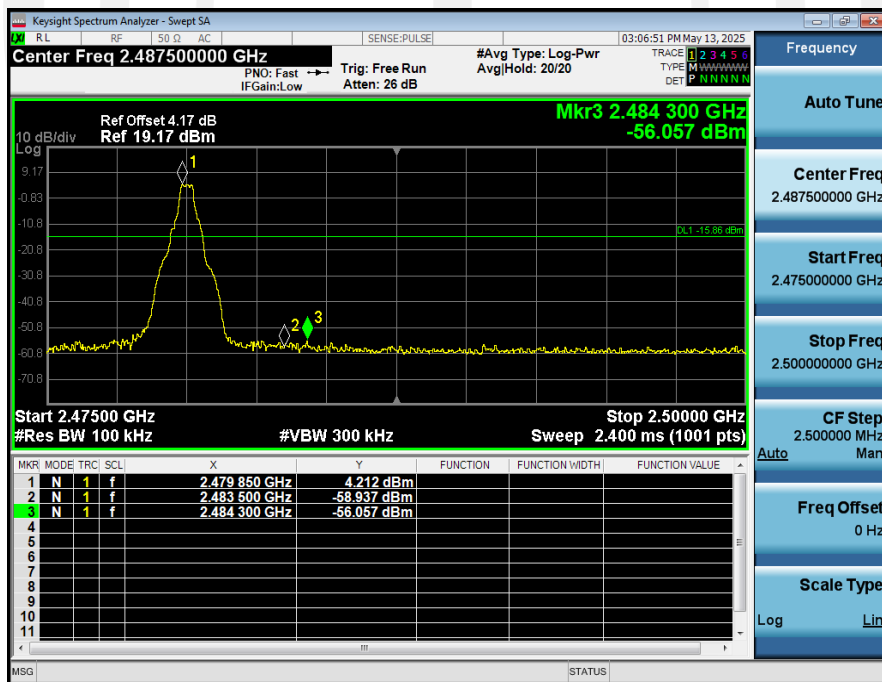

1\_Reference\_Level\_Hopping\_NVNT\_ANT1\_1-DH1\_Hopping

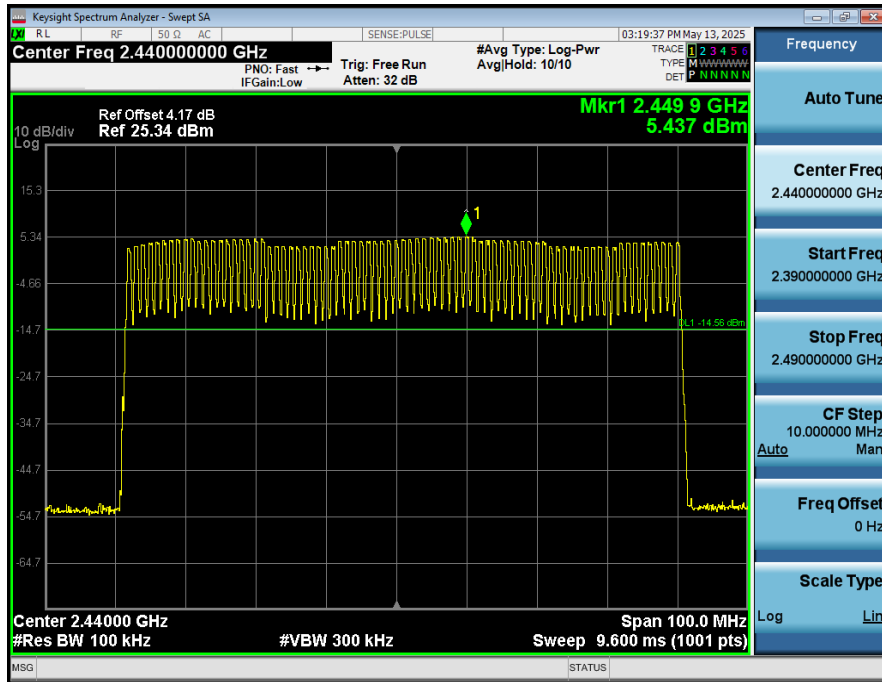

2\_Band\_Edge\_(Hopping)\_NVNT\_ANT1\_1-DH1\_Hopping

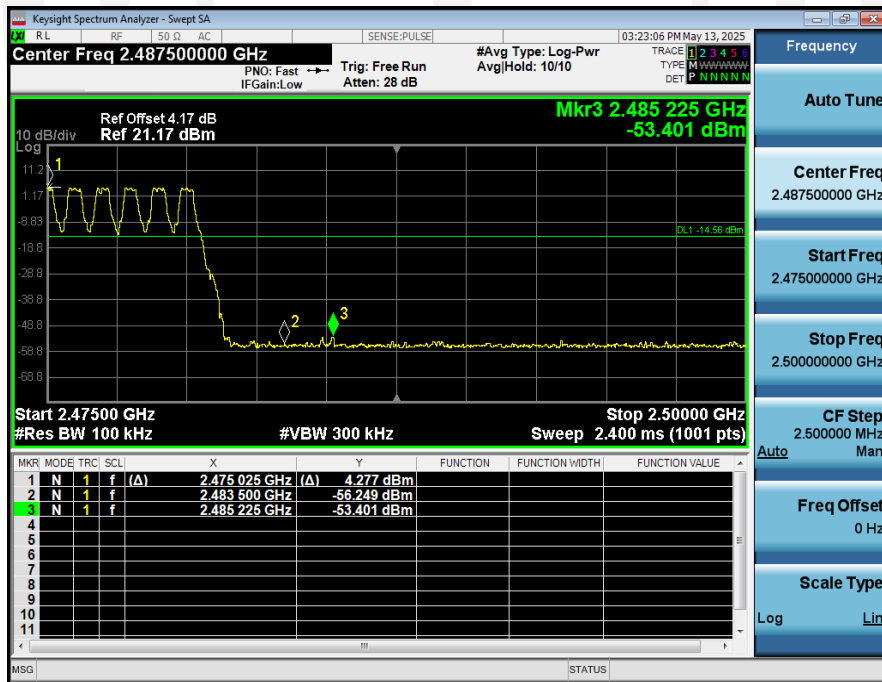

1\_Reference\_Level\_NVNT\_ANT1\_2-DH1\_2402\_00



2\_Bandedge\_NVNT\_ANT1\_2-DH1\_2402\_00

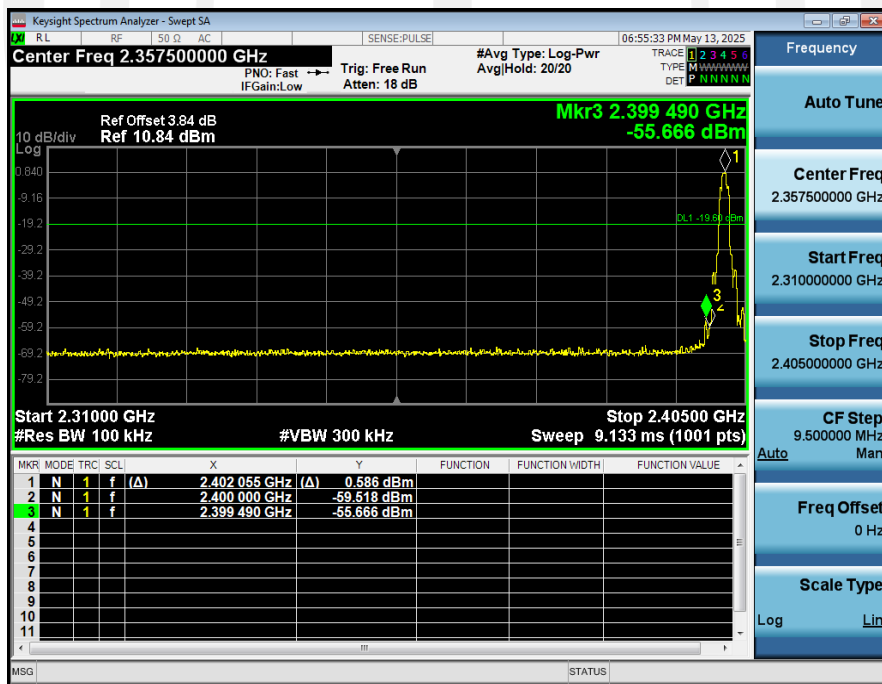

1\_Reference\_Level\_Hopping\_NVNT\_ANT1\_2-DH1\_Hopping



2\_Band\_Edge\_(Hopping)\_NVNT\_ANT1\_2-DH1\_Hopping

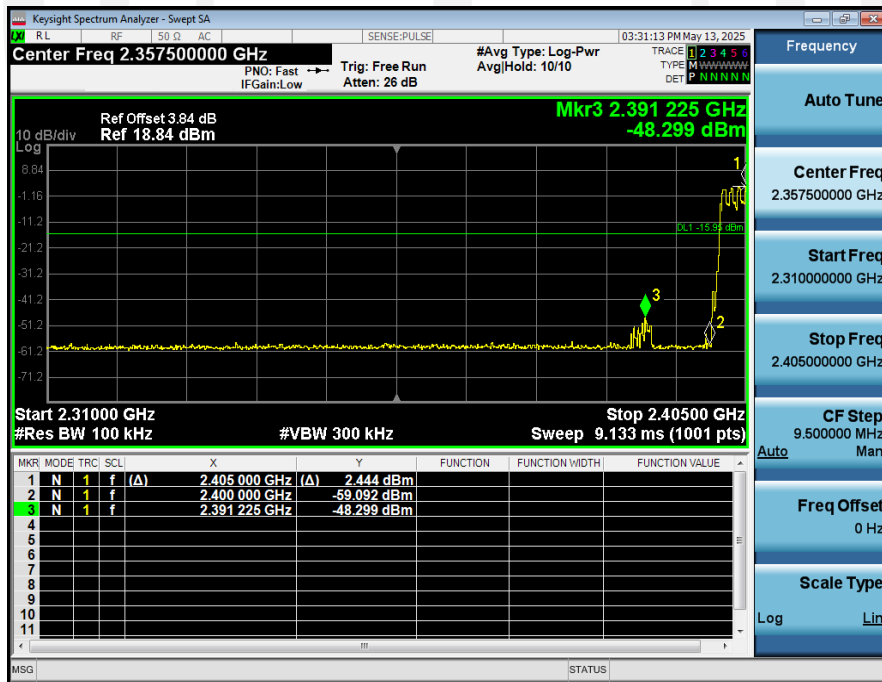

1\_Reference\_Level\_NVNT\_ANT1\_2-DH1\_2480\_00



2\_Bandedge\_NVNT\_ANT1\_2-DH1\_2480\_00

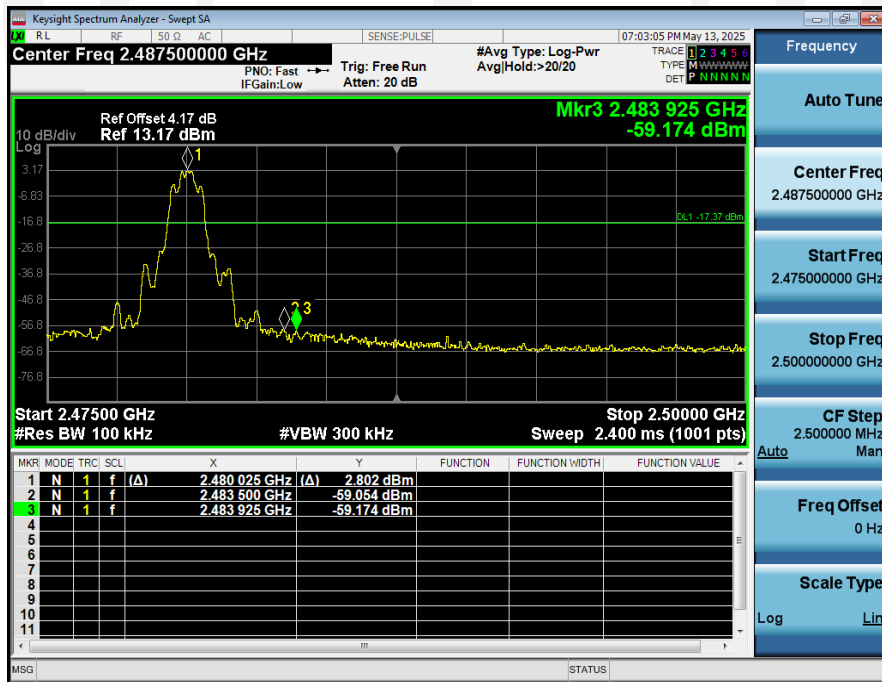

1\_Reference\_Level\_Hopping\_NVNT\_ANT1\_2-DH1\_Hopping

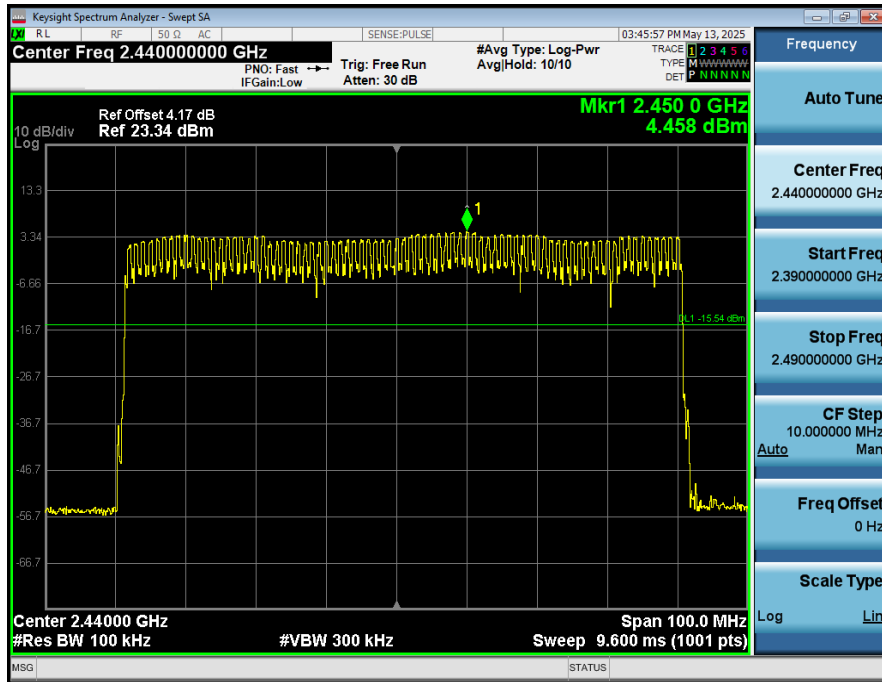

2\_Band\_Edge\_(Hopping)\_NVNT\_ANT1\_2-DH1\_Hopping

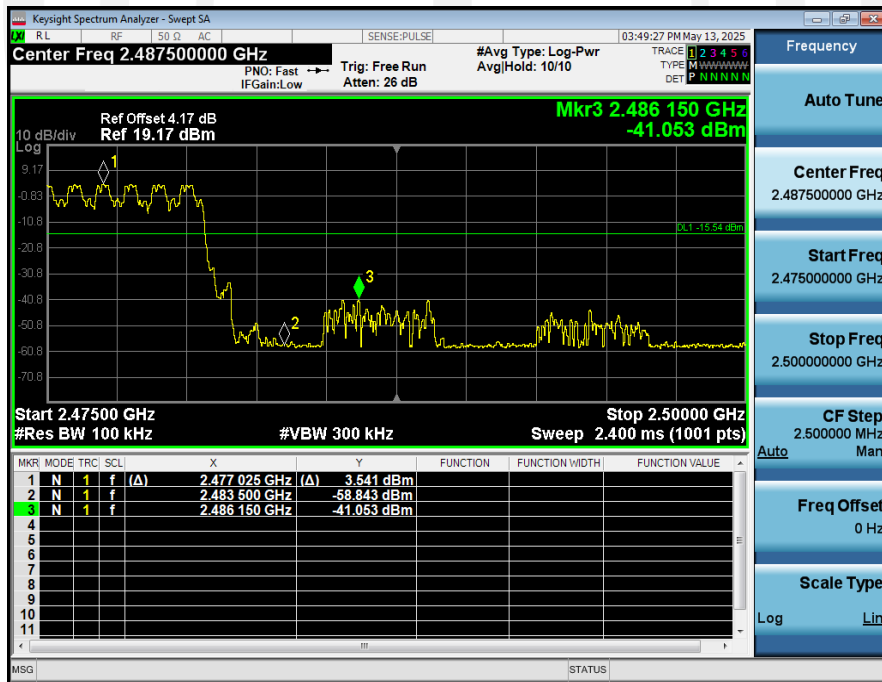

1\_Reference\_Level\_NVNT\_ANT1\_3-DH1\_2402\_00



2\_Bandedge\_NVNT\_ANT1\_3-DH1\_2402\_00

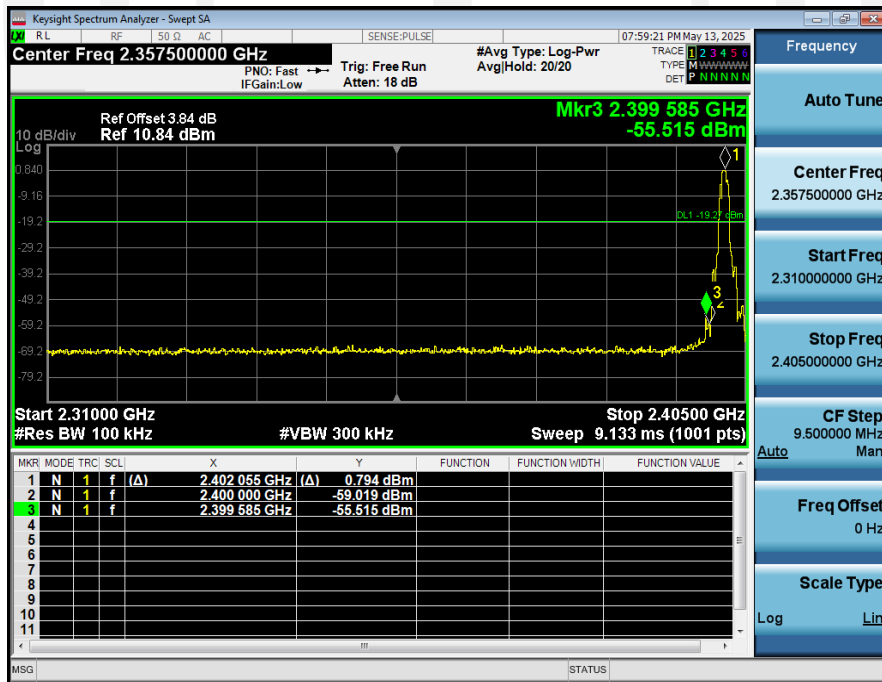



1\_Reference\_Level\_Hopping\_NVNT\_ANT1\_3-DH1\_Hopping

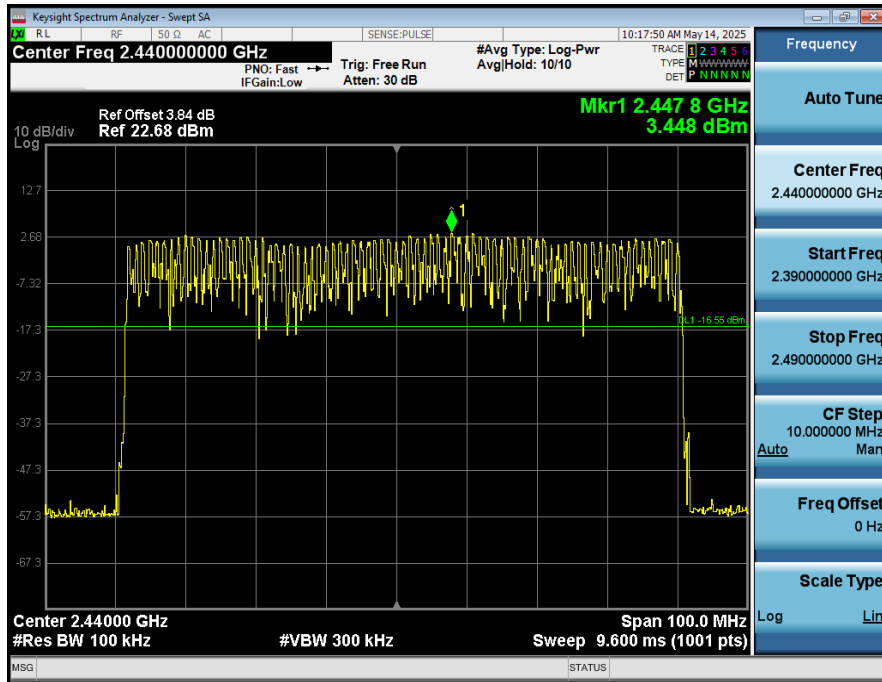

2\_Band\_Edge\_(Hopping)\_NVNT\_ANT1\_3-DH1\_Hopping

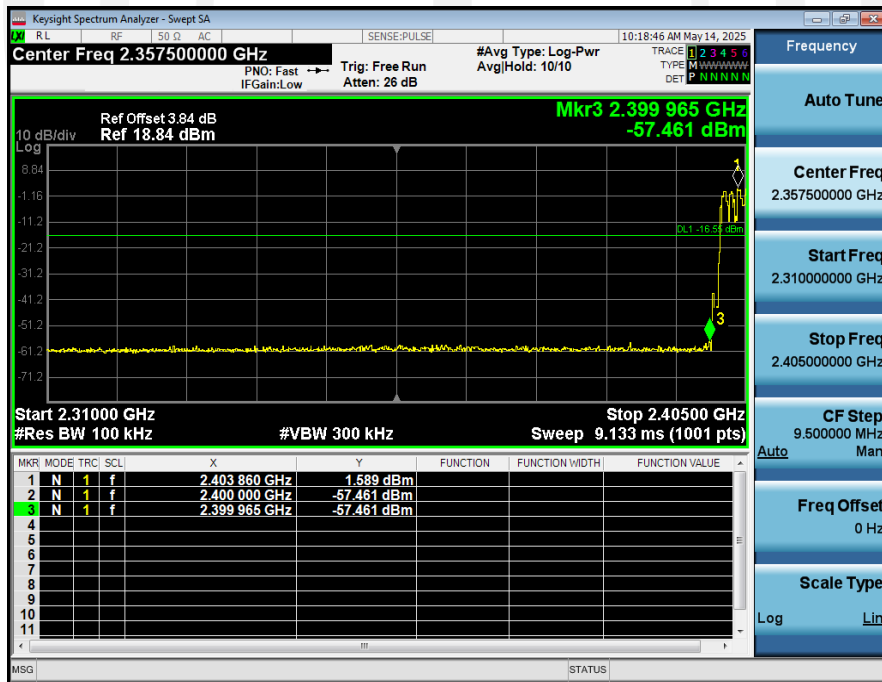

1\_Reference\_Level\_NVNT\_ANT1\_3-DH1\_2480\_00



2\_Bandedge\_NVNT\_ANT1\_3-DH1\_2480\_00

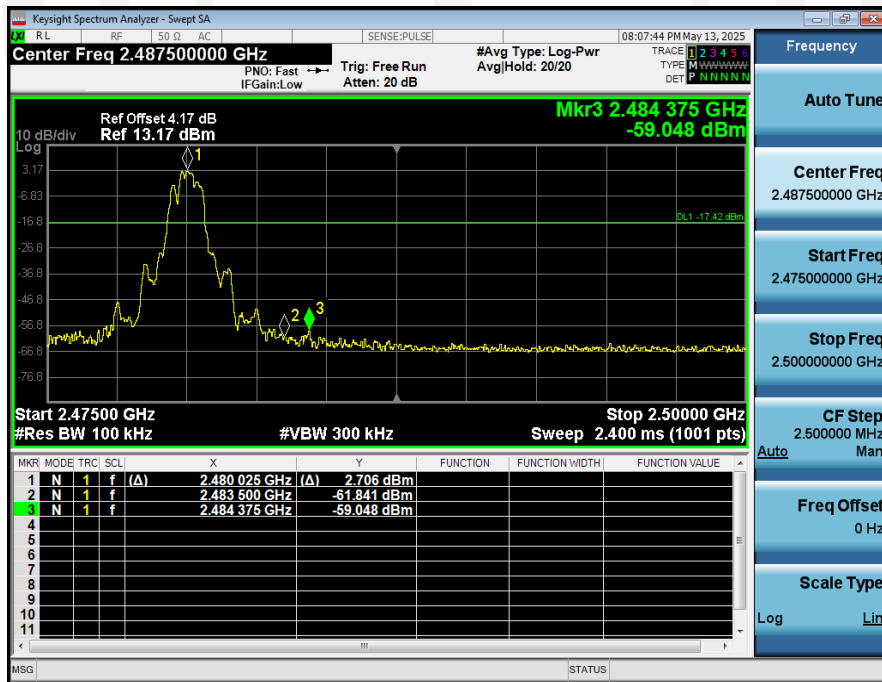

1\_Reference\_Level\_Hopping\_NVNT\_ANT1\_3-DH1\_Hopping

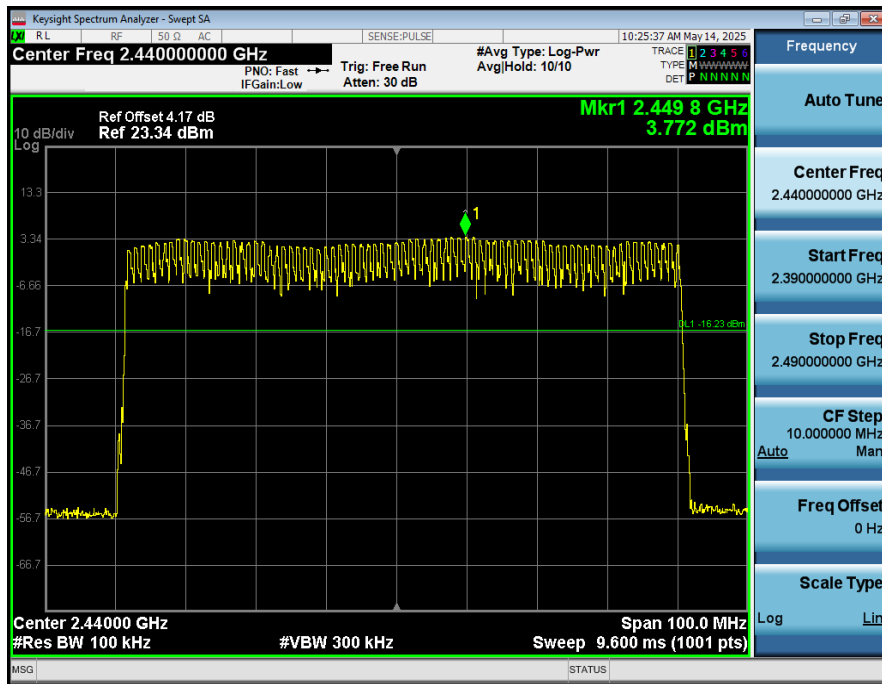

2\_Band\_Edge\_(Hopping)\_NVNT\_ANT1\_3-DH1\_Hopping

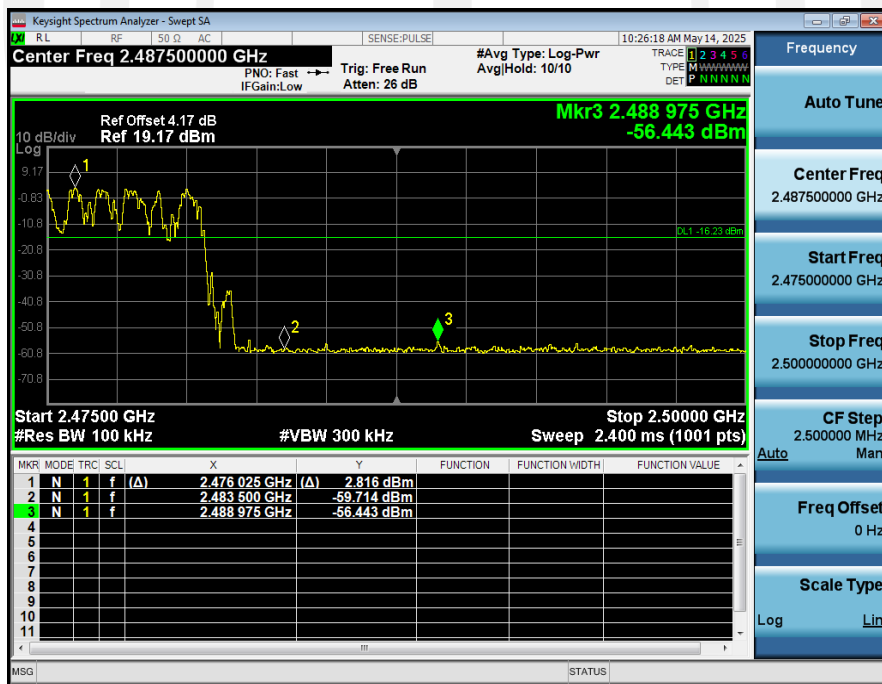

**Conducted spurious emission: Pass**

Condition	Antenna	Modulation	TX Mode	Ref_level(dBm)	Spurious MAX.Value(dBm)	Limit	Result
NVNT	ANT1	1-DH1	2402.00	2.743	-52.801	-17.257	Pass
NVNT	ANT1	1-DH1	2441.00	4.760	-50.405	-15.240	Pass
NVNT	ANT1	1-DH1	2480.00	4.144	-46.115	-15.856	Pass
NVNT	ANT1	2-DH1	2402.00	0.399	-34.339	-19.601	Pass
NVNT	ANT1	2-DH1	2441.00	2.503	-30.041	-17.497	Pass
NVNT	ANT1	2-DH1	2480.00	2.626	-52.559	-17.374	Pass
NVNT	ANT1	3-DH1	2402.00	0.726	-32.423	-19.274	Pass
NVNT	ANT1	3-DH1	2441.00	2.592	-38.795	-17.408	Pass
NVNT	ANT1	3-DH1	2480.00	2.582	-34.066	-17.418	Pass



1\_Reference\_Level\_NVNT\_ANT1\_1-DH1\_2402\_00

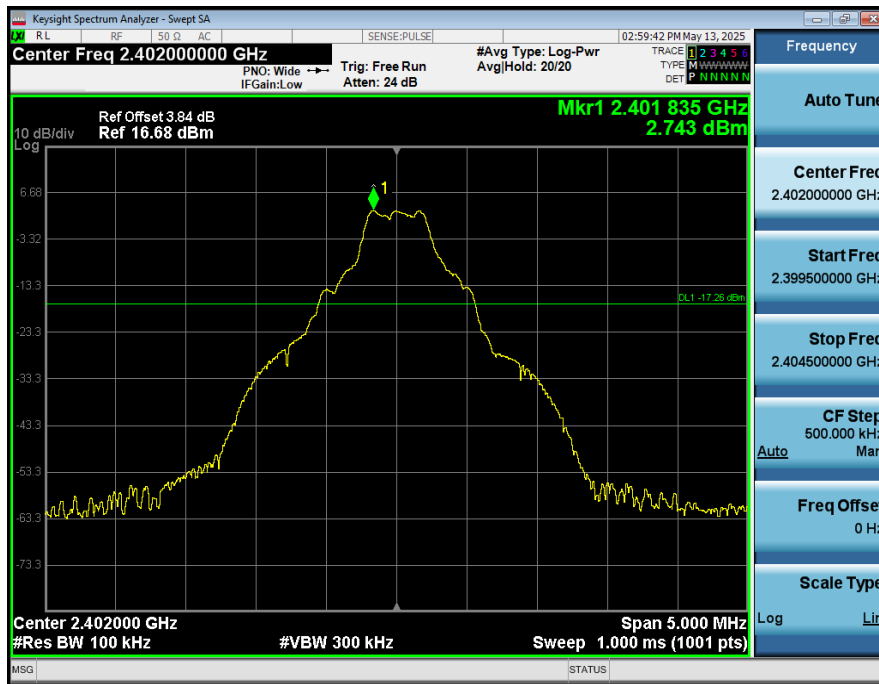

2\_Spurious\_Emissions\_NVNT\_ANT1\_1-DH1\_2402\_00

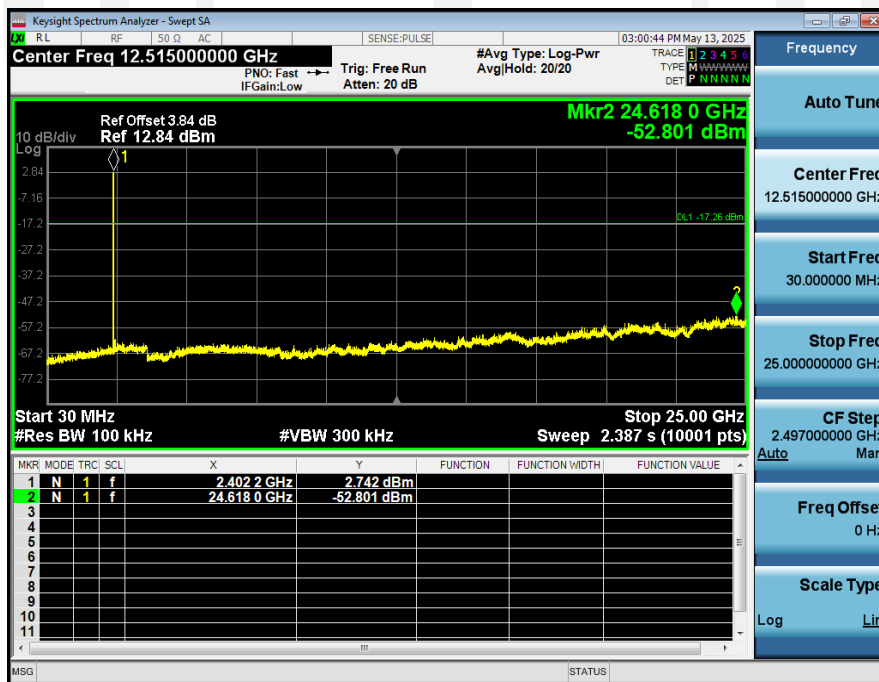

1\_Reference\_Level\_NVNT\_ANT1\_1-DH1\_2441\_00

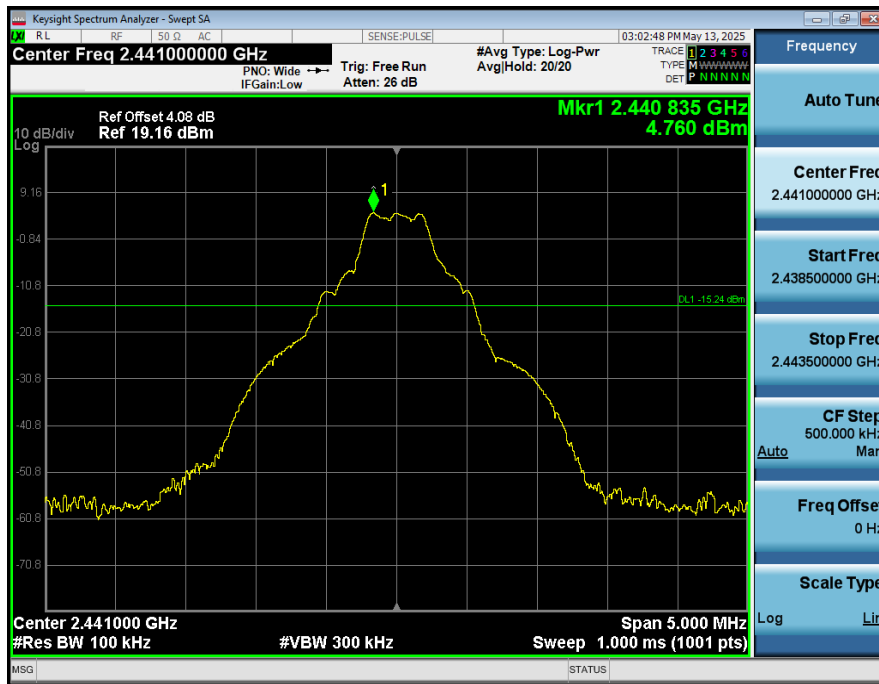

2\_Spurious\_Emissions\_NVNT\_ANT1\_1-DH1\_2441\_00

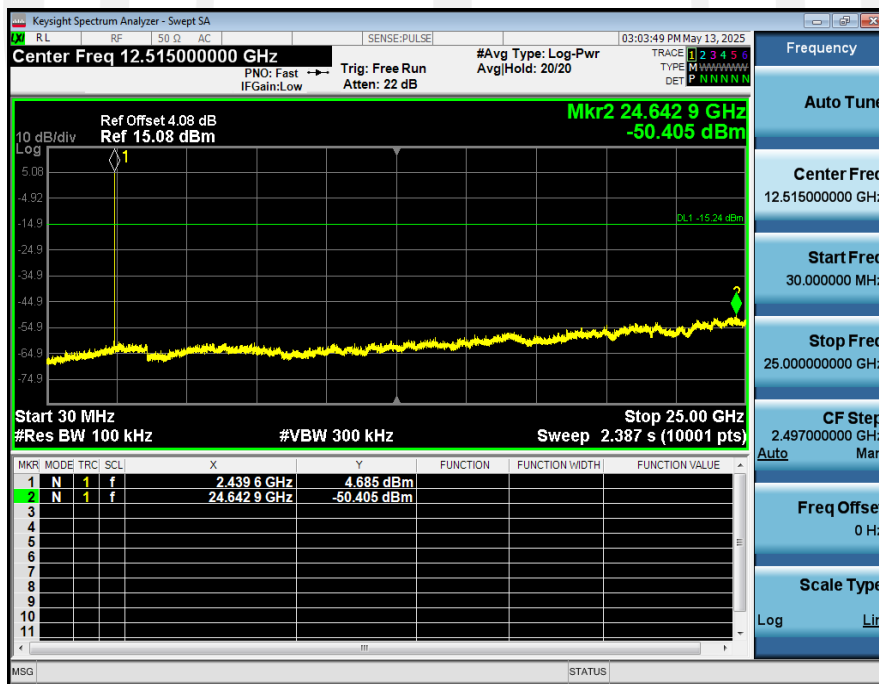

1\_Reference\_Level\_NVNT\_ANT1\_1-DH1\_2480\_00

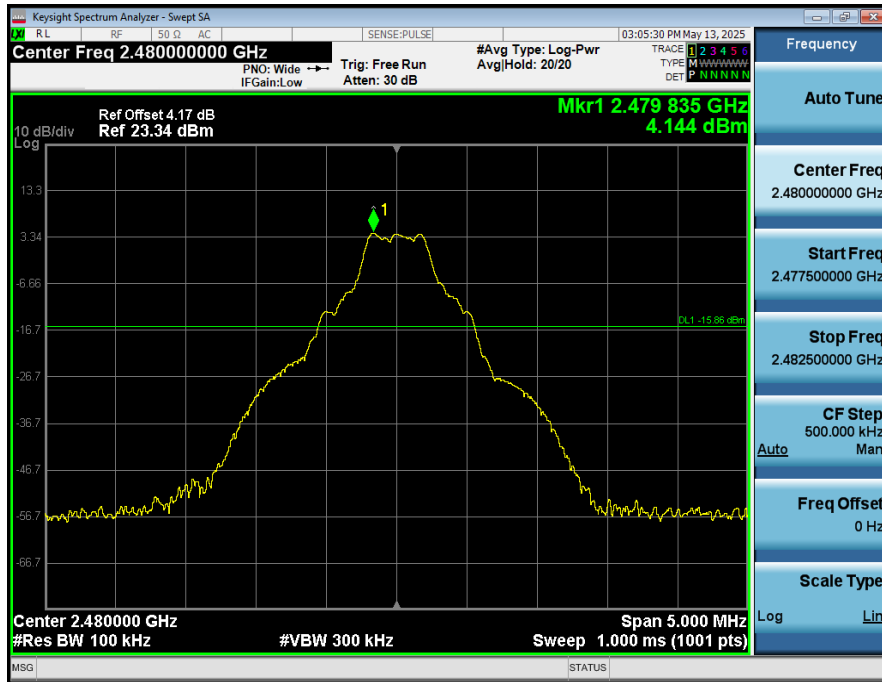

2\_Spurious\_Emissions\_NVNT\_ANT1\_1-DH1\_2480\_00

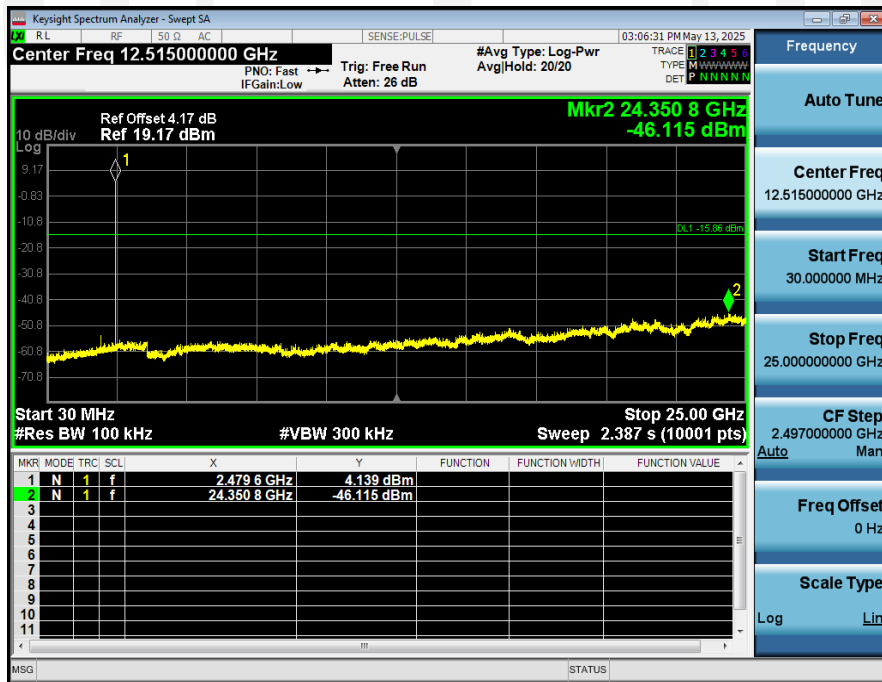

1\_Reference\_Level\_NVNT\_ANT1\_2-DH1\_2402\_00



2\_Spurious\_Emissions\_NVNT\_ANT1\_2-DH1\_2402\_00

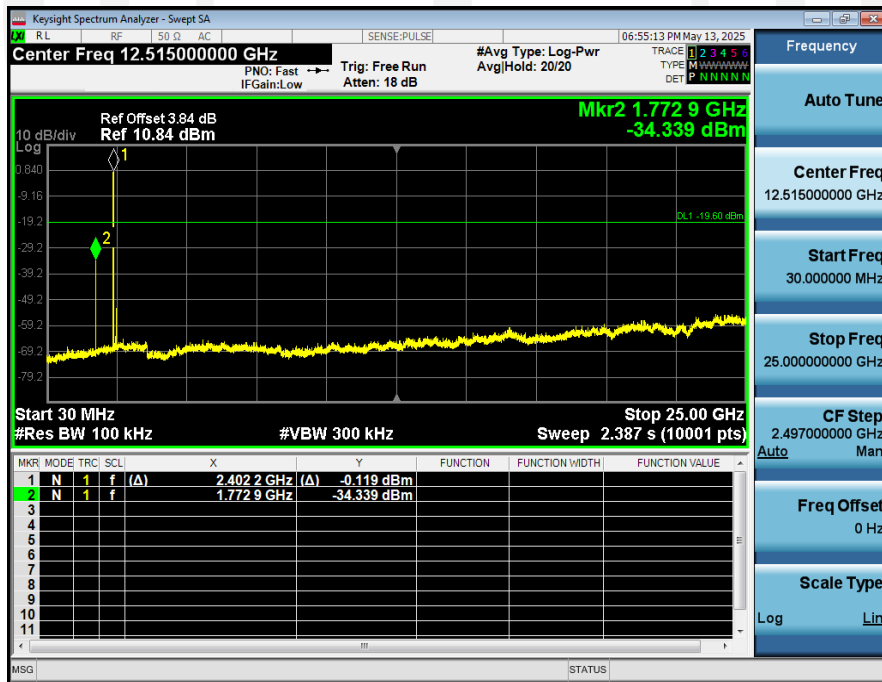



1\_Reference\_Level\_NVNT\_ANT1\_2-DH1\_2441\_00



2\_Spurious\_Emissions\_NVNT\_ANT1\_2-DH1\_2441\_00

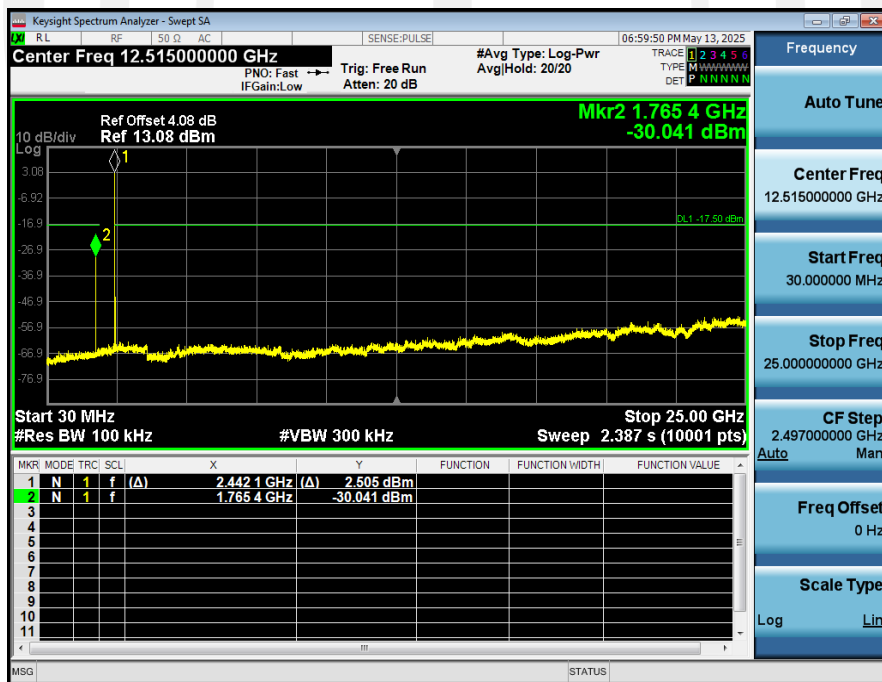

1\_Reference\_Level\_NVNT\_ANT1\_2-DH1\_2480\_00



2\_Spurious\_Emissions\_NVNT\_ANT1\_2-DH1\_2480\_00

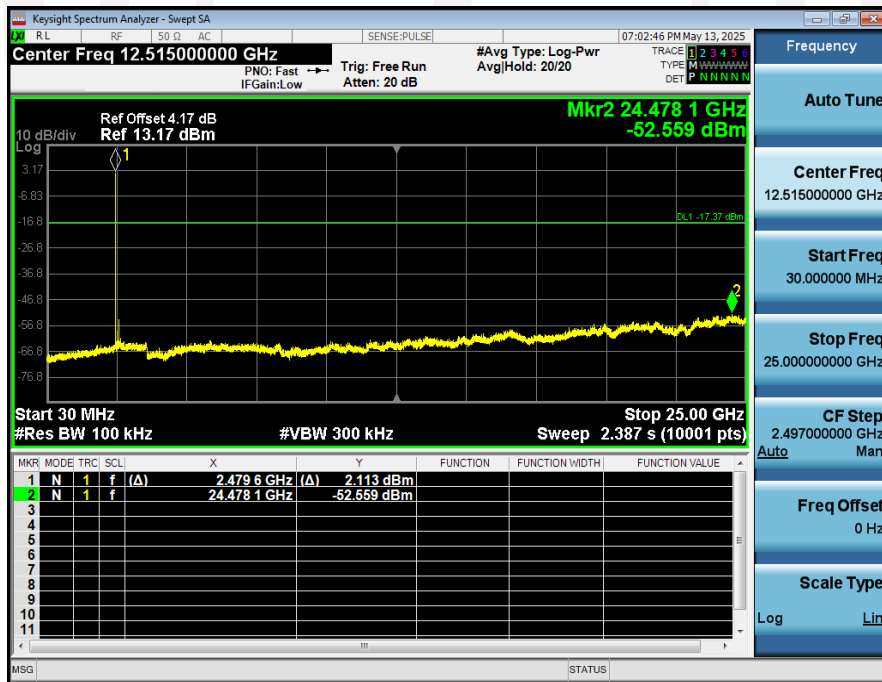

1\_Reference\_Level\_NVNT\_ANT1\_3-DH1\_2402\_00



2\_Spurious\_Emissions\_NVNT\_ANT1\_3-DH1\_2402\_00

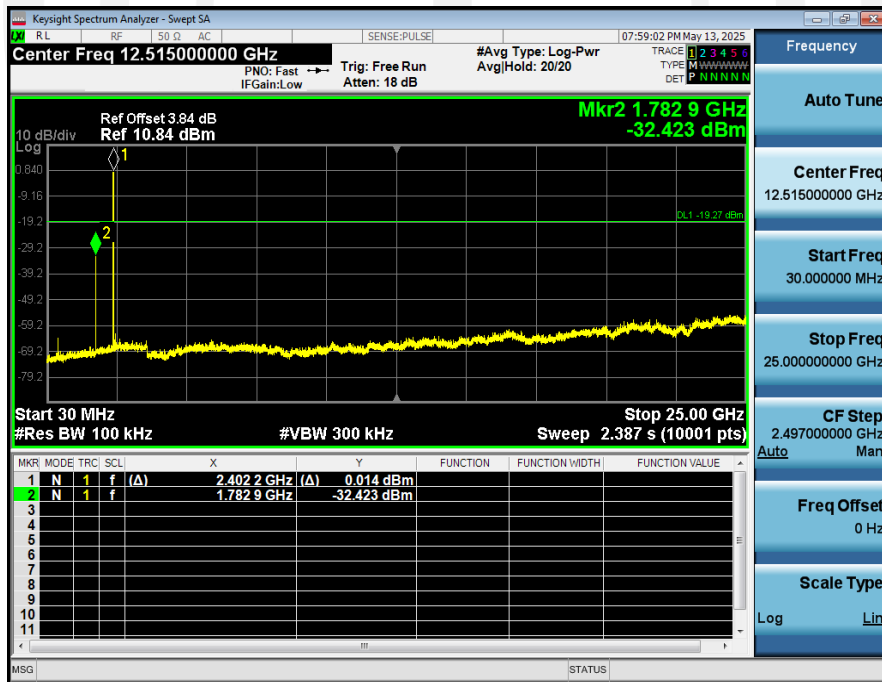

1\_Reference\_Level\_NVNT\_ANT1\_3-DH1\_2441\_00



2\_Spurious\_Emissions\_NVNT\_ANT1\_3-DH1\_2441\_00

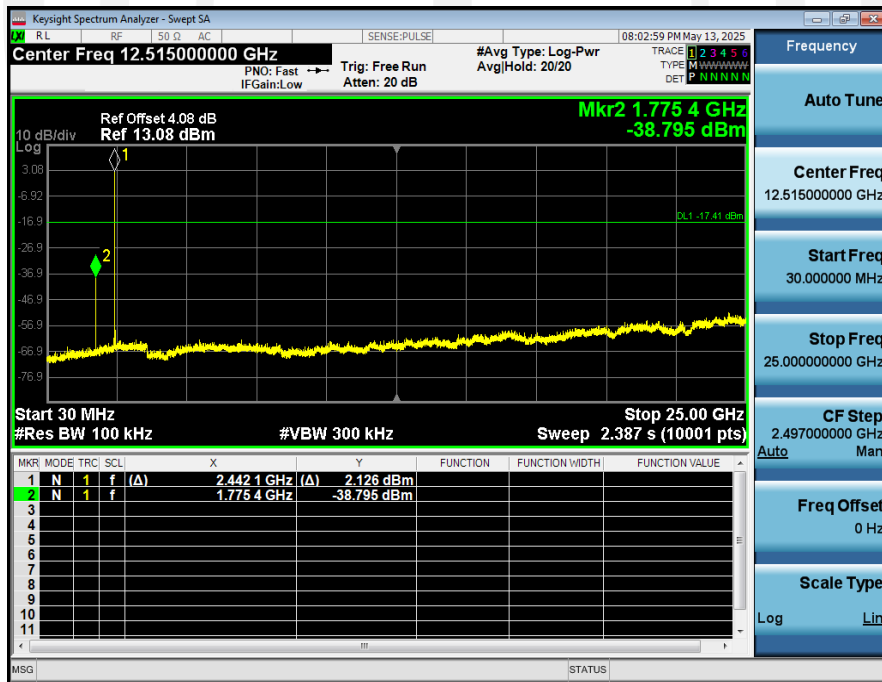

1\_Reference\_Level\_NVNT\_ANT1\_3-DH1\_2480\_00



2\_Spurious\_Emissions\_NVNT\_ANT1\_3-DH1\_2480\_00

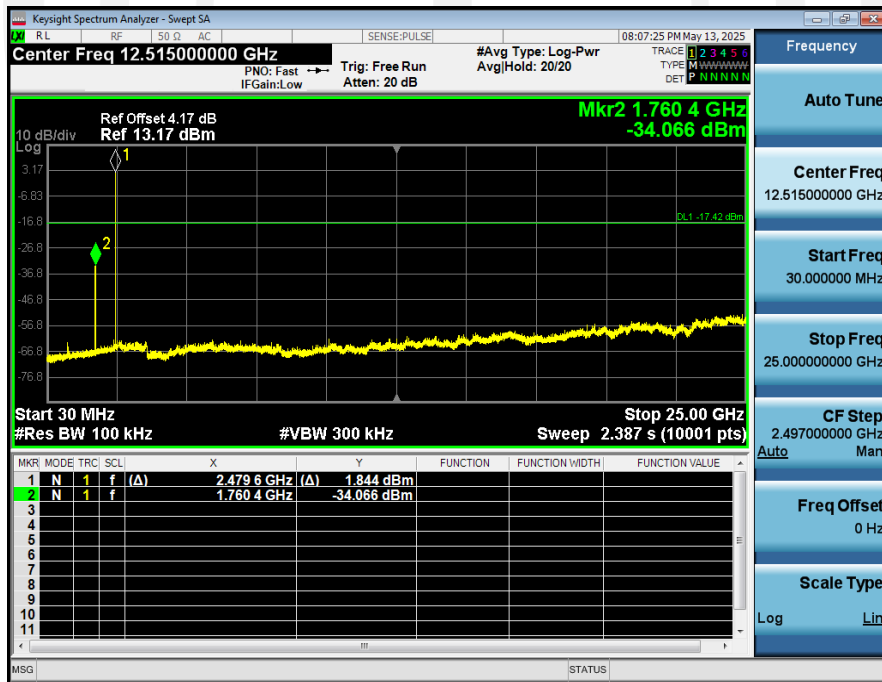

## 9. Radiated Emissions

### 9.1. Limit

All the emissions appearing within 15.205 restricted frequency bands shall not exceed the limits shown in 15.209, all the other emissions shall be at least 20dB below the fundamental emissions, or comply with 15.209 limits.

15.205 Restricted frequency band

MHz	MHz	MHz	GHz
0.090 - 0.110	16.42 - 16.423	399.9 - 410	4.5 - 5.15
<sup>1</sup> 0.495 - 0.505	16.69475 - 16.69525	608 - 614	5.35 - 5.46
2.1735 - 2.1905	16.80425 - 16.80475	960 - 1240	7.25 - 7.75
4.125 - 4.128	25.5 - 25.67	1300 - 1427	8.025 - 8.5
4.17725 - 4.17775	37.5 - 38.25	1435 - 1626.5	9.0 - 9.2
4.20725 - 4.20775	73 - 74.6	1645.5 - 1646.5	9.3 - 9.5
6.215 - 6.218	74.8 - 75.2	1660 - 1710	10.6 - 12.7
6.26775 - 6.26825	108 - 121.94	1718.8 - 1722.2	13.25 - 13.4
6.31175 - 6.31225	123 - 138	2200 - 2300	14.47 - 14.5
8.291 - 8.294	149.9 - 150.05	2310 - 2390	15.35 - 16.2
8.362 - 8.366	156.52475 - 156.52525	2483.5 - 2500	17.7 - 21.4
8.37625 - 8.38675	156.7 - 156.9	2690 - 2900	22.01 - 23.12
8.41425 - 8.41475	162.0125 - 167.17	3260 - 3267	23.6 - 24.0
12.29 - 12.293	167.72 - 173.2	3332 - 3339	31.2 - 31.8
12.51975 - 12.52025	240 - 285	3345.8 - 3358	36.43 - 36.5
12.57675 - 12.57725	322 - 335.4	3600 - 4400	( <sup>2</sup> )

RSS-GEN Restricted frequency band

Table 7 – Restricted frequency bands<sup>Note 1</sup>

MHz	MHz	GHz
0.090 - 0.110	149.9 - 150.05	9.0 - 9.2
0.495 - 0.505	156.52475 - 156.52525	9.3 - 9.5
2.1735 - 2.1905	156.7 - 156.9	10.6 - 12.7
3.020 - 3.026	162.0125 - 167.17	13.25 - 13.4
4.125 - 4.128	167.72 - 173.2	14.47 - 14.5
4.17725 - 4.17775	240 - 285	15.35 - 16.2
4.20725 - 4.20775	322 - 335.4	17.7 - 21.4
5.677 - 5.683	399.9 - 410	22.01 - 23.12
6.215 - 6.218	608 - 614	23.6 - 24.0
6.26775 - 6.26825	960 - 1427	31.2 - 31.8
6.31175 - 6.31225	1435 - 1626.5	36.43 - 36.5

8.291 - 8.294	1645.5 - 1646.5	Above 38.6
8.362 - 8.366	1660 - 1710	
8.37625 - 8.38675	1718.8 - 1722.2	
8.41425 - 8.41475	2200 - 2300	
12.29 - 12.293	2310 - 2390	
12.51975 - 12.52025	2483.5 - 2500	
12.57675 - 12.57725	2655 - 2900	
13.36 - 13.41	3260 - 3267	
16.42 - 16.423	3332 - 3339	
16.69475 - 16.69525	3345.8 - 3358	
16.80425 - 16.80475	3500 - 4400	
25.5 - 25.67	4500 - 5150	
37.5 - 38.25	5350 - 5460	
73 - 74.6	7250 - 7750	
74.8 - 75.2	8025 - 8500	
108 - 138		

Note 1: Certain frequency bands listed in table 7 and in bands above 38.6 GHz are designated for licence-exempt applications. These frequency bands and the requirements that apply to related devices are set out in the 200 and 300 series of RSS.

## 15.209 Limit

FREQUENCY MHz	DISTANCE Meters	FIELD STRENGTHS LIMIT	
		$\mu\text{V}/\text{m}$	$\text{dB}(\mu\text{V})/\text{m}$
0.009-0.490	300	$2400/\text{F}(\text{KHz})$	/
0.490-1.705	30	$24000/\text{F}(\text{KHz})$	/
1.705-30	30	30	29.5
30 ~ 88	3	100	40.0
88 ~ 216	3	150	43.5
216 ~ 960	3	200	46.0
960 ~ 1000	3	500	54.0
Above 1000	3	74.0 $\text{dB}(\mu\text{V})/\text{m}$ (Peak) 54.0 $\text{dB}(\mu\text{V})/\text{m}$ (Average)	

Note: The peak limit is 20 dB higher than the average limit

**Table 5 – General field strength limits at frequencies above 30 MHz**

Frequency (MHz)	Field strength ( $\mu\text{V}/\text{m}$ at 3 m)
30 – 88	100
88 – 216	150
216 – 960	200
Above 960	500

**Table 6 – General field strength limits at frequencies below 30 MHz**

Frequency	Magnetic field strength (H-Field) ( $\mu\text{A}/\text{m}$ )	Measurement distance (m)
9 - 490 kHz <sup>Note 1</sup>	$6.37/\text{F}$ (F in kHz)	300
490 - 1705 kHz	$63.7/\text{F}$ (F in kHz)	30
1.705 - 30 MHz	0.08	30

**Note 1:** The emission limits for the ranges 9-90 kHz and 110-490 kHz are based on measurements employing a linear average detector.



## 9.2. Block Diagram of Test setup

### 9.2.1 In 3m Anechoic Chamber Test Setup Diagram for below 30MHz

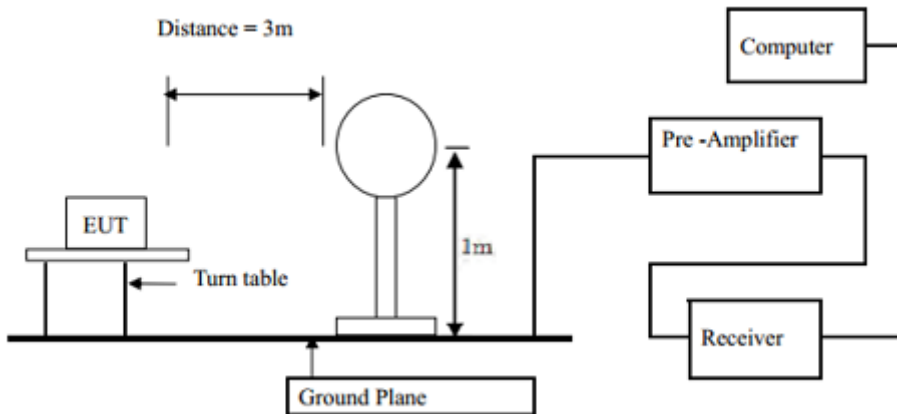

### 9.2.1 In 3m Anechoic Chamber Test Setup Diagram for below 1GHz

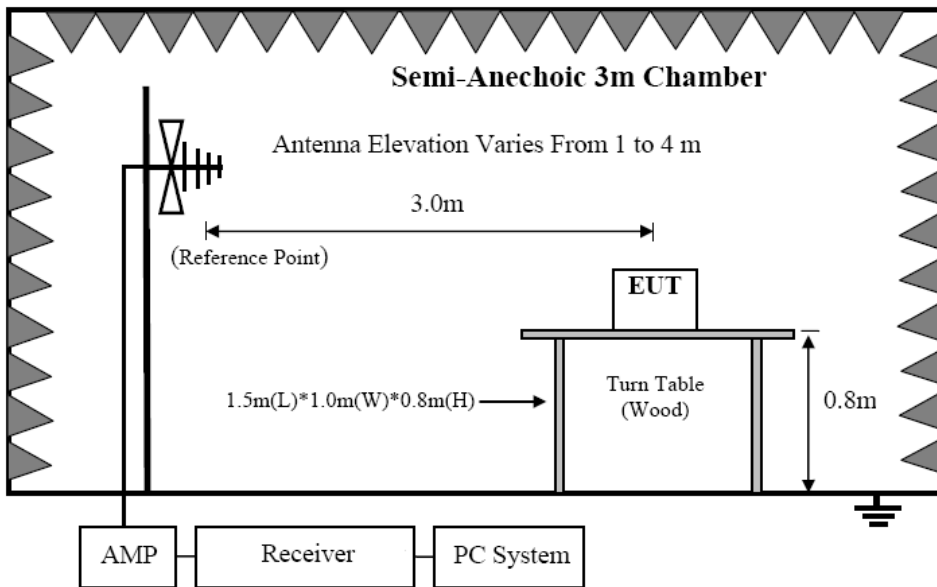

### 9.2.2 In 3m Anechoic Chamber Test Setup Diagram for frequency above 1GHz

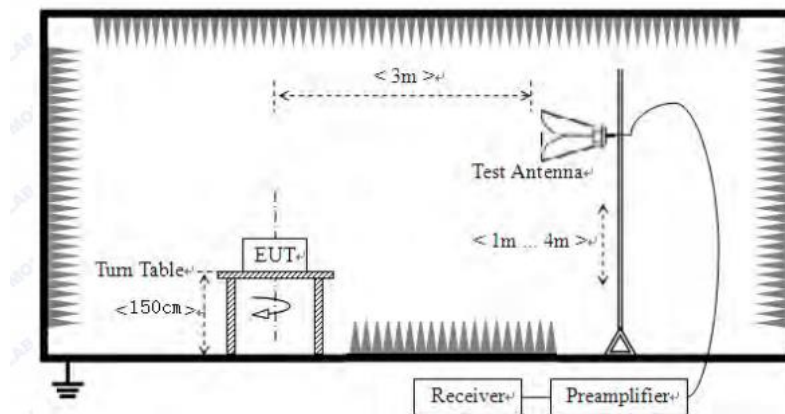

Note: For harmonic emissions test a appropriate high pass filter was inserted in the input port of AMP.

### 9.3. Test Procedure

- (1) EUT was placed on a non-metallic table, 80 cm above the ground plane inside a semi-anechoic chamber.
- (2) Setup EUT and simulator
- (3) Test antenna was located 3m from the EUT on an adjustable mast. Below pre-scan procedure was first performed in order to find prominent radiated emissions.
  - (a) Change work frequency or channel of device if practicable.
  - (b) Change modulation type of device if practicable.
  - (c) Rotated EUT though three orthogonal axes to determine the attitude of EUT arrangement produces highest emissions
- (4) Spectrum frequency from 9KHz to 25GHz (tenth harmonic of fundamental frequency) was investigated
- (5) For final emissions measurements at each frequency of interest, the EUT were rotated and the antenna height was varied between 1m and 4m in order to maximize the emission. Measurements in both horizontal and vertical polarities were made and the data was recorded. In order to find the maximum emission, the relative positions of equipments and all of the interface cables were changed according to ANSI C63.10:2013on Radiated Emission test.
- (6) For emissions above 1GHz, both Peak and Average level were measured with Spectrum Analyzer, and the RBW is set at 1MHz, VBW is set at 3MHz for Peak measure; RBW is set at 1MHz, VBW is set at 10Hz for Average measure.

### 9.4. Test Results

We have scanned from 9kHz to the 10th harmonic of the EUT's highest frequency.

Detailed information please see the following page.

From 9KHz to 30MHz:	
Test Date : 2025.05.12	Temperature : 26°C
Test Engineer : Jensen Wang	Humidity : 54%
Test Mode : GFSK mode	
Test Results : <b>PASS</b>	
Note:	The amplitude of spurious emissions which are attenuated by more than 20dB below the permissible value has no need to be reported.

From 30MHz to 1000MHz:	
Test Date : 2025.05.12	Temperature : 26°C
Test Engineer : Jensen Wang	Humidity : 54%
Test Mode : GFSK mode	
Test Results : <b>PASS</b>	
Note:	<ol style="list-style-type: none"><li>1. The test results are listed in next pages.</li><li>2. If the limits for the measurement with the average detector are met when using a receiver with a peak detector, the test unit shall be deemed to meet both limits and the measurement with the average detector and quasi-peak detector need not be carried out.</li><li>3. All modes have been tested, and only worst data of GFSK mode, Channel 2402MHz (AC 120V/ 60Hz) was listed in this report.</li></ol>



## Polarization: Vertical

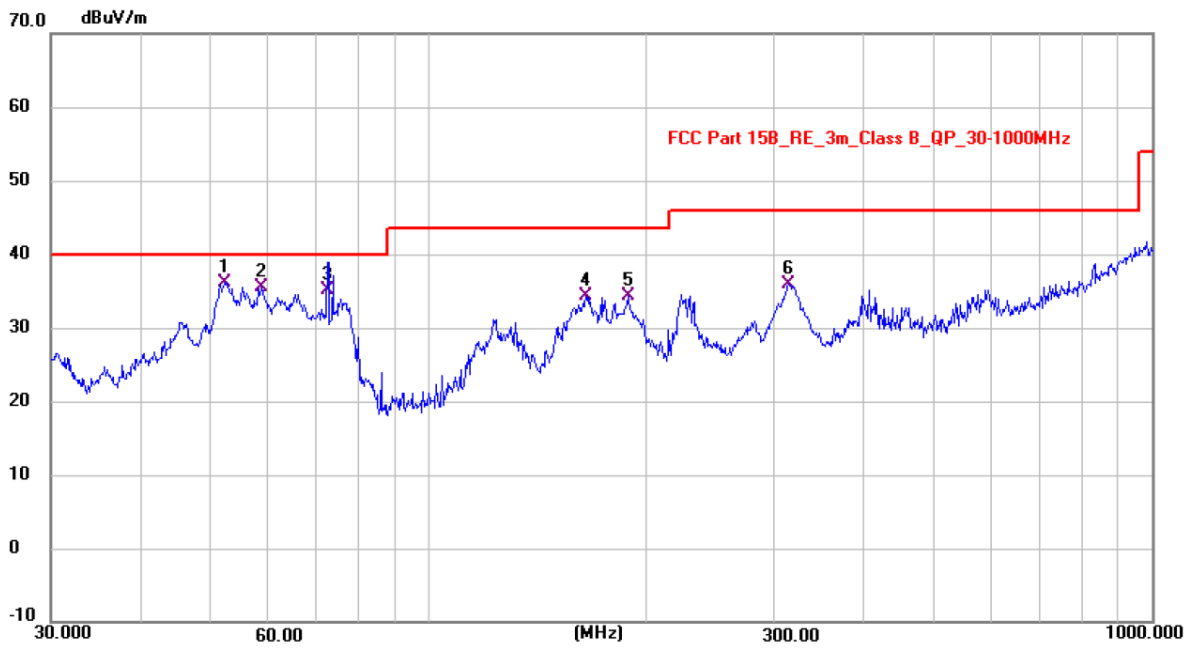

No.	Frequency (MHz)	Reading (dBuV)	Factor (dB/m)	Level (dBuV/m)	Limit (dBuV/m)	Margin (dB)	Detector
1 *	52.2536	22.12	13.91	36.03	40.00	-3.97	QP
2	58.7927	22.33	13.24	35.57	40.00	-4.43	QP
3	72.5885	23.76	11.40	35.16	40.00	-4.84	QP
4	164.9798	20.52	13.86	34.38	43.50	-9.12	QP
5	188.8259	22.43	11.85	34.28	43.50	-9.22	QP
6	314.9281	20.58	15.32	35.90	46.00	-10.10	QP

Note: Level = Reading + Factor Margin = Level - Limit

## Polarization: Horizontal

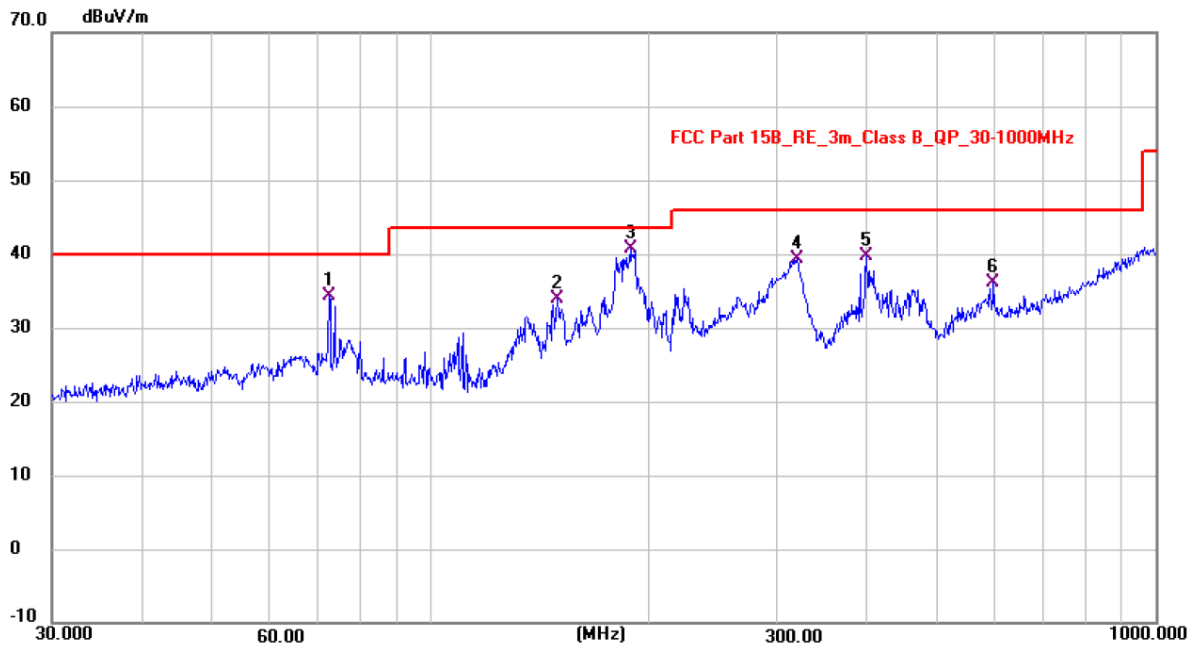

No.	Frequency (MHz)	Reading (dBuV)	Factor (dB/m)	Level (dBuV/m)	Limit (dBuV/m)	Margin (dB)	Detector
1	72.5598	22.89	11.41	34.30	40.00	-5.70	QP
2	149.6824	19.79	14.11	33.90	43.50	-9.60	QP
3 *	188.9086	28.92	11.84	40.76	43.50	-2.74	QP
4	320.0772	23.75	15.47	39.22	46.00	-6.78	QP
5	399.9057	22.05	17.73	39.78	46.00	-6.22	QP
6	598.7960	13.22	22.85	36.07	46.00	-9.93	QP

Note: Level = Reading + Factor Margin = Level - Limit

From 1GHz to 25GHz:	
Test Date : 2025.05.12	Temperature : 26°C
Test Engineer : Jensen Wang	Humidity : 54%
Test Mode : GFSK, $\pi/4$ DQPSK, 8DPSK mode	
Test Results : <b>PASS</b>	
Note:	<ol style="list-style-type: none"><li>1. The test results are listed in next pages.</li><li>2. If the limits for the measurement with the average detector are met when using a receiver with a peak detector, the test unit shall be deemed to meet both limits and the measurement with the average detector and quasi-peak detector need not be carried out.</li><li>3. If the limits for the measurement with the average detector are met when using a receiver with a quasi-peak detector, the test unit shall be deemed to meet both limits and the measurement with the average detector need not be carried out.</li></ol>



Test Mode : GFSK TX Low								
No.	Freq MHz	Polarity	Reading (dBuV/m)	Correct Factor	Result (dBuV/m)	Limit (dBuV/m)	Margin	Remark
1	4804	V	58.73	-13.25	45.48	74.00	-28.52	Peak
2	4804	V	49.54	-13.25	36.29	54.00	-17.71	Avg
3	7206	--	--	--	--	--	--	--
4	9608	--	--	--	--	--	--	--
5	4804	H	57.15	-13.25	43.90	74.00	-30.10	Peak
6	4804	H	45.04	-13.25	31.79	54.00	-22.21	Avg
7	7206	--	--	--	--	--	--	--
8	9608	--	--	--	--	--	--	--
Test Mode : GFSK TX Mid								
1	4882	V	58.95	-12.98	45.97	74.00	-28.03	Peak
2	4882	V	49.12	-12.98	36.14	54.00	-17.86	Avg
3	7323	--	--	--	--	--	--	--
4	9764	--	--	--	--	--	--	--
5	4882	H	57.82	-12.98	44.84	74.00	-29.16	Peak
6	4882	H	46.20	-12.98	33.22	54.00	-20.78	Avg
7	7323	--	--	--	--	--	--	--
8	9764	--	--	--	--	--	--	--
Test Mode : GFSK TX High								
1	4960	V	59.10	-12.70	46.40	74.00	-27.60	Peak
2	4960	V	48.98	-12.70	36.28	54.00	-17.72	Avg
3	7440	--	--	--	--	--	--	--
4	9920	--	--	--	--	--	--	--
5	4960	H	57.37	-12.70	44.67	74.00	-29.33	Peak
6	4960	H	45.36	-12.70	32.66	54.00	-21.34	Avg
7	7440	--	--	--	--	--	--	--
8	9920	--	--	--	--	--	--	--
Note:	1. Means other frequency and mode comply with standard requirements and at least have 20dB margin. 2. Correct Factor=Cable Loss+ Antenna Factor-Amplifier Gain. Result=Reading + Correct Factor. Margin= Result-Limit.							

Test Mode : $\pi/4$ DQPSK TX Low								
No.	Freq MHz	Polarity	Reading (dBuV/m)	Correct Factor	Result (dBuV/m)	Limit (dBuV/m)	Margin	Remark
1	4804	V	60.06	-13.25	46.81	74.00	-27.19	Peak
2	4804	V	48.89	-13.25	35.64	54.00	-18.36	Avg
3	7206	--	--	--	--	--	--	--
4	9608	--	--	--	--	--	--	--
5	4804	H	56.92	-13.25	43.67	74.00	-30.33	Peak
6	4804	H	46.54	-13.25	33.29	54.00	-20.71	Avg
7	7206	--	--	--	--	--	--	--
8	9608	--	--	--	--	--	--	--
Test Mode : $\pi/4$ DQPSK TX Mid								
1	4882	V	56.94	-12.98	43.96	74.00	-30.04	Peak
2	4882	V	46.96	-12.98	33.98	54.00	-20.02	Avg
3	7323	--	--	--	--	--	--	--
4	9764	--	--	--	--	--	--	--
5	4882	H	55.08	-12.98	42.10	74.00	-31.90	Peak
6	4882	H	45.92	-12.98	32.94	54.00	-21.06	Avg
7	7323	--	--	--	--	--	--	--
8	9764	--	--	--	--	--	--	--
Test Mode : $\pi/4$ DQPSK TX High								
1	4960	V	57.23	-12.70	44.53	74.00	-29.47	Peak
2	4960	V	49.89	-12.70	37.19	54.00	-16.81	Avg
3	7440	--	--	--	--	--	--	--
4	9920	--	--	--	--	--	--	--
5	4960	H	57.27	-12.70	44.57	74.00	-29.43	Peak
6	4960	H	44.76	-12.70	32.06	54.00	-21.94	Avg
7	7440	--	--	--	--	--	--	--
8	9920	--	--	--	--	--	--	--
Note:	1. Means other frequency and mode comply with standard requirements and at least have 20dB margin. 2. Correct Factor=Cable Loss+ Antenna Factor-Amplifier Gain. Result=Reading + Correct Factor. Margin= Result-Limit.							



Test Mode : 8DPSK TX Low								
No.	Freq MHz	Polarity	Reading (dBuV/m)	Correct Factor	Result (dBuV/m)	Limit (dBuV/m)	Margin	Remark
1	4804	V	57.89	-13.25	44.64	74.00	-29.36	Peak
2	4804	V	47.50	-13.25	34.25	54.00	-19.75	Avg
3	7206	--	--	--	--	--	--	--
4	9608	--	--	--	--	--	--	--
5	4804	H	56.30	-13.25	43.05	74.00	-30.95	Peak
6	4804	H	48.00	-13.25	34.75	54.00	-19.25	Avg
7	7206	--	--	--	--	--	--	--
8	9608	--	--	--	--	--	--	--
Test Mode : 8DPSK TX Mid								
1	4882	V	56.58	-12.98	43.60	74.00	-30.40	Peak
2	4882	V	50.47	-12.98	37.49	54.00	-16.51	Avg
3	7323	--	--	--	--	--	--	--
4	9764	--	--	--	--	--	--	--
5	4882	H	55.36	-12.98	42.38	74.00	-31.62	Peak
6	4882	H	48.10	-12.98	35.12	54.00	-18.88	Avg
7	7323	--	--	--	--	--	--	--
8	9764	--	--	--	--	--	--	--
Test Mode : 8D PSK TX High								
1	4960	V	57.56	-12.70	44.86	74.00	-29.14	Peak
2	4960	V	50.32	-12.70	37.62	54.00	-16.38	Avg
3	7440	--	--	--	--	--	--	--
4	9920	--	--	--	--	--	--	--
5	4960	H	56.02	-12.70	43.32	74.00	-30.68	Peak
6	4960	H	45.91	-12.70	33.21	54.00	-20.79	Avg
7	7440	--	--	--	--	--	--	--
8	9920	--	--	--	--	--	--	--
Note:	1. Means other frequency and mode comply with standard requirements and at least have 20dB margin. 2. Correct Factor=Cable Loss+ Antenna Factor-Amplifier Gain. Result=Reading + Correct Factor. Margin= Result-Limit.							

## 10. Band Edge Test

### 10.1. Block Diagram of Test Setup

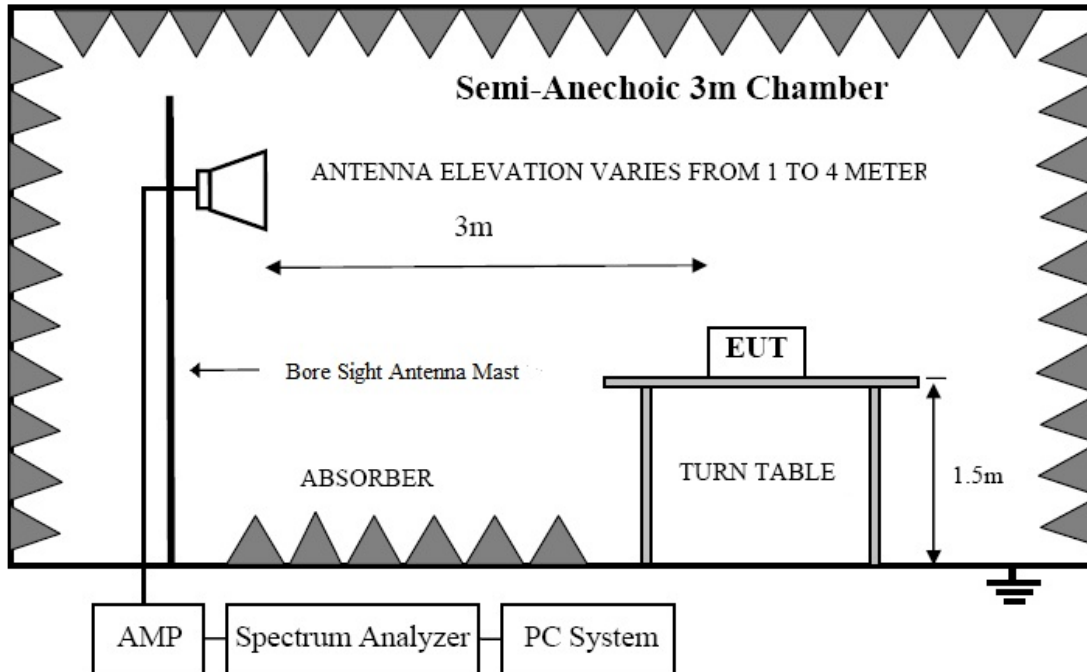

### 10.2. Test Limit

Radiated emissions which fall in the restricted bands, as defined in § 15.205(a), must also comply with the radiated emission limits specified in § 15.209(a) (see § 15.205(c)).

Please refer section RSS-GEN&15.247.

### 10.3. Test Procedure

Refer to ANSI C 63.10, Clause 6.10.

All restriction band and non- restriction band have been tested, only worse case is reported.

## 10.4. Test Results

Test Date	: 2025.05.12	Temperature	: 26°C
Test Engineer	: Jensen Wang	Humidity	: 54%
Test Results	: <b>PASS</b>		

Frequency Range : <b>2310MHz~2410MHz</b>								
Test Mode : GFSK TX 2402MHz								
No.	Freq MHz	Polarity	Reading (dBuV/m)	Correct Factor	Result (dBuV/m)	Limit (dBuV/m)	Margin	Remark
1	2390	H	61.98	-20.45	41.53	74.00	-32.47	Peak
2	2390	H	--	-20.45	--	54.00	--	Avg
3	2400	H	63.13	-20.41	42.72	74.00	-31.28	Peak
4	2400	H	--	-20.41	--	54.00	--	Avg
1	2390	V	63.45	-20.45	43.00	74.00	-31.00	Peak
2	2390	V	--	-20.45	--	54.00	--	Avg
3	2400	V	62.51	-20.41	42.10	74.00	-31.90	Peak
4	2400	V	--	-20.41	--	54.00	--	Avg
Frequency Range : <b>2450MHz~2550MHz</b>								
Test Mode : GFSK TX 2480MHz								
1	2483.5	H	61.13	-20.15	40.98	74.00	-33.02	Peak
2	2483.5	H	--	-20.15	--	54.00	--	Avg
1	2483.5	V	63.57	-20.15	43.42	74.00	-30.58	Peak
2	2483.5	V	--	-20.15	--	54.00	--	Avg
Note:	<p>1. Means other frequency and mode comply with standard requirements and at least have 20dB margin.</p> <p>2. Correct Factor=Cable Loss+ Antenna Factor-Amplifier Gain. Result=Reading + Correct Factor. Margin= Result-Limit.</p> <p>3. If the limits for the measurement with the average detector are met when using a receiver with a peak detector, the test unit shall be deemed to meet both limits and the measurement with the average detector need not be carried out.</p>							

Frequency Range : <b>2310MHz~2410MHz</b>								
Test Mode : $\pi/4$ DQPSK TX 2402MHz								
No.	Freq MHz	Polarity	Reading (dBuV/m)	Correct Factor	Result (dBuV/m)	Limit (dBuV/m)	Margin	Remark
1	2390	H	61.25	-20.45	40.80	74.00	-33.20	Peak
2	2390	H	--	-20.45	--	54.00	--	Avg
3	2400	H	62.12	-20.41	41.71	74.00	-32.29	Peak
4	2400	H	--	-20.41	--	54.00	--	Avg
1	2390	V	61.74	-20.45	41.29	74.00	-32.71	Peak
2	2390	V	--	-20.45	--	54.00	--	Avg
3	2400	V	63.54	-20.41	43.13	74.00	-30.87	Peak
4	2400	V	--	-20.41	--	54.00	--	Avg
Frequency Range : <b>2450MHz~2550MHz</b>								
Test Mode : $\pi/4$ DQPSK TX 2480MHz								
1	2483.5	H	62.86	-20.15	42.71	74.00	-31.29	Peak
2	2483.5	H	--	-20.15	--	54.00	--	Avg
1	2483.5	V	63.33	-20.15	43.18	74.00	-30.82	Peak
2	2483.5	V	--	-20.15	--	54.00	--	Avg
Note:	<p>1. Means other frequency and mode comply with standard requirements and at least have 20dB margin.</p> <p>2. Correct Factor=Cable Loss+ Antenna Factor-Amplifier Gain. Result=Reading + Correct Factor. Margin= Result-Limit.</p> <p>3. If the limits for the measurement with the average detector are met when using a receiver with a peak detector, the test unit shall be deemed to meet both limits and the measurement with the average detector need not be carried out.</p>							

Frequency Range : <b>2310MHz~2410MHz</b>								
Test Mode : 8DPSK TX 2402MHz								
No.	Freq MHz	Polarity	Reading (dBuV/m)	Correct Factor	Result (dBuV/m)	Limit (dBuV/m)	Margin	Remark
1	2390	H	61.21	-20.45	40.76	74.00	-33.24	Peak
2	2390	H	--	-20.45	--	54.00	--	Avg
3	2400	H	64.59	-20.41	44.18	74.00	-29.82	Peak
4	2400	H	--	-20.41	--	54.00	--	Avg
1	2390	V	61.25	-20.45	40.80	74.00	-33.20	Peak
2	2390	V	--	-20.45	--	54.00	--	Avg
3	2400	V	62.20	-20.41	41.79	74.00	-32.21	Peak
4	2400	V	--	-20.41	--	54.00	--	Avg
Frequency Range : <b>2450MHz~2550MHz</b>								
Test Mode : 8DPSK TX 2480MHz								
1	2483.5	H	61.98	-20.15	41.83	74.00	-32.17	Peak
2	2483.5	H	--	-20.15	--	54.00	--	Avg
1	2483.5	V	66.23	-20.15	46.08	74.00	-27.92	Peak
2	2483.5	V	--	-20.15	--	54.00	--	Avg
Note:	<p>1. Means other frequency and mode comply with standard requirements and at least have 20dB margin.</p> <p>2. Correct Factor=Cable Loss+ Antenna Factor-Amplifier Gain. Result=Reading + Correct Factor. Margin= Result-Limit.</p> <p>3. If the limits for the measurement with the average detector are met when using a receiver with a peak detector, the test unit shall be deemed to meet both limits and the measurement with the average detector need not be carried out.</p>							

## 11. Power Line Conducted Emissions

### 11.1. Block Diagram of Test Setup

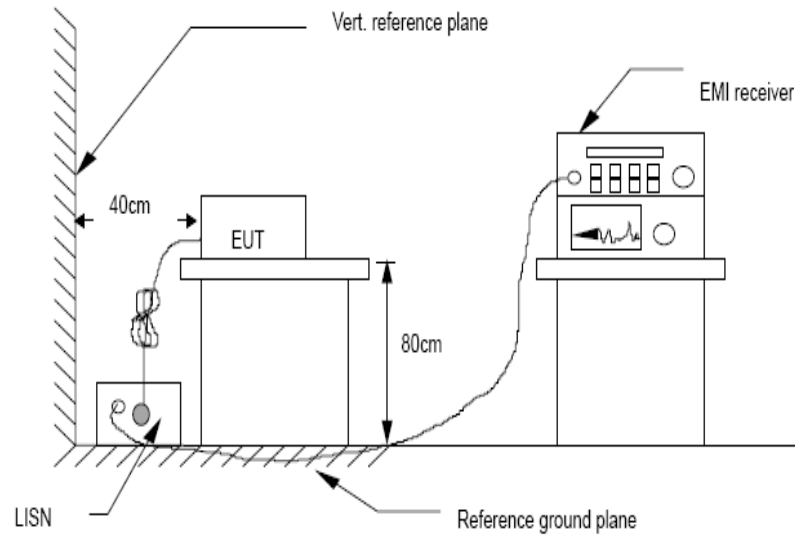

### 11.2. Limit

Frequency	Maximum RF Line Voltage	
	Quasi-Peak Level dB( $\mu$ V)	Average Level dB( $\mu$ V)
150kHz ~ 500kHz	66 ~ 56*	56 ~ 46*
500kHz ~ 5MHz	56	46
5MHz ~ 30MHz	60	50

- Notes: 1. \* Decreasing linearly with logarithm of frequency.  
2. The lower limit shall apply at the transition frequencies.

### 11.3. Test Procedure

- (1) The EUT was placed on a non-metallic table, 80cm above the ground plane.
- (2) Setup the EUT and simulator as shown in 10.1
- (3) The EUT Power connected to the power mains through a power adapter and a line impedance stabilization network (L.I.S.N1). The other peripheral devices power cord connected to the power mains through a line impedance stabilization network (L.I.S.N2), this provided a 50-ohm coupling impedance for the EUT (Please refer to the block diagram of the test setup and photographs). Both sides of power line were checked for maximum conducted interference. In order to find the maximum emission, the relative positions of equipments and all of the interface cables were changed according to ANSI C63.10:2013on conducted Emission test.
- (4) The bandwidth of test receiver is set at 10KHz.
- (5) The frequency range from 150 KHz to 30MHz is checked.

## 11.4. Test Results

Test Date	: 2025.05.12	Temperature	: 24°C
Test Engineer	: Jensen Wang	Humidity	: 56%
Test Mode	: GFSK mode		
Test Results	: <b>PASS</b>		
Note:	<ol style="list-style-type: none"><li>1. The test results are listed in next pages.</li><li>2. If the limits for the measurement with the average detector are met when using a receiver with a peak detector, the test unit shall be deemed to meet both limits and the measurement with the average detector and quasi-peak detector need not be carried out.</li><li>3. If the limits for the measurement with the average detector are met when using a receiver with a quasi-peak detector, the test unit shall be deemed to meet both limits and the measurement with the average detector need not be carried out.</li><li>4. All modes have been tested, and only worst data of GFSK mode, Channel 2402MHz (AC 120V/ 60Hz) was listed in this report.</li></ol>		



## Polarization: L

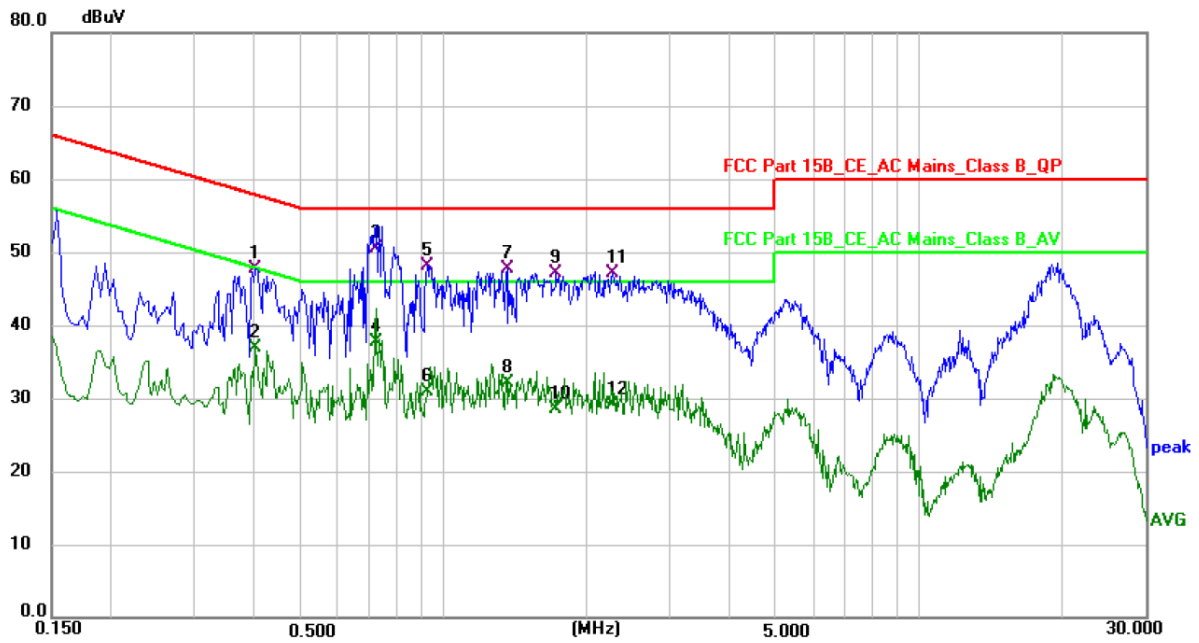

No.	Frequency (MHz)	Reading (dBuV)	Factor (dB)	Level (dBuV)	Limit (dBuV)	Margin (dB)	Detector
1	0.4020	38.14	9.63	47.77	57.81	-10.04	QP
2	0.4020	27.36	9.63	36.99	47.81	-10.82	AVG
3 *	0.7260	41.17	9.43	50.60	56.00	-5.40	QP
4	0.7260	28.29	9.43	37.72	46.00	-8.28	AVG
5	0.9260	38.77	9.41	48.18	56.00	-7.82	QP
6	0.9260	21.57	9.41	30.98	46.00	-15.02	AVG
7	1.3619	38.22	9.40	47.62	56.00	-8.38	QP
8	1.3619	22.61	9.40	32.01	46.00	-13.99	AVG
9	1.7260	37.80	9.40	47.20	56.00	-8.80	QP
10	1.7260	19.16	9.40	28.56	46.00	-17.44	AVG
11	2.2820	37.73	9.39	47.12	56.00	-8.88	QP
12	2.2820	19.74	9.39	29.13	46.00	-16.87	AVG

Note: Level = Reading + Factor Margin = Level - Limit



## Polarization: N

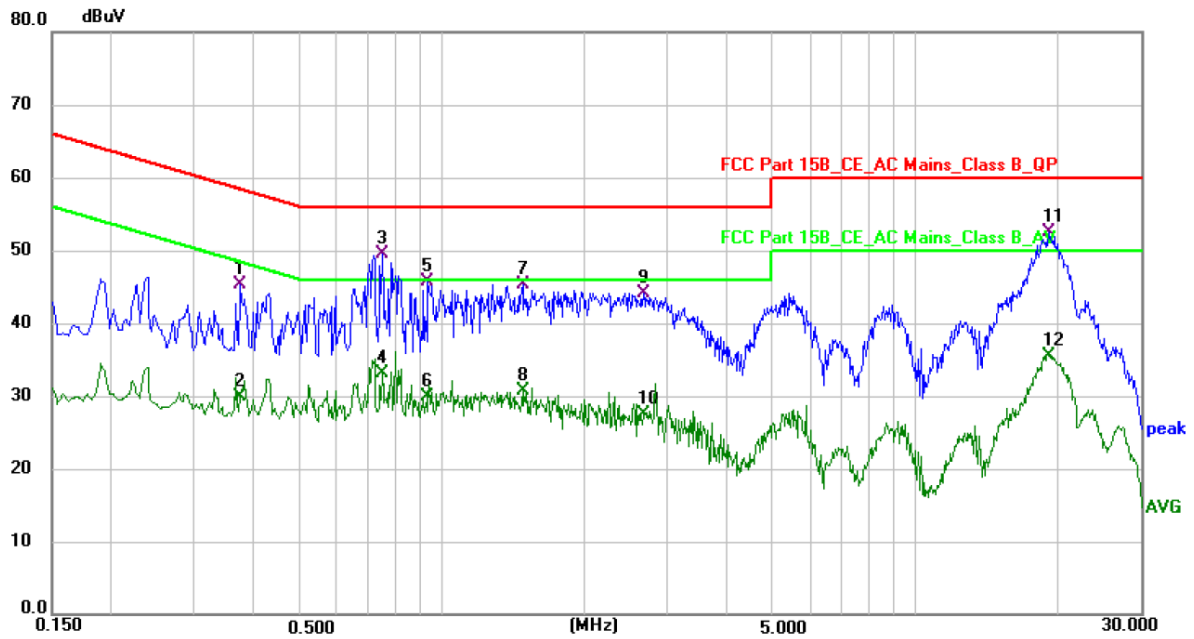

No.	Frequency (MHz)	Reading (dBuV)	Factor (dB)	Level (dBuV)	Limit (dBuV)	Margin (dB)	Detector
1	0.3740	35.75	9.61	45.36	58.41	-13.05	QP
2	0.3740	20.23	9.61	29.84	48.41	-18.57	AVG
3 *	0.7500	39.85	9.73	49.58	56.00	-6.42	QP
4	0.7500	23.47	9.73	33.20	46.00	-12.80	AVG
5	0.9380	36.17	9.57	45.74	56.00	-10.26	QP
6	0.9380	20.34	9.57	29.91	46.00	-16.09	AVG
7	1.4860	36.01	9.39	45.40	56.00	-10.60	QP
8	1.4860	21.26	9.39	30.65	46.00	-15.35	AVG
9	2.6780	34.74	9.46	44.20	56.00	-11.80	QP
10	2.6780	18.03	9.46	27.49	46.00	-18.51	AVG
11	19.1380	42.46	9.99	52.45	60.00	-7.55	QP
12	19.1380	25.55	9.99	35.54	50.00	-14.46	AVG

Note: Level = Reading + Factor Margin = Level - Limit

## 12. Frequency stability

### 12.1. Test limit

Please refer section RSS-Gen.

Regulation RSS-Gen If the frequency stability of the licence-exempt radio apparatus is not specified in the applicable RSS, the fundamental emissions of the radio apparatus should be kept within at least the central 80% of its permitted operating frequency band in order to minimize the possibility of out-of-band operation. In addition, its occupied bandwidth shall be entirely outside the restricted bands and the prohibited TV bands of 54-72 MHz, 76-88 MHz, 174-216 MHz, and 470-602 MHz, unless otherwise indicated.

### 12.2. Test Procedure

The following equipment are installed on the emission measurement to meet the commission requirements and operating regulations in a manner which tends to maximize its emission characteristics in normal application.

### 12.3. Test Setup

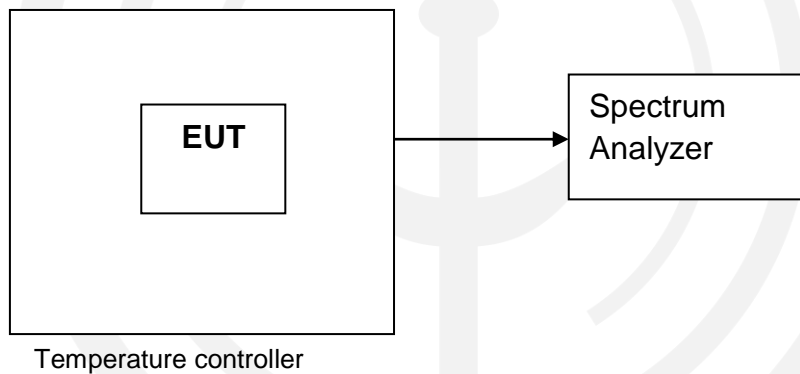

### 12.4. Test Results

Not Applicable.

## 13. Antenna Requirements

### 13.1.Limit

For intentional device, according to FCC 47 CFR Section 15.203 and RSS-GEN, an intentional radiator shall be designed to ensure that no antenna other than that furnished by the responsible party shall be used with the device. And according to FCC 47 CFR Section 15.247 (b), if transmitting antennas of directional gain greater than 6dBi are used, the power shall be reduced by the amount in dB that the directional gain of the antenna exceeds 6dBi.

### 13.2.Result

The EUT antenna is internal antenna. It complies with the standard requirement.



## 14.Photos of test setup

Reference to the **appendix I Test Setup Photo** for details.

## 15.Photos of EUT

Reference to the **appendix II external photos** and **appendix III internal photos** for details.

----- END OF REPORT-----

