

Shenzhen Yangcheng communication antenna Co., LTD

Contact number: 0755-27762026/13510698462

Website: <http://gaozhancheng22.1688.com>

Address: 3rd Floor, No. 24, Wugang Road, Henggang Street,

Longgang District, Shenzhen, Guangdong

2.4G folding glue stick antenna specification

Electrical factor	
Frequency range	2400-2500 MHz
Impedance	50 Ω
VSWR	≤ 2.0
Gain	3dBi
Polarization	perpendicularity
Radiation	omnidirectional
Maximum power input-watts	50W

Mechanical performance	
Dimension	86 \pm 2mm
Connector	
Radome material	TPE.ABS
Radome color	black
Working temperature	-40 $^{\circ}$ C \sim 85 $^{\circ}$ C
Storage temperature	-40 $^{\circ}$ C \sim 90 $^{\circ}$ C

Drawings

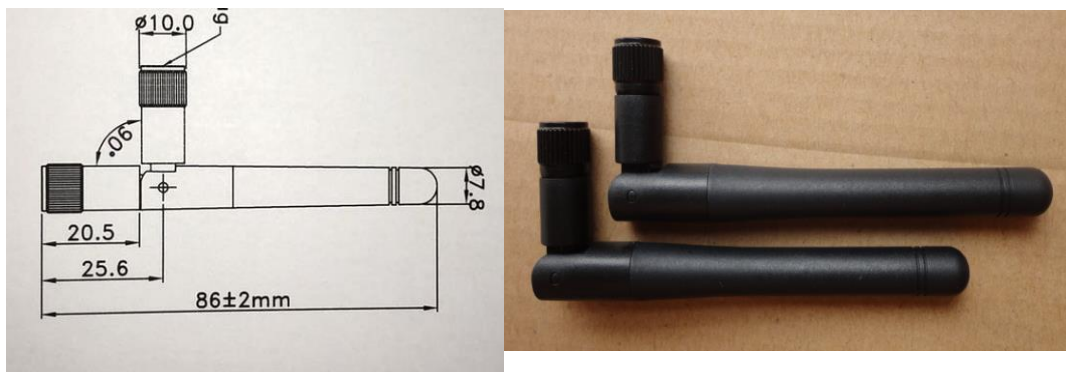

Performance test

1. SMITH

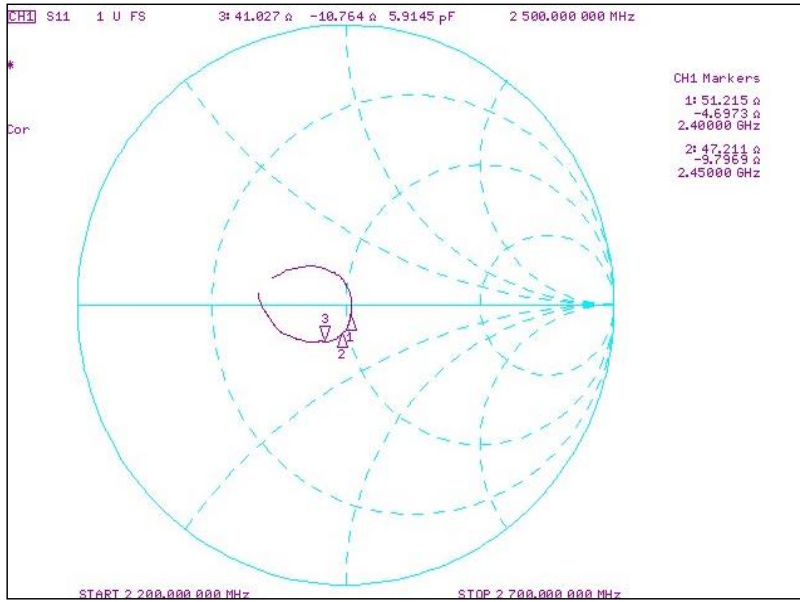

2. VSWR

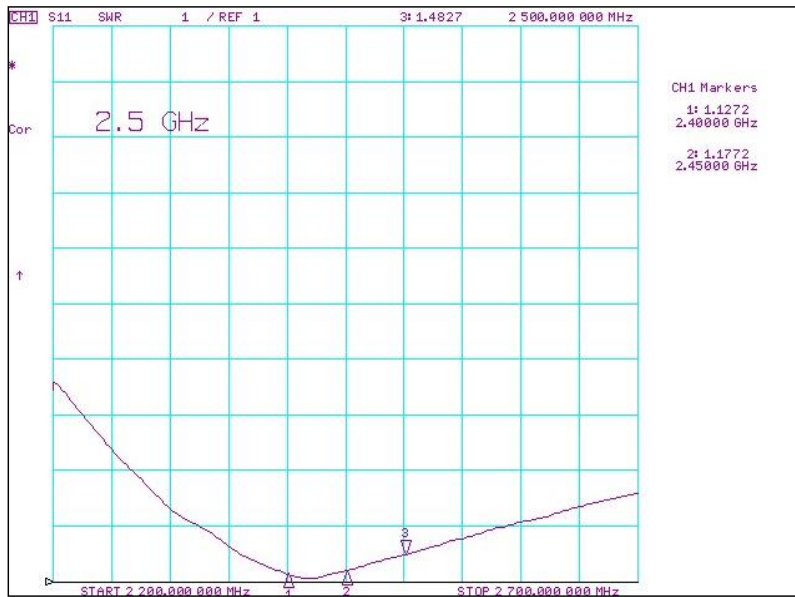

3. RETURN LOSS

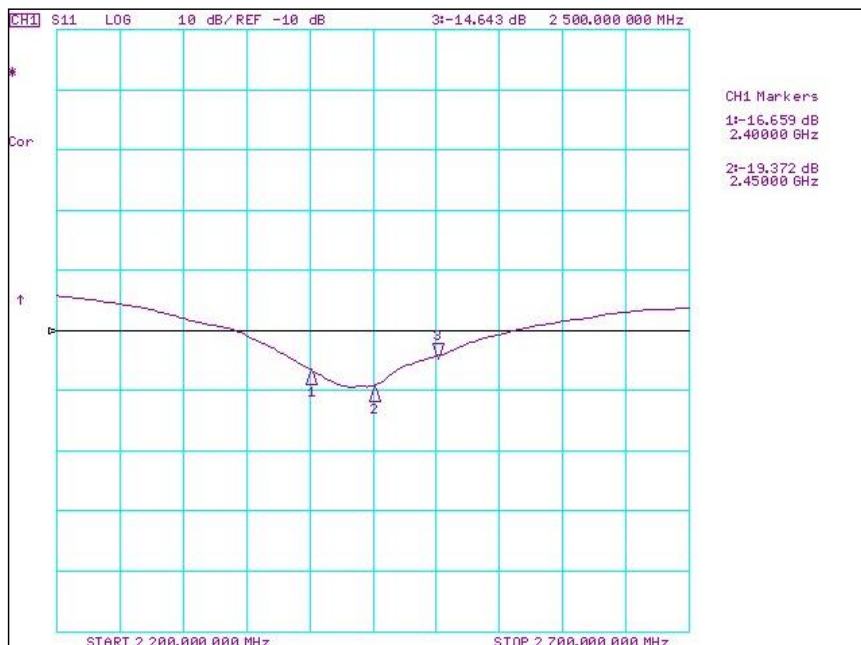

4. PATTERN

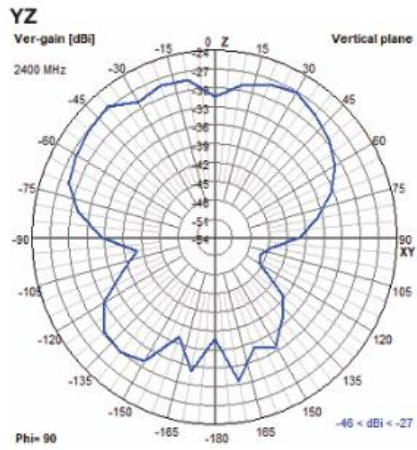
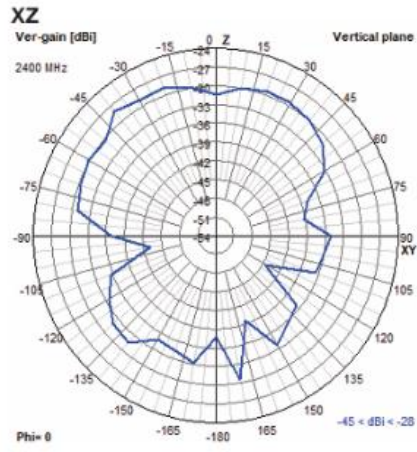
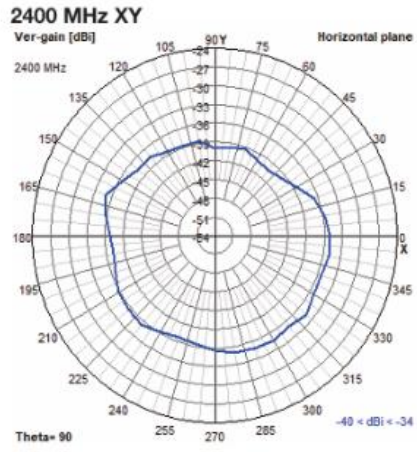

2400 MHz

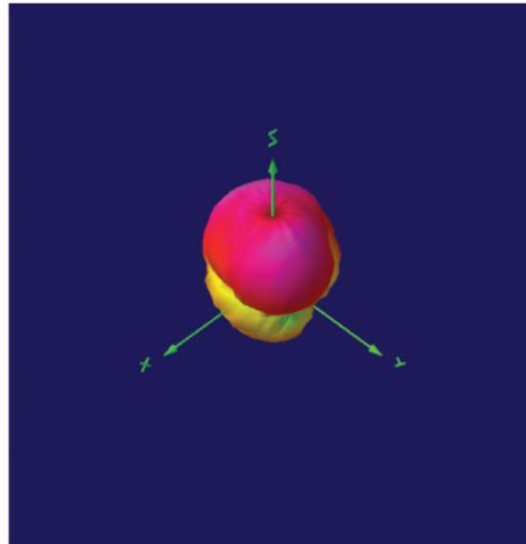

5. Gain&Efficiency

Application	Frequency Range	Efficiency (%)	Maximum VSWR	Peak Gain from highest direction (dBi)
ISM 2.4 GHz	2400 - 2500 MHz	69.31	2.19	3.49
2.4G	2401 - 2483 MHz	69.12	2.04	3.483
2.4G (USA)	2401 - 2473 MHz	69.36	1.93	3.483
2.4G (Japan)	2401 - 2495 MHz	69.16	2.11	3.483