



FCC Radio Test Report

FCC ID: 2BCGWAX10

This report concerns: Class II permissive Change

Project No. : 2311G085D
Equipment : 1) AX1500 Wi-Fi 6 Router
 2) AX1450 Dual Band Wi-Fi 6 Router
Brand Name : tp-link
Test Model : 1) Archer AX10
Series Model : 1) Archer AX1500
 2) Archer AX1450
Applicant : TP-LINK CORPORATION PTE. LTD.
Address : 7 Temasek Boulevard #29-03 Suntec Tower One, Singapore 038987
Manufacturer : TP-LINK CORPORATION PTE. LTD.
Address : 7 Temasek Boulevard #29-03 Suntec Tower One, Singapore 038987
Date of Receipt : Nov. 17, 2023
 Nov. 21, 2024
Date of Test : Dec. 13, 2023 ~ Feb. 05, 2024
 Nov. 26, 2024 ~ Dec. 13, 2024
Issued Date : Jan. 23, 2025
Report Version : R00
Test Sample : Engineering Sample No.: SSL202311163 for conducted,
 SSL202311164 and SSL2024112125 for radiated.
Standard(s) : FCC CFR Title 47, Part 15, Subpart C

The above equipment has been tested and found compliance with the requirement of the relative standards by BTL Inc.

Prepared by : _____
 Antony Liang

Approved by : _____
 Steven Lu

Room 108, Building 2, No. 1, Yile Road, Songshan Lake Zone, Dongguan City, Guangdong
 523000 China.

Tel: +86-769-8318-3000 Web: www.newbtl.com Service mail: btl_qa@newbtl.com

Declaration

BTL represents to the client that testing is done in accordance with standard procedures as applicable and that test instruments used has been calibrated with standards traceable to international standard(s) and/or national standard(s).

BTL's reports apply only to the specific samples tested under conditions. It is manufacture's responsibility to ensure that additional production units of this model are manufactured with the identical electrical and mechanical components. **BTL** assumes no responsibility for the data provided by the customer, any statements, inferences or generalizations drawn by the customer or others from the reports issued by **BTL**.

The report must not be used by the client to claim product certification, approval, or endorsement by NVLAP, NIST, or any agency of the U.S. Government.

This report is the confidential property of the client. As a mutual protection to the clients, the public and ourselves, the test report shall not be reproduced, except in full, without our written approval.

BTL's laboratory quality assurance procedures are in compliance with the ISO/IEC 17025: 2017 requirements, and accredited by the conformity assessment authorities listed in this test report.

BTL is not responsible for the sampling stage, so the results only apply to the sample as received.

The information, data and test plan are provided by manufacturer which may affect the validity of results, so it is manufacturer's responsibility to ensure that the apparatus meets the essential requirements of applied standards and in all the possible configurations as representative of its intended use.

Limitation

For the use of the authority's logo is limited unless the Test Standard(s)/Scope(s)/Item(s) mentioned in this test report is (are) included in the conformity assessment authorities acceptance respective.

Please note that the measurement uncertainty is provided for informational purpose only and are not use in determining the Pass/Fail results.

Table of Contents	Page
REPORT ISSUED HISTORY	6
1 . APPLICABLE STANDARDS	7
2 . SUMMARY OF TEST RESULTS	7
2.1 TEST FACILITY	8
2.2 MEASUREMENT UNCERTAINTY	8
2.3 TEST ENVIRONMENT CONDITIONS	9
3 . GENERAL INFORMATION	10
3.1 GENERAL DESCRIPTION OF EUT	10
3.2 DESCRIPTION OF TEST MODES	12
3.3 PARAMETERS OF TEST SOFTWARE	13
3.4 DUTY CYCLE	14
3.5 BLOCK DIAGRAM SHOWING THE CONFIGURATION OF SYSTEM TESTED	16
3.6 SUPPORT UNITS	16
3.7 CUSTOMER INFORMATION DESCRIPTION	16
4 . AC POWER LINE CONDUCTED EMISSIONS	17
4.1 LIMIT	17
4.2 TEST PROCEDURE	17
4.3 DEVIATION FROM TEST STANDARD	17
4.4 TEST SETUP	18
4.5 EUT OPERATION CONDITIONS	18
4.6 TEST RESULTS	18
5 . RADIATED EMISSIONS	19
5.1 LIMIT	19
5.2 TEST PROCEDURE	20
5.3 DEVIATION FROM TEST STANDARD	21
5.4 TEST SETUP	21
5.5 EUT OPERATION CONDITIONS	24
5.6 TEST RESULTS - 9 KHZ TO 30 MHZ	24
5.7 TEST RESULTS - 30 MHZ TO 1000 MHZ	24
5.8 TEST RESULTS - ABOVE 1000 MHZ	24
6 . BANDWIDTH	25
6.1 LIMIT	25
6.2 TEST PROCEDURE	25

Table of Contents	Page
6.3 DEVIATION FROM STANDARD	25
6.4 TEST SETUP	25
6.5 EUT OPERATION CONDITIONS	25
6.6 TEST RESULTS	25
7 . MAXIMUM OUTPUT POWER	26
7.1 LIMIT	26
7.2 TEST PROCEDURE	26
7.3 DEVIATION FROM STANDARD	26
7.4 TEST SETUP	26
7.5 EUT OPERATION CONDITIONS	26
7.6 TEST RESULTS	26
8 . CONDUCTED SPURIOUS EMISSIONS	27
8.1 LIMIT	27
8.2 TEST PROCEDURE	27
8.3 DEVIATION FROM STANDARD	27
8.4 TEST SETUP	27
8.5 EUT OPERATION CONDITIONS	27
8.6 TEST RESULTS	27
9 . POWER SPECTRAL DENSITY	28
9.1 LIMIT	28
9.2 TEST PROCEDURE	28
9.3 DEVIATION FROM STANDARD	28
9.4 TEST SETUP	28
9.5 EUT OPERATION CONDITIONS	28
9.6 TEST RESULTS	28
10 . MEASUREMENT INSTRUMENTS LIST	29
11 . EUT TEST PHOTO	33
APPENDIX A - AC POWER LINE CONDUCTED EMISSIONS	38
APPENDIX B - RADIATED EMISSION - 9 KHZ TO 30 MHZ	41
APPENDIX C - RADIATED EMISSION - 30 MHZ TO 1000 MHZ	46
APPENDIX D - RADIATED EMISSION- ABOVE 1000 MHZ	49
APPENDIX E - BANDWIDTH	84
APPENDIX F - MAXIMUM OUTPUT POWER	89

Table of Contents**Page****APPENDIX G - CONDUCTED SPURIOUS EMISSIONS****94****APPENDIX H - POWER SPECTRAL DENSITY****111**

REPORT ISSUED HISTORY

Report No.	Version	Description	Issued Date	Note
BTL-FCCP-1-2311G085D	R00	<p>This is a supplementary report to the original test report (BTL-FCCP-1-2311G085).</p> <ol style="list-style-type: none">1. Added the product name and series model.2. Change to FEM is pin to pin, the pin function is exactly the same, and the layout does not change. <p>Based on above described changes, so used product of chip with shielding cover to test the worst case of radiated emissions and recorded. Other are kept the same.</p>	Jan. 23, 2025	Valid

1. APPLICABLE STANDARDS

According to the specifications of the manufacturer, the EUT must comply with the requirements of the following standards:

ANSI C63.10-2013

The following reference test guidance is not within the scope of accreditation of NVLAP:

KDB 558074 D01 15.247 Meas Guidance v05r02

KDB 662911 D01 Multiple Transmitter Output v02r01

2. SUMMARY OF TEST RESULTS

Test procedures according to the technical standard(s):

FCC CFR Title 47, Part 15, Subpart C				
Standard(s) Section	Test Item	Test Result	Judgment	Remark
15.207	AC Power Line Conducted Emissions	APPENDIX A	PASS	-----
15.247(d) 15.205(a) 15.209(a)	Radiated Emissions	APPENDIX B APPENDIX C APPENDIX D	PASS	-----
15.247(a)(2)	Bandwidth	APPENDIX E	PASS	-----
15.247(b)(3)	Maximum Output Power	APPENDIX F	PASS	-----
15.247(d)	Conducted Spurious Emissions	APPENDIX G	PASS	-----
15.247(e)	Power Spectral Density	APPENDIX H	PASS	-----
15.203	Antenna Requirement	-----	PASS	Note(2)

Note:

(1) "N/A" denotes test is not applicable in this test report.

(2) The device what use a permanently attached antenna were considered sufficient to comply with the provisions of 15.203.

2.1 TEST FACILITY

The test facilities used to collect the test data in this report is at the location of No. 3 Jinshagang 1st Rd. Shixia, Dalang Town, Dongguan City, Guangdong 523792.

BTL's Registration Number for FCC: 162128

BTL's Designation Number for FCC: CN5042

2.2 MEASUREMENT UNCERTAINTY

ISO/IEC 17025 requires that an estimate of the measurement uncertainties associated with the emissions test results be included in the report. The measurement uncertainties given below are based on a 95% confidence level (based on a coverage factor (k=2))

The BTL measurement uncertainty as below table:

A. AC power line conducted emissions test:

Test Site	Method	Measurement Frequency Range	U,(dB)
DG-C02	CISPR	150kHz ~ 30MHz	2.60

B. Radiated emissions test:

Test Site	Method	Measurement Frequency Range	U,(dB)
DG-CB01	CISPR	9kHz ~ 30MHz	2.36

Test Site	Method	Measurement Frequency Range	Ant. H / V	U,(dB)
DG-CB03 (3m)	CISPR	30MHz ~ 200MHz	V	4.40
		30MHz ~ 200MHz	H	3.62
		200MHz ~ 1,000MHz	V	4.58
		200MHz ~ 1,000MHz	H	3.98

Test Site	Method	Measurement Frequency Range	U,(dB)
DG-CB03 (3m)	CISPR	1GHz ~ 6GHz	4.08
		6GHz ~ 18GHz	4.62

Test Site	Method	Measurement Frequency Range	U,(dB)
DG-CB03 (1m)	CISPR	18 ~ 26.5 GHz	3.36

C. Other Measurement:

Test Item	Uncertainty
Bandwidth	0.90 %
Maximum Output Power	1.3 dB
Conducted Spurious Emission	1.9 dB
Power Spectral Density	1.4 dB
Temperature	0.8 °C
Humidity	2.2 %

Note: Unless specifically mentioned, the uncertainty of measurement has not been taken into account to declare the compliance or non-compliance to the specification.

2.3 TEST ENVIRONMENT CONDITIONS

Test Item	Temperature	Humidity	Test Voltage	Tested By	Test Date
AC Power Line Conducted Emissions	24°C	58%	AC 120V/60Hz	Hayden Chen	/
Radiated Emissions-9kHz to 30 MHz	22°C	48%	AC 120V/60Hz	Hayden Chen	/
Radiated Emissions-30MHz to 1000MHz	23°C	49%	AC 120V/60Hz	Calvin Wen	Dec. 13, 2024
Radiated Emissions-Above 1000MHz	24°C	46%	AC 120V/60Hz	Berton Luo	/
	23°C	49%	AC 120V/60Hz	Calvin Wen	Dec. 13, 2024
Bandwidth	25°C	49-52%	DC 12V	Steve Zhou	/
Maximum Output Power	24°C	51%	DC 12V	Gene Yang	/
Conducted Spurious Emissions	25°C	49-52%	DC 12V	Steve Zhou	/
Power Spectral Density	25°C	49-52%	DC 12V	Steve Zhou	/

3. GENERAL INFORMATION

3.1 GENERAL DESCRIPTION OF EUT

Equipment	1) AX1500 Wi-Fi 6 Router 2) AX1450 Dual Band Wi-Fi 6 Router
Brand Name	tp-link
Test Model	1) Archer AX10
Series Model	1) Archer AX1500 2) Archer AX1450
Model Difference(s)	Only differ in model name and product name.
Hardware Version	3.0
Software Version	ax10v3-flash-us-ver1-0-0-P1[20230825-rel33060]-ecc
Power Source	DC Voltage supplied from AC adapter. Model: T120100-2B1
Power Rating	I/P: 100-240V~ 50-60Hz 0.3A O/P: 12.0V \square 1.0A
Operation Frequency	2412 MHz ~ 2462 MHz
Modulation Type	IEEE 802.11b: DSSS IEEE 802.11g: OFDM IEEE 802.11n: OFDM
Bit Rate of Transmitter	IEEE 802.11b: 11/5.5/2/1 Mbps IEEE 802.11g: 54/48/36/24/18/12/9/6 Mbps IEEE 802.11n: up to 300 Mbps
Maximum Output Power	IEEE 802.11g: 24.58 dBm (0.2871 W)

Note:

- For a more detailed features description, please refer to the manufacturer's specifications or the user's manual.

2. Channel List:

CH01 - CH11 for IEEE 802.11b, IEEE 802.11g, IEEE 802.11n(HT20) CH03 - CH09 for IEEE 802.11n(HT40)							
Channel	Frequency (MHz)	Channel	Frequency (MHz)	Channel	Frequency (MHz)	Channel	Frequency (MHz)
01	2412	04	2427	07	2442	10	2457
02	2417	05	2432	08	2447	11	2462
03	2422	06	2437	09	2452		

3. Antenna Specification:

Ant.	Manufacturer	P/N	Antenna Type	Connector	Gain (dBi)
1	BIG FIELD GLOBAL PTE. LTD.	3101503966	Dipole	N/A	2
2	BIG FIELD GLOBAL PTE. LTD.	3101504414	Dipole	N/A	2

Note:

- This EUT supports CDD, and all antennas have the same gain, Directional gain = $G_{ANT} + \text{Array Gain}$.
For power measurements, Array Gain=0dB ($N_{ANT} \leq 4$), so the Directional gain=2.
For power spectral density measurements, $N_{ANT}=2$, $N_{SS} = 1$.
So the Directional gain= $G_{ANT} + \text{Array Gain} = G_{ANT} + 10 \log(N_{ANT}/N_{SS}) \text{dBi} = 2 + 10 \log(2/1) \text{dBi} = 5.01$.

4. Table for Antenna Configuration:

Operating Mode	TX Mode	2TX
IEEE 802.11b		V(Ant. 1 + Ant. 2)
IEEE 802.11g		V(Ant. 1 + Ant. 2)
IEEE 802.11n(HT20)		V(Ant. 1 + Ant. 2)
IEEE 802.11n(HT40)		V(Ant. 1 + Ant. 2)

3.2 DESCRIPTION OF TEST MODES

The test system was pre-tested based on the consideration of all possible combinations of EUT operation mode.

Pretest Mode	Description
Mode 1	TX B Mode Channel 01/06/11
Mode 2	TX G Mode Channel 01/06/11
Mode 3	TX N(HT20) Mode Channel 01/06/11
Mode 4	TX N(HT40) Mode Channel 03/06/09
Mode 5	TX B Mode Channel 01/02/06/10/11
Mode 6	TX G Mode Channel 01/02/06/10/11
Mode 7	TX N(HT20) Mode Channel 01/02/06/10/11
Mode 8	TX N(HT40) Mode Channel 03/04/06/09/10
Mode 9	TX G Mode Channel 06

Following mode(s) was (were) found to be the worst case(s) and selected for the final test.

AC power line conducted emissions test	
Final Test Mode	Description
Mode 9	TX G Mode Channel 06

Radiated emissions test - Below 1GHz	
Final Test Mode	Description
Mode 9	TX G Mode Channel 06

Radiated emissions test- Above 1GHz(Harmonic)	
Final Test Mode	Description
Mode 1	TX B Mode Channel 01/06/11
Mode 2	TX G Mode Channel 01/06/11
Mode 3	TX N(HT20) Mode Channel 01/06/11
Mode 4	TX N(HT40) Mode Channel 03/06/09

Radiated emissions test- Above 1GHz(Bandedge)	
Final Test Mode	Description
Mode 5	TX B Mode Channel 01/02/06/10/11
Mode 6	TX G Mode Channel 01/02/06/10/11
Mode 7	TX N(HT20) Mode Channel 01/02/06/10/11
Mode 8	TX N(HT40) Mode Channel 03/04/06/09/10

Conducted test	
Final Test Mode	Description
Mode 1	TX B Mode Channel 01/06/11
Mode 2	TX G Mode Channel 01/06/11
Mode 3	TX N(HT20) Mode Channel 01/06/11
Mode 4	TX N(HT40) Mode Channel 03/06/09

NOTE:

- (1) All the bit rate of transmitter have been tested and found the lowest rate is found to be the worst case and recorded.
- (2) For AC power line conducted emissions and radiated emission below 1 GHz test, the TX G Mode Channel 06 is found to be the worst case and recorded.
- (3) For radiated emission above 1 GHz test, the spurious points of 1GHz~26.5GHz have been pre-tested and in this report only recorded the worst case. The remaining spurious points are all below the limit value of 20dB.
- (4) For radiated emission above 1 GHz test, the polarization of Vertical and Horizontal are evaluated, the worst case is Vertical and recorded.
- (5) The chip of the product with or without a shield cover, so radiated emission and power were evaluated. It found that chip of the product without a shield cover was worst case and record.

3.3 PARAMETERS OF TEST SOFTWARE

Test Software Version	IPOP V4.0		
Frequency (MHz)	2412	2437	2462
IEEE 802.11b	36/40	42/46	36/37
IEEE 802.11g	37/40	52/55	38/41
IEEE 802.11n(HT20)	36/39	53/54	37/38
Frequency (MHz)	2422	2437	2452
IEEE 802.11n(HT40)	35/36	39/40	34/35

3.4 DUTY CYCLE

If duty cycle is $\geq 98\%$, duty factor is not required.
 If duty cycle is $< 98\%$, duty factor shall be considered.
 The output power = measured power + duty factor.

IEEE 802.11b

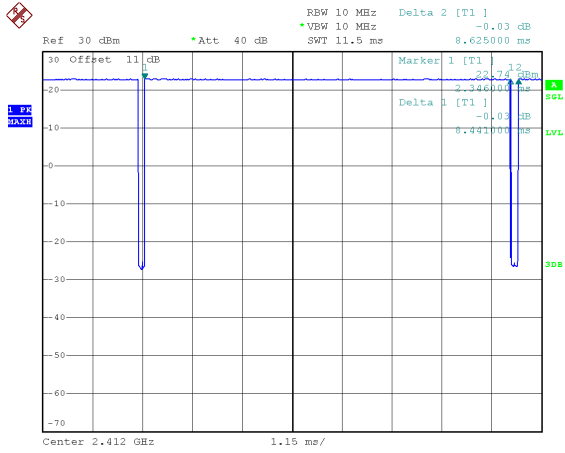

Date: 10.DEC.2023 10:02:20

Duty cycle = $8.441 \text{ ms} / 8.625 \text{ ms} = 97.87\%$
 Duty Factor = $10 \log(1/\text{Duty cycle}) = 0.09$

IEEE 802.11g

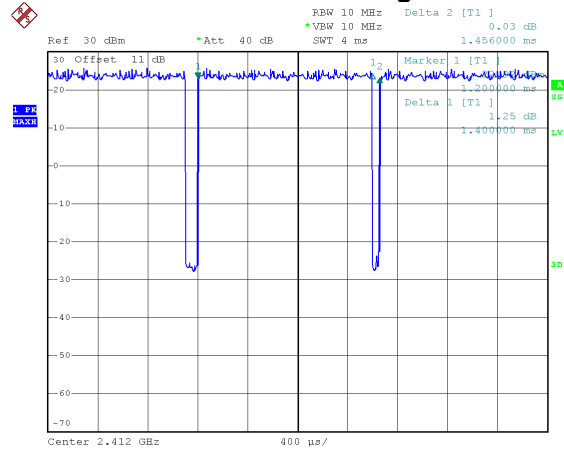

Date: 10.DEC.2023 10:13:14

Duty cycle = $1.400 \text{ ms} / 1.456 \text{ ms} = 96.15\%$
 Duty Factor = $10 \log(1/\text{Duty cycle}) = 0.17$

IEEE 802.11n(HT20)

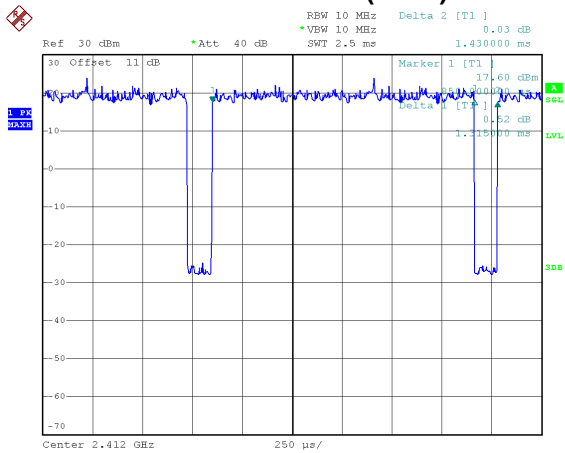

Date: 10.DEC.2023 10:33:26

Duty cycle = $1.135 \text{ ms} / 1.430 \text{ ms} = 91.96\%$
 Duty Factor = $10 \log(1/\text{Duty cycle}) = 0.36$

IEEE 802.11n(HT40)

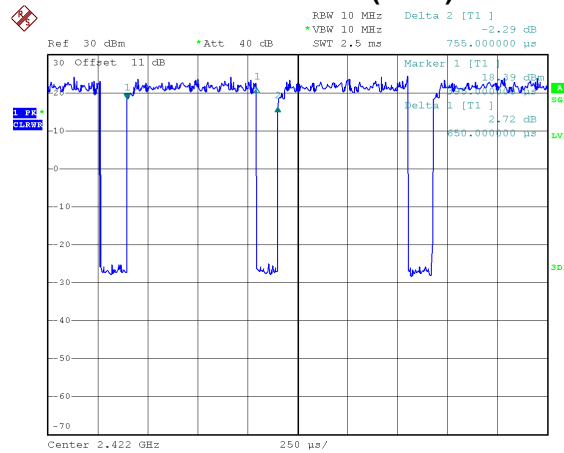

Date: 10.DEC.2023 10:40:00

Duty cycle = $0.650 \text{ ms} / 0.755 \text{ ms} = 86.09\%$
 Duty Factor = $10 \log(1/\text{Duty cycle}) = 0.65$

NOTE:

For IEEE 802.11b:

For radiated emissions frequency above 1 GHz, the resolution bandwidth of test receiver/spectrum analyzer is 1 MHz and the video bandwidth is 118 Hz.

For IEEE 802.11g:

For radiated emissions frequency above 1 GHz, the resolution bandwidth of test receiver/spectrum analyzer is 1 MHz and the video bandwidth is 714 Hz.

For IEEE 802.11n(HT20):

For radiated emissions frequency above 1 GHz, the resolution bandwidth of test receiver/spectrum analyzer is 1 MHz and the video bandwidth is 760 Hz.

For IEEE 802.11n(HT40):

For radiated emissions frequency above 1 GHz, the resolution bandwidth of test receiver/spectrum analyzer is 1 MHz and the video bandwidth is 1538 Hz.

3.5 BLOCK DIAGRAM SHOWING THE CONFIGURATION OF SYSTEM TESTED

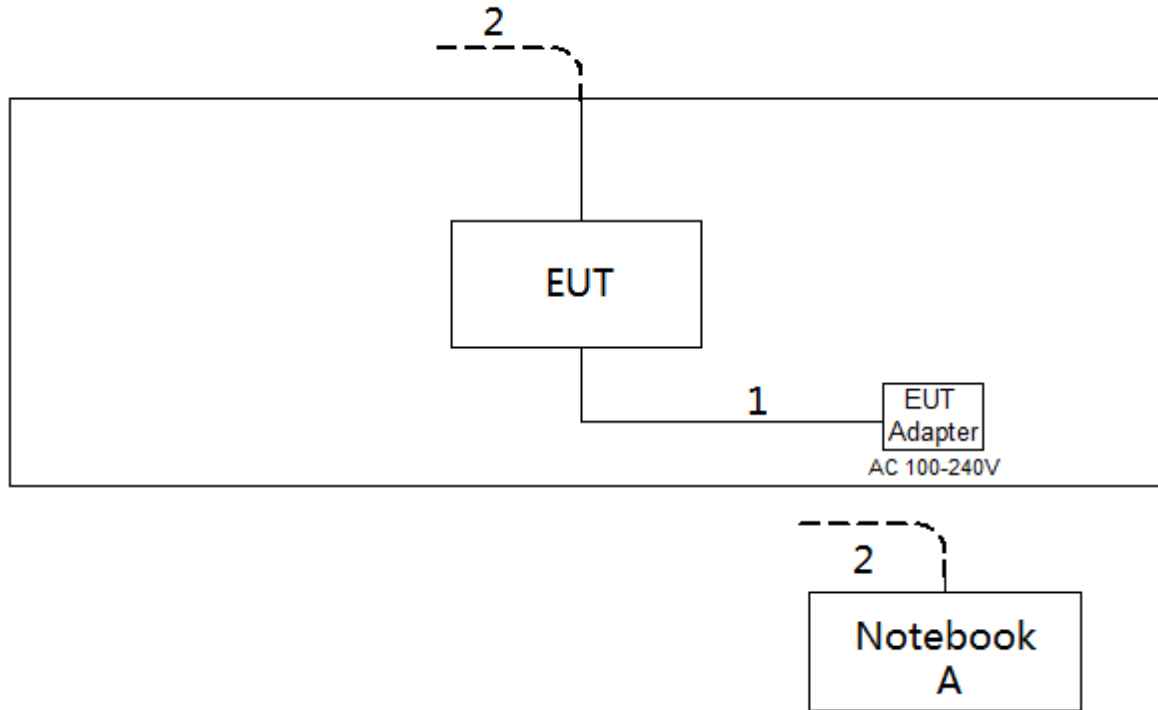

3.6 SUPPORT UNITS

Item	Equipment	Brand	Model No.	Series No.
A	Notebook	Dell	Inspiron 15-7559	N/A

Item	Cable Type	Shielded Type	Ferrite Core	Length
1	DC Cable	NO	NO	1.5m
2	RJ45 Cable	NO	NO	10m

3.7 CUSTOMER INFORMATION DESCRIPTION

- 1) The antenna gain is provided by the manufacturer.
- 2) Except for AC power line conducted emissions and radiated emissions, the results of all test items include cable losses. All cable losses are provided by the testing laboratory.

4. AC POWER LINE CONDUCTED EMISSIONS

4.1 LIMIT

Frequency of Emission (MHz)	Limit (dB μ V)	
	Quasi-peak	Average
0.15 - 0.5	66 to 56*	56 to 46*
0.5 - 5.0	56	46
5.0 - 30.0	60	50

NOTE:

- (1) The tighter limit applies at the band edges.
- (2) The limit of " * " marked band means the limitation decreases linearly with the logarithm of the frequency in the range.

4.2 TEST PROCEDURE

- a. The EUT was placed 0.8 meters from the horizontal ground plane with EUT being connected to the power mains through a line impedance stabilization network (LISN). All other support equipment powered from additional LISN(s). The LISN provide 50 Ohm/ 50uH of coupling impedance for the measuring instrument.
- b. Interconnecting cables that hang closer than 40 cm to the ground plane shall be folded back and forth in the center forming a bundle 30 to 40 cm long.
- c. I/O cables that are not connected to a peripheral shall be bundled in the center. The end of the cable may be terminated, if required, using the correct terminating impedance. The overall length shall not exceed 1 m.
- d. LISN at least 80 cm from nearest part of EUT chassis.
- e. For the actual test configuration, please refer to the related Item -EUT Test Photos.

The following table is the setting of the receiver:

Receiver Parameters	Setting
Start Frequency	0.15 MHz
Stop Frequency	30 MHz
IF Bandwidth	9 kHz

4.3 DEVIATION FROM TEST STANDARD

No deviation.

4.4 TEST SETUP

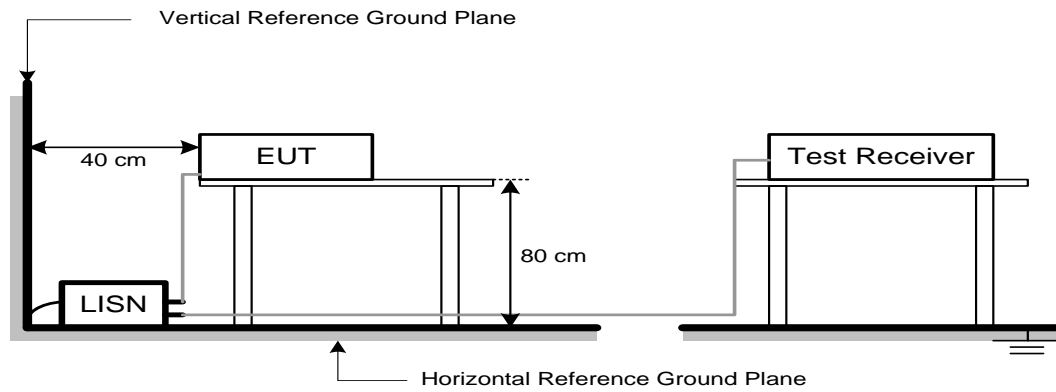

4.5 EUT OPERATION CONDITIONS

EUT was programmed to be in continuously transmitting mode.

4.6 TEST RESULTS

Please refer to the APPENDIX A.

5. RADIATED EMISSIONS

5.1 LIMIT

In case the emission fall within the restricted band specified on 15.205(a), then the 15.209(a) limit in the table below has to be followed.

LIMITS OF RADIATED EMISSION MEASUREMENT (9 kHz-1000 MHz)

Frequency (MHz)	Field Strength (microvolts/meter)	Measurement Distance (meters)
0.009-0.490	2400/F(kHz)	300
0.490-1.705	24000/F(kHz)	30
1.705-30.0	30	30
30-88	100	3
88-216	150	3
216-960	200	3
Above 960	500	3

LIMITS OF RADIATED EMISSION MEASUREMENT (Above 1000 MHz)

Frequency (MHz)	Band edge/ Harmonic at 3m (dB μ V/m)		Harmonic at 1m (dB μ V/m)	
	Peak	Average	Peak	Average
Above 1000	74	54	83.5 (Note 4)	63.5 (Note 4)

NOTE:

- (1) The limit for radiated test was performed according to FCC CFR Title 47, Part 15, Subpart C.
- (2) The tighter limit applies at the band edges.
- (3) Emission level (dB μ V/m)=20log Emission level (uV/m).
- (4)

$$FS_{\text{limit}} = FS_{\text{max}} - 20 \log \left(\frac{d_{\text{limit}}}{d_{\text{measure}}} \right)$$

$20 \log (d_{\text{limit}}/d_{\text{measure}}) = 20 \log (3/1) = 9.5 \text{ dB}$.

FS_{limit} : Harmonic at 3m Peak and Average limit.

FS_{max} : Harmonic at 1m Peak and Average Maximum value.

d_{limit} : Harmonic at 3m test distance.

d_{measure} : Harmonic Actual test distance.

5.2 TEST PROCEDURE

- a. The measuring distance of 3 m shall be used for measurements. The EUT was placed on the top of a rotating table 0.8 meter above the ground at a 3 meter semi-anechoic chamber. The table was rotated 360 degrees to determine the position of the highest radiation.(below 1 GHz)
- b. The measuring distance of 3 m or 1m shall be used for measurements. The EUT was placed on the top of a rotating table 1.5 meter above the ground at a 3 meter semi-anechoic chamber. The table was rotated 360 degrees to determine the position of the highest radiation.(above 1GHz)
- c. The height of the equipment or of the substitution antenna shall be 0.8m or 1.5m; the height of the test antenna shall vary between 1 m to 4 m. Both horizontal and vertical polarizations of the antenna are set to make the measurement.
- d. For each suspected emission, the EUT was arranged to its worst case and then the antenna was tuned to heights find the maximum reading (used Bore sight function).
- e. The receiver system was set to peak and average detect function and specified bandwidth with maximum hold mode when the test frequency is above 1 GHz.
- f. The initial step in collecting radiated emission data is a receiver peak detector mode pre-scanning the measurement frequency range. Significant peaks are then marked and then Quasi Peak detector mode re-measured.
- g. All readings are Peak unless otherwise stated QP in column of Note. Peak denotes that the Peak reading compliance with the QP Limits and then QP Mode measurement didn't perform. (below 1 GHz)
- h. All readings are Peak Mode value unless otherwise stated AVG in column of Note. If the Peak Mode Measured value compliance with the Peak Limits and lower than AVG Limits, the EUT shall be deemed to meet both Peak & AVG Limits and then only Peak Mode was measured, but AVG Mode didn't perform. (above 1 GHz)
- i. For the actual test configuration, please refer to the related Item -EUT Test Photos.

The following table is the setting of the receiver:

Spectrum Parameters	Setting
Start ~ Stop Frequency	9 kHz~150 kHz for RBW 200 Hz
Start ~ Stop Frequency	0.15 MHz~30 MHz for RBW 9 kHz
Start ~ Stop Frequency	30 MHz~1000 MHz for RBW 100 kHz

Spectrum Parameters	Setting
Start Frequency	1000 MHz
Stop Frequency	10th carrier harmonic
RBW / VBW (Emission in restricted band)	1 MHz / 3 MHz for PK value 1 MHz / 1/T Hz for AVG value

Receiver Parameters	Setting
Start ~ Stop Frequency	9 kHz~90 kHz for PK/AVG detector
Start ~ Stop Frequency	90 kHz~110 kHz for QP detector
Start ~ Stop Frequency	110 kHz~490 kHz for PK/AVG detector
Start ~ Stop Frequency	490 kHz~30 MHz for QP detector
Start ~ Stop Frequency	30 MHz~1000 MHz for QP detector
Start ~ Stop Frequency	1 GHz~26.5 GHz for PK/AVG detector

5.3 DEVIATION FROM TEST STANDARD

No deviation.

5.4 TEST SETUP

9 kHz to 30 MHz

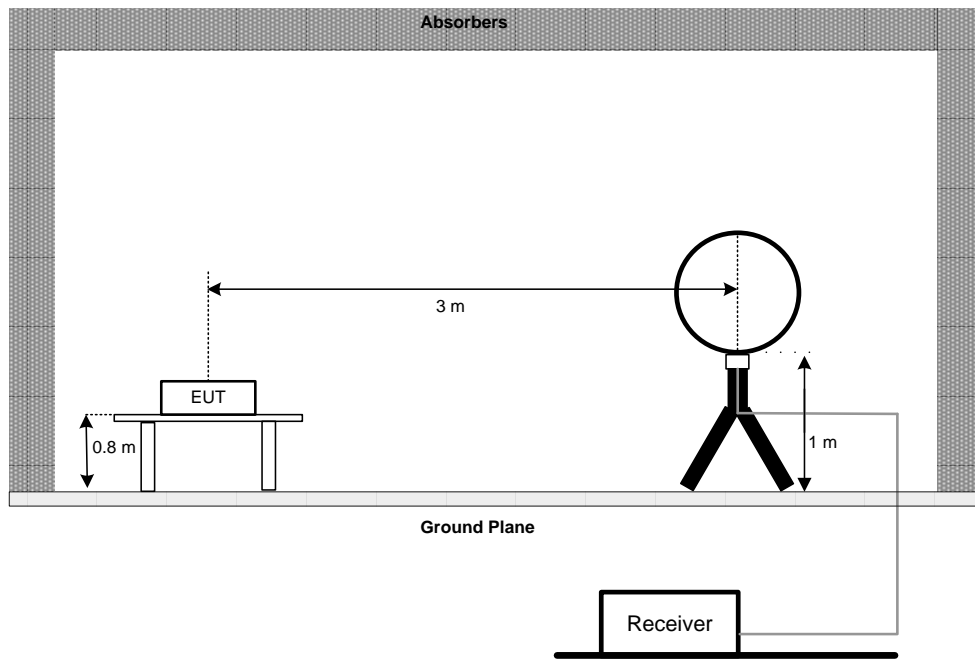

30 MHz to 1 GHz

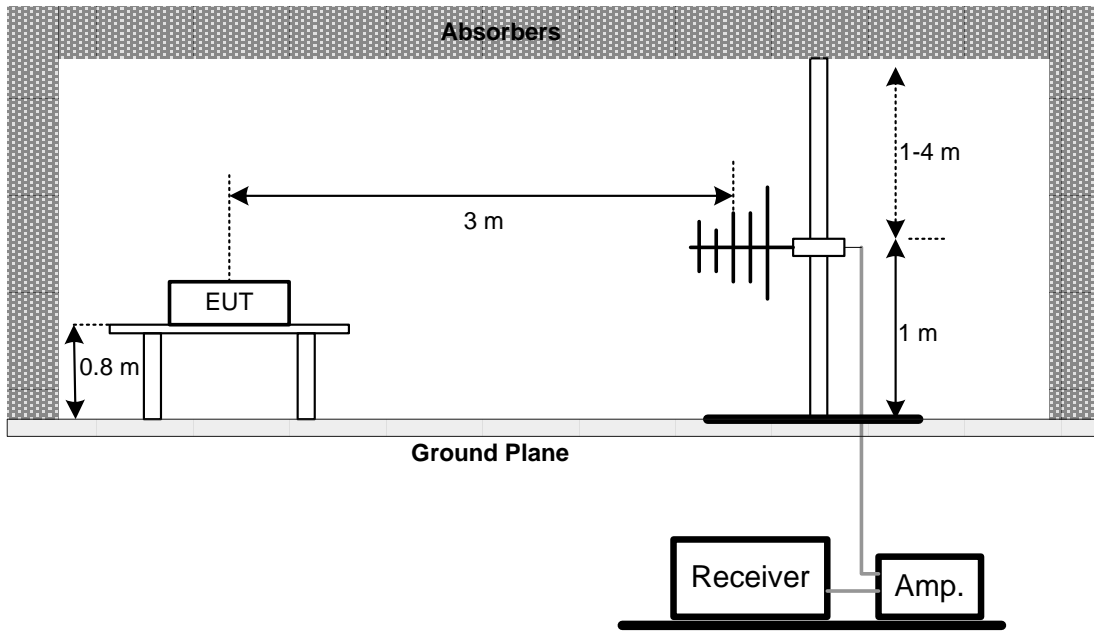

Above 1 GHz Band edge

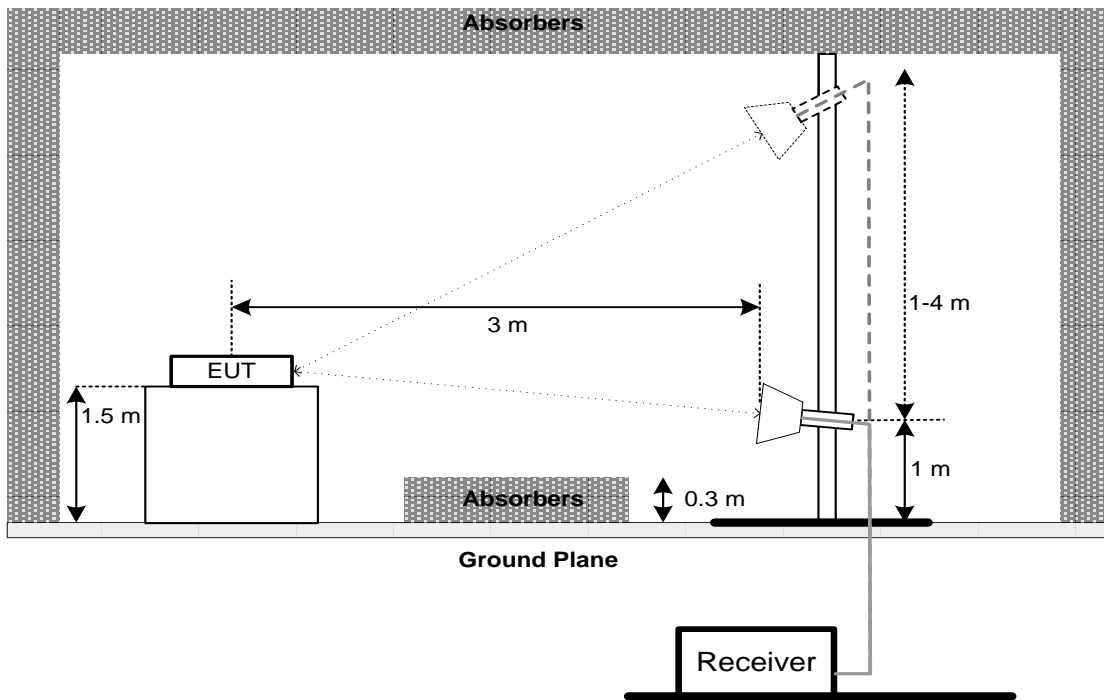

Harmonic(1 GHz to 18 GHz)

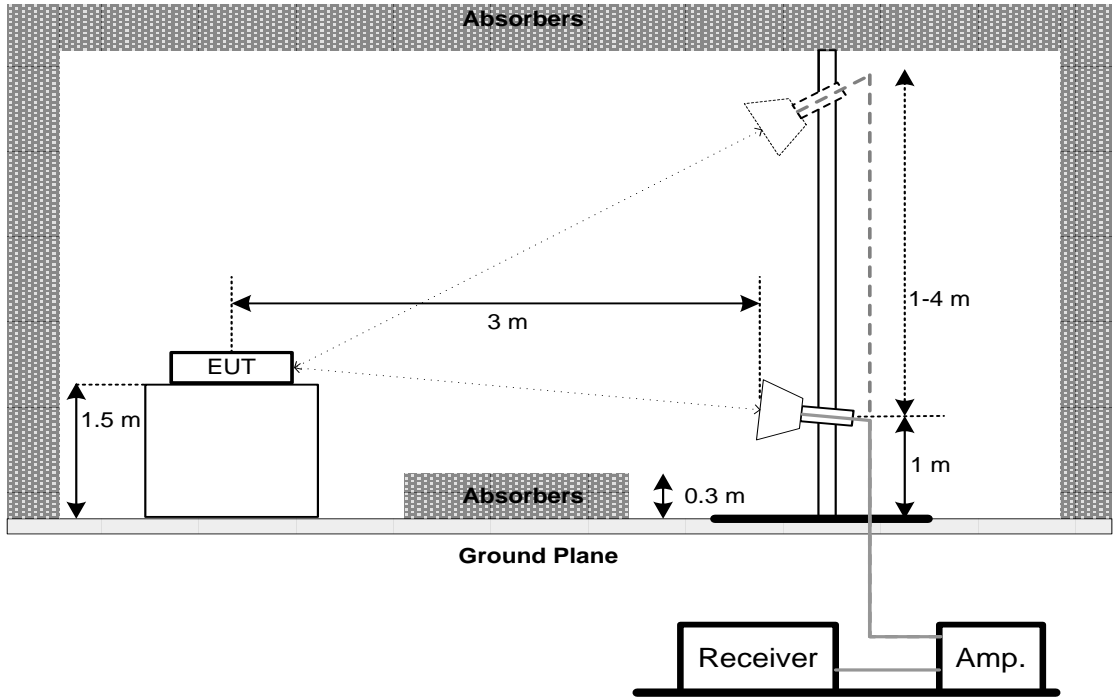

Harmonic(18 GHz to 26.5 GHz)

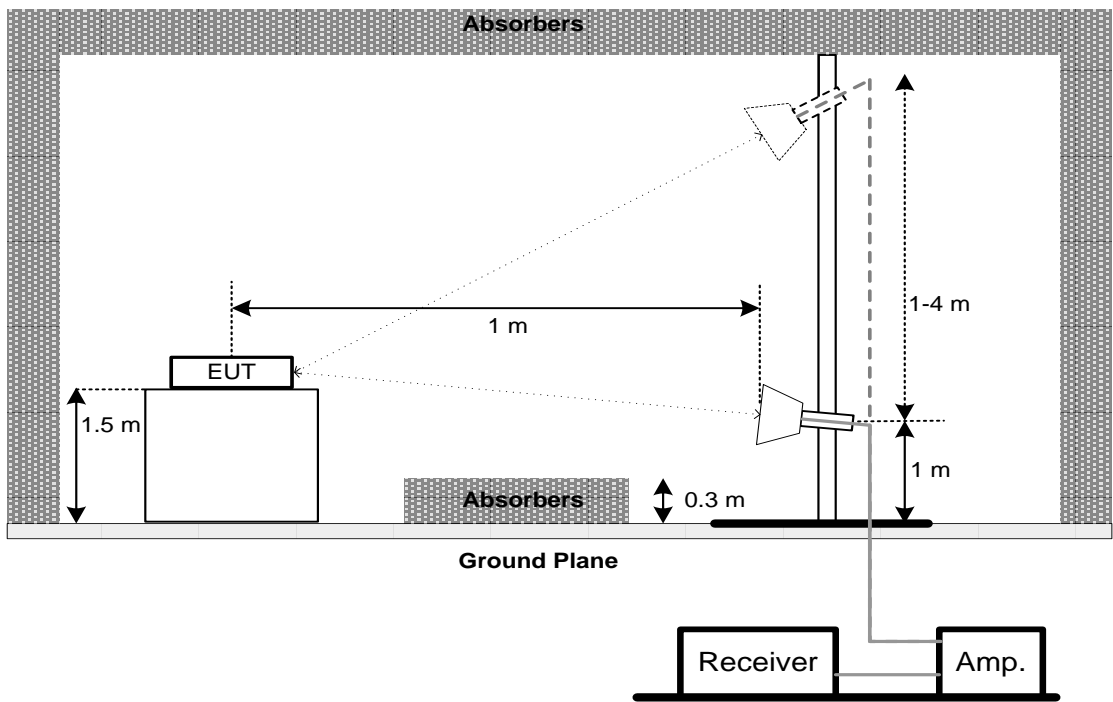

5.5 EUT OPERATION CONDITIONS

The EUT was programmed to be in continuously transmitting mode.

5.6 TEST RESULTS - 9 KHZ TO 30 MHZ

Please refer to the APPENDIX B.

Remark:

- (1) Distance extrapolation factor = $40 \log (\text{specific distance} / \text{test distance})$ (dB).
- (2) Limit line = specific limits (dBuV) + distance extrapolation factor.

5.7 TEST RESULTS - 30 MHZ TO 1000 MHZ

Please refer to the APPENDIX C.

5.8 TEST RESULTS - ABOVE 1000 MHZ

Please refer to the APPENDIX D.

Remark:

- (1) No limit: This is fundamental signal, the judgment is not applicable.
For fundamental signal judgment was referred to Peak output test.

6. BANDWIDTH

6.1 LIMIT

Section	Test Item	Limit
FCC 15.247(a)(2)	6 dB Bandwidth	Minimum 500 kHz
	99% Emission Bandwidth	-

6.2 TEST PROCEDURE

- The EUT was directly connected to the spectrum analyzer and antenna output port as show in the block diagram below.
- The following table is the setting of the spectrum analyzer:

For 6 dB Bandwidth:

Spectrum Parameters	Setting
Span Frequency	> Measurement Bandwidth
RBW	100 kHz
VBW	300 kHz
Detector	Peak
Trace	Max Hold
Sweep Time	Auto

For 99% Emission Bandwidth:

Spectrum Parameters	Setting
Span Frequency	Between 1.5 times and 5.0 times the OBW
RBW	300 kHz For 20MHz 1 MHz For 40MHz
VBW	1 MHz For 20MHz 3 MHz For 40MHz
Detector	Peak
Trace	Max Hold
Sweep Time	Auto

6.3 DEVIATION FROM STANDARD

No deviation.

6.4 TEST SETUP

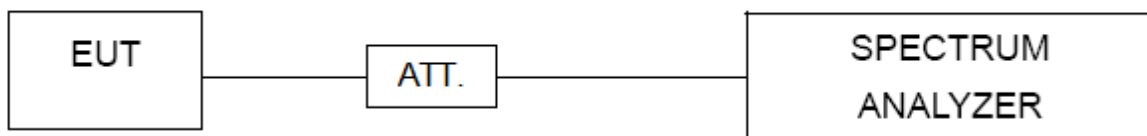

6.5 EUT OPERATION CONDITIONS

The EUT was programmed to be in continuously transmitting mode.

6.6 TEST RESULTS

Please refer to the APPENDIX E.

7. MAXIMUM OUTPUT POWER

7.1 LIMIT

Section	Test Item	Limit
FCC 15.247(b)(3)	Maximum Output Power	1.0000 Watt or 30.00 dBm

7.2 TEST PROCEDURE

- The EUT was directly connected to the peak power analyzer and antenna output port as show in the block diagram below.
- The maximum conducted output power was performed in accordance with method 11.9.2.3.1 of ANSI C63.10-2013 and FCC KDB 662911 D01 v02r01 Multiple Transmitter Output.

7.3 DEVIATION FROM STANDARD

No deviation.

7.4 TEST SETUP

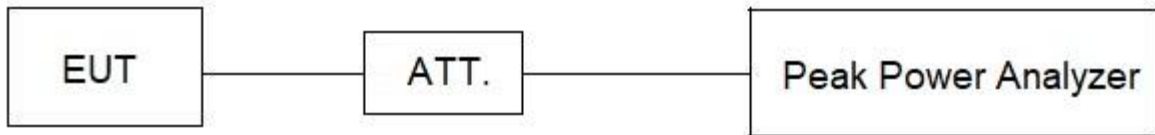

7.5 EUT OPERATION CONDITIONS

The EUT was programmed to be in continuously transmitting mode.

7.6 TEST RESULTS

Please refer to the APPENDIX F.

8. CONDUCTED SPURIOUS EMISSIONS

8.1 LIMIT

In any 100 kHz bandwidth outside the frequency band in which the spread spectrum or digitally modulated intentional radiator is operating, the radio frequency power that is produced by the intentional radiator shall be at least 20 dB below that in the 100 kHz bandwidth within the band that contains the highest level of the desired power, based on either an RF conducted or a radiated measurement, provided the transmitter demonstrates compliance with the peak Output Power limits. If the transmitter complies with the Output Power limits based on the use of RMS averaging over a time interval, as permitted under paragraph (b)(3) of this section, the attenuation required under this paragraph shall be 30 dB instead of 20 dB. Attenuation below the general limits specified in Section 15.209(a) is not required.

8.2 TEST PROCEDURE

- a. The EUT was directly connected to the spectrum analyzer and antenna output port as show in the block diagram below.
- b. The following table is the setting of the spectrum analyzer:

Spectrum Parameters	Setting
Start Frequency	30 MHz
Stop Frequency	26.5 GHz
RBW	100 kHz
VBW	300 kHz
Detector	Peak
Trace	Max Hold
Sweep Time	Auto

8.3 DEVIATION FROM STANDARD

No deviation.

8.4 TEST SETUP

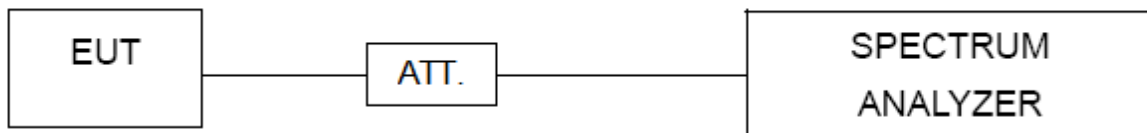

8.5 EUT OPERATION CONDITIONS

The EUT was programmed to be in continuously transmitting mode.

8.6 TEST RESULTS

Please refer to the APPENDIX G.

9. POWER SPECTRAL DENSITY

9.1 LIMIT

Section	Test Item	Limit
FCC 15.247(e)	Power Spectral Density	8 dBm (in any 3 kHz)

9.2 TEST PROCEDURE

- The EUT was directly connected to the spectrum analyzer and antenna output port as show in the block diagram below.
- The following table is the setting of the spectrum analyzer:

Spectrum Parameters	Setting
Span Frequency	25 MHz (20 MHz) / 60 MHz (40 MHz)
RBW	3 kHz
VBW	10 kHz
Detector	Peak
Trace	Max Hold
Sweep Time	Auto

9.3 DEVIATION FROM STANDARD

No deviation.

9.4 TEST SETUP



9.5 EUT OPERATION CONDITIONS

The EUT was programmed to be in continuously transmitting mode.

9.6 TEST RESULTS

Please refer to the APPENDIX H.

10. MEASUREMENT INSTRUMENTS LIST

Test Date: Dec. 13, 2023 ~ Feb. 05, 2024

AC Power Line Conducted Emissions					
Item	Kind of Equipment	Manufacturer	Type No.	Serial No.	Calibrated until
1	EMI Test Receiver	R&S	ESR3	103027	Jun. 16, 2024
2	TWO-LINE V-NETWORK	R&S	ENV216	101447	Dec. 22, 2024
3	Measurement Software	Farad	EZ-EMC Ver.NB-03A1-01	N/A	N/A
4	Cable	N/A	RG223	12m	Sep. 13, 2024
5	643 Shield Room	ETS	6*4*3	N/A	N/A

Radiated Emissions - 9 kHz to 30 MHz					
Item	Kind of Equipment	Manufacturer	Type No.	Serial No.	Calibrated until
1	Active Loop Antenna	Schwarzbeck	FMZB 1513-60B	1513-60 B-034	Apr. 01, 2024
2	MXE EMI Receiver	Keysight	N9038A	MY56400091	Dec. 22, 2024
3	Cable	N/A	RW2350-3.8A-NMB M-1.5M	N/A	Jun. 10, 2024
4	Measurement Software	Farad	EZ-EMC Ver.NB-03A1-01	N/A	N/A
5	966 Chamber room	ETS	9*6*6	N/A	Jul. 11, 2024

Radiated Emissions - Above 1 GHz					
Item	Kind of Equipment	Manufacturer	Type No.	Serial No.	Calibrated until
1	Receiver	Agilent	N9038A	MY52130039	Jan. 07, 2024
2	Preamplifier	EMC INSTRUMENT	EMC118A45SE	980888	Nov. 17, 2024
3	EXA Spectrum Analyzer	Keysight	N9010A	MY55150209	Jun. 16, 2024
4	Double Ridged Guide Antenna	ETS	3115	75789	May 31, 2024
5	Cable	RegalWay	A81-SMAMSMAM-12.5M	N/A	Aug. 08, 2024
6	Cable	RegalWay	RWLP50-4.0A-NM RASM-2.5M	N/A	Aug. 08, 2024
7	Cable	RegalWay	RWLP50-4.0A-NM RASMRA-0.8M	N/A	Aug. 08, 2024
8	Low Noise Amplifier	CONNPHY	CLN-18G40G-4330 -K	619413	Jul. 06, 2024
9	Cable	RegalWay	RWLP50-2.6A-2.92 M2.92M-1.1M	N/A	Jul. 26, 2024
10	Cable	Tonscend	HF160-KMKM-3M	N/A	Jul. 26, 2024
11	Broad-Band Horn Antenna	Schwarzbeck	BBHA9170(3m)	9170-319	Jun. 20, 2024
12	966 Chamber room	CM	9*6*6	N/A	May 17, 2024
13	Positioning Controller	MF	MF-7802	N/A	N/A

Bandwidth & Conducted Spurious Emissions & Power Spectral Density					
Item	Kind of Equipment	Manufacturer	Type No.	Serial No.	Calibrated until
1	Spectrum Analyzer	R&S	FSP40	100185	Jun. 16, 2024
2	Attenuator	Talent Microwave	TA10A0-S-26.5	N/A	N/A
3	Attenuator	Talent Microwave	TA10A0-S-26.5	N/A	N/A
4	DC Block	N/A	N/A	N/A	N/A
5	Measurement Software	BTL	BTL Conducted Test	N/A	N/A

Maximum Output Power					
Item	Kind of Equipment	Manufacturer	Type No.	Serial No.	Calibrated until
1	Peak Power Analyzer	Keysight	8990B	MY51000506	Jun. 17, 2024
2	Wideband power sensor	Keysight	N1923A	MY58310004	Jun. 17, 2024
3	Attenuator	Talent Microwave	TA10A2-S-18	N/A	N/A

Test Date: Nov. 26, 2024 ~ Dec. 13, 2024

Radiated Emissions - 30 MHz to 1 GHz					
Item	Kind of Equipment	Manufacturer	Type No.	Serial No.	Calibrated until
1	Trilog-Broadband Antenna	Schwarzbeck	VULB9168	587	May 12, 2025
2	Attenuator	SHX	TS2-6-6-A	240124196	May 12, 2025
3	Preamplifier	EMC INSTRUMENT	EMC001330	980998	May 31, 2025
4	Cable	RegalWay	LMR400-NMNM-12.5m	N/A	Jun. 06, 2025
5	Cable	RegalWay	LMR400-NMNM-3m	N/A	Jun. 06, 2025
6	Cable	RegalWay	LMR400-NMNM-0.5m	N/A	Jun. 06, 2025
7	MXE EMI Receiver	KEYSIGHT	N9038B	MY62210123	Oct. 29, 2025
8	Positioning Controller	MF	MF-7802	N/A	N/A
9	Measurement Software	Farad	EZ-EMC Ver.NB-03A1-01	N/A	N/A
10	966 Chamber room	CM	9*6*6	N/A	May 16, 2025

Radiated Emissions - 1 GHz to 18GHz					
Item	Kind of Equipment	Manufacturer	Type No.	Serial No.	Calibrated until
1	MXA Signal Analyzer	KEYSIGHT	N9020B	MY63380204	Oct. 29, 2025
2	Preamplifier	EMC INSTRUMENT	EMC118A45SE	980888	Oct. 29, 2025
3	Double Ridged Guide Antenna	ETS	3115	75789	Jun. 15, 2025
4	Cable	RegalWay	RWLP50-4.0A-SMS M-12.5M	N/A	Jul. 03, 2025
5	Cable	RegalWay	RWLP50-4.0A-NM RASM-2.5M	N/A	Jul. 03, 2025
6	Cable	RegalWay	RWLP50-4.0A-NM RASMRA-0.8M	N/A	Jul. 03, 2025
7	966 Chamber room	CM	9*6*6	N/A	May 19, 2025
8	Positioning Controller	MF	MF-7802	N/A	N/A
9	Measurement Software	Farad	EZ-EMC Ver.NB-03A1-01	N/A	N/A
10	Filter	STI	STI15-9912	N/A	May 31, 2025

Radiated Emissions - Above 18 GHz					
Item	Kind of Equipment	Manufacturer	Type No.	Serial No.	Calibrated until
1	EXA Spectrum Analyzer	Keysight	N9010A	MY55150209	Aug. 20, 2025
2	Preamplifier	EMC INSTRUMENT	EMC184045SE	980905	Oct. 29, 2025
3	Cable	RegalWay	RWLP50-2.6A-2.92 M2.92M-1.1M	N/A	Jul. 25, 2025
4	Cable	Tonscend	HF160-KMKM-3M	N/A	Jul. 25, 2025
5	Broad-Band Horn Antenna	Schwarzbeck	BBHA9170(3m)	9170-319	Jun. 16, 2025
6	966 Chamber room	CM	9*6*6	N/A	May 19, 2025
7	Positioning Controller	MF	MF-7802	N/A	N/A
8	Measurement Software	Farad	EZ-EMC Ver.NB-03A1-01	N/A	N/A

Remark: "N/A" denotes no model name, serial no. or calibration specified.

All calibration period of equipment list is one year.

11. EUT TEST PHOTO**AC Power Line Conducted Emissions Test Photos**

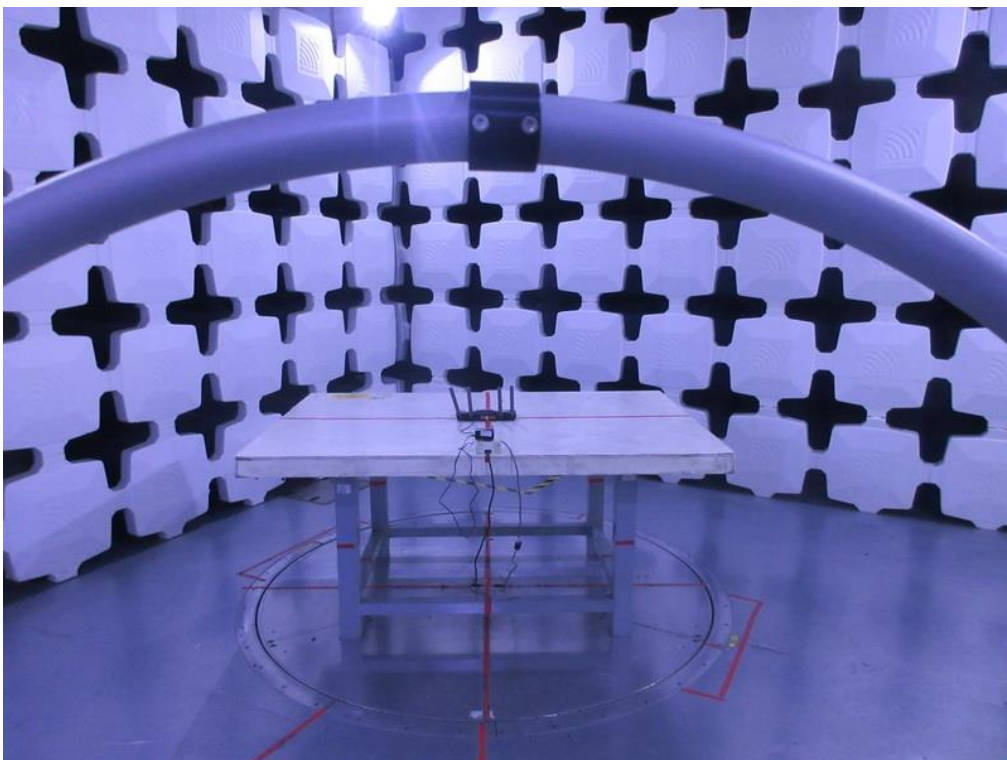
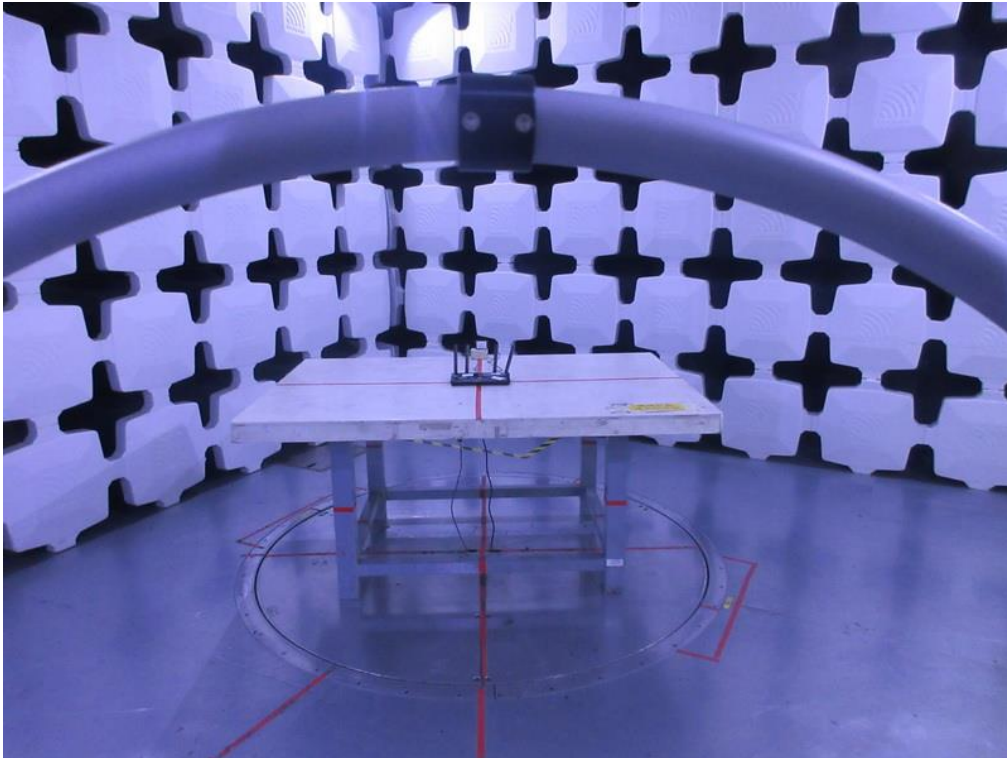
Radiated Emissions Test Photos**9 kHz to 30 MHz**

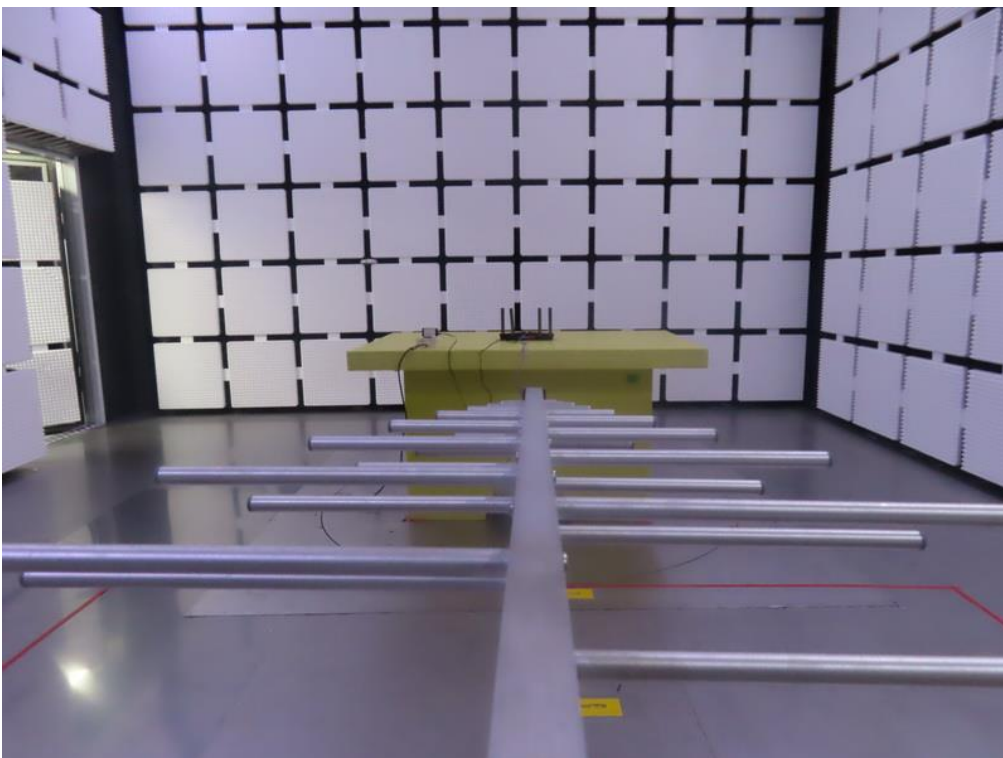
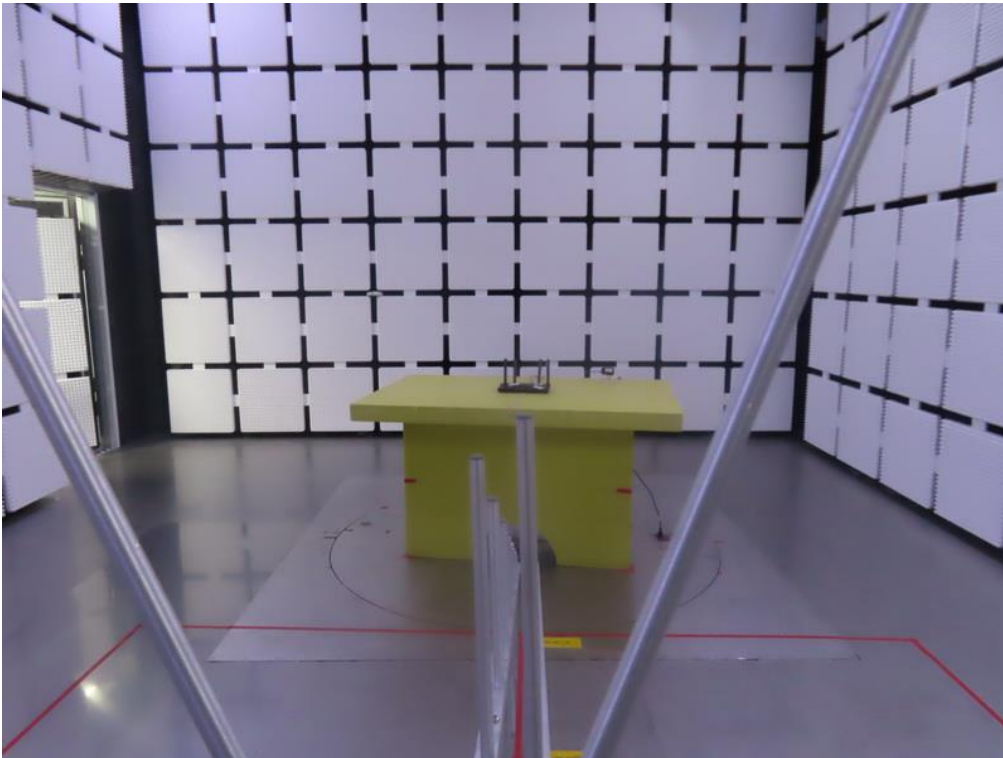
Radiated Emissions Test Photos**30 MHz to 1 GHz**

Radiated Emissions Test Photos

Above 1 GHz

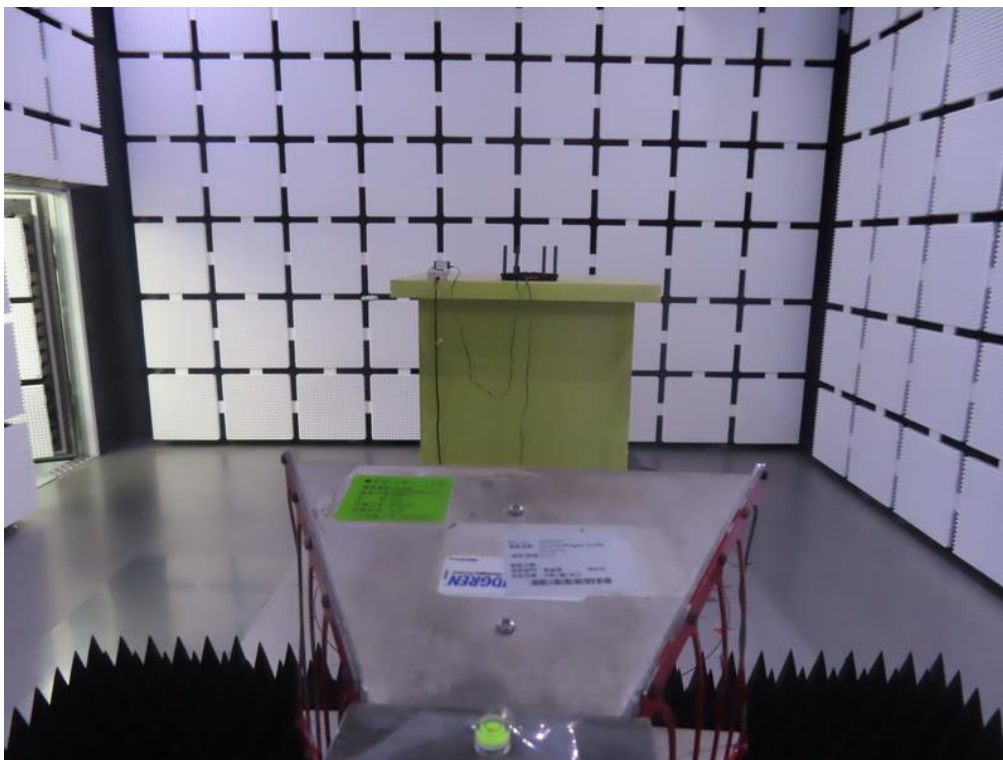
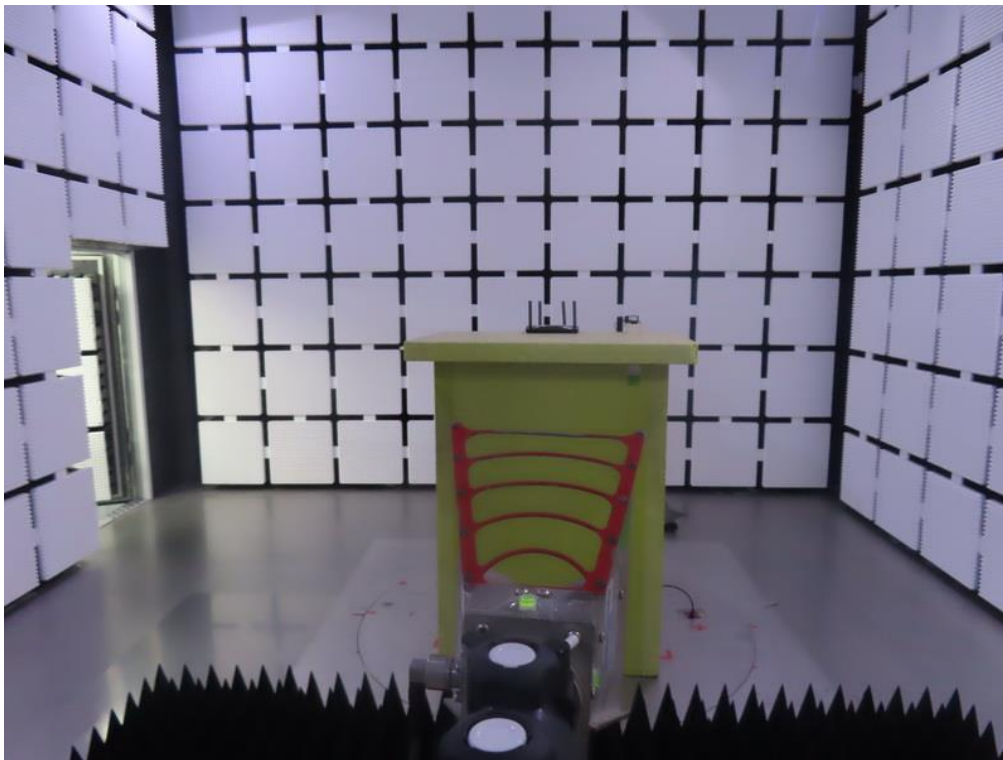

Conducted Test Photos

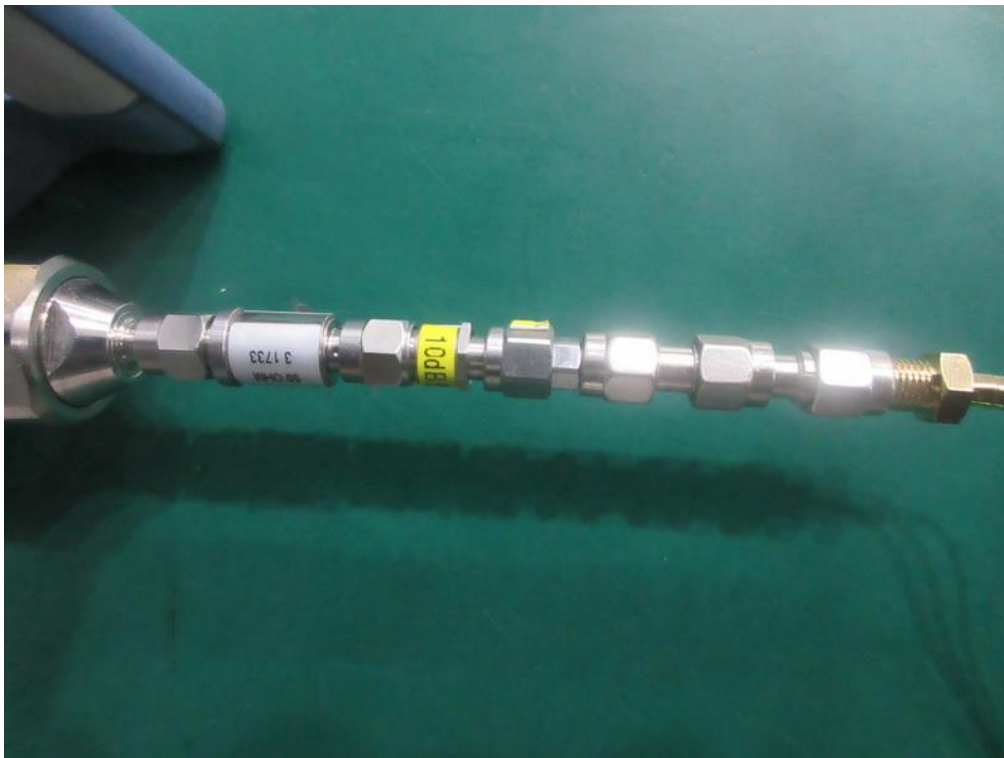
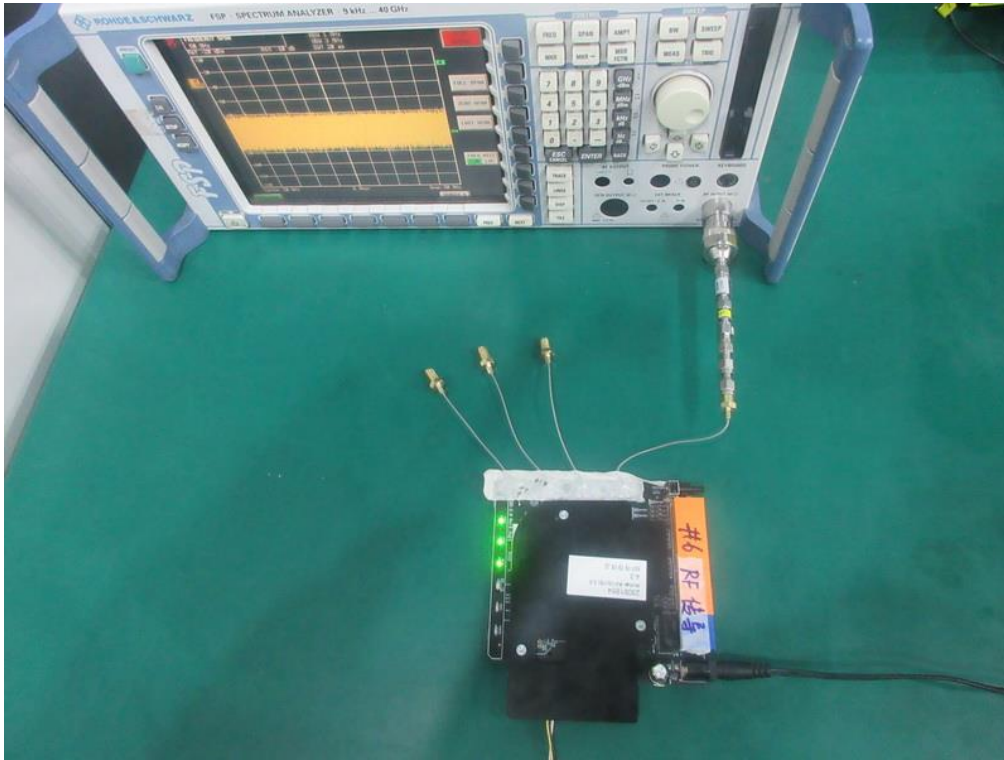

APPENDIX A - AC POWER LINE CONDUCTED EMISSIONS

Test Mode	TX G Mode Channel 06	Phase	Line
-----------	----------------------	-------	------

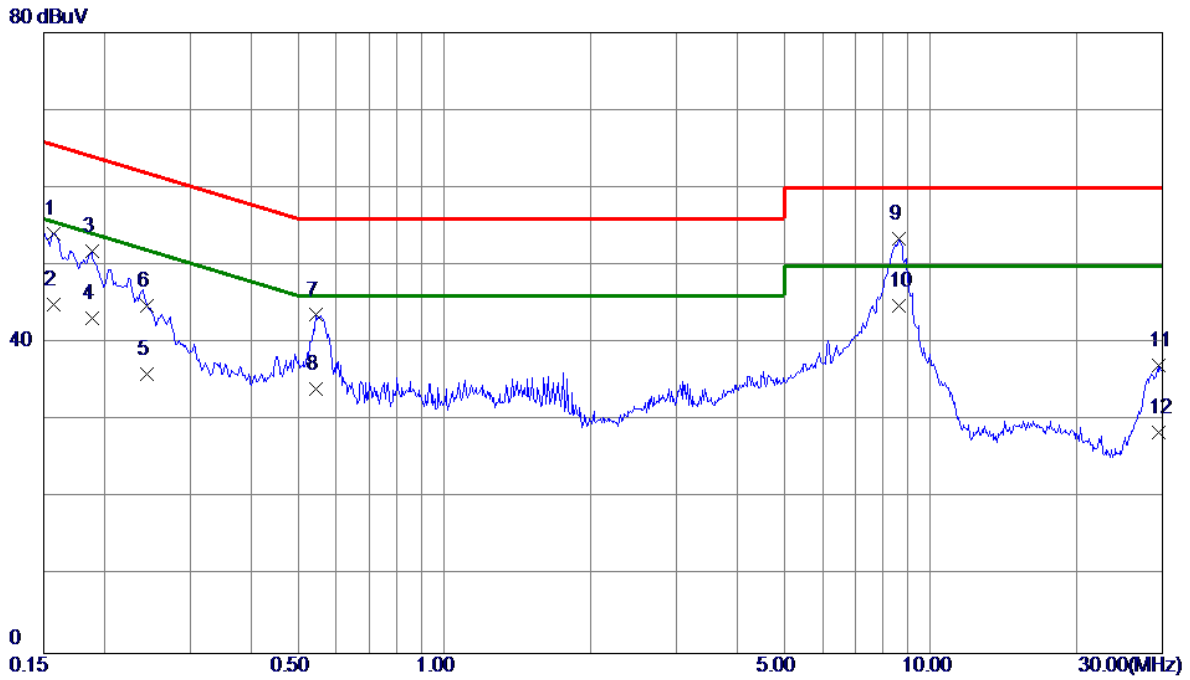

No.	Freq. MHz	Reading Level dBuV	Correct Factor dB	Measure ment dBuV	Limit dBuV	Margin dB	Detector	Comment
1	0.1568	44.44	9.71	54.15	65.63	-11.48	QP	
2	0.1568	35.20	9.71	44.91	55.63	-10.72	AVG	
3	0.1883	42.06	9.71	51.77	64.11	-12.34	QP	
4	0.1883	33.50	9.71	43.21	54.11	-10.90	AVG	
5	0.2445	26.29	9.71	36.00	61.94	-25.94	QP	
6	0.2445	35.13	9.71	44.84	51.94	-7.10	AVG	
7	0.5437	33.86	9.74	43.60	56.00	-12.40	QP	
8	0.5437	24.30	9.74	34.04	46.00	-11.96	AVG	
9	8.6235	43.29	10.19	53.48	60.00	-6.52	QP	
10 *	8.6235	34.60	10.19	44.79	50.00	-5.21	AVG	
11	29.5395	26.12	11.03	37.15	60.00	-22.85	QP	
12	29.5395	17.50	11.03	28.53	50.00	-21.47	AVG	

REMARKS:

- (1) Measurement Value = Reading Level + Correct Factor.
- (2) Margin Level = Measurement Value - Limit Value.

Test Mode	TX G Mode Channel 06	Phase	Neutral
-----------	----------------------	-------	---------

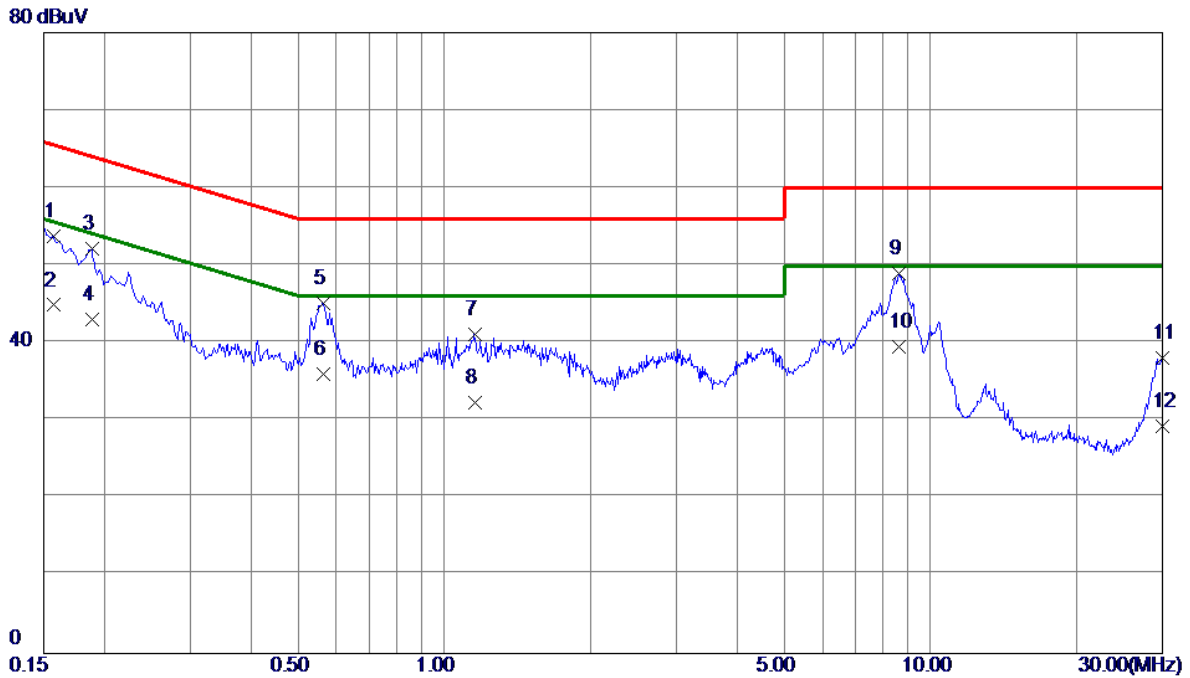

No.	Freq. MHz	Reading Level dBuV	Correct Factor dB	Measurement dBuV	Limit dBuV	Margin dB	Detector	Comment
1	0.1568	44.08	9.68	53.76	65.63	-11.87	QP	
2	0.1568	35.20	9.68	44.88	55.63	-10.75	AVG	
3	0.1883	42.52	9.68	52.20	64.11	-11.91	QP	
4	0.1883	33.40	9.68	43.08	54.11	-11.03	AVG	
5	0.5639	35.46	9.71	45.17	56.00	-10.83	QP	
6 *	0.5639	26.30	9.71	36.01	46.00	-9.99	AVG	
7	1.1535	31.28	9.77	41.05	56.00	-14.95	QP	
8	1.1535	22.50	9.77	32.27	46.00	-13.73	AVG	
9	8.5897	38.77	10.17	48.94	60.00	-11.06	QP	
10	8.5897	29.41	10.17	39.58	50.00	-10.42	AVG	
11	29.9175	27.05	11.03	38.08	60.00	-21.92	QP	
12	29.9175	18.30	11.03	29.33	50.00	-20.67	AVG	

REMARKS:

- (1) Measurement Value = Reading Level + Correct Factor.
- (2) Margin Level = Measurement Value - Limit Value.

APPENDIX B - RADIATED EMISSION - 9 KHZ TO 30 MHZ

Test Mode	TX G Mode Channel 06	Polarization	Ant 0°
-----------	----------------------	--------------	--------

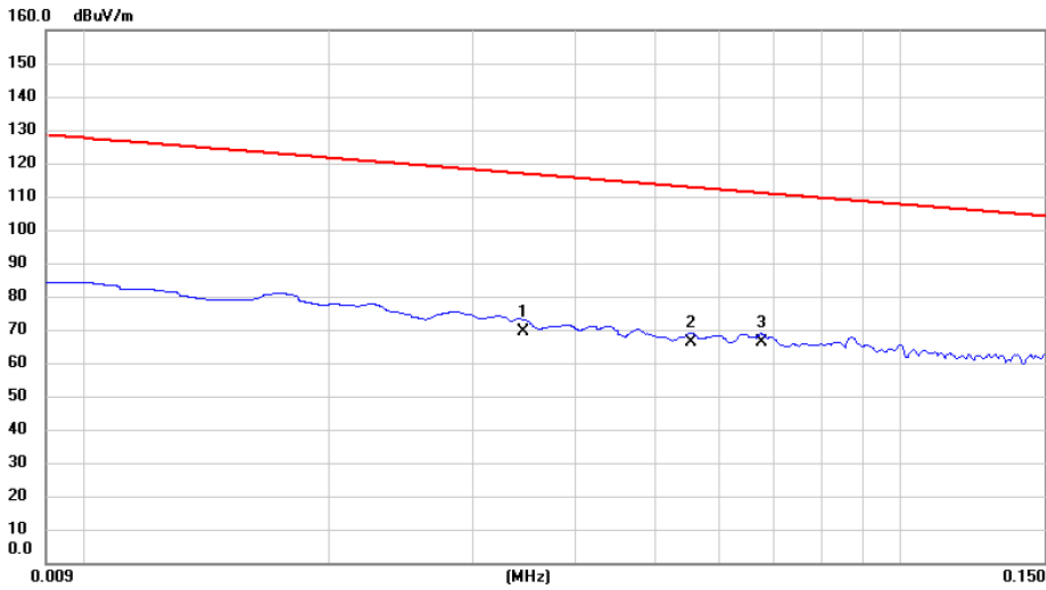

No.	Mk.	Freq. MHz	Reading Level dBuV	Correct Factor dB	Measurement dBuV/m	Limit dBuV/m	Margin dB	Detector	Comment
1		0.0345	49.63	19.80	69.43	116.85	-47.42	AVG	
2		0.0554	46.51	19.82	66.33	112.73	-46.40	AVG	
3	*	0.0675	46.22	19.86	66.08	111.02	-44.94	AVG	

REMARKS:

- (1) Measurement Value = Reading Level + Correct Factor.
- (2) Margin Level = Measurement Value - Limit Value.

Test Mode	TX G Mode Channel 06	Polarization	Ant 0°
-----------	----------------------	--------------	--------

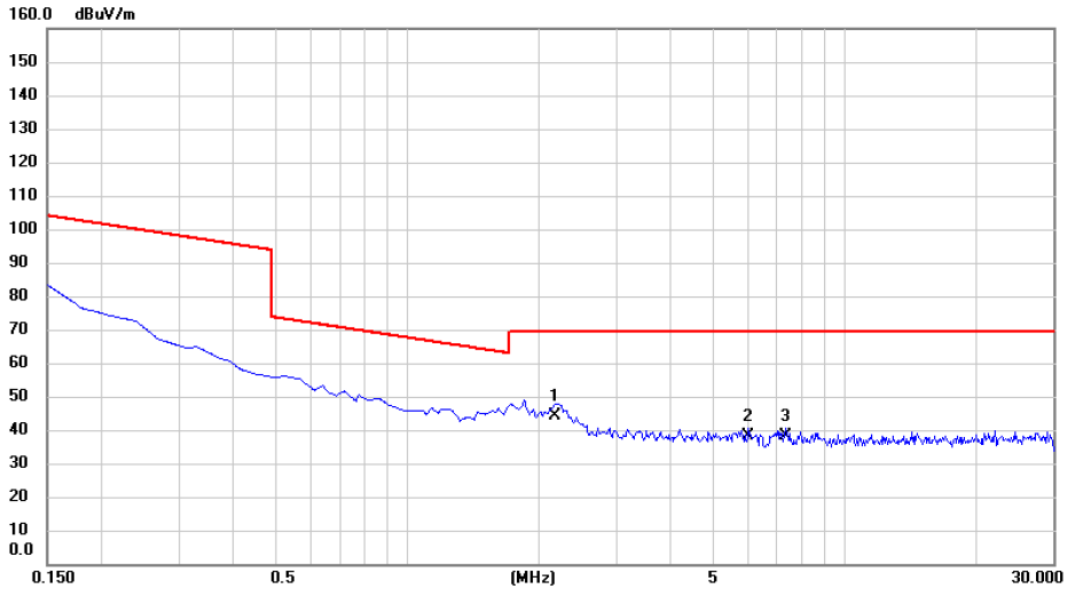

No. Mk.	Freq. MHz	Reading Level dBuV	Correct Factor dB	Measure- ment dBuV/m	Limit dBuV/m	Margin dB	Detector	Comment
1 *	2.1798	24.32	19.81	44.13	69.54	-25.41	QP	
2	6.0305	18.11	19.96	38.07	69.54	-31.47	QP	
3	7.3140	18.23	20.04	38.27	69.54	-31.27	QP	

REMARKS:

- (1) Measurement Value = Reading Level + Correct Factor.
- (2) Margin Level = Measurement Value - Limit Value.

Test Mode	TX G Mode Channel 06	Polarization	Ant 90°
-----------	----------------------	--------------	---------

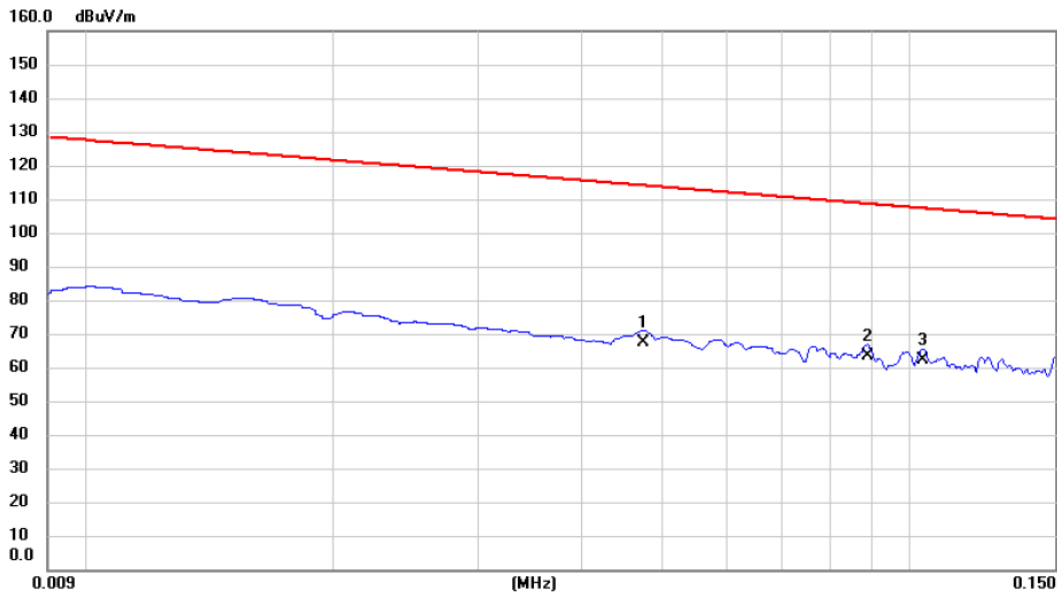

No.	Mk.	Freq. MHz	Reading Level dBuV	Correct Factor dB	Measure- ment dBuV/m	Limit dBuV/m	Margin dB	Detector	Comment
1		0.0475	47.63	19.80	67.43	114.07	-46.64	AVG	
2		0.0888	43.62	19.86	63.48	108.64	-45.16	AVG	
3	*	0.1038	42.51	19.83	62.34	107.28	-44.94	QP	

REMARKS:

- (1) Measurement Value = Reading Level + Correct Factor.
- (2) Margin Level = Measurement Value - Limit Value.

Test Mode	TX G Mode Channel 06	Polarization	Ant 90°
-----------	----------------------	--------------	---------

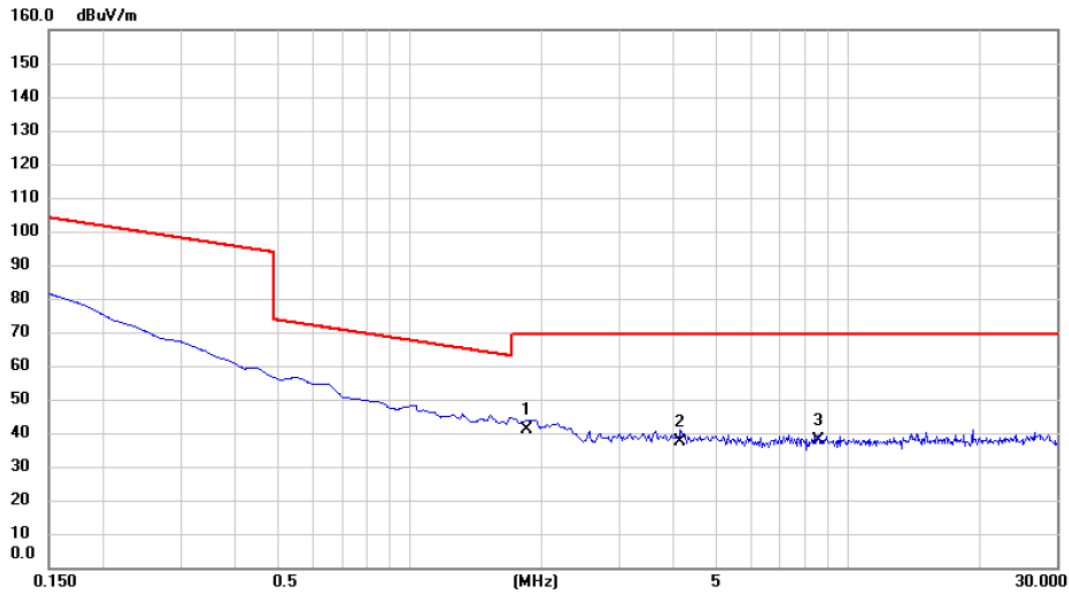

No.	Mk.	Freq. MHz	Reading Level dBuV	Correct Factor dB	Measure- ment dBuV/m	Limit dBuV/m	Margin dB	Detector	Comment
1	*	1.8515	21.36	19.80	41.16	69.54	-28.38	QP	
2		4.1500	17.65	19.93	37.58	69.54	-31.96	QP	
3		8.5677	17.52	20.12	37.64	69.54	-31.90	QP	

REMARKS:

- (1) Measurement Value = Reading Level + Correct Factor.
- (2) Margin Level = Measurement Value - Limit Value.

APPENDIX C - RADIATED EMISSION - 30 MHZ TO 1000 MHZ

Test Mode	TX G Mode Channel 06	Polarization	Vertical
-----------	----------------------	--------------	----------

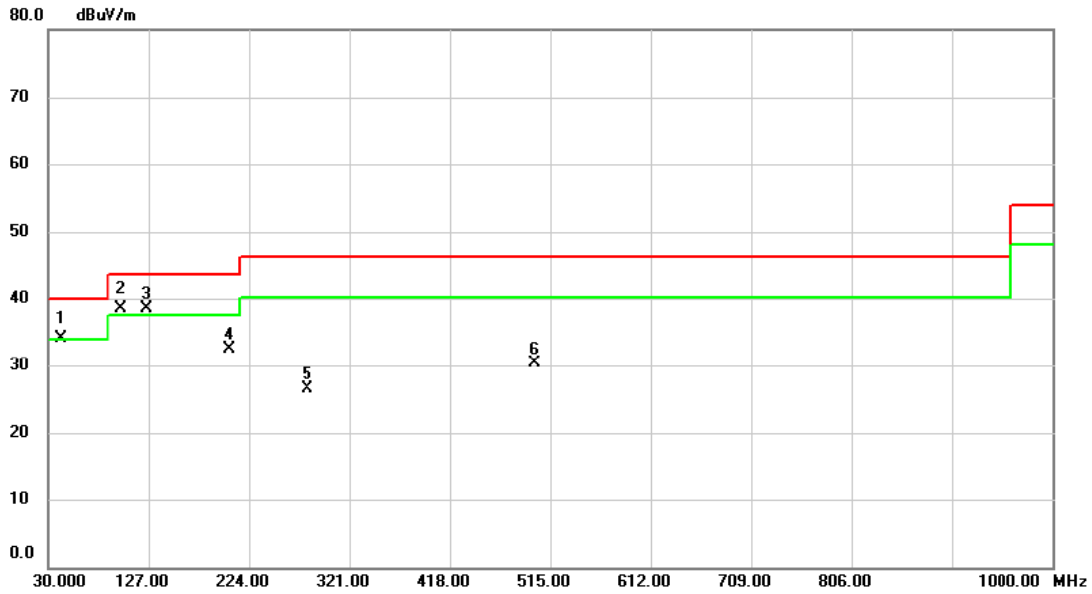

No.	Mk.	Freq. MHz	Reading Level dBuV	Correct Factor dB	Measure- ment dBuV/m	Limit dBuV/m	Margin dB	Detector	Comment
1	!	41.640	45.79	-11.60	34.19	40.00	-5.81	QP	
2	*	100.810	54.24	-15.79	38.45	43.52	-5.07	QP	
3	!	124.575	51.26	-12.81	38.45	43.52	-5.07	peak	
4		205.570	46.89	-14.42	32.47	43.52	-11.05	peak	
5		280.260	37.61	-11.03	26.58	46.02	-19.44	peak	
6		499.965	36.27	-6.02	30.25	46.02	-15.77	peak	

REMARKS:

- (1) Measurement Value = Reading Level + Correct Factor.
- (2) Margin Level = Measurement Value - Limit Value.

Test Mode	TX G Mode Channel 06	Polarization	Horizontal
-----------	----------------------	--------------	------------

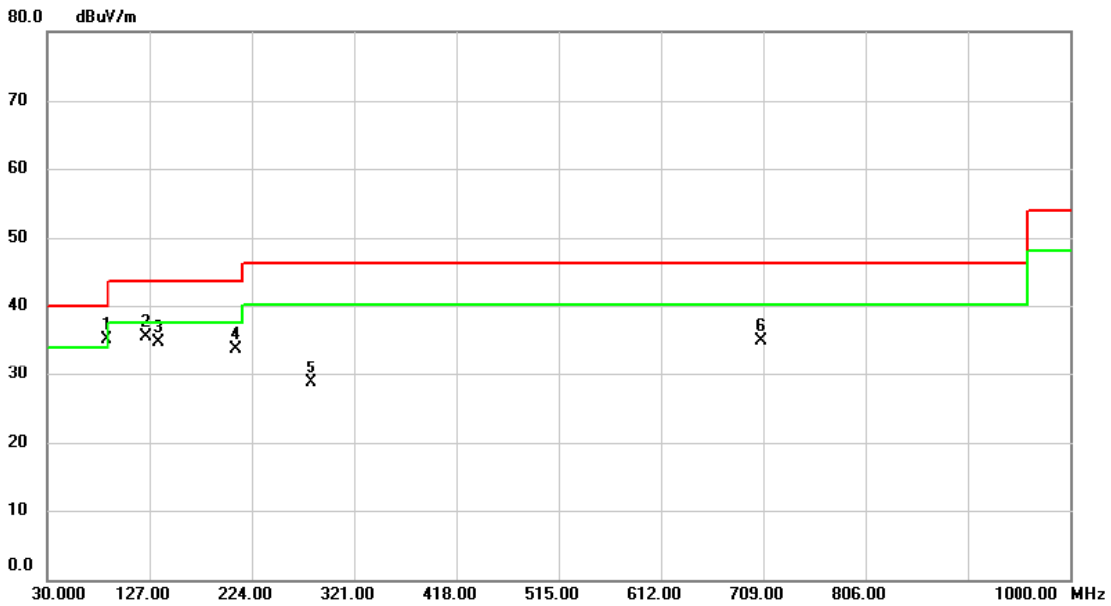

No.	Mk.	Freq. MHz	Reading Level dBuV	Correct Factor dB	Measure- ment dBuV/m	Limit dBuV/m	Margin dB	Detector	Comment
1	*	85.775	51.72	-16.60	35.12	40.00	-4.88	peak	
2		123.605	48.43	-12.90	35.53	43.52	-7.99	peak	
3		134.760	46.84	-12.07	34.77	43.52	-8.75	peak	
4		209.450	48.12	-14.42	33.70	43.52	-9.82	peak	
5		279.775	39.80	-11.05	28.75	46.02	-17.27	peak	
6		706.575	37.11	-2.14	34.97	46.02	-11.05	peak	

REMARKS:

- (1) Measurement Value = Reading Level + Correct Factor.
- (2) Margin Level = Measurement Value - Limit Value.

APPENDIX D - RADIATED EMISSION- ABOVE 1000 MHZ

Test Mode	TX B Mode 2412 MHz	Polarization	Vertical
-----------	--------------------	--------------	----------

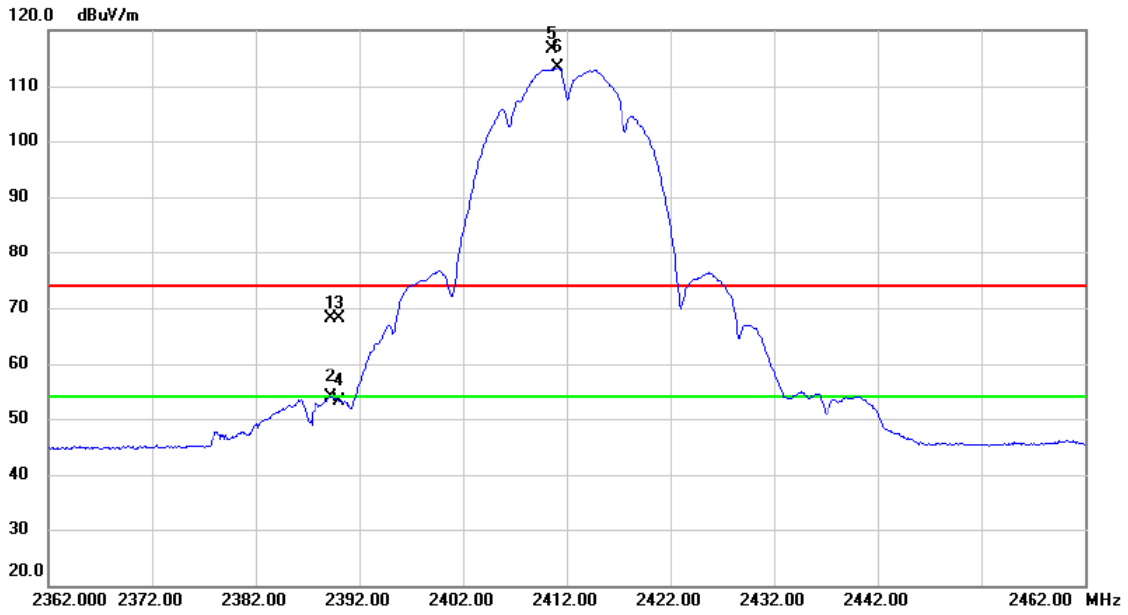

No. Mk.	Freq. MHz	Reading Level dBuV	Correct Factor dB	Measurement dBuV/m	Limit dBuV/m	Margin dB	Detector	Comment
1	2389.250	60.58	7.49	68.07	74.00	-5.93	peak	
2	2389.250	46.42	7.49	53.91	54.00	-0.09	AVG	
3	2390.000	60.74	7.49	68.23	74.00	-5.77	peak	
4	2390.000	45.66	7.49	53.15	54.00	-0.85	AVG	
5 X	2410.550	109.17	7.52	116.69	74.00	42.69	peak	No Limit
6 *	2411.200	105.76	7.52	113.28	54.00	59.28	AVG	No Limit

REMARKS:

- (1) Measurement Value = Reading Level + Correct Factor.
- (2) Margin Level = Measurement Value - Limit Value.

Test Mode	TX B Mode 2412 MHz	Polarization	Vertical
-----------	--------------------	--------------	----------

80 dBuV/m

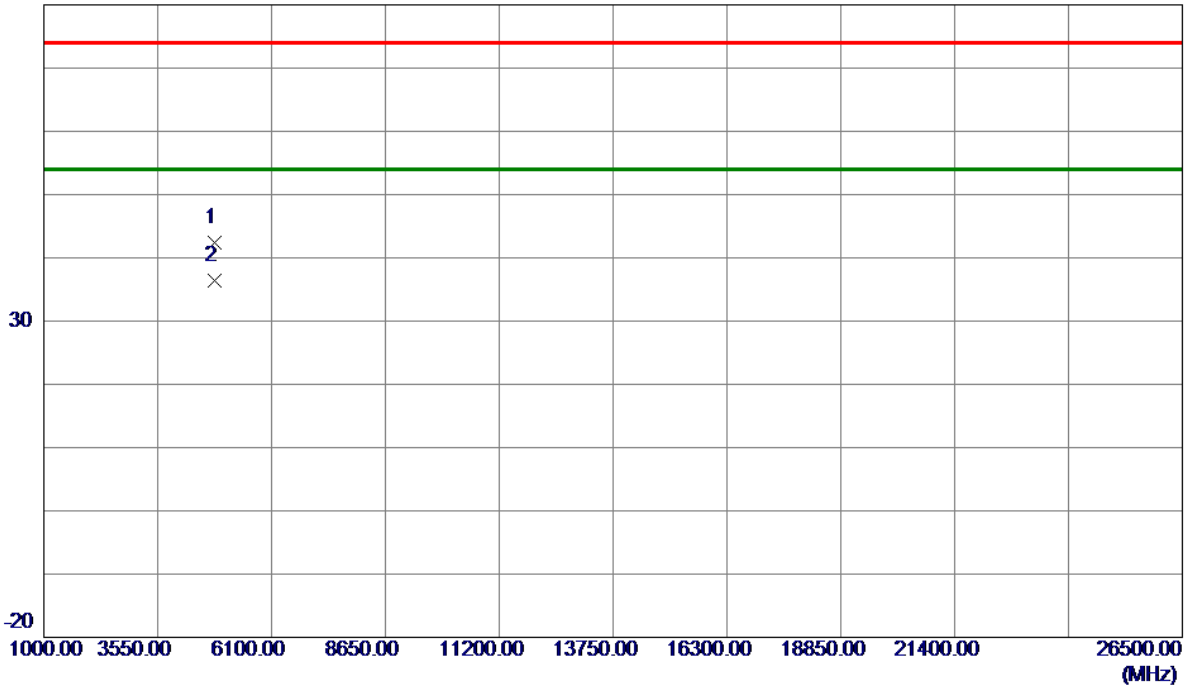

No.	Freq. MHz	Reading Level dBuV/m	Correct Factor dB	Measure ment dBuV/m	Limit dBuV/m	Margin dB	Detector	Comment
1	4823.8000	41.45	0.95	42.40	74.00	-31.60	Peak	
2 *	4823.9750	35.43	0.95	36.38	54.00	-17.62	AVG	

REMARKS:

- (1) Measurement Value = Reading Level + Correct Factor.
- (2) Margin Level = Measurement Value - Limit Value.

Test Mode	TX B Mode 2417 MHz	Polarization	Vertical
-----------	--------------------	--------------	----------

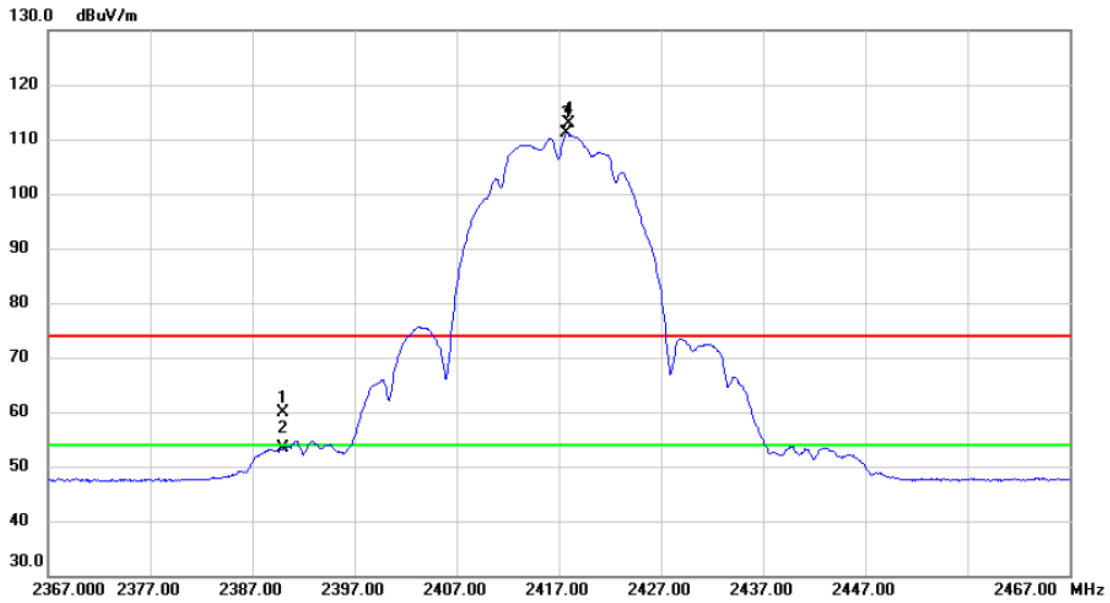

No.	Mk.	Freq. MHz	Reading Level dBuV	Correct Factor dB	Measure- ment dBuV/m	Limit dBuV/m	Margin dB	Detector	Comment
1		2390.000	52.71	7.22	59.93	74.00	-14.07	peak	
2		2390.000	46.19	7.22	53.41	54.00	-0.59	AVG	
3	*	2417.750	103.78	7.24	111.02	54.00	57.02	AVG	No Limit
4	X	2417.950	105.70	7.24	112.94	74.00	38.94	peak	No Limit

REMARKS:

(1) Measurement Value = Reading Level

Test Mode	TX B Mode 2437 MHz	Polarization	Vertical
-----------	--------------------	--------------	----------

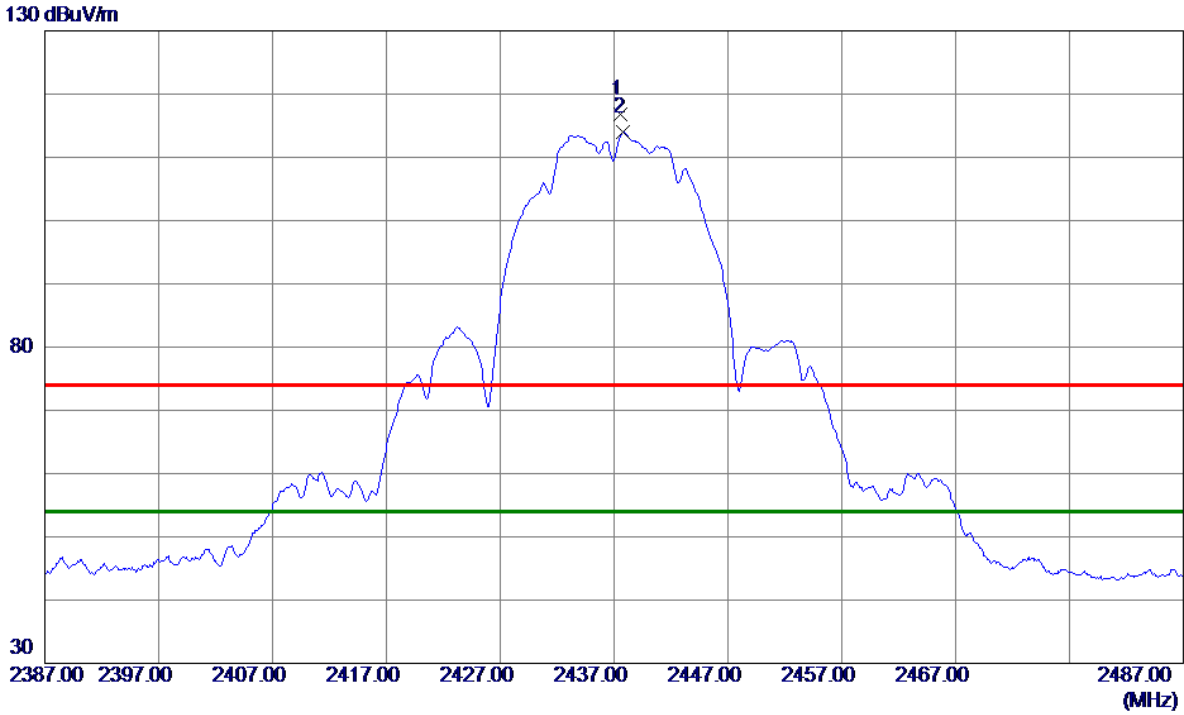

No.	Freq. MHz	Reading Level dBuV/m	Correct Factor dB	Measure ment dBuV/m	Limit dBuV/m	Margin dB	Detector	Comment
1	2437.6000	110.51	6.20	116.71	74.00	42.71	Peak	No Limit
2 *	2437.8000	107.76	6.20	113.96	54.00	59.96	AVG	No Limit

REMARKS:

- (1) Measurement Value = Reading Level + Correct Factor.
- (2) Margin Level = Measurement Value - Limit Value.

Test Mode	TX B Mode 2437 MHz	Polarization	Vertical
-----------	--------------------	--------------	----------

80 dBuV/m

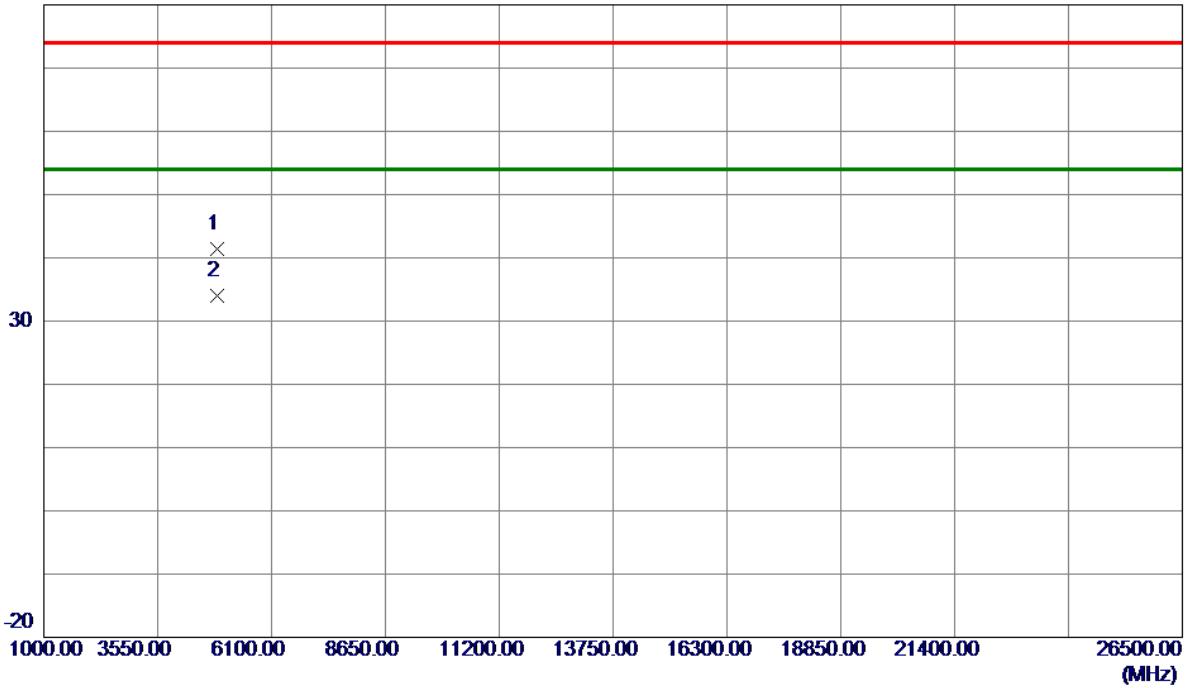

No.	Freq. MHz	Reading Level dBuV/m	Correct Factor dB	Measure ment dBuV/m	Limit dBuV/m	Margin dB	Detector	Comment
1	4873.8750	40.23	1.08	41.31	74.00	-32.69	Peak	
2 *	4874.0099	32.90	1.08	33.98	54.00	-20.02	AVG	

REMARKS:

- (1) Measurement Value = Reading Level + Correct Factor.
- (2) Margin Level = Measurement Value - Limit Value.

Test Mode	TX B Mode 2457 MHz	Polarization	Vertical
-----------	--------------------	--------------	----------

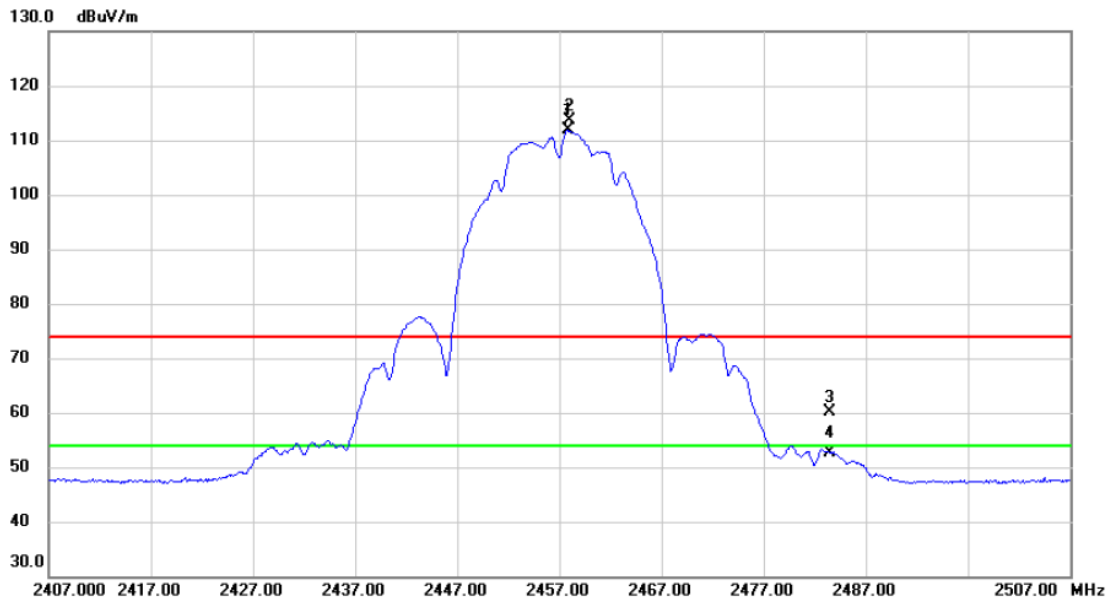

No.	Mk.	Freq. MHz	Reading Level dBuV	Correct Factor dB	Measure- ment dBuV/m	Limit dBuV/m	Margin dB	Detector	Comment
1	*	2457.800	104.55	7.27	111.82	54.00	57.82	AVG	No Limit
2	X	2457.950	106.44	7.27	113.71	74.00	39.71	peak	No Limit
3		2483.500	52.84	7.27	60.11	74.00	-13.89	peak	
4		2483.500	45.47	7.27	52.74	54.00	-1.26	AVG	

REMARKS:

- (1) Measurement Value = Reading Level + Correct Factor.
- (2) Margin Level = Measurement Value - Limit Value.

Test Mode	TX B Mode 2462 MHz	Polarization	Vertical
-----------	--------------------	--------------	----------

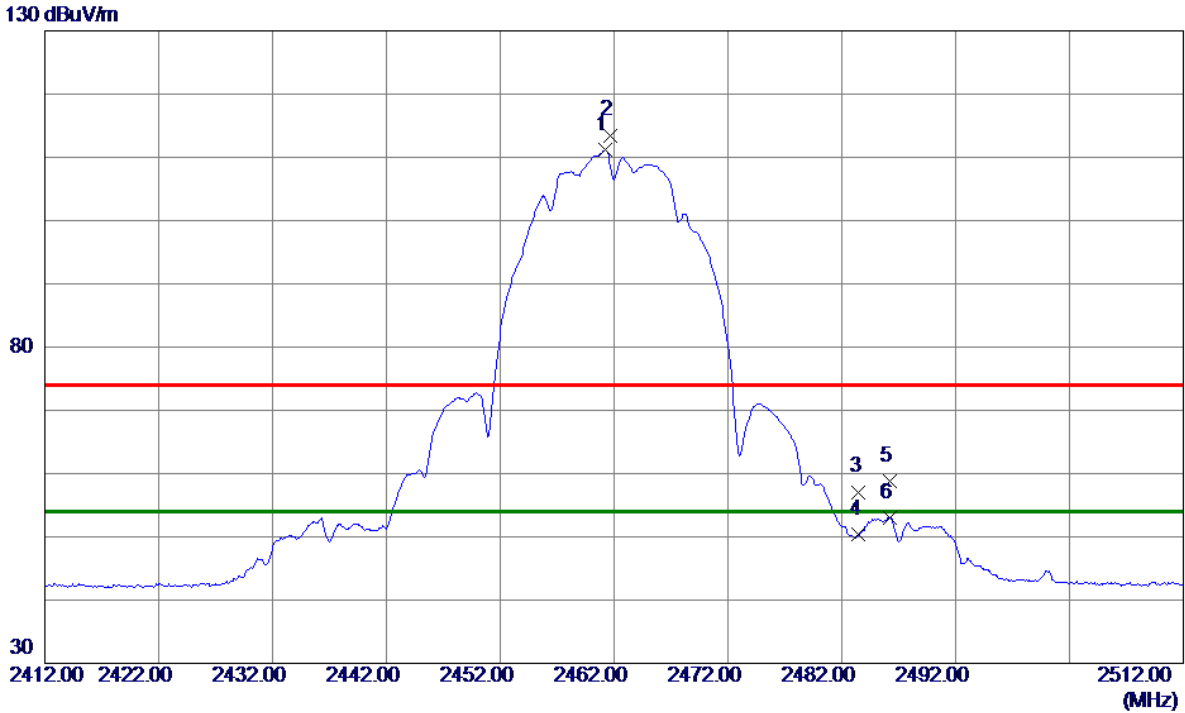

No.	Freq. MHz	Reading Level dBuV/m	Correct Factor dB	Measure ment dBuV/m	Limit dBuV/m	Margin dB	Detector	Comment
1 *	2461.2500	104.90	6.21	111.11	54.00	57.11	AVG	No Limit
2	2461.6500	107.29	6.21	113.50	74.00	39.50	Peak	No Limit
3	2483.5000	50.87	6.23	57.10	74.00	-16.90	Peak	
4	2483.5000	44.25	6.23	50.48	54.00	-3.52	AVG	
5	2486.2500	52.60	6.23	58.83	74.00	-15.17	Peak	
6	2486.2500	46.80	6.23	53.03	54.00	-0.97	AVG	

REMARKS:

- (1) Measurement Value = Reading Level + Correct Factor.
- (2) Margin Level = Measurement Value - Limit Value.

Test Mode	TX B Mode 2462 MHz	Polarization	Vertical
-----------	--------------------	--------------	----------

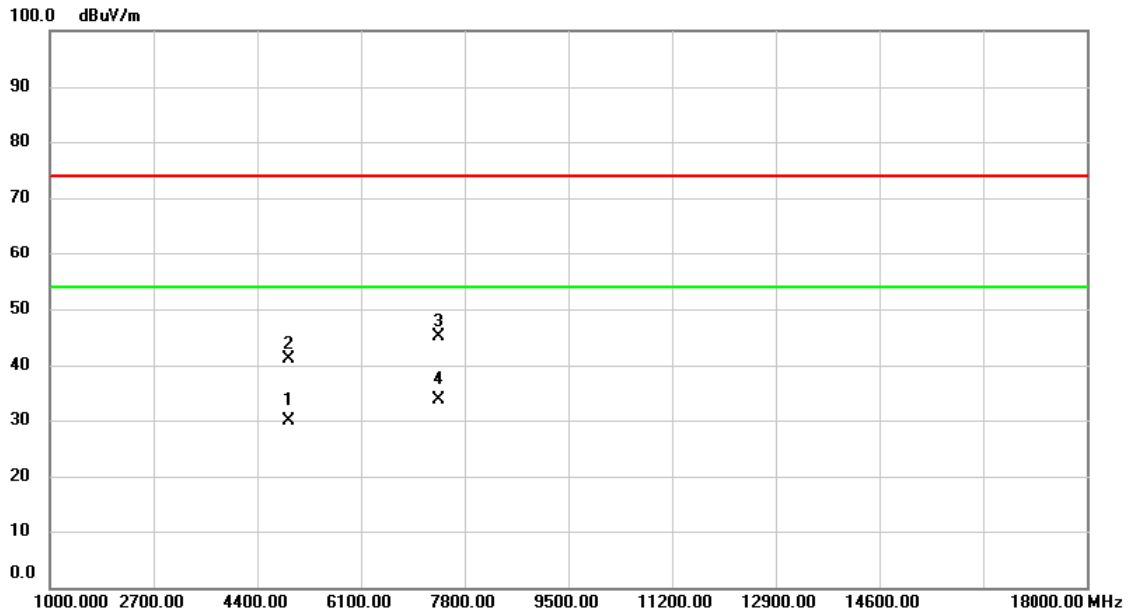

No. Mk.	Freq. MHz	Reading Level dBuV	Correct Factor dB	Measurement dBuV/m	Limit dBuV/m	Margin dB	Detector	Comment
1	4914.390	26.92	2.89	29.81	54.00	-24.19	AVG	
2	4918.250	38.33	2.90	41.23	74.00	-32.77	peak	
3	7378.000	36.78	8.32	45.10	74.00	-28.90	peak	
4 *	7389.460	25.37	8.33	33.70	54.00	-20.30	AVG	

REMARKS:

- (1) Measurement Value = Reading Level + Correct Factor.
- (2) Margin Level = Measurement Value - Limit Value.

Test Mode	TX G Mode 2412 MHz	Polarization	Vertical
-----------	--------------------	--------------	----------

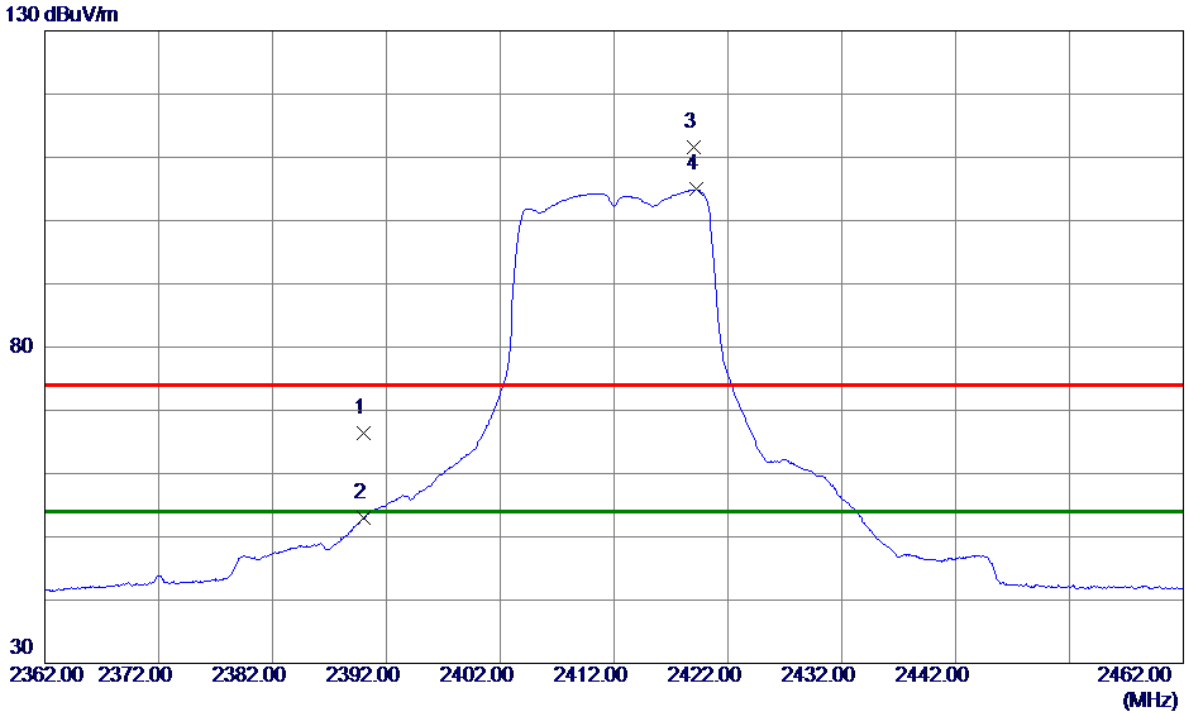

No.	Freq. MHz	Reading Level dBuV/m	Correct Factor dB	Measure ment dBuV/m	Limit dBuV/m	Margin dB	Detector	Comment
1	2390.0000	60.26	6.17	66.43	74.00	-7.57	Peak	
2	2390.0000	46.86	6.17	53.03	54.00	-0.97	AVG	
3	2419.0000	105.40	6.19	111.59	74.00	37.59	Peak	No Limit
4 *	2419.2500	98.72	6.19	104.91	54.00	50.91	AVG	No Limit

REMARKS:

- (1) Measurement Value = Reading Level + Correct Factor.
- (2) Margin Level = Measurement Value - Limit Value.

Test Mode	TX G Mode 2412 MHz	Polarization	Vertical
-----------	--------------------	--------------	----------

80 dBuV/m

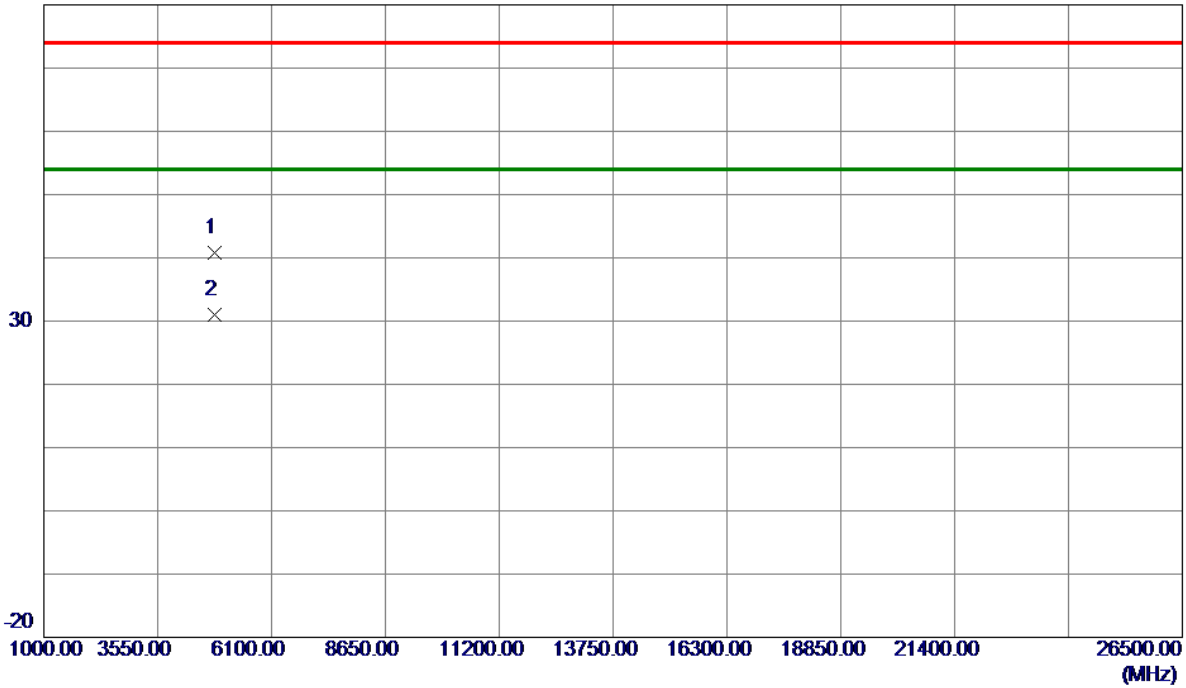

No.	Freq. MHz	Reading Level dBuV/m	Correct Factor dB	Measure ment dBuV/m	Limit dBuV/m	Margin dB	Detector	Comment
1	4823.5230	39.90	0.95	40.85	74.00	-33.15	Peak	
2 *	4823.8550	30.08	0.95	31.03	54.00	-22.97	AVG	

REMARKS:

- (1) Measurement Value = Reading Level + Correct Factor.
- (2) Margin Level = Measurement Value - Limit Value.

Test Mode	TX G Mode 2417 MHz	Polarization	Vertical
-----------	--------------------	--------------	----------

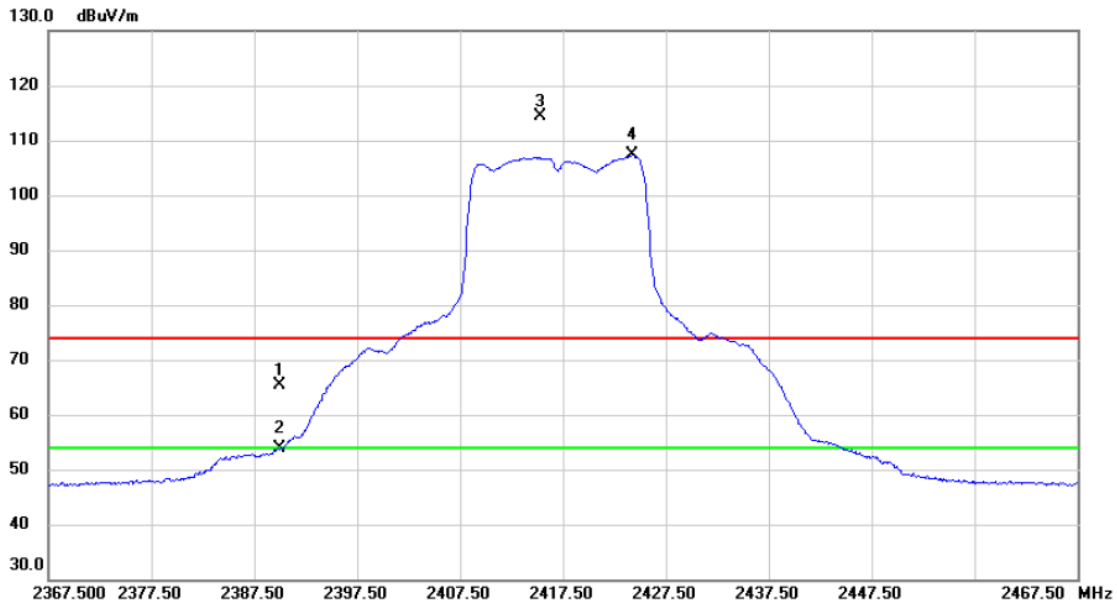

No.	Mk.	Freq. MHz	Reading Level dBuV	Correct Factor dB	Measure- ment dBuV/m	Limit dBuV/m	Margin dB	Detector	Comment
1		2390.000	58.10	7.22	65.32	74.00	-8.68	peak	
2		2390.000	46.69	7.22	53.91	54.00	-0.09	AVG	
3	X	2415.250	107.25	7.24	114.49	74.00	40.49	peak	No Limit
4	*	2424.250	100.11	7.24	107.35	54.00	53.35	AVG	No Limit

REMARKS:

- (1) Measurement Value = Reading Level + Correct Factor.
- (2) Margin Level = Measurement Value - Limit Value.

Test Mode	TX G Mode 2437 MHz	Polarization	Vertical
-----------	--------------------	--------------	----------

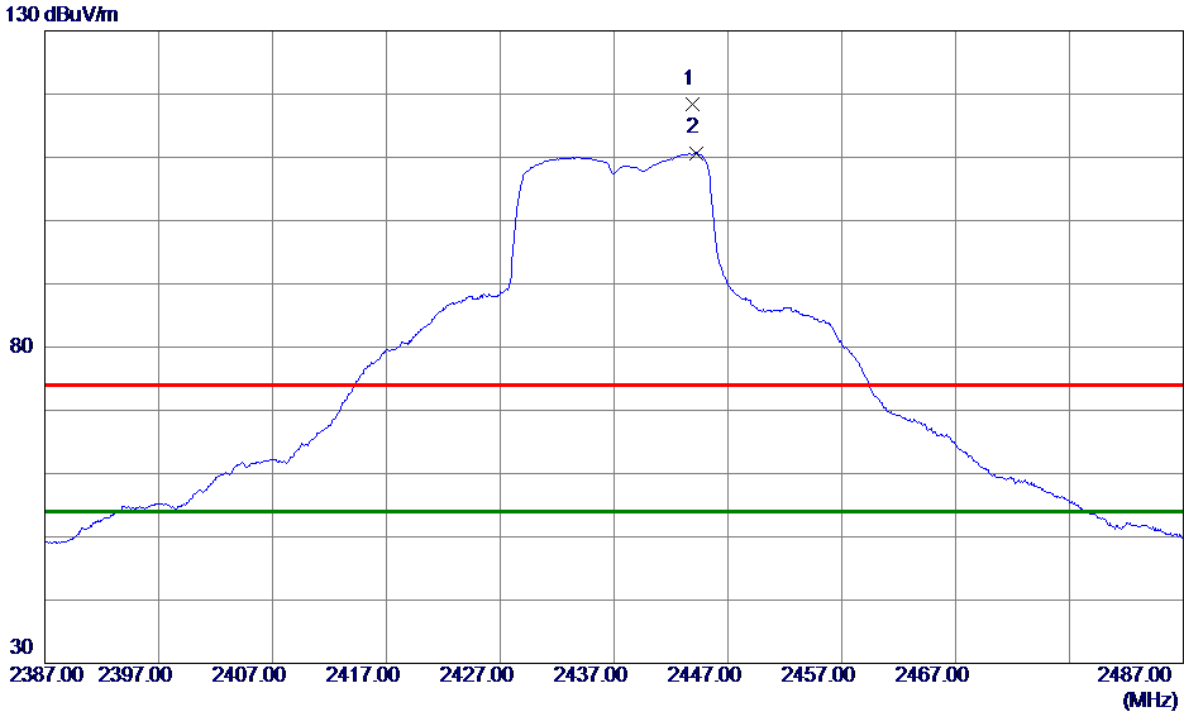

No.	Freq. MHz	Reading Level dBuV/m	Correct Factor dB	Measure ment dBuV/m	Limit dBuV/m	Margin dB	Detector	Comment
1	2443.9000	112.16	6.20	118.36	74.00	44.36	Peak	No Limit
2 *	2444.2000	104.50	6.20	110.70	54.00	56.70	AVG	No Limit

REMARKS:

- (1) Measurement Value = Reading Level + Correct Factor.
- (2) Margin Level = Measurement Value - Limit Value.

Test Mode	TX G Mode 2437 MHz	Polarization	Vertical
-----------	--------------------	--------------	----------

80 dBuV/m

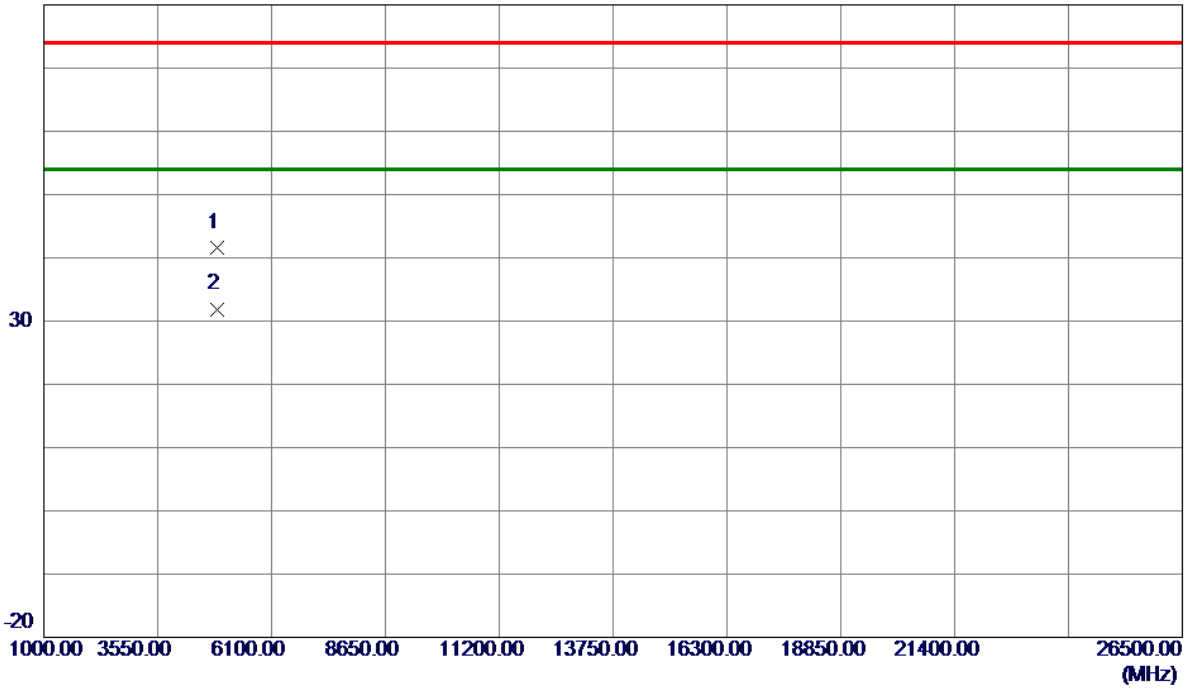

No.	Freq. MHz	Reading Level dBuV/m	Correct Factor dB	Measure ment dBuV/m	Limit dBuV/m	Margin dB	Detector	Comment
1	4871.8800	40.56	1.07	41.63	74.00	-32.37	Peak	
2 *	4874.0050	30.82	1.08	31.90	54.00	-22.10	AVG	

REMARKS:

- (1) Measurement Value = Reading Level + Correct Factor.
- (2) Margin Level = Measurement Value - Limit Value.

Test Mode	TX G Mode 2457 MHz	Polarization	Vertical
-----------	--------------------	--------------	----------

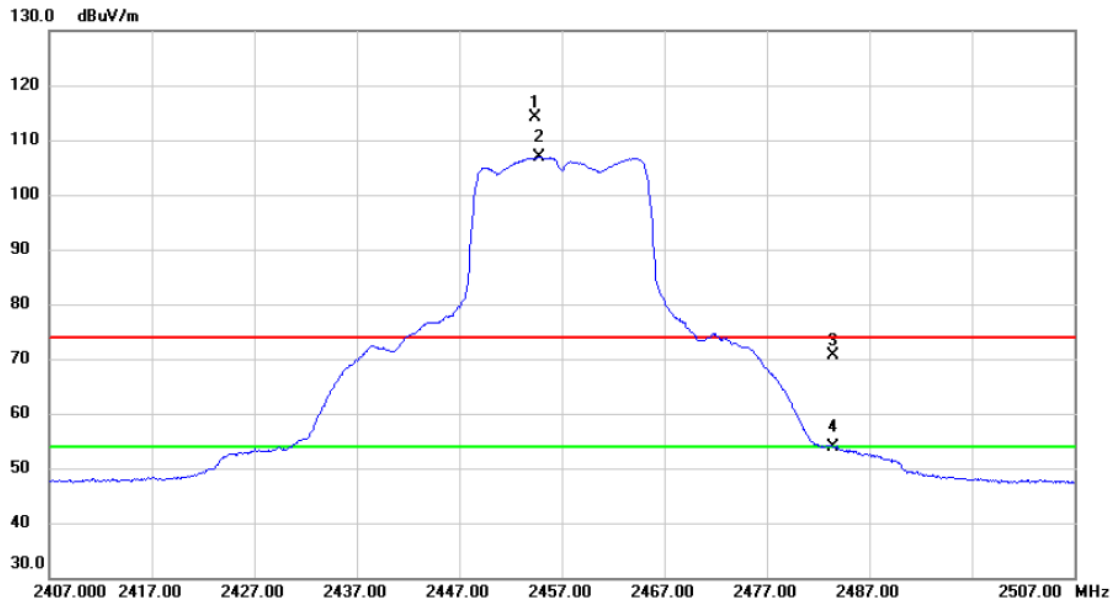

No.	Mk.	Freq. MHz	Reading Level dBuV	Correct Factor dB	Measure- ment dBuV/m	Limit dBuV/m	Margin dB	Detector	Comment
1	X	2454.400	106.93	7.26	114.19	74.00	40.19	peak	No Limit
2	*	2454.850	99.59	7.26	106.85	54.00	52.85	AVG	No Limit
3		2483.500	63.28	7.27	70.55	74.00	-3.45	peak	
4		2483.500	46.58	7.27	53.85	54.00	-0.15	AVG	

REMARKS:

- (1) Measurement Value = Reading Level + Correct Factor.
- (2) Margin Level = Measurement Value - Limit Value.

Test Mode	TX G Mode 2462 MHz	Polarization	Vertical
-----------	--------------------	--------------	----------

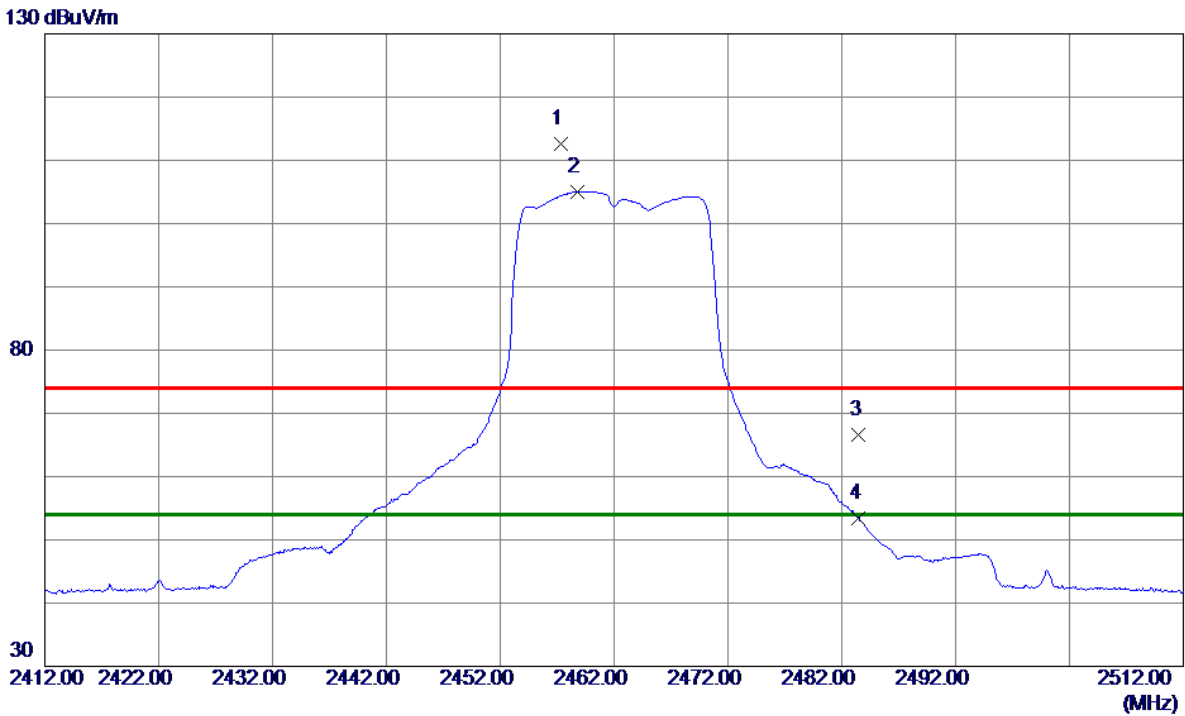

No.	Freq. MHz	Reading Level dBuV/m	Correct Factor dB	Measure ment dBuV/m	Limit dBuV/m	Margin dB	Detector	Comment
1	2457.3500	106.35	6.21	112.56	74.00	38.56	Peak	No Limit
2 *	2458.7500	98.89	6.21	105.10	54.00	51.10	AVG	No Limit
3	2483.5000	60.40	6.23	66.63	74.00	-7.37	Peak	
4	2483.5000	47.16	6.23	53.39	54.00	-0.61	AVG	

REMARKS:

- (1) Measurement Value = Reading Level + Correct Factor.
- (2) Margin Level = Measurement Value - Limit Value.

Test Mode	TX G Mode 2462 MHz	Polarization	Vertical
-----------	--------------------	--------------	----------

80 dBuV/m

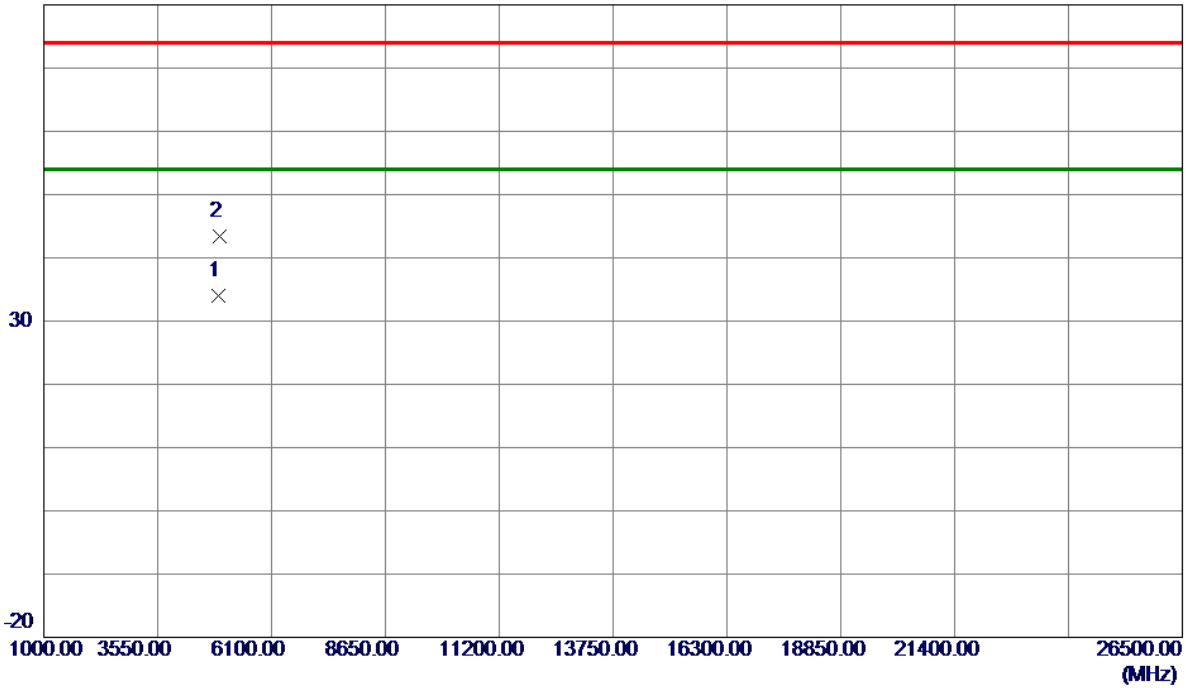

No.	Freq. MHz	Reading Level dBuV/m	Correct Factor dB	Measure ment dBuV/m	Limit dBuV/m	Margin dB	Detector	Comment
1 *	4924.1130	32.72	1.21	33.93	54.00	-20.07	AVG	
2	4925.3250	42.28	1.21	43.49	74.00	-30.51	Peak	

REMARKS:

- (1) Measurement Value = Reading Level + Correct Factor.
- (2) Margin Level = Measurement Value - Limit Value.

Test Mode	TX N(HT20) Mode 2412 MHz	Polarization	Vertical
-----------	--------------------------	--------------	----------

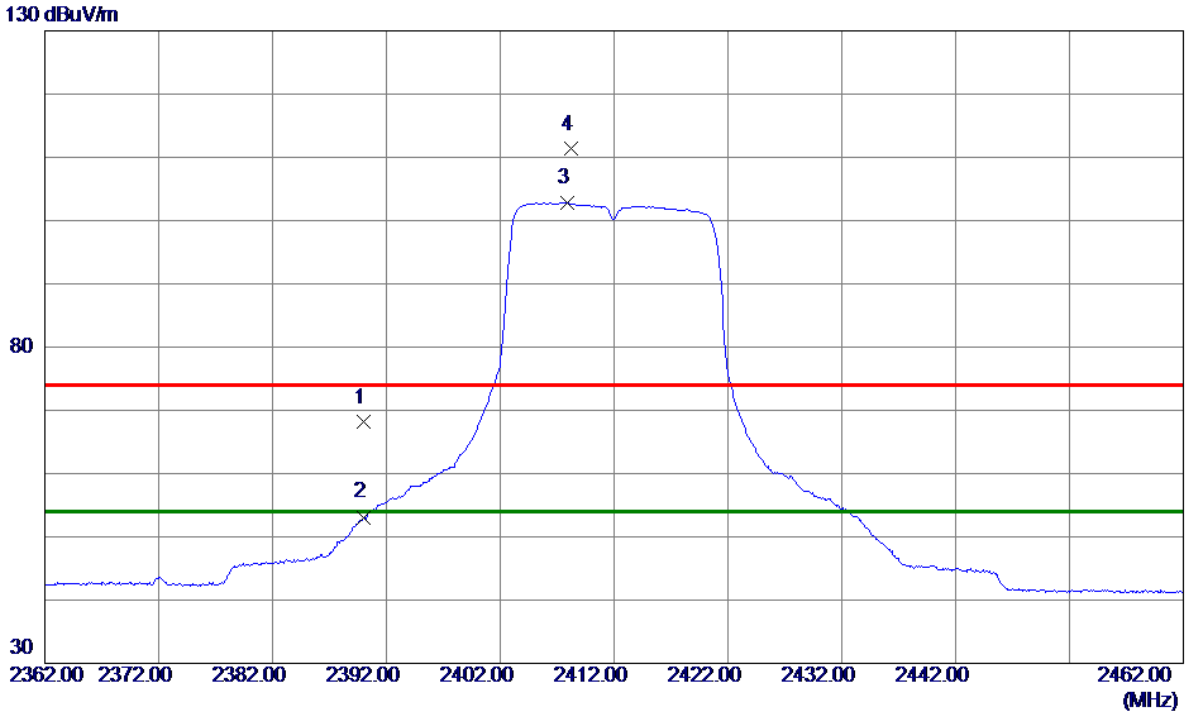

No.	Freq. MHz	Reading Level dBuV/m	Correct Factor dB	Measure ment dBuV/m	Limit dBuV/m	Margin dB	Detector	Comment
1	2390.0000	61.93	6.17	68.10	74.00	-5.90	Peak	
2	2390.0000	46.93	6.17	53.10	54.00	-0.90	AVG	
3 *	2407.8500	96.67	6.18	102.85	54.00	48.85	AVG	No Limit
4	2408.2500	105.12	6.18	111.30	74.00	37.30	Peak	No Limit

REMARKS:

- (1) Measurement Value = Reading Level + Correct Factor.
- (2) Margin Level = Measurement Value - Limit Value.

Test Mode	TX N(HT20) Mode 2412 MHz	Polarization	Vertical
-----------	--------------------------	--------------	----------

80 dBuV/m

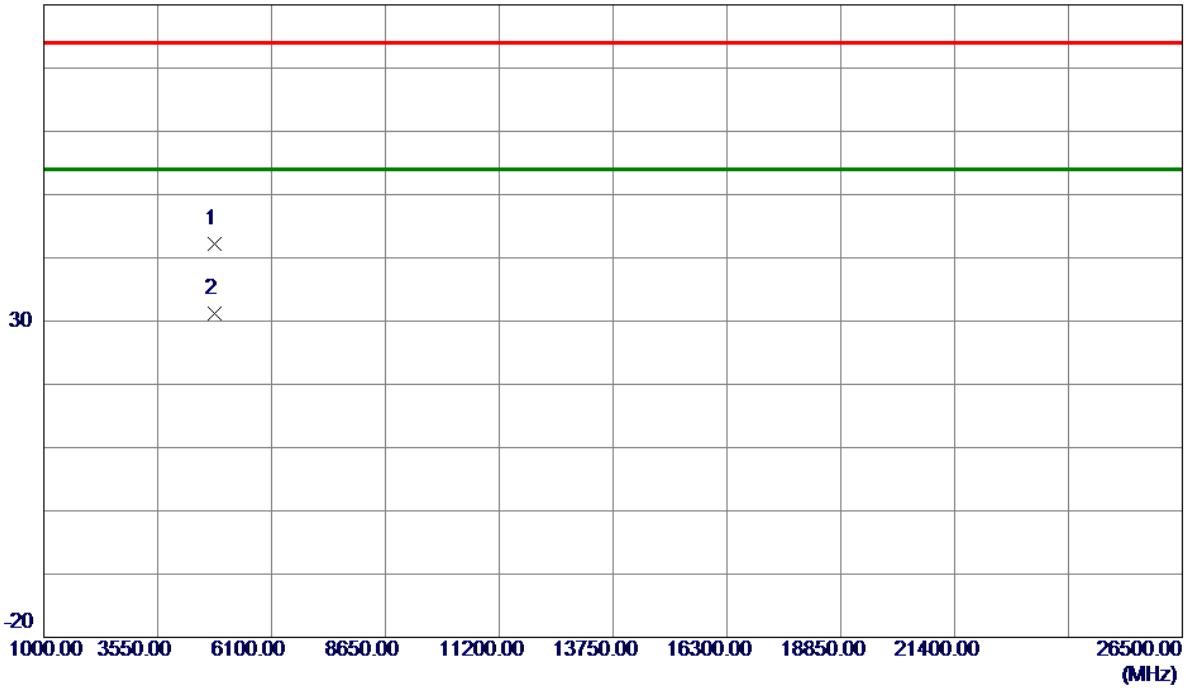

No.	Freq. MHz	Reading Level dBuV/m	Correct Factor dB	Measure ment dBuV/m	Limit dBuV/m	Margin dB	Detector	Comment
1	4825.1420	41.33	0.95	42.28	74.00	-31.72	Peak	
2 *	4825.7150	30.18	0.96	31.14	54.00	-22.86	AVG	

REMARKS:

- (1) Measurement Value = Reading Level + Correct Factor.
- (2) Margin Level = Measurement Value - Limit Value.

Test Mode	TX N(HT20) Mode 2417 MHz	Polarization	Vertical
-----------	--------------------------	--------------	----------

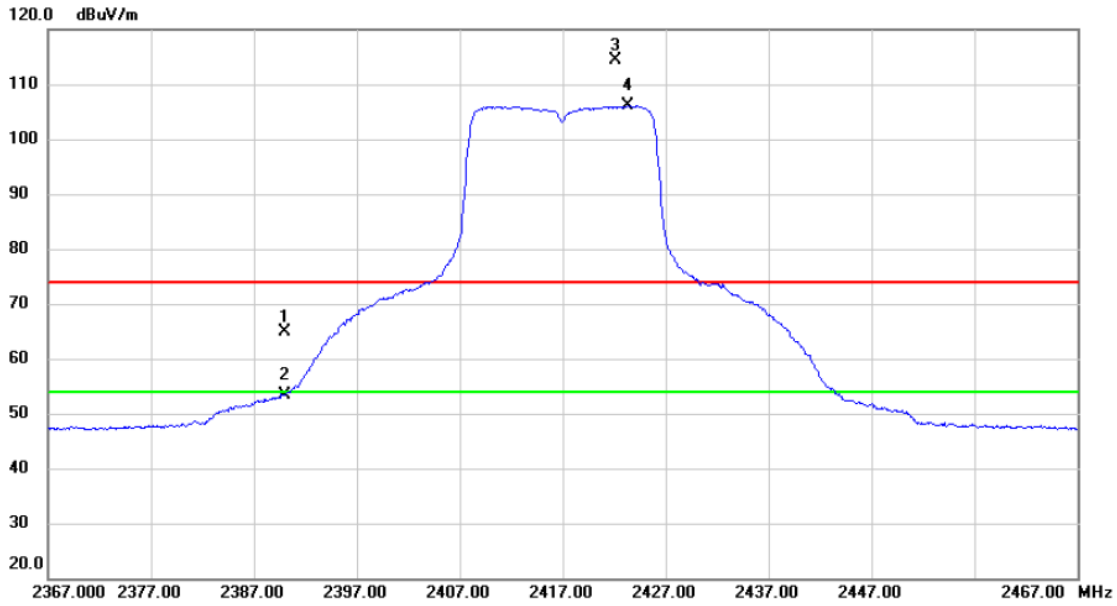

No. Mk.	Freq. MHz	Reading Level dBuV	Correct Factor dB	Measurement dBuV/m	Limit dBuV/m	Margin dB	Detector	Comment
1	2390.000	57.69	7.22	64.91	74.00	-9.09	peak	
2	2390.000	46.21	7.22	53.43	54.00	-0.57	AVG	
3 X	2422.150	107.19	7.24	114.43	74.00	40.43	peak	No Limit
4 *	2423.300	98.92	7.24	106.16	54.00	52.16	AVG	No Limit

REMARKS:

- (1) Measurement Value = Reading Level + Correct Factor.
- (2) Margin Level = Measurement Value - Limit Value.

Test Mode	TX N(HT20) Mode 2437 MHz	Polarization	Vertical
-----------	--------------------------	--------------	----------

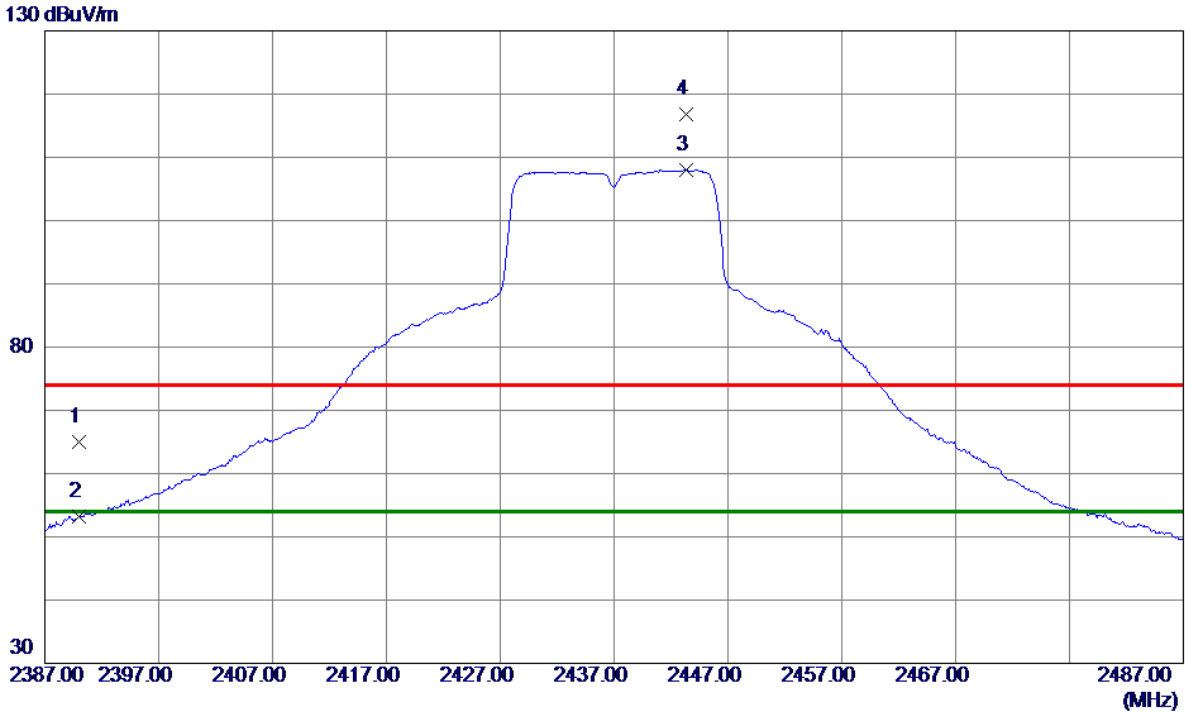

No.	Freq. MHz	Reading Level dBuV/m	Correct Factor dB	Measure ment dBuV/m	Limit dBuV/m	Margin dB	Detector	Comment
1	2390.0000	58.84	6.17	65.01	74.00	-8.99	Peak	
2	2390.0000	46.99	6.17	53.16	54.00	-0.84	AVG	
3 *	2443.3000	101.87	6.20	108.07	54.00	54.07	AVG	No Limit
4	2443.3500	110.59	6.20	116.79	74.00	42.79	Peak	No Limit

REMARKS:

- (1) Measurement Value = Reading Level + Correct Factor.
- (2) Margin Level = Measurement Value - Limit Value.

Test Mode	TX N(HT20) Mode 2437 MHz	Polarization	Vertical
-----------	--------------------------	--------------	----------

80 dBuV/m

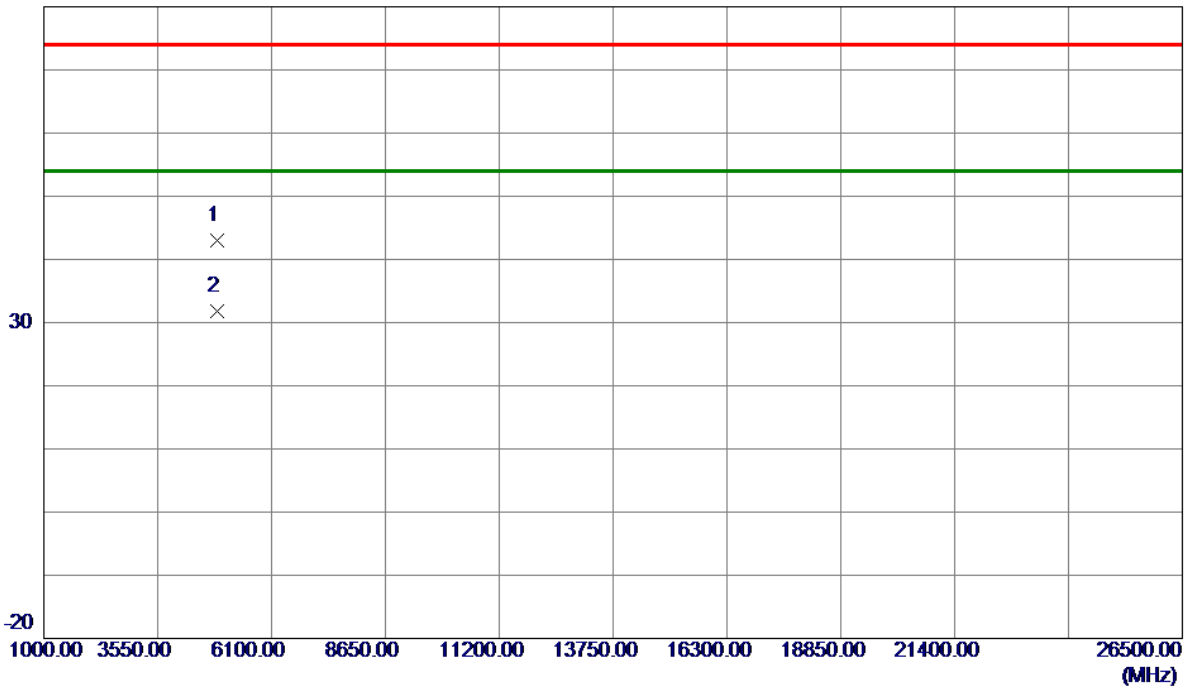

No.	Freq. MHz	Reading Level dBuV/m	Correct Factor dB	Measure ment dBuV/m	Limit dBuV/m	Margin dB	Detector	Comment
1	4876.3580	41.97	1.08	43.05	74.00	-30.95	Peak	
2 *	4876.5000	30.65	1.08	31.73	54.00	-22.27	AVG	

REMARKS:

- (1) Measurement Value = Reading Level + Correct Factor.
- (2) Margin Level = Measurement Value - Limit Value.

Test Mode	TX N(HT20) Mode 2457 MHz	Polarization	Vertical
-----------	--------------------------	--------------	----------

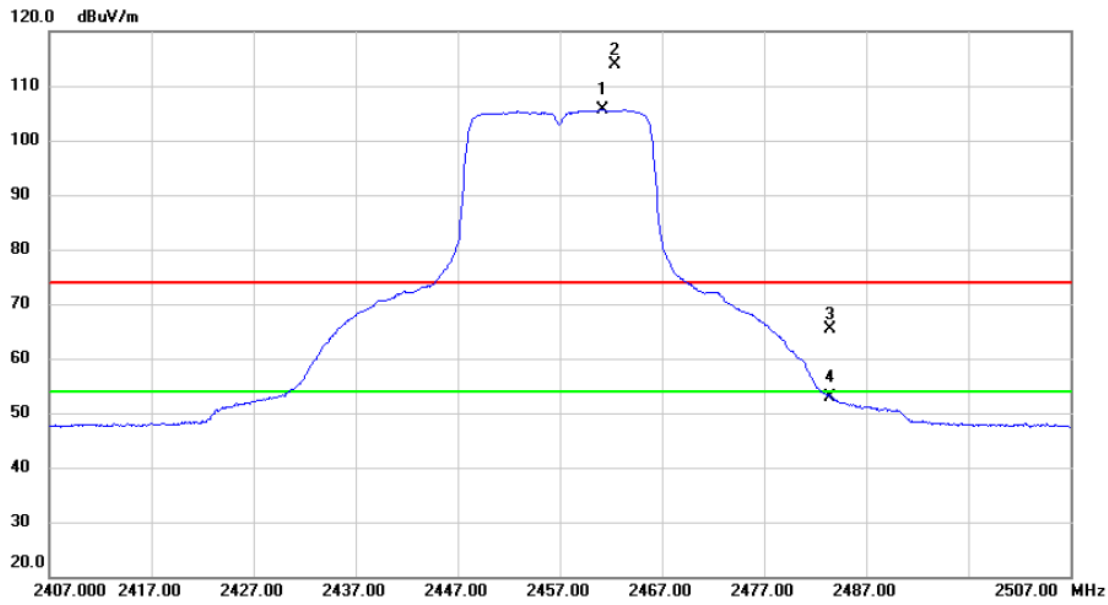

No.	Mk.	Freq. MHz	Reading Level dBuV	Correct Factor dB	Measure- ment dBuV/m	Limit dBuV/m	Margin dB	Detector	Comment
1	*	2461.150	98.35	7.26	105.61	54.00	51.61	AVG	No Limit
2	X	2462.450	106.58	7.26	113.84	74.00	39.84	peak	No Limit
3		2483.500	58.14	7.27	65.41	74.00	-8.59	peak	
4		2483.500	45.59	7.27	52.86	54.00	-1.14	AVG	

REMARKS:

- (1) Measurement Value = Reading Level + Correct Factor.
- (2) Margin Level = Measurement Value - Limit Value.

Test Mode	TX N(HT20) Mode 2462 MHz	Polarization	Vertical
-----------	--------------------------	--------------	----------

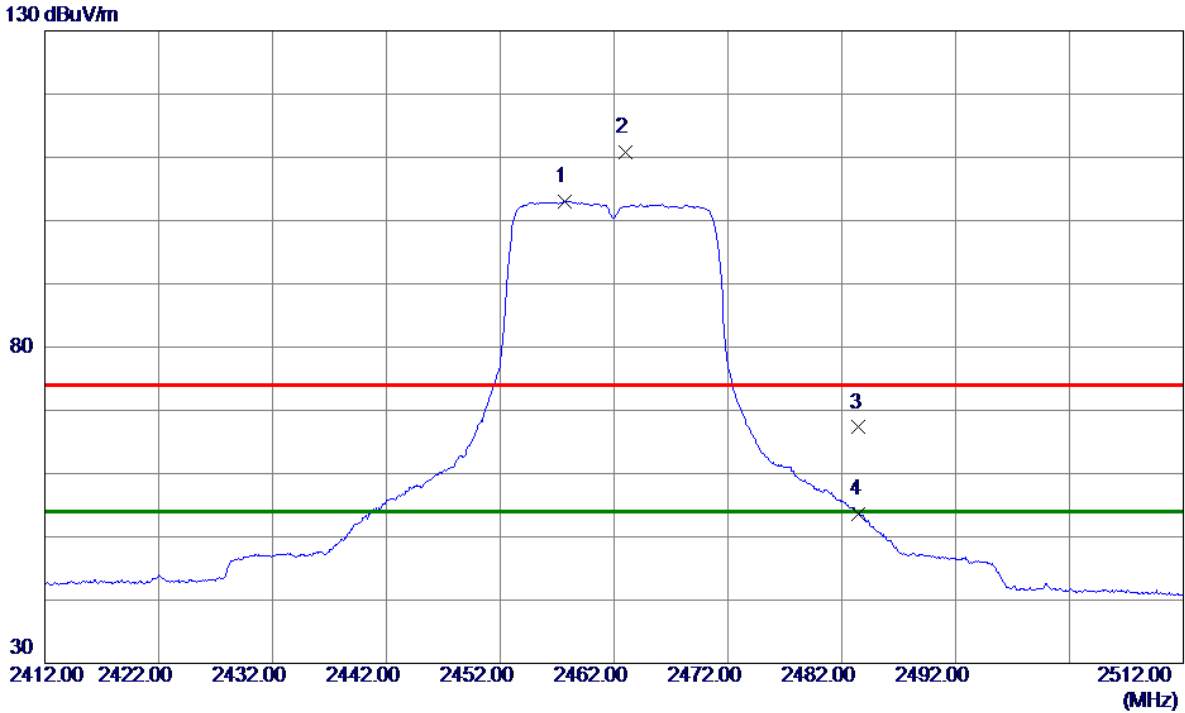

No.	Freq. MHz	Reading Level dBuV/m	Correct Factor dB	Measure ment dBuV/m	Limit dBuV/m	Margin dB	Detector	Comment
1 *	2457.7000	96.79	6.21	103.00	54.00	49.00	AVG	No Limit
2	2462.9500	104.56	6.22	110.78	74.00	36.78	Peak	No Limit
3	2483.5000	61.07	6.23	67.30	74.00	-6.70	Peak	
4	2483.5000	47.34	6.23	53.57	54.00	-0.43	AVG	

REMARKS:

- (1) Measurement Value = Reading Level + Correct Factor.
- (2) Margin Level = Measurement Value - Limit Value.

Test Mode	TX N(HT20) Mode 2462 MHz	Polarization	Vertical
-----------	--------------------------	--------------	----------

80 dBuV/m

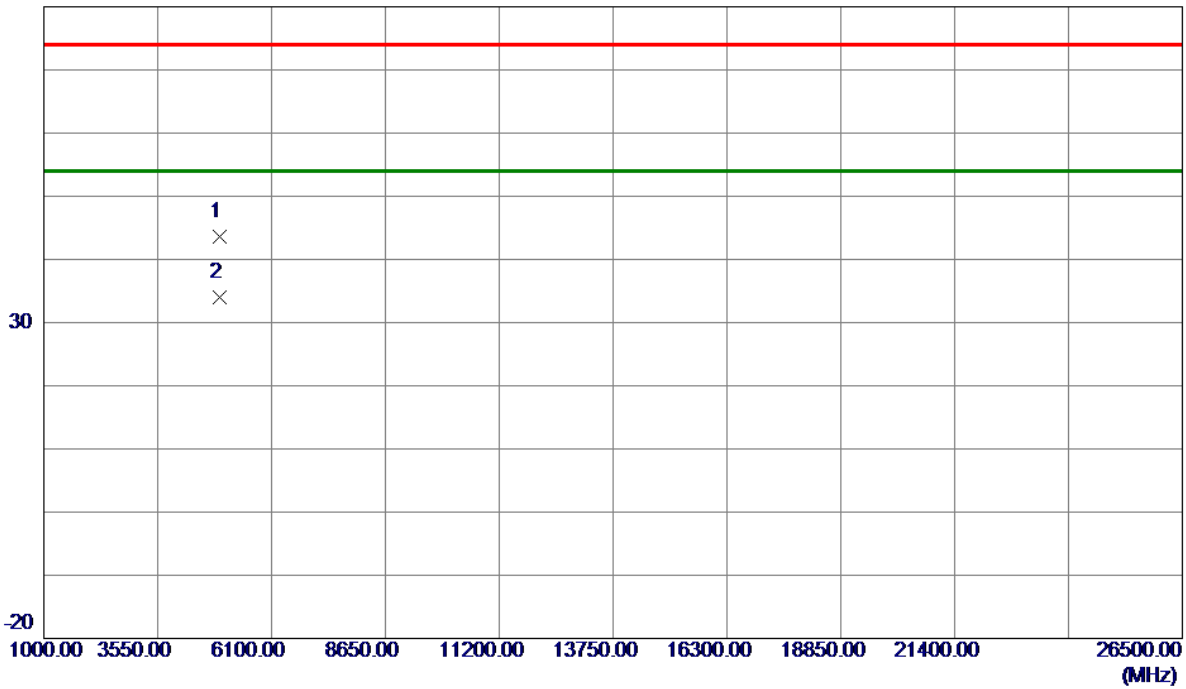

No.	Freq. MHz	Reading Level dBuV/m	Correct Factor dB	Measure ment dBuV/m	Limit dBuV/m	Margin dB	Detector	Comment
1	4926.2200	42.47	1.21	43.68	74.00	-30.32	Peak	
2 *	4926.4830	32.84	1.21	34.05	54.00	-19.95	AVG	

REMARKS:

- (1) Measurement Value = Reading Level + Correct Factor.
- (2) Margin Level = Measurement Value - Limit Value.

Test Mode	TX N(HT40) Mode 2422 MHz	Polarization	Vertical
-----------	--------------------------	--------------	----------

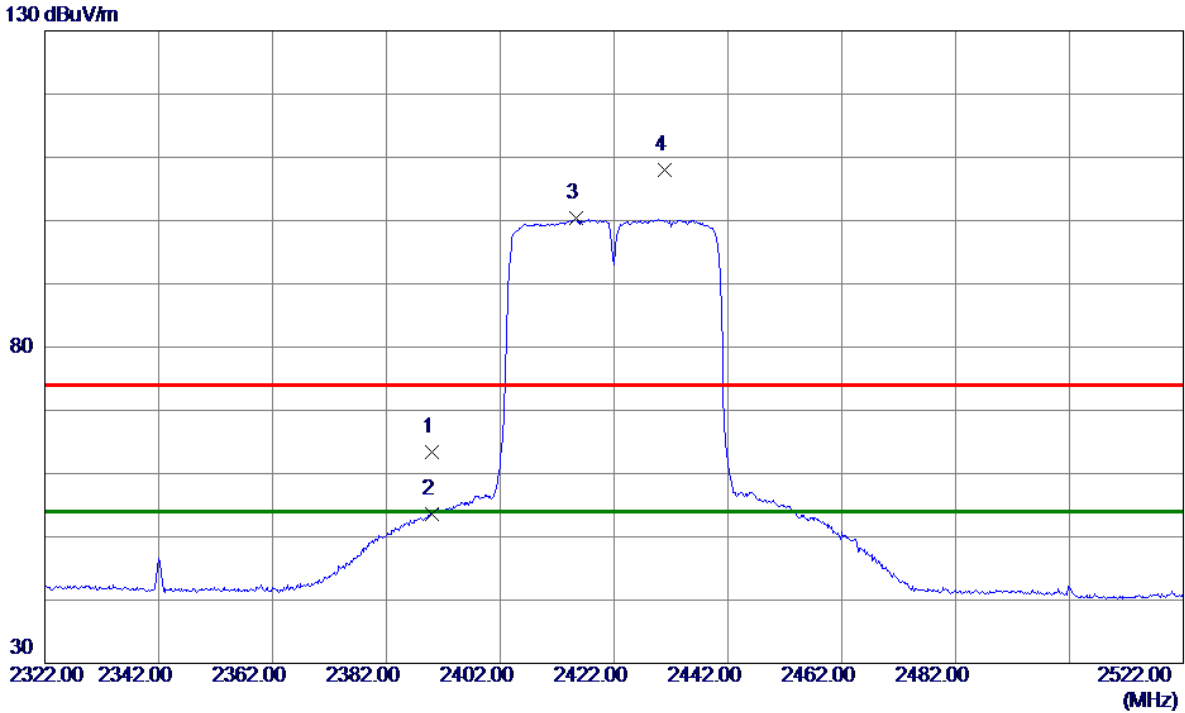

No.	Freq. MHz	Reading Level dBuV/m	Correct Factor dB	Measure ment dBuV/m	Limit dBuV/m	Margin dB	Detector	Comment
1	2390.0000	57.17	6.17	63.34	74.00	-10.66	Peak	
2	2390.0000	47.35	6.17	53.52	54.00	-0.48	AVG	
3 *	2415.3000	94.21	6.18	100.39	54.00	46.39	AVG	No Limit
4	2430.8000	101.84	6.19	108.03	74.00	34.03	Peak	No Limit

REMARKS:

- (1) Measurement Value = Reading Level + Correct Factor.
- (2) Margin Level = Measurement Value - Limit Value.

Test Mode	TX N(HT40) Mode 2422 MHz	Polarization	Vertical
-----------	--------------------------	--------------	----------

80 dBuV/m

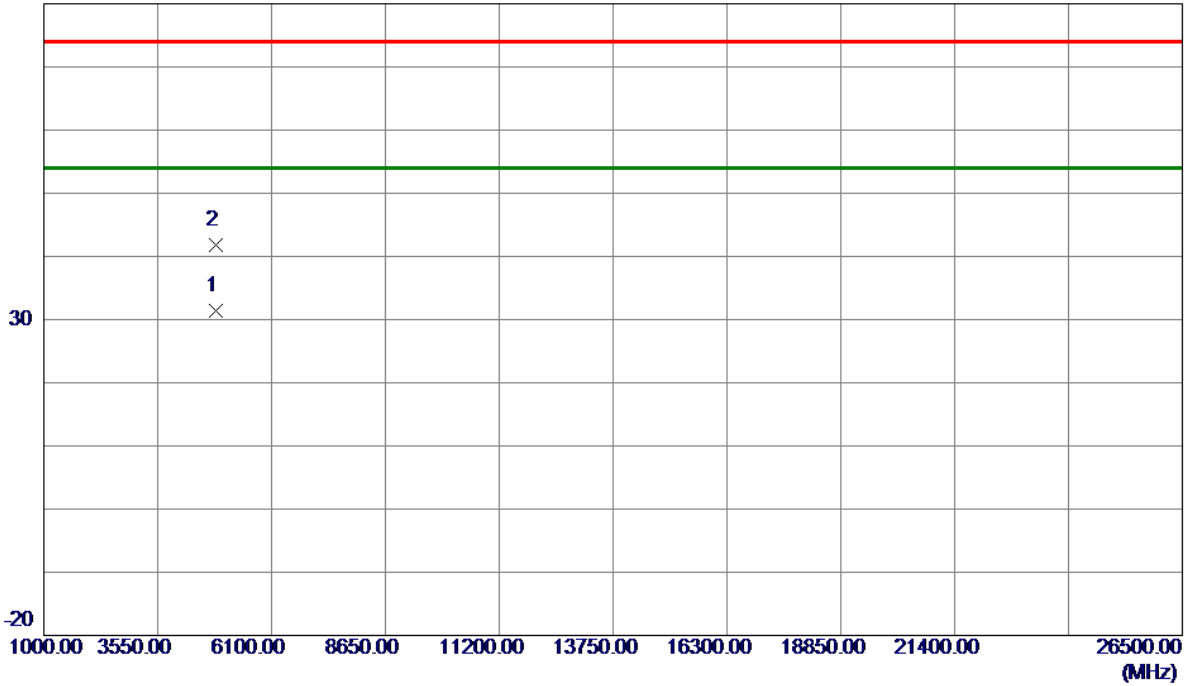

No.	Freq. MHz	Reading Level dBuV/m	Correct Factor dB	Measure ment dBuV/m	Limit dBuV/m	Margin dB	Detector	Comment
1 *	4845.9530	30.46	1.01	31.47	54.00	-22.53	AVG	
2	4846.0150	40.75	1.01	41.76	74.00	-32.24	Peak	

REMARKS:

- (1) Measurement Value = Reading Level + Correct Factor.
- (2) Margin Level = Measurement Value - Limit Value.

Test Mode	TX N(HT40) Mode 2427 MHz	Polarization	Vertical
-----------	--------------------------	--------------	----------

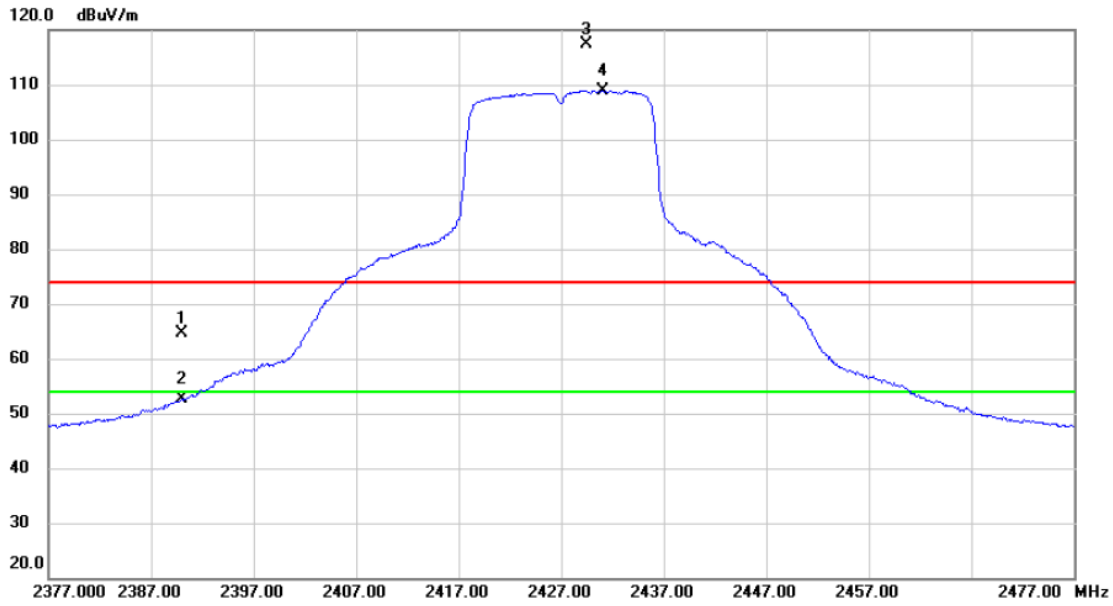

No.	Mk.	Freq. MHz	Reading Level dBuV	Correct Factor dB	Measure- ment dBuV/m	Limit dBuV/m	Margin dB	Detector	Comment
1		2390.000	57.35	7.22	64.57	74.00	-9.43	peak	
2		2390.000	45.30	7.22	52.52	54.00	-1.48	AVG	
3	X	2429.500	110.10	7.25	117.35	74.00	43.35	peak	No Limit
4	*	2431.100	101.71	7.25	108.96	54.00	54.96	AVG	No Limit

REMARKS:

- (1) Measurement Value = Reading Level + Correct Factor.
- (2) Margin Level = Measurement Value - Limit Value.

Test Mode	TX N(HT40) Mode 2437 MHz	Polarization	Vertical
-----------	--------------------------	--------------	----------

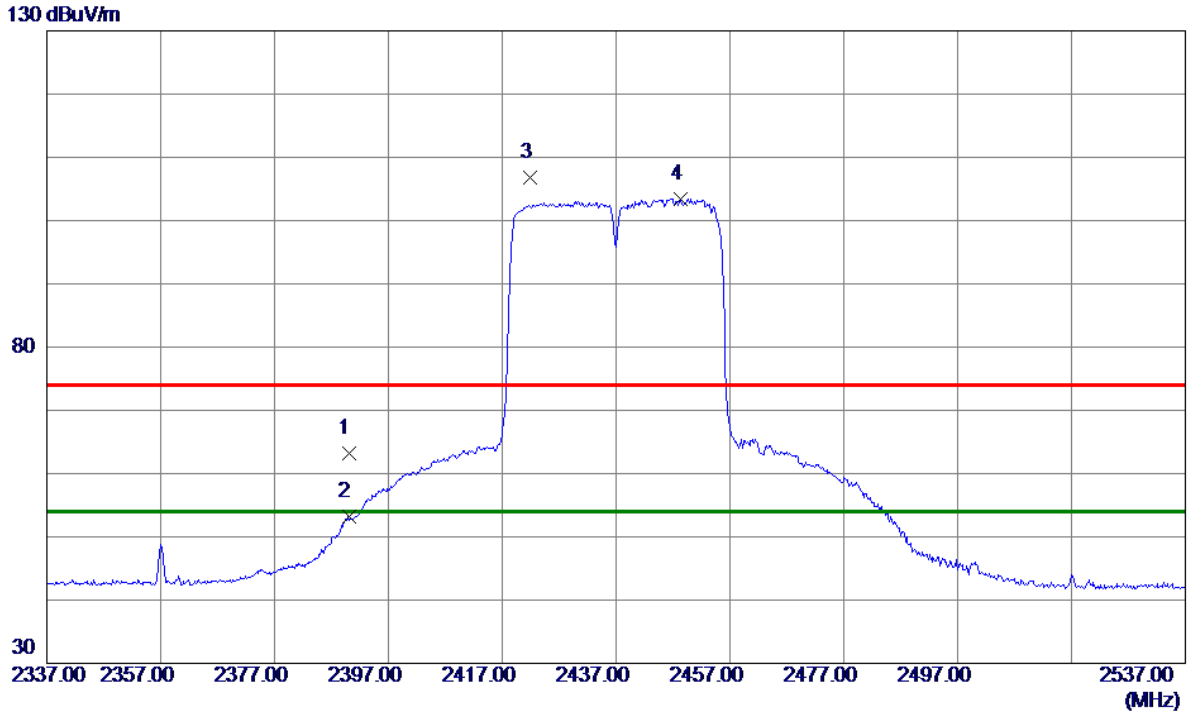

No.	Freq. MHz	Reading Level dBuV/m	Correct Factor dB	Measure ment dBuV/m	Limit dBuV/m	Margin dB	Detector	Comment
1	2390.0000	57.10	6.17	63.27	74.00	-10.73	Peak	
2	2390.0000	47.04	6.17	53.21	54.00	-0.79	AVG	
3	2421.8000	100.61	6.19	106.80	74.00	32.80	Peak	No Limit
4 *	2448.3000	97.28	6.21	103.49	54.00	49.49	AVG	No Limit

REMARKS:

- (1) Measurement Value = Reading Level + Correct Factor.
- (2) Margin Level = Measurement Value - Limit Value.

Test Mode	TX N(HT40) Mode 2437 MHz	Polarization	Vertical
-----------	--------------------------	--------------	----------

80 dBuV/m

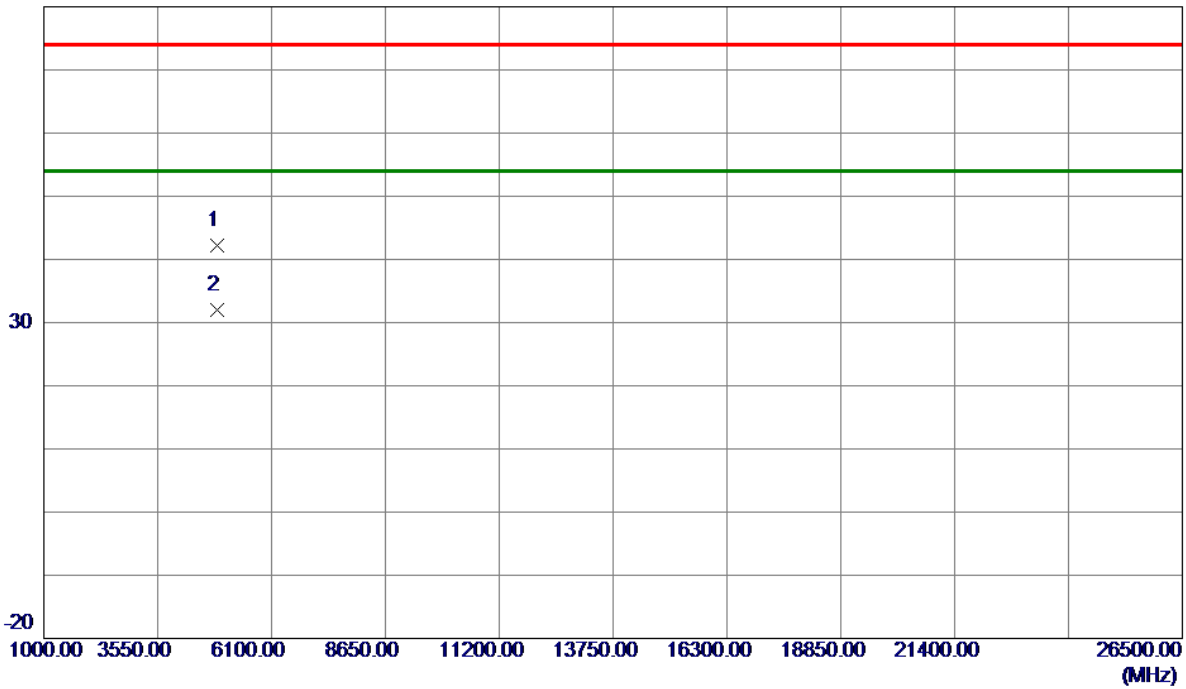

No.	Freq. MHz	Reading Level dBuV/m	Correct Factor dB	Measure ment dBuV/m	Limit dBuV/m	Margin dB	Detector	Comment
1	4875.9500	41.18	1.08	42.26	74.00	-31.74	Peak	
2 *	4876.3520	30.83	1.08	31.91	54.00	-22.09	AVG	

REMARKS:

- (1) Measurement Value = Reading Level + Correct Factor.
- (2) Margin Level = Measurement Value - Limit Value.

Test Mode	TX N(HT40) Mode 2452 MHz	Polarization	Vertical
-----------	--------------------------	--------------	----------

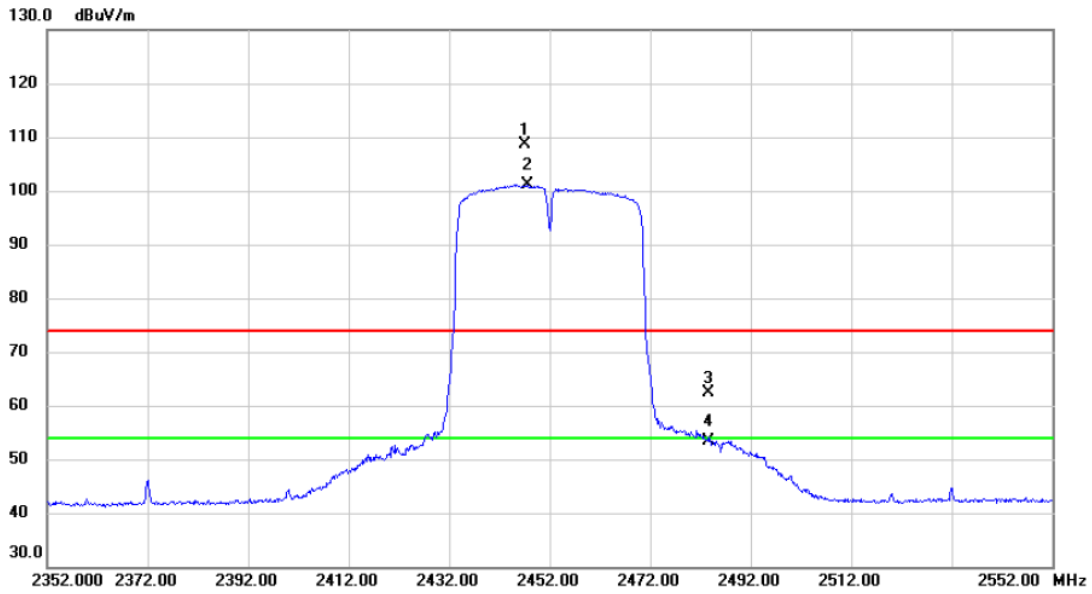

No.	Mk.	Freq. MHz	Reading Level dBuV	Correct Factor dB	Measure- ment dBuV/m	Limit dBuV/m	Margin dB	Detector	Comment
1	X	2447.200	102.40	6.21	108.61	74.00	34.61	peak	No Limit
2	*	2447.600	95.03	6.21	101.24	54.00	47.24	AVG	No Limit
3		2483.500	56.17	6.22	62.39	74.00	-11.61	peak	
4		2483.500	47.19	6.22	53.41	54.00	-0.59	AVG	

REMARKS:

(1) Measurement Value = Reading Level + Correct Factor.

(2) Margin Level = Measurement Value - Limit Value.

Test Mode	TX N(HT40) Mode 2452 MHz	Polarization	Vertical
-----------	--------------------------	--------------	----------

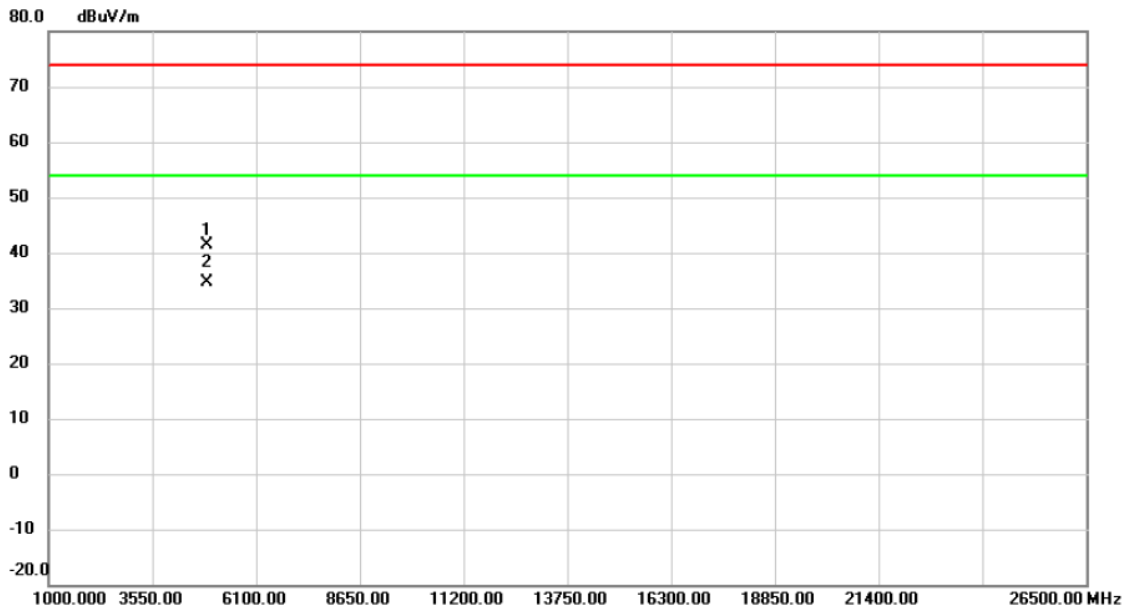

No. Mk.	Freq. MHz	Reading Level dBuV	Correct Factor dB	Measure- ment dBuV/m	Limit dBuV/m	Margin dB	Detector	Comment
1	4902.238	40.17	1.15	41.32	74.00	-32.68	peak	
2 *	4903.958	33.40	1.15	34.55	54.00	-19.45	AVG	

REMARKS:

- (1) Measurement Value = Reading Level + Correct Factor.
- (2) Margin Level = Measurement Value - Limit Value.

Test Mode	TX N(HT40) Mode 2457 MHz	Polarization	Vertical
-----------	--------------------------	--------------	----------

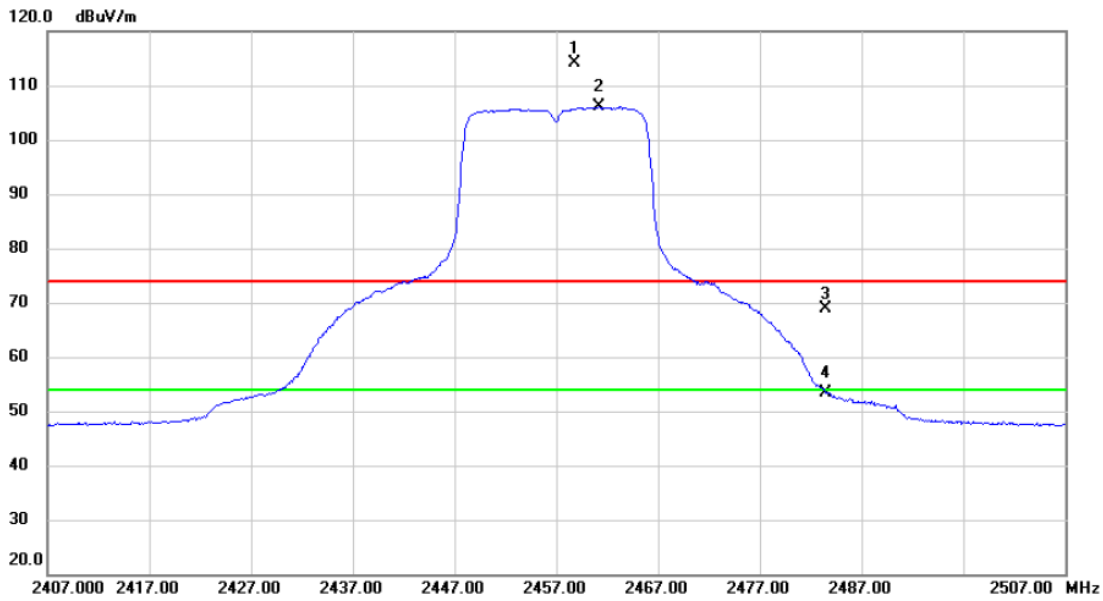

No. Mk.	Freq. MHz	Reading Level dBuV	Correct Factor dB	Measurement dBuV/m	Limit dBuV/m	Margin dB	Detector	Comment
1 X	2458.850	106.77	7.26	114.03	74.00	40.03	peak	No Limit
2 *	2461.150	98.82	7.26	106.08	54.00	52.08	AVG	No Limit
3	2483.500	61.62	7.27	68.89	74.00	-5.11	peak	
4	2483.500	46.21	7.27	53.48	54.00	-0.52	AVG	

REMARKS:

- (1) Measurement Value = Reading Level + Correct Factor.
- (2) Margin Level = Measurement Value - Limit Value.

Test Mode	TX G Mode Channel 06	Polarization	Vertical
-----------	----------------------	--------------	----------

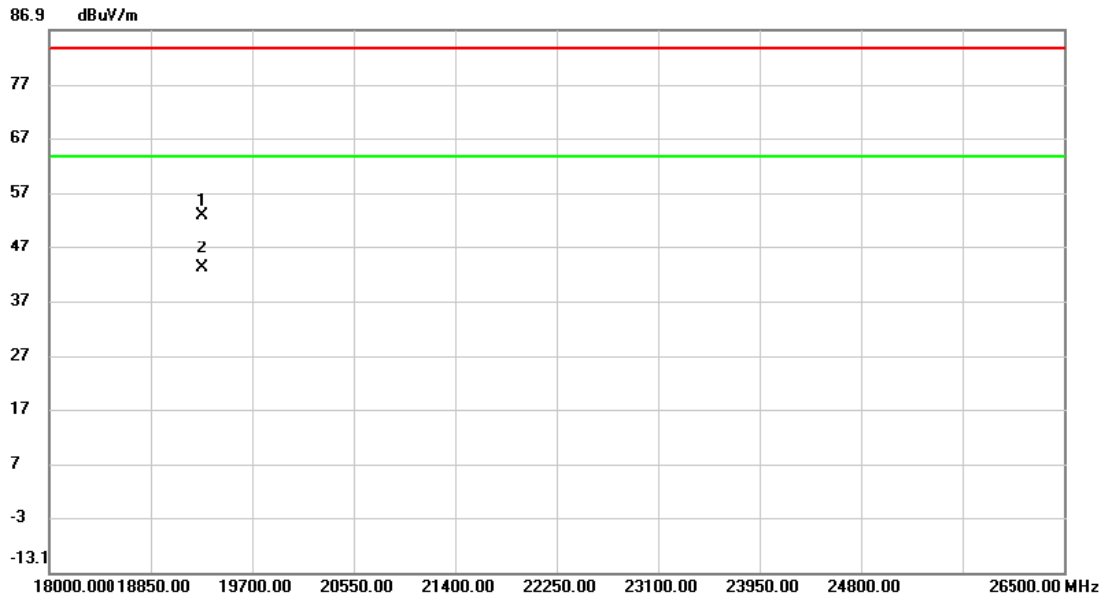

No.	Mk.	Freq.	Reading Level	Correct Factor	Measurement	Limit	Margin	Detector	Comment
		MHz	dBuV	dB	dBuV/m	dBuV/m	dB		
1		19270.750	54.01	-1.29	52.72	83.50	-30.78	peak	
2	*	19270.750	44.36	-1.29	43.07	63.50	-20.43	AVG	

REMARKS:

- (1) Measurement Value = Reading Level + Correct Factor.
- (2) Margin Level = Measurement Value - Limit Value.

Test Mode	TX G Mode Channel 06	Polarization	Horizontal
-----------	----------------------	--------------	------------

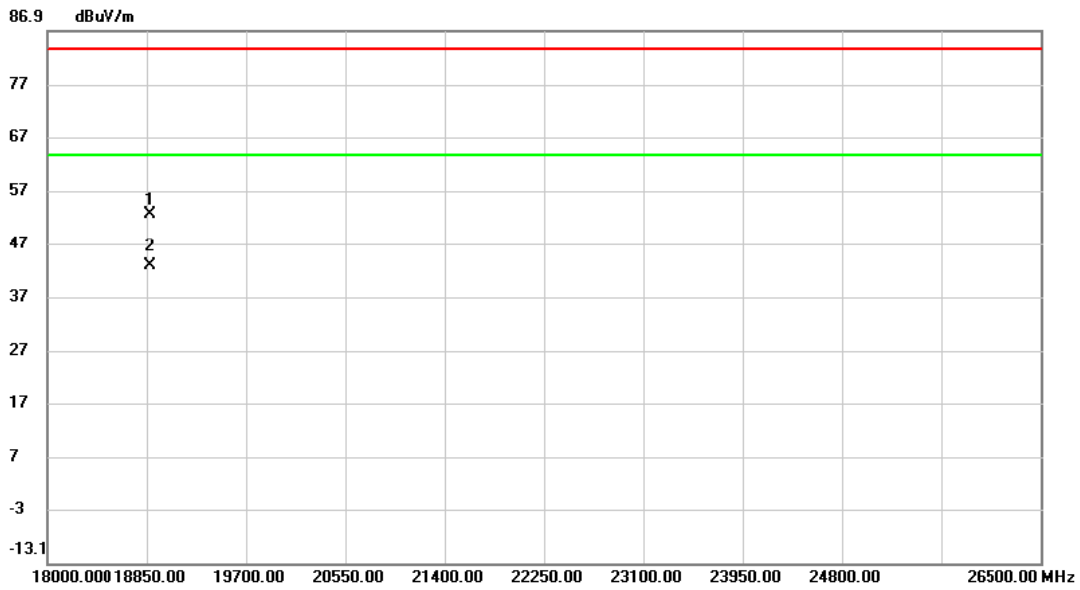

No.	Mk.	Freq. MHz	Reading Level dBuV	Correct Factor dB	Measure- ment dBuV/m	Limit dBuV/m	Margin dB	Detector	Comment
1		18875.500	53.97	-1.48	52.49	83.50	-31.01	peak	
2	*	18875.500	44.21	-1.48	42.73	63.50	-20.77	AVG	

REMARKS:

- (1) Measurement Value = Reading Level + Correct Factor.
- (2) Margin Level = Measurement Value - Limit Value.

APPENDIX E - BANDWIDTH

Test Mode	TX B Mode
-----------	-----------

Channel	Frequency (MHz)	6 dB Bandwidth (MHz)	99 % Occupied Bandwidth (MHz)	6 dB Bandwidth Min. Limit (MHz)	Result
01	2412	10.100	15.680	0.5	Complies
06	2437	10.100	15.680	0.5	Complies
11	2462	10.100	15.840	0.5	Complies

CH01

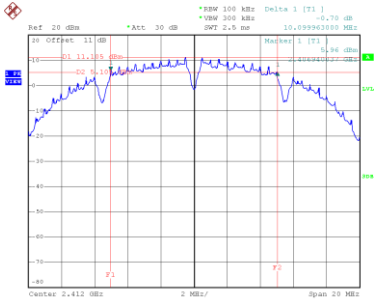

Date: 10_DEC.2023 10:00:51

CH06
6 dB Bandwidth

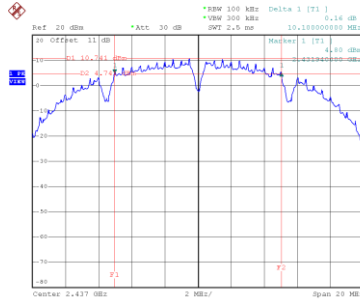

Date: 10_DEC.2023 10:00:47

CH11

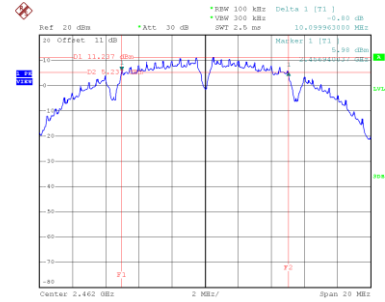

Date: 10_DEC.2023 10:00:51

99 % Occupied Bandwidth

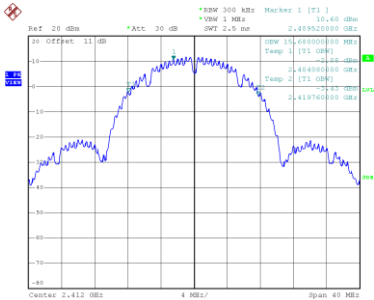

Date: 10_DEC.2023 10:00:58

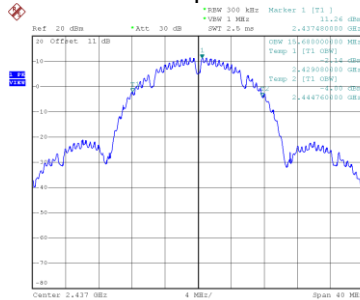

Date: 10_DEC.2023 10:00:55

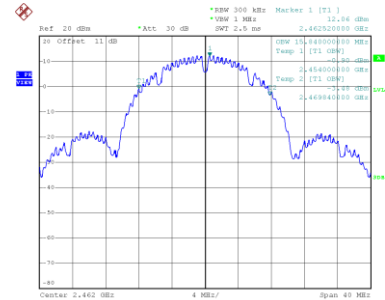

Date: 10_DEC.2023 10:00:58

Test Mode	TX G Mode
-----------	-----------

Channel	Frequency (MHz)	6 dB Bandwidth (MHz)	99 % Occupied Bandwidth (MHz)	6 dB Bandwidth Min. Limit (MHz)	Result
01	2412	16.360	20.960	0.5	Complies
06	2437	16.380	21.040	0.5	Complies
11	2462	16.420	20.560	0.5	Complies

CH01

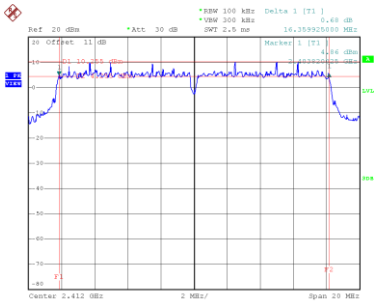

Date: 10_DEC.2023 10:11:53

CH06
6 dB Bandwidth

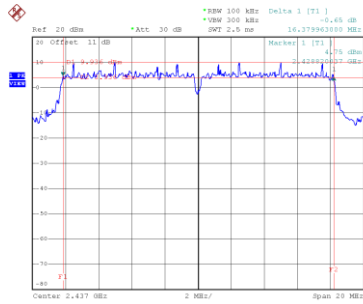

Date: 10_DEC.2023 10:13:57

CH11

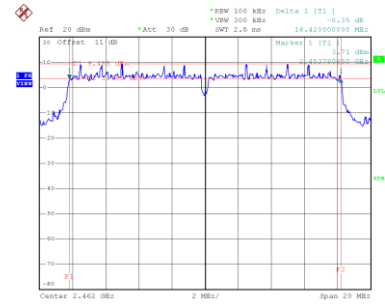

Date: 10_DEC.2023 10:15:21

99 % Occupied Bandwidth

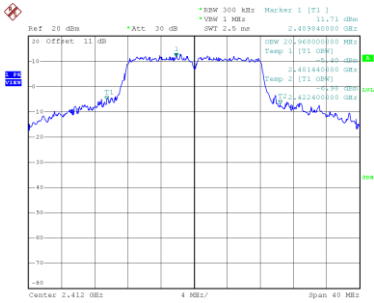

Date: 10_DEC.2023 10:12:00

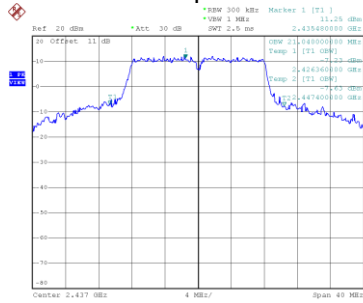

Date: 10_DEC.2023 10:14:04

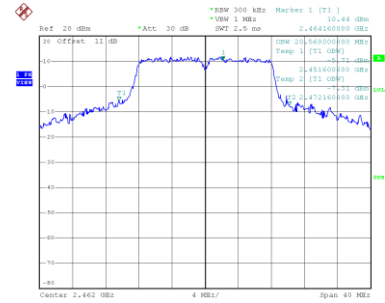

Date: 10_DEC.2023 10:15:29

Test Mode	TX N(HT20) Mode
-----------	-----------------

Channel	Frequency (MHz)	6 dB Bandwidth (MHz)	99 % Occupied Bandwidth (MHz)	6 dB Bandwidth Min. Limit (MHz)	Result
01	2412	17.069	21.760	0.5	Complies
06	2437	17.160	23.120	0.5	Complies
11	2462	17.199	23.600	0.5	Complies

CH01

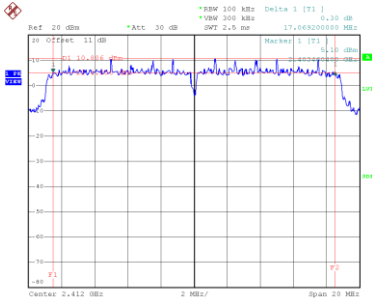

Date: 10_DEC.2023 10:57:12

CH06
6 dB Bandwidth

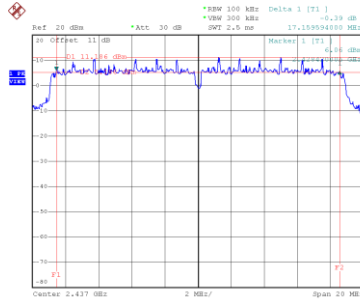

Date: 10_DEC.2023 10:34:23

CH11

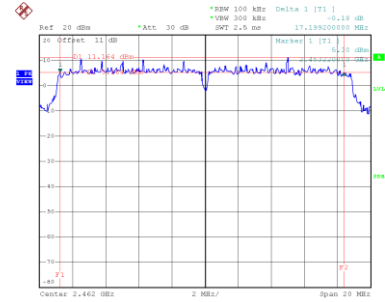

Date: 10_DEC.2023 10:57:39

99 % Occupied Bandwidth

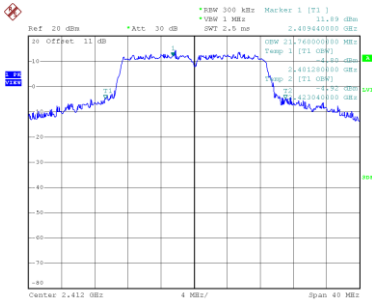

Date: 10_DEC.2023 10:57:19

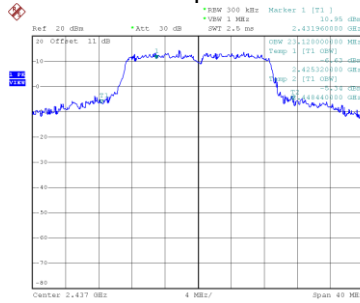

Date: 10_DEC.2023 10:34:30

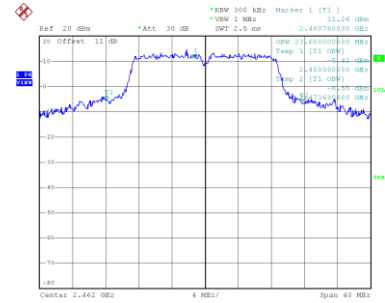

Date: 10_DEC.2023 10:57:46

Test Mode TX N(HT40) Mode

Channel	Frequency (MHz)	6 dB Bandwidth (MHz)	99 % Occupied Bandwidth (MHz)	6 dB Bandwidth Min. Limit (MHz)	Result
03	2422	35.510	48.320	0.5	Complies
06	2437	35.669	46.240	0.5	Complies
09	2452	35.919	45.600	0.5	Complies

CH03

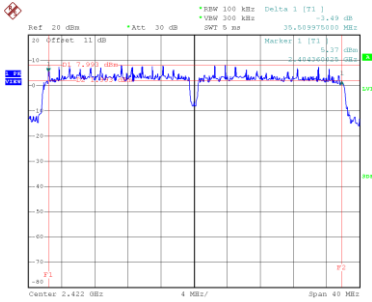

Date: 10_DEC.2023 10:55:142

CH06
6 dB Bandwidth

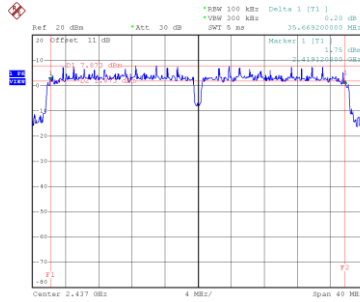

Date: 10_DEC.2023 10:52:103

CH09

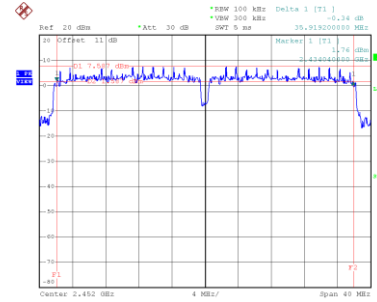

Date: 10_DEC.2023 10:53:104

99 % Occupied Bandwidth

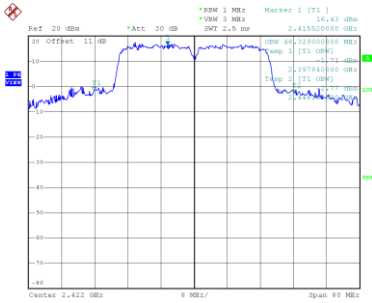

Date: 10_DEC.2023 10:55:149

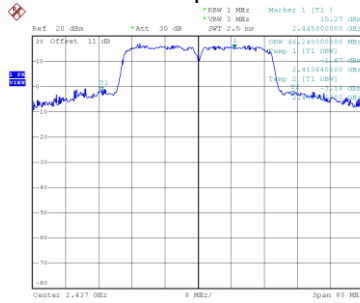

Date: 10_DEC.2023 10:52:111

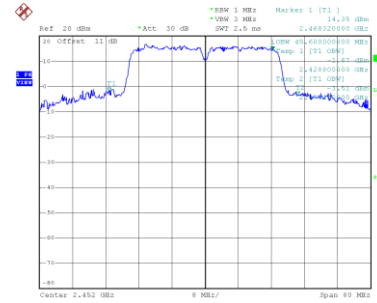

Date: 10_DEC.2023 10:53:111

APPENDIX F - MAXIMUM OUTPUT POWER

Test Mode	TX B Mode_Ant. 1
-----------	------------------

Channel	Frequency (MHz)	Output Power (dBm)	Duty Factor	Output Power + Duty Factor (dBm)	Max. Limit (dBm)	Max. Limit (W)	Result
01	2412	19.27	0.09	19.36	30.00	1.0000	Complies
06	2437	21.18	0.09	21.27	30.00	1.0000	Complies
11	2462	17.80	0.09	17.89	30.00	1.0000	Complies

Test Mode	TX B Mode_Ant. 2
-----------	------------------

Channel	Frequency (MHz)	Output Power (dBm)	Duty Factor	Output Power + Duty Factor (dBm)	Max. Limit (dBm)	Max. Limit (W)	Result
01	2412	18.80	0.09	18.89	30.00	1.0000	Complies
06	2437	21.55	0.09	21.64	30.00	1.0000	Complies
11	2462	17.28	0.09	17.37	30.00	1.0000	Complies

Test Mode	TX B Mode_Total
-----------	-----------------

Channel	Frequency (MHz)	Output Power (dBm)	Max. Limit (dBm)	Max. Limit (W)	Result
01	2412	22.15	30.00	1.0000	Complies
06	2437	24.47	30.00	1.0000	Complies
11	2462	20.65	30.00	1.0000	Complies

Test Mode	TX G Mode_Ant. 1
-----------	------------------

Channel	Frequency (MHz)	Output Power (dBm)	Duty Factor	Output Power + Duty Factor (dBm)	Max. Limit (dBm)	Max. Limit (W)	Result
01	2412	14.88	0.17	15.05	30.00	1.0000	Complies
06	2437	21.28	0.17	21.45	30.00	1.0000	Complies
11	2462	21.06	0.17	21.23	30.00	1.0000	Complies

Test Mode	TX G Mode_Ant. 2
-----------	------------------

Channel	Frequency (MHz)	Output Power (dBm)	Duty Factor	Output Power + Duty Factor (dBm)	Max. Limit (dBm)	Max. Limit (W)	Result
01	2412	14.51	0.17	14.68	30.00	1.0000	Complies
06	2437	21.51	0.17	21.68	30.00	1.0000	Complies
11	2462	21.51	0.17	21.68	30.00	1.0000	Complies

Test Mode	TX G Mode_Total
-----------	-----------------

Channel	Frequency (MHz)	Output Power (dBm)	Max. Limit (dBm)	Max. Limit (W)	Result
01	2412	17.88	30.00	1.0000	Complies
06	2437	24.58	30.00	1.0000	Complies
11	2462	24.47	30.00	1.0000	Complies

Test Mode	TX N(HT20) Mode_Ant. 1
-----------	------------------------

Channel	Frequency (MHz)	Output Power (dBm)	Duty Factor	Output Power + Duty Factor (dBm)	Max. Limit (dBm)	Max. Limit (W)	Result
01	2412	13.94	0.36	14.30	30.00	1.0000	Complies
06	2437	20.93	0.36	21.29	30.00	1.0000	Complies
11	2462	13.21	0.36	13.57	30.00	1.0000	Complies

Test Mode	TX N(HT20) Mode_Ant. 2
-----------	------------------------

Channel	Frequency (MHz)	Output Power (dBm)	Duty Factor	Output Power + Duty Factor (dBm)	Max. Limit (dBm)	Max. Limit (W)	Result
01	2412	13.90	0.36	14.26	30.00	1.0000	Complies
06	2437	20.49	0.36	20.85	30.00	1.0000	Complies
11	2462	13.92	0.36	14.28	30.00	1.0000	Complies

Test Mode	TX N(HT20) Mode_Total
-----------	-----------------------

Channel	Frequency (MHz)	Output Power (dBm)	Max. Limit (dBm)	Max. Limit (W)	Result
01	2412	17.29	30.00	1.0000	Complies
06	2437	24.09	30.00	1.0000	Complies
11	2462	16.95	30.00	1.0000	Complies

Test Mode	TX N(HT40) Mode_Ant. 1
-----------	------------------------

Channel	Frequency (MHz)	Output Power (dBm)	Duty Factor	Output Power + Duty Factor (dBm)	Max. Limit (dBm)	Max. Limit (W)	Result
03	2422	12.96	0.65	13.61	30.00	1.0000	Complies
06	2437	14.57	0.65	15.22	30.00	1.0000	Complies
09	2452	12.05	0.65	12.70	30.00	1.0000	Complies

Test Mode	TX N(HT40) Mode_Ant. 2
-----------	------------------------

Channel	Frequency (MHz)	Output Power (dBm)	Duty Factor	Output Power + Duty Factor (dBm)	Max. Limit (dBm)	Max. Limit (W)	Result
03	2422	12.49	0.65	13.14	30.00	1.0000	Complies
06	2437	14.63	0.65	15.28	30.00	1.0000	Complies
09	2452	12.46	0.65	13.11	30.00	1.0000	Complies

Test Mode	TX N(HT40) Mode_Total
-----------	-----------------------

Channel	Frequency (MHz)	Output Power (dBm)	Max. Limit (dBm)	Max. Limit (W)	Result
03	2422	16.39	30.00	1.0000	Complies
06	2437	18.26	30.00	1.0000	Complies
09	2452	15.92	30.00	1.0000	Complies

APPENDIX G - CONDUCTED SPURIOUS EMISSIONS

Test Mode TX B Mode_Ant. 1

Reference Level-CH01

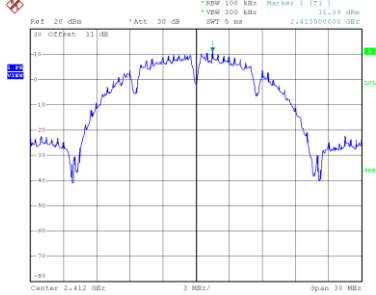

Date: 10.DEC.2023 11:46:14

Reference Level-CH06

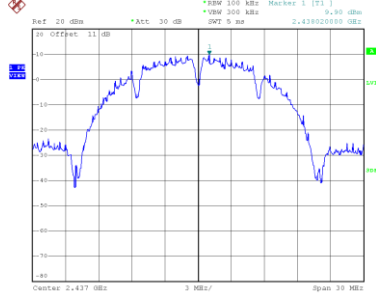

Date: 10.DEC.2023 11:46:19

Reference Level-CH11

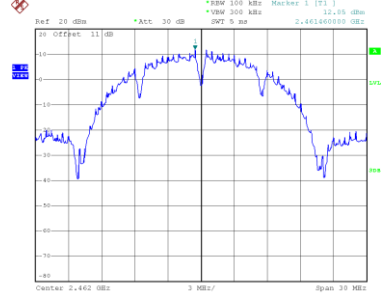

Date: 10.DEC.2023 11:47:23

Bandedge-CH01

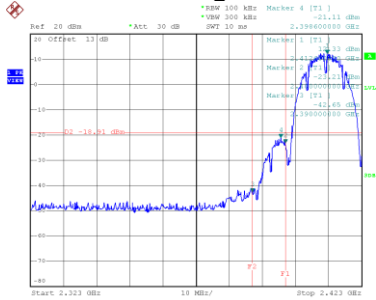

Date: 10.DEC.2023 12:32:23

Bandedge-CH11

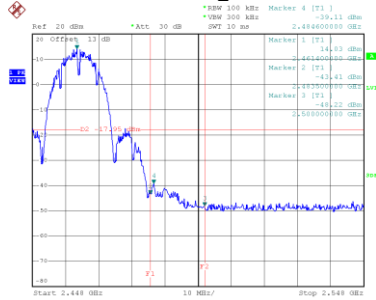

Date: 10.DEC.2023 12:34:34

CH01 – 10th Harmonic of the fundamental frequency

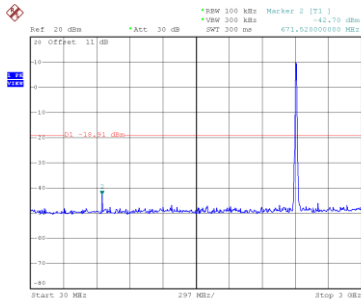

Date: 10_DEC.2023 13:32:14

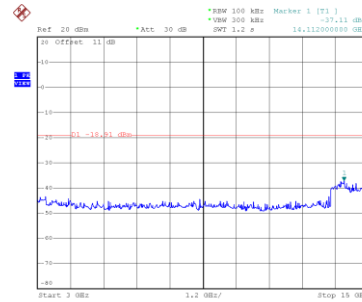

Date: 10_DEC.2023 13:32:23

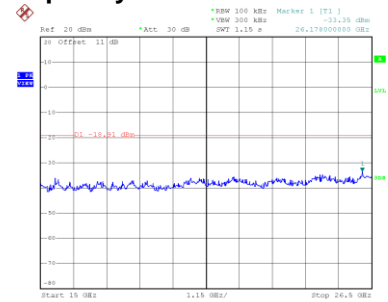

Date: 10_DEC.2023 13:32:32

CH06 – 10th Harmonic of the fundamental frequency

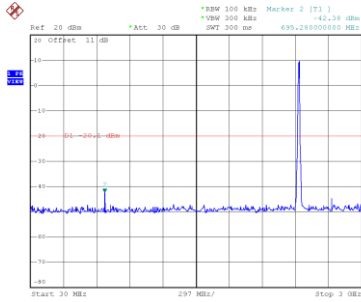

Date: 10_DEC.2023 13:33:05

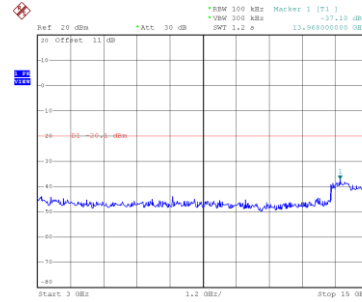

Date: 10_DEC.2023 13:33:14

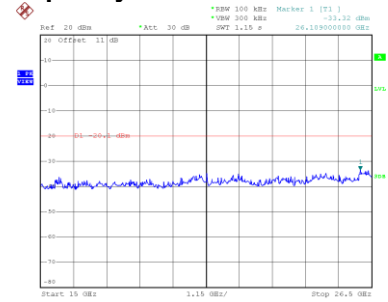

Date: 10_DEC.2023 13:33:22

CH11 – 10th Harmonic of the fundamental frequency

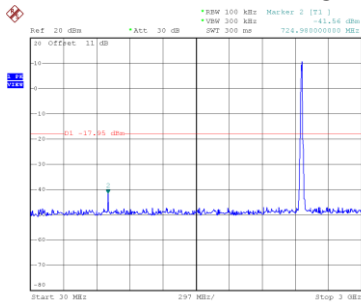

Date: 10_DEC.2023 13:33:45

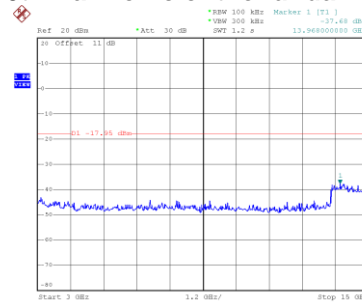

Date: 10_DEC.2023 13:33:53

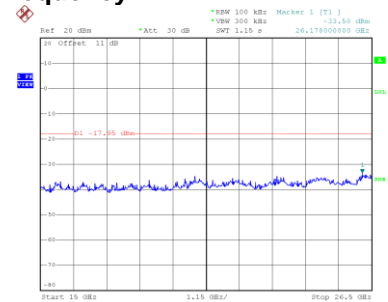

Date: 10_DEC.2023 13:34:02

Test Mode

TX B Mode_Ant. 2

Reference Level-CH01

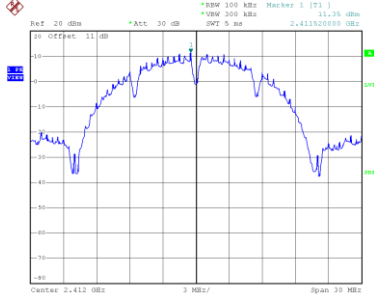

Date: 10.DEC.2023 11:53:43

Reference Level-CH06

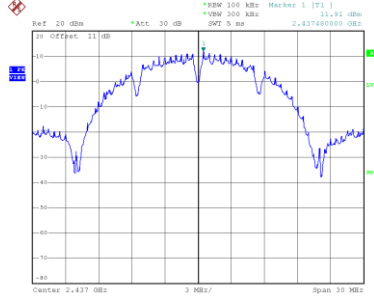

Date: 10.DEC.2023 11:54:13

Reference Level-CH11

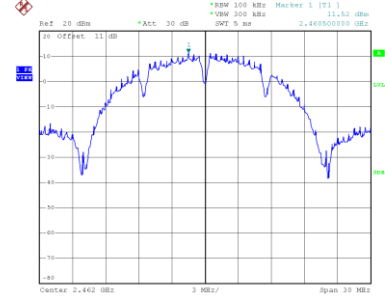

Date: 10.DEC.2023 11:54:35

Bandedge-CH01

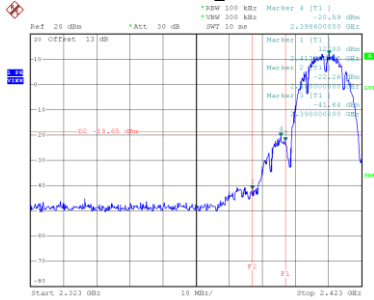

Date: 10.DEC.2023 12:59:42

Bandedge-CH11

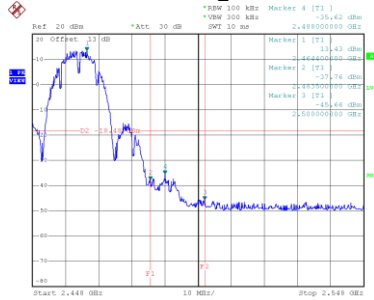

Date: 10.DEC.2023 13:02:02

CH01 – 10th Harmonic of the fundamental frequency

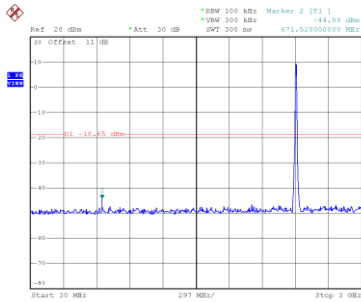

Date: 10.DEC.2023 13:23:18

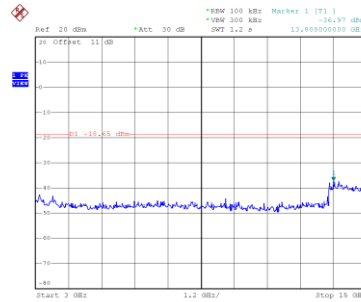

Date: 10.DEC.2023 13:23:27

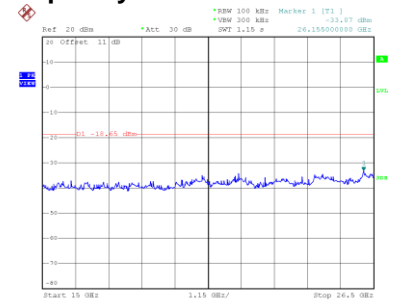

Date: 10.DEC.2023 13:23:35

CH06 – 10th Harmonic of the fundamental frequency

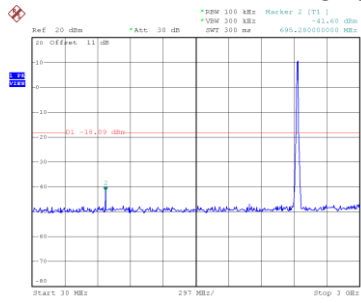

Date: 10.DEC.2023 13:23:55

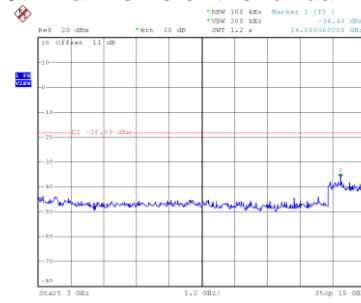

Date: 10.DEC.2023 13:24:04

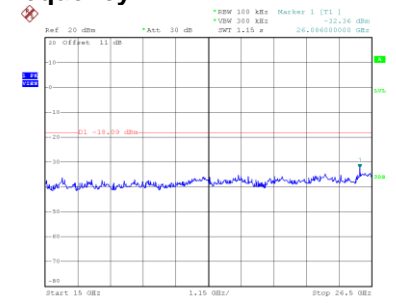

Date: 10.DEC.2023 13:24:12

CH11 – 10th Harmonic of the fundamental frequency

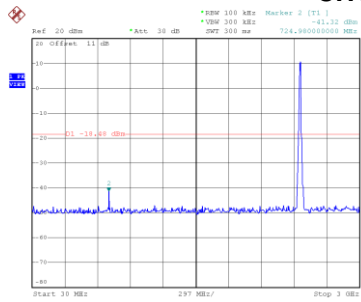

Date: 10.DEC.2023 13:24:31

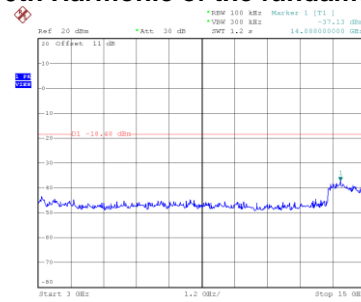

Date: 10.DEC.2023 13:24:40

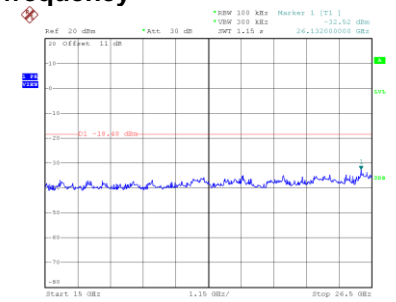

Date: 10.DEC.2023 13:24:48

Test Mode TX G Mode_Ant. 1

Reference Level-CH01

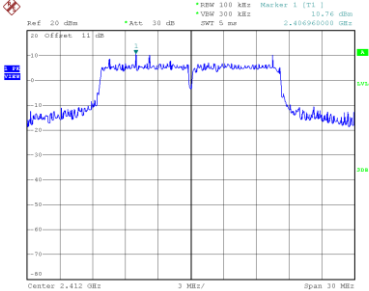

Date: 10.DEC.2023 11:47:59

Reference Level-CH06

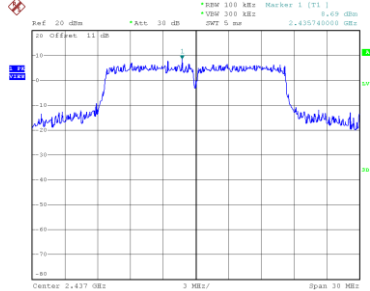

Date: 10.DEC.2023 11:48:19

Reference Level-CH11

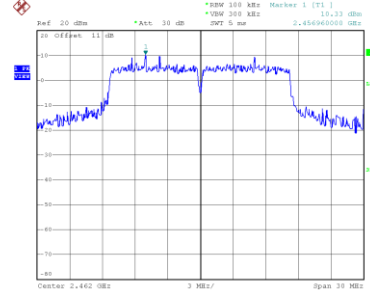

Date: 10.DEC.2023 11:48:36

Bandedge-CH01

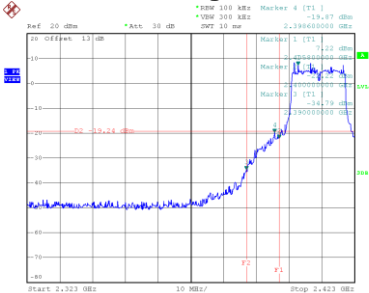

Date: 10.DEC.2023 12:38:56

Bandedge-CH11

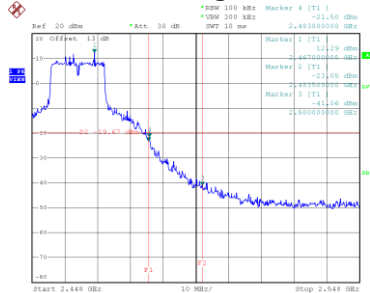

Date: 10.DEC.2023 12:40:59