



Test Report No:  
24C0828R-RFUSV15S-C

## TEST REPORT

### FCC Rules&Regulations

Product Name	Flipper Module
Brand Name	Commcrete
Model No.	VTS-300
FCC ID	2BBUK-FLIPPERVTS300
Applicant's Name / Address	Commcrete ltd Shaked 11, Shoham7319900, Israel
Manufacturer's Name	Commcrete ltd
Test Standard	FCC CFR Title 47 Part 25
Verdict Summary	IN COMPLIANCE
Documented By April Chen	<i>April Chen</i>
Tested by Ivan Chuang	<i>Ivan Chuang</i>
Approved By Alan Chen	<i>Alan Chen</i>
Date of Receipt	2024/12/24
Date of Issue	2025/07/04
Report Version	V1.0

## INDEX

	<b>page</b>
Competences and Guarantees.....	4
General Conditions.....	4
Revision History.....	5
Summary of Test Result.....	6
Comments and Remarks.....	7
1. General Information.....	8
1.1. EUT Description.....	8
1.2. EUT Information.....	9
1.3. Testing Location Information.....	9
1.4. Measurement Uncertainty.....	10
1.5. List of Test Equipment.....	11
2. Test Configuration of EUT.....	12
2.1. Test Condition.....	12
2.2. Test Frequency Mode.....	12
2.3. The Worst Case Measurement Configuration.....	12
2.4. Tested System Details.....	13
2.5. Configuration of Tested System.....	13
2.6. EUT Operating Procedures.....	13
3. RF Output Power.....	14
3.1. Test Setup.....	14
3.2. Limit.....	14
3.3. Test Procedure.....	14
3.4. Test Result of RF Output Power.....	14
4. Occupied Bandwidth.....	15
4.1. Test Setup.....	15
4.2. Limit.....	15
4.3. Test Procedures.....	15
4.4. Test Result of Occupied Bandwidth.....	15
5. Spurious Emissions at Antenna Terminals (conducted emissions).....	16
5.1. Test Setup.....	16
5.2. Limit.....	16
5.3. Test Procedure.....	16
5.4. Test Result of Spurious Emissions at Antenna Terminals (conducted emissions).....	16
6. Spurious Emission (radiated emission).....	17
6.1. Test Setup.....	17
6.2. Limit.....	18

---

6.3.	Test Procedure .....	18
6.4.	Test Result of Spurious Emission .....	18
7.	Limits on emissions from mobile earth stations for protection of aeronautical radio navigation satellite service / Carrier-off state emissions (conducted emissions) .....	19
7.1.	Test Setup .....	19
7.2.	Limit.....	19
7.3.	Test Procedure .....	19
7.4.	Test Result of Limits on emissions from mobile earth stations for protection of aeronautical radio navigation satellite service / Carrier-off state emissions (conducted emissions) .....	19
8.	Frequency Stability.....	20
8.1.	Test Setup .....	20
8.2.	Limit.....	20
8.3.	Test Procedures .....	20
8.4.	Test Result of Frequency Stability .....	20
Appendix A. Test Result of RF Output Power		
Appendix B. Test Result of Occupied Bandwidth		
Appendix C. Test Result of Peak to Average Power Ratio		
Appendix D. Test Result of Spurious Emission		
Appendix E. Test Result of Conducted Band Edge		
Appendix F. Test Result of Frequency Stability		
Appendix G. Test Setup Photograph		

---

## Competences and Guarantees

---

DEKRA is a testing laboratory competent to carry out the tests described in this report.

In order to assure the traceability to other national and international laboratories, DEKRA has a calibration and maintenance program for its measurement equipment.

DEKRA guarantees the reliability of the data presented in this report, which is the result of the measurements and the tests performed to the item under test on the date and under the conditions stated in the report and it is based on the knowledge and technical facilities available at DEKRA at the time of performance of the test.

DEKRA is liable to the client for the maintenance of the confidentiality of all information related to the item under test and the results of the test.

The results presented in this Test Report apply only to the particular item under test established in this document.

**IMPORTANT:** No parts of this report may be reproduced or quoted out of context, in any form or by any means, except in full, without the previous written permission of DEKRA.

---

## General Conditions

---

1. The test results relate only to the samples tested.
2. The test results shown in the test report are traceable to the national/international standard through the calibration report of the equipment and evaluated measurement uncertainty herein.
3. This report must not be used to claim product endorsement by TAF or any agency of the government.
4. The test report shall not be reproduced without the written approval of DEKRA Testing and Certification Co., Ltd.
5. Measurement uncertainties evaluated for each testing system and associated connections are given here to provide the system information for reference. Compliance determinations do not take into account measurement uncertainties for each testing system, but are based on the results of the compliance measurement.

---

## Revision History

---

Version	Description	Issued Date
V1.0	Initial issue of report	2025/07/04

## Summary of Test Result

---

Report Clause	Test Items	Ref Std. Clause	Result (PASS/FAIL)	Remark
3	RF Output Power	25.204 (a)	PASS	-
4	Occupied Bandwidth	2.1049	PASS	-
5	Spurious Emissions at Antenna Terminals (conducted emissions)	25.202 (f)(1)&(2)&(3)	PASS	-
6	Spurious Emissions (radiated emission)	25.202 (f)(3)	PASS	-
7	Limits on emissions from mobile earth stations for protection of aeronautical radio navigation satellite service / Carrier-off state emissions (conducted emissions)	25.216 (c)&(h)&(i)	PASS	-
8	Frequency Stability	25.202 (d)	PASS	-

Comments and Explanations
The declared of product specification for EUT presented in the report are provided by the manufacturer, and the manufacturer takes all the responsibilities for the accuracy of product specification.

### Comments and Remarks

---

The product specification and testing instructions for the EUT declared in the report are provided by the manufacturer who will take all responsibilities for the accuracy.

## 1. General Information

### 1.1. EUT Description

Uplink Frequency Range (MHz)	1637.83-1649.16MHz
Downlink Frequency Range (MHz)	1536.33-1547.66 MHz
Type of Modulation	GMSK

#### Channel List

Flipper Parameters	F2	F3
Uplink - Tx [MHz]	1637.83	1649.16
Downlink - Rx [MHz]	1536.33	1547.66

Note: F2 and F3 are EUT working bands – Satellite F2 Rx 1536.33 MHz/ Tx 1637.83 MHz; Satellite F3 Rx 1547.66 MHz/ Tx 1649.16 MHz.”

Accessories Information				
No.	Equipment Name	Brand Name	Model No.	Remark
1	RF cable 5m (TNC to N-Type)	Commcrete	VRF-NT050	Shielded, 5m
2	RF cable 1m (TNC to TNC)	Commcrete	VRF-TT010	Shielded, 1m

Antenna Information				
Item.	Brand Name	Model No.	Type	Gain (dBi)
1	Commcrete Ltd.	PA45-1592-175SA	Omni Directional Single Patch	2



## 1.2. EUT Information

EUT Power Type	From DC 12V by DC Power Supply
----------------	--------------------------------

## 1.3. Testing Location Information

USA	FCC Designation Number: TW0033
Canada	CAB Identifier Number: TW3023 / Company Number: 26930

Site Description	Accredited by TAF
	Accredited Number: 3023

Test Laboratory	DEKRA Testing and Certification Co., Ltd.
	Linkou Laboratory
Address	No. 85, Wenlin St., Linkou Dist., New Taipei City 244017, Taiwan, R.O.C.
Performed Location	No. 26, Huaya 1st Rd., Guishan Dist., Taoyuan City 333411, Taiwan, R.O.C.
Phone Number	+886-3-275-7255
Fax Number	+886-3-327-8031

Ambient conditions in the laboratory:

Performed Item	Items	Required	Actual	Test Date
RF Conducted Emission	Temperature (°C)	10~40 °C	25.4 °C	2025/06/05 ~ 2025/06/16
	Humidity (%RH)	10~90 %	53.3 %	
Radiated Emission	Temperature (°C)	10~40 °C	23.8 °C	2025/06/05 ~ 2025/06/16
	Humidity (%RH)	10~90 %	52.5 %	

#### 1.4. Measurement Uncertainty

Uncertainties have been calculated according to the DEKRA internal document.

The reported expanded uncertainties are based on a standard uncertainty multiplied by a coverage factor of  $k=2$ , providing a level of confidence of approximately 95%.

Measurement uncertainties evaluated for each testing system and associated connections are given here to provide the system information for reference. Compliance determinations do not take into account measurement uncertainties for each testing system, but are based on the results of the compliance measurement.

Test Item	Uncertainty
RF Output Power	$\pm 2.13$ dB
Occupied Bandwidth	$\pm 1580.61$ Hz
Spurious Emissions at Antenna Terminals (conducted emissions)	$\pm 2.13$ dB
Spurious Emissions (radiated emission)	9 kHz~30 MHz: $\pm 3.30$ dB 30 MHz~1 GHz: $\pm 5.19$ dB
Limits on emissions from mobile earth stations for protection of aeronautical radio navigation satellite service / Carrier-off state emissions (conducted emissions)	$\pm 2.13$ dB
Frequency Stability	$\pm 0.51$ ppm

## 1.5. List of Test Equipment

For Conducted Measurements / HY-SR02

	Equipment	Manufacturer	Model No.	Serial No.	Cal. Date	Due Date
V	Spectrum Analyzer	R&S	FSV30	103466	2024/12/18	2025/12/17

Note:

1. All equipment is calibrated every year.
2. The test instruments marked with "V" are used to measure the final test results.

For Radiated Measurements / HY-CB02

	Equipment	Manufacturer	Model No.	Serial No.	Cal. Date	Due Date
V	Loop Antenna	TESEQ	HLA6121	49611	2025/02/18	2026/02/17
V	Bi-Log Antenna	SCHWARZBECK	VULB9168	9168-0675	2023/08/09	2025/08/08
V	Horn Antenna	RF SPIN	DRH18-E	210503A18ES	2024/02/29	2026/02/28
V	Pre-Amplifier	SGH	SGH0301	20230308-1	2025/02/06	2026/02/05
V	Pre-Amplifier	SGH	PRAMP118	20200702	2025/01/10	2026/01/09
V	Filter	MICRO TRONICS	HPM50115	G069	2025/01/05	2026/01/04
V	EMI Test Receiver	R&S	ESR3	102793	2024/12/06	2025/12/05
V	Spectrum Analyzer	R&S	FSV3044	101113	2025/01/22	2026/01/21
V	Coaxial Cable	SGH	HA800	GD20110223-2	2025/01/10	2026/01/09
V	Coaxial Cable	SGH	HA800	GD20110222-4	2025/01/10	2026/01/09
V	Coaxial Cable	SGH	SGH18	2021005-2	2025/01/10	2026/01/09
V	Coaxial Cable	SGH	SGH18	202108-5	2025/01/10	2026/01/09

Note:

1. Bi-Log Antenna is calibrated every two years, the other equipment is calibrated every year.
2. The test instruments marked with "V" are used to measure the final test results.
3. Test Software Version: e3 230303 dekra V9.

## 2. Test Configuration of EUT

### 2.1. Test Condition

EUT Operational Condition	
Testing Voltage	DC 12V by DC Power Supply

### 2.2. Test Frequency Mode

Test Software Version	N/A
-----------------------	-----

Modulation	Frequency (MHz)	Power Setting
GMSK	1637.83	N/A
	1649.16	N/A

### 2.3. The Worst Case Measurement Configuration

Test Mode	Mode 1: Transmit mode
-----------	-----------------------

Note:

1. Determining compliance shall be based on the results of the compliance measurement, not taking into account measurement instrumentation uncertainty.
2. The EUT was performed at X axis, Y axis and Z axis position for radiated spurious emission test. The worst case was found at Z axis, so the measurement will follow this same test configuration.

## 2.4. Tested System Details

No.	Equipment	Brand Name	Model No.	Serial No.
1	DC Power Supply	N/A	N/A	N/A
2	TYT Radio+Battery	ICOM	ID-50	N/A

## 2.5. Configuration of Tested System

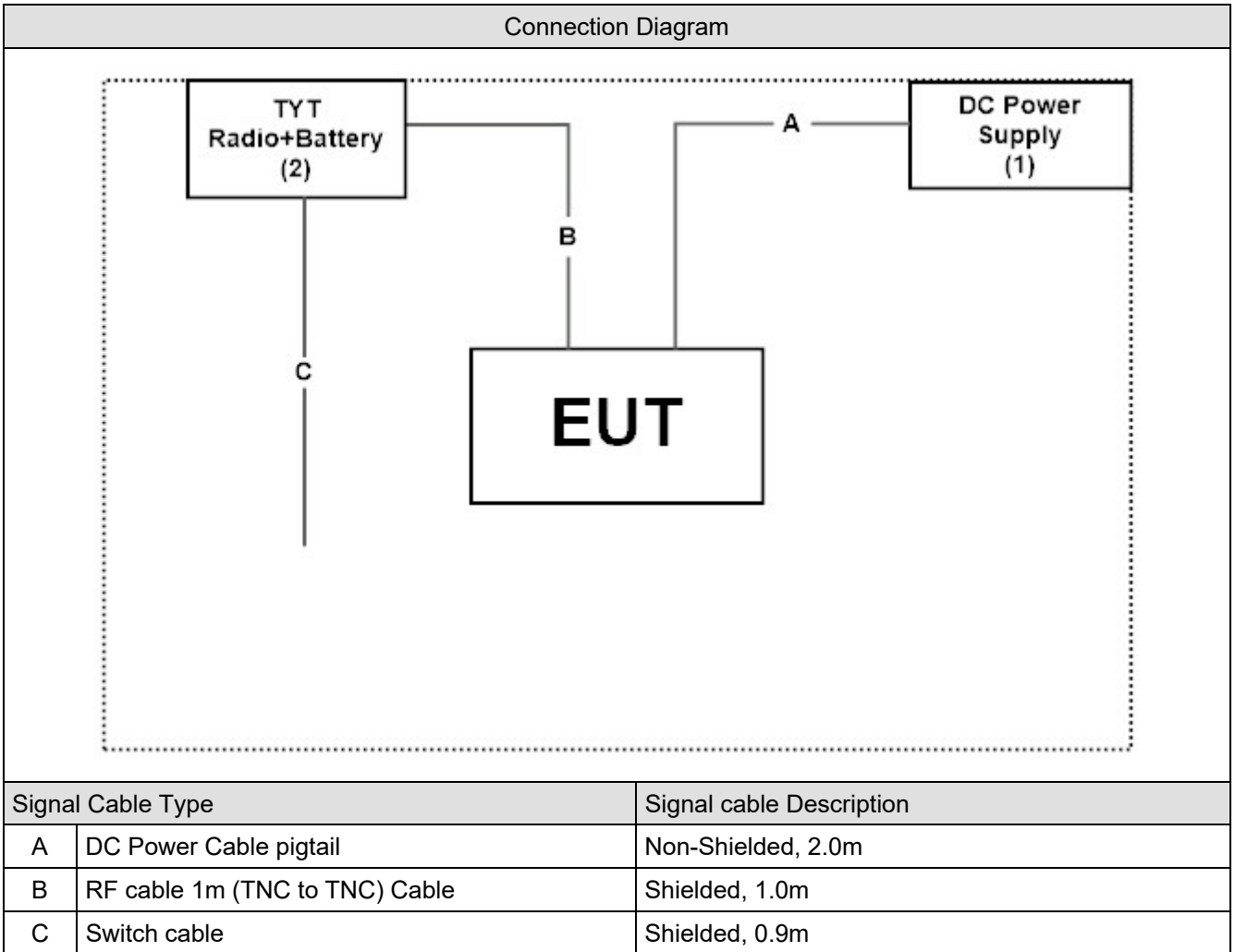

## 2.6. EUT Operating Procedures

1	Setup the EUT as shown in Section 2.5.
2	Use the buttons to adjust the channel on the EUT.
3	Configure the test mode.
4	Verify that the EUT works properly.

### 3. RF Output Power

#### 3.1. Test Setup

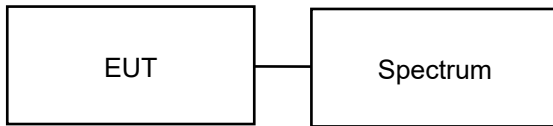

#### 3.2. Limit

FCC: §25.204

(a) In bands shared coequally with terrestrial radio communication services, the equivalent isotropically radiated power transmitted in any direction towards the horizon by an earth station, other than an ESV, operating in frequency bands between 1 and 15 GHz, shall not exceed the following limits except as provided for in paragraph (c) of this section:

+ 40 dBW in any 4 kHz band for  $\theta \leq 0^\circ$

+ 40 + 3 $\theta$  dBW in any 4 kHz band for  $0^\circ < \theta \leq 5^\circ$

Where  $\theta$  is the angle of elevation of the horizon viewed from the center of radiation of the antenna of the earth station and measured in degrees as positive above the horizontal plane and negative below it.

#### 3.3. Test Procedure

The RF output power were measured with the following setting according to Subclause 5.2.4.2, 5.2.4.3 and/or 5.2.4.4 of ANSI C63.26-2015.

#### 3.4. Test Result of RF Output Power

Refer as Appendix A

## 4. Occupied Bandwidth

### 4.1. Test Setup

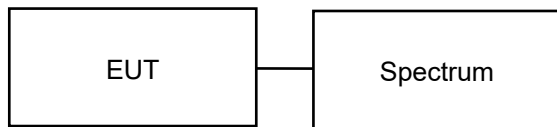

### 4.2. Limit

According to 2.1049, Measurements required: Occupied bandwidth: The occupied bandwidth, that is the frequency bandwidth such that, below its lower and above its upper frequency limits, the mean powers radiated are each equal to 0.5 percent of the total mean power radiated by a given emission shall be measured under the specified conditions of 2.1049 (a) through (i) as applicable.

### 4.3. Test Procedures

The Occupied bandwidth (99 %) were measured with the following setting according to subclause 5.4.4 of ANSI C63.26.

### 4.4. Test Result of Occupied Bandwidth

Refer as Appendix B

## 5. Spurious Emissions at Antenna Terminals (conducted emissions)

### 5.1. Test Setup

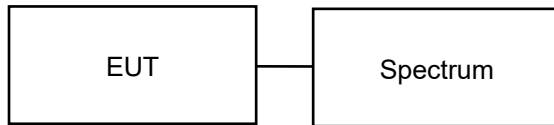

### 5.2. Limit

According to 25.202(f), Emission limitations. Except for SDARS terrestrial repeaters and as provided for in paragraph (i), the mean power of emissions shall be attenuated below the mean output power of the transmitter in accordance with the schedule set forth in paragraphs (f)(1) through (f)(4) of this section. The out-of-band emissions of SDARS terrestrial repeaters shall be attenuated in accordance with the schedule set forth in paragraph (h) of this section.

- (1) In any 4 kHz band, the center frequency of which is removed from the assigned frequency by more than 50 percent up to and including 100 percent of the authorized bandwidth: 25 dB;
- (2) In any 4 kHz band, the center frequency of which is removed from the assigned frequency by more than 100 percent up to and including 250 percent of the authorized bandwidth: 35 dB;
- (3) In any 4 kHz band, the center frequency of which is removed from the assigned frequency by more than 250 percent of the authorized bandwidth: An amount equal to 43 dB plus 10 times the logarithm (to the base 10) of the transmitter power in watts;
- (4) In any event, when an emission outside of the authorized bandwidth causes harmful interference, the Commission may, at its discretion, require greater attenuation than specified in paragraphs (f) (1), (2) and (3) of this section.

### 5.3. Test Procedure

The Spurious Emissions at Antenna Terminals were measured with the following setting according to subclause 5.7.3 and 5.7.4 of ANSI C63.26.

### 5.4. Test Result of Spurious Emissions at Antenna Terminals (conducted emissions)

Refer as Appendix C



## 6. Spurious Emission (radiated emission)

### 6.1. Test Setup

Radiated Spurious Measurement (below 1 GHz)

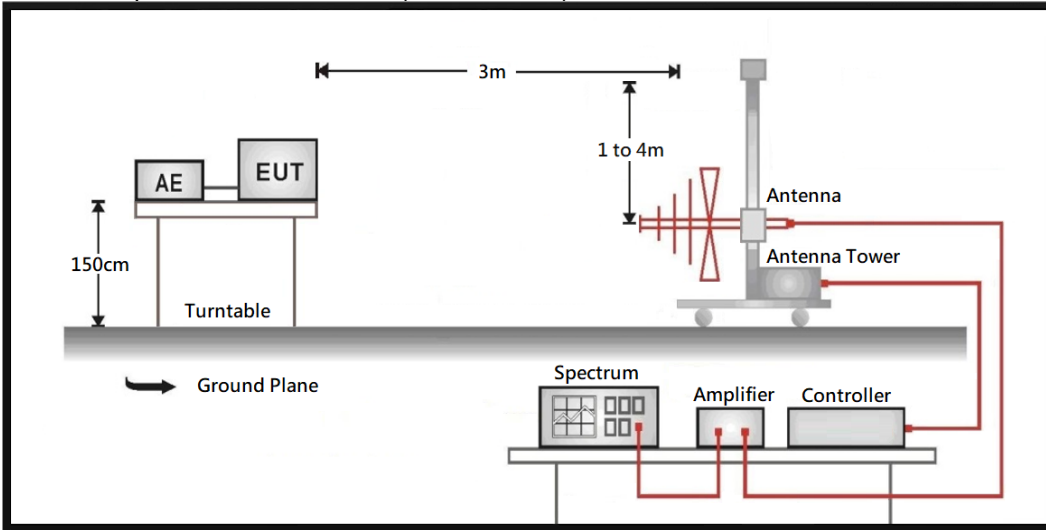

Radiated Spurious Measurement (above 1 GHz)

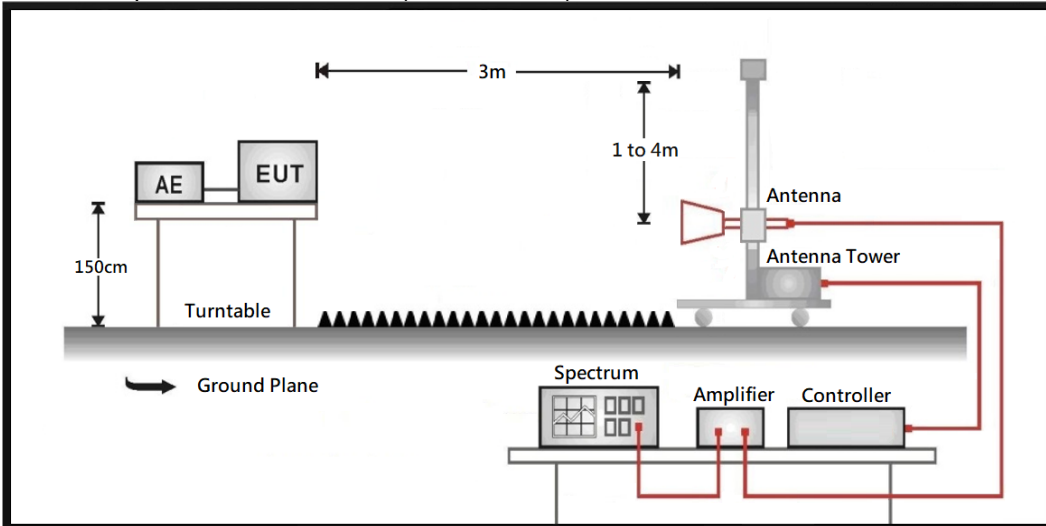

## 6.2. Limit

According to 25.202(f), Emission limitations. Except for SDARS terrestrial repeaters and as provided for in paragraph (i), the mean power of emissions shall be attenuated below the mean output power of the transmitter in accordance with the schedule set forth in paragraphs (f)(1) through (f)(4) of this section. The out-of-band emissions of SDARS terrestrial repeaters shall be attenuated in accordance with the schedule set forth in paragraph (h) of this section.

- (1) In any 4 kHz band, the center frequency of which is removed from the assigned frequency by more than 50 percent up to and including 100 percent of the authorized bandwidth: 25 dB;
- (2) In any 4 kHz band, the center frequency of which is removed from the assigned frequency by more than 100 percent up to and including 250 percent of the authorized bandwidth: 35 dB;
- (3) In any 4 kHz band, the center frequency of which is removed from the assigned frequency by more than 250 percent of the authorized bandwidth: An amount equal to 43 dB plus 10 times the logarithm (to the base 10) of the transmitter power in watts;
- (4) In any event, when an emission outside of the authorized bandwidth causes harmful interference, the Commission may, at its discretion, require greater attenuation than specified in paragraphs (f) (1), (2) and (3) of this section.

## 6.3. Test Procedure

### **Radiated Spurious Measurement:**

The field strength of radiated spurious measurements was made in accordance with the procedures of subclause 5.5 of ANSI C63.26

The EUT and its simulators are placed on a turn table which is 1.5 meter above ground. The turn table can rotate 360 degrees to determine the position of the maximum emission level. The height of the receiving antenna is varied between one meter and four meters to search the maximum spurious emission for both horizontal and vertical polarizations. The resolution bandwidth of the spectrum analyzer was set at 1 MHz, sufficient scans were taken to show the out of band Emission if any up to 10th harmonic. Taking the record of maximum spurious emission.

## 6.4. Test Result of Spurious Emission

Refer as Appendix D

## 7. Limits on emissions from mobile earth stations for protection of aeronautical radio navigation satellite service / Carrier-off state emissions (conducted emissions)

### 7.1. Test Setup

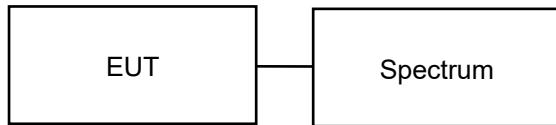

### 7.2. Limit

According to 25.216, Limits on emissions from mobile earth stations for protection of aeronautical radionavigation-satellite service.

(c) The e.i.r.p. density of emissions from mobile earth stations placed in service after July 21, 2002 with assigned uplink frequencies between 1610 MHz and 1660.5 MHz shall not exceed  $-70$  dBW/MHz, averaged over any 2 millisecond active transmission interval, in the band 1559-1605 MHz. The e.i.r.p. of discrete emissions of less than 700 Hz bandwidth from such stations shall not exceed  $-80$  dBW, averaged over any 2 millisecond active transmission interval, in the 1559-1605 MHz band.

(h) Mobile earth stations manufactured more than six months after Federal Register publication of the rule changes adopted in FCC 03-283 with assigned uplink frequencies in the 1626.5-1660.5 MHz band shall suppress the power density of emissions in the 1605-1610 MHz band-segment to an extent determined by linear interpolation from  $-70$  dBW/MHz at 1605 MHz to  $-46$  dBW/MHz at 1610 MHz, averaged over any 2 millisecond active transmission interval. The e.i.r.p of discrete emissions of less than 700 Hz bandwidth from such stations shall not exceed a level determined by linear interpolation from  $-80$  dBW at 1605 MHz to  $-56$  dBW at 1610 MHz, averaged over any 2 millisecond active transmission interval.

(i) The e.i.r.p density of carrier-off state emissions from mobile earth stations manufactured more than six months after Federal Register publication of the rule changes adopted in FCC 03-283 with assigned uplink frequencies between 1 and 3 GHz shall not exceed  $-80$  dBW/MHz in the 1559-1610 MHz band averaged over any two millisecond interval.

### 7.3. Test Procedure

The procedure for the measurements of Spurious Emissions at Antenna Terminals (conducted emissions) was used, except for the measurement frequency range and the reference measurement bandwidth.

### 7.4. Test Result of Limits on emissions from mobile earth stations for protection of aeronautical radio navigation satellite service / Carrier-off state emissions (conducted emissions)

Refer as Appendix E

## 8. Frequency Stability

### 8.1. Test Setup

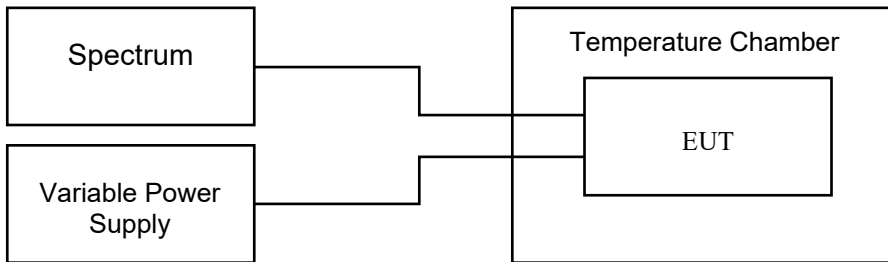

### 8.2. Limit

According to 25.202(d), Frequency tolerance, Earth stations. The carrier frequency of each earth station transmitter authorized in these services shall be maintained within 0.001 percent of the reference frequency.

### 8.3. Test Procedures

#### Frequency Stability under Temperature Variations:

The EUT under test was connected to an external AC or DC power supply and input rated voltage. RF output was connected to a communication simulator. The EUT was placed inside the temperature chamber. Set the EUT 20°C operating frequency as reference frequency. Turn EUT off and set the chamber temperature to -30°C. After the temperature stabilized for approximately 30 minutes recorded the frequency. Repeat step measure with 10°C increased per stage until the highest temperature of +50°C reached.

#### Frequency Stability under Voltage Variations:

Set chamber temperature to 20°C. Use a variable AC or DC power supply to power the EUT and set the voltage to rated voltage. Reduce the input voltage to specify extreme voltage variation ( $\pm 15\%$ ) and endpoint, record the maximum frequency change.

### 8.4. Test Result of Frequency Stability

Refer as Appendix F