



FCC TEST REPORT

FCC ID:2BBR6-T6

Report Number..... : ZKT-2406277391E-2

Date of Test..... Jun. 20, 2024 to Aug. 12, 2024

Date of issue..... : Aug. 12, 2024

Total number of pages..... 52

Test Result..... : PASS

Testing Laboratory..... : Shenzhen ZKT Technology Co., Ltd.

Address : 1/F, No. 101, Building B, No. 6, Tangwei Community Industrial Avenue, Fuhai Street, Bao'an District, Shenzhen, China

Applicant's name : Shenzhen Leader Eletronics Technology Co.,Ltd.

Address : Room1528, Dongming Mansion, Minkang Rd,Minzhi street,Shenzhen,China

Manufacturer's name : Shenzhen Leader Eletronics Technology Co.,Ltd.

Address : Room1528, Dongming Mansion, Minkang Rd,Minzhi street,Shenzhen,China

Test specification:

Standard..... : FCC CFR Title 47 Part 15 Subpart C Section 15.247
ANSI C63.10:2013

Test procedure..... : /

Non-standard test method : N/A

Test Report Form No..... : TRF-EL-110_V0

Test Report Form(s) Originator..... : ZKT Testing

Master TRF : Dated: 2020-01-06

This device described above has been tested by ZKT, and the test results show that the equipment under test (EUT) is in compliance with the FCC requirements. And it is applicable only to the tested sample identified in the report.

This report shall not be reproduced except in full, without the written approval of ZKT, this document may be altered or revised by ZKT, personal only, and shall be noted in the revision of the document.

Product name..... : trail camera Hunter camera

Trademark : N/A

Model/Type reference..... : T6
T6W, T6S, T6G, T6F, T6P

Ratings..... : Battery Input : 1.5V*8 AA Battery



Testing procedure and testing location:

Testing Laboratory.....: **Shenzhen ZKT Technology Co., Ltd.**

Address.....: 1/F, No. 101, Building B, No. 6, Tangwei Community Industrial Avenue, Fuhai Street, Bao'an District, Shenzhen, China

Tested by (name + signature).....: Jim Liu

Reviewer (name + signature).....: Jackson Fang

Approved (name + signature).....: Lake Xie





Table of Contents

	Page
1. VERSION	5
2. SUMMARY OF TEST RESULTS	6
2.1 TEST FACILITY	7
2.2 MEASUREMENT UNCERTAINTY	7
3. GENERAL INFORMATION	8
3.1 GENERAL DESCRIPTION OF EUT	8
3.2 DESCRIPTION OF TEST MODES	9
3.3 BLOCK DIGRAM SHOWING THE CONFIGURATION OF SYSTEM TESTED	10
3.4 DESCRIPTION OF SUPPORT UNITS(CONDUCTED MODE)	10
3.5EQUIPMENTS LIST FOR ALL TEST ITEMS	11
4. EMC EMISSION TEST	13
4.1 CONDUCTED EMISSION MEASUREMENT	13
4.1.1 POWER LINE CONDUCTED EMISSION LIMITS	13
4.1.2 TEST PROCEDURE	13
4.1.3 DEVIATION FROM TEST STANDARD	13
4.1.4 TEST SETUP	14
4.1.5 EUT OPERATING CONDITIONS	14
4.1.6 TEST RESULT	14
4.2.1 RADIATED EMISSION LIMITS	15
4.2.2 TEST PROCEDURE	15
4.2.3 DEVIATION FROM TEST STANDARD	16
4.2.4 TEST SETUP	16
4.2.5 EUT OPERATING CONDITIONS	17
4.2.6 TEST RESULTS	17
5.1 TEST REQUIREMENT:	26
5.2 TEST PROCEDURE	26
5.3 DEVIATION FROM TEST STANDARD	26
5.4 TEST SETUP	27
5.5 EUT OPERATING CONDITIONS	27
5.6 TEST RESULT	28
6.1 APPLIED PROCEDURES / LIMIT	30
6.2 TEST PROCEDURE	30
6.3 DEVIATION FROM STANDARD	30
6.4 TEST SETUP	30
6.5 EUT OPERATION CONDITIONS	30
6.6 TEST RESULT	31
7. 6DB OCCUPIED BANDWIDTH	37
7.1 APPLIED PROCEDURES / LIMIT	37
7.2 TEST PROCEDURE	37
7.3 DEVIATION FROM STANDARD	37
7.4 TEST SETUP	37
7.5 EUT OPERATION CONDITIONS	37
7.6 TEST RESULT	38
8.PEAK OUTPUT POWER TEST	41
8.1 APPLIED PROCEDURES/LIMIT	41
8.2 TEST PROCEDURE	41
8.3 DEVIATION FROM STANDARD	41
8.4 TEST SETUP	41
8.5 EUT OPERATION CONDITIONS	41
8.6 TEST RESULT	42
9. CONDUCTED BAND EDGE AND SPURIOUS EMISSION	43



9.1 APPLICABLE STANDARD43

9.2 TEST PROCEDURE 43

9.3 DEVIATION FROM STANDARD43

9.4 TEST SETUP 43

9.5 EUT OPERATION CONDITIONS 43

9.6 TEST RESULTS43

10. DUTY CYCLE48

10.1 APPLIED PROCEDURES / LIMIT 48

10.2 DEVIATION FROM STANDARD48

10.3 TEST SETUP 48

11. ANTENNA REQUIREMENT 51

12. TEST SETUP PHOTO52

13. EUT CONSTRUCTIONAL DETAILS52



1. VERSION

Report No.	Version	Description	Approved
ZKT-2406277391E-2	Rev.01	Initial issue of report	Aug. 12, 2024



2. SUMMARY OF TEST RESULTS

Test procedures according to the technical standards:

FCC Part15 (15.247) , Subpart C			
Standard Section	Test Item	Result	Remark
FCC part 15.203/15.247 (c)	Antenna requirement	PASS	
FCC part 15.207	AC Power Line Conducted Emission	N/A	
FCC part 15.247 (b)(3)	Conducted Peak Output Power	PASS	
FCC part 15.247 (a)(2)	6dB Occupied Bandwidth	PASS	
FCC part 15.247 (e)	Power Spectral Density	PASS	
FCC part 15.247(d)	Band Edge	PASS	
FCC part 15.205/15.209	Spurious Emission	PASS	
ANSI C63.10:2013	Duty cycle	PASS	

NOTE:

(1) "N/A" denotes test is not applicable in this Test Report



2.1 TEST FACILITY

Shenzhen ZKT Technology Co., Ltd.
Add. : 1/F, No. 101, Building B, No. 6, Tangwei Community Industrial Avenue, Fuhai Street, Bao'an District, Shenzhen, China

FCC Test Firm Registration Number: 692225
Designation Number: CN1299
IC Registered No.: 27033
CAB identifier: CN0110

2.2 MEASUREMENT UNCERTAINTY

The reported uncertainty of measurement $y \pm U$ where expanded uncertainty U is based on a standard uncertainty multiplied by a coverage factor of $k=2$ providing a level of confidence of approximately 95 %.

No.	Item	Uncertainty
1	3m chamber Radiated spurious emission(9KHz-30MHz)	U=4.5dB
2	3m chamber Radiated spurious emission(30MHz-1GHz)	U=4.8dB
3	3m chamber Radiated spurious emission(1GHz-6GHz)	U=4.9dB
4	3m chamber Radiated spurious emission(6GHz-40GHz)	U=5.0dB
5	Conducted disturbance	U=3.2dB
6	RF Band Edge	U=1.68dB
7	RF power conducted	U=1.86dB
8	RF conducted Spurious Emission	U=2.2dB
9	RF Occupied Bandwidth	U=1.8MHz
10	RF Power Spectral Density	U=1.75dB
11	humidity uncertainty	U=5.3%
12	Temperature uncertainty	U=0.59°C



3. GENERAL INFORMATION

3.1 GENERAL DESCRIPTION OF EUT

Product Name:	trail camera Hunter camera
Model No.:	T6
Model Different.:	All the model are the same circuit and RF module, only the model name is different.
Serial No.:	T6W, T6S, T6G, T6F, T6P
Hardware Version:	N/A
Software Version:	N/A
Sample(s) Status:	Engineer sample
Channel numbers:	802.11b/802.11g /802.11n(HT20):11
Channel separation:	5MHz
Modulation technology:	802.11b: Direct Sequence Spread Spectrum(DSSS) 802.11g/802.11n(HT20): Orthogonal Frequency Division Multiplexing(OFDM)
Antenna Type:	Inside Antenna
Antenna gain:	3.82 dBi
Power supply:	Battery Input : 1.5V*8 AA Battery
AC/DC Adapter:	N/A
AC/DC Adapter Mode:	N/A



Operation Frequency each of channel							
Channel	Frequency	Channel	Frequency	Channel	Frequency	Channel	Frequency
1	2412MHz	4	2427MHz	7	2442MHz	10	2457MHz
2	2417MHz	5	2432MHz	8	2447MHz	11	2462MHz
3	2422MHz	6	2437MHz	9	2452MHz	X	

Note:

In section 15.31(m), regards to the operating frequency range over 10 MHz, the Lowest frequency, the middle frequency, and the highest frequency of channel were selected to perform the test, and the selected channel see below:

Test channel	Frequency (MHz)
	802.11b/802.11g/802.11n(HT20)
Lowest channel	2412MHz
Middle channel	2437MHz
Highest channel	2462MHz

3.2 DESCRIPTION OF TEST MODES

Transmitting mode	Keep the EUT in continuously transmitting mode
Remark: The test voltage was tuned from 85% to 115% of the nominal rated supply voltage, and found that the worst case was under the nominal rated supply condition. So the report just shows that condition's data.	

We have verified the construction and function in typical operation. All the test modes were carried out with the EUT in transmitting operation, which was shown in this test report and defined as follows:			
Pre-scan all kind of data rate in lowest channel, and found the follow list which it was worst case.			
Mode	802.11b	802.11g	802.11n(HT20)
Data rate	1Mbps	6Mbps	6.5Mbps

Test Software	CMD
Power level setup	Default



3.3 BLOCK DIGRAM SHOWING THE CONFIGURATION OF SYSTEM TESTED

Radiated Emission

EUT

Conducted Spurious

EUT

3.4 DESCRIPTION OF SUPPORT UNITS(CONDUCTED MODE)

The EUT has been tested as an independent unit together with other necessary accessories or support units. The following support units or accessories were used to form a representative test configuration during the tests.

Item	Equipment	Mfr/Brand	Model/Type No.	Series No.	Note
E-1	trail camera Hunter camera	N/A	T6	See page 8	EUT

Item	Shielded Type	Ferrite Core	Length	Note

Note:

- (1) The support equipment was authorized by Declaration of Confirmation.
- (2) For detachable type I/O cable should be specified the length in cm in 『Length』 column.



3.5EQUIPMENTS LIST FOR ALL TEST ITEMS

Conduction Test equipment

Item	Kind of Equipment	Manufacturer	Type No.	Serial No.	Firmware Version	Last calibration	Calibrated until
1	LISN	R&S	ENV216	101471	N/A	Nov. 14, 2023	Nov. 13, 2024
2	LISN	CYBERTEK	EM5040A	E1850400149	N/A	Nov. 02, 2023	Nov. 01, 2024
3	Test Cable	N/A	C-01	N/A	N/A	Nov. 02, 2023	Nov. 01, 2024
4	Test Cable	N/A	C-02	N/A	N/A	Nov. 02, 2023	Nov. 01, 2024
5	Test Cable	N/A	C-03	N/A	N/A	Nov. 02, 2023	Nov. 01, 2024
6	EMI Test Receiver	R&S	ESCI3	101393	4.42 SP3	Nov. 02, 2023	Nov. 01, 2024
7	Triple-Loop Antenna	N/A	RF300	N/A	N/A	Nov. 02, 2023	Nov. 01, 2024
8	Absorbing Clamp	DZ	ZN23201	15034	N/A	Nov. 07, 2023	Nov. 06, 2024
9	EMC Software	Frad	EZ-EMC	Ver.EMC-CON 3A1.1	N/A	\	\

Radiation Test equipment

Item	Equipment	Manufacturer	Type No.	Serial No.	Firmware Version	Last calibration	Calibrated until
1	Spectrum Analyzer (9kHz-26.5GHz)	KEYSIGHT	9020A	MY55370835	A.17.05	Nov. 02, 2023	Nov. 01, 2024
2	Spectrum Analyzer (10kHz-39.9GHz)	R&S	FSV40-N	100363	1.71 SP2	Nov. 02, 2023	Nov. 01, 2024
3	EMI Test Receiver (9kHz-7GHz)	R&S	ESCI7	101169	4.32	Nov. 02, 2023	Nov. 01, 2024
4	Bilog Antenna (30MHz-1500MHz)	Schwarzbeck	VULB9168	N/A	N/A	Nov. 13, 2023	Nov. 12, 2024
5	Horn Antenna (1GHz-18GHz)	Agilent	AH-118	071145	N/A	Nov. 13, 2023	Nov. 12, 2024
6	Horn Antenna (15GHz-40GHz)	A.H.System	SAS-574	588	N/A	Nov. 13, 2023	Nov. 12, 2024
7	Loop Antenna	TESEQ	HLA6121	58357	N/A	Nov. 16, 2023	Nov. 15, 2024
8	Amplifier (30-1000MHz)	EM Electronics	EM330 Amplifier	060747	N/A	Nov. 02, 2023	Nov. 01, 2024
9	Amplifier (1GHz-26.5GHz)	Agilent	8449B	3008A00315	N/A	Nov. 02, 2023	Nov. 01, 2024
10	Amplifier (500MHz-40GHz)	QuanJuDa	DLE-161	097	N/A	Nov. 02, 2023	Nov. 01, 2024
11	Test Cable	N/A	R-01	N/A	N/A	Nov. 02, 2023	Nov. 01, 2024
12	Test Cable	N/A	R-02	N/A	N/A	Nov. 02, 2023	Nov. 01, 2024
13	Test Cable	N/A	R-03	N/A	N/A	Nov. 02, 2023	Nov. 01, 2024
14	D.C. Power Supply	LongWei	TPR-6405D	N/A	N/A	\	\
15	EMC Software	Frad	EZ-EMC	Ver.EMC-CO N 3A1.1	N/A	\	\
16	Turntable	MF	MF-7802BS	N/A	N/A	\	\
17	Antenna tower	MF	MF-7802BS	N/A	N/A	\	\



RF Test equipment

Item	Equipment	Manufacturer	Type No.	Serial No.	Firmware Version	Last calibration	Calibrated until
1	Spectrum Analyzer (9kHz-26.5GHz)	KEYSIGHT	9020A	MY55370835	A.17.05	Nov. 02, 2023	Nov. 01, 2024
2	Spectrum Analyzer (10kHz-39.9GHz)	R&S	FSV40-N	100363	1.71 SP2	Nov. 02, 2023	Nov. 01, 2024
3	Test Cable	N/A	RF-01	N/A	N/A	Nov. 02, 2023	Nov. 01, 2024
4	Test Cable	N/A	RF-02	N/A	N/A	Nov. 02, 2023	Nov. 01, 2024
5	Test Cable	N/A	RF-03	N/A	N/A	Nov. 02, 2023	Nov. 01, 2024
6	ESG Signal Generator	Agilent	E4421B	N/A	B.03.84	Nov. 02, 2023	Nov. 01, 2024
7	Signal Generator	Agilent	N5182A	N/A	A.01.87	Nov. 02, 2023	Nov. 01, 2024
8	Magnetic Field Probe Tester	Narda	ELT-400	0-0344	N/A	Nov. 16, 2023	Nov. 15, 2024
9	Wideband Radio Communication Test	R&S	CMW500	106504	V 3.7.22	Nov. 02, 2023	Nov. 01, 2024
10	MWRF Power Meter Test system	MW	MW100-RF CB	N/A	N/A	Nov. 02, 2023	Nov. 01, 2024
11	Power Meter	KEYSIGHT	N1912A P	N/A	A.05.00	Nov. 02, 2023	Nov. 01, 2024
12	D.C. Power Supply	LongWei	TPR-6405D	N/A	N/A	\	\
13	RF Software	MW	MTS8310	V2.0.0.0	N/A	\	\



4. EMC EMISSION TEST

4.1 CONDUCTED EMISSION MEASUREMENT

Test Requirement:	FCC Part15 C Section 15.207
Test Method:	ANSI C63.10:2013
Test Frequency Range:	150KHz to 30MHz
Receiver setup:	RBW=9KHz, VBW=30KHz, Sweep time=auto

4.1.1 POWER LINE CONDUCTED EMISSION Limits

FREQUENCY (MHz)	Limit (dBuV)		Standard
	Quasi-peak	Average	
0.15 -0.5	66 - 56 *	56 - 46 *	FCC
0.50 -5.0	56.00	46.00	FCC
5.0 -30.0	60.00	50.00	FCC

Note:

(1) *Decreases with the logarithm of the frequency.

4.1.2 TEST PROCEDURE

- The EUT was placed 0.8 meters from the horizontal ground plane with EUT being connected to the power mains through a line impedance stabilization network (LISN). All other support equipments powered from additional LISN(s). The LISN provide 50 Ohm/ 50uH of coupling impedance for the measuring instrument.
- Interconnecting cables that hang closer than 40 cm to the ground plane shall be folded back and forth in the center forming a bundle 30 to 40 cm long.
- I/O cables that are not connected to a peripheral shall be bundled in the center. The end of the cable may be terminated, if required, using the correct terminating impedance. The overall length shall not exceed 1 m.
- LISN at least 80 cm from nearest part of EUT chassis.
- For the actual test configuration, please refer to the related Item –EUT Test Photos.

4.1.3 DEVIATION FROM TEST STANDARD

No deviation



4.1.4 TEST SETUP

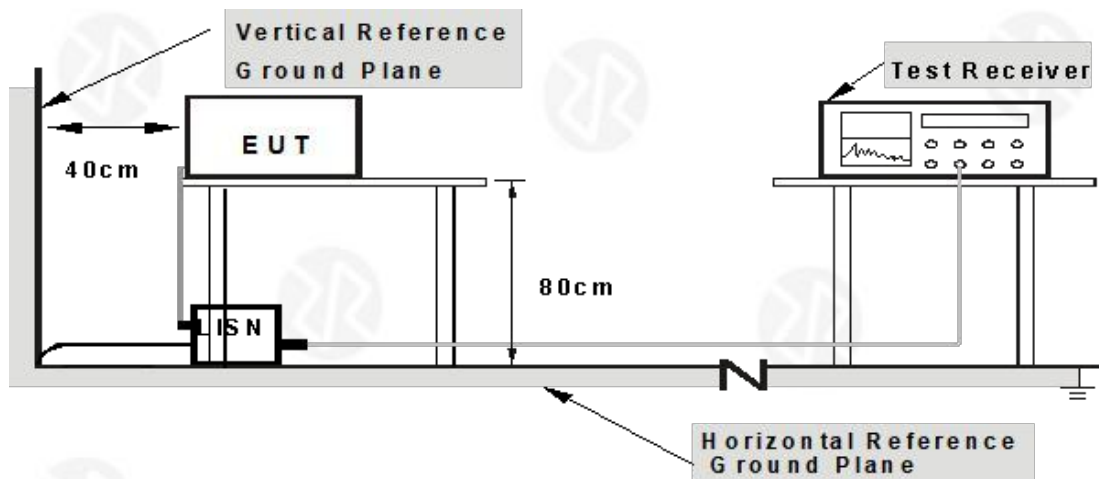

- Note:**
- 1.Support units were connected to second LISN.
 - 2.Both of LISNs (AMN) are 80 cm from EUT and at least 80 from other units and other metal planes

4.1.5 EUT OPERATING CONDITIONS

The EUT was configured for testing in a typical fashion (as a customer would normally use it). The EUT has been programmed to continuously transmit during test. This operating condition was tested and used to collect the included data.

4.1.6 TEST RESULT

The EUT is powered by DC only. The test items is not applicable.



4.2 RADIATED EMISSION MEASUREMENT

Test Requirement:	FCC Part15 C Section 15.209				
Test Method:	ANSI C63.10:2013				
Test Frequency Range:	9kHz to 25GHz				
Test site:	Measurement Distance: 3m				
Receiver setup:	Frequency	Detector	RBW	VBW	Value
	9KHz-150KHz	Quasi-peak	200Hz	600Hz	Quasi-peak
	150KHz-30MHz	Quasi-peak	9KHz	30KHz	Quasi-peak
	30MHz-1GHz	Quasi-peak	100KHz	300KHz	Quasi-peak
	Above 1GHz	Peak	1MHz	3MHz	Peak
Peak		1MHz	10Hz	Average	

4.2.1 RADIATED EMISSION LIMITS

Frequencies (MHz)	Field Strength (micovolts/meter)	Measurement Distance (meters)
0.009~0.490	2400/F(KHz)	300
0.490~1.705	24000/F(KHz)	30
1.705~30.0	30	30
30~88	100	3
88~216	150	3
216~960	200	3
Above 960	500	3

LIMITS OF RADIATED EMISSION MEASUREMENT

FREQUENCY (MHz)	Limit (dBuV/m) (at 3M)	
	PEAK	AVERAGE
Above 1000	74	54

Notes:

- (1) The limit for radiated test was performed according to FCC PART 15C.
- (2) The tighter limit applies at the band edges.
- (3) Emission level (dBuV/m)=20log Emission level (uV/m).

4.2.2 TEST PROCEDURE

Below 1GHz test procedure as below:

- a. The EUT was placed on the top of a rotating table 0.8 meters above the ground at a 3 meter semi-anechoic chamber. The table was rotated 360 degrees to determine the position of the highest radiation.
- b. The EUT was set 3 meters away from the interference-receiving antenna, which was mounted on the top of available-height antenna tower.



- c. The antenna height is varied from one meter to four meters above the ground to determine the maximum value of the field strength. Both horizontal and vertical polarizations of the antenna are set to make the measurement.
- d. For each suspected emission, the EUT was arranged to its worst case and then the antenna was tuned to heights from 1 meter to 4 meters (for the test frequency of below 30MHz, the antenna was tuned to heights 1meter) and the rotatable table was turned from 0 degrees to 360 degrees to find the maximum reading.
- e. The test-receiver system was set to Peak Detect Function and Specified Bandwidth with Maximum Hold Mode.
- f. If the emission level of the EUT in peak mode was 10dB lower than the limit specified, then testing could be stopped and the peak values of the EUT would be reported. Otherwise the emissions that did not have 10dBmargin would be re-tested one by one using peak, quasi-peak or average method as specified and then reported in a data sheet.

Above 1GHz test procedure as below:

- g. Different between above is the test site, change from Semi- Anechoic Chamber to fully Anechoic Chamber and change form table 0.8 meter to 1.5 meter(Above 18GHz the distance is 1 meter and table is 1.5 meter).
- h. Test the EUT in the lowest channel ,the middle channel ,the Highest channel

Note:

Both horizontal and vertical antenna polarities were tested and performed pretest to three orthogonal axis. The worst case emissions were reported

4.2.3 DEVIATION FROM TEST STANDARD

No deviation

4.2.4 TEST SETUP

(A) Radiated Emission Test-Up Frequency Below 30MHz

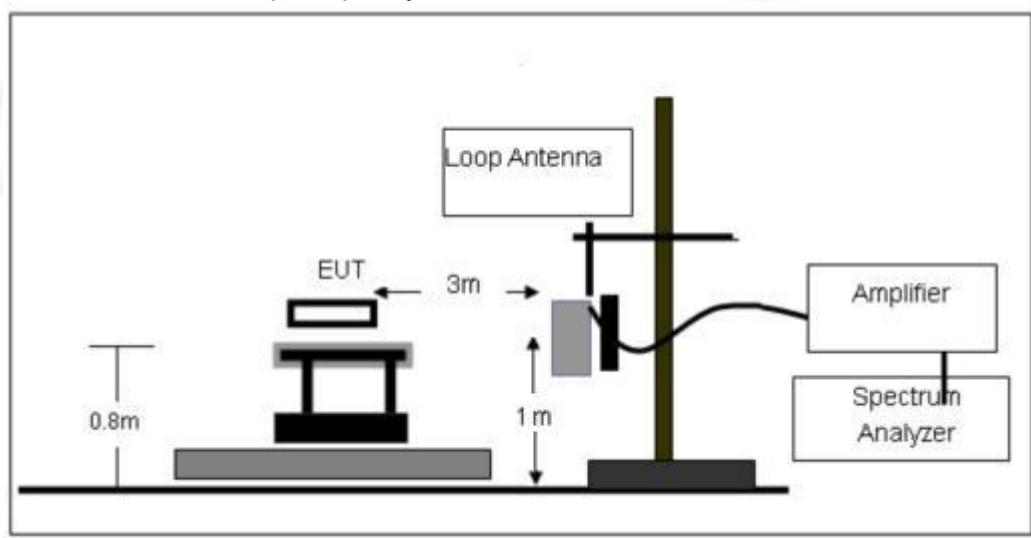



(B) Radiated Emission Test-Up Frequency 30MHz~1GHz

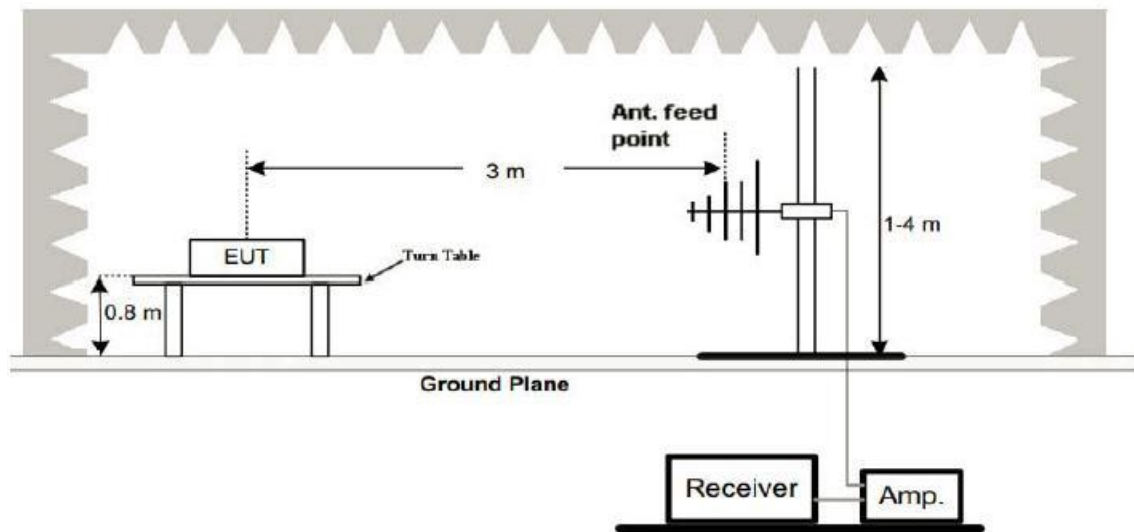

(C) Radiated Emission Test-Up Frequency Above 1GHz

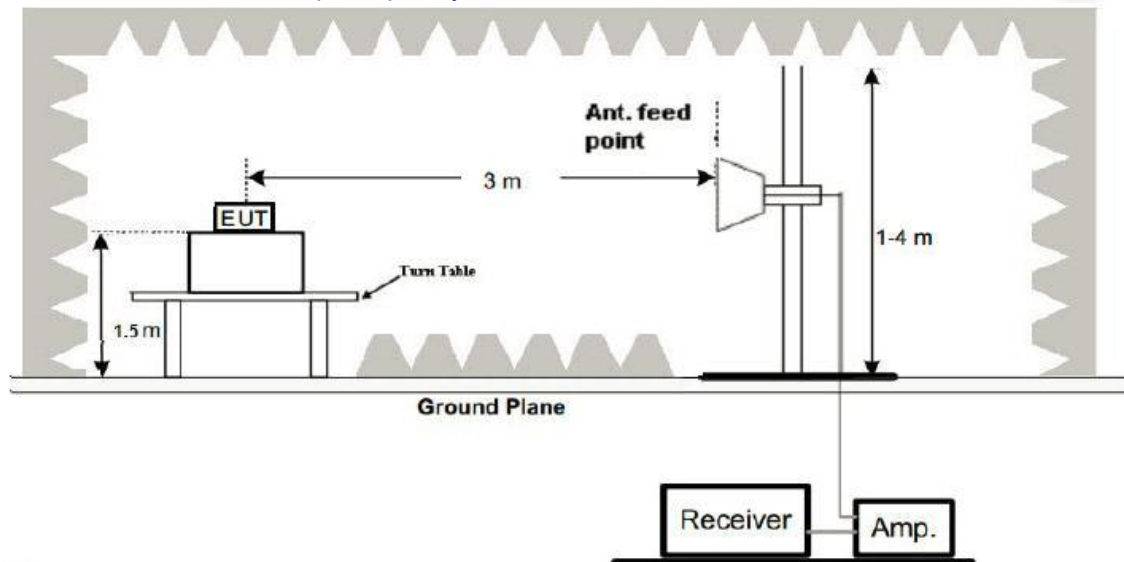

4.2.5 EUT OPERATING CONDITIONS

The EUT tested system was configured as the statements of 2.4 Unless otherwise a special operating condition is specified in the follows during the testing.

4.2.6 TEST RESULTS

Between 9KHz – 30MHz

The emission from 9 kHz to 30MHz was pre-tested and found the result was 20dB lower than the limit, and according to 15.31(o) & RSS-Gen 6.13, the test result no need to reported.



Between 30MHz – 1GHz

Temperature:	26°C	Relative Humidity:	54%
Pressure:	101 kPa	Polarization:	Horizontal
Test Voltage:	DC 12V	Test Mode :	TX 802.11n20 - 2412MHz

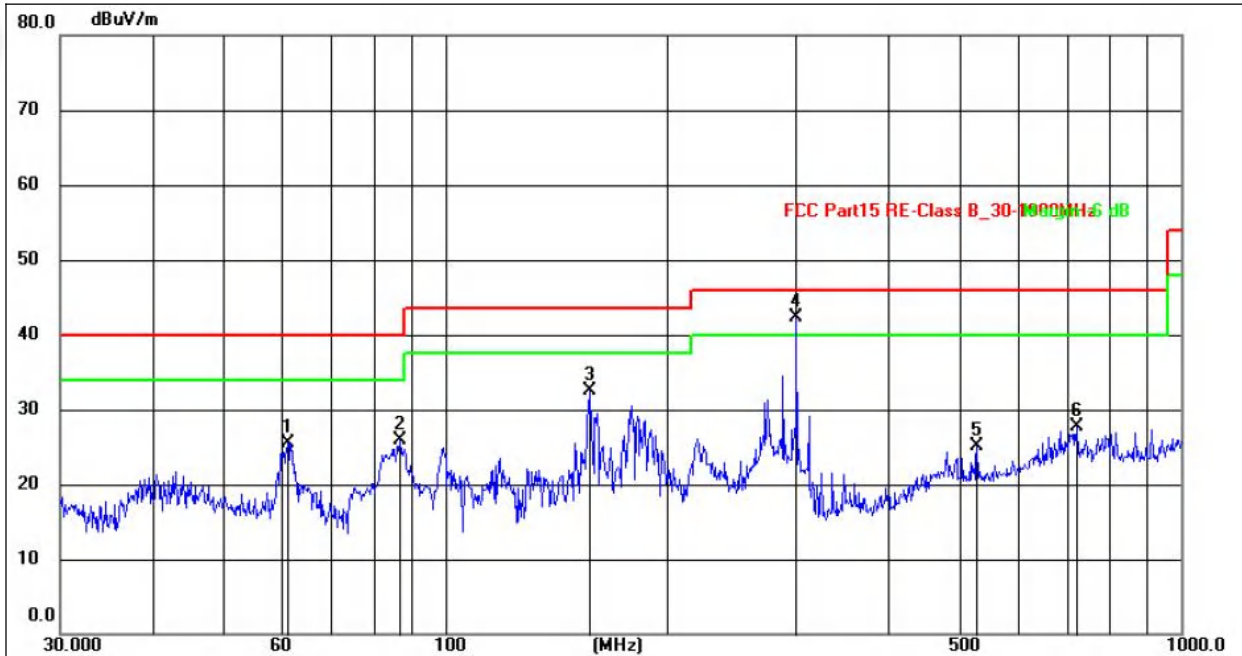

No.	Frequency (MHz)	Reading (dBuV)	Factor (dB/m)	Level (dBuV/m)	Limit (dBuV/m)	Margin (dB)	Detector
1	61.1315	40.10	-14.53	25.57	40.00	-14.43	QP
2	86.8067	45.84	-19.96	25.88	40.00	-14.12	QP
3	157.5586	48.69	-16.28	32.41	43.50	-11.09	QP
4	300.3672	59.27	-16.98	42.29	46.00	-3.71	QP
5	528.2458	35.95	-10.83	25.12	46.00	-20.88	QP
6	721.7258	34.41	-6.76	27.65	46.00	-18.35	QP



Temperature:	26°C	Relative Humidity:	54%
Pressure:	101kPa	Polarization:	Vertical
Test Voltage:	DC 12V	Test Mode :	TX 802.11n20 - 2412MHz

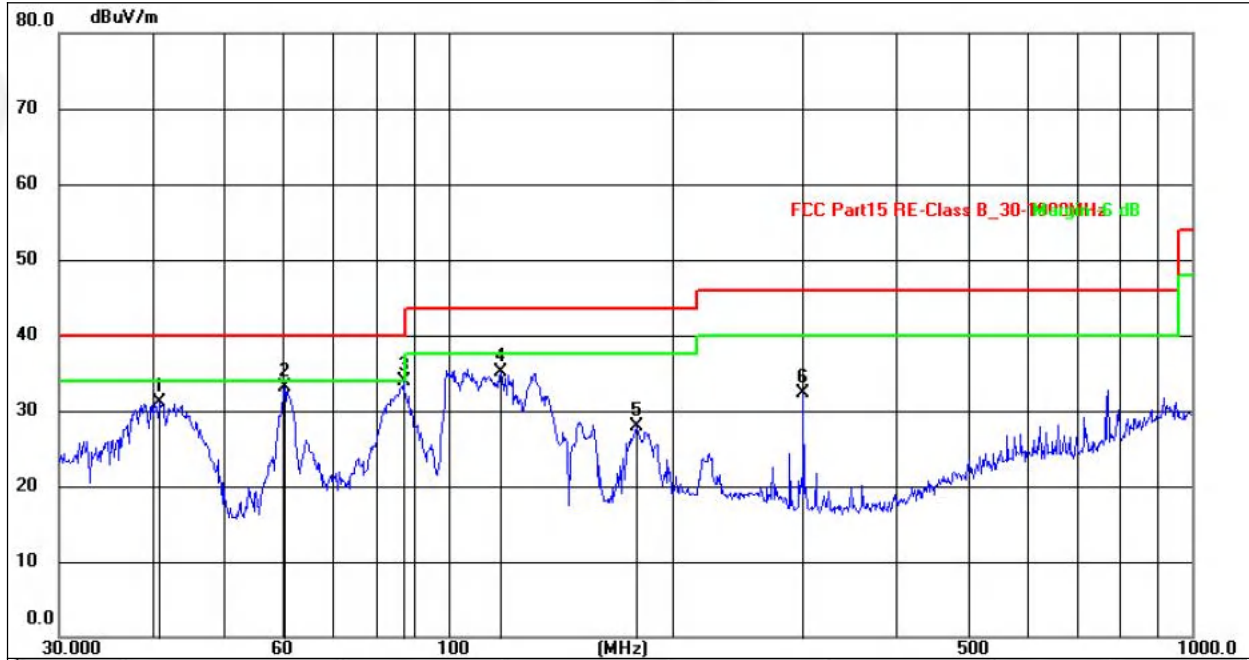

No.	Frequency (MHz)	Reading (dBuV)	Factor (dB/m)	Level (dBuV/m)	Limit (dBuV/m)	Margin (dB)	Detector
1	40.9879	47.98	-16.90	31.08	40.00	-8.92	QP
2	60.2800	51.36	-18.34	33.02	40.00	-6.98	QP
3	87.1115	55.46	-21.61	33.85	40.00	-6.15	QP
4	117.7724	56.52	-21.36	35.16	43.50	-8.34	QP
5	179.3863	47.66	-19.85	27.81	43.50	-15.69	QP
6	300.3672	50.57	-18.32	32.25	46.00	-13.75	QP

Remarks:

- 1.Final Level =Receiver Read level + Antenna Factor + Cable Loss – Preamplifier Factor
- 2.The emission levels of other frequencies are very lower than the limit and not show in test report.
- 3.The test data shows only the worst case TX 802.11b - 2412MHz.



1GHz~25GHz

802.11b

Polar (H/V)	Frequency	Meter Reading	Pre-ampl ifier	Cable Loss	Antenna Factor	Emission Level	Limits	Margin	Detect or Type
	(MHz)	(dBuV)	(dB)	(dB)	(dB)	(dBuV/m)	(dBuV/ m)	(dB)	
Low Channel:2412MHz									
V	4824.00	50.24	30.55	5.77	24.66	50.12	74.00	-23.88	PK
V	4824.00	43.09	30.55	5.77	24.66	42.97	54.00	-11.03	AV
V	7236.00	52.90	30.33	6.32	24.55	53.44	74.00	-20.56	PK
V	7236.00	43.95	30.33	6.32	24.55	44.49	54.00	-9.51	AV
V	9648.00	51.44	30.85	7.45	24.69	52.73	74.00	-21.27	PK
V	9648.00	43.76	30.85	7.45	24.69	45.05	54.00	-8.95	AV
V	12060.00	51.01	31.02	8.99	25.57	54.55	74.00	-19.45	PK
V	12060.00	43.07	31.02	8.99	25.57	46.61	54.00	-7.39	AV
H	4824.00	54.58	30.55	5.77	24.66	54.46	74.00	-19.54	PK
H	4824.00	43.36	30.55	5.77	24.66	43.24	54.00	-10.76	AV
H	7236.00	54.22	30.33	6.32	24.55	54.76	74.00	-19.24	PK
H	7236.00	43.58	30.33	6.32	24.55	44.12	54.00	-9.88	AV
H	9648.00	51.60	30.85	7.45	24.69	52.89	74.00	-21.11	PK
H	9648.00	43.94	30.85	7.45	24.69	45.23	54.00	-8.77	AV
H	12060.00	52.18	31.02	8.99	25.57	55.72	74.00	-18.28	PK
H	12060.00	43.26	31.02	8.99	25.57	46.80	54.00	-7.20	AV

Polar (H/V)	Frequency	Meter Reading	Pre-ampl ifier	Cable Loss	Antenna Factor	Emission Level	Limits	Margin	Detect or Type
	(MHz)	(dBuV)	(dB)	(dB)	(dB)	(dBuV/m)	(dBuV/ m)	(dB)	
Middle Channel:2437MHz									
V	4874.00	51.91	30.55	5.77	24.66	51.79	74.00	-22.21	PK
V	4874.00	43.39	30.55	5.77	24.66	43.27	54.00	-10.73	AV
V	7311.00	52.70	30.33	6.32	24.55	53.24	74.00	-20.76	PK
V	7311.00	43.95	30.33	6.32	24.55	44.49	54.00	-9.51	AV
V	9748.00	51.22	30.85	7.45	24.69	52.51	74.00	-21.49	PK
V	9748.00	43.43	30.85	7.45	24.69	44.72	54.00	-9.28	AV
V	12185.00	54.35	31.02	8.99	25.57	57.89	74.00	-16.11	PK
V	12185.00	43.23	31.02	8.99	25.57	46.77	54.00	-7.23	AV
H	4874.00	51.79	30.55	5.77	24.66	51.67	74.00	-22.33	PK
H	4874.00	43.64	30.55	5.77	24.66	43.52	54.00	-10.48	AV
H	7311.00	51.19	30.33	6.32	24.55	51.73	74.00	-22.27	PK
H	7311.00	43.87	30.33	6.32	24.55	44.41	54.00	-9.59	AV
H	9748.00	52.78	30.85	7.45	24.69	54.07	74.00	-19.93	PK
H	9748.00	43.11	30.85	7.45	24.69	44.40	54.00	-9.60	AV
H	12185.00	50.36	31.02	8.99	25.57	53.90	74.00	-20.10	PK
H	12185.00	43.51	31.02	8.99	25.57	47.05	54.00	-6.95	AV



Polar (H/V)	Frequency	Meter Reading	Pre-ampli fier	Cable Loss	Antenna Factor	Emission Level	Limits	Margin	Detect or Type
	(MHz)	(dBuV)	(dB)	(dB)	(dB)	(dBuV/m)	(dBuV/ m)	(dB)	
High Channel:2462MHz									
V	4924.00	51.94	30.55	5.77	24.66	51.82	74.00	-22.18	PK
V	4924.00	43.32	30.55	5.77	24.66	43.20	54.00	-10.80	AV
V	7386.00	52.48	30.33	6.32	24.55	53.02	74.00	-20.98	PK
V	7386.00	43.11	30.33	6.32	24.55	43.65	54.00	-10.35	AV
V	9848.00	52.07	30.85	7.45	24.69	53.36	74.00	-20.64	PK
V	9848.00	43.65	30.85	7.45	24.69	44.94	54.00	-9.06	AV
V	12310.00	53.58	31.02	8.99	25.57	57.12	74.00	-16.88	PK
V	12310.00	43.55	31.02	8.99	25.57	47.09	54.00	-6.91	AV
H	4924.00	52.45	30.55	5.77	24.66	52.33	74.00	-21.67	PK
H	4924.00	43.36	30.55	5.77	24.66	43.24	54.00	-10.76	AV
H	7386.00	53.64	30.33	6.32	24.55	54.18	74.00	-19.82	PK
H	7386.00	43.91	30.33	6.32	24.55	44.45	54.00	-9.55	AV
H	9848.00	52.79	30.85	7.45	24.69	54.08	74.00	-19.92	PK
H	9848.00	43.32	30.85	7.45	24.69	44.61	54.00	-9.39	AV
H	12310.00	50.78	31.02	8.99	25.57	54.32	74.00	-19.68	PK
H	12310.00	43.77	31.02	8.99	25.57	47.31	54.00	-6.69	AV

Remark:

1. Emission Level = Meter Reading + Antenna Factor + Cable Loss – Pre-amplifier,
Margin= Emission Level - Limit
2. If peak below the average limit, the average emission was no test.
3. The amplitude of spurious emissions which are attenuated by more than 20dB below the permissible value has no need to be reported.



802.11g

Polar (H/V)	Frequency	Meter Reading	Pre-amplifier	Cable Loss	Antenna Factor	Emission Level	Limits	Margin	Detect or Type
	(MHz)	(dBuV)	(dB)	(dB)	(dB)	(dBuV/m)	(dBuV/m)	(dB)	
Low Channel:2412MHz									
V	4824.00	53.64	30.55	5.77	24.66	53.52	74.00	-20.48	PK
V	4824.00	43.17	30.55	5.77	24.66	43.05	54.00	-10.95	AV
V	7236.00	53.07	30.33	6.32	24.55	53.61	74.00	-20.39	PK
V	7236.00	43.23	30.33	6.32	24.55	43.77	54.00	-10.23	AV
V	9648.00	50.31	30.85	7.45	24.69	51.60	74.00	-22.40	PK
V	9648.00	43.98	30.85	7.45	24.69	45.27	54.00	-8.73	AV
V	12060.00	51.18	31.02	8.99	25.57	54.72	74.00	-19.28	PK
V	12060.00	43.60	31.02	8.99	25.57	47.14	54.00	-6.86	AV
H	4824.00	53.52	30.55	5.77	24.66	53.40	74.00	-20.60	PK
H	4824.00	43.70	30.55	5.77	24.66	43.58	54.00	-10.42	AV
H	7236.00	52.60	30.33	6.32	24.55	53.14	74.00	-20.86	PK
H	7236.00	43.27	30.33	6.32	24.55	43.81	54.00	-10.19	AV
H	9648.00	53.34	30.85	7.45	24.69	54.63	74.00	-19.37	PK
H	9648.00	43.92	30.85	7.45	24.69	45.21	54.00	-8.79	AV
H	12060.00	51.74	31.02	8.99	25.57	55.28	74.00	-18.72	PK
H	12060.00	43.57	31.02	8.99	25.57	47.11	54.00	-6.89	AV

Polar (H/V)	Frequency	Meter Reading	Pre-amplifier	Cable Loss	Antenna Factor	Emission Level	Limits	Margin	Detect or Type
	(MHz)	(dBuV)	(dB)	(dB)	(dB)	(dBuV/m)	(dBuV/m)	(dB)	
Middle Channel:2437MHz									
V	4874.00	54.29	30.55	5.77	24.66	54.17	74.00	-19.83	PK
V	4874.00	43.02	30.55	5.77	24.66	42.90	54.00	-11.10	AV
V	7311.00	54.50	30.33	6.32	24.55	55.04	74.00	-18.96	PK
V	7311.00	43.32	30.33	6.32	24.55	43.86	54.00	-10.14	AV
V	9748.00	51.37	30.85	7.45	24.69	52.66	74.00	-21.34	PK
V	9748.00	43.89	30.85	7.45	24.69	45.18	54.00	-8.82	AV
V	12185.00	54.61	31.02	8.99	25.57	58.15	74.00	-15.85	PK
V	12185.00	43.83	31.02	8.99	25.57	47.37	54.00	-6.63	AV
H	4874.00	51.96	30.55	5.77	24.66	51.84	74.00	-22.16	PK
H	4874.00	43.66	30.55	5.77	24.66	43.54	54.00	-10.46	AV
H	7311.00	53.02	30.33	6.32	24.55	53.56	74.00	-20.44	PK
H	7311.00	43.15	30.33	6.32	24.55	43.69	54.00	-10.31	AV
H	9748.00	50.73	30.85	7.45	24.69	52.02	74.00	-21.98	PK
H	9748.00	43.61	30.85	7.45	24.69	44.90	54.00	-9.10	AV
H	12185.00	51.80	31.02	8.99	25.57	55.34	74.00	-18.66	PK
H	12185.00	43.38	31.02	8.99	25.57	46.92	54.00	-7.08	AV



Polar (H/V)	Frequency	Meter Reading	Pre-ampl ifier	Cable Loss	Antenna Factor	Emission Level	Limits	Margin	Detect or Type
	(MHz)	(dBuV)	(dB)	(dB)	(dB)	(dBuV/m)	(dBuV/ m)	(dB)	
High Channel:2462MHz									
V	4924.00	51.48	30.55	5.77	24.66	51.36	74.00	-22.64	PK
V	4924.00	43.07	30.55	5.77	24.66	42.95	54.00	-11.05	AV
V	7386.00	52.97	30.33	6.32	24.55	53.51	74.00	-20.49	PK
V	7386.00	43.31	30.33	6.32	24.55	43.85	54.00	-10.15	AV
V	9848.00	54.97	30.85	7.45	24.69	56.26	74.00	-17.74	PK
V	9848.00	43.46	30.85	7.45	24.69	44.75	54.00	-9.25	AV
V	12310.00	51.93	31.02	8.99	25.57	55.47	74.00	-18.53	PK
V	12310.00	43.85	31.02	8.99	25.57	47.39	54.00	-6.61	AV
H	4924.00	54.91	30.55	5.77	24.66	54.79	74.00	-19.21	PK
H	4924.00	43.45	30.55	5.77	24.66	43.33	54.00	-10.67	AV
H	7386.00	52.26	30.33	6.32	24.55	52.80	74.00	-21.20	PK
H	7386.00	43.75	30.33	6.32	24.55	44.29	54.00	-9.71	AV
H	9848.00	51.76	30.85	7.45	24.69	53.05	74.00	-20.95	PK
H	9848.00	43.87	30.85	7.45	24.69	45.16	54.00	-8.84	AV
H	12310.00	51.18	31.02	8.99	25.57	54.72	74.00	-19.28	PK
H	12310.00	43.55	31.02	8.99	25.57	47.09	54.00	-6.91	AV

Remark:

1. Emission Level = Meter Reading + Antenna Factor + Cable Loss – Pre-amplifier,

Margin= Emission Level - Limit

2. If peak below the average limit, the average emission was no test.

3. The amplitude of spurious emissions which are attenuated by more than 20dB below the permissible value has no need to be reported.



802.11n20

Polar (H/V)	Frequency	Meter Reading	Pre-amplifier	Cable Loss	Antenna Factor	Emission Level	Limits	Margin	Detect or Type
	(MHz)	(dBuV)	(dB)	(dB)	(dB)	(dBuV/m)	(dBuV/m)	(dB)	
Low Channel:2412MHz									
V	4824.00	51.52	30.55	5.77	24.66	51.40	74.00	-22.60	PK
V	4824.00	43.64	30.55	5.77	24.66	43.52	54.00	-10.48	AV
V	7236.00	53.70	30.33	6.32	24.55	54.24	74.00	-19.76	PK
V	7236.00	43.69	30.33	6.32	24.55	44.23	54.00	-9.77	AV
V	9648.00	53.72	30.85	7.45	24.69	55.01	74.00	-18.99	PK
V	9648.00	43.63	30.85	7.45	24.69	44.92	54.00	-9.08	AV
V	12060.00	54.83	31.02	8.99	25.57	58.37	74.00	-15.63	PK
V	12060.00	43.54	31.02	8.99	25.57	47.08	54.00	-6.92	AV
H	4824.00	54.43	30.55	5.77	24.66	54.31	74.00	-19.69	PK
H	4824.00	43.71	30.55	5.77	24.66	43.59	54.00	-10.41	AV
H	7236.00	52.27	30.33	6.32	24.55	52.81	74.00	-21.19	PK
H	7236.00	43.08	30.33	6.32	24.55	43.62	54.00	-10.38	AV
H	9648.00	50.18	30.85	7.45	24.69	51.47	74.00	-22.53	PK
H	9648.00	43.76	30.85	7.45	24.69	45.05	54.00	-8.95	AV
H	12060.00	52.04	31.02	8.99	25.57	55.58	74.00	-18.42	PK
H	12060.00	43.30	31.02	8.99	25.57	46.84	54.00	-7.16	AV

Polar (H/V)	Frequency	Meter Reading	Pre-amplifier	Cable Loss	Antenna Factor	Emission Level	Limits	Margin	Detect or Type
	(MHz)	(dBuV)	(dB)	(dB)	(dB)	(dBuV/m)	(dBuV/m)	(dB)	
Middle Channel:2437MHz									
V	4874.00	51.26	30.55	5.77	24.66	51.14	74.00	-22.86	PK
V	4874.00	43.30	30.55	5.77	24.66	43.18	54.00	-10.82	AV
V	7311.00	51.75	30.33	6.32	24.55	52.29	74.00	-21.71	PK
V	7311.00	43.13	30.33	6.32	24.55	43.67	54.00	-10.33	AV
V	9748.00	50.45	30.85	7.45	24.69	51.74	74.00	-22.26	PK
V	9748.00	43.52	30.85	7.45	24.69	44.81	54.00	-9.19	AV
V	12185.00	52.18	31.02	8.99	25.57	55.72	74.00	-18.28	PK
V	12185.00	43.40	31.02	8.99	25.57	46.94	54.00	-7.06	AV
H	4874.00	52.24	30.55	5.77	24.66	52.12	74.00	-21.88	PK
H	4874.00	43.81	30.55	5.77	24.66	43.69	54.00	-10.31	AV
H	7311.00	50.44	30.33	6.32	24.55	50.98	74.00	-23.02	PK
H	7311.00	43.21	30.33	6.32	24.55	43.75	54.00	-10.25	AV
H	9748.00	52.16	30.85	7.45	24.69	53.45	74.00	-20.55	PK
H	9748.00	43.91	30.85	7.45	24.69	45.20	54.00	-8.80	AV
H	12185.00	54.31	31.02	8.99	25.57	57.85	74.00	-16.15	PK
H	12185.00	43.64	31.02	8.99	25.57	47.18	54.00	-6.82	AV



Polar (H/V)	Frequency	Meter Reading	Pre-ampl ifier	Cable Loss	Antenna Factor	Emission Level	Limits	Margin	Detect or Type
	(MHz)	(dBuV)	(dB)	(dB)	(dB)	(dBuV/m)	(dBuV/ m)	(dB)	
High Channel:2462MHz									
V	4924.00	51.01	30.55	5.77	24.66	50.89	74.00	-23.11	PK
V	4924.00	43.23	30.55	5.77	24.66	43.11	54.00	-10.89	AV
V	7386.00	54.53	30.33	6.32	24.55	55.07	74.00	-18.93	PK
V	7386.00	43.88	30.33	6.32	24.55	44.42	54.00	-9.58	AV
V	9848.00	52.47	30.85	7.45	24.69	53.76	74.00	-20.24	PK
V	9848.00	43.78	30.85	7.45	24.69	45.07	54.00	-8.93	AV
V	12310.00	50.54	31.02	8.99	25.57	54.08	74.00	-19.92	PK
V	12310.00	43.83	31.02	8.99	25.57	47.37	54.00	-6.63	AV
H	4924.00	50.52	30.55	5.77	24.66	50.40	74.00	-23.60	PK
H	4924.00	43.08	30.55	5.77	24.66	42.96	54.00	-11.04	AV
H	7386.00	53.06	30.33	6.32	24.55	53.60	74.00	-20.40	PK
H	7386.00	43.86	30.33	6.32	24.55	44.40	54.00	-9.60	AV
H	9848.00	51.12	30.85	7.45	24.69	52.41	74.00	-21.59	PK
H	9848.00	43.39	30.85	7.45	24.69	44.68	54.00	-9.32	AV
H	12310.00	50.23	31.02	8.99	25.57	53.77	74.00	-20.23	PK
H	12310.00	43.69	31.02	8.99	25.57	47.23	54.00	-6.77	AV

Remark:

1. Emission Level = Meter Reading + Antenna Factor + Cable Loss – Pre-amplifier,

Margin= Emission Level - Limit

2. If peak below the average limit, the average emission was no test.

3. The amplitude of spurious emissions which are attenuated by more than 20dB below the permissible value has no need to be reported.



5. RADIATED Band EMISSION MEASUREMENT

5.1 TEST REQUIREMENT:

Test Requirement:	FCC Part15 C Section 15.209 and 15.205				
Test Method:	ANSI C63.10: 2013				
Test Frequency Range:	All of the restrict bands were tested, only the worst band's (2390MHz to 2500MHz) data was showed.				
Test site:	Measurement Distance: 3m				
Receiver setup:	Frequency	Detector	RBW	VBW	Value
	Above 1GHz	Peak	1MHz	3MHz	Peak
		Average	1MHz	3MHz	Average

LIMITS OF RADIATED EMISSION MEASUREMENT (Above 1000MHz)

FREQUENCY (MHz)	Class B (dBuV/m) (at 3M)	
	PEAK	AVERAGE
Above 1000	74	54

Notes:

- (1) The limit for radiated test was performed according to FCC PART 15C.
- (2) The tighter limit applies at the band edges.
- (3) Emission level (dBuV/m)=20log Emission level (uV/m).

5.2 TEST PROCEDURE

Above 1GHz test procedure as below:

- a. 1. The EUT was placed on the top of a rotating table 0.8 meters above the ground at a 3 meter camber. The table was rotated 360 degrees to determine the position of the highest radiation.
- b. The EUT was set 3 meters away from the interference-receiving antenna, which was mounted on the top of a variable-height antenna tower.
- c. The antenna height is varied from one meter to four meters above the ground to determine the maximum value of the field strength. Both horizontal and vertical polarizations of the antenna are set to make the measurement.
- d. For each suspected emission, the EUT was arranged to its worst case and then the antenna was tuned to heights from 1 meter to 4 meters and the rota table was turned from 0 degrees to 360 degrees to find the maximum reading.
- e. The test-receiver system was set to Peak Detect Function and Specified Bandwidth with Maximum Hold Mode.
- f. If the emission level of the EUT in peak mode was 10dB lower than the limit specified, then testing could be stopped and the peak values of the EUT would be reported. Otherwise the emissions that did not have 10dBmargin would be re-tested one by one using peak, quasi-peak or average method as specified and then reported in a data sheet.
- g. Test the EUT in the lowest channel, the Highest channel

Note:

Both horizontal and vertical antenna polarities were tested and performed pretest to three orthogonal axis. The worst case emissions were reported

5.3 DEVIATION FROM TEST STANDARD

No deviation



5.4 TEST SETUP

Radiated Emission Test-Up Frequency Above 1GHz

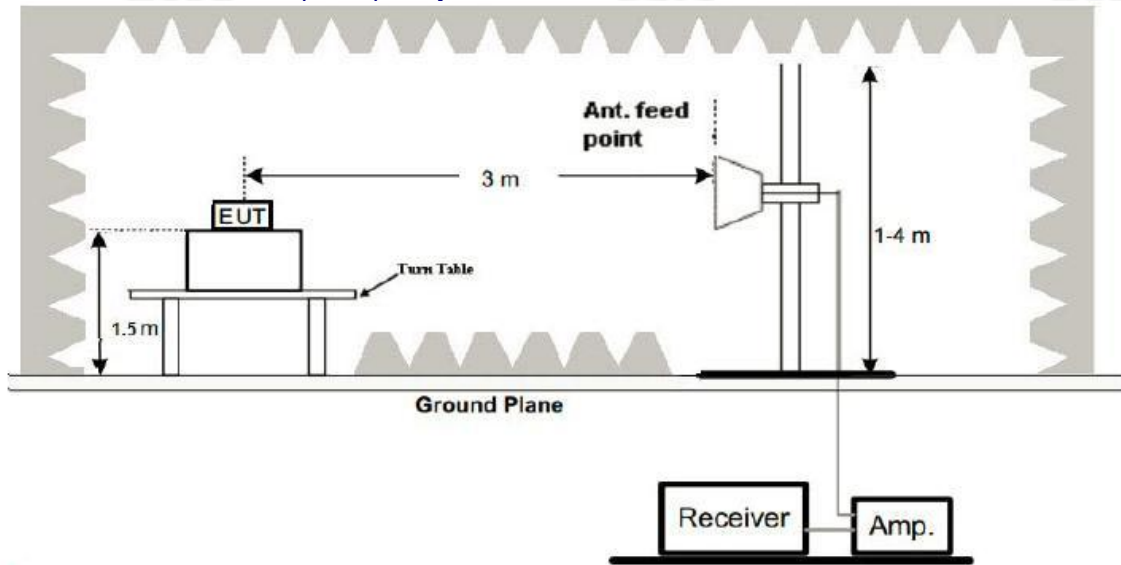

5.5 EUT OPERATING CONDITIONS

The EUT tested system was configured as the statements of 2.3 Unless otherwise a special operating condition is specified in the follows during the testing.



5.6 TEST RESULT

	Polar (H/V)	Frequenc y (MHz)	Meter Reading (dBuV)	Pre-amplifier (dB)	Cable Loss (dB)	Antenna Factor (dB/m)	Emission level (dBuV/m)	Limit (dBuV /m)	Detec tor Type	Result
802.11b	LowChannel 2412MHz									
	H	2390.00	54.58	30.22	4.85	23.98	53.19	74.00	PK	PASS
	H	2390.00	44.07	30.22	4.85	23.98	42.68	54.00	AV	PASS
	H	2400.00	53.05	30.22	4.85	23.98	51.66	74.00	PK	PASS
	H	2400.00	44.70	30.22	4.85	23.98	43.31	54.00	AV	PASS
	V	2390.00	54.74	30.22	4.85	23.98	53.35	74.00	PK	PASS
	V	2390.00	44.49	30.22	4.85	23.98	43.10	54.00	AV	PASS
	V	2400.00	53.87	30.22	4.85	23.98	52.48	74.00	PK	PASS
	V	2400.00	44.36	30.22	4.85	23.98	42.97	54.00	AV	PASS
	HighChannel 2462MHz									
	H	2483.50	53.17	30.22	4.85	23.98	51.78	74.00	PK	PASS
	H	2483.50	44.83	30.22	4.85	23.98	43.44	54.00	AV	PASS
	H	2500.00	54.10	30.22	4.85	23.98	52.71	74.00	PK	PASS
	H	2500.00	44.05	30.22	4.85	23.98	42.66	54.00	AV	PASS
	V	2483.50	53.25	30.22	4.85	23.98	51.86	74.00	PK	PASS
	V	2483.50	44.81	30.22	4.85	23.98	43.42	54.00	AV	PASS
V	2500.00	54.84	30.22	4.85	23.98	53.45	74.00	PK	PASS	
V	2500.00	44.74	30.22	4.85	23.98	43.35	54.00	AV	PASS	
802.11g	LowChannel 2412MHz									
	H	2390.00	53.20	30.22	4.85	23.98	51.81	74.00	PK	PASS
	H	2390.00	44.20	30.22	4.85	23.98	42.81	54.00	AV	PASS
	H	2400.00	53.62	30.22	4.85	23.98	52.23	74.00	PK	PASS
	H	2400.00	44.37	30.22	4.85	23.98	42.98	54.00	AV	PASS
	V	2390.00	53.81	30.22	4.85	23.98	52.42	74.00	PK	PASS
	V	2390.00	44.17	30.22	4.85	23.98	42.78	54.00	AV	PASS
	V	2400.00	54.92	30.22	4.85	23.98	53.53	74.00	PK	PASS
	V	2400.00	44.17	30.22	4.85	23.98	42.78	54.00	AV	PASS
	High Channel 2462MHz									
	H	2483.50	54.86	30.22	4.85	23.98	53.47	74.00	PK	PASS
	H	2483.50	44.40	30.22	4.85	23.98	43.01	54.00	AV	PASS
	H	2500.00	53.50	30.22	4.85	23.98	52.11	74.00	PK	PASS
	H	2500.00	44.96	30.22	4.85	23.98	43.57	54.00	AV	PASS
	V	2483.50	53.04	30.22	4.85	23.98	51.65	74.00	PK	PASS
	V	2483.50	44.29	30.22	4.85	23.98	42.90	54.00	AV	PASS
V	2500.00	53.87	30.22	4.85	23.98	52.48	74.00	PK	PASS	
V	2500.00	44.39	30.22	4.85	23.98	43.00	54.00	AV	PASS	
Remark:										
Emission Level = Meter Reading + Antenna Factor + Cable Loss – Pre-amplifier, Margin= Emission Level - Limit										



	Polar (H/V)	Frequency (MHz)	Meter Reading (dBuV)	Pre-amplifier (dB)	Cable Loss (dB)	Antenna Factor (dB/m)	Emission level (dBuV/m)	Limit (dBuV/m)	Detector Type	Result
802.11n20	LowChannel 2412MHz									
	H	2390.00	54.64	30.22	4.85	23.98	53.25	74.00	PK	PASS
	H	2390.00	44.19	30.22	4.85	23.98	42.80	54.00	AV	PASS
	H	2400.00	54.12	30.22	4.85	23.98	52.73	74.00	PK	PASS
	H	2400.00	44.59	30.22	4.85	23.98	43.20	54.00	AV	PASS
	V	2390.00	54.87	30.22	4.85	23.98	53.48	74.00	PK	PASS
	V	2390.00	44.77	30.22	4.85	23.98	43.38	54.00	AV	PASS
	V	2400.00	53.88	30.22	4.85	23.98	52.49	74.00	PK	PASS
	V	2400.00	44.01	30.22	4.85	23.98	42.62	54.00	AV	PASS
	High Channel 2462MHz									
	H	2483.50	54.32	30.22	4.85	23.98	52.93	74.00	PK	PASS
	H	2483.50	44.80	30.22	4.85	23.98	43.41	54.00	AV	PASS
	H	2500.00	54.19	30.22	4.85	23.98	52.80	74.00	PK	PASS
	H	2500.00	44.95	30.22	4.85	23.98	43.56	54.00	AV	PASS
	V	2483.50	54.56	30.22	4.85	23.98	53.17	74.00	PK	PASS
	V	2483.50	44.99	30.22	4.85	23.98	43.60	54.00	AV	PASS
	V	2500.00	54.97	30.22	4.85	23.98	53.58	74.00	PK	PASS
	V	2500.00	44.15	30.22	4.85	23.98	42.76	54.00	AV	PASS

Remark:

1. Emission Level = Meter Reading + Antenna Factor + Cable Loss – Pre-amplifier, Margin= Emission Level - Limit



6. POWER SPECTRAL DENSITY TEST

Test Requirement:	FCC Part15 C Section 15.247 (e)
Test Method:	KDB558074 D0115.247 Meas Guidancev05r02

6.1 APPLIED PROCEDURES / LIMIT

FCC Part15 (15.247) , Subpart C				
Section	Test Item	Limit	Frequency Range (MHz)	Result
15.247	Power Spectral Density	8dBm/3kHz	2400-2483.5	PASS

6.2 TEST PROCEDURE

1. Set analyzer center frequency to DTS channel center frequency.
2. Set the span to 1.5 times the DTS bandwidth.
3. Set the RBW to: $3 \text{ kHz} \leq \text{RBW} \leq 100 \text{ kHz}$.
4. Set the VBW $\geq 3 \times \text{RBW}$.
5. Detector = peak.
6. Sweep time = auto couple.
7. Trace mode = max hold.
8. Allow trace to fully stabilize.
9. Use the peak marker function to determine the maximum amplitude level within the RBW.
10. If measured value exceeds limit, reduce RBW (no less than 3 kHz) and repeat.

6.3 DEVIATION FROM STANDARD

No deviation.

6.4 TEST SETUP



6.5 EUT OPERATION CONDITIONS

The EUT tested system was configured as the statements of 2.1 Unless otherwise a special operating condition is specified in the follows during the testing.



6.6 TEST RESULT

Temperature :	26°C	Relative Humidity :	54%
Pressure :	101kPa	Test Voltage :	DC 12V
Test Mode :	TX b Mode		

Frequency	Power Spectral Density (dBm/3kHz)	Limit (dBm/3kHz)	Result
2412 MHz	-9.866	8	PASS
2437 MHz	-10.524	8	PASS
2462 MHz	-11.406	8	PASS

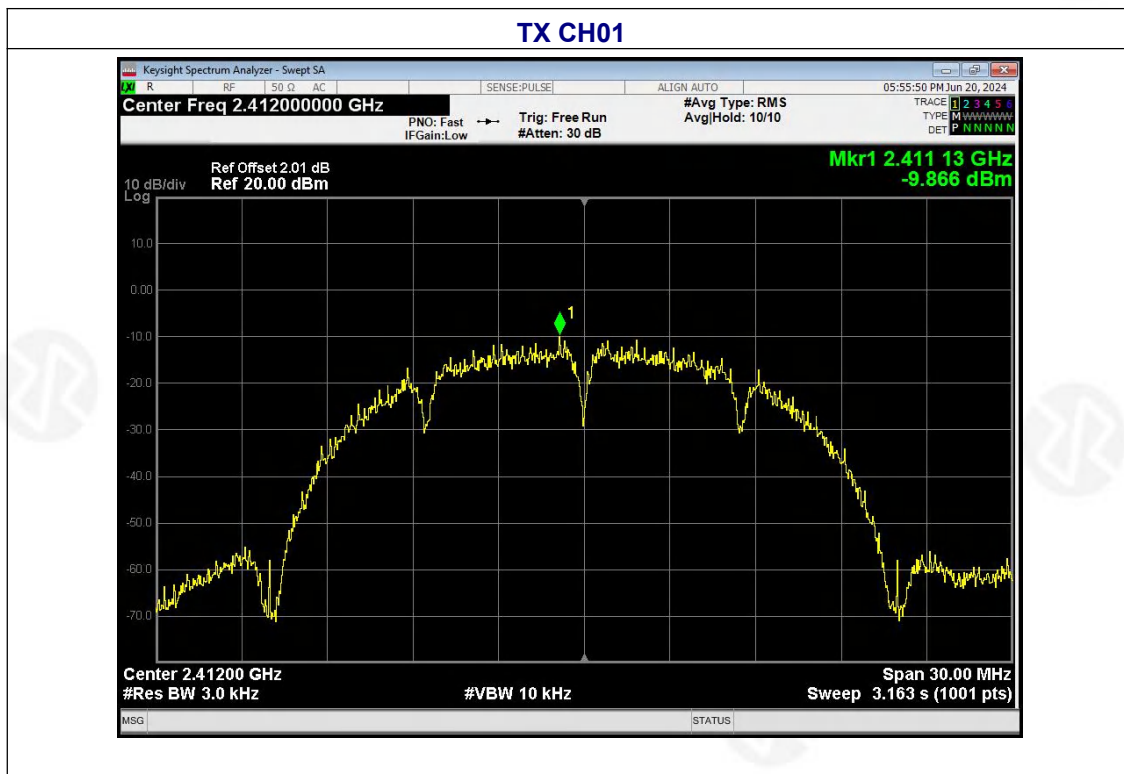



TX CH06

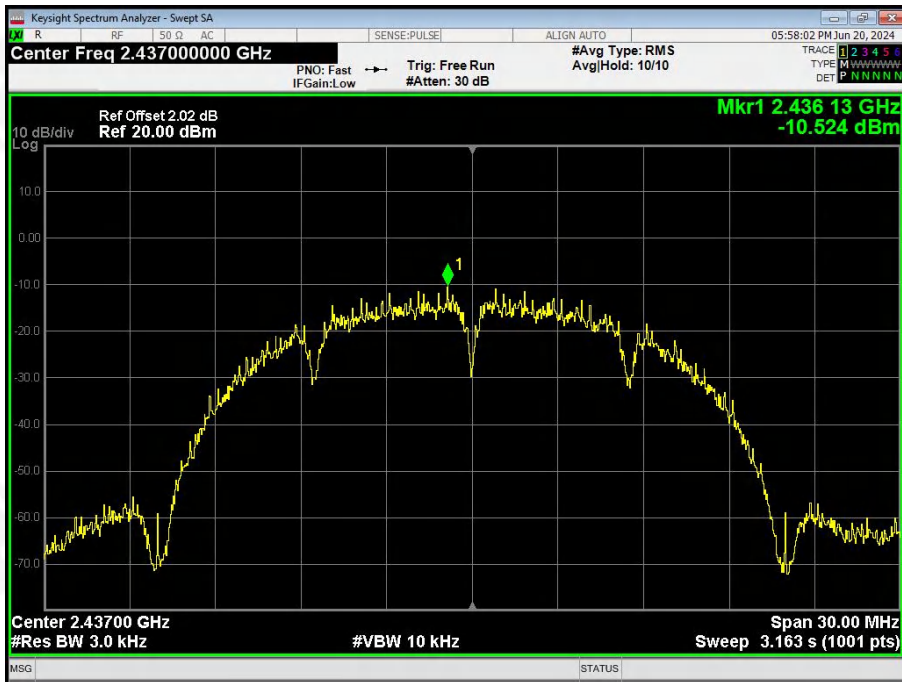

TX CH11

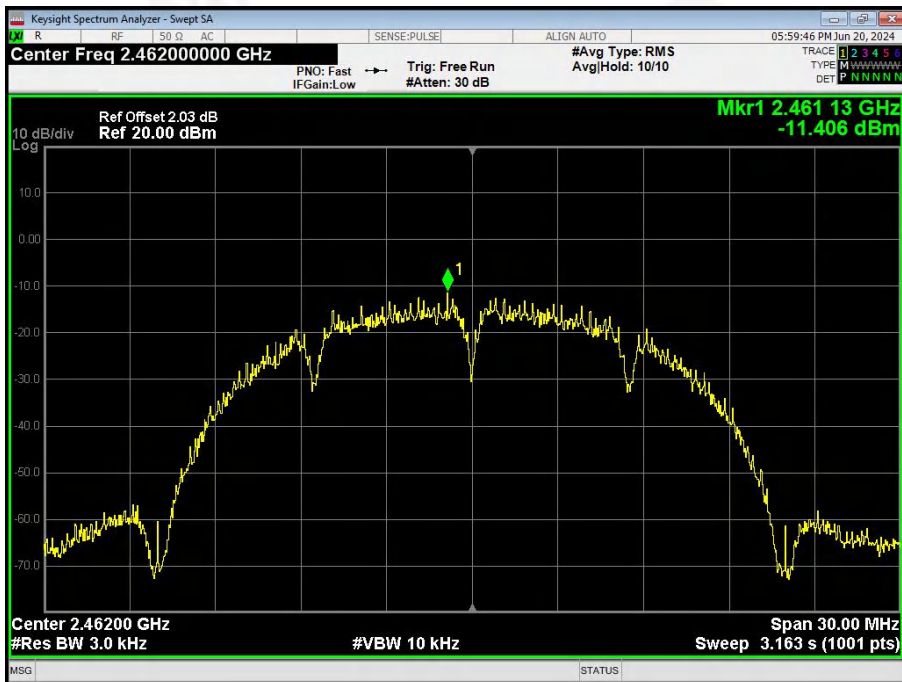



Temperature :	26°C	Relative Humidity :	54%
Pressure :	101kPa	Test Voltage :	DC 12V
Test Mode :	TX g Mode		

Frequency	Power Spectral Density (dBm/3kHz)	Limit (dBm/3kHz)	Result
2412 MHz	-16.456	8	PASS
2437 MHz	-18.079	8	PASS
2462 MHz	-18.156	8	PASS

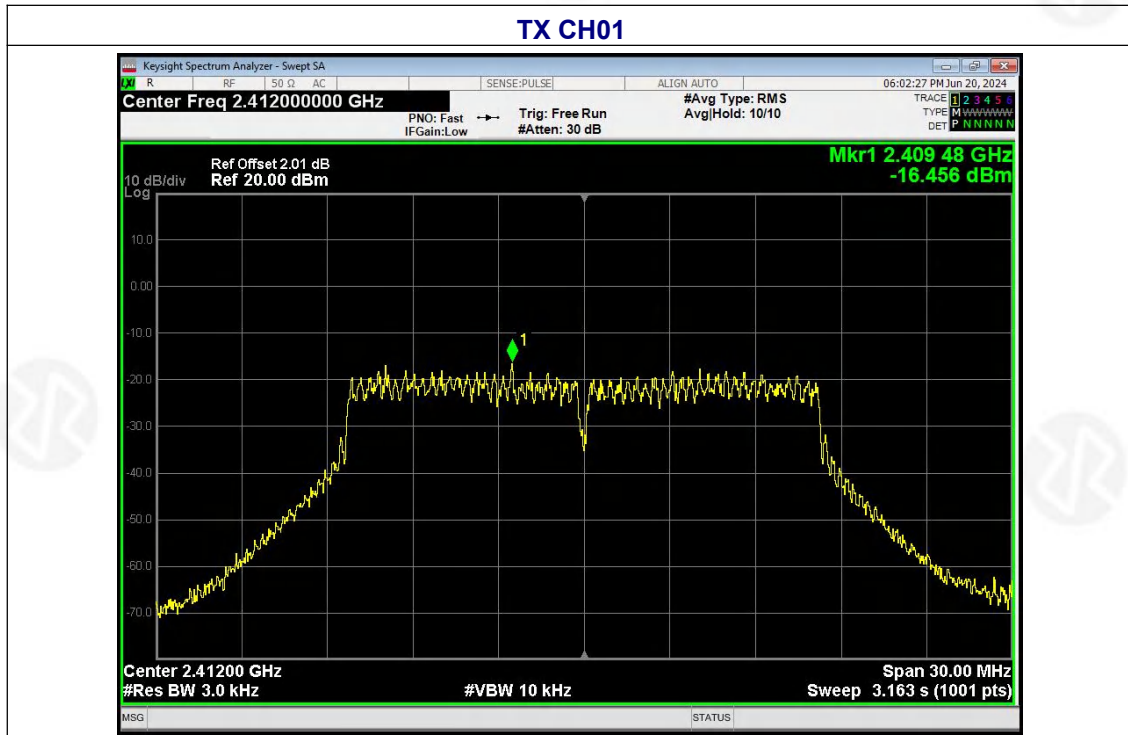



TX CH06

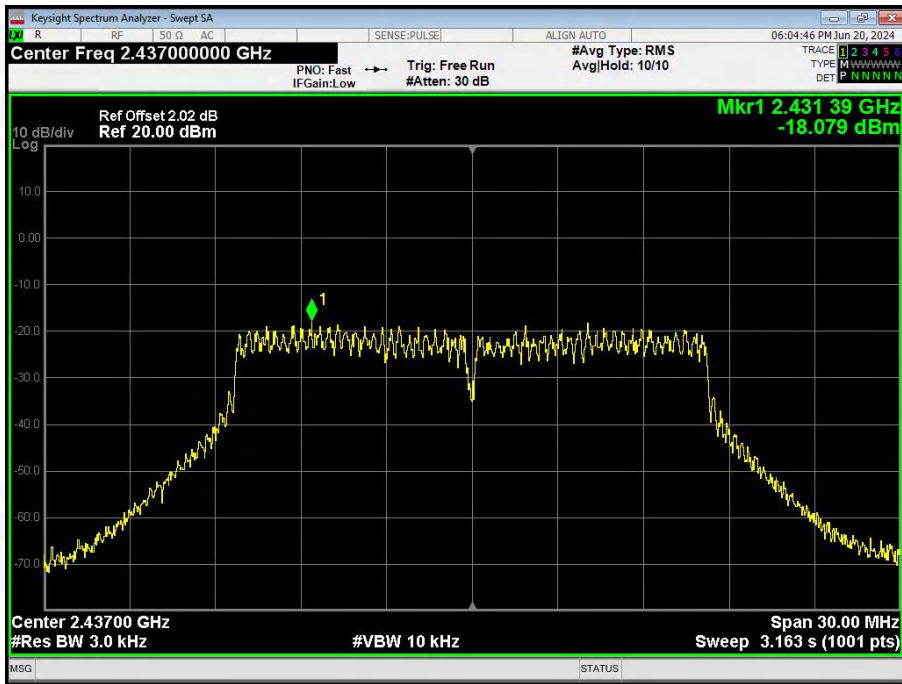

TX CH11

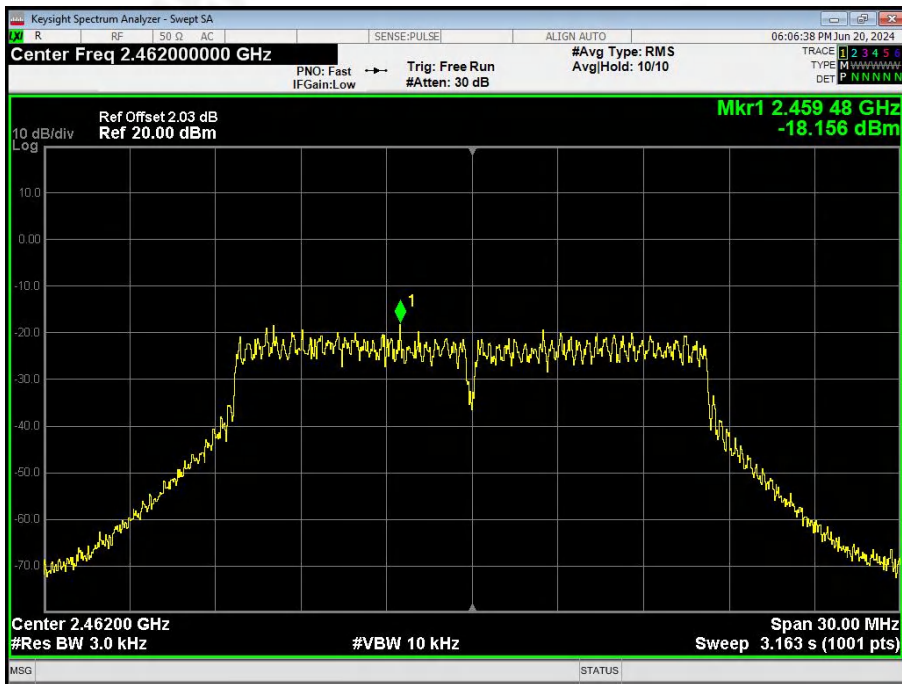



Temperature :	26°C	Relative Humidity :	54%
Pressure :	101kPa	Test Voltage :	DC 12V
Test Mode :	TX n Mode(20M)		

Frequency	Power Spectral Density (dBm/3kHz)	Limit (dBm/3kHz)	Result
2412 MHz	-18.501	8	PASS
2437 MHz	-19.018	8	PASS
2462 MHz	-19.84	8	PASS

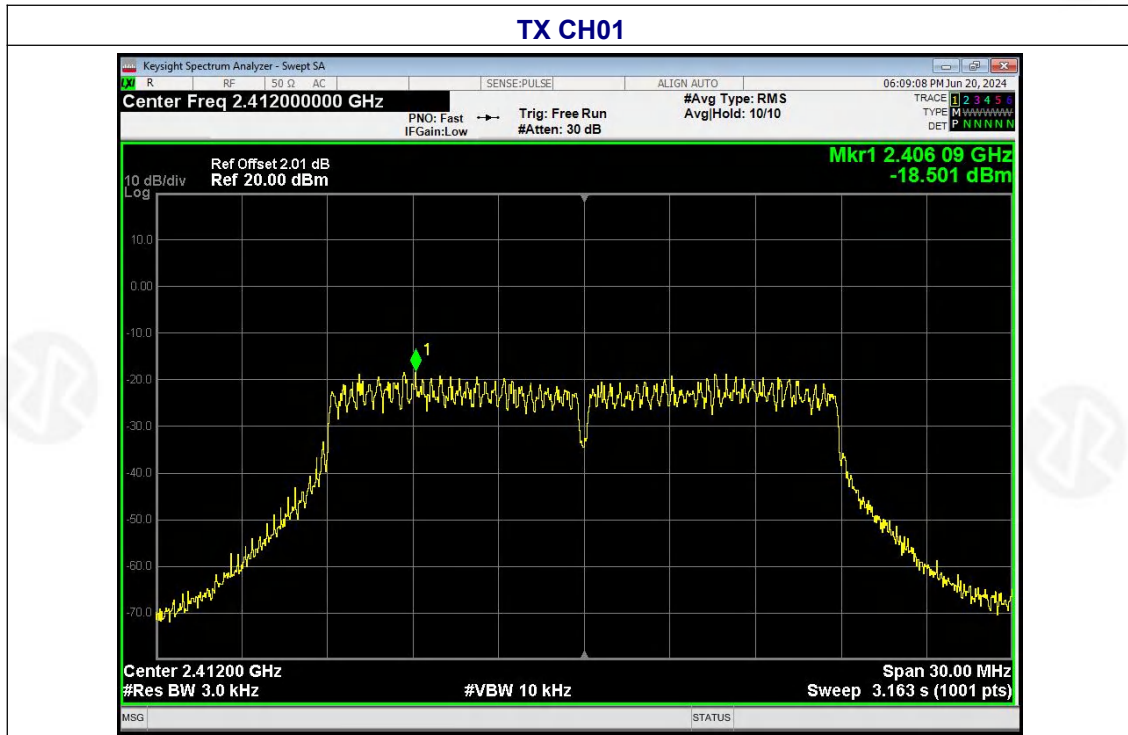



TX CH06

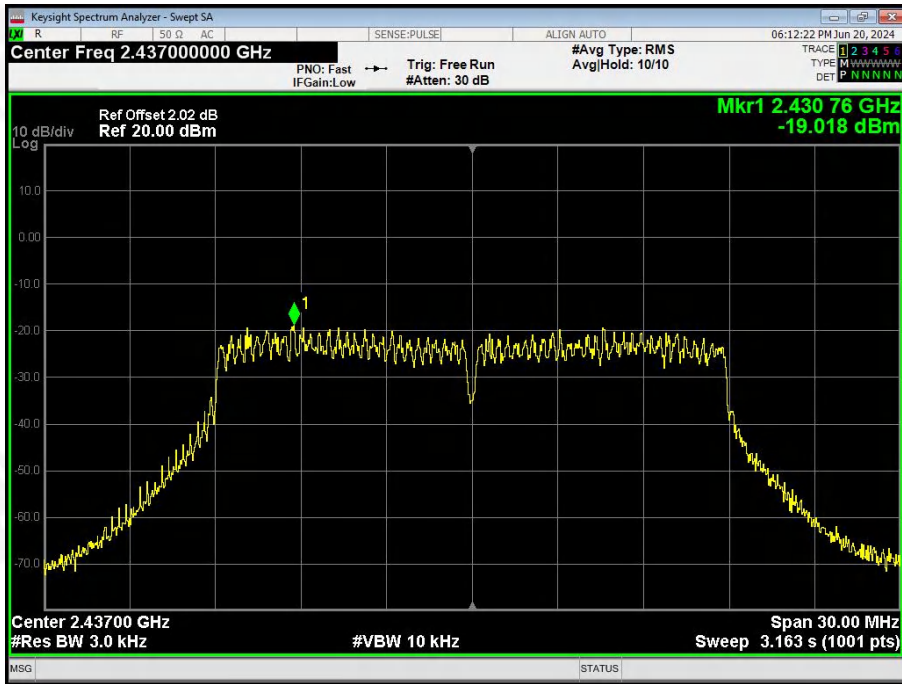

TX CH11

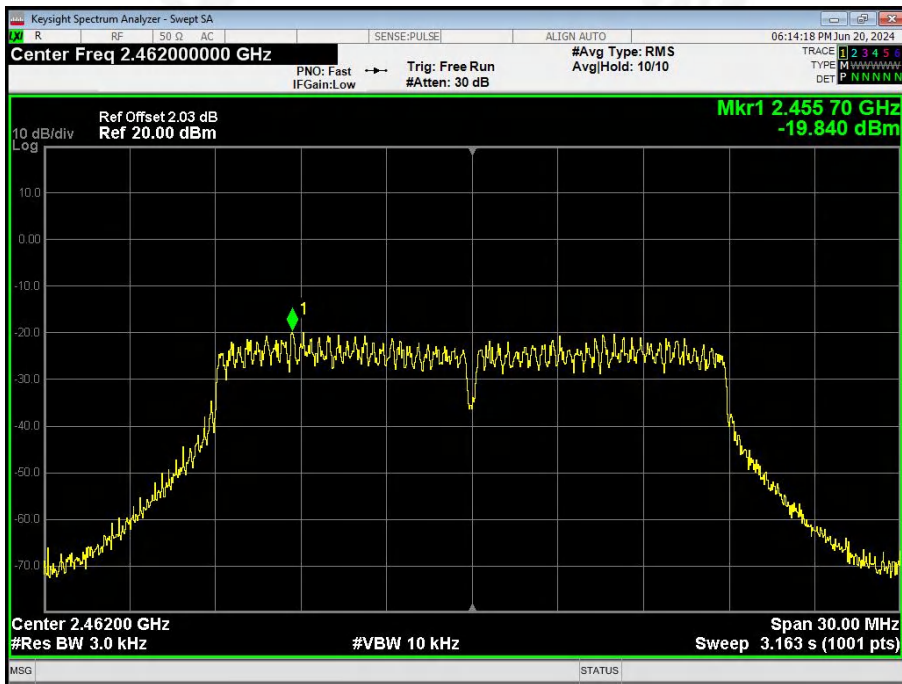



7. 6DB OCCUPIED BANDWIDTH

Test Requirement:	FCC Part15 C Section 15.247 (a)(2)
Test Method:	KDB558074 D0115.247 Meas Guidancev05r02

7.1 APPLIED PROCEDURES / LIMIT

FCC Part15 (15.247) , Subpart C				
Section	Test Item	Limit	Frequency Range (MHz)	Result
15.247(a)(2)	Bandwidth	$\geq 500\text{KHz}$ (6dB Occupied Bandwidth)	2400-2483.5	PASS

7.2 TEST PROCEDURE

1. Set RBW = 100 kHz.
2. Set the video bandwidth (VBW) $\geq 3 \times \text{RBW}$.
3. Detector = Peak.
4. Trace mode = max hold.
5. Sweep = auto couple.
6. Allow the trace to stabilize.
7. Measure the maximum width of the emission that is constrained by the frequencies associated with the two outermost amplitude points (upper and lower frequencies) that are attenuated by 6 dB relative to the maximum level measured in the fundamental emission.

7.3 DEVIATION FROM STANDARD

No deviation.

7.4 TEST SETUP



7.5 EUT OPERATION CONDITIONS

The EUT tested system was configured as the statements of 2.4 Unless otherwise a special operating condition is specified in the follows during the testing.



7.6 TEST RESULT

Temperature :	26°C	Relative Humidity :	54%
Pressure :	101kPa	Test Voltage :	DC 12V
Test Mode :	TX		

Test CH	6dB Occupied Bandwidth (MHz)				Result
	802.11b	802.11g	802.11n(HT20)	Limit(KHz)	
Lowest	10.099	16.303	16.651	>500	Pass
Middle	10.078	16.315	16.979		
Highest	10.101	16.294	16.815		



Test plot as follows:

802.11b

802.11g

Lowest channel

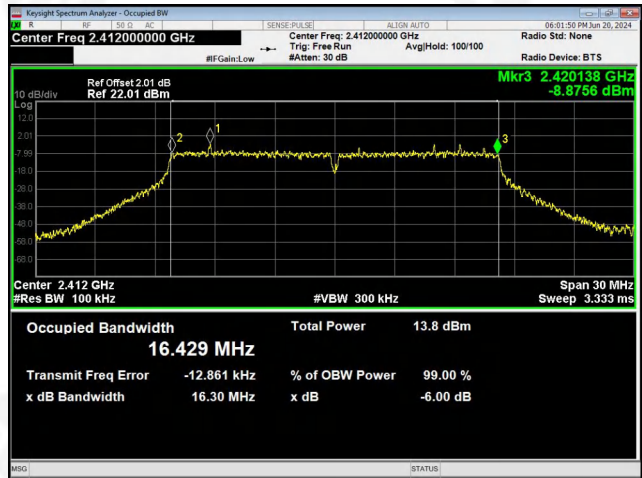
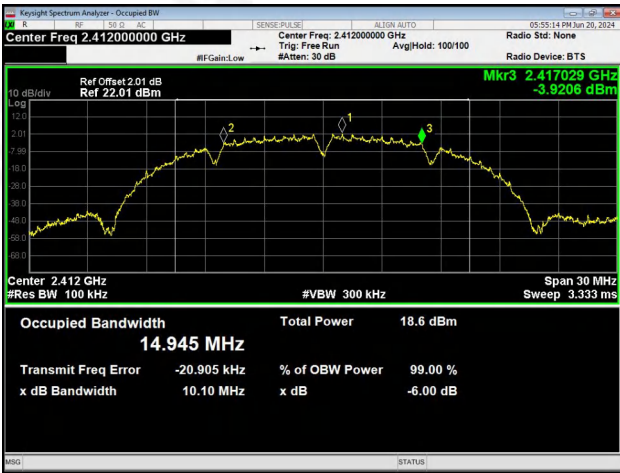

Middle channel

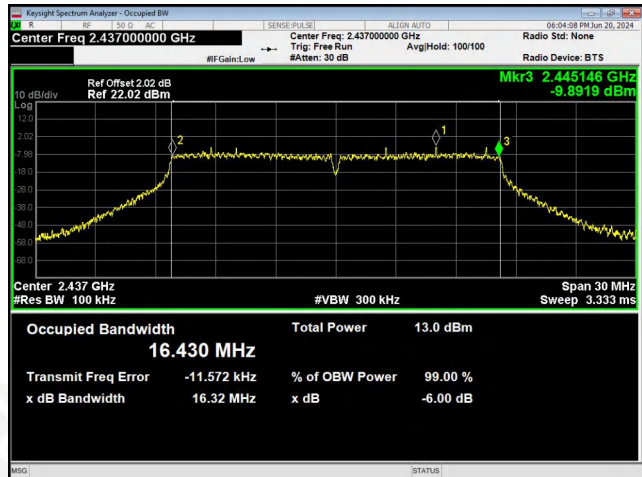
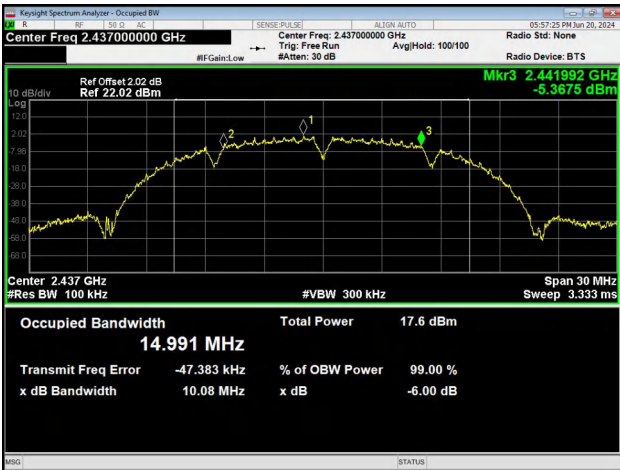

Highest channel

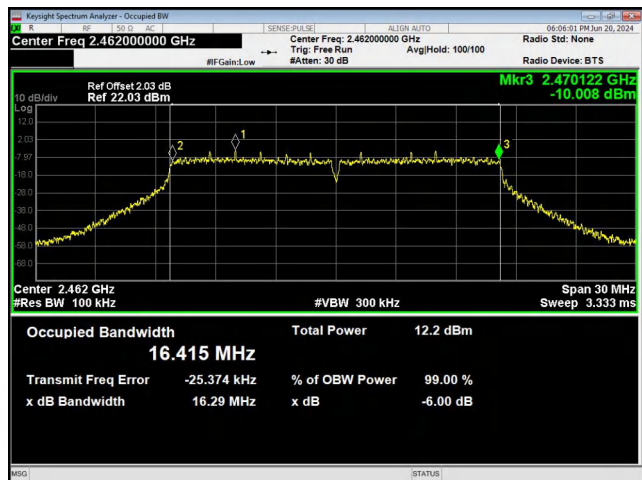
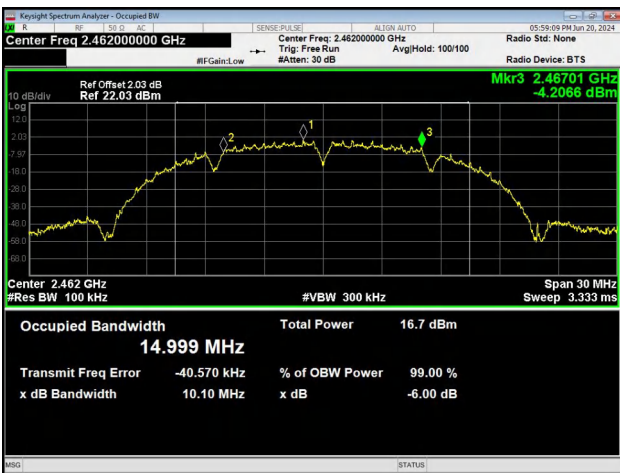



802.11n20 Lowest channel

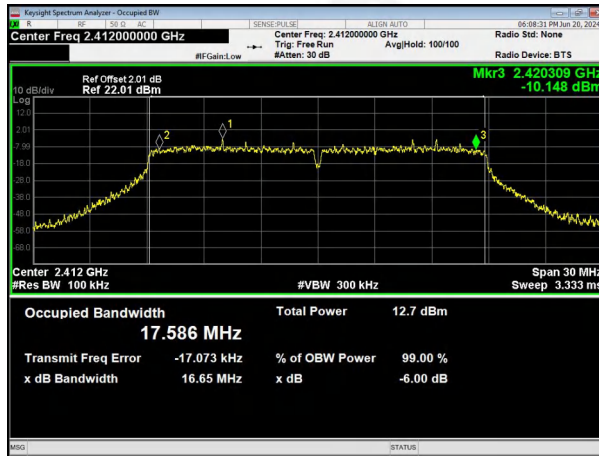

Middle channel

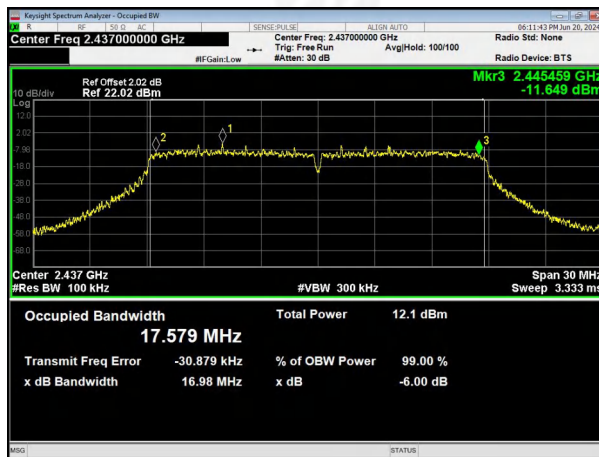

Highest channel

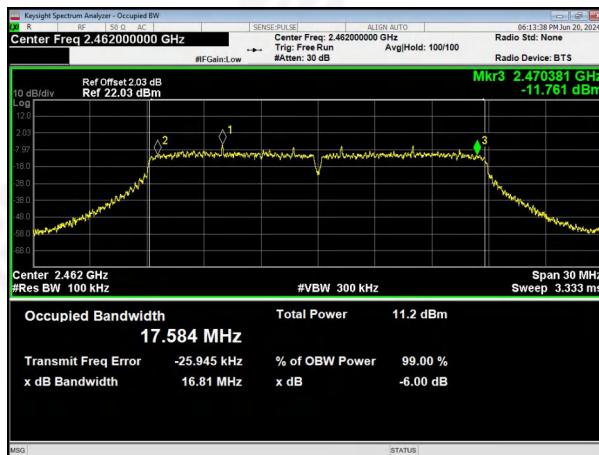



8. PEAK OUTPUT POWER TEST

Test Requirement:	FCC Part15 C Section 15.247 (b)(3)
Test Method:	KDB558074 D0115.247 Meas Guidancev05r02

8.1 APPLIED PROCEDURES/LIMIT

FCC Part15 (15.247) , Subpart C				
Section	Test Item	Limit	Frequency Range (MHz)	Result
15.247(b)(3)	Peak Output Power	1 watt or 30dBm	2400-2483.5	PASS

8.2 TEST PROCEDURE

- a. The EUT was directly connected to the Power meter

8.3 DEVIATION FROM STANDARD

No deviation.

8.4 TEST SETUP



8.5 EUT OPERATION CONDITIONS

The EUT tested system was configured as the statements of 2.4 Unless otherwise a special operating condition is specified in the follows during the testing.



8.6 TEST RESULT

Temperature :	26°C	Relative Humidity :	54%
Pressure :	101kPa	Test Voltage :	DC 12V

Test CH	Peak Output Power (dBm)			Limit(dBm)	Result
	802.11b	802.11g	802.11n(HT20)		
Lowest	9.046	7.613	6.419	30.00	Pass
Middle	7.904	6.896	5.716		
Highest	6.914	5.849	4.9		



9. CONDUCTED BAND EDGE AND SPURIOUS EMISSION

Test Requirement:	FCC Part15 C Section 15.247 (d)
Test Method:	KDB558074 D0115.247 Meas Guidancev05r02

9.1 APPLICABLE STANDARD

in any 100 kHz bandwidth outside the frequency bands in which the spread spectrum intentional radiator is operating, the radio frequency power that is produced by the intentional radiator shall be at least 20dB below that in the 100kHz bandwidth within the band that contains the highest level of the desired power, In addition, radiated emissions which fall in the restricted bands, as defined in§15.205(a), must also comply with the radiated emission limits specified in15.209(a).

9.2 TEST PROCEDURE

Using the following spectrum analyzer setting:

- A) Set the RBW = 100KHz.
- B) Set the VBW = 300KHz.
- C) Sweep time = auto couple.
- D) Detector function = peak.
- E) Trace mode = max hold.
- F) Allow trace to fully stabilize.

9.3 DEVIATION FROM STANDARD

No deviation.

9.4 TEST SETUP

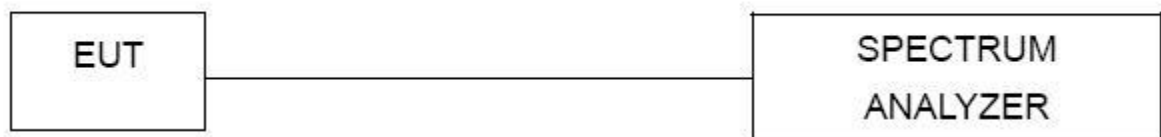

9.5 EUT OPERATION CONDITIONS

The EUT tested system was configured as the statements of 2.4 Unless otherwise a special operating condition is specified in the follows during the testing.

9.6 TEST RESULTS



Test plot as follows:

Test mode:

802.11b

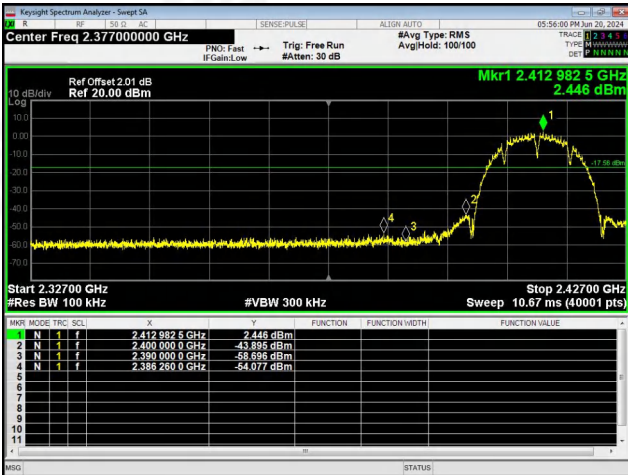

Lowest channel

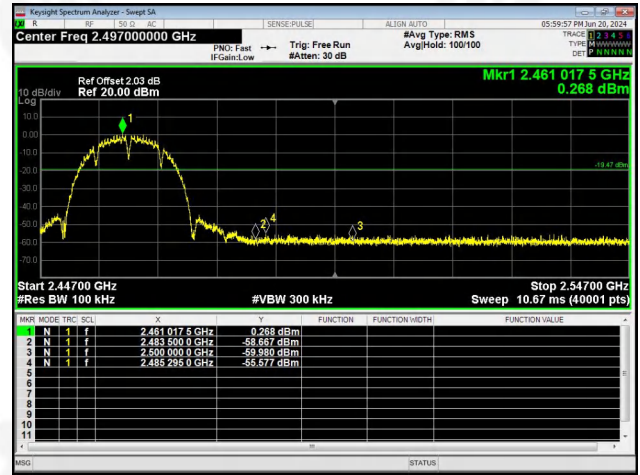

Highest channel

Test mode:

802.11g

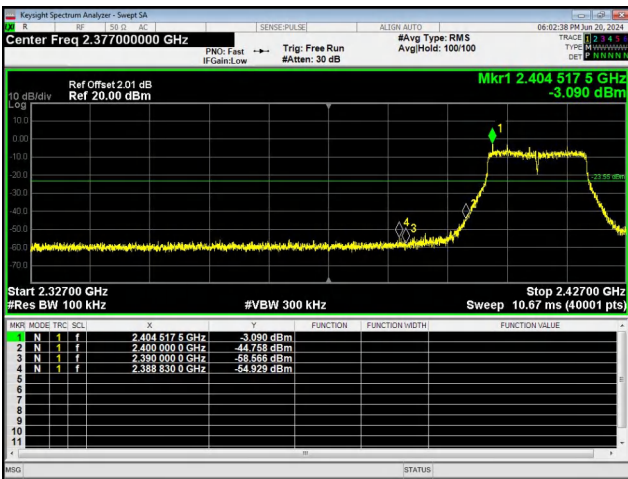

Lowest channel

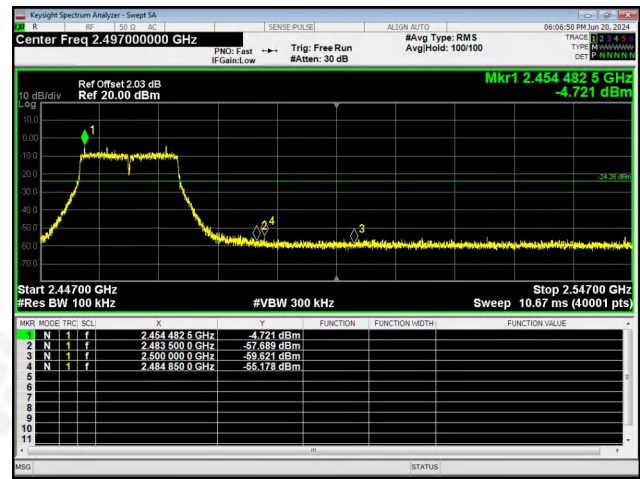

Highest channel

Test mode:

802.11n(HT20)

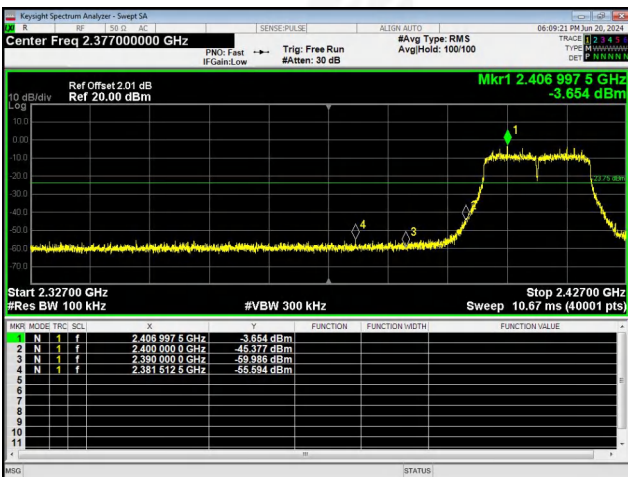

Lowest channel

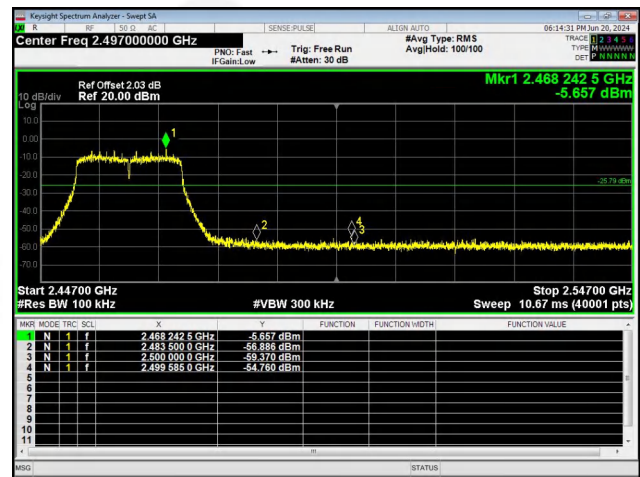

Highest channel



Test plot as follows:

802.11b
Lowest channel

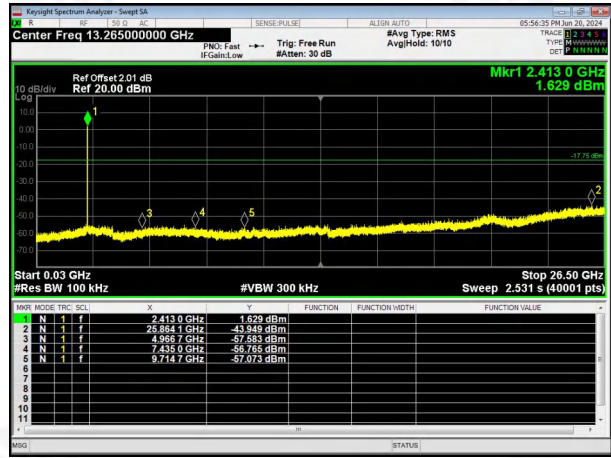
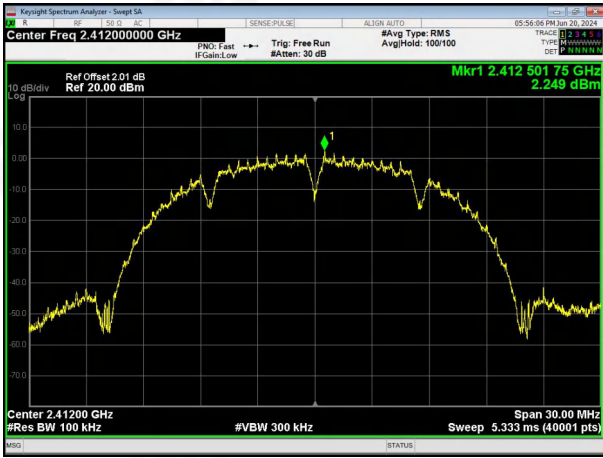

Middle channel

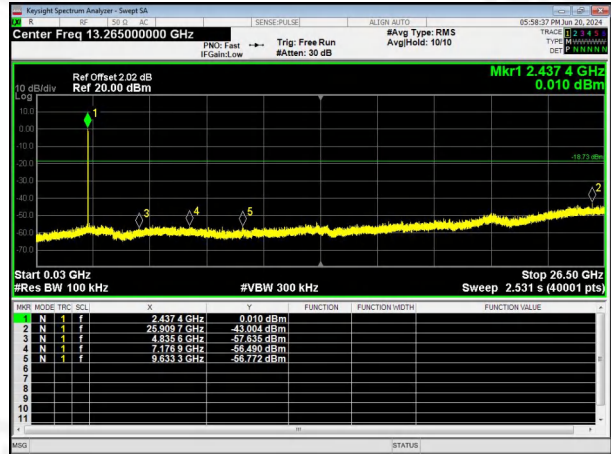
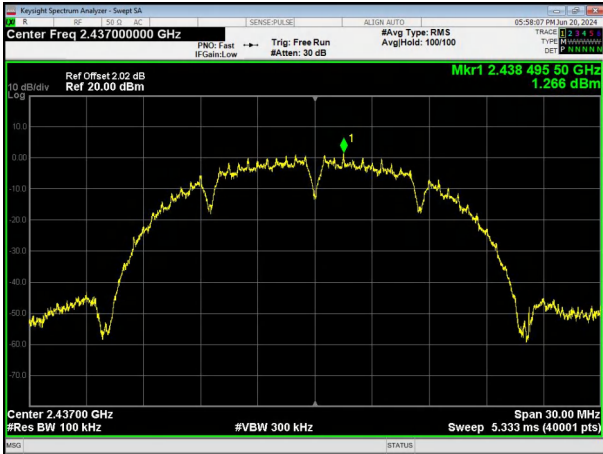

Highest channel

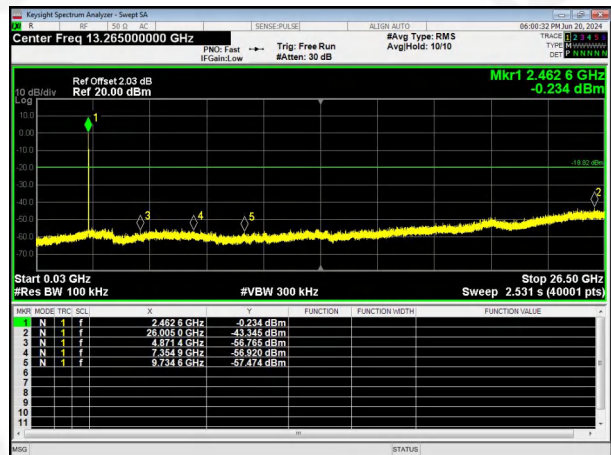
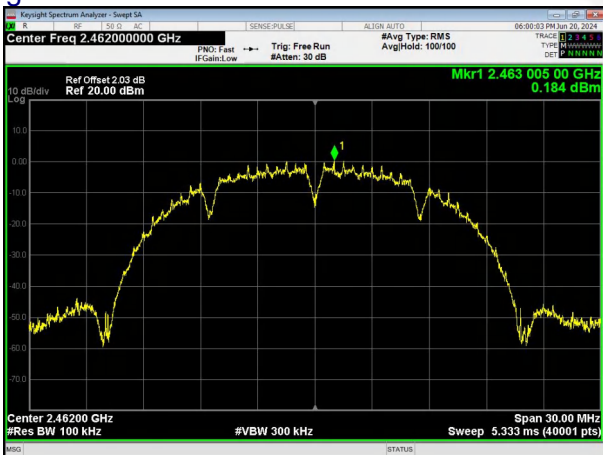



802.11g
Lowest channel

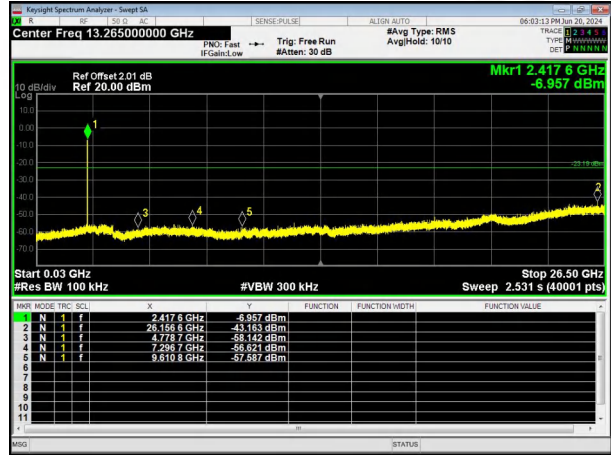
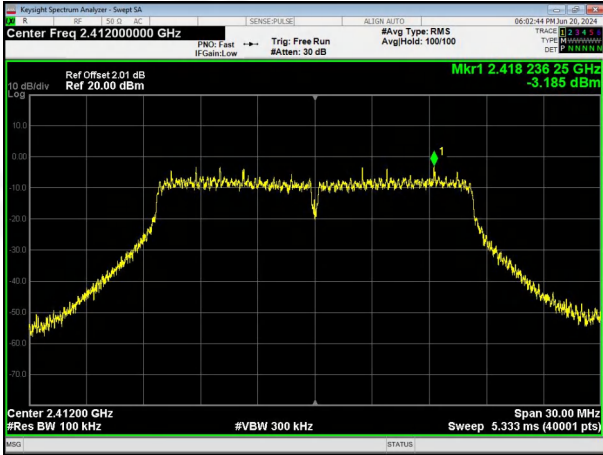

Middle channel

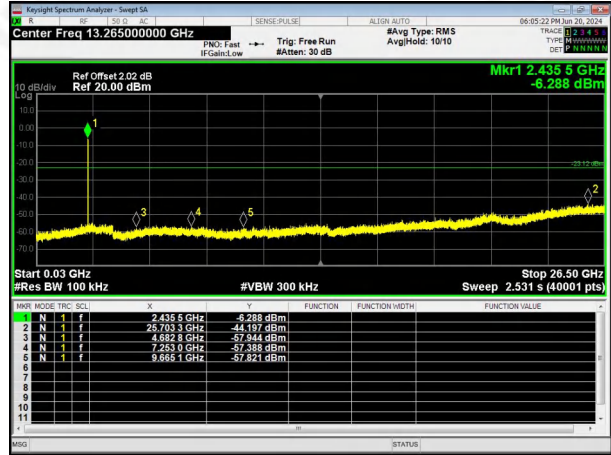
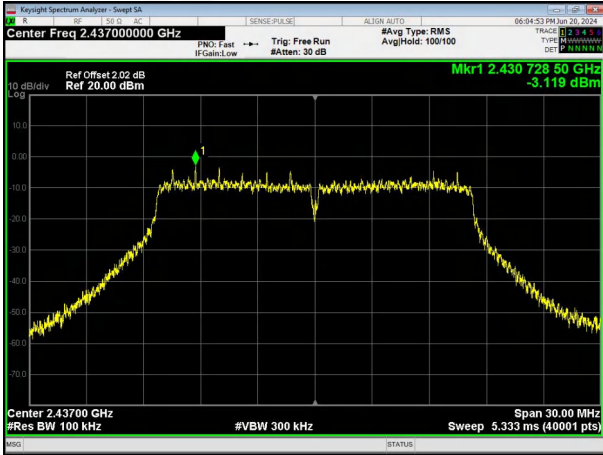

Highest channel

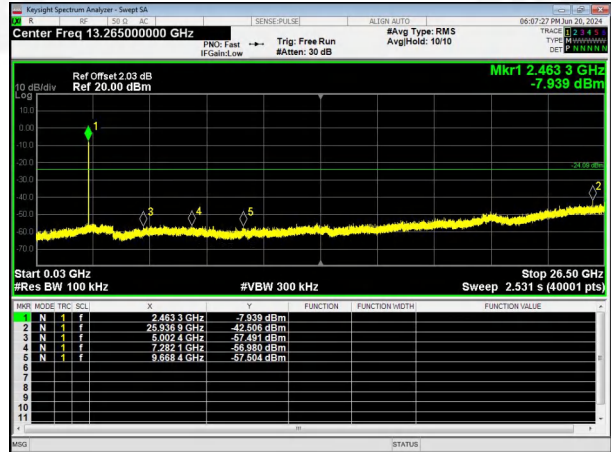
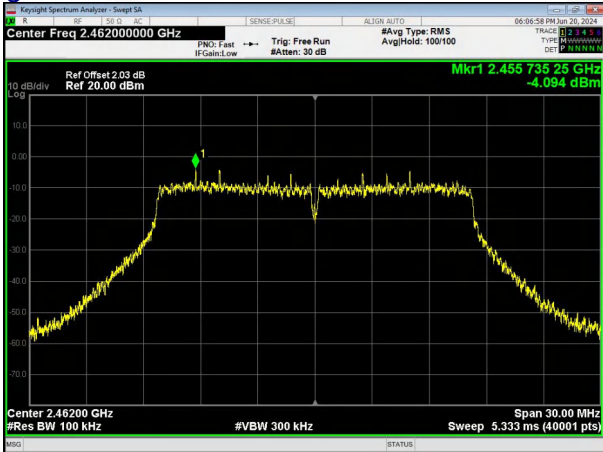



802.11n(HT20)
Lowest channel

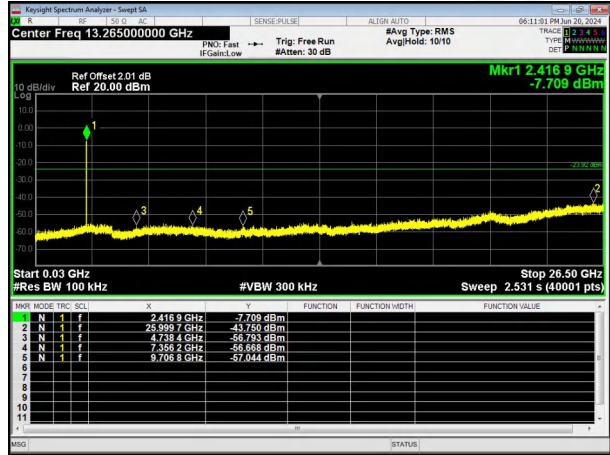
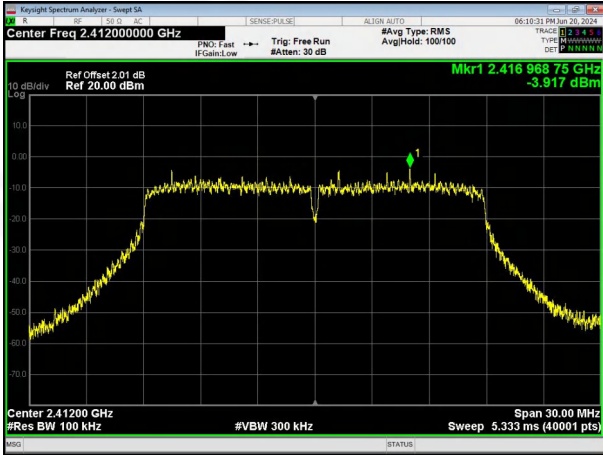

Middle channel

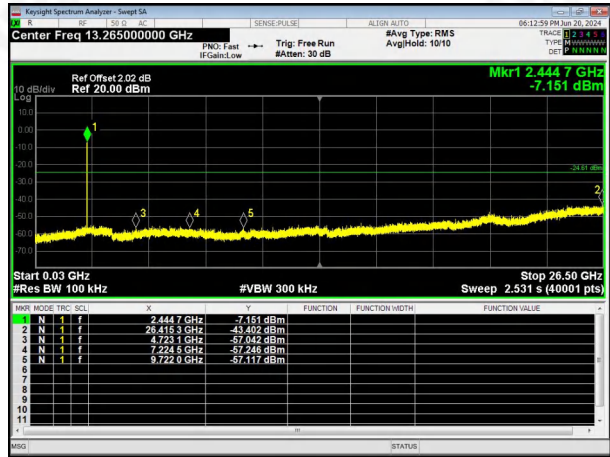
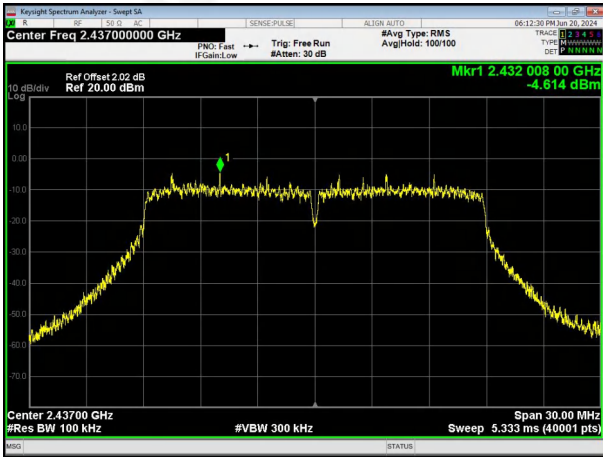

Highest channel

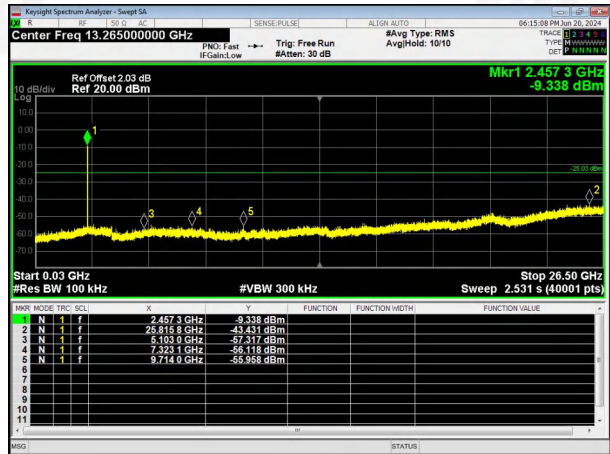
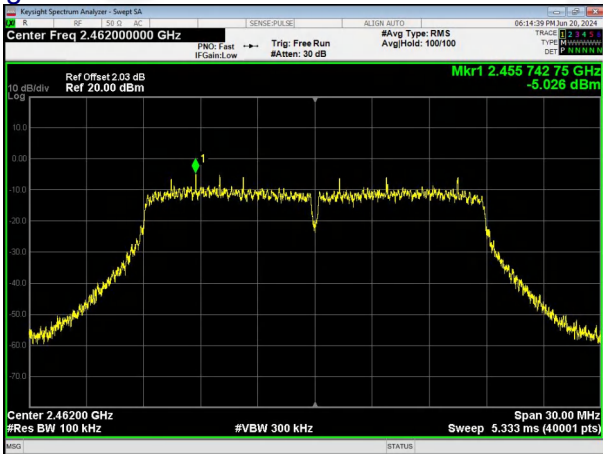



10. DUTY CYCLE

Test Method:	ANSI C63.10:2013
--------------	------------------

10.1 APPLIED PROCEDURES / LIMIT

Measurements of duty cycle and transmission duration shall be performed using one of the following techniques:

- a) A diode detector and an oscilloscope that together have a sufficiently short response time to permit accurate measurements of the ON and OFF times of the transmitted signal.
- b) The zero-span mode on a spectrum analyzer or EMI receiver if the response time and spacing between bins on the sweep are sufficient to permit accurate measurements of the ON and OFF times of the transmitted signal:
 - 1) Set the center frequency of the instrument to the center frequency of the transmission.
 - 2) Set $RBW \geq OBW$ if possible; otherwise, set RBW to the largest available value.
 - 3) Set $VBW \geq RBW$. Set detector = peak or average.
 - 4) The zero-span measurement method shall not be used unless both RBW and VBW are $> 50/T$ and the number of sweep points across duration T exceeds 100. (For example, if VBW and/or RBW are limited to 3 MHz, then the zero-span method of measuring the duty cycle shall not be used if $T \leq 16.7 \mu s$.)

10.2 DEVIATION FROM STANDARD

No deviation.

10.3 TEST SETUP





10.4 TEST RESULTS

Mode	Frequency (MHz)	Duty Cycle (%)
802.11b	2412	89.62
802.11g	2412	56.78
802.11n20	2412	55.51

802.11b

2412MHz

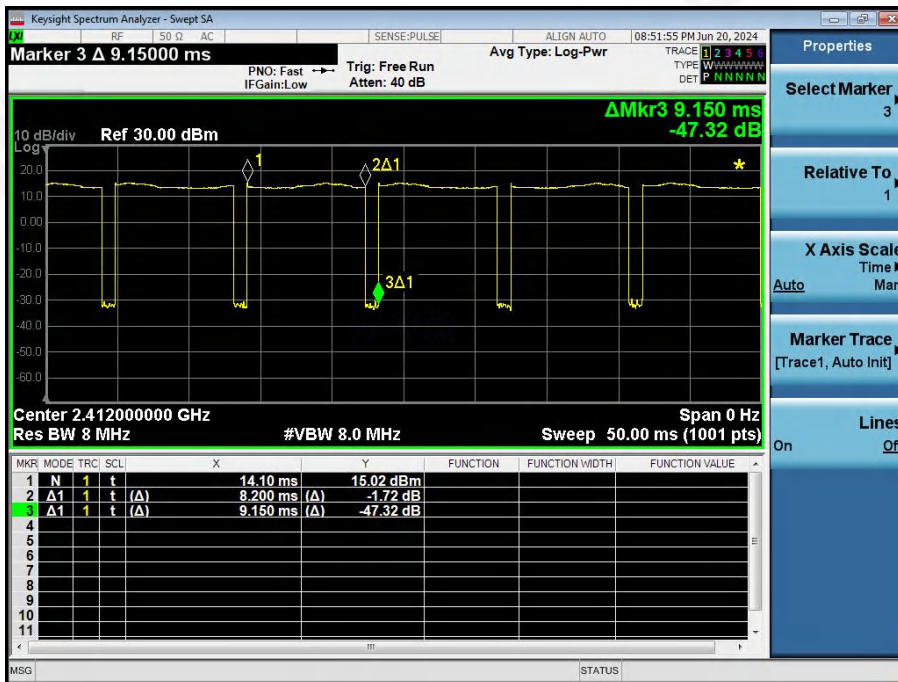

802.11g

2412MHz

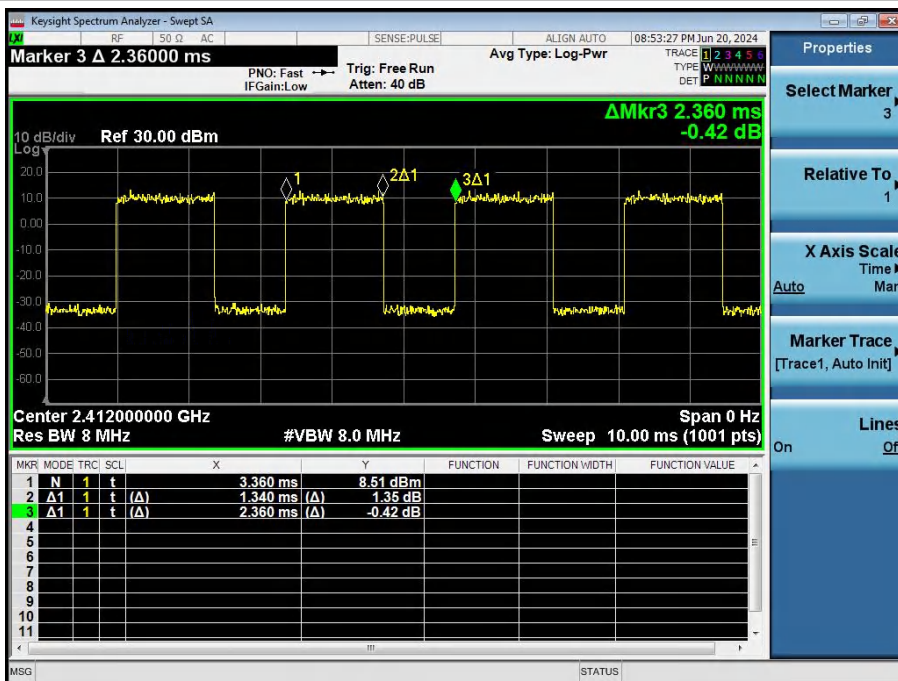



11. ANTENNA REQUIREMENT

Standard requirement:	FCC Part15 C Section 15.203 /247(c)
15.203 requirement: An intentional radiator shall be designed to ensure that no antenna other than that furnished by the responsible party shall be used with the device. The use of a permanently attached antenna or of an antenna that uses a unique coupling to the intentional radiator, the manufacturer may design the unit so that a broken antenna can be replaced by the user, but the use of a standard antenna jack or electrical connector is prohibited.	
15.247(c) (1)(i) requirement: (i) Systems operating in the 2400-2483.5 MHz band that is used exclusively for fixed. Point-to-point operations may employ transmitting antennas with directional gain greater than 6dBi provided the maximum conducted output power of the intentional radiator is reduced by 1 dB for every 3 dB that the directional gain of the antenna exceeds 6dBi.	
EUT Antenna:	
The antenna is Inside Antenna , the best case gain of the antenna is 3.82 dBi, reference to the appendix II for details	



12. TEST SETUP PHOTO

Reference to the appendix I for details.

13. EUT CONSTRUCTIONAL DETAILS

Reference to the appendix II for details.

***** END OF REPORT *****