

OTA TEST REPORT

Applicant Shenzhen General Test System Co., Ltd
Product RayZone1800
Issue Date 2025-07-03

Shenzhen Fu Bang Wireless Technology Co., Ltd. tested the above equipment in accordance with the requirements in **ANTI/IEEE Std 149-2008**. The test results show that the equipment tested is capable of demonstrating compliance with the Requirements as documented in this report.

Prepared by: Lunkang Yan

Approved by: Guoqing Gu

Shenzhen Fu Bang Wireless Technology Co., Ltd.

Room 302, lianjian Industry Part, Huarong road, Longhua District, Shenzhen, P.R. China

1. Test Laboratory

1.1 Notes of the Test report

This report shall not be reproduced in full or partial. The results documented in this report apply only to the tested sample, under the conditions and modes of operation as described herein. Measurement Uncertainties were not taken into account and are published for informational purposes only. This report is written to support regulatory compliance of applicable standards stated above.

1.2 Test facility

GTS1800 Microwave Anechoic Chamber : testing frequency ranges from 600MHz to 6GHz .

1.3 Testing Location

Company: Shenzhen Fu Bang Wireless Technology Co., Ltd

Address: Room 302, Lianjian Industry Part, Huarong road, Longhua District,
Shenzhen, P.R. China

Contact: lunkang Yan

Telephone: 13760182610

E-mail: 646363118@qq.com

1.4 Laboratory Environment

Temperature	Min.= 19°C, Max.=25°C	
Relative humidity	Min.=40%, Max.=72%	
Shield effect	0.6-7GHz	>100dB
Ground resistance	<0.5 Ω	

2. General Description of Equipment under Test

2.1 Applicant and Manufacturer information

Applicant Name	Shenzhen General Test System Co., Ltd
Applicant address	Building C-A7 Suite 805,2190 Liuxian Avenue, Nanshan District, Shenzhen, P.R. China
Manufacturer Name	Shenzhen General Test System Co., Ltd
Manufacturer address	Building C-A7 Suite 805,2190 Liuxian Avenue, Nanshan District, Shenzhen, P.R. China

2.2 General information

EUT Description	
Product Name	RayZone1800
Model	GTS-ANT D-H
HW Version	RayZone1800 V1.0
SW Version	MaxSign 100
Antenna Type	PCB Antenna
Antenna Manufacturer	Shenzhen General Test System Co., Ltd
Test Frequency	600MHz-6GHz

2.3 Applied Standards

According to the specifications of the manufacturer, it must comply with the requirements of the following standards:

Test Method: **ANSI/IEEE Std 149-2008**

3. Test Conditions

3.1 Test Configuration

The method is used to measure the antenna 3D GAIN of EUT in OTA qualified anechoic chamber. Equipment Under Test (EUT) geometry centre vertical projection at the centre of platform, the distance from EUT to measurement antenna is 1m.

3.2 Test Measurement

Spherical coordinate system

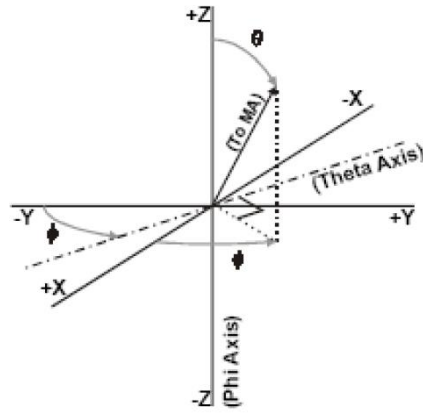
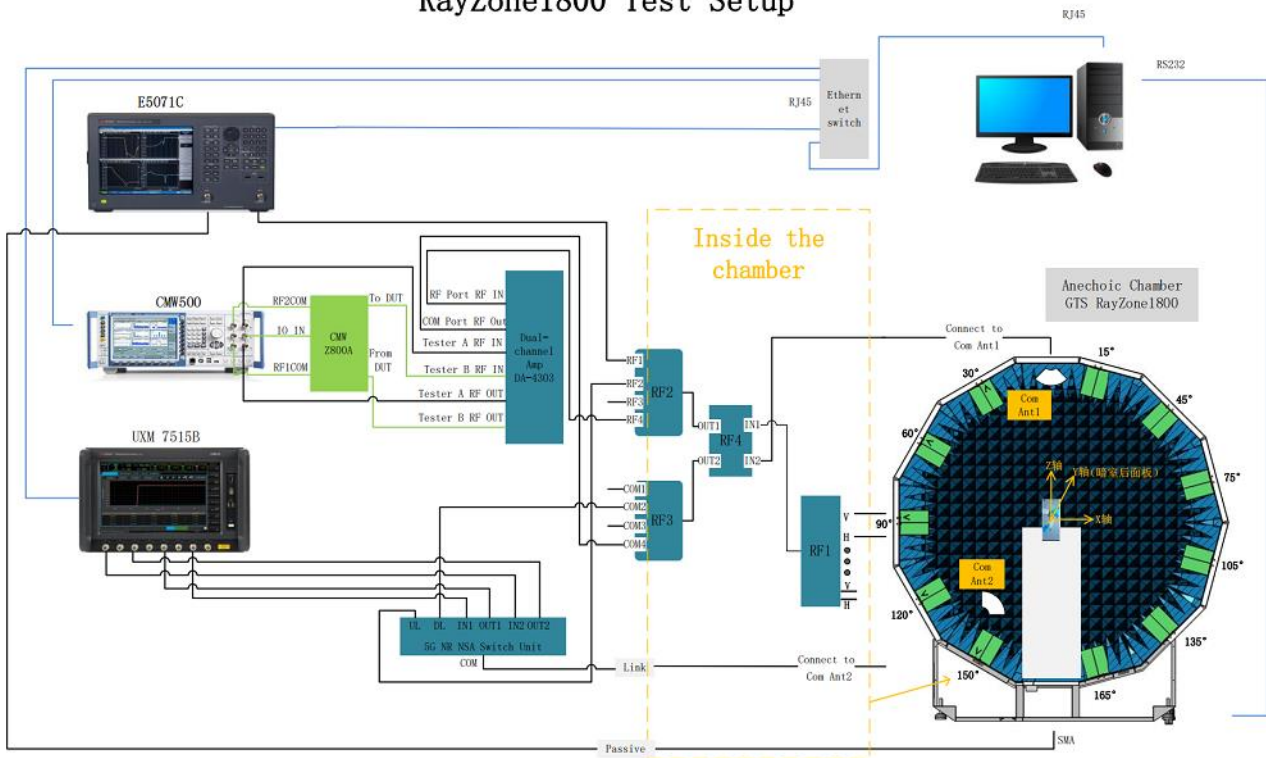

Figure 1 Test coordinate system

Note: Theta is from 0-180degree. Phi is from EUT and record the Date, the step of rotation is 15 degree.

Test Setup

RayZone1800 Test Setup



4. Test Results

4.1 Gain and Efficiency



OTA Test Report

Model	Test State	Frequency (MHz)	Efficiency (%)	Gain (dBi)	Frequency (MHz)	Efficiency (%)	Gain (dBi)	Note
	Free Space	700	18.5	-0.2	1900	42.7	-0.1	
		710	19.3	-0.1	1920	42.1	0.5	
		720	19.8	-0.1	1940	40.7	0.3	
		730	19.6	-0.1	1960	39.6	0.1	
		740	19.8	0.1	1980	39.3	0.5	
		750	19.8	0.1	2000	38.8	0.5	
		760	19.5	-0.1	2020	38.6	0.6	
		770	18.2	-0.2	2040	36.8	0.4	
		780	17.8	-0.3	2060	35.7	0.5	
		790	17.6	-0.3	2080	33.6	0.2	
		800	17.0	-0.3	2100	32.7	0.1	
		810	16.4	-0.4	2120	32.5	0.1	
		820	19.3	-0.1	2140	31.0	0.2	
		830	19.4	-0.1	2160	31.8	0.7	
		840	20.2	0.1	2180	33.0	0.7	
		850	21.5	0.2	2200	31.2	0.6	
		860	22.7	0.2	2500	31.0	0.5	
		870	20.8	0.2	2520	33.4	1.0	
		880	22.9	-0.2	2540	36.1	1.3	
		890	23.8	-0.1	2560	39.0	1.6	
		900	24.7	-0.1	2580	40.1	1.5	
		910	25.1	-1.1	2600	41.5	1.4	
		920	29.0	-0.4	2620	45.2	1.4	
		930	31.2	-0.2	2640	47.9	1.8	
		940	30.9	-0.6	2660	48.7	1.5	
		950	28.4	-0.8	2680	47.1	1.2	
		960	25.1	-1.1	2700	44.5	1.2	
		1700	33.9	1.5				
		1720	36.7	2.0				
		1740	40.7	2.2				
		1760	43.1	2.0				
		1780	41.3	1.3				
		1800	41.3	1.1				
	1820	42.1	0.7					
	1840	44.6	0.7					
	1860	44.6	0.1					
	1880	42.9	-0.3					

Model	Test State	Frequency (MHz)	Efficiency (%)	Gain (dBi)	Frequency (MHz)	Efficiency (%)	Gain (dBi)	Note
	Free Space	1520	31.3	0.8	5260	36.1	1.8	
		1530	33.3	1.0	5280	34.3	1.7	
		1540	34.3	1.1	5300	32.6	1.5	
		1550	32.4	1.0	5320	33.0	1.5	
		1560	32.3	1.0	5340	31.0	1.4	
		1570	31.9	1.0	5360	29.7	1.3	
		1580	31.7	0.9	5380	30.2	1.4	
		1590	31.3	0.8	5400	31.0	1.4	
		1600	30.3	0.7	5420	30.6	1.4	
		2400	35.1	1.4	5440	30.4	1.4	
		2410	36.6	1.5	5460	29.7	1.3	
		2420	36.8	1.5	5480	29.6	1.3	
		2430	37.2	1.6	5500	28.8	1.2	
		2440	37.5	1.6	5520	28.6	1.2	
		2450	37.3	1.6	5540	28.1	1.2	
		2460	37.1	1.6	5560	29.5	1.3	
		2470	36.7	1.5	5580	28.5	1.2	
		2480	36.2	1.5	5600	27.3	1.1	
		2490	35.6	1.4	5620	27.3	1.1	
		2500	35.0	1.4	5640	25.5	1.0	
		5100	22.1	0.9	5660	25.9	1.0	
		5120	23.0	1.0	5680	24.9	0.9	
		5140	25.5	1.1	5700	24.7	0.9	
		5160	27.7	1.2	5720	24.1	0.8	
		5180	29.7	1.3	5740	23.2	0.7	
		5200	30.7	1.4	5760	22.3	0.6	
		5220	32.3	1.6	5780	22.0	0.6	
		5240	35.2	1.8	5800	22.3	0.6	

5. Equipment List

Type of Equipment	Manufacture	Model Number
Network Analyzer	Key sight	E5071C
Switch control System	GTS	RayZone1800
Software	GTS	MaxSign 100 Patten Measurement software

ANNEX A 3-D Patten Plots

Shenzhen Fu Bang Wireless Technology Co., Ltd.

This report shall not be reproduced except in full, without the written approval of Shenzhen Fu Bang Wireless Technology Co., Ltd.

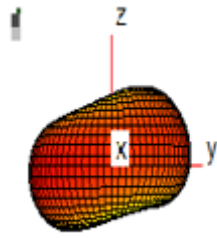

700MHz

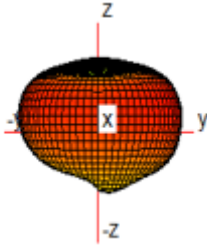

850MHz

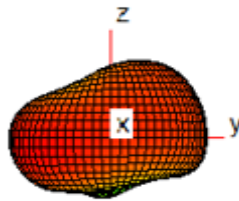

900MHz

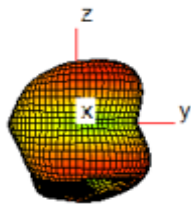

1800MHz



1900MHz

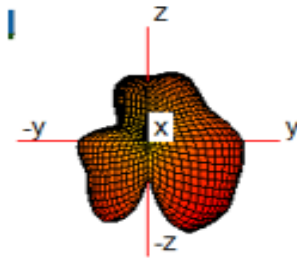

2100MHz

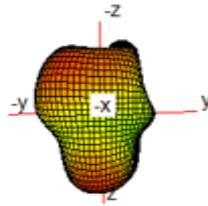

2700MHz

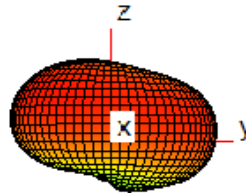

1575MHz

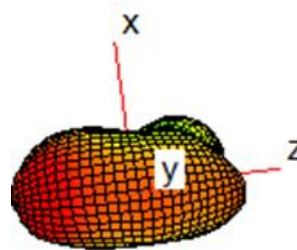

2400MHz

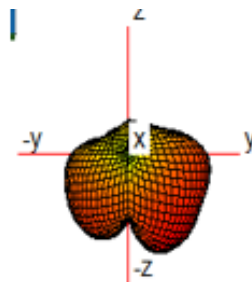

5100MHz

ANNEX B: The EUT Appearance and Test Configuration

B.1 EUT Appearance

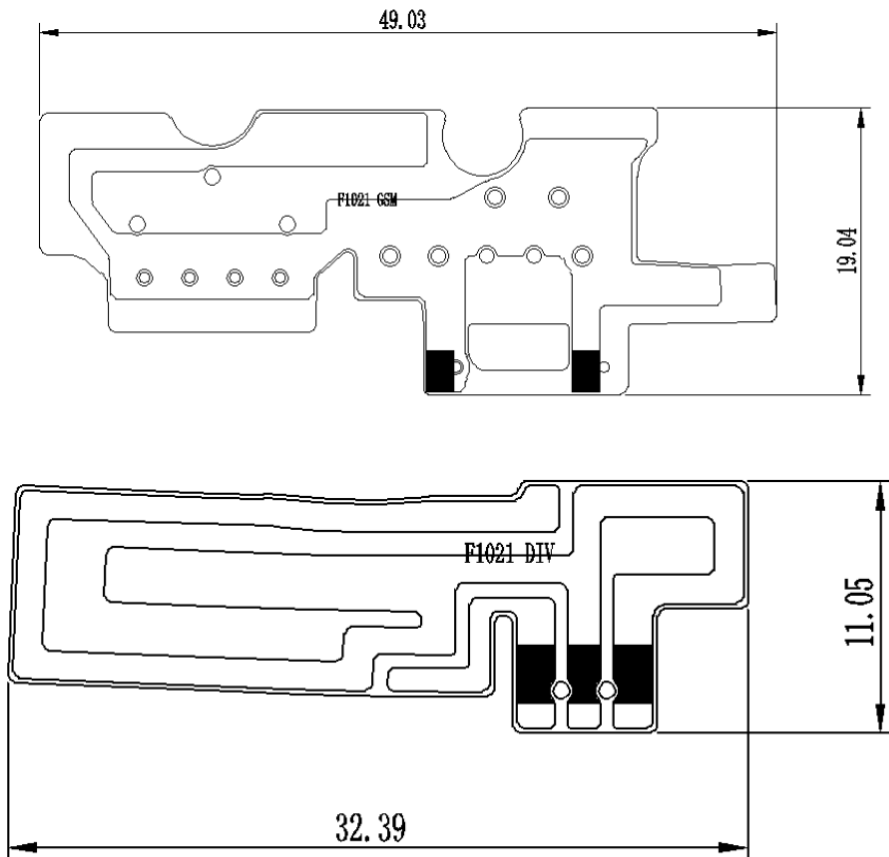

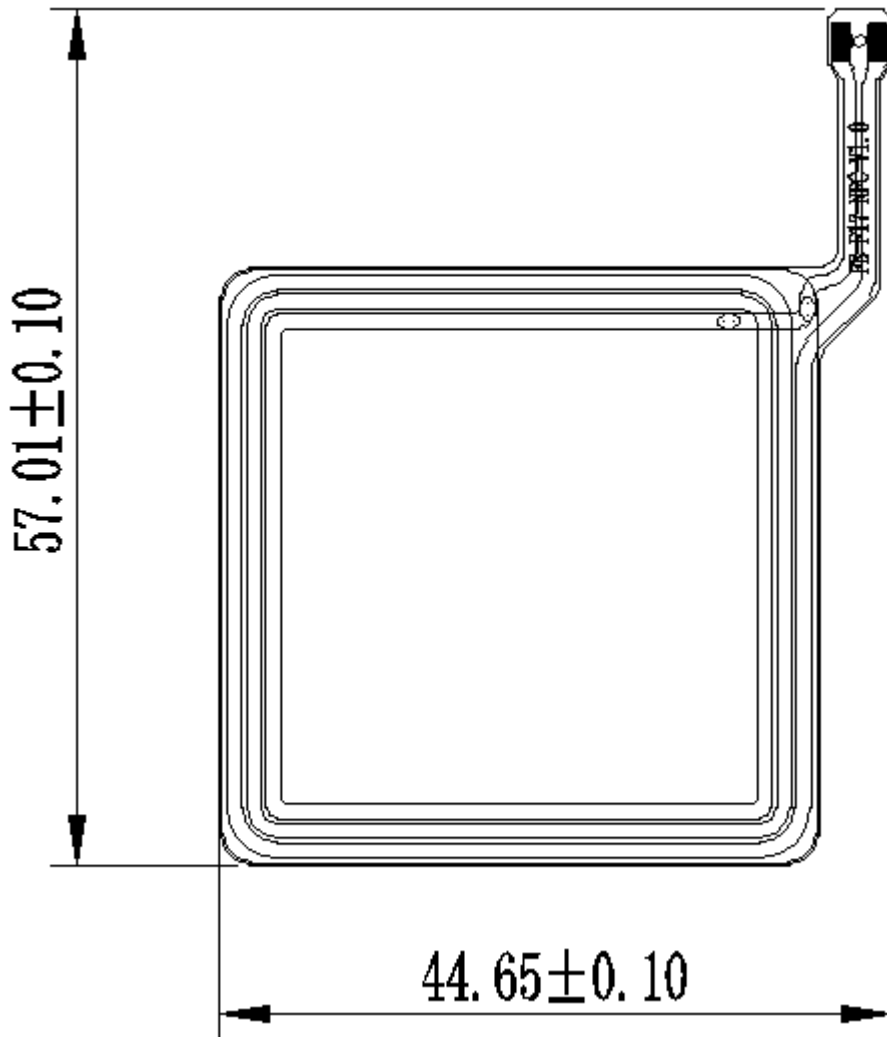
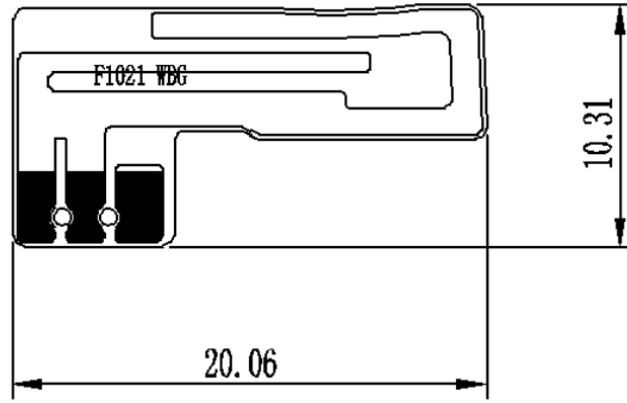

F1021天线逻辑	
RF1	GSM900的RX/1800/1900+W1/2/4+LTE-B1/2/3/4/7/8/25/38/40/41/66
RF2	GSM850+W5+LTE-B5/19/20/18/26
RF3	LTE-B12/17/28AB
RF4	W8+GSM900的TX

B.2 Test Configuration

