

Multilayer Chip Antenna

Features

- ❖ Monolithic SMD with small, low-profile and light-weight type.
- ❖ Wide bandwidth
- ❖ RoHS compliant

Applications

- ❖ 2400~2500MHz ISM Band Systems
- Antenna Type: Chip Antenna



Specifications

Part Number	Frequency Range (MHz)	Peak Gain (dBi typ.)	Average Gain (dBi typ.)	VSWR	Impedance
AN1608-2440	2400~2480	0.5 (XZ-total)	-2.0 (XZ-total)	3 max.	50 Ω

(*Electrical specification is defined by the measurement of Scenario#1)

- Q'ty/Reel (pcs) : 4,000 pcs
- Operating Temperature Range : -40 ~ +85 °C
- Storage Temperature Range : -40 ~ +85 °C
- Storage Period : 12 months max.
- Power Capacity : 2W max.

Terminal Configuration

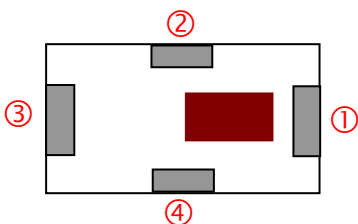

Scenario#1: Antenna on the edge side of PCBA			
No.	Terminal Name	No.	Terminal Name
①	Feeding Point	③	NC
②	GND	④	GND

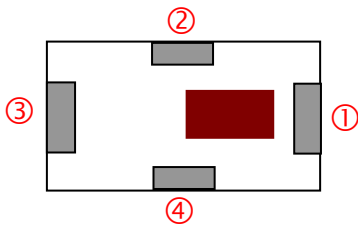

Scenario#2: Antenna on the corner of PCBA			
No.	Terminal Name	No.	Terminal Name
①	Feeding Point	③	NC
②	NC	④	NC

Dimensions and Recommended PC Board Pattern

Unit : mm

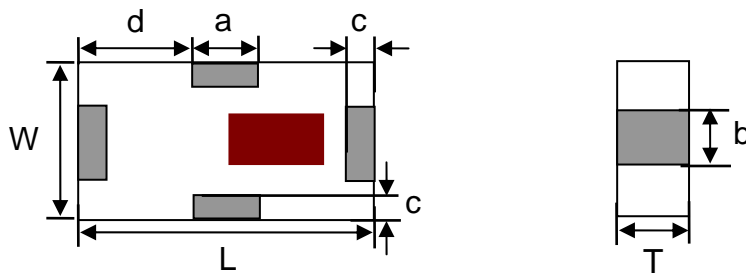

Mark	L	W	T	a	b	c	d
Dimensions	1.6 ± 0.1	0.8 ± 0.1	0.4 ± 0.1	0.5 ± 0.1	0.5 ± 0.1	0.2 ± 0.05	0.55 ± 0.1

Typical Electrical Characteristics for Scenario#1 (T=25°C)

❖ Test Board-Scenario#1

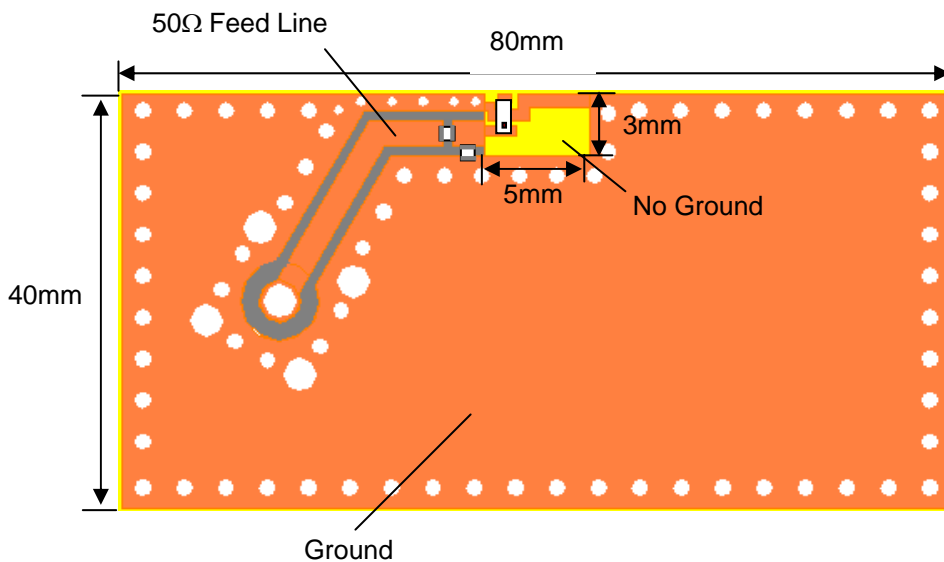

❖ Antenna Footprint With matching- Scenario#1 (Unit in mm)

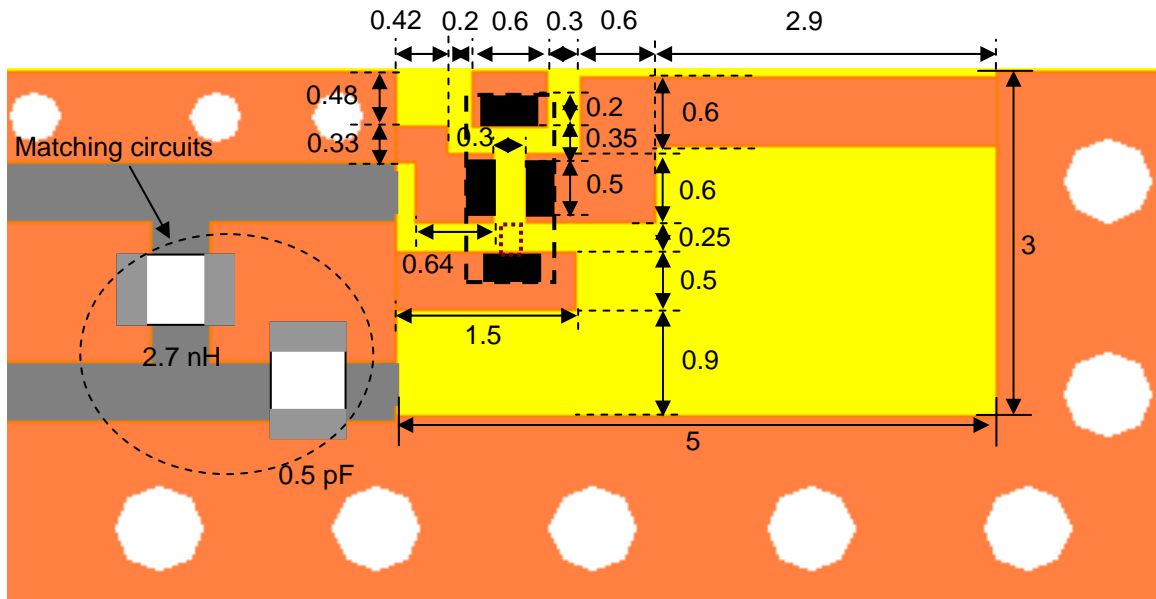

(Matching circuit and component values will be different, depending on PCB layout)

*Line width should be designed to match 50Ω characteristic impedance, depending on PCB material and thickness.

❖ Return Loss (with matching)- Scenario#1

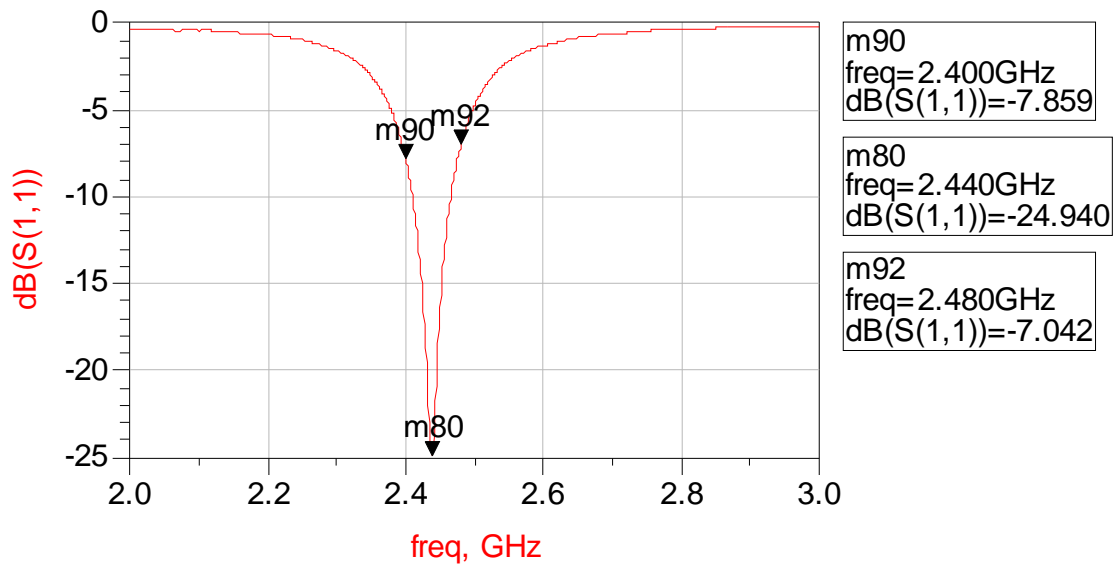

❖ Radiation Patterns- Scenario#1 (Antenna Efficiency: 50 %)

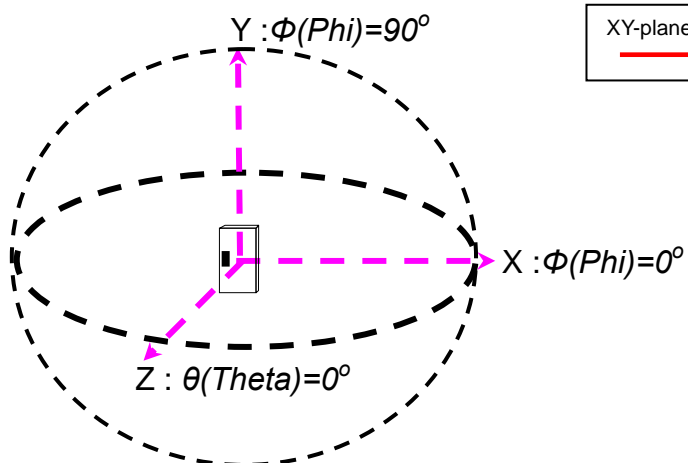

XY-plane @2440MHz
— Total

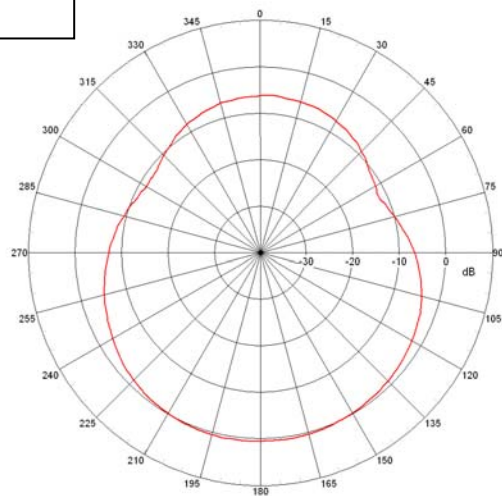

XZ-plane @2440MHz
— Total

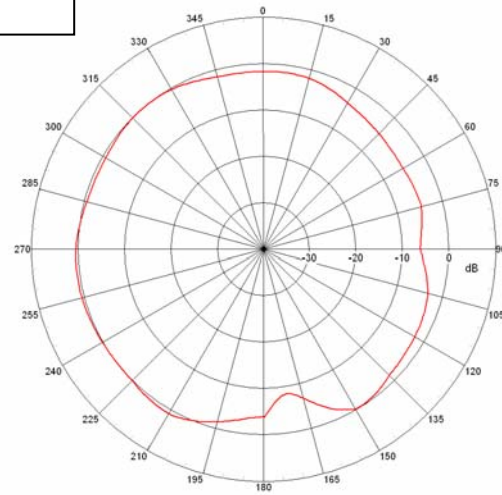

YZ-plane @2440MHz
— Total

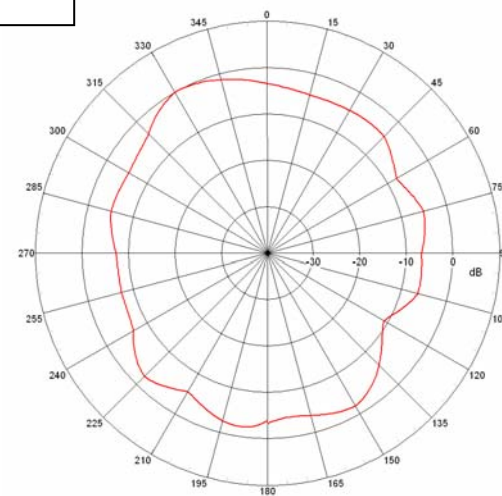

Typical Electrical Characteristics for Scenario#2 (T=25°C)

❖ Test Board- Scenario#2

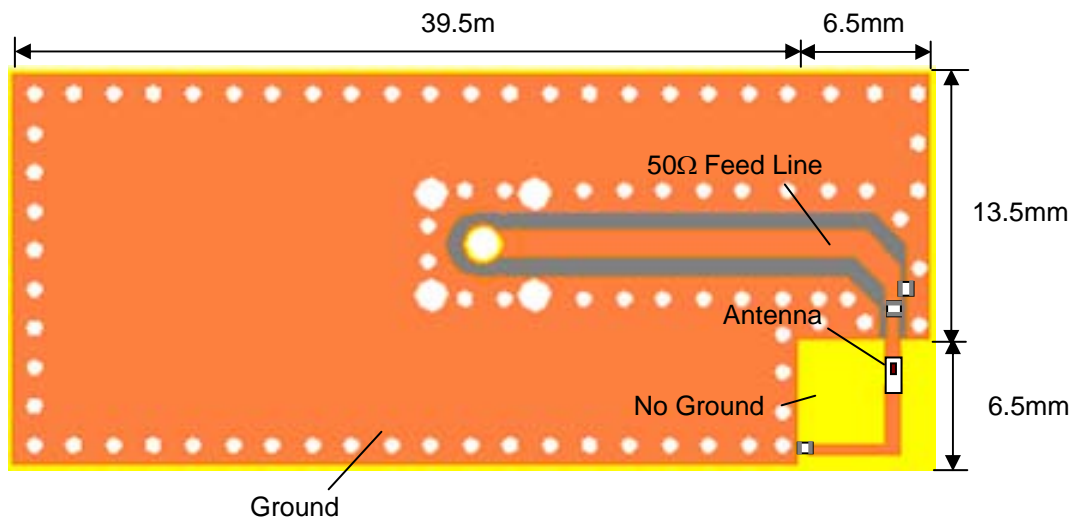

❖ Antenna Footprint With matching- Scenario#2

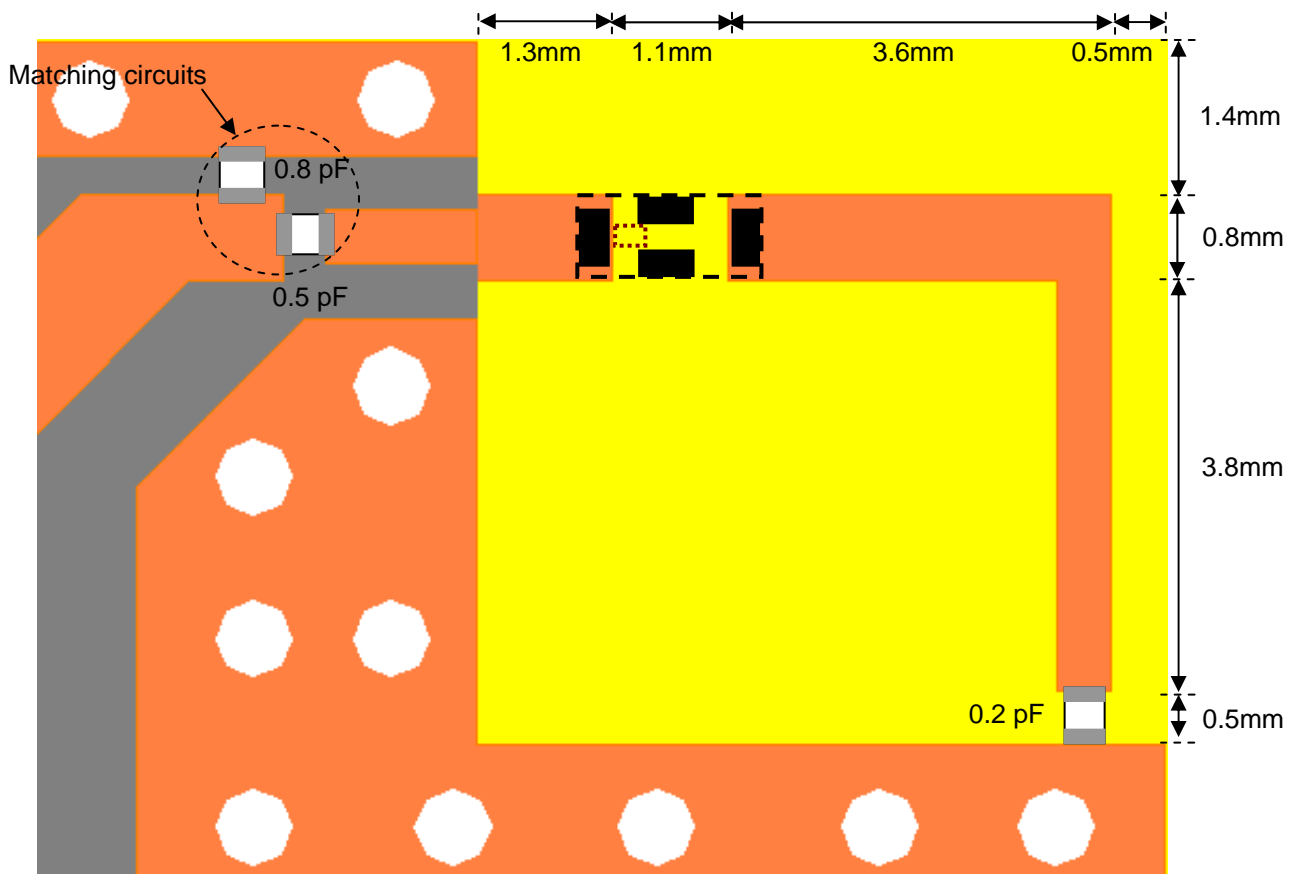

(Matching circuit and component values will be different, depending on PCB layout)

*Line width should be designed to match 50Ω characteristic impedance, depending on PCB material and thickness.

❖ Return Loss (with matching)- Scenario#2

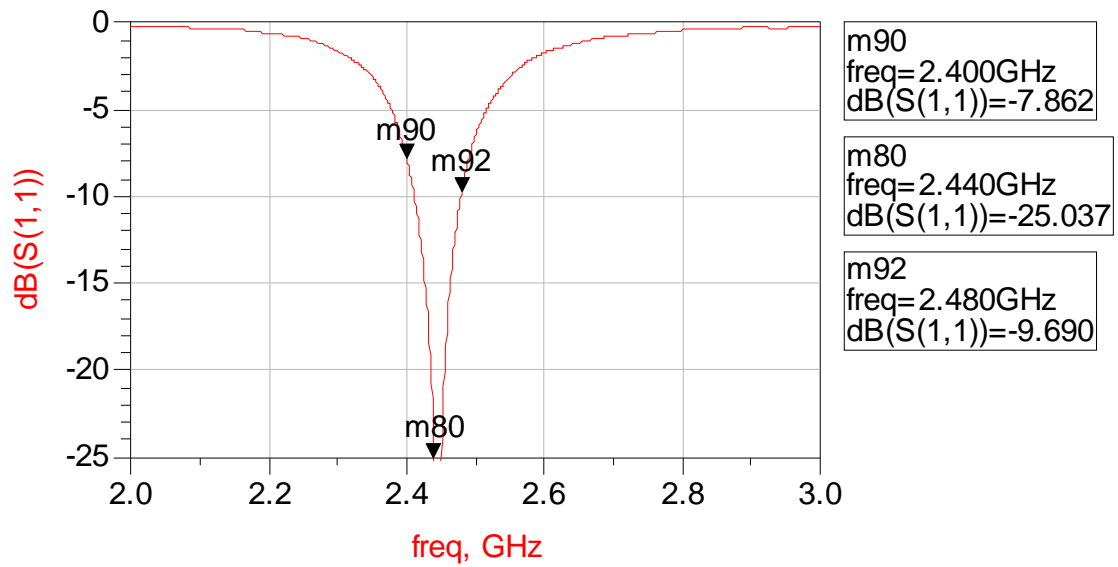

❖ Radiation Patterns- Scenario#2 (Antenna Efficiency: 64 %)

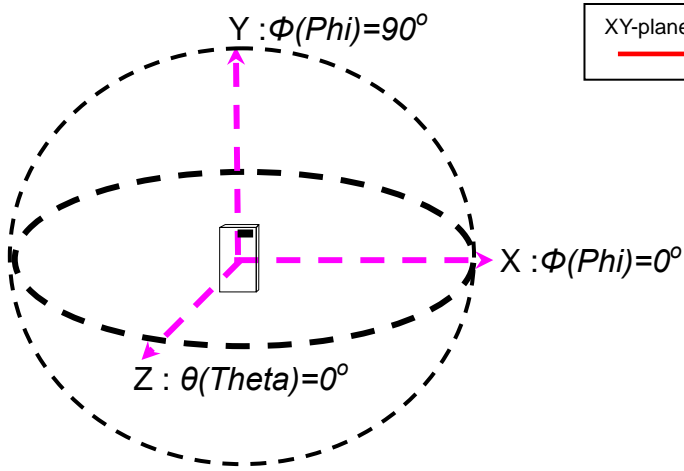

XY-plane @2440MHz
 — Total

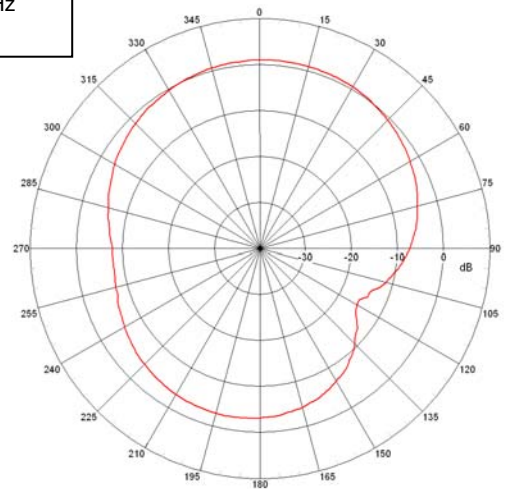

XZ-plane @2440MHz
 — Total

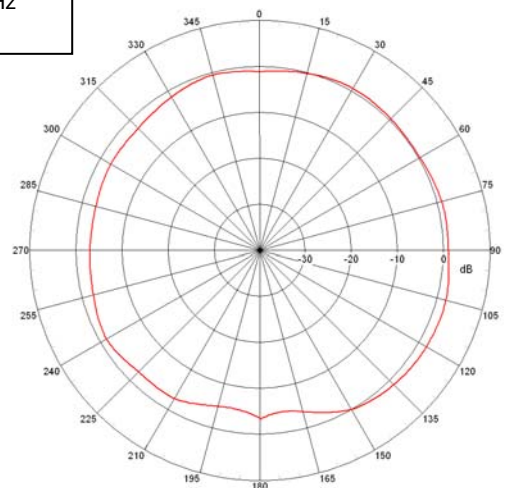

YZ-plane @2440MHz
— Total

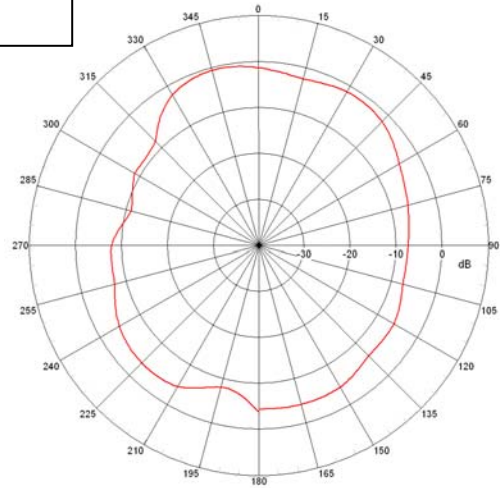

Taping Specifications

❖Tape & Reel Dimensions (Unit: mm) vs. Quantity (pcs)

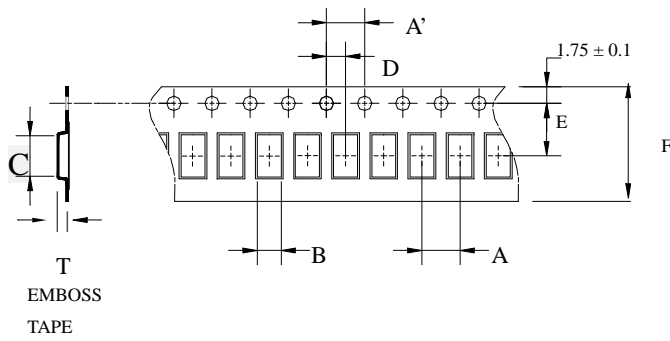

Type	A	A'	B	C	D	E	F	T	Quantity/per reel	Tape material	Material No.
	4.0±0.1	4.0±0.1	2.4±0.1	7.3±0.1	2.0±0.05	5.5±0.1	12.0±0.1	1.45±0.1	1,000pcs	Plastic (Embossed)	1220104

❖Reel Dimensions (Unit: mm)

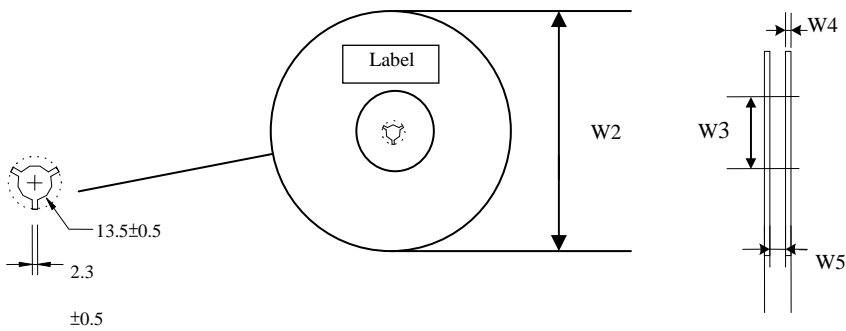

Label: Customer's Name,

Type	W2	W3	W4	W5	Material No.
	178±1	60±1	1.4±0.2	17±0.5	1220301

❖ Leader and Trailer Tape

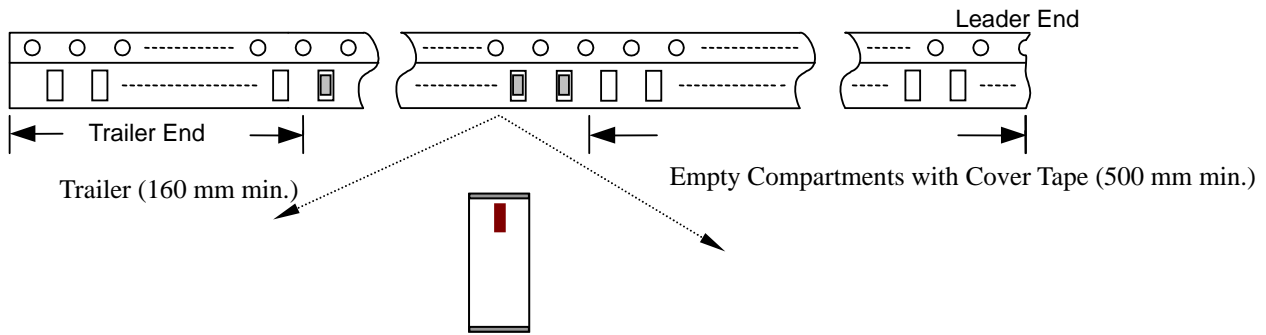

❖ Peel-off Force

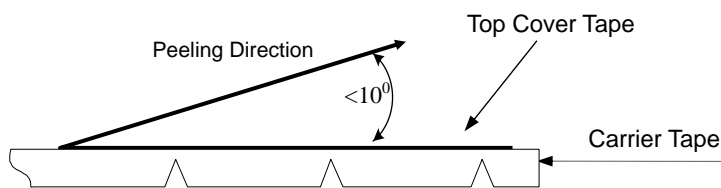

Peel-off force should be in the range of 0.1 – 0.6 N at a peel-off speed of 300 ± 10 mm/min .

❖ Storage Conditions

- (1) Temperature: $5 \sim 35^\circ\text{C}$, relative humidity (RH): 45~75%.
- (2) Non-corrosive environment

Notes

❖The contents of this data sheet are subject to change without notice. Please confirm the specifications and delivery conditions when placing your order.

Mechanical & Environmental Characteristics

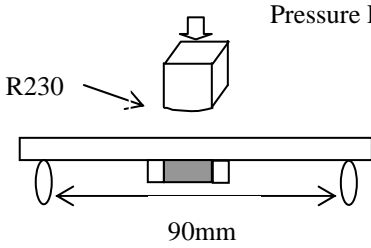
Item	Requirements	Procedure
Solderability	<ol style="list-style-type: none"> 1. No apparent damage 2. More than 95% of the terminal electrode shall be covered with new solder 	<ol style="list-style-type: none"> 1. Preheat: $120 \pm 5^\circ\text{C}$ 2. Solder: $245 \pm 5^\circ\text{C}$ for 5 ± 1 sec
Soldering strength (Termination Adhesion)	<ol style="list-style-type: none"> 1. 1kg minimum 	<ol style="list-style-type: none"> 1. Solder specimen onto test jig. 2. Apply push force at 0.5mm/s until electrode pads are peeled off or ceramic are broken. Pushing force is applied to longitude direction
Deflection (Substrate Bending)	<ol style="list-style-type: none"> 1. No apparent damage 	<ol style="list-style-type: none"> 1. Solder specimen onto test jig (FR4, 0.8mm) using the recommend soldering profile. 2. Apply a bending force of 1mm deflection 
Heat/Humidity Resistance	<ol style="list-style-type: none"> 1. No apparent damage 2. Fulfill the electrical specification after test 	<ol style="list-style-type: none"> 1. Temperature: $85 \pm 2^\circ\text{C}$ 2. Humidity: 90% ~ 95% RH 3. Duration: 1000 ± 48hrs 4. Recovery: 1-2hrs
Thermal shock (Temperature Cycle)	<ol style="list-style-type: none"> 1. No apparent damage 2. Fulfill the electrical specification after test 	<ol style="list-style-type: none"> 1. One cycle/step 1 : $125 \pm 5^\circ\text{C}$ for 30 min step 2 : $-40 \pm 5^\circ\text{C}$ for 30 min 2. No of cycles : 100 3. Recovery: 1-2 hrs
Low Temperature Resistance	<ol style="list-style-type: none"> 1. No apparent damage 2. Fulfill the electrical specification after test 	<ol style="list-style-type: none"> 1. Temperature: $-40 \pm 5^\circ\text{C}$ 2. Duration: 500 ± 24hrs 3. Recovery: 1-2hrs

Soldering Conditions

❖ Typical Soldering Profile for Lead-free Process

Reflow Soldering :

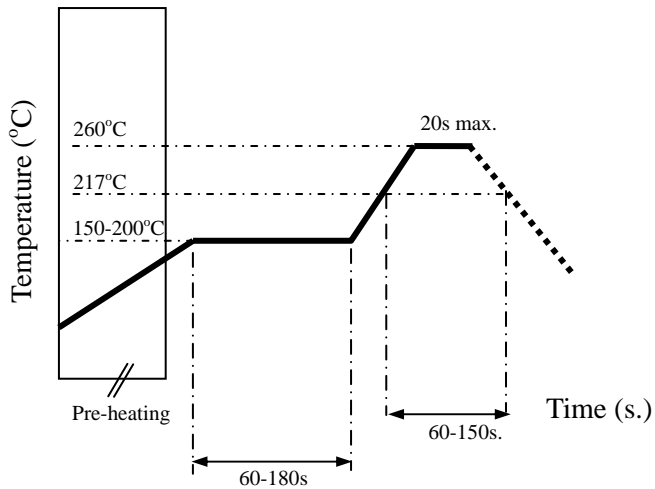

Notes

❖ The contents of this data sheet are subject to change without notice. Please confirm the specifications and delivery conditions when placing your order.

Manufacturer:

Advanced Ceramic X Corp.

16 Tzu Chiang Road, Hsinchu Industrial District Hsinchu Hsien 303, Taiwan

TEL:886-3-5987008 FAX:886-3-5987001

E-mail: acx@acxc.com.tw

<http://www.acxc.com.tw>