

TEST REPORT

Report No.: BCTC2310178307-4E

Applicant: NINGBO AUDITORYWORKS CO., LTD.

Product Name: NearHub Rooms

Model/Type
reference: AW-NR10

Tested Date: 2023-10-11 to 2023-11-01

Issued Date: 2023-11-03

Shenzhen BCTC Testing Co., Ltd.



FCC ID: 2BAHR-NR10

Product Name: NearHub Rooms
Trademark: N/A
Model/Type Reference: AW-NR10
AW-NR***** (“*” can be 0-9, A-Z, a-z or blank, indicate different enclosure color, performance, sales area or customer)
Prepared For: NINGBO AUDITORYWORKS CO., LTD.
Address: 3-314 Lingqiao Road 229, Haishu District, Ningbo City, Zhejiang Province, China
Manufacturer: NINGBO AUDITORYWORKS CO., LTD.
Address: 3-314 Lingqiao Road 229, Haishu District, Ningbo City, Zhejiang Province, China
Prepared By: Shenzhen BCTC Testing Co., Ltd.
Address: 1-2/F., Building B, Pengzhou Industrial Park, No.158, Fuyuan 1st Road, Zhancheng, Fuhai Subdistrict, Bao'an District, Shenzhen, Guangdong, China
Sample Received Date: 2023-10-11
Sample tested Date: 2023-10-11 to 2023-11-01
Issue Date: 2023-11-03
Report No.: BCTC2310178307-4E
FCC Part15 15.407
Test Standards: ANSI C63.10-2013
KDB 662911 D01 v02r01
KDB 789033 D02 v02r01
Test Results: PASS

Tested by:



Lei Chen/Project Handler

Approved by:



Zero Zhou/Reviewer

The test report is effective only with both signature and specialized stamp. This result(s) shown in this report refer only to the sample(s) tested. Without written approval of Shenzhen BCTC Testing Co., Ltd, this report can't be reproduced except in full. The tested sample(s) and the sample information are provided by the client.

Table Of Content

Test Report Declaration	Page
1. Version	5
2. Test Summary	6
3. Measurement Uncertainty	7
4. Product Information And Test Setup	8
4.1 Product Information.....	8
4.2 Test Setup Configuration	9
4.3 Support Equipment	9
4.4 Channel List	10
4.5 Test Mode	11
4.6 Table Of Parameters Of Text Software Setting.....	11
4.7 Antenna.....	11
5. Test Facility And Test Instrument Used.....	13
5.1 Test Facility.....	13
5.2 Test Instrument Used.....	13
6. Conducted Emissions.....	15
6.1 Block Diagram Of Test Setup.....	15
6.2 Limit	15
6.3 Test Procedure	15
6.4 EUT Operating Conditions	15
6.5 Test Result.....	16
7. Radiated Emissions.....	20
7.1 Block Diagram Of Test Setup.....	20
7.2 Limit	21
7.3 Test Procedure	22
7.4 EUT Operating Conditions	23
7.5 Test Result.....	23
8. Power Spectral Density Test	64
8.1 Block Diagram Of Test Setup.....	64
8.2 Limit	64
8.3 Test Procedure	65
8.4 EUT Operating Conditions	65
8.5 Test Result.....	66
9. 26dB & 6dB & 99% Emission Bandwidth	112
9.1 Block Diagram Of Test Setup.....	112
9.2 Limit	112
9.3 Test Procedure	112
9.4 EUT Operating Conditions	113
9.5 Test Result.....	114
10. Maximum Conducted Output Power.....	206
10.1 Block Diagram Of Test Setup.....	206
10.2 Limit	206
10.3 Test Procedure	206
10.4 EUT Operating Conditions	207

10.5	Test Result.....	208
11.	Out Of Band Emissions	212
11.1	Block Diagram Of Test Setup.....	212
11.2	Limit	212
11.3	Test Procedure	212
11.4	EUT Operating Conditions	212
11.5	Test Result.....	213
12.	Spurious RF Conducted Emissions.....	248
12.1	Block Diagram Of Test Setup.....	248
12.2	Limit	248
12.3	Test Procedure	248
12.4	Test Result.....	248
13.	Frequency Stability Measurement	291
13.1	Block Diagram Of Test Setup.....	291
13.2	Limit	291
13.3	Test Procedure	291
13.4	Test Result.....	292
14.	Duty Cycle Of Test Signal	304
14.1	Standard Requirement	304
14.2	Formula.....	304
14.3	Test Procedure	304
14.4	Test Result.....	304
15.	Antenna Requirement	396
15.1	Limit	396
15.2	Test Result.....	396
16.	EUT Photographs.....	397
17.	EUT Test Setup Photographs.....	398

(Note: N/A Means Not Applicable)

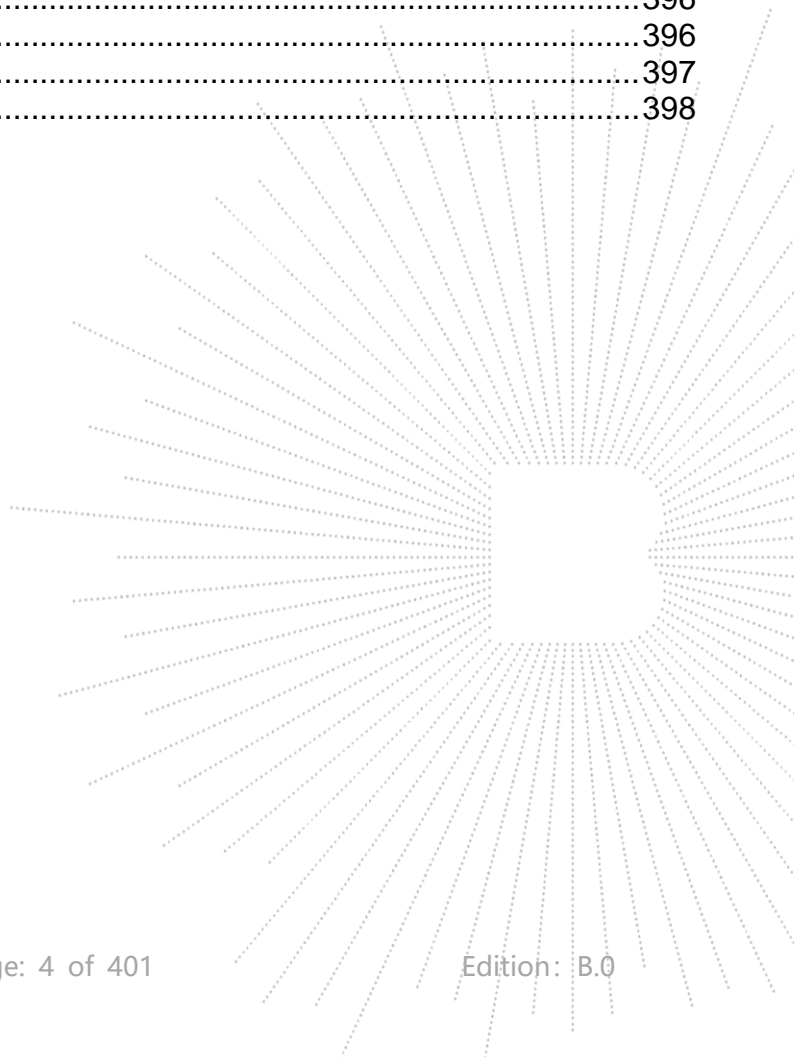

1. Version

Report No.	Issue Date	Description	Approved
BCTC2310178307-4E	2023-11-03	Original	Valid

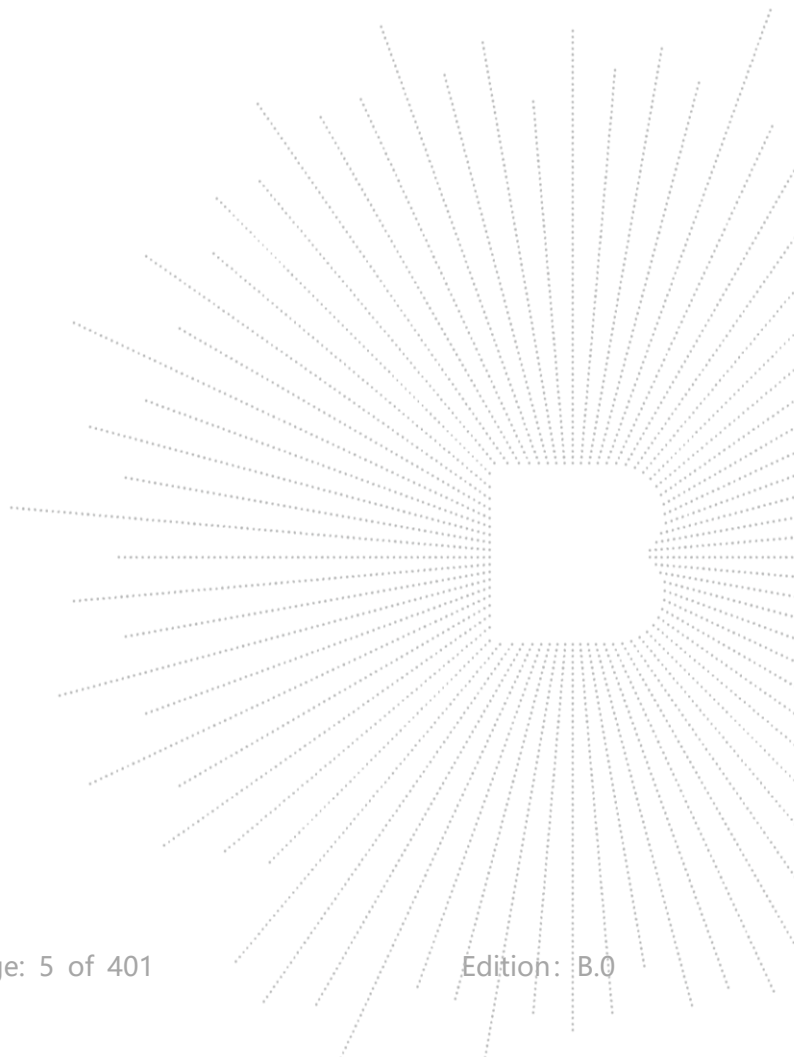

2. Test Summary

The Product has been tested according to the following specifications:

No.	Test Parameter	Clause No.	Results
1	Spurious Radiated Emissions	15.209(a) 15.407 (b)	PASS
2	Conducted Emission	15.207	PASS
3	26 dB and 99% Emission Bandwidth	15.407 a 15.1049	PASS
4	Minimum 6 dB bandwidth	15.407(e)	PASS
5	Maximum Conducted Output Power	15.407 a	PASS
6	Band Edge	2.1051, 15.407 b	PASS
7	Power Spectral Density	15.407 a	PASS
8	Spurious Emissions at Antenna Terminals	2.1051, 15.407 b	PASS
9	Antenna Requirement	15.203	PASS

Note: The device shall automatically discontinue transmission in case of either absence of information to transmit or operational failure.

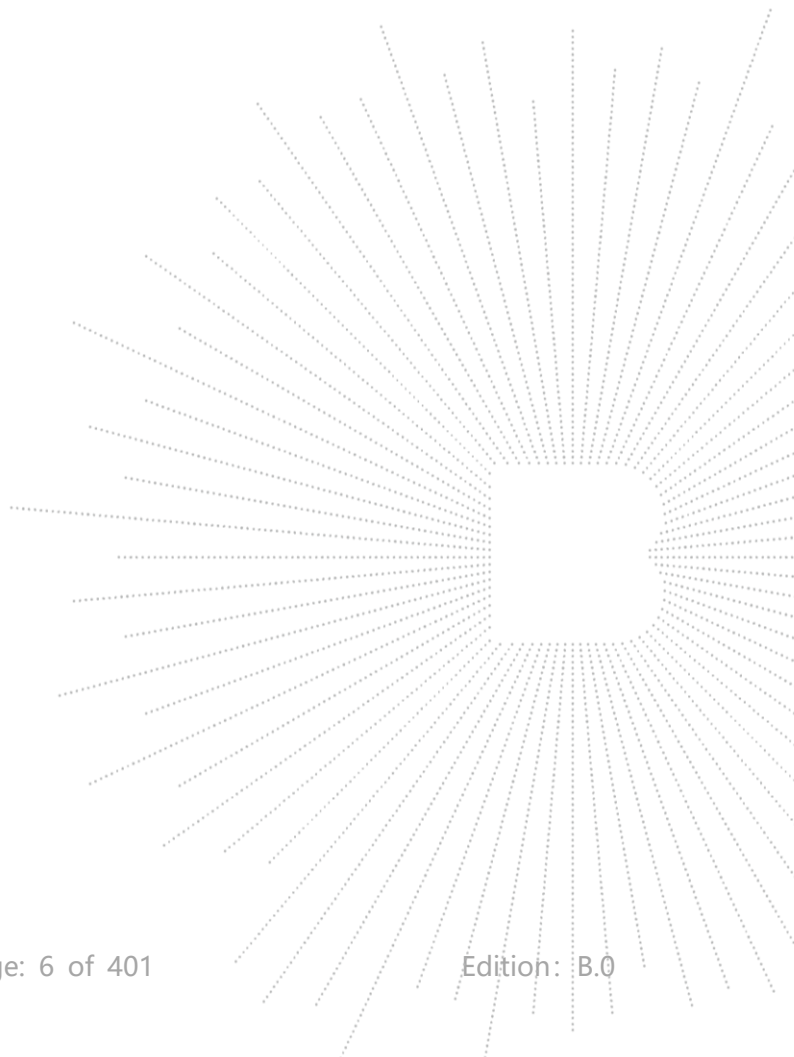

3. Measurement Uncertainty

Where relevant, the following measurement uncertainty levels have been estimated for tests performed on the Product as specified in CISPR 16-4-2. This uncertainty represents an expanded uncertainty expressed at approximately the 95% confidence level using a coverage factor of $k=2$.

No.	Item	Uncertainty
1	3m chamber Radiated spurious emission(9kHz-30MHz)	U=3.7dB
2	3m chamber Radiated spurious emission(30MHz-1GHz)	U=4.3dB
3	3m chamber Radiated spurious emission(1GHz-18GHz)	U=4.5dB
4	3m chamber Radiated spurious emission(18GHz-40GHz)	U=3.34dB
5	Conducted Emission(150kHz-30MHz)	U=3.20dB
6	Conducted Adjacent channel power	U=1.38dB
7	Conducted output power uncertainty Above 1G	U=1.576dB
8	Conducted output power uncertainty below 1G	U=1.28dB
9	humidity uncertainty	U=5.3%
10	Temperature uncertainty	U=0.59°C

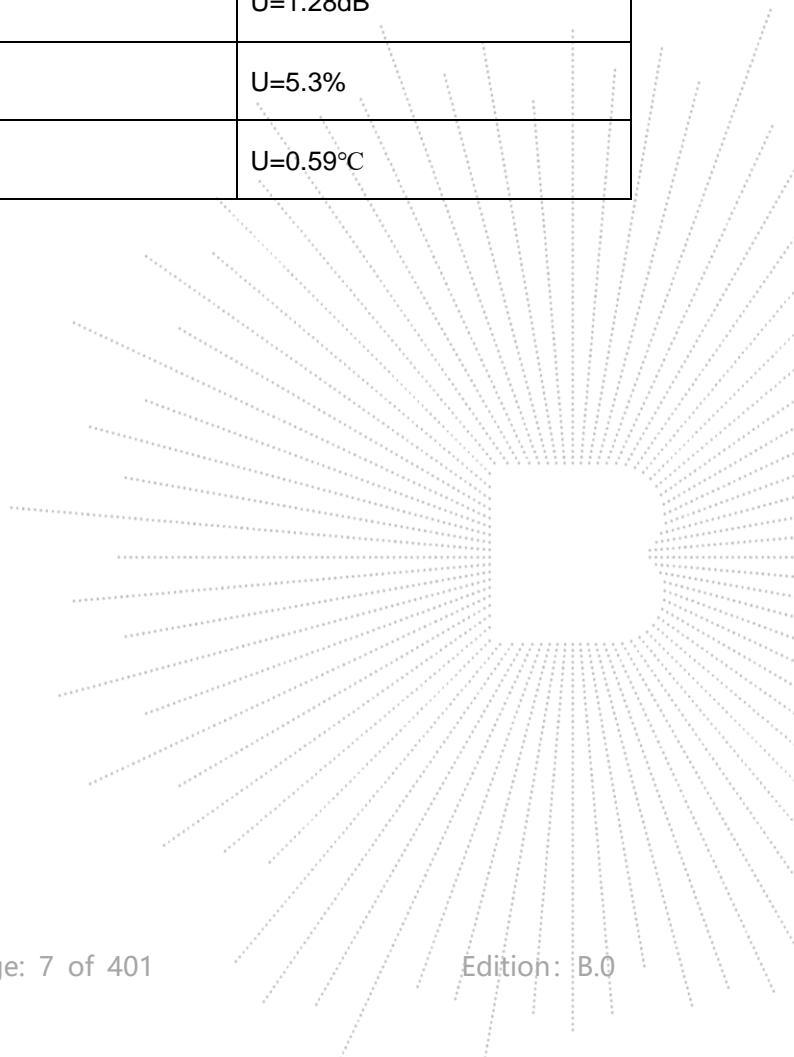

4. Product Information And Test Setup

4.1 Product Information

Model/Type Ref.:	AW-NR10 AW-NR**** (“*” can be 0-9, A-Z, a-z or blank, indicate different enclosure color, performance, sales area or customer)
Model differences:	All models are the same circuit and RF modules, with differences in model name, housing color, performance, sales region, or customer.
Hardware Version:	N/A
Software Version:	N/A
IEEE 802.11 WLAN Mode Supported	802.11a/n/ac/ax(20MHz channel bandwidth) 802.11n/ac/ax(40MHz channel bandwidth) 802.11ac/ax(80MHz channel bandwidth)
Operation Frequency:	5180-5240MHz for 802.11a/n/ac/ax(HT20); 5190-5230MHz for 802.11n/ac/ax(HT40); 5210MHz for 802.11 ac/ax80; 5260-5320MHz for 802.11a/n/ac/ax(HT20); 5270-5310MHz for 802.11n/ac/ax(HT40); 5290MHz for 802.11 ac/ax80; 5500-5700MHz for 802.11a/n/ac/ax(HT20); 5410-5670MHz for 802.11n/ac/ax(HT40); 5530-5610MHz for 802.11 ac/ax80; 5745-5825 MHz for 802.11a/n/ac/ax(HT20); 5755-5795 MHz for 802.11n/ac/ax(HT40); 5775MHz for 802.11 ac/ax80
Data Rate	802.11a: 6,9,12,18,24,36,48,54Mbps; 802.11n(HT20/HT40):MCS0-MCS15; 802.11ac/ax(VHT20): NSS1, MCS0-MCS8 802.11ac/ax(VHT40/VHT80):NSS1, MCS0-MCS9
Type of Modulation:	OFDM with BPSK/QPSK/16QAM/64QAM/256QAM for 802.11a/n/ac/ax;
Antenna installation:	External antenna *2
Antenna Gain:	5.1GHz: Antenna A: 3.77 dBi, Antenna B: 3.77 dBi 5.3GHz: Antenna A: 4.66 dBi, Antenna B: 4.66 dBi 5.6GHz: Antenna A: 4.45 dBi, Antenna B: 4.45 dBi 5.8GHz: Antenna A: 3.82 dBi, Antenna B: 3.82 dBi
Ratings:	DC 12V from adapter, DC 48V from POE
Adapter Information:	Model No.: AS3601A-1203000DM Input: AC 100-240V 50/60Hz Output: DC 12V 3A

4.2 Test Setup Configuration

See test photographs attached in *EUT TEST SETUP PHOTOGRAPHS* for the actual connections between Product and support equipment.

Conducted Emission & Radiated Spurious Emission:

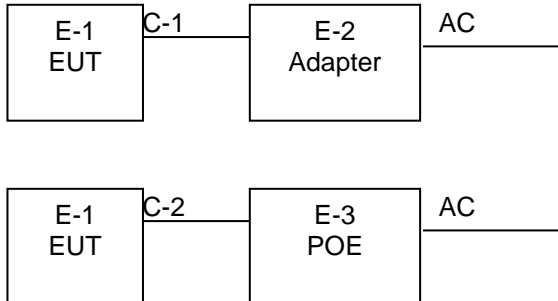

4.3 Support Equipment

No.	Device Type	Brand	Model	Series No.	Note
E-1	NearHub Rooms	N/A	AW-NR10	N/A	EUT
E-2	Adapter	N/A	AS3601A-12030 00DM	N/A	Auxiliary
E-3	POE	N/A	DS-3E0505R-E	N/A	Auxiliary

Item	Shielded Type	Ferrite Core	Length	Note
C-1	N/A	N/A	1M	DC cable unshielded
C-2	N/A	N/A	1M	Net cable unshielded

Notes:

1. All the equipment/cables were placed in the worst-case configuration to maximize the emission during the test.
2. Grounding was established in accordance with the manufacturer's requirements and conditions for the intended use.

4.4 Channel List

(U-NII-1) 5180MHz-5240MHz				
Bandwidth	Channel	Frequency (MHz)	Channel	Frequency
20MHz	36	5180	40	5200
	44	5220	48	5240
40MHz	38	5190	46	5230
80MHz	42	5210		
(U-NII-2A) 5260MHz-5320MHz				
Bandwidth	Channel	Frequency (MHz)	Channel	Frequency
20MHz	52	5260	56	5280
	60	5300	64	5320
40MHz	54	5270	62	5310
80MHz	58	5290		
(U-NII-2C) 5500MHz-5700MHz				
Bandwidth	Channel	Frequency (MHz)	Channel	Frequency
20MHz	100	5500	105	5520
	108	5540	112	5560
	116	5580	120	5600
	124	5620	128	5640
	132	5660	136	5680
	140	5700		
40MHz	102	5510	110	5550
	118	5590	126	5630
	134	5670	142	5710
80MHz	106	5530	122	5610
(U-NII-3) 5745MHz-5825MHz				
Bandwidth	Channel	Frequency (MHz)	Channel	Frequency
20MHz	149	5745	153	5765
	157	5785	161	5805
	165	5825		
40MHz	151	5775	159	5795
80MHz	155	5775		

4.5 Test Mode

To investigate the maximum EMI emission characteristics generates from EUT, the test system was pre-scanning tested base on the consideration of following EUT operation mode or test configuration mode which possible have effect on EMI emission level. Each of these EUT operation mode(s) or test configuration mode(s) mentioned above was evaluated respectively.

Pretest Mode	Description
Mode 1	802.11a / n/ ac 20/ ax 20 CH36/ CH40/ CH 48 802.11a / n/ ac 20/ax 20 CH52/ CH56/ CH 64 802.11a / n/ ac 20/ax 20 CH100/ CH116/ CH 140 802.11a /n/ ac 20/ax 20 CH149/ CH157/ CH 165
Mode 2	802.11n/ ac40/ax 40 CH38/ CH 46 802.11n/ ac40/ax 40 CH54/ CH 62 802.11n/ ac40/ax 40 CH102/ CH 110/CH134 802.11n/ ac40/ax 40 CH 151 / CH 159
Mode 3	802.11 ac80/ax 80 CH 42/ CH 58/ CH 106/ CH 155
Mode 4	Link Mode

Conducted Emission	
Final Test Mode	Description
Mode 4	Link Mode

Note: The measurements are performed at all Bit Rate of Transmitter, the worst data was reported.

4.6 Table Of Parameters Of Text Software Setting

During testing channel & power controlling software provided by the customer was used to control the operating channel as well as the output power level. The RF output power selection is for the setting of RF output power expected by the customer and is going to be fixed on the firmware of the final end product power parameters

Test software Version	CMD		
Parameters	DEF	DEF	DEF

4.7 Antenna

5.1G

Ant.	Brand	Model Name	Antenna Type	Gain (dBi)	NOTE
A	N/A	N/A	External antenna	3.77	N/A
B	N/A	N/A	External antenna	3.77	N/A

EUT has two PCB antennas with Max gain GANT 3.77 dBi on every antenna, CDD device with one spatial streams, also can operat with one spatial streams according to KDB662911-D01 v02r01, Directional gain= GANT + Array Gain, where Array Gain is as follows.

- 1)For power spectral density(PSD) measurements,
 $\text{Array Gain} = 10 \log(\text{NANT}/\text{NSS}) \text{dB} = 10 \log(2/1) = 3.01 \text{ dBi}$,
 So the directional gain for PSD is 6.78 dBi
- 2)For power measurements,
 The Array gain=0 for $\text{NANT} \leq 4$,
 So the directional gain for Power measurements is 3.77 dBi

5.3G

Ant.	Brand	Model Name	Antenna Type	Gain (dBi)	NOTE
A	N/A	N/A	External antenna	4.66	N/A
B	N/A	N/A	External antenna	4.66	N/A

EUT has two PCB antennas with Max gain GANT 4.66 dBi on every antenna, CDD device with one spatial streams, also can operat with one spatial streams according to KDB662911 D01 v02r01, Directional gain= GANT + Array Gain, where Array Gain is as follows.

- 1)For power spectral density(PSD) measurements,
 Array Gain= $10\log(\text{NANT}/\text{NSS})\text{dB}=10\log(2/1)=3.01$ dBi,
 So the directional gain for PSD is 7.67 dBi
- 2)For power measurements,
 The Array gain=0 for $\text{NANT}\leq 4$,
 So the directional gain for Power measurements is 4.66 dBi

5.6G

Ant.	Brand	Model Name	Antenna Type	Gain (dBi)	NOTE
A	N/A	N/A	External antenna	4.45	N/A
B	N/A	N/A	External antenna	4.45	N/A

EUT has two PCB antennas with Max gain GANT 4.45 dBi on every antenna, CDD device with one spatial streams, also can operat with one spatial streams according to KDB662911 D01 v02r01, Directional gain= GANT + Array Gain, where Array Gain is as follows.

- 1)For power spectral density(PSD) measurements,
 Array Gain= $10\log(\text{NANT}/\text{NSS})\text{dB}=10\log(2/1)=3.01$ dBi,
 So the directional gain for PSD is 7.46 dBi
- 2)For power measurements,
 The Array gain=0 for $\text{NANT}\leq 4$,
 So the directional gain for Power measurements is 4.45 dBi

5.8G

Ant.	Brand	Model Name	Antenna Type	Gain (dBi)	NOTE
A	N/A	N/A	External antenna	3.82	N/A
B	N/A	N/A	External antenna	3.82	N/A

EUT has two PCB antennas with Max gain GANT 3.82 dBi on every antenna, CDD device with one spatial streams, also can operat with one spatial streams according to KDB662911 D01 v02r01, Directional gain= GANT + Array Gain, where Array Gain is as follows.

- 1)For power spectral density(PSD) measurements,
 Array Gain= $10\log(\text{NANT}/\text{NSS})\text{dB}=10\log(2/1)=3.01$ dBi,
 So the directional gain for PSD is 6.83 dBi
- 2)For power measurements,
 The Array gain=0 for $\text{NANT}\leq 4$,
 So the directional gain for Power measurements is 3.82 dBi

5. Test Facility And Test Instrument Used

5.1 Test Facility

All measurement facilities used to collect the measurement data are located at Shenzhen BCTC Testing Co., Ltd. Address: 1-2/F., Building B, Pengzhou Industrial Park, No.158, Fuyuan 1st Road, Zhancheng, Fuhai Subdistrict, Bao'an District, Shenzhen, Guangdong, China. The site and apparatus are constructed in conformance with the requirements of ANSI C63.4 and CISPR 16-1-1 other equivalent standards. FCC Test Firm Registration Number: 712850 IC Registered No.: 23583

5.2 Test Instrument Used

Conducted Emissions Test					
Equipment	Manufacturer	Model#	Serial#	Last Cal.	Next Cal.
Receiver	R&S	ESR3	102075	May 15, 2023	May 14, 2024
LISN	R&S	ENV216	101375	May 15, 2023	May 14, 2024
Software	Frad	EZ-EMC	EMC-CON 3A1	\	\
Pulse limiter	Schwarzbeck	VTSD9561-F	01323	Sept. 22, 2023	Sept 21, 2024

RF Conducted Test					
Equipment	Manufacturer	Model#	Serial#	Last Cal.	Next Cal.
Power meter	Keysight	E4419	\	May 15, 2023	May 14, 2024
Power Sensor (AV)	Keysight	E9300A	\	May 15, 2023	May 14, 2024
Signal Analyzer20kHz-26.5GHz	Keysight	N9020A	MY49100060	May 15, 2023	May 14, 2024
Spectrum Analyzer9kHz-40GHz	R&S	FSP40	100363	May 15, 2023	May 14, 2024
Radio frequency control box	MAIWEI	MW100-RFC B	\	\	\
Software	MAIWEI	MTS 8310	\	\	\

Radiated Emissions Test (966 Chamber01)					
Equipment	Manufacturer	Model#	Serial#	Last Cal.	Next Cal.
966 chamber	ChengYu	966 Room	966	May 15, 2023	May 14, 2026
Receiver	R&S	ESR3	102075	May 15, 2023	May 14, 2024
Receiver	R&S	ESRP	101154	May 15, 2023	May 14, 2024
Amplifier	Schwarzbeck	BBV9744	9744-0037	May 15, 2023	May 14, 2024
TRILOG Broadband Antenna	Schwarzbeck	VULB9163	942	May 29, 2023	May 28, 2024
Loop Antenna(9KHz -30MHz)	Schwarzbeck	FMZB1519B	00014	May 31, 2023	May 30, 2024
Amplifier	SKET	LAPA_01G18 G-45dB	SK2021040901	May 15, 2023	May 14, 2024
Horn Antenna	Schwarzbeck	BBHA9120D	1541	May 31, 2023	May 30, 2024
Amplifier(18G Hz-40GHz)	MITEQ	TTA1840-35-HG	2034381	May 15, 2023	May 14, 2024
Horn Antenna(18G Hz-40GHz)	Schwarzbeck	BBHA9170	00822	May 31, 2023	May 30, 2024
Spectrum Analyzer9kHz-40GHz	R&S	FSP40	100363	May 15, 2023	May 14, 2024
Software	Frad	EZ-EMC	FA-03A2 RE	\	\

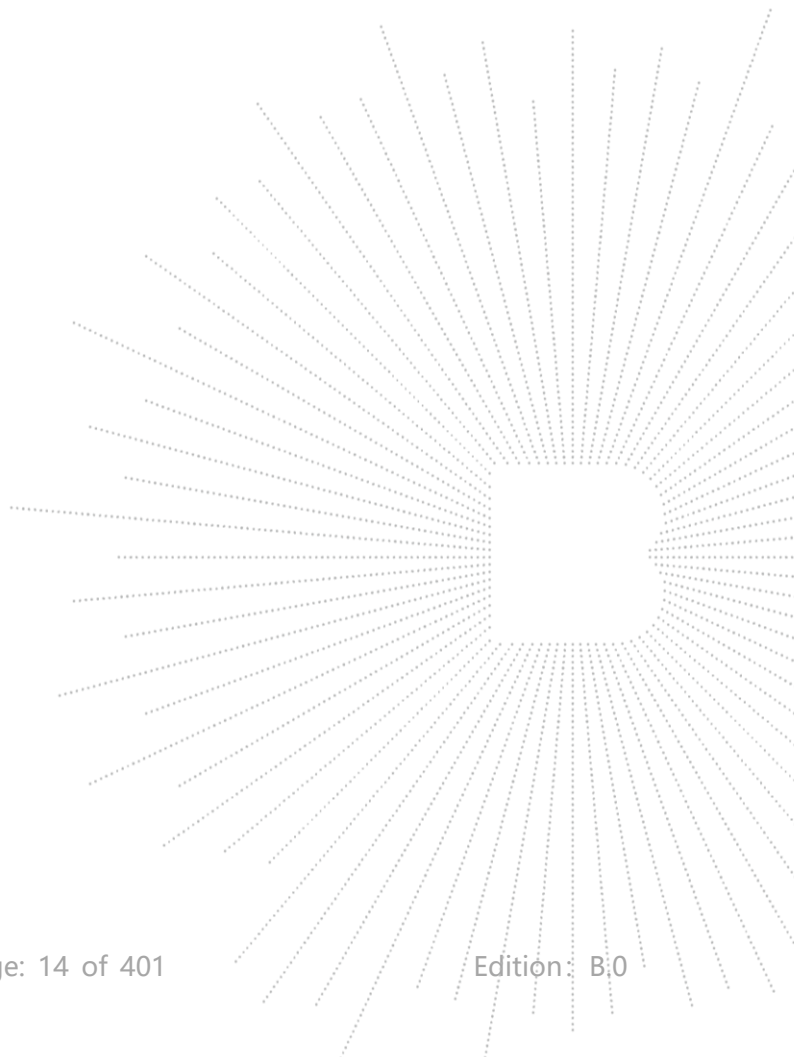

6. Conducted Emissions

6.1 Block Diagram Of Test Setup

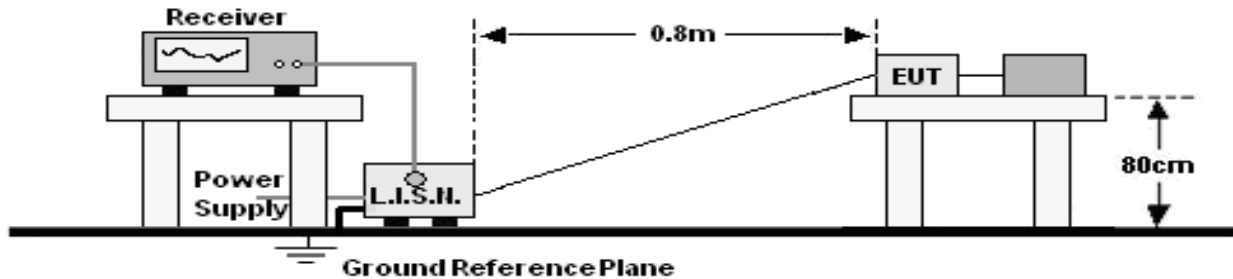

6.2 Limit

Frequency (MHz)	Limit (dBuV)	
	Quas-peak	Average
0.15 -0.5	66 - 56 *	56 - 46 *
0.50 -5.0	56.00	46.00
5.0 -30.0	60.00	50.00

Notes:
 1. *Decreasing linearly with logarithm of frequency.
 2. The lower limit shall apply at the transition frequencies.

6.3 Test Procedure

Receiver Parameters	Setting
Attenuation	10 dB
Start Frequency	0.15 MHz
Stop Frequency	30 MHz
IF Bandwidth	9 kHz

- The Product was placed on a nonconductive table 0.8 m above the horizontal ground reference plane, and 0.4 m from the vertical ground reference plane, and connected to the main through Line Impedance Stability Network (L.I.S.N).
- The RBW of the receiver was set at 9 kHz in 150 kHz ~ 30MHz with Peak and AVG detector in Max Hold mode. Run the receiver's pre-scan to record the maximum disturbance generated from Product in all power lines in the full band.
- For each frequency whose maximum record was higher or close to limit, measure its QP and AVG values and record.

6.4 EUT Operating Conditions

The EUT was configured for testing in a typical fashion (as a customer would normally use it). The EUT has been programmed to continuously transmit during test. This operating condition was tested and used to collect the included data.

6.5 Test Result

Temperature:	26 °C	Relative Humidity:	54%
Pressure:	101KPa	Phase :	L
Test Mode:	Mode 4 (Adapter)	Test Voltage :	AC120V/60Hz

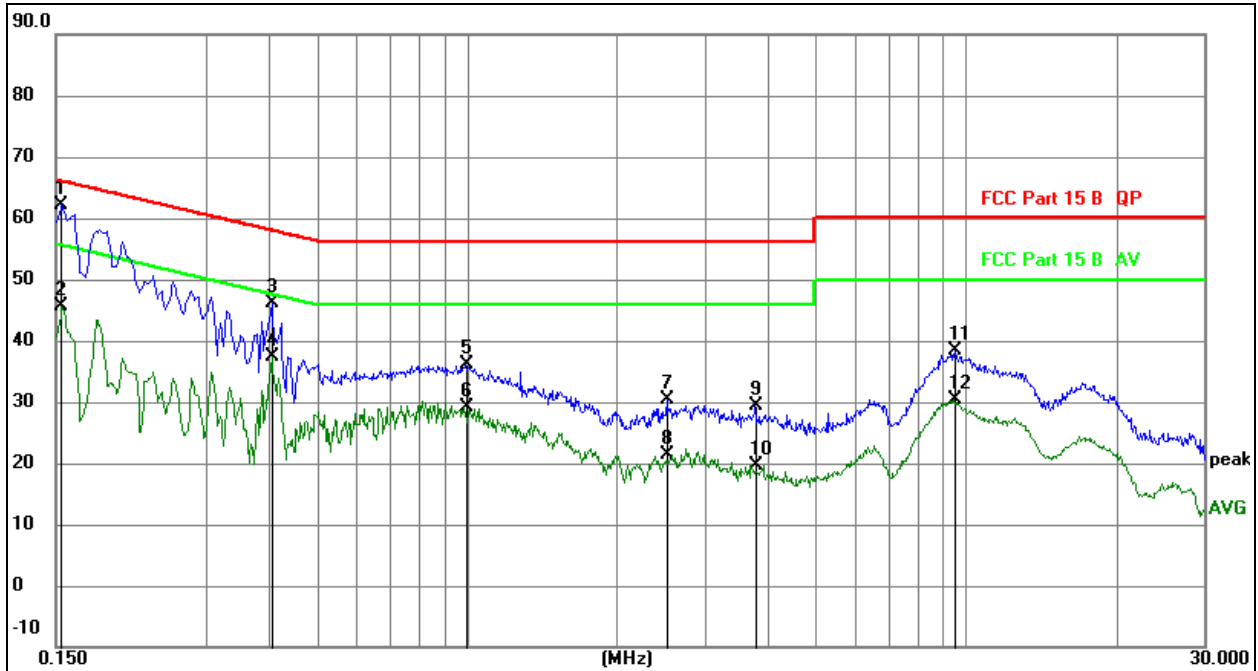

Remark:

1. All readings are Quasi-Peak and Average values.
2. Factor = Insertion Loss + Cable Loss.
3. Measurement = Reading Level + Correct Factor
4. Over = Measurement - Limit

No.	Mk.	Freq. MHz	Reading Level	Correct Factor dB	Measure- ment dBuV	Limit dBuV	Over dB	Detector
1	*	0.1539	42.51	19.74	62.25	65.79	-3.54	QP
2		0.1539	25.99	19.74	45.73	55.79	-10.06	AVG
3		0.4061	26.31	19.84	46.15	57.73	-11.58	QP
4		0.4061	17.66	19.84	37.50	47.73	-10.23	AVG
5		0.9944	16.07	19.95	36.02	56.00	-19.98	QP
6		0.9944	9.24	19.95	29.19	46.00	-16.81	AVG
7		2.5133	10.34	20.13	30.47	56.00	-25.53	QP
8		2.5133	1.14	20.13	21.27	46.00	-24.73	AVG
9		3.7794	8.90	20.58	29.48	56.00	-26.52	QP
10		3.7794	-1.06	20.58	19.52	46.00	-26.48	AVG
11		9.5016	18.41	19.89	38.30	60.00	-21.70	QP
12		9.5016	10.42	19.89	30.31	50.00	-19.69	AVG

Temperature:	26 °C	Relative Humidity:	54%
Pressure:	101KPa	Phase :	N
Test Mode:	Mode 4 (Adapter)	Test Voltage :	AC120V/60Hz

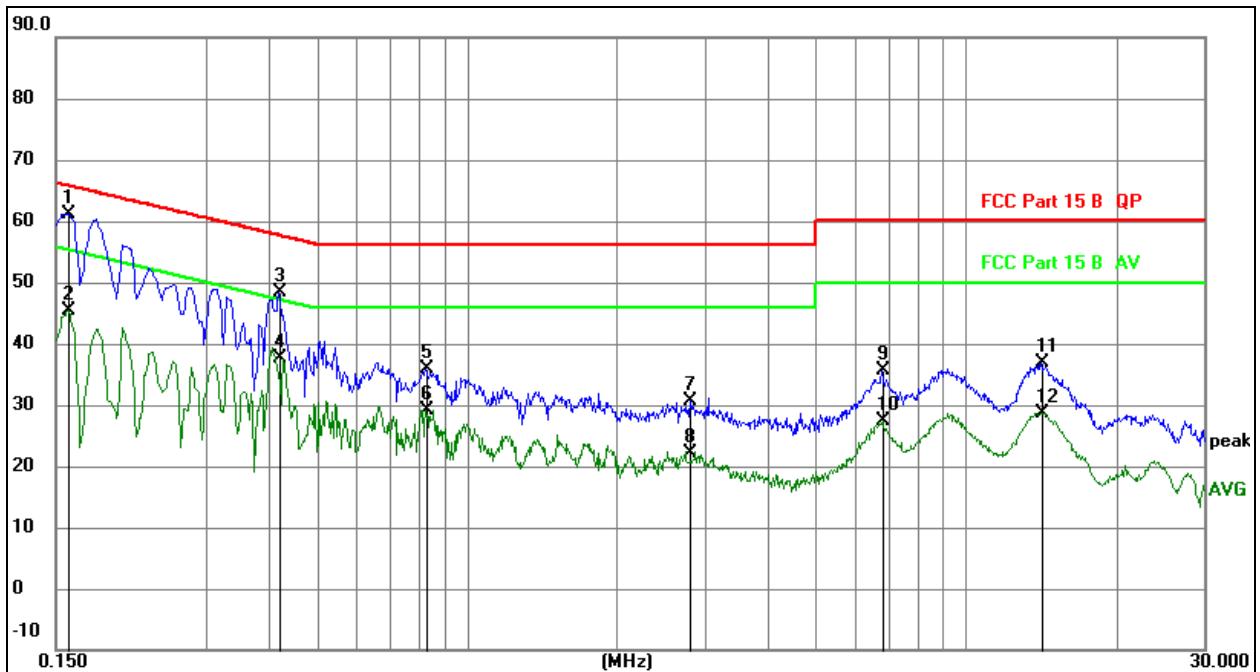
Remark:

1. All readings are Quasi-Peak and Average values.
2. Factor = Insertion Loss + Cable Loss.
3. Measurement = Reading Level + Correct Factor
4. Over = Measurement - Limit

No.	Mk.	Freq. MHz	Reading Level	Correct Factor dB	Measure- ment dBuV	Limit dBuV	Over dB	Detector
1	*	0.1590	41.49	19.75	61.24	65.52	-4.28	QP
2		0.1590	25.59	19.75	45.34	55.52	-10.18	AVG
3		0.4200	28.64	19.84	48.48	57.45	-8.97	QP
4		0.4200	17.67	19.84	37.51	47.45	-9.94	AVG
5		0.8295	15.94	19.89	35.83	56.00	-20.17	QP
6		0.8295	9.33	19.89	29.22	46.00	-16.78	AVG
7		2.8050	10.39	20.24	30.63	56.00	-25.37	QP
8		2.8050	2.01	20.24	22.25	46.00	-23.75	AVG
9		6.7740	15.50	20.01	35.51	60.00	-24.49	QP
10		6.7740	7.36	20.01	27.37	50.00	-22.63	AVG
11		14.1990	17.08	19.88	36.96	60.00	-23.04	QP
12		14.1990	8.83	19.88	28.71	50.00	-21.29	AVG

Temperature:	26 °C	Relative Humidity:	54%
Pressure:	101KPa	Phase :	L
Test Mode:	Mode 4 (POE)	Test Voltage :	AC120V/60Hz

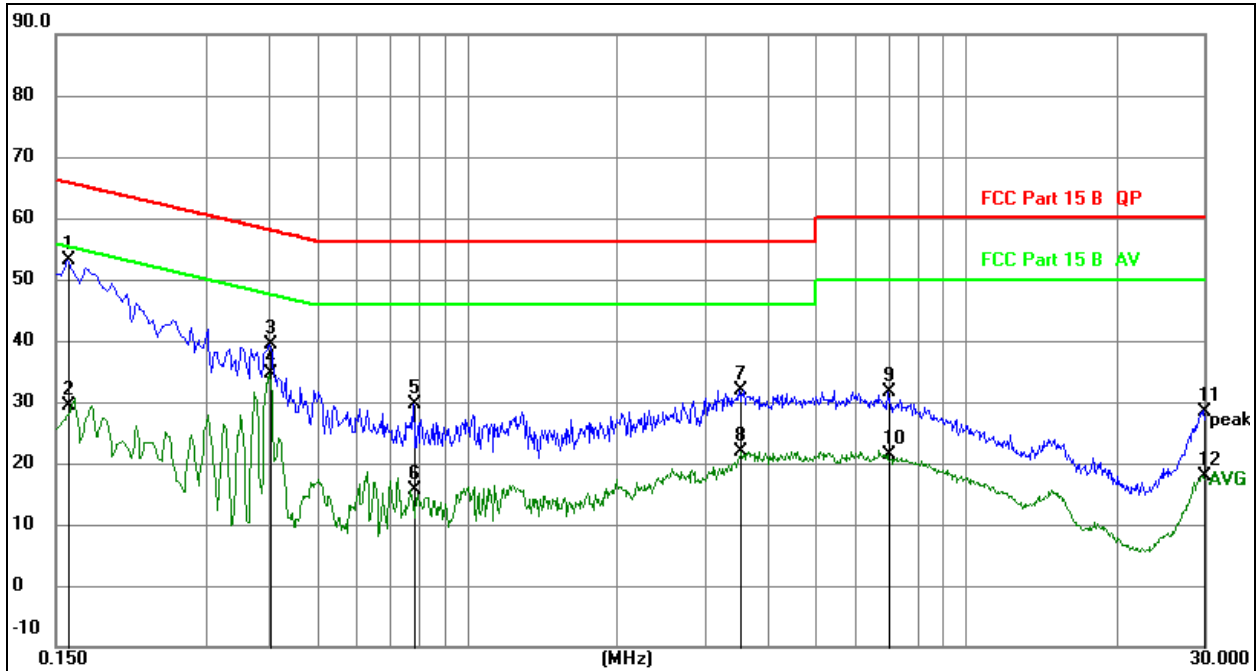
Remark:

1. All readings are Quasi-Peak and Average values.
2. Factor = Insertion Loss + Cable Loss.
3. Measurement = Reading Level + Correct Factor
4. Over = Measurement - Limit

No.	Mk.	Freq. MHz	Reading Level	Correct Factor dB	Measure- ment dBuV	Limit dBuV	Over dB	Detector
1	*	0.1590	33.44	19.75	53.19	65.52	-12.33	QP
2		0.1590	9.70	19.75	29.45	55.52	-26.07	AVG
3		0.4020	19.43	19.84	39.27	57.81	-18.54	QP
4		0.4020	14.82	19.84	34.66	47.81	-13.15	AVG
5		0.7799	9.64	19.87	29.51	56.00	-26.49	QP
6		0.7799	-4.32	19.87	15.55	46.00	-30.45	AVG
7		3.5115	11.50	20.49	31.99	56.00	-24.01	QP
8		3.5115	1.49	20.49	21.98	46.00	-24.02	AVG
9		7.0035	11.73	19.96	31.69	60.00	-28.31	QP
10		7.0035	1.49	19.96	21.45	50.00	-28.55	AVG
11		29.9625	8.51	19.99	28.50	60.00	-31.50	QP
12		29.9625	-2.12	19.99	17.87	50.00	-32.13	AVG

Temperature:	26 °C	Relative Humidity:	54%
Pressure:	101KPa	Phase :	N
Test Mode:	Mode 4 (POE)	Test Voltage :	AC120V/60Hz

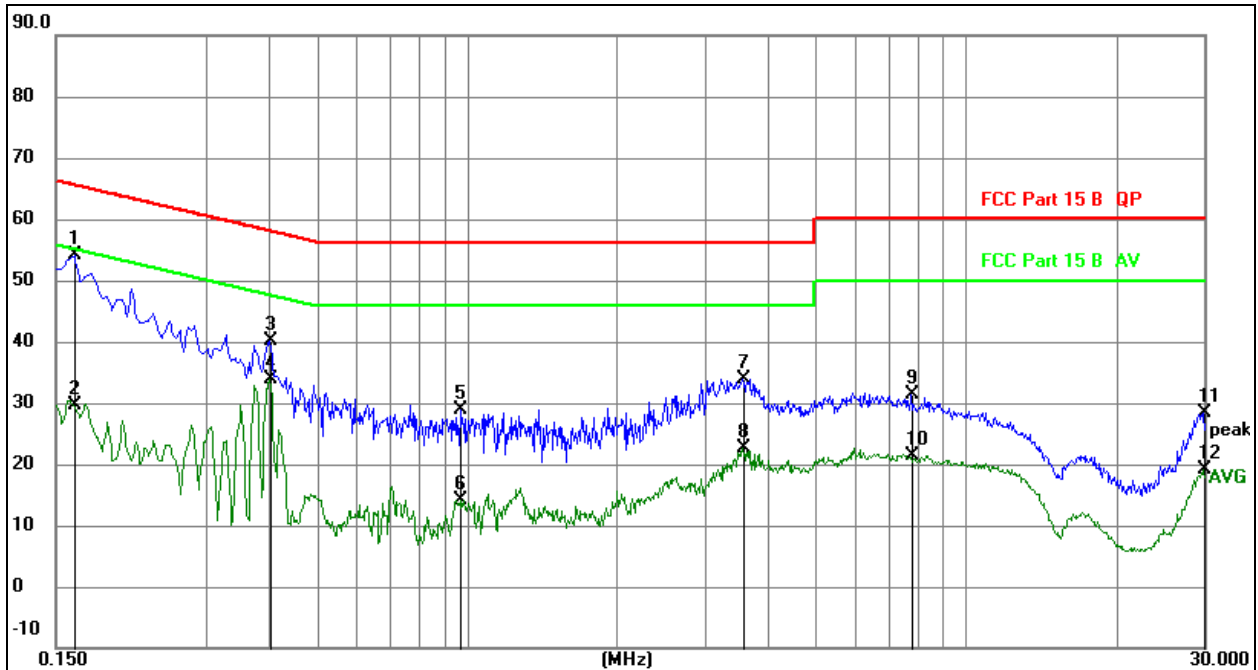
Remark:

1. All readings are Quasi-Peak and Average values.
2. Factor = Insertion Loss + Cable Loss.
3. Measurement = Reading Level + Correct Factor
4. Over = Measurement - Limit

No.	Mk.	Freq. MHz	Reading Level	Correct Factor dB	Measure- ment dBuV	Limit dBuV	Over dB	Detector
1	*	0.1633	34.35	19.76	54.11	65.29	-11.18	QP
2		0.1633	9.95	19.76	29.71	55.29	-25.58	AVG
3		0.4019	20.36	19.84	40.20	57.81	-17.61	QP
4		0.4019	14.07	19.84	33.91	47.81	-13.90	AVG
5		0.9735	8.91	19.94	28.85	56.00	-27.15	QP
6		0.9735	-5.76	19.94	14.18	46.00	-31.82	AVG
7		3.5654	13.48	20.51	33.99	56.00	-22.01	QP
8		3.5654	2.11	20.51	22.62	46.00	-23.38	AVG
9		7.7689	11.38	19.94	31.32	60.00	-28.68	QP
10		7.7689	1.32	19.94	21.26	50.00	-28.74	AVG
11		29.8415	8.31	19.99	28.30	60.00	-31.70	QP
12		29.8415	-0.95	19.99	19.04	50.00	-30.96	AVG

7. Radiated Emissions

7.1 Block Diagram Of Test Setup

(A) Radiated Emission Test-Up Frequency Below 30MHz

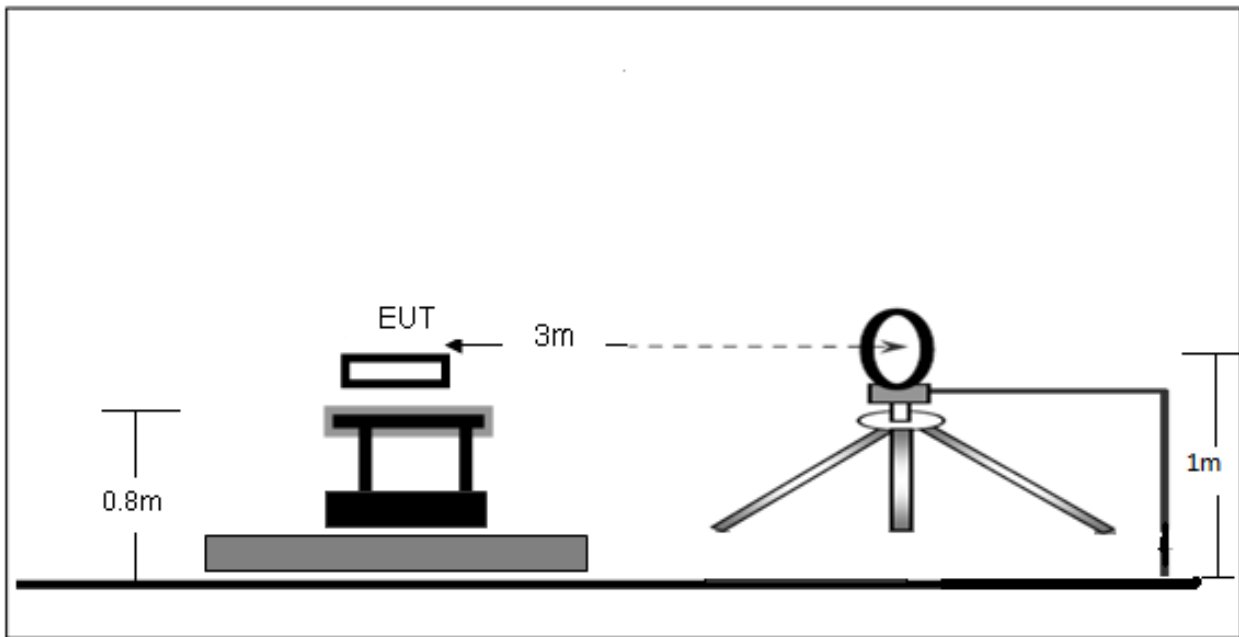

(B) Radiated Emission Test-Up Frequency 30MHz~1GHz

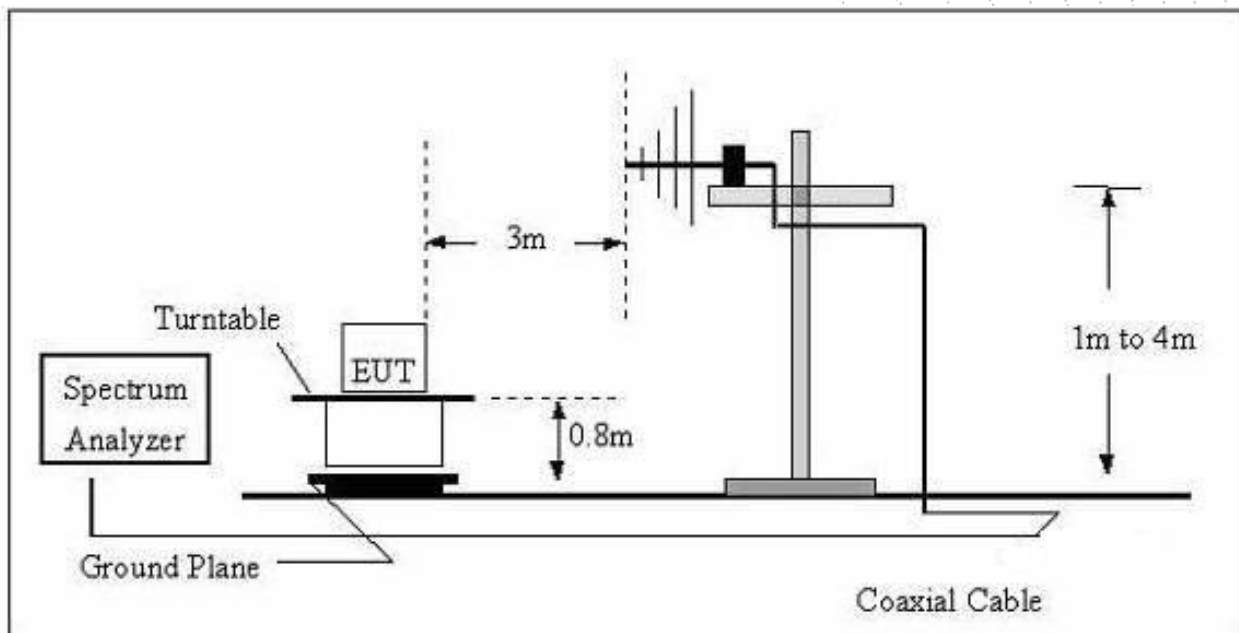

(C) Radiated Emission Test-Up Frequency Above 1GHz

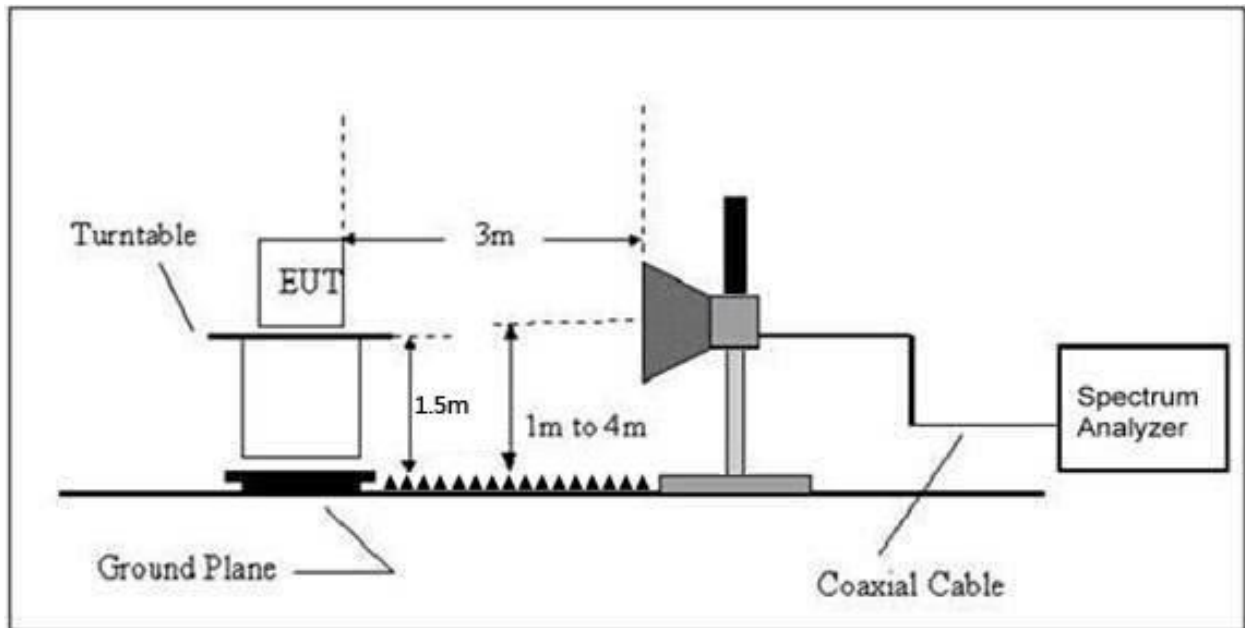

7.2 Limit

20dBc in any 100 kHz bandwidth outside the operating frequency band. In case the emission fall within the restricted band specified on 15.205(a), then the 15.209(a) limit in the table below has to be followed.

Frequency (MHz)	Field Strength uV/m	Distance (m)	Field Strength Limit at 3m Distance	
			uV/m	dBuV/m
0.009 ~ 0.490	2400/F(kHz)	300	10000 * 2400/F(kHz)	20log ^{(2400/F(kHz))} + 80
0.490 ~ 1.705	24000/F(kHz)	30	100 * 24000/F(kHz)	20log ^{(24000/F(kHz))} + 40
1.705 ~ 30	30	30	100 * 30	20log ⁽³⁰⁾ + 40
30 ~ 88	100	3	100	20log ⁽¹⁰⁰⁾
88 ~ 216	150	3	150	20log ⁽¹⁵⁰⁾
216 ~ 960	200	3	200	20log ⁽²⁰⁰⁾
Above 960	500	3	500	20log ⁽⁵⁰⁰⁾

Limits Of Radiated Emission Measurement (Above 1000MHz)

Frequency (MHz)	Limit (dBuV/m) (at 3M)	
	Peak	Average
Above 1000	74	54

Notes:

- (1)The limit for radiated test was performed according to FCC PART 15C.
- (2)The tighter limit applies at the band edges.
- (3) Emission level (dBuV/m)=20log Emission level (uV/m).

7.3 Test Procedure

The test site semi-anechoic chamber has met the requirement of NSA tolerance 4 dB according to the standards: ANSI C63.10-2013. The test distance is 3m. The setup is according to the requirements in Section 13.1.4.1 of ANSI C63.10-2013 and CAN/CSA-CEI/IEC CISPR 22.

This test is required for any spurious emission that falls in a Restricted Band, as defined in Section 15.205.

It must be performed with the highest gain of each type of antenna proposed for use with the EUT. Use the following spectrum analyzer settings:

Spectrum Parameter	Setting
Attenuation	Auto
Start Frequency	1000 MHz
Stop Frequency	10th carrier harmonic
RB / VB (emission in restricted band)	1 MHz / 1 MHz for Peak, 1 MHz / 10Hz for Average

Receiver Parameter	Setting
Attenuation	Auto
Start ~ Stop Frequency	9kHz~150kHz / RB 200Hz for QP
Start ~ Stop Frequency	150kHz~30MHz / RB 9kHz for QP
Start ~ Stop Frequency	30MHz~1000MHz / RB 120kHz for QP

- The measuring distance of at 3 m shall be used for measurements at frequency up to 1GHz. For frequencies above 1GHz, any suitable measuring distance may be used.
- The EUT was placed on the top of a rotating table 0.8 m for below 1GHz and 1.5m for above 1GHz the ground at a 3 meter. The table was rotated 360 degrees to determine the position of the highest radiation.
- The height of the equipment or of the substitution antenna shall be 0.8 m for below 1GHz and 1.5m for above 1GHz; the height of the test antenna shall vary between 1 m to 4 m. Both horizontal and vertical polarizations of the antenna are set to make the measurement.
- The initial step in collecting conducted emission data is a spectrum analyzer peak detector mode pre-scanning the measurement frequency range. Significant peaks are then marked and then Quasi Peak detector mode re-measured.
- If the Peak Mode measured value compliance with and lower than Quasi Peak Mode Limit, the EUT shall be deemed to meet QP Limits and then no additional QP Mode measurement performed.
- For the actual test configuration, please refer to the related Item –EUT Test Photos.

Note:

Both horizontal and vertical antenna polarities were tested and performed pretest to three orthogonal axis. The worst case emissions were reported

During the radiated emission test, the Spectrum Analyzer was set with the following configurations:

Frequency Band (MHz)	Function	Resolution bandwidth	Video Bandwidth
30 to 1000	QP	120 kHz	300 kHz
Above 1000	Peak	1 MHz	1 MHz
	Average	1 MHz	10 Hz

Note: for the frequency ranges below 30 MHz, a narrower RBW is used for these ranges but the measured value should add a RBW correction factor (RBWCF) where $RBWCF [dB] = 10 \cdot \lg(100 [kHz] / \text{narrower RBW} [kHz])$. , the narrower RBW is 1 kHz and RBWCF is 20 dB for the frequency 9 kHz to 150 kHz, and the narrower RBW is 10 kHz and RBWCF is 10 dB for the frequency 150 kHz to 30 MHz.

7.4 EUT Operating Conditions

The EUT was configured for testing in a typical fashion (as a customer would normally use it). The EUT has been programmed to continuously transmit during test. This operating condition was tested and used to collect the included data.

7.5 Test Result

Below 30MHz

Temperature:	26 °C	Relative Humidity:	54%
Pressure:	101KPa	Test Voltage :	AC120V/60Hz
Test Mode:	Mode 4	Polarization :	---

Freq. (MHz)	Reading (dBuV/m)	Limit (dBuV/m)	Margin (dB)	State P/F
--	--	--	--	PASS
--	--	--	--	PASS

Note:

The amplitude of spurious emissions which are attenuated by more than 20dB below the permissible value has no need to be reported.

Distance extrapolation factor = $40 \log(\text{specific distance/test distance})$ (dB);

Limit line = specific limits(dBuv) + distance extrapolation factor.

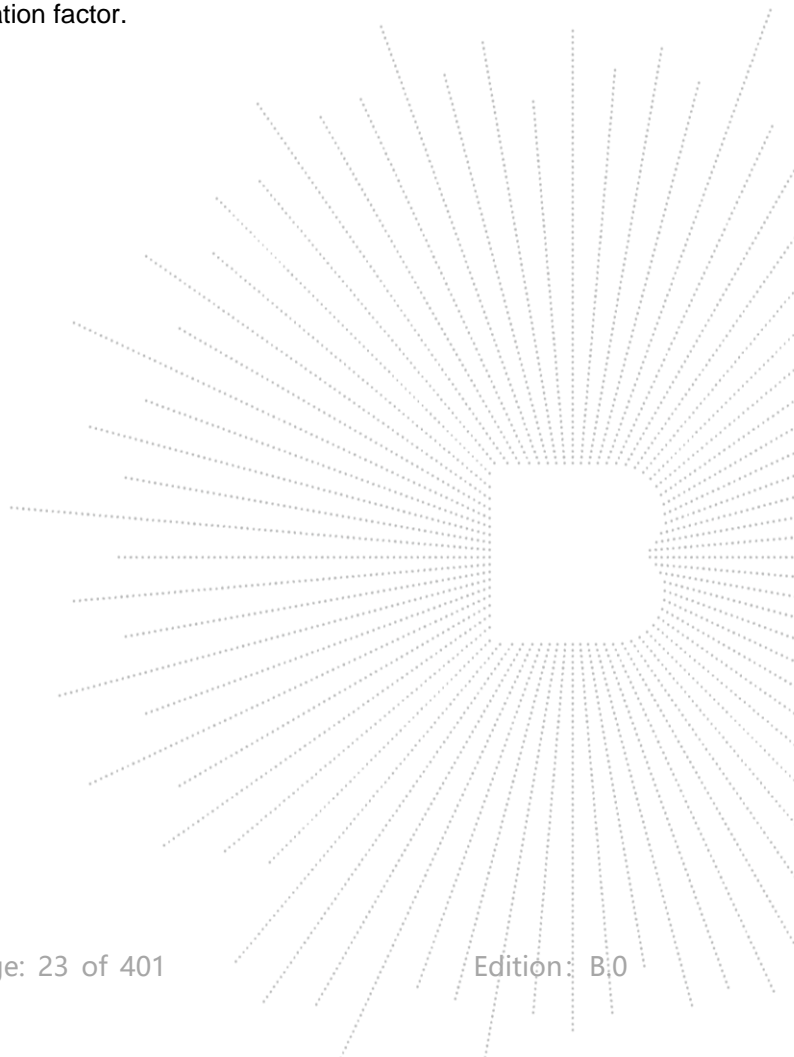

Between 30MHz – 1GHz

Temperature:	26 °C	Relative Humidity:	54%
Pressure:	101KPa	Phase :	Horizontal
Test Mode:	Mode 4 (Adapter)	Test Voltage:	AC120V/60Hz

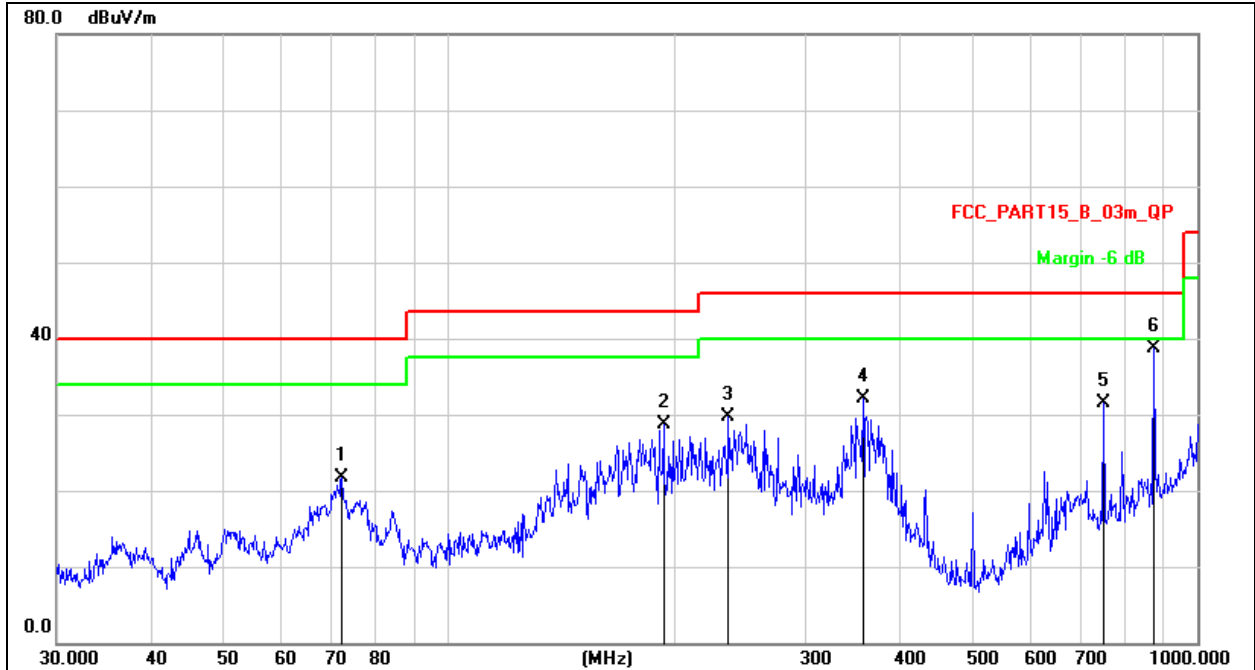

Remark:

1. Factor = Antenna Factor + Cable Loss – Pre-amplifier.
2. Measurement = Reading Level + Correct Factor
3. Over = Measurement - Limit

No.	Mk.	Freq. MHz	Reading Level dBuV	Correct Factor dB	Measure- ment dBuV/m	Limit dB/m	Over dB	Detector
1		72.0843	38.08	-16.31	21.77	40.00	-18.23	QP
2		193.7728	42.69	-13.96	28.73	43.50	-14.77	QP
3		236.6447	45.22	-15.54	29.68	46.00	-16.32	QP
4		357.9287	48.18	-16.01	32.17	46.00	-13.83	QP
5		750.1083	41.59	-9.99	31.60	46.00	-14.40	QP
6	*	875.2470	44.89	-6.24	38.65	46.00	-7.35	QP

Temperature:	26 °C	Relative Humidity:	54%
Pressure:	101KPa	Phase :	Vertical
Test Mode:	Mode 4 (Adapter)	Test Voltage:	AC120V/60Hz

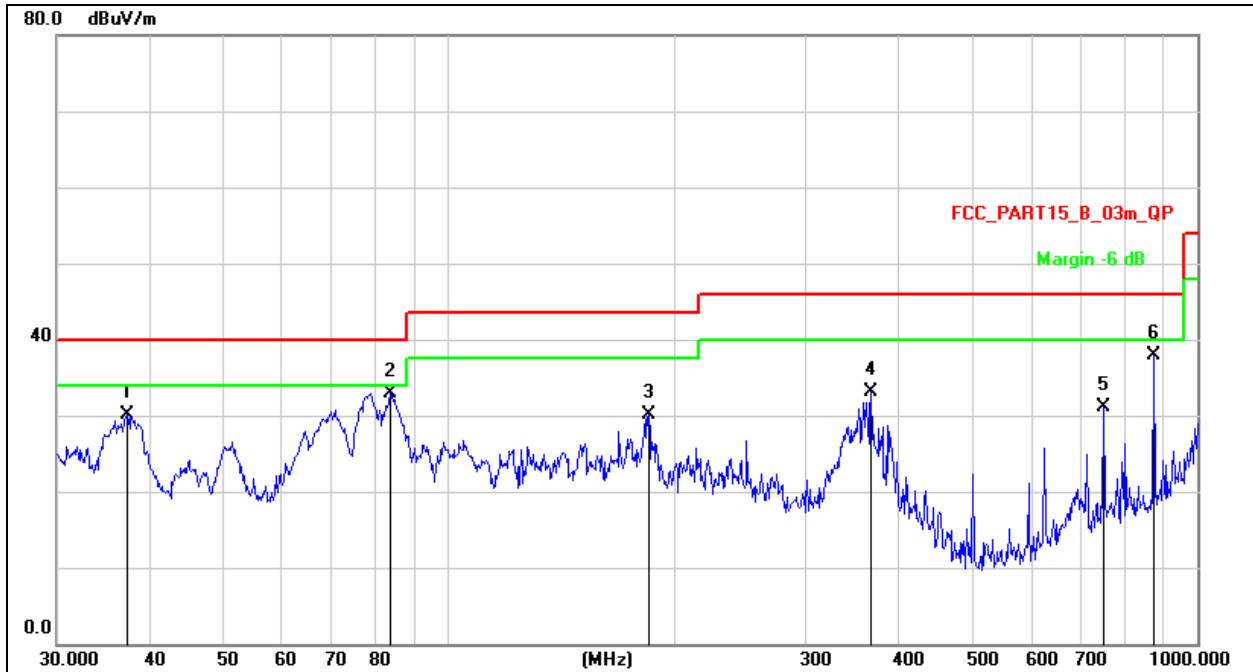
Remark:

1. Factor = Antenna Factor + Cable Loss – Pre-amplifier.
2. Measurement = Reading Level + Correct Factor
3. Over = Measurement - Limit

No.	Mk.	Freq. MHz	Reading Level dBuV	Correct Factor dB	Measure- ment dBuV/m	Limit dB/m	Over dB	Detector
1		37.2855	46.91	-16.74	30.17	40.00	-9.83	QP
2	*	83.5222	48.69	-15.72	32.97	40.00	-7.03	QP
3		185.1379	43.95	-13.87	30.08	43.50	-13.42	QP
4		366.8231	49.20	-16.03	33.17	46.00	-12.83	QP
5		750.1083	41.03	-9.99	31.04	46.00	-14.96	QP
6		875.2470	44.13	-6.24	37.89	46.00	-8.11	QP

Temperature:	26 °C	Relative Humidity:	54%
Pressure:	101KPa	Phase :	Horizontal
Test Mode:	Mode 4 (POE)	Test Voltage:	AC120V/60Hz

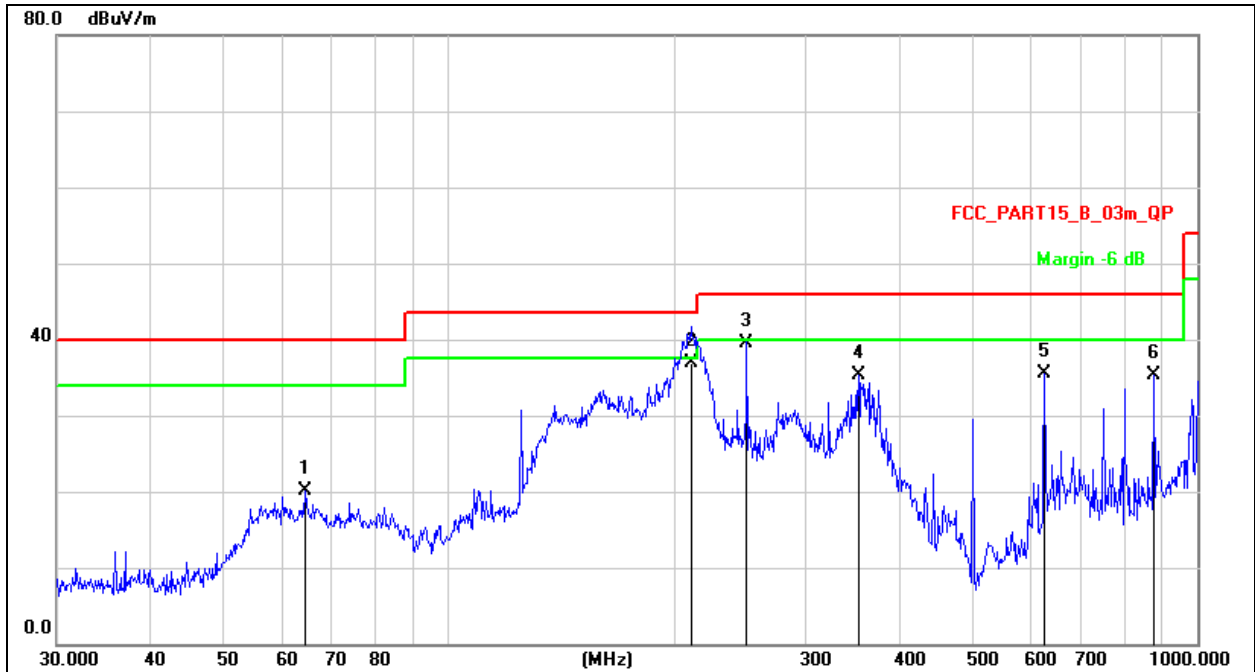
Remark:

1. Factor = Antenna Factor + Cable Loss – Pre-amplifier.
2. Measurement = Reading Level + Correct Factor
3. Over = Measurement - Limit

No.	Mk.	Freq. MHz	Reading Level dBuV	Correct Factor dB	Measure- ment dBuV/m	Limit dB/m	Over dB	Detector
1		64.4331	36.56	-16.46	20.10	40.00	-19.90	QP
2		210.7860	51.44	-14.47	36.97	43.50	-6.53	QP
3	*	250.3012	55.71	-16.11	39.60	46.00	-6.40	QP
4		352.9433	51.29	-15.99	35.30	46.00	-10.70	QP
5		625.0780	48.80	-13.24	35.56	46.00	-10.44	QP
6		875.2470	41.51	-6.24	35.27	46.00	-10.73	QP

Temperature:	26 °C	Relative Humidity:	54%
Pressure:	101KPa	Phase :	Vertical
Test Mode:	Mode 4 (POE)	Test Voltage:	AC120V/60Hz

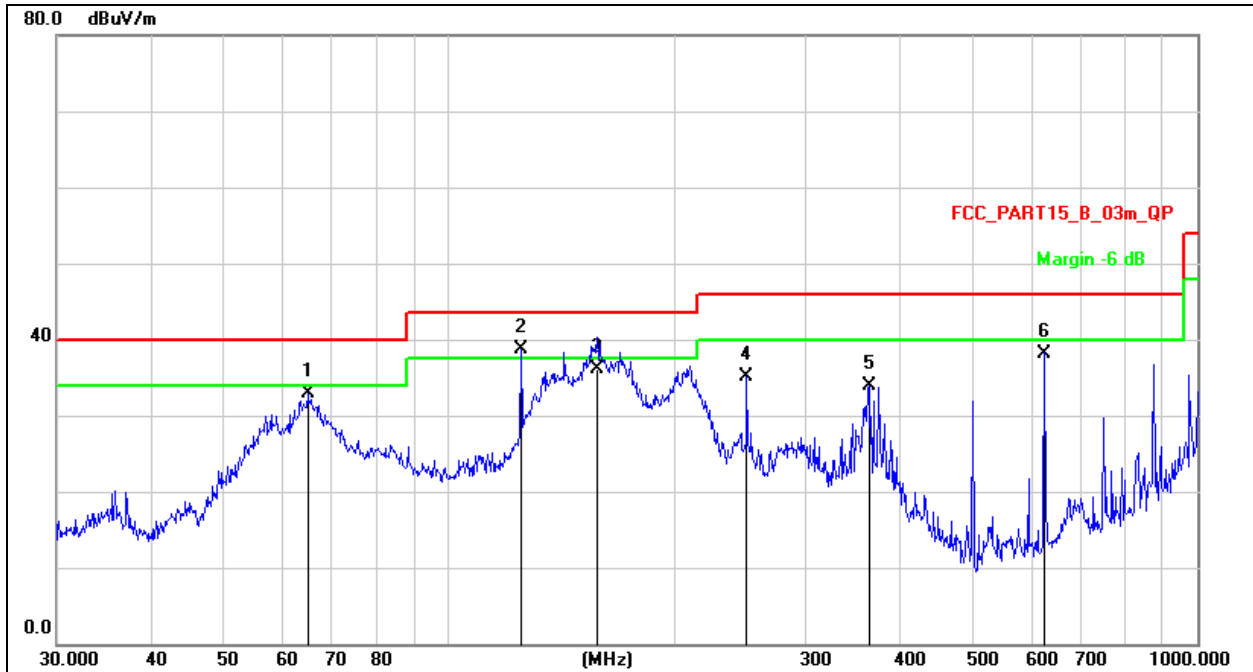
Remark:

1. Factor = Antenna Factor + Cable Loss – Pre-amplifier.
2. Measurement = Reading Level + Correct Factor
3. Over = Measurement - Limit

No.	Mk.	Freq. MHz	Reading Level dBuV	Correct Factor dB	Measure- ment dBuV/m	Limit dB/m	Over dB	Detector
1		64.8865	49.35	-16.45	32.90	40.00	-7.10	QP
2	*	125.0066	52.90	-14.23	38.67	43.50	-4.83	QP
3		158.1123	49.71	-13.61	36.10	43.50	-7.40	QP
4		250.3012	51.18	-16.11	35.07	46.00	-10.93	QP
5		364.2595	49.92	-16.03	33.89	46.00	-12.11	QP
6		625.0780	51.44	-13.24	38.20	46.00	-7.80	QP

Between 1GHz – 40GHz(The worst case)

Test Mode:	TX(5.1G) - 802.11a
------------	--------------------

Polar (H/V)	Fre- quency (MHz)	Reading Level (dBuV/m)	Correct Factor (dB)	Measure- ment (dBuV/m)	Limits (dBuV/m)	Over (dB)	Detector Type
Low Channel (5180 MHz)-Above 1G							
Vertical	4434.084	72.50	-20.73	51.77	68.2	-16.43	PK
Vertical	4434.084	59.01	-20.73	38.27	54	-15.73	AV
Vertical	10360.025	60.73	-9.36	51.37	68.2	-16.83	PK
Vertical	10360.025	49.33	-9.36	39.97	54	-14.03	AV
Vertical	15540.155	62.55	-7.84	54.71	74	-19.29	PK
Vertical	15540.155	49.80	-7.84	41.96	54	-12.04	AV
Horizontal	4434.022	70.23	-20.73	49.50	68.2	-18.70	PK
Horizontal	4434.022	59.41	-20.73	38.68	54	-15.32	AV
Horizontal	10360.124	60.27	-9.36	50.91	68.2	-17.29	PK
Horizontal	10360.124	49.77	-9.36	40.41	54	-13.59	AV
Horizontal	15540.030	60.86	-7.84	53.02	74	-20.98	PK
Horizontal	15540.030	49.46	-7.84	41.62	54	-12.38	AV
middle Channel (5200 MHz)-Above 1G							
Vertical	4592.113	71.54	-20.42	51.13	74	-22.87	PK
Vertical	4592.113	59.59	-20.42	39.18	54	-14.82	AV
Vertical	10400.059	62.52	-9.30	53.22	68.2	-14.98	PK
Vertical	10400.059	49.83	-9.30	40.53	54	-13.47	AV
Vertical	15600.027	63.27	-7.82	55.45	74	-18.55	PK
Vertical	15600.027	49.94	-7.82	42.12	54	-11.88	AV
Horizontal	4592.141	73.15	-20.42	52.74	74	-21.26	PK
Horizontal	4592.141	59.61	-20.42	39.20	54	-14.80	AV
Horizontal	10400.003	63.20	-9.30	53.90	68.2	-14.30	PK
Horizontal	10400.003	49.97	-9.30	40.67	54	-13.33	AV
Horizontal	15600.036	60.76	-7.82	52.94	74	-21.06	PK
Horizontal	15600.036	49.88	-7.82	42.06	54	-11.94	AV
High Channel (5240 MHz)-Above 1G							
Vertical	4739.007	71.30	-20.12	51.18	74	-22.82	PK
Vertical	4739.007	59.29	-20.12	39.16	54	-14.84	AV
Vertical	10480.110	63.40	-9.18	54.22	68.2	-13.98	PK
Vertical	10480.110	49.64	-9.18	40.46	54	-13.54	AV
Vertical	15720.128	60.64	-7.78	52.86	74	-21.14	PK
Vertical	15720.128	49.87	-7.78	42.09	54	-11.91	AV
Horizontal	4739.052	74.18	-20.12	54.06	74	-19.94	PK
Horizontal	4739.052	59.81	-20.12	39.69	54	-14.31	AV
Horizontal	10480.099	61.83	-9.18	52.65	68.2	-15.55	PK
Horizontal	10480.099	49.85	-9.18	40.67	54	-13.33	AV
Horizontal	15720.088	60.96	-7.78	53.18	74	-20.82	PK
Horizontal	15720.088	49.51	-7.78	41.73	54	-12.27	AV

Note: PK value is lower than the Average value limit, So average didn't record.

The 26.5-40G amplitude of spurious emissions that are attenuated by more than 20dB below the permissible value has no need to be reported.

Emission level (dBuV/m) = 20 log Emission level (uV/m).

Corrected Reading: Antenna Factor + Cable Loss + Read Level - Preamp Factor = Level.

The worst case is Antenna A.

Test Mode:	TX(5.1G) - 802.11n-HT20
------------	-------------------------

Polar (H/V)	Fre- quency (MHz)	Reading Level (dBuV/m)	Correct Factor (dB)	Measure- ment (dBuV/m)	Limits (dBuV/m)	Over (dB)	Detector Type
Low Channel (5180 MHz)-Above 1G							
Vertical	4434.181	74.99	-20.73	54.26	68.2	-13.94	PK
Vertical	4434.181	59.73	-20.73	38.99	54	-15.01	AV
Vertical	10360.186	64.51	-9.36	55.15	68.2	-13.05	PK
Vertical	10360.186	49.21	-9.36	39.85	54	-14.15	AV
Vertical	15540.189	60.54	-7.84	52.70	74	-21.30	PK
Vertical	15540.189	49.67	-7.84	41.83	54	-12.17	AV
Horizontal	4434.103	72.07	-20.73	51.34	68.2	-16.86	PK
Horizontal	4434.103	59.23	-20.73	38.50	54	-15.50	AV
Horizontal	10360.181	61.11	-9.36	51.75	68.2	-16.45	PK
Horizontal	10360.181	49.72	-9.36	40.36	54	-13.64	AV
Horizontal	15540.007	63.40	-7.84	55.56	74	-18.44	PK
Horizontal	15540.007	49.58	-7.84	41.74	54	-12.26	AV
middle Channel (5200 MHz)-Above 1G							
Vertical	4592.046	70.50	-20.42	50.08	74	-23.92	PK
Vertical	4592.046	59.29	-20.42	38.88	54	-15.12	AV
Vertical	10400.083	61.81	-9.30	52.51	68.2	-15.69	PK
Vertical	10400.083	49.78	-9.30	40.48	54	-13.52	AV
Vertical	15600.047	60.21	-7.82	52.39	74	-21.61	PK
Vertical	15600.047	49.60	-7.82	41.78	54	-12.22	AV
Horizontal	4592.022	74.99	-20.42	54.58	74	-19.42	PK
Horizontal	4592.022	59.47	-20.42	39.05	54	-14.95	AV
Horizontal	10400.050	61.06	-9.30	51.76	68.2	-16.44	PK
Horizontal	10400.050	49.35	-9.30	40.05	54	-13.95	AV
Horizontal	15600.050	64.60	-7.82	56.78	74	-17.22	PK
Horizontal	15600.050	49.68	-7.82	41.86	54	-12.14	AV
High Channel (5240 MHz)-Above 1G							
Vertical	4739.161	70.13	-20.12	50.01	74	-23.99	PK
Vertical	4739.161	59.57	-20.12	39.44	54	-14.56	AV
Vertical	10480.157	61.29	-9.18	52.11	68.2	-16.09	PK
Vertical	10480.157	49.63	-9.18	40.45	54	-13.55	AV
Vertical	15720.150	62.69	-7.78	54.91	74	-19.09	PK
Vertical	15720.150	49.60	-7.78	41.82	54	-12.18	AV
Horizontal	4739.096	72.68	-20.12	52.56	74	-21.44	PK
Horizontal	4739.096	59.59	-20.12	39.47	54	-14.53	AV
Horizontal	10480.147	63.25	-9.18	54.07	68.2	-14.13	PK
Horizontal	10480.147	49.80	-9.18	40.62	54	-13.38	AV
Horizontal	15720.040	61.89	-7.78	54.11	74	-19.89	PK
Horizontal	15720.040	49.16	-7.78	41.38	54	-12.62	AV

Note: PK value is lower than the Average value limit, So average didn't record.
 The 26.5-40G amplitude of spurious emissions that are attenuated by more than 20dB below the permissible value has no need to be reported.
 Emission level (dBuV/m) = 20 log Emission level (uV/m).
 Corrected Reading: Antenna Factor + Cable Loss + Read Level - Preamp Factor = Level.
 Test Mode is MIMO Mode.

Test Mode:	TX(5.1G) - 802.11n-HT40
------------	-------------------------

Polar (H/V)	Fre- quency (MHz)	Reading Level (dBuV/m)	Correct Factor (dB)	Measure- ment (dBuV/m)	Limits (dBuV/m)	Over (dB)	Detector Type
Low Channel (5190 MHz)-Above 1G							
Vertical	4434.023	70.64	-20.73	49.91	68.2	-18.29	PK
Vertical	4434.023	59.37	-20.73	38.64	54	-15.36	AV
Vertical	10380.158	60.49	-9.33	51.16	68.2	-17.04	PK
Vertical	10380.158	49.76	-9.33	40.43	54	-13.57	AV
Vertical	15570.031	60.88	-7.83	53.05	74	-20.95	PK
Vertical	15570.031	49.76	-7.83	41.93	54	-12.07	AV
Horizontal	4434.125	74.05	-20.73	53.32	74	-20.68	PK
Horizontal	4434.125	59.35	-20.73	38.62	54	-15.38	AV
Horizontal	10380.139	60.70	-9.33	51.37	68.2	-16.83	PK
Horizontal	10380.139	49.19	-9.33	39.86	54	-14.14	AV
Horizontal	15570.015	64.44	-7.83	56.61	74	-17.39	PK
Horizontal	15570.015	49.82	-7.83	41.99	54	-12.01	AV
High Channel (5230 MHz)-Above 1G							
Vertical	4739.077	73.67	-20.12	53.55	68.2	-14.65	PK
Vertical	4739.077	59.42	-20.12	39.30	54	-14.70	AV
Vertical	10460.087	62.94	-9.21	53.73	68.2	-14.47	PK
Vertical	10460.087	49.01	-9.21	39.80	54	-14.20	AV
Vertical	15690.005	62.01	-7.79	54.22	74	-19.78	PK
Vertical	15690.005	49.38	-7.79	41.59	54	-12.41	AV
Horizontal	4739.174	73.40	-20.12	53.28	68.2	-14.92	PK
Horizontal	4739.174	59.41	-20.12	39.29	54	-14.71	AV
Horizontal	10460.192	61.44	-9.21	52.23	68.2	-15.97	PK
Horizontal	10460.192	49.23	-9.21	40.02	54	-13.98	AV
Horizontal	15690.020	63.77	-7.79	55.98	74	-18.02	PK
Horizontal	15690.020	49.48	-7.79	41.69	54	-12.31	AV

Note: PK value is lower than the Average value limit, So average didn't record.
 The 26.5-40G amplitude of spurious emissions that are attenuated by more than 20dB below the permissible value has no need to be reported.
 Emission level (dBuV/m) = 20 log Emission level (uV/m).
 Corrected Reading: Antenna Factor + Cable Loss + Read Level - Preamp Factor = Level.
 Test Mode is MIMO Mode.

Test Mode:	TX(5.1G) - 802.11ac-HT20
------------	--------------------------

Polar	Fre- quency	Reading Level	Correct Factor	Measure- ment	Limits	Over	Detector Type
(H/V)	(MHz)	(dBuV/m)	(dB)	(dBuV/m)	(dBuV/m)	(dB)	
Low Channel (5180 MHz)-Above 1G							
Vertical	4434.179	72.21	-20.73	51.48	68.2	-16.72	PK
Vertical	4434.179	59.51	-20.73	38.78	54	-15.22	AV
Vertical	10360.172	61.39	-9.36	52.03	68.2	-16.17	PK
Vertical	10360.172	49.76	-9.36	40.40	54	-13.60	AV
Vertical	15540.115	62.49	-7.84	54.65	74	-19.35	PK
Vertical	15540.115	49.76	-7.84	41.92	54	-12.08	AV
Horizontal	4434.058	71.11	-20.73	50.37	68.2	-17.83	PK
Horizontal	4434.058	59.71	-20.73	38.98	54	-15.02	AV
Horizontal	10360.173	62.98	-9.36	53.62	68.2	-14.58	PK
Horizontal	10360.173	49.22	-9.36	39.86	54	-14.14	AV
Horizontal	15540.067	61.42	-7.84	53.58	74	-20.42	PK
Horizontal	15540.067	49.36	-7.84	41.52	54	-12.48	AV
middle Channel (5200 MHz)-Above 1G							
Vertical	4592.017	74.47	-20.42	54.05	74	-19.95	PK
Vertical	4592.017	59.37	-20.42	38.95	54	-15.05	AV
Vertical	10400.043	62.15	-9.30	52.85	68.2	-15.35	PK
Vertical	10400.043	49.30	-9.30	40.00	54	-14.00	AV
Vertical	15600.063	64.42	-7.82	56.60	74	-17.40	PK
Vertical	15600.063	49.23	-7.82	41.41	54	-12.59	AV
Horizontal	4592.176	72.05	-20.42	51.64	74	-22.36	PK
Horizontal	4592.176	59.58	-20.42	39.16	54	-14.84	AV
Horizontal	10400.187	61.19	-9.30	51.89	68.2	-16.31	PK
Horizontal	10400.187	49.79	-9.30	40.49	54	-13.51	AV
Horizontal	15600.100	60.92	-7.82	53.10	74	-20.90	PK
Horizontal	15600.100	49.41	-7.82	41.59	54	-12.41	AV
High Channel (5240 MHz)-Above 1G							
Vertical	4739.192	74.62	-20.12	54.50	74	-19.50	PK
Vertical	4739.192	59.39	-20.12	39.27	54	-14.73	AV
Vertical	10480.086	64.09	-9.18	54.91	68.2	-13.29	PK
Vertical	10480.086	49.45	-9.18	40.27	54	-13.73	AV
Vertical	15720.142	61.63	-7.78	53.85	74	-20.15	PK
Vertical	15720.142	49.52	-7.78	41.74	54	-12.26	AV
Horizontal	4739.028	73.62	-20.12	53.50	74	-20.50	PK
Horizontal	4739.028	59.01	-20.12	38.89	54	-15.11	AV
Horizontal	10480.180	63.74	-9.18	54.56	68.2	-13.64	PK
Horizontal	10480.180	49.09	-9.18	39.91	54	-14.09	AV
Horizontal	15720.081	64.21	-7.78	56.43	74	-17.57	PK
Horizontal	15720.081	49.69	-7.78	41.91	54	-12.09	AV

Note: PK value is lower than the Average value limit, So average didn't record.
 The 26.5-40G amplitude of spurious emissions that are attenuated by more than 20dB below the permissible value has no need to be reported.
 Emission level (dBuV/m) = 20 log Emission level (uV/m).
 Corrected Reading: Antenna Factor + Cable Loss + Read Level - Preamp Factor = Level.
 Test Mode is MIMO Mode.

Test Mode:	TX(5.1G) - 802.11ac-HT40
------------	--------------------------

Polar (H/V)	Fre- quency (MHz)	Reading Level (dBuV/m)	Correct Factor (dB)	Measure- ment (dBuV/m)	Limits (dBuV/m)	Over (dB)	Detector Type
Low Channel (5190 MHz)-Above 1G							
Vertical	4434.088	73.07	-20.73	52.34	68.2	-15.86	PK
Vertical	4434.088	59.83	-20.73	39.10	54	-14.90	AV
Vertical	10380.179	64.50	-9.33	55.17	68.2	-13.03	PK
Vertical	10380.179	49.95	-9.33	40.62	54	-13.38	AV
Vertical	15570.133	63.81	-7.83	55.98	74	-18.02	PK
Vertical	15570.133	49.89	-7.83	42.06	54	-11.94	AV
Horizontal	4434.188	72.55	-20.73	51.82	74	-22.18	PK
Horizontal	4434.188	59.10	-20.73	38.36	54	-15.64	AV
Horizontal	10380.002	63.52	-9.33	54.19	68.2	-14.01	PK
Horizontal	10380.002	49.80	-9.33	40.47	54	-13.53	AV
Horizontal	15570.020	60.59	-7.83	52.76	74	-21.24	PK
Horizontal	15570.020	49.06	-7.83	41.23	54	-12.77	AV
High Channel (5230 MHz)-Above 1G							
Vertical	4739.176	70.04	-20.12	49.92	68.2	-18.28	PK
Vertical	4739.176	59.31	-20.12	39.19	54	-14.81	AV
Vertical	10460.074	63.83	-9.21	54.62	68.2	-13.58	PK
Vertical	10460.074	49.57	-9.21	40.36	54	-13.64	AV
Vertical	15690.101	62.78	-7.79	54.99	74	-19.01	PK
Vertical	15690.101	49.23	-7.79	41.44	54	-12.56	AV
Horizontal	4739.035	73.83	-20.12	53.71	68.2	-14.49	PK
Horizontal	4739.035	59.39	-20.12	39.27	54	-14.73	AV
Horizontal	10460.109	60.44	-9.21	51.23	68.2	-16.97	PK
Horizontal	10460.109	49.84	-9.21	40.63	54	-13.37	AV
Horizontal	15690.002	64.80	-7.79	57.01	74	-16.99	PK
Horizontal	15690.002	49.96	-7.79	42.17	54	-11.83	AV

Note: PK value is lower than the Average value limit, So average didn't record.
 The 26.5-40G amplitude of spurious emissions that are attenuated by more than 20dB below the permissible value has no need to be reported.
 Emission level (dBuV/m) = 20 log Emission level (uV/m).
 Corrected Reading: Antenna Factor + Cable Loss + Read Level - Preamp Factor = Level.
 Test Mode is MIMO Mode.

Test Mode:	TX(5.1G) - 802.11ac-HT80
------------	--------------------------

Polar (H/V)	Fre- quency (MHz)	Reading Level (dBuV/m)	Correct Factor (dB)	Measure- ment (dBuV/m)	Limits (dBuV/m)	Over (dB)	Detector Type
(5210 MHz)-Above 1G							
Vertical	4434.161	72.99	-20.73	52.26	68.2	-15.94	PK
Vertical	4434.161	59.84	-20.73	39.11	54	-14.89	AV
Vertical	10420.103	64.70	-9.27	55.43	68.2	-12.77	PK
Vertical	10420.103	49.12	-9.27	39.85	54	-14.15	AV
Vertical	15630.144	61.30	-7.81	53.49	74	-20.51	PK
Vertical	15630.144	49.95	-7.81	42.14	54	-11.86	AV
Horizontal	4434.088	72.32	-20.73	51.58	68.2	-16.62	PK
Horizontal	4434.088	49.66	-20.73	28.93	54	-25.07	AV
Horizontal	10420.028	41.63	9.27	50.90	68.2	-17.30	PK
Horizontal	10420.028	29.08	9.27	38.35	54	-15.65	AV
Horizontal	15630.097	64.03	-7.81	56.22	74	-17.78	PK
Horizontal	15630.097	49.74	-7.81	41.93	54	-12.07	AV

Note: PK value is lower than the Average value limit, So average didn't record.
 The 26.5-40G amplitude of spurious emissions that are attenuated by more than 20dB below the permissible value has no need to be reported.
 Emission level (dBuV/m) = 20 log Emission level (uV/m).
 Corrected Reading: Antenna Factor + Cable Loss + Read Level - Preamp Factor = Level.
 Test Mode is MIMO Mode.

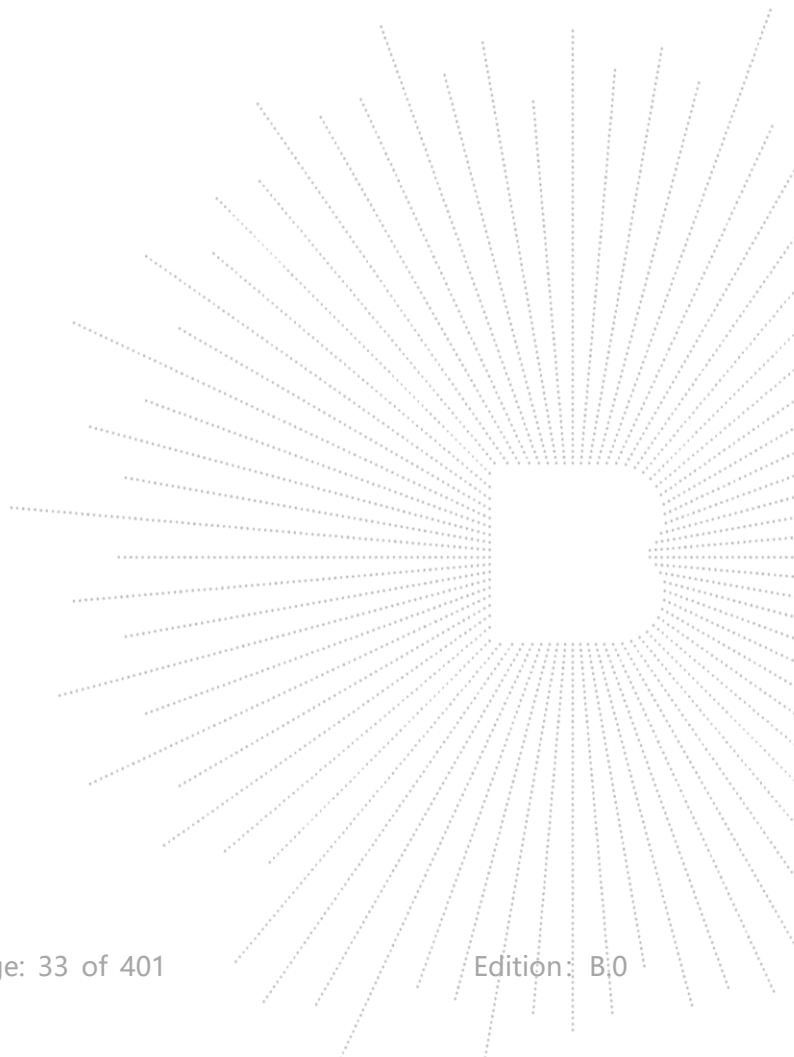

Test Mode:	TX(5.1G) - 802.11ax-HT20
------------	--------------------------

Polar	Fre- quency	Reading Level	Correct Factor	Measure- ment	Limits	Over	Detector Type
(H/V)	(MHz)	(dBuV/m)	(dB)	(dBuV/m)	(dBuV/m)	(dB)	
Low Channel (5180 MHz)-Above 1G							
Vertical	4434.053	74.51	-20.73	53.78	68.2	-14.42	PK
Vertical	4434.053	59.98	-20.73	39.25	54	-14.75	AV
Vertical	10360.080	64.31	-9.36	54.95	68.2	-13.25	PK
Vertical	10360.080	49.99	-9.36	40.63	54	-13.37	AV
Vertical	15540.085	61.86	-7.84	54.02	74	-19.98	PK
Vertical	15540.085	49.68	-7.84	41.84	54	-12.16	AV
Horizontal	4434.151	73.99	-20.73	53.26	68.2	-14.94	PK
Horizontal	4434.151	59.41	-20.73	38.68	54	-15.32	AV
Horizontal	10360.105	60.14	-9.36	50.78	68.2	-17.42	PK
Horizontal	10360.105	49.54	-9.36	40.18	54	-13.82	AV
Horizontal	15540.033	60.70	-7.84	52.86	74	-21.14	PK
Horizontal	15540.033	49.53	-7.84	41.69	54	-12.31	AV
middle Channel (5200 MHz)-Above 1G							
Vertical	4592.147	70.80	-20.42	50.39	74	-23.61	PK
Vertical	4592.147	59.92	-20.42	39.50	54	-14.50	AV
Vertical	10400.117	60.48	-9.30	51.18	68.2	-17.02	PK
Vertical	10400.117	49.25	-9.30	39.95	54	-14.05	AV
Vertical	15600.140	62.36	-7.82	54.54	74	-19.46	PK
Vertical	15600.140	49.32	-7.82	41.50	54	-12.50	AV
Horizontal	4592.060	73.54	-20.42	53.12	74	-20.88	PK
Horizontal	4592.060	59.97	-20.42	39.55	54	-14.45	AV
Horizontal	10400.171	60.48	-9.30	51.18	68.2	-17.02	PK
Horizontal	10400.171	49.40	-9.30	40.10	54	-13.90	AV
Horizontal	15600.005	63.64	-7.82	55.82	74	-18.18	PK
Horizontal	15600.005	49.37	-7.82	41.55	54	-12.45	AV
High Channel (5240 MHz)-Above 1G							
Vertical	4739.100	73.24	-20.12	53.12	74	-20.88	PK
Vertical	4739.100	59.39	-20.12	39.27	54	-14.73	AV
Vertical	10480.099	61.69	-9.18	52.51	68.2	-15.69	PK
Vertical	10480.099	49.95	-9.18	40.77	54	-13.23	AV
Vertical	15720.181	60.80	-7.78	53.02	74	-20.98	PK
Vertical	15720.181	49.30	-7.78	41.52	54	-12.48	AV
Horizontal	4739.162	71.83	-20.12	51.71	74	-22.29	PK
Horizontal	4739.162	59.85	-20.12	39.73	54	-14.27	AV
Horizontal	10480.019	62.79	-9.18	53.61	68.2	-14.59	PK
Horizontal	10480.019	49.25	-9.18	40.07	54	-13.93	AV
Horizontal	15720.159	61.79	-7.78	54.01	74	-19.99	PK
Horizontal	15720.159	49.15	-7.78	41.37	54	-12.63	AV

Note: PK value is lower than the Average value limit, So average didn't record.
 The 26.5-40G amplitude of spurious emissions that are attenuated by more than 20dB below the permissible value has no need to be reported.
 Emission level (dBuV/m) = 20 log Emission level (uV/m).
 Corrected Reading: Antenna Factor + Cable Loss + Read Level - Preamp Factor = Level.
 Test Mode is MIMO Mode.

Test Mode:	TX(5.1G) - 802.11ax-HT40
------------	--------------------------

Polar (H/V)	Fre- quency (MHz)	Reading Level (dBuV/m)	Correct Factor (dB)	Measure- ment (dBuV/m)	Limits (dBuV/m)	Over (dB)	Detector Type
Low Channel (5190 MHz)-Above 1G							
Vertical	4434.018	73.67	-20.73	52.94	68.2	-15.26	PK
Vertical	4434.018	59.96	-20.73	39.23	54	-14.77	AV
Vertical	10380.047	64.57	-9.33	55.24	68.2	-12.96	PK
Vertical	10380.047	49.02	-9.33	39.69	54	-14.31	AV
Vertical	15570.072	63.34	-7.83	55.51	74	-18.49	PK
Vertical	15570.072	49.47	-7.83	41.64	54	-12.36	AV
Horizontal	4434.022	71.32	-20.73	50.59	74	-23.41	PK
Horizontal	4434.022	59.12	-20.73	38.39	54	-15.61	AV
Horizontal	10380.055	62.48	-9.33	53.15	68.2	-15.05	PK
Horizontal	10380.055	49.71	-9.33	40.38	54	-13.62	AV
Horizontal	15570.063	64.53	-7.83	56.70	74	-17.30	PK
Horizontal	15570.063	49.83	-7.83	42.00	54	-12.00	AV
High Channel (5230 MHz)-Above 1G							
Vertical	4739.084	74.44	-20.12	54.32	68.2	-13.88	PK
Vertical	4739.084	59.69	-20.12	39.57	54	-14.43	AV
Vertical	10460.098	64.23	-9.21	55.02	68.2	-13.18	PK
Vertical	10460.098	49.47	-9.21	40.26	54	-13.74	AV
Vertical	15690.197	61.96	-7.79	54.17	74	-19.83	PK
Vertical	15690.197	49.35	-7.79	41.56	54	-12.44	AV
Horizontal	4739.152	72.58	-20.12	52.46	68.2	-15.74	PK
Horizontal	4739.152	59.79	-20.12	39.67	54	-14.33	AV
Horizontal	10460.086	63.49	-9.21	54.28	68.2	-13.92	PK
Horizontal	10460.086	49.33	-9.21	40.12	54	-13.88	AV
Horizontal	15690.038	60.77	-7.79	52.98	74	-21.02	PK
Horizontal	15690.038	49.62	-7.79	41.83	54	-12.17	AV

Note: PK value is lower than the Average value limit, So average didn't record.
 The 26.5-40G amplitude of spurious emissions that are attenuated by more than 20dB below the permissible value has no need to be reported.
 Emission level (dBuV/m) = 20 log Emission level (uV/m).
 Corrected Reading: Antenna Factor + Cable Loss + Read Level - Preamp Factor = Level.
 Test Mode is MIMO Mode.

Test Mode:	TX(5.1G) - 802.11ax-HT80
------------	--------------------------

Polar (H/V)	Fre- quency (MHz)	Reading Level (dBuV/m)	Correct Factor (dB)	Measure- ment (dBuV/m)	Limits (dBuV/m)	Over (dB)	Detector Type
(5210 MHz)-Above 1G							
Vertical	4434.048	71.72	-20.73	50.99	68.2	-17.21	PK
Vertical	4434.048	59.55	-20.73	38.82	54	-15.18	AV
Vertical	10420.039	60.31	-9.27	51.04	68.2	-17.16	PK
Vertical	10420.039	49.74	-9.27	40.47	54	-13.53	AV
Vertical	15630.101	61.06	-7.81	53.25	74	-20.75	PK
Vertical	15630.101	49.51	-7.81	41.70	54	-12.30	AV
Horizontal	4434.098	74.44	-20.73	53.71	68.2	-14.49	PK
Horizontal	4434.098	49.50	-20.73	28.77	54	-25.23	AV
Horizontal	10420.012	43.72	9.27	52.99	68.2	-15.21	PK
Horizontal	10420.012	29.65	9.27	38.92	54	-15.08	AV
Horizontal	15630.051	60.39	-7.81	52.58	74	-21.42	PK
Horizontal	15630.051	49.62	-7.81	41.81	54	-12.19	AV

Note: PK value is lower than the Average value limit, So average didn't record.
 The 26.5-40G amplitude of spurious emissions that are attenuated by more than 20dB below the permissible value has no need to be reported.
 Emission level (dBuV/m) = 20 log Emission level (uV/m).
 Corrected Reading: Antenna Factor + Cable Loss + Read Level - Preamp Factor = Level.
 Test Mode is MIMO Mode.

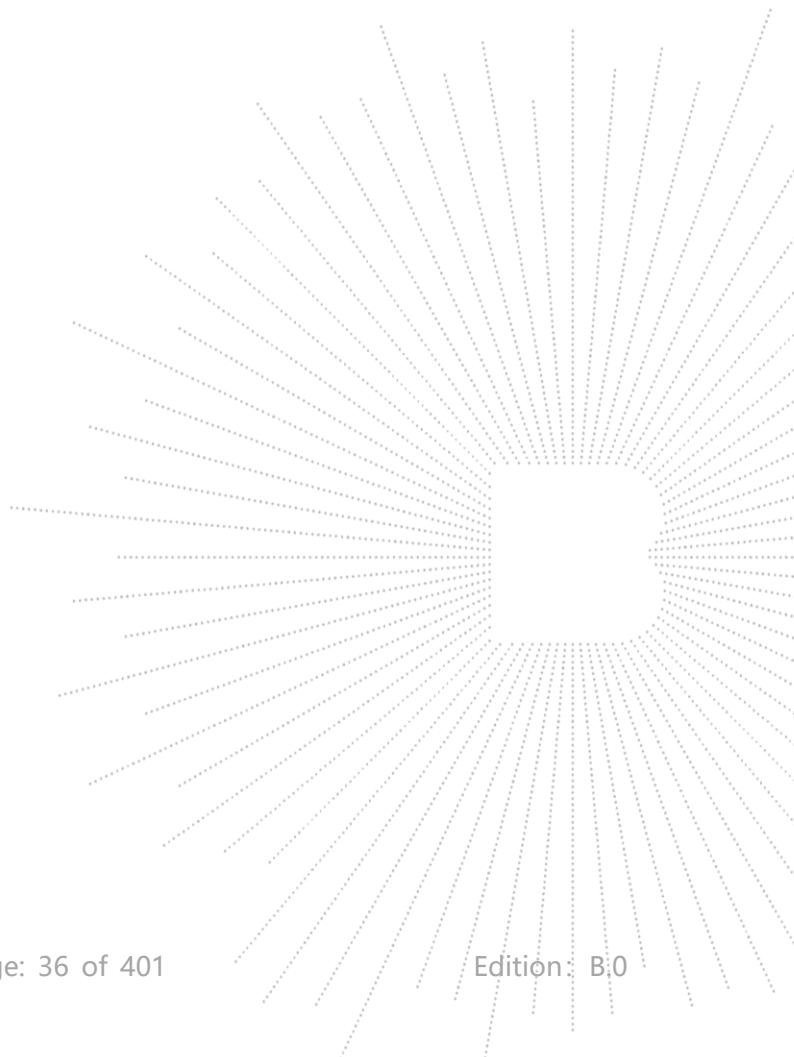

Test Mode:	TX(5.3G) - 802.11a
------------	--------------------

Polar (H/V)	Fre- quency (MHz)	Reading Level (dBuV/m)	Correct Factor (dB)	Measure- ment (dBuV/m)	Limits (dBuV/m)	Over (dB)	Detector Type
Low Channel (5260 MHz)-Above 1G							
Vertical	4434.070	72.22	-20.73	51.49	68.2	-16.71	PK
Vertical	4434.070	59.93	-20.73	39.20	54	-14.80	AV
Vertical	10520.014	61.19	-9.12	52.07	68.2	-16.13	PK
Vertical	10520.014	49.73	-9.12	40.61	54	-13.39	AV
Vertical	15780.142	62.51	-7.77	54.74	74	-19.26	PK
Vertical	15780.142	49.70	-7.77	41.93	54	-12.07	AV
Horizontal	4434.188	71.40	-20.73	50.67	68.2	-17.53	PK
Horizontal	4434.188	59.26	-20.73	38.53	54	-15.47	AV
Horizontal	10520.004	62.18	-9.12	53.06	68.2	-15.14	PK
Horizontal	10520.004	49.27	-9.12	40.15	54	-13.85	AV
Horizontal	15780.043	63.91	-7.77	56.14	74	-17.86	PK
Horizontal	15780.043	49.67	-7.77	41.90	54	-12.10	AV
middle Channel (5280 MHz)-Above 1G							
Vertical	4592.046	71.67	-20.42	51.26	74	-22.74	PK
Vertical	4592.046	59.55	-20.42	39.13	54	-14.87	AV
Vertical	10560.154	60.16	-9.06	51.10	68.2	-17.10	PK
Vertical	10560.154	49.96	-9.06	40.90	54	-13.10	AV
Vertical	15840.044	61.63	-7.75	53.88	74	-20.12	PK
Vertical	15840.044	49.51	-7.75	41.76	54	-12.24	AV
Horizontal	4592.167	71.70	-20.42	51.29	74	-22.71	PK
Horizontal	4592.167	59.72	-20.42	39.31	54	-14.69	AV
Horizontal	10560.086	64.67	-9.06	55.61	68.2	-12.59	PK
Horizontal	10560.086	49.48	-9.06	40.42	54	-13.58	AV
Horizontal	15840.106	62.70	-7.75	54.95	74	-19.05	PK
Horizontal	15840.106	49.11	-7.75	41.36	54	-12.64	AV
High Channel (5320 MHz)-Above 1G							
Vertical	4739.163	70.89	-20.12	50.76	74	-23.24	PK
Vertical	4739.163	59.38	-20.12	39.26	54	-14.74	AV
Vertical	10640.093	63.64	-8.94	54.70	68.2	-13.50	PK
Vertical	10640.093	49.56	-8.94	40.62	54	-13.38	AV
Vertical	15960.056	61.96	-7.71	54.25	74	-19.75	PK
Vertical	15960.056	49.88	-7.71	42.17	54	-11.83	AV
Horizontal	4739.048	73.63	-20.12	53.50	74	-20.50	PK
Horizontal	4739.048	59.00	-20.12	38.88	54	-15.12	AV
Horizontal	10640.028	60.42	-8.94	51.48	68.2	-16.72	PK
Horizontal	10640.028	49.71	-8.94	40.77	54	-13.23	AV
Horizontal	15960.090	63.50	-7.71	55.79	74	-18.21	PK
Horizontal	15960.090	49.06	-7.71	41.35	54	-12.65	AV

Note: PK value is lower than the Average value limit, So average didn't record.
 The 26.5-40G amplitude of spurious emissions that are attenuated by more than 20dB below the permissible value has no need to be reported.
 Emission level (dBuV/m) = 20 log Emission level (uV/m).
 Corrected Reading: Antenna Factor + Cable Loss + Read Level - Preamp Factor = Level.
 The worst case is Antenna A.

Test Mode:	TX(5.3G) - 802.11n-HT20
------------	-------------------------

Polar (H/V)	Fre- quency (MHz)	Reading Level (dBuV/m)	Correct Factor (dB)	Measure- ment (dBuV/m)	Limits (dBuV/m)	Over (dB)	Detector Type
Low Channel (5260 MHz)-Above 1G							
Vertical	4434.110	73.58	-20.73	52.85	68.2	-15.35	PK
Vertical	4434.110	59.68	-20.73	38.94	54	-15.06	AV
Vertical	10520.128	61.92	-9.12	52.80	68.2	-15.40	PK
Vertical	10520.128	49.37	-9.12	40.25	54	-13.75	AV
Vertical	15780.133	62.82	-7.77	55.05	74	-18.95	PK
Vertical	15780.133	49.17	-7.77	41.40	54	-12.60	AV
Horizontal	4434.146	71.11	-20.73	50.38	68.2	-17.82	PK
Horizontal	4434.146	59.39	-20.73	38.65	54	-15.35	AV
Horizontal	10520.162	61.91	-9.12	52.79	68.2	-15.41	PK
Horizontal	10520.162	49.21	-9.12	40.09	54	-13.91	AV
Horizontal	15780.017	61.66	-7.77	53.89	74	-20.11	PK
Horizontal	15780.017	49.64	-7.77	41.87	54	-12.13	AV
middle Channel (5280 MHz)-Above 1G							
Vertical	4592.022	73.60	-20.42	53.18	74	-20.82	PK
Vertical	4592.022	59.03	-20.42	38.61	54	-15.39	AV
Vertical	10560.065	64.14	-9.06	55.08	68.2	-13.12	PK
Vertical	10560.065	49.51	-9.06	40.45	54	-13.55	AV
Vertical	15840.131	60.28	-7.75	52.53	74	-21.47	PK
Vertical	15840.131	49.05	-7.75	41.30	54	-12.70	AV
Horizontal	4592.024	71.66	-20.42	51.25	74	-22.75	PK
Horizontal	4592.024	59.66	-20.42	39.25	54	-14.75	AV
Horizontal	10560.005	62.01	-9.06	52.95	68.2	-15.25	PK
Horizontal	10560.005	49.34	-9.06	40.28	54	-13.72	AV
Horizontal	15840.168	63.37	-7.75	55.62	74	-18.38	PK
Horizontal	15840.168	49.90	-7.75	42.15	54	-11.85	AV
High Channel (5320 MHz)-Above 1G							
Vertical	4739.124	74.04	-20.12	53.92	74	-20.08	PK
Vertical	4739.124	59.13	-20.12	39.00	54	-15.00	AV
Vertical	10640.002	64.04	-8.94	55.10	68.2	-13.10	PK
Vertical	10640.002	49.86	-8.94	40.92	54	-13.08	AV
Vertical	15960.007	63.00	-7.71	55.29	74	-18.71	PK
Vertical	15960.007	49.13	-7.71	41.42	54	-12.58	AV
Horizontal	4739.100	70.18	-20.12	50.05	74	-23.95	PK
Horizontal	4739.100	59.61	-20.12	39.49	54	-14.51	AV
Horizontal	10640.169	61.36	-8.94	52.42	68.2	-15.78	PK
Horizontal	10640.169	49.16	-8.94	40.22	54	-13.78	AV
Horizontal	15960.184	62.68	-7.71	54.97	74	-19.03	PK
Horizontal	15960.184	49.47	-7.71	41.76	54	-12.24	AV

Note: PK value is lower than the Average value limit, So average didn't record.
 The 26.5-40G amplitude of spurious emissions that are attenuated by more than 20dB below the permissible value has no need to be reported.
 Emission level (dBuV/m) = 20 log Emission level (uV/m).
 Corrected Reading: Antenna Factor + Cable Loss + Read Level - Preamp Factor = Level.
 Test Mode is MIMO Mode.

Test Mode:	TX(5.3G) - 802.11n-HT40
------------	-------------------------

Polar (H/V)	Fre- quency (MHz)	Reading Level (dBuV/m)	Correct Factor (dB)	Measure- ment (dBuV/m)	Limits (dBuV/m)	Over (dB)	Detector Type
Low Channel (5270 MHz)-Above 1G							
Vertical	4434.189	73.26	-20.73	52.53	68.2	-15.67	PK
Vertical	4434.189	59.60	-20.73	38.87	54	-15.13	AV
Vertical	10540.108	64.95	-9.09	55.86	68.2	-12.34	PK
Vertical	10540.108	49.49	-9.09	40.40	54	-13.60	AV
Vertical	15810.181	62.14	-7.76	54.38	74	-19.62	PK
Vertical	15810.181	49.56	-7.76	41.80	54	-12.20	AV
Horizontal	4434.106	71.99	-20.73	51.26	74	-22.74	PK
Horizontal	4434.106	59.28	-20.73	38.55	54	-15.45	AV
Horizontal	10540.074	64.74	-9.09	55.65	68.2	-12.55	PK
Horizontal	10540.074	49.32	-9.09	40.23	54	-13.77	AV
Horizontal	15810.115	60.31	-7.76	52.55	74	-21.45	PK
Horizontal	15810.115	49.22	-7.76	41.46	54	-12.54	AV
High Channel (5310 MHz)-Above 1G							
Vertical	4739.001	71.89	-20.12	51.77	68.2	-16.43	PK
Vertical	4739.001	59.49	-20.12	39.36	54	-14.64	AV
Vertical	10620.009	63.85	-8.97	54.88	68.2	-13.32	PK
Vertical	10620.009	49.70	-8.97	40.73	54	-13.27	AV
Vertical	15930.034	64.93	-7.72	57.21	74	-16.79	PK
Vertical	15930.034	49.08	-7.72	41.36	54	-12.64	AV
Horizontal	4739.124	70.11	-20.12	49.99	68.2	-18.21	PK
Horizontal	4739.124	60.00	-20.12	39.88	54	-14.12	AV
Horizontal	10620.188	64.45	-8.97	55.48	68.2	-12.72	PK
Horizontal	10620.188	49.28	-8.97	40.31	54	-13.69	AV
Horizontal	15930.153	64.57	-7.72	56.85	74	-17.15	PK
Horizontal	15930.153	49.48	-7.72	41.76	54	-12.24	AV

Note: PK value is lower than the Average value limit, So average didn't record.
 The 26.5-40G amplitude of spurious emissions that are attenuated by more than 20dB below the permissible value has no need to be reported.
 Emission level (dBuV/m) = 20 log Emission level (uV/m).
 Corrected Reading: Antenna Factor + Cable Loss + Read Level - Preamp Factor = Level.
 Test Mode is MIMO Mode.

Test Mode:	TX(5.3G) - 802.11ac-HT20
------------	--------------------------

Polar (H/V)	Fre- quency (MHz)	Reading Level (dBuV/m)	Correct Factor (dB)	Measure- ment (dBuV/m)	Limits (dBuV/m)	Over (dB)	Detector Type
Low Channel (5260 MHz)-Above 1G							
Vertical	4434.140	72.94	-20.73	52.21	68.2	-15.99	PK
Vertical	4434.140	59.30	-20.73	38.57	54	-15.43	AV
Vertical	10520.105	61.60	-9.12	52.48	68.2	-15.72	PK
Vertical	10520.105	49.49	-9.12	40.37	54	-13.63	AV
Vertical	15780.150	62.87	-7.77	55.10	74	-18.90	PK
Vertical	15780.150	49.98	-7.77	42.21	54	-11.79	AV
Horizontal	4434.126	71.93	-20.73	51.20	68.2	-17.00	PK
Horizontal	4434.126	59.62	-20.73	38.88	54	-15.12	AV
Horizontal	10520.088	64.70	-9.12	55.58	68.2	-12.62	PK
Horizontal	10520.088	49.17	-9.12	40.05	54	-13.95	AV
Horizontal	15780.025	64.21	-7.77	56.44	74	-17.56	PK
Horizontal	15780.025	49.66	-7.77	41.89	54	-12.11	AV
middle Channel (5280 MHz)-Above 1G							
Vertical	4592.003	73.93	-20.42	53.51	74	-20.49	PK
Vertical	4592.003	59.74	-20.42	39.32	54	-14.68	AV
Vertical	10560.153	60.52	-9.06	51.46	68.2	-16.74	PK
Vertical	10560.153	49.78	-9.06	40.72	54	-13.28	AV
Vertical	15840.065	62.53	-7.75	54.78	74	-19.22	PK
Vertical	15840.065	49.45	-7.75	41.70	54	-12.30	AV
Horizontal	4592.041	71.08	-20.42	50.66	74	-23.34	PK
Horizontal	4592.041	59.28	-20.42	38.87	54	-15.13	AV
Horizontal	10560.014	60.92	-9.06	51.86	68.2	-16.34	PK
Horizontal	10560.014	49.59	-9.06	40.53	54	-13.47	AV
Horizontal	15840.059	64.72	-7.75	56.97	74	-17.03	PK
Horizontal	15840.059	49.65	-7.75	41.90	54	-12.10	AV
High Channel (5320 MHz)-Above 1G							
Vertical	4739.186	74.22	-20.12	54.10	74	-19.90	PK
Vertical	4739.186	59.86	-20.12	39.74	54	-14.26	AV
Vertical	10640.138	62.45	-8.94	53.51	68.2	-14.69	PK
Vertical	10640.138	49.63	-8.94	40.69	54	-13.31	AV
Vertical	15960.171	63.37	-7.71	55.66	74	-18.34	PK
Vertical	15960.171	49.82	-7.71	42.11	54	-11.89	AV
Horizontal	4739.170	73.75	-20.12	53.63	74	-20.37	PK
Horizontal	4739.170	59.77	-20.12	39.65	54	-14.35	AV
Horizontal	10640.153	62.21	-8.94	53.27	68.2	-14.93	PK
Horizontal	10640.153	49.45	-8.94	40.51	54	-13.49	AV
Horizontal	15960.185	63.90	-7.71	56.19	74	-17.81	PK
Horizontal	15960.185	49.08	-7.71	41.37	54	-12.63	AV

Note: PK value is lower than the Average value limit, So average didn't record.
 The 26.5-40G amplitude of spurious emissions that are attenuated by more than 20dB below the permissible value has no need to be reported.
 Emission level (dBuV/m) = 20 log Emission level (uV/m).
 Corrected Reading: Antenna Factor + Cable Loss + Read Level - Preamp Factor = Level.
 Test Mode is MIMO Mode.

Test Mode:	TX(5.3G) - 802.11ac-HT40
------------	--------------------------

Polar (H/V)	Fre- quency (MHz)	Reading Level (dBuV/m)	Correct Factor (dB)	Measure- ment (dBuV/m)	Limits (dBuV/m)	Over (dB)	Detector Type
Low Channel (5270 MHz)-Above 1G							
Vertical	4434.129	72.07	-20.73	51.34	68.2	-16.86	PK
Vertical	4434.129	59.06	-20.73	38.32	54	-15.68	AV
Vertical	10540.040	60.82	-9.09	51.73	68.2	-16.47	PK
Vertical	10540.040	49.85	-9.09	40.76	54	-13.24	AV
Vertical	15810.066	61.98	-7.76	54.22	74	-19.78	PK
Vertical	15810.066	49.49	-7.76	41.73	54	-12.27	AV
Horizontal	4434.125	74.49	-20.73	53.76	74	-20.24	PK
Horizontal	4434.125	59.65	-20.73	38.92	54	-15.08	AV
Horizontal	10540.081	62.46	-9.09	53.37	68.2	-14.83	PK
Horizontal	10540.081	49.91	-9.09	40.82	54	-13.18	AV
Horizontal	15810.041	62.56	-7.76	54.80	74	-19.20	PK
Horizontal	15810.041	49.08	-7.76	41.32	54	-12.68	AV
High Channel (5310 MHz)-Above 1G							
Vertical	4739.147	74.02	-20.12	53.90	68.2	-14.30	PK
Vertical	4739.147	59.82	-20.12	39.70	54	-14.30	AV
Vertical	10620.149	63.72	-8.97	54.75	68.2	-13.45	PK
Vertical	10620.149	49.91	-8.97	40.94	54	-13.06	AV
Vertical	15930.112	60.48	-7.72	52.76	74	-21.24	PK
Vertical	15930.112	49.35	-7.72	41.63	54	-12.37	AV
Horizontal	4739.083	74.51	-20.12	54.39	68.2	-13.81	PK
Horizontal	4739.083	59.72	-20.12	39.59	54	-14.41	AV
Horizontal	10620.071	64.32	-8.97	55.35	68.2	-12.85	PK
Horizontal	10620.071	49.40	-8.97	40.43	54	-13.57	AV
Horizontal	15930.095	64.27	-7.72	56.55	74	-17.45	PK
Horizontal	15930.095	49.79	-7.72	42.07	54	-11.93	AV

Note: PK value is lower than the Average value limit, So average didn't record.
 The 26.5-40G amplitude of spurious emissions that are attenuated by more than 20dB below the permissible value has no need to be reported.
 Emission level (dBuV/m) = 20 log Emission level (uV/m).
 Corrected Reading: Antenna Factor + Cable Loss + Read Level - Preamp Factor = Level.
 Test Mode is MIMO Mode.

Test Mode:	TX(5.3G) - 802.11ac-HT80
------------	--------------------------

Polar (H/V)	Fre- quency (MHz)	Reading Level (dBuV/m)	Correct Factor (dB)	Measure- ment (dBuV/m)	Limits (dBuV/m)	Over (dB)	Detector Type
(5290 MHz)-Above 1G							
Vertical	4434.051	72.52	-20.73	51.79	68.2	-16.41	PK
Vertical	4434.051	59.66	-20.73	38.92	54	-15.08	AV
Vertical	10580.017	61.78	-9.03	52.75	68.2	-15.45	PK
Vertical	10580.017	49.31	-9.03	40.28	54	-13.72	AV
Vertical	15870.023	60.44	-7.74	52.70	74	-21.30	PK
Vertical	15870.023	49.89	-7.74	42.15	54	-11.85	AV
Horizontal	4434.073	72.18	-20.73	51.45	68.2	-16.75	PK
Horizontal	4434.073	59.72	-20.73	38.99	54	-15.01	AV
Horizontal	10580.072	63.49	-9.03	54.46	68.2	-13.74	PK
Horizontal	10580.072	49.77	-9.03	40.74	54	-13.26	AV
Horizontal	15870.028	63.03	-7.74	55.29	74	-18.71	PK
Horizontal	15870.028	49.86	-7.74	42.12	54	-11.88	AV

Note: PK value is lower than the Average value limit, So average didn't record.
 The 26.5-40G amplitude of spurious emissions that are attenuated by more than 20dB below the permissible value has no need to be reported.
 Emission level (dBuV/m) = 20 log Emission level (uV/m).
 Corrected Reading: Antenna Factor + Cable Loss + Read Level - Preamp Factor = Level.
 Test Mode is MIMO Mode.

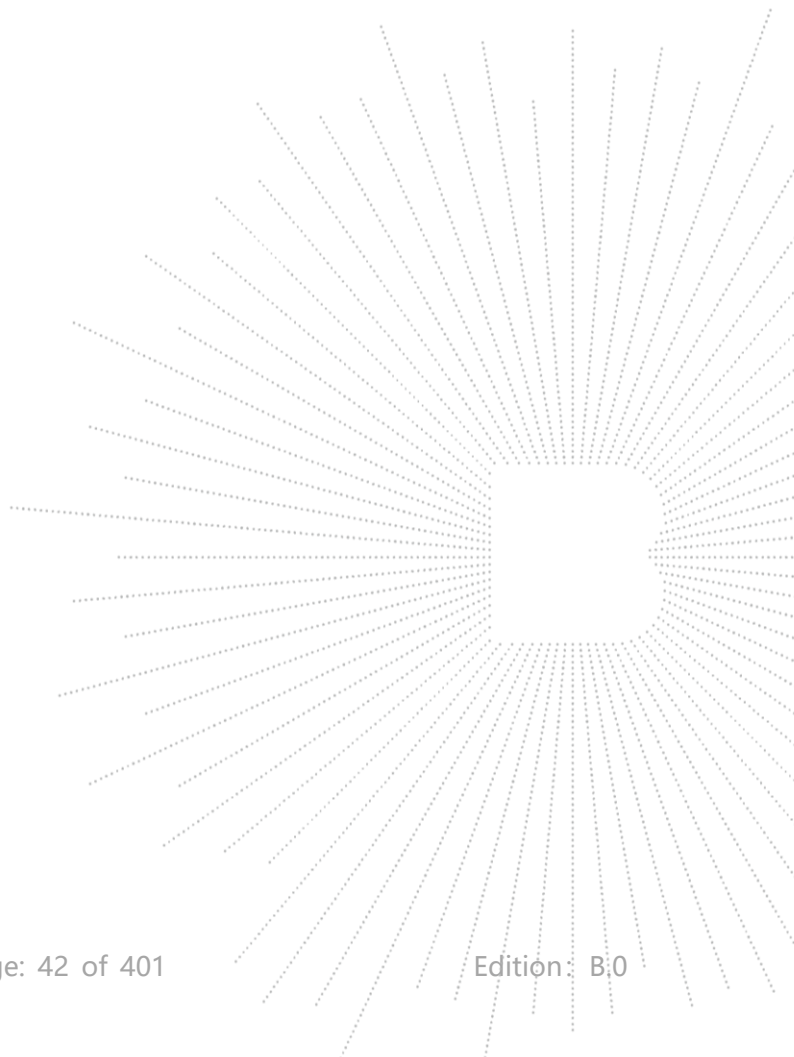

Test Mode:	TX(5.3G) - 802.11ax-HT20
------------	--------------------------

Polar (H/V)	Fre- quency (MHz)	Reading Level (dBuV/m)	Correct Factor (dB)	Measure- ment (dBuV/m)	Limits (dBuV/m)	Over (dB)	Detector Type
Low Channel (5260 MHz)-Above 1G							
Vertical	4434.186	70.79	-20.73	50.06	68.2	-18.14	PK
Vertical	4434.186	59.76	-20.73	39.03	54	-14.97	AV
Vertical	10520.098	63.40	-9.12	54.28	68.2	-13.92	PK
Vertical	10520.098	49.46	-9.12	40.34	54	-13.66	AV
Vertical	15780.165	62.04	-7.77	54.27	74	-19.73	PK
Vertical	15780.165	49.52	-7.77	41.75	54	-12.25	AV
Horizontal	4434.151	71.08	-20.73	50.35	68.2	-17.85	PK
Horizontal	4434.151	59.29	-20.73	38.56	54	-15.44	AV
Horizontal	10520.090	62.89	-9.12	53.77	68.2	-14.43	PK
Horizontal	10520.090	49.90	-9.12	40.78	54	-13.22	AV
Horizontal	15780.104	63.05	-7.77	55.28	74	-18.72	PK
Horizontal	15780.104	49.29	-7.77	41.52	54	-12.48	AV
middle Channel (5280 MHz)-Above 1G							
Vertical	4592.100	71.14	-20.42	50.72	74	-23.28	PK
Vertical	4592.100	59.27	-20.42	38.85	54	-15.15	AV
Vertical	10560.161	63.15	-9.06	54.09	68.2	-14.11	PK
Vertical	10560.161	49.78	-9.06	40.72	54	-13.28	AV
Vertical	15840.128	63.75	-7.75	56.00	74	-18.00	PK
Vertical	15840.128	49.84	-7.75	42.09	54	-11.91	AV
Horizontal	4592.195	72.36	-20.42	51.95	74	-22.05	PK
Horizontal	4592.195	59.33	-20.42	38.91	54	-15.09	AV
Horizontal	10560.085	62.88	-9.06	53.82	68.2	-14.38	PK
Horizontal	10560.085	49.30	-9.06	40.24	54	-13.76	AV
Horizontal	15840.007	64.43	-7.75	56.68	74	-17.32	PK
Horizontal	15840.007	49.43	-7.75	41.68	54	-12.32	AV
High Channel (5320 MHz)-Above 1G							
Vertical	4739.042	70.75	-20.12	50.62	74	-23.38	PK
Vertical	4739.042	59.22	-20.12	39.09	54	-14.91	AV
Vertical	10640.049	60.08	-8.94	51.14	68.2	-17.06	PK
Vertical	10640.049	49.20	-8.94	40.26	54	-13.74	AV
Vertical	15960.040	64.63	-7.71	56.92	74	-17.08	PK
Vertical	15960.040	49.27	-7.71	41.56	54	-12.44	AV
Horizontal	4739.127	70.63	-20.12	50.51	74	-23.49	PK
Horizontal	4739.127	59.41	-20.12	39.29	54	-14.71	AV
Horizontal	10640.166	64.20	-8.94	55.26	68.2	-12.94	PK
Horizontal	10640.166	49.75	-8.94	40.81	54	-13.19	AV
Horizontal	15960.052	63.87	-7.71	56.16	74	-17.84	PK
Horizontal	15960.052	49.72	-7.71	42.01	54	-11.99	AV

Note: PK value is lower than the Average value limit, So average didn't record.
 The 26.5-40G amplitude of spurious emissions that are attenuated by more than 20dB below the permissible value has no need to be reported.
 Emission level (dBuV/m) = 20 log Emission level (uV/m).
 Corrected Reading: Antenna Factor + Cable Loss + Read Level - Preamp Factor = Level.
 Test Mode is MIMO Mode.

Test Mode:	TX(5.3G) - 802.11ax-HT40
------------	--------------------------

Polar (H/V)	Fre- quency (MHz)	Reading Level (dBuV/m)	Correct Factor (dB)	Measure- ment (dBuV/m)	Limits (dBuV/m)	Over (dB)	Detector Type
Low Channel (5270 MHz)-Above 1G							
Vertical	4434.010	74.98	-20.73	54.25	68.2	-13.95	PK
Vertical	4434.010	59.50	-20.73	38.77	54	-15.23	AV
Vertical	10540.097	61.30	-9.09	52.21	68.2	-15.99	PK
Vertical	10540.097	49.44	-9.09	40.35	54	-13.65	AV
Vertical	15810.134	62.33	-7.76	54.57	74	-19.43	PK
Vertical	15810.134	49.25	-7.76	41.49	54	-12.51	AV
Horizontal	4434.034	73.72	-20.73	52.99	74	-21.01	PK
Horizontal	4434.034	59.64	-20.73	38.91	54	-15.09	AV
Horizontal	10540.182	62.82	-9.09	53.73	68.2	-14.47	PK
Horizontal	10540.182	49.85	-9.09	40.76	54	-13.24	AV
Horizontal	15810.098	61.76	-7.76	54.00	74	-20.00	PK
Horizontal	15810.098	49.62	-7.76	41.86	54	-12.14	AV
High Channel (5310 MHz)-Above 1G							
Vertical	4739.072	71.33	-20.12	51.21	68.2	-16.99	PK
Vertical	4739.072	59.85	-20.12	39.73	54	-14.27	AV
Vertical	10620.185	63.34	-8.97	54.37	68.2	-13.83	PK
Vertical	10620.185	49.10	-8.97	40.13	54	-13.87	AV
Vertical	15930.130	64.40	-7.72	56.68	74	-17.32	PK
Vertical	15930.130	49.63	-7.72	41.91	54	-12.09	AV
Horizontal	4739.063	70.38	-20.12	50.26	68.2	-17.94	PK
Horizontal	4739.063	59.84	-20.12	39.71	54	-14.29	AV
Horizontal	10620.021	62.24	-8.97	53.27	68.2	-14.93	PK
Horizontal	10620.021	49.13	-8.97	40.16	54	-13.84	AV
Horizontal	15930.100	62.69	-7.72	54.97	74	-19.03	PK
Horizontal	15930.100	49.46	-7.72	41.74	54	-12.26	AV

Note: PK value is lower than the Average value limit, So average didn't record.
 The 26.5-40G amplitude of spurious emissions that are attenuated by more than 20dB below the permissible value has no need to be reported.
 Emission level (dBuV/m) = 20 log Emission level (uV/m).
 Corrected Reading: Antenna Factor + Cable Loss + Read Level - Preamp Factor = Level.
 Test Mode is MIMO Mode.