

TEST REPORT

Product Name : Mi Smart Projector 2
Model Number : XMTYY02FMGL,XMTYY**FMGL(*=0-9)
FCC ID : 2AZNP-XMTYY02FMGL2

Prepared for : Formovie (Chongqing) Innovative Technology Co., Ltd.
Address : 4-401, #2 Longgang Road, Guojiatuo Area, Jiangbei District, Chongqing, China

Prepared by : EMTEK (SHENZHEN) CO., LTD.
Address : Building 69, Majialong Industry Zone, Nanshan District, Shenzhen, Guangdong, China

Tel: (0755) 26954280
Fax: (0755) 26954282

Report Number : ENS2111080078W00404R
Date(s) of Tests : November 09, 2021 to November 22, 2021
Date of issue : November 22, 2021

1 TEST RESULT CERTIFICATION

Applicant : Formovie (Chongqing) Innovative Technology Co., Ltd.
 Address : 4-401, #2 Longgang Road, Guojiatuo Area, Jiangbei District, Chongqing, China
 Manufacturer : Formovie (Chongqing) Innovative Technology Co., Ltd.
 Address : 4-401, #2 Longgang Road, Guojiatuo Area, Jiangbei District, Chongqing, China
 EUT : Mi Smart Projector 2
 Model Name : XMTYY02FMGL,XMTYY**FMGL (*=0-9)
 Trademark : mi , Xiaomi

Measurement Procedure Used:

APPLICABLE STANDARDS	
STANDARD	TEST RESULT
FCC 47 CFR Part 2, Subpart J FCC 47 CFR Part 15, Subpart E	PASS

The above equipment was tested by EMTEK (SHENZHEN) CO., LTD. The test data, data evaluation, test procedures, and equipment configurations shown in this report were made in accordance with the procedures given in ANSI C63.10 (2013) and the energy emitted by the sample EUT tested as described in this report is in compliance with the requirements of FCC Rules Part 2 and Part 15.407

The test results of this report relate only to the tested sample identified in this report.

Date of Test : November 09, 2021 to November 22, 2021

Prepared by : 
 Luo peiye /Editor

Reviewer : 
 Joe Xia /Supervisor

Approve & Authorized Signer : 
 Lisa Wang/Manager

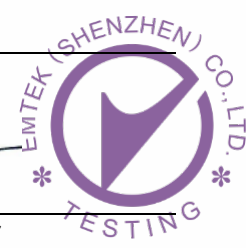

Modified History

Version	Report No.	Revision Date	Summary
V1.0	ENS2111080078W00404R	/	Original Report



TABLE OF CONTENTS

1	TEST RESULT CERTIFICATION	2
2	EUT TECHNICAL DESCRIPTION	5
3	SUMMARY OF TEST RESULT	7
4	TEST METHODOLOGY	8
4.1	GENERAL DESCRIPTION OF APPLIED STANDARDS.....	8
4.2	MEASUREMENT EQUIPMENT USED.....	8
4.3	DESCRIPTION OF TEST MODES.....	10
5	FACILITIES AND ACCREDITATIONS	14
5.1	FACILITIES.....	14
5.2	EQUIPMENT.....	14
5.3	LABORATORY ACCREDITATIONS AND LISTINGS.....	14
6	TEST SYSTEM UNCERTAINTY	15
7	SETUP OF EQUIPMENT UNDER TEST	16
7.1	RADIO FREQUENCY TEST SETUP.....	16
7.2	RADIO FREQUENCY TEST SETUP.....	16
7.3	CONDUCTED EMISSION TEST SETUP.....	18
7.4	BLOCK DIAGRAM CONFIGURATION OF TEST SYSTEM.....	19
7.5	SUPPORT EQUIPMENT.....	19
8	TEST REQUIREMENTS	20
8.1	BANDWIDTH MEASUREMENT.....	20
8.2	MAXIMUM CONDUCTED OUTPUT POWER.....	61
8.3	MAXIMUM PEAK POWER DENSITY.....	71
8.4	FREQUENCY STABILITY.....	141
8.5	UNDESIRABLE RADIATED SPURIOUS EMISSION.....	150
8.6	POWER LINE CONDUCTED EMISSIONS.....	179
8.7	ANTENNA APPLICATION.....	182

2 EUT TECHNICAL DESCRIPTION

Characteristics	Description	
Product:	Mi Smart Projector 2	
Model Number:	XMTYY02FMGL,XMTYY**FMGL (*=0-9) (These models are identical in circuitry and electrical, mechanical and physical construction; Only indicates for different market purposes; We chose XMTYY02FMGL as the final test prototype)	
Sample Number:	2#	
Wifi Type:	<input checked="" type="checkbox"/> Wifi 5G with 5150MHz-5250MHz Band <input checked="" type="checkbox"/> Wifi 5G with 5250MHz-5350MHz Band <input checked="" type="checkbox"/> Wifi 5G with 5470MHz-5725MHz Band <input checked="" type="checkbox"/> Wifi 5G with 5725MHz-5850MHz Band	
WLAN Supported:	<input checked="" type="checkbox"/> 802.11a <input checked="" type="checkbox"/> 802.11n(20MHz channel bandwidth) <input checked="" type="checkbox"/> 802.11n(40MHz channel bandwidth) <input checked="" type="checkbox"/> 802.11ac(20MHz channel bandwidth) <input checked="" type="checkbox"/> 802.11ac(40MHz channel bandwidth) <input checked="" type="checkbox"/> 802.11ac(80MHz channel bandwidth)	
Data Rate :	<input checked="" type="checkbox"/> 802.11a:54/48/36/24/18/12/9/6Mbps <input checked="" type="checkbox"/> 802.11n:up to 300 Mbps <input checked="" type="checkbox"/> 802.11ac:up to 867 Mbps	
Modulation:	<input checked="" type="checkbox"/> OFDM with BPSK/QPSK/16QAM/64QAM for 802.11a/n <input checked="" type="checkbox"/> OFDM with BPSK/QPSK/16QAM/64QAM/256QAM for 802.11ac	
Frequency Range:	<input checked="" type="checkbox"/> UNII-1: 5150MHz-5250MHz Band	
	<input checked="" type="checkbox"/> 5180-5240MHz for 802.11a; <input checked="" type="checkbox"/> 5180-5240MHz for 802.11n(HT20); <input checked="" type="checkbox"/> 5180-5240MHz for 802.11ac(HT20);	<input checked="" type="checkbox"/> 5190-5230MHz for 802.11n(HT40); <input checked="" type="checkbox"/> 5190-5230MHz for 802.11ac(HT40); <input checked="" type="checkbox"/> 5210MHz for 802.11ac(HT80);
	<input checked="" type="checkbox"/> UNII-2A: 5250MHz-5350MHz Band	
	<input checked="" type="checkbox"/> 5260-5320MHz for 802.11a; <input checked="" type="checkbox"/> 5260-5320MHz for 802.11n(HT20); <input checked="" type="checkbox"/> 5260-5320MHz for 802.11ac(HT20);	<input checked="" type="checkbox"/> 5270-5310MHz for 802.11n(HT40); <input checked="" type="checkbox"/> 5270-5310MHz for 802.11ac(HT40); <input checked="" type="checkbox"/> 5290MHz for 802.11ac(HT80);
	<input checked="" type="checkbox"/> UNII-2C: 5470MHz-5725MHz Band	
	<input checked="" type="checkbox"/> 5500-5700MHz for 802.11a; <input checked="" type="checkbox"/> 5500-5700MHz for 802.11n(HT20); <input checked="" type="checkbox"/> 5500-5700MHz for 802.11ac(HT20);	<input checked="" type="checkbox"/> 5510-5670MHz for 802.11n(HT40); <input checked="" type="checkbox"/> 5510-5670MHz for 802.11ac(HT40); <input checked="" type="checkbox"/> 5530MHz for 802.11ac(HT80);
	<input checked="" type="checkbox"/> UNII-3 with 5725MHz-5850MHz Band	
	<input checked="" type="checkbox"/> 5745-5825MHz for 802.11a; <input checked="" type="checkbox"/> 5745-5825MHz for 802.11n(HT20); <input checked="" type="checkbox"/> 5745-5825MHz for 802.11ac(HT20);	<input checked="" type="checkbox"/> 5755-5795MHz for 802.11n(HT40); <input checked="" type="checkbox"/> 5755-5795MHz for 802.11ac(HT40); <input checked="" type="checkbox"/> 5775MHz for 802.11ac(HT80);
TPC Function:	<input type="checkbox"/> Applicable <input checked="" type="checkbox"/> Not Applicable	

Antenna Port:	<input checked="" type="checkbox"/> Antenna port 1 <input checked="" type="checkbox"/> Antenna port 2
Antenna Type:	FPC Antenna
Antenna Gain:	<input checked="" type="checkbox"/> ANT 1: 5.34 dBi <input checked="" type="checkbox"/> ANT 2: 5.57 dBi
Transmit Power:	5150MHz-5250MHz : 11.64 dBm 5250MHz-5350MHz : 14.82 dBm 5470MHz-5725MHz : 15.13 dBm 5725MHz-5850MHz : 13.83 dBm
Power Supply :	DC 19V from Adapter
Adapter :	Model: DSA-65PFG-19FUS Input: AC100-240, 50Hz/60Hz,2.0A Output: DC19V,3.42A,64.98W
Date of Received:	November 09, 2021
Temperature Range:	0°C ~ 40°C

Note: For more details, please refer to the User's manual of the EUT.

3 SUMMARY OF TEST RESULT

FCC Part Clause	Test Parameter	Verdict	Remark
15.407 (a) 15.407 (e)	99% , 6dB and 26dB Bandwidth	PASS	
15.407 (a)	Maximum Conducted Output Power	PASS	
15.407 (a)	Peak Power Spectral Density	PASS	
15.407 (b)	Radiated Spurious Emission	PASS	
15.407(g)	Frequency Stability	PASS	
15.407 (b)(6) 15.207	Power Line Conducted Emission	PASS	
15.407(a) 15.203	Antenna Application	PASS	
<p>NOTE1: N/A (Not Applicable) NOTE2: According to FCC OET KDB 789033 D2 General UNII Test Procedures New Rules v02r01, In addition, the radiated test is also performed to ensure the emissions emanating from the device cabinet also comply with the applicable limits.</p>			

RELATED SUBMITTAL(S) / GRANT(S):

This submittal(s) (test report) is intended for FCC ID: 2AZNP-XMTYY02FMGL2 filing to comply with Section 15.247 of the FCC Part 15, Subpart C Rules.

4 TEST METHODOLOGY

4.1 GENERAL DESCRIPTION OF APPLIED STANDARDS

According to its specifications, the EUT must comply with the requirements of the following standards:

FCC 47 CFR Part 2, Subpart J

FCC 47 CFR Part 15, Subpart E

FCC KDB 662911 D01 Multiple Transmitter Output v02r01

FCC KDB 789033 D2 General UNII Test Procedures New Rules v02r01

4.2 MEASUREMENT EQUIPMENT USED

Conducted Emission Test Equipment

Equipment	Manufacturer	Model No.	Serial No.	Last Cal.	Cal. Interval
EMI Test Receiver	Rohde & Schwarz	ESCI	101045	2021/5/15	1Year
PULSE LIMTER	Rohde & Schwarz	ESH3-Z2	100107	2021/5/15	1Year
AMN	Rohde & Schwarz	ESH3-Z5	100191	2021/5/15	1Year
AMN	Schwarzbeck	NNLK 8129	8129203	2021/5/15	1Year
V-Network	Rohde & Schwarz	ESH3-Z6	100011	2021/5/15	1Year
V-Network	Rohde & Schwarz	ESH3-Z6	100253	2021/5/16	1Year
EMI Test Receiver	Rohde & Schwarz	ESCI	101384	2021/5/15	1Year
AMN	Rohde & Schwarz	ENV216	5	2021/5/15	1Year
AMN	Kyoritsu	KNW-407	8-1492-9	2021/5/15	1Year

For Spurious Emissions Test

Equipment	Manufacturer	Model No.	Serial No.	Last Cal.	Cal. Interval
Pre-Amplifier	HP	8447F	2944A07999	2021/5/15	1Year
EMI Test Receiver	Rohde & Schwarz	ESCI	101414	2021/5/15	1Year
Bilog Antenna	Schwarzbeck	VULB9163	712	2021/7/5	2 Year
Horn antenna	Schwarzbeck	BBHA9120D	9120D-1178	2020/7/4	2 Year
Pre-Amplifie	Lunar EM	LNA1G18-48	J101113101000 1	2021/5/15	1Year
Spectrum Analyzer	Rohde & Schwarz	FSV40	100967	2021/5/15	1Year
EMI Test Receiver	Rohde & Schwarz	ESU 26	100154	2021/5/15	1Year
Pre-Amplifie	Lunar EM	LNA30M3G-25	J10100000070	2021/5/15	1Year
Bilog Antenna	Schwarzbeck	VULB9163	659	2021/8/22	2 Year
Horn antenna	Schwarzbeck	BBHA9120D	9120D-1177	2020/7/4	2 Year
Pre-Amplifie	SKET	LNPA_0118G-45	SK2019051801	2021/5/15	1Year
Loop Antenna	Schwarzbeck	FMZB1519	1519-012	2021/6/12	2 Year
Cable	H+B	NmSm-05-C15052	N/A	2021/5/15	1 Year
Cable	H+B	NmSm-2-C15201	N/A	2021/5/15	1 Year
Cable	H+B	NmNm-7-C15702	N/A	2021/5/15	1 Year
Cable	H+B	SAC-40G-1	414	2021/5/15	1 Year
Cable	H+B	SUCOFLEX104	MY14871/4	2021/5/15	1 Year
Cable	H+B	BLU18A-NmSm-650 0	D8501	2021/5/15	1 Year
Band reject Filter(50dB)	WI/DE	WRCGV-2400(2400- 2485MHz)	2	May 15, 2021	1 Year

For other test items:

Equipment	Manufacturer	Model No.	Serial No.	Last Cal.	Cal. Interval
Signal Analyzer	Agilent	N9010A	My53470879	2021/5/16	1 Year
Power meter	Anritsu	ML2495A	0824006	2021/5/15	1 Year
Power sensor	Anritsu	MA2411B	0738172	2021/5/15	1 Year
Spectrum Analyzer	Rohde & Schwarz	FSV40	100967	2021/5/15	1 Year



4.3 DESCRIPTION OF TEST MODES

The EUT has been tested under its typical operating condition.

The EUT configuration for testing is installed on RF field strength measurement to meet the Commissions requirement and operating in a manner which intends to maximize its emission characteristics in a continuous normal application.

The Transmitter was operated in the normal operating mode. The TX frequency was fixed which was for the purpose of the measurements.

Test of channel included the lowest and middle and highest frequency to perform the test, then record on this report.

Pre-defined engineering program for regulatory testing used to control the EUT for staying in continuous transmitting and receiving mode is programmed.

Wifi 5G with U-NII - 1

Frequency and Channel list for 802.11a, 802.11n (HT20), 802.11ac (HT20):

Channel	Frequency (MHz)	Channel	Frequency (MHz)	Channel	Frequency (MHz)
36	5180	44	5220		
40	5200	48	5240		

Frequency and Channel list for 802.11n (HT40), 802.11ac (HT40):

Channel	Frequency (MHz)	Channel	Frequency (MHz)	Channel	Frequency (MHz)
38	5190	46	5230		

Frequency and Channel list for 802.11ac (HT80):

Channel	Frequency (MHz)	Channel	Frequency (MHz)	Channel	Frequency (MHz)
42	5210				

Test Frequency and Channel for 802.11a, 802.11n (HT20), 802.11ac (HT20):

Lowest Frequency		Middle Frequency		Highest Frequency	
Channel	Frequency (MHz)	Channel	Frequency (MHz)	Channel	Frequency (MHz)
36	5180	40	5200	48	5240

Test Frequency and channel for 802.11n (HT40), 802.11ac (HT40):

Lowest Frequency		Middle Frequency		Highest Frequency	
Channel	Frequency (MHz)	Channel	Frequency (MHz)	Channel	Frequency (MHz)
38	5190	N/A	N/A	46	5230

Test Frequency and channel for 802.11ac (HT80):

Lowest Frequency		Middle Frequency		Highest Frequency	
Channel	Frequency (MHz)	Channel	Frequency (MHz)	Channel	Frequency (MHz)
42	5210	N/A	N/A	N/A	N/A

Wifi 5G with U-NII -2A

Frequency and Channel list 802.11a, 802.11n (HT20), 802.11ac (HT20):

Channel	Frequency (MHz)	Channel	Frequency (MHz)	Channel	Frequency (MHz)
52	5260	60	5300		
56	5280	64	5320		

Frequency and Channel list for 802.11n (HT40), 802.11ac (HT40):

Channel	Frequency (MHz)	Channel	Frequency (MHz)	Channel	Frequency (MHz)
54	5270				
62	5310				

Frequency and Channel list for 802.11ac (HT80):

Channel	Frequency (MHz)	Channel	Frequency (MHz)	Channel	Frequency (MHz)
58	5290				

Test Frequency and Channel for 802.11a, 802.11n (HT20), 802.11ac (HT20):

Lowest Frequency		Middle Frequency		Highest Frequency	
Channel	Frequency (MHz)	Channel	Frequency (MHz)	Channel	Frequency (MHz)
52	5260	56	5280	64	5320

Test Frequency and channel for 802.11n (HT40), 802.11ac (HT40):

Lowest Frequency		Middle Frequency		Highest Frequency	
Channel	Frequency (MHz)	Channel	Frequency (MHz)	Channel	Frequency (MHz)
54	5270	N/A	N/A	62	5310

Test Frequency and channel for 802.11ac (HT80):

Lowest Frequency		Middle Frequency		Highest Frequency	
Channel	Frequency (MHz)	Channel	Frequency (MHz)	Channel	Frequency (MHz)
58	5290				

Wifi 5G with U-NII -2C

Frequency and Channel list for 802.11a, 802.11n (HT20), 802.11ac (HT20):

Channel	Frequency (MHz)	Channel	Frequency (MHz)	Channel	Frequency (MHz)
100	5500	116	5580	132	5660
104	5520	120	5600	136	5680
108	5540	124	5620	140	5700
112	5560	128	5640		

Frequency and Channel list for 802.11n (HT40), 802.11ac (HT40):

Channel	Frequency (MHz)	Channel	Frequency (MHz)	Channel	Frequency (MHz)
102	5510	118	5590	134	5670
110	5550	126	5630		

Frequency and Channel list for 802.11ac (HT80):

Channel	Frequency (MHz)	Channel	Frequency (MHz)	Channel	Frequency (MHz)
106	5530	122	5610		

Test Frequency and Channel for 802.11a, 802.11n (HT20), 802.11ac (HT20):

Lowest Frequency		Middle Frequency		Highest Frequency	
Channel	Frequency (MHz)	Channel	Frequency (MHz)	Channel	Frequency (MHz)
100	5500	116	5580	140	5700

Test Frequency and channel for 802.11n (HT40), 802.11ac (HT40):

Lowest Frequency		Middle Frequency		Highest Frequency	
Channel	Frequency (MHz)	Channel	Frequency (MHz)	Channel	Frequency (MHz)
102	5510			134	5670

Test Frequency and channel for 802.11ac (HT80):

Lowest Frequency		Middle Frequency		Highest Frequency	
Channel	Frequency (MHz)	Channel	Frequency (MHz)	Channel	Frequency (MHz)
106	5530				

Wifi 5G with U-NII -3

Frequency and Channel list for 802.11a, 802.11n (HT20), 802.11ac (HT20):

Channel	Frequency (MHz)	Channel	Frequency (MHz)	Channel	Frequency (MHz)
149	5745	157	5785	165	5825
153	5765	161	5805		

Frequency and Channel list for 802.11n (HT40), 802.11ac (HT40):

Channel	Frequency (MHz)	Channel	Frequency (MHz)	Channel	Frequency (MHz)
151	5755	159	5795		

Frequency and Channel list for 802.11ac (HT80):

Channel	Frequency (MHz)	Channel	Frequency (MHz)	Channel	Frequency (MHz)
155	5775				

Test Frequency and Channel for 802.11a, 802.11n (HT20), 802.11ac (HT20):

Lowest Frequency		Middle Frequency		Highest Frequency	
Channel	Frequency (MHz)	Channel	Frequency (MHz)	Channel	Frequency (MHz)
149	5745	157	5785	165	5825

Test Frequency and channel for 802.11n (HT40), 802.11ac (HT40):

Lowest Frequency		Middle Frequency		Highest Frequency	
Channel	Frequency (MHz)	Channel	Frequency (MHz)	Channel	Frequency (MHz)
151	5755	N/A	N/A	159	5795

Test Frequency and channel for 802.11ac (HT80):

Lowest Frequency		Middle Frequency		Highest Frequency	
Channel	Frequency (MHz)	Channel	Frequency (MHz)	Channel	Frequency (MHz)
155	5775				

The 5G WIFI has two antennas and support Multiple Outputs for 802.11n/ac mode for this report; Antenna 1 Gain is 5.34dBi; Antenna 2 Gain is 5.57dBi; for this function is belong to Correlated Categorization equipment

According to KDB 662911, for Unequal antenna gains,

$$\text{Directional gain} = 10 \log [(10^{5.34/20} + 10^{5.57/20})^2/2] \text{ dBi} = 8.47 \text{ dBi}$$

5 FACILITIES AND ACCREDITATIONS

5.1 FACILITIES

All measurement facilities used to collect the measurement data are located at:

EMTEK (Shenzhen) Co., Ltd.

Building 69, Majialong Industry Zone District, Nanshan District, Shenzhen, China

The sites are constructed in conformance with the requirements of ANSI C63.7, ANSI C63.4 and CISPR Publication 22.

5.2 EQUIPMENT

Radiated emissions are measured with one or more of the following types of linearly polarized antennas: tuned dipole, biconical, log periodic, bi-log, and/or ridged waveguide, horn. Spectrum analyzers with preselectors and quasi-peak detectors are used to perform radiated measurements.

Conducted emissions are measured with Line Impedance Stabilization Networks and EMI Test Receivers.

Calibrated wideband preamplifiers, coaxial cables, and coaxial attenuators are also used for making measurements.

All receiving equipment conforms to CISPR Publication 16-1, "Radio Interference Measuring Apparatus and Measurement Methods."

5.3 LABORATORY ACCREDITATIONS AND LISTINGS

Site Description	
EMC Lab.	<p>Accredited by CNAS The Certificate Registration Number is L2291. The Laboratory has been assessed and proved to be in compliance with CNAS-CL01 (identical to ISO/IEC 17025:2017)</p> <p>Accredited by FCC Designation Number: CN1204 Test Firm Registration Number: 882943</p> <p>Accredited by A2LA The Certificate Number is 4321.01.</p> <p>Accredited by Industry Canada The Conformity Assessment Body Identifier is CN0008</p>
Name of Firm	: EMTEK (SHENZHEN) CO., LTD.
Site Location	: Building 69, Majialong Industry Zone, Nanshan District, Shenzhen, Guangdong, China

6 TEST SYSTEM UNCERTAINTY

The following measurement uncertainty levels have been estimated for tests performed on the apparatus:

Parameter	Uncertainty
Radio Frequency	$\pm 1 \times 10^{-5}$
Maximum Peak Output Power Test	$\pm 1.0\text{dB}$
Conducted Emissions Test	$\pm 2.0\text{dB}$
Radiated Emission Test	$\pm 2.0\text{dB}$
Power Density	$\pm 2.0\text{dB}$
Occupied Bandwidth Test	$\pm 1.0\text{dB}$
Band Edge Test	$\pm 3\text{dB}$
All emission, radiated	$\pm 3\text{dB}$
Antenna Port Emission	$\pm 3\text{dB}$
Temperature	$\pm 0.5^\circ\text{C}$
Humidity	$\pm 3\%$

Measurement Uncertainty for a level of Confidence of 95%

7 SETUP OF EQUIPMENT UNDER TEST

7.1 RADIO FREQUENCY TEST SETUP

The WLAN component's antenna ports(s) of the EUT are connected to the measurement instrument per an appropriate attenuator. The EUT is controlled by PC/software to emit the specified signals for the purpose of measurements.

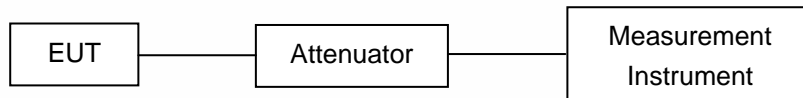

7.2 RADIO FREQUENCY TEST SETUP

The test site semi-anechoic chamber has met the requirement of NSA tolerance 4 dB according to the standards: ANSI C63.10. The test distance is 3m. The setup is according to the requirements in Section 13.1.4.1 of ANSI C63.10-2013 and CAN/CSA-CEI/IEC CISPR 22.

Below 30MHz:

The EUT is placed on a turntable 0.8 meters above the ground in the chamber, 3 meter away from the antenna (loop antenna). The Antenna should be positioned with its plane vertical at the specified distance from the EUT and rotated about its vertical axis for maximum response at each azimuth about the EUT. The center of the loop shall be 1 m above the ground. For certain applications, the loop antenna plane may also need to be positioned horizontally at the specified distance from the EUT.

Above 30MHz:

The EUT is placed on a turntable 0.8 meters above the ground in the chamber, 3 meter away from the antenna. The maximal emission value is acquired by adjusting the antenna height, polarisation and turntable azimuth. Normally, the height range of antenna is 1 m to 4 m, the azimuth range of turntable is 0° to 360°, and the receive antenna has two polarizations Vertical (V) and Horizontal (H).

Above 1GHz:

(Note: the FCC's permission to use 1.5m as an alternative per TCBC Conf call of Dec. 2, 2014.)

The EUT is placed on a turntable 1.5 meters above the ground in the chamber, 3 meter away from the antenna. The maximal emission value is acquired by adjusting the antenna height, polarisation and turntable azimuth. Normally, the height range of antenna is 1 m to 4 m, the azimuth range of turntable is 0° to 360°, and the receive antenna has two polarizations Vertical (V) and Horizontal (H).

(a) Radiated Emission Test Set-Up, Frequency Below 30MHz

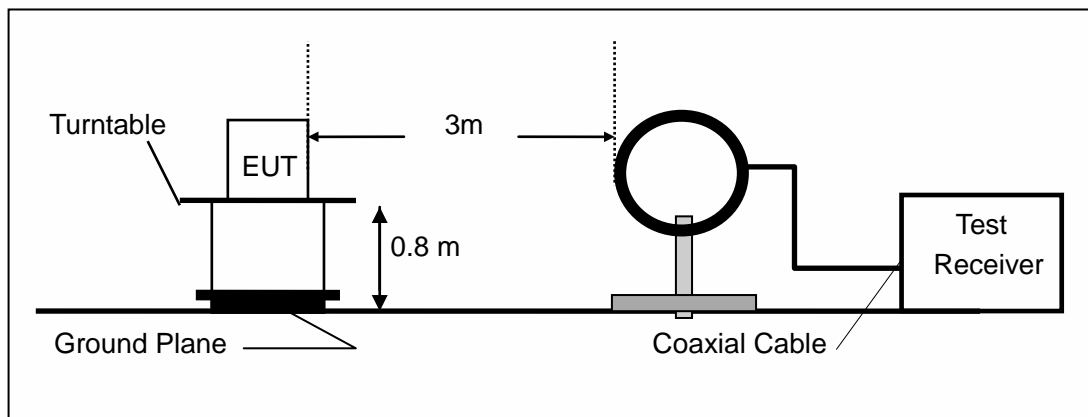

(b) Radiated Emission Test Set-Up, Frequency Below 1000MHz

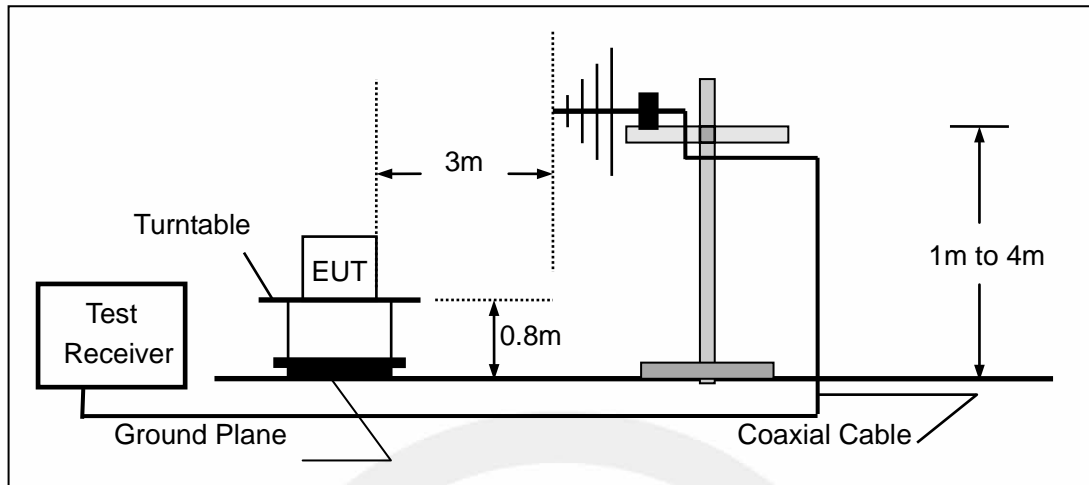

(c) Radiated Emission Test Set-Up, Frequency above 1000MHz

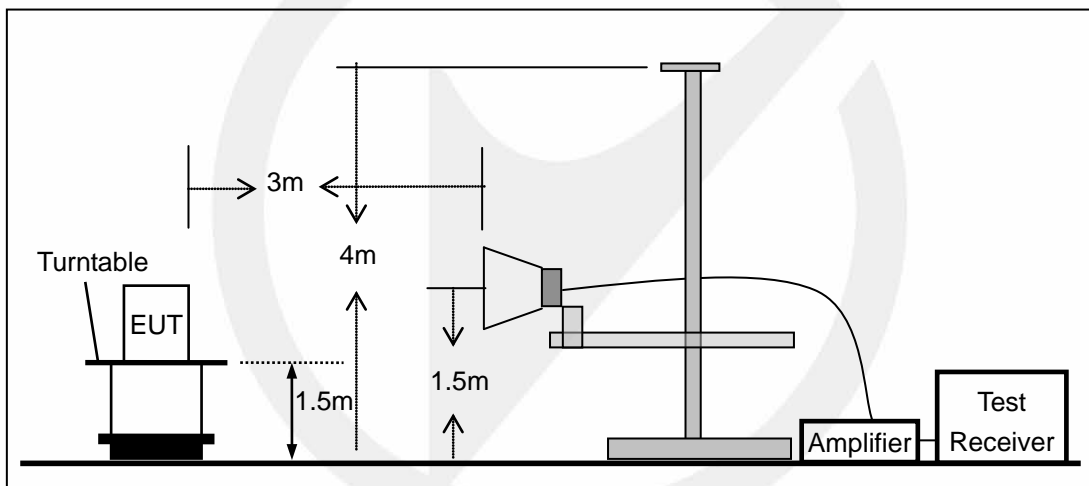

7.3 CONDUCTED EMISSION TEST SETUP

The mains cable of the EUT (maybe per AC/DC Adapter) must be connected to LISN. The LISN shall be placed 0.8 m from the boundary of EUT and bonded to a ground reference plane for LISN mounted on top of the ground reference plane. This distance is between the closest points of the LISN and the EUT. All other units of the EUT and associated equipment shall be at least 0.8m from the LISN.

Ground connections, where required for safety purposes, shall be connected to the reference ground point of the LISN and, where not otherwise provided or specified by the manufacturer, shall be of same length as the mains cable and run parallel to the mains connection at a separation distance of not more than 0.1 m.

According to the requirements in Section 13.1.4.1 of ANSI C63.10-2013 Conducted emissions from the EUT measured in the frequency range between 0.15 MHz and 30 MHz using CISPR Quasi-Peak and average detector mode.

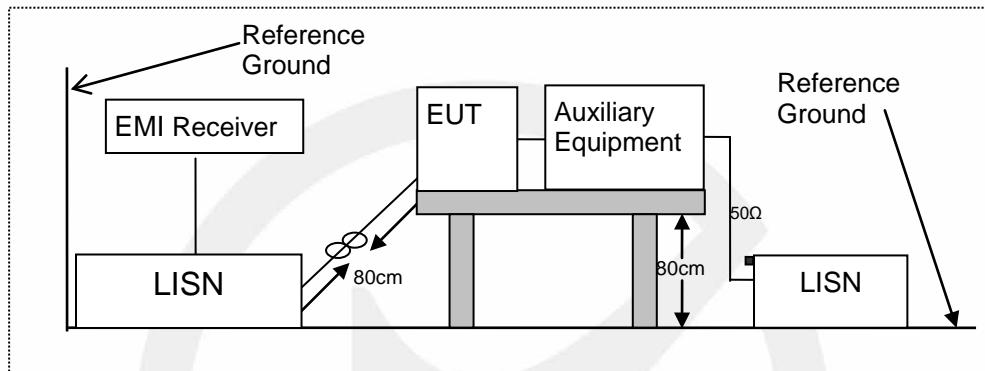

7.4 BLOCK DIAGRAM CONFIGURATION OF TEST SYSTEM

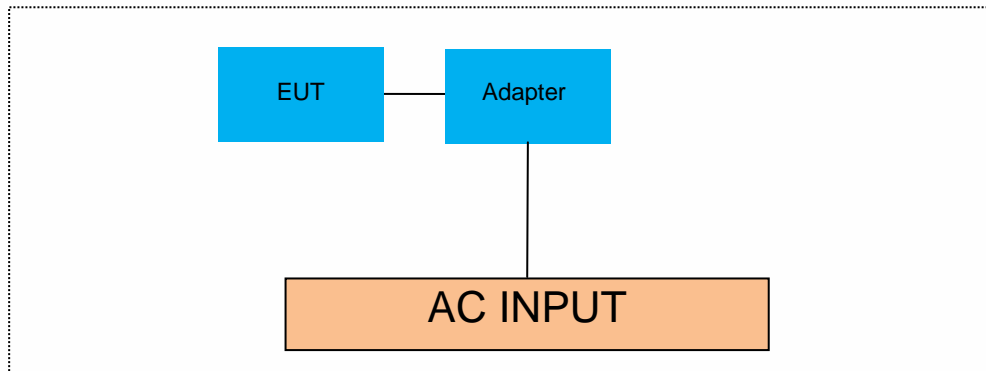

7.5 SUPPORT EQUIPMENT

EUT Cable List and Details			
Cable Description	Length (m)	Shielded/Unshielded	With / Without Ferrite
/	/	/	/

Auxiliary Cable List and Details			
Cable Description	Length (m)	Shielded/Unshielded	With / Without Ferrite
/	/	/	/

Auxiliary Equipment List and Details			
Description	Manufacturer	Model	Serial Number
Notebook	LENOVO	M713A	SA12582190

Notes:

- 1.All the equipment/cables were placed in the worst-case configuration to maximize the emission during the test.
- 2.Grounding was established in accordance with the manufacturer’s requirements and conditions for the intended use.

8 TEST REQUIREMENTS

8.1 BANDWIDTH MEASUREMENT

8.1.1 Applicable Standard

According to FCC Part 15.407(a)(1) for UNII Band I
According to FCC Part 15.407(a)(2) for UNII Band II-A and UNII Band II-C
According to FCC Part 15.407(a)(3) for UNII Band III
According to FCC Part 15.407(e) for UNII Band III
According to 789033 D02 Section II(C)
According to 789033 D02 Section II(D)

8.1.2 Conformance Limit

(1) For the band 5.15-5.25 GHz.

(iv) For mobile and portable client devices in the 5.15-5.25 GHz band, the maximum conducted output power over the frequency band of operation shall not exceed 250 mW provided the maximum antenna gain does not exceed 6 dBi. In addition, the maximum power spectral density shall not exceed 11 dBm in any 1 megahertz band. If transmitting antennas of directional gain greater than 6 dBi are used, both the maximum conducted output power and the maximum power spectral density shall be reduced by the amount in dB that the directional gain of the antenna exceeds 6 dBi.

(2) For the 5.25-5.35 GHz and 5.47-5.725 GHz bands, the maximum conducted output power over the frequency bands of operation shall not exceed the lesser of 250 mW or 11 dBm + 10 log B, where B is the 26 dB emission bandwidth in megahertz. In addition, the maximum power spectral density shall not exceed 11 dBm in any 1 megahertz band. If transmitting antennas of directional gain greater than 6 dBi are used, both the maximum conducted output power and the maximum power spectral density shall be reduced by the amount in dB that the directional gain of the antenna exceeds 6 dBi.

(3) For the band 5.725-5.85 GHz, the maximum conducted output power over the frequency band of operation shall not exceed 1 W. In addition, the maximum power spectral density shall not exceed 30 dBm in any 500-kHz band. If transmitting antennas of directional gain greater than 6 dBi are used, both the maximum conducted output power and the maximum power spectral density shall be reduced by the amount in dB that the directional gain of the antenna exceeds 6 dBi. However, fixed point-to-point U-NII devices operating in this band may employ transmitting antennas with directional gain greater than 6 dBi without any corresponding reduction in transmitter conducted power. Fixed, point-to-point operations exclude the use of point-to-multipoint systems, omnidirectional applications, and multiple collocated transmitters transmitting the same information. The operator of the U-NII device, or if the equipment is professionally installed, the installer, is responsible for ensuring that systems employing high gain directional antennas are used exclusively for fixed, point-to-point operations.

(e) Within the 5.725-5.85 GHz band, the minimum 6 dB bandwidth of U-NII devices shall be at least 500 kHz.

8.1.3 Test Configuration

Test according to clause 7.1 radio frequency test setup

8.1.4 Test Procedure

According to 789033 D02 v02r01 section C&D, the following is the measurement procedure.

1. Emission Bandwidth (EBW)

- Set RBW = approximately 1% of the emission bandwidth.
- Set the VBW > RBW.
- Detector = Peak.
- Trace mode = max hold.
- Measure the maximum width of the emission that is 26 dB down from the maximum of the emission.

Compare this with the RBW setting of the analyzer. Readjust RBW and repeat measurement as needed until the RBW/EBW ratio is approximately 1%.

2. Minimum Emission Bandwidth for the band 5.725-5.85 GHz

Section 15.407(e) specifies the minimum 6 dB emission bandwidth of at least 500 KHz for the band 5.715-5.85 GHz. The following procedure shall be used for measuring this bandwidth:

- a) Set RBW = 100 kHz.
- b) Set the video bandwidth (VBW) $\geq 3 \times$ RBW.
- c) Detector = Peak.
- d) Trace mode = max hold.
- e) Sweep = auto couple.
- f) Allow the trace to stabilize.
- g) Measure the maximum width of the emission that is constrained by the frequencies associated with the two outermost amplitude points (upper and lower frequencies) that are attenuated by 6 dB relative to the maximum level measured in the fundamental emission.

Note: The automatic bandwidth measurement capability of a spectrum analyzer or EMI receiver may be employed if it implements the functionality described above.

D. 99 Percent Occupied Bandwidth

The 99-percent occupied bandwidth is the frequency bandwidth such that, below its lower and above its upper frequency limits, the mean powers are each equal to 0.5 % of the total mean power of the given emission. Measurement of the 99-percent occupied bandwidth is required only as a condition for using the optional band-edge measurement techniques described in section II.G.3.d). Measurements of 99-percent occupied bandwidth may also optionally be used in lieu of the EBW to 789033 D02 v01r02 General UNII Test Procedures New Rules v01 define the minimum frequency range over which the spectrum is integrated when measuring maximum conducted output power as described in section II.E. However, the EBW must be measured to determine bandwidth dependent limits on maximum conducted output power in accordance with 15.407(a).

The following procedure shall be used for measuring (99 %) power bandwidth:

1. Set center frequency to the nominal EUT channel center frequency.
2. Set span = 1.5 times to 5.0 times the OBW.
3. Set RBW = 1 % to 5 % of the OBW
4. Set VBW $\geq 3 \cdot$ RBW
5. Video averaging is not permitted. Where practical, a sample detection and single sweep mode shall be used. Otherwise, peak detection and max hold mode (until the trace stabilizes) shall be used.
6. Use the 99 % power bandwidth function of the instrument (if available).
7. If the instrument does not have a 99 % power bandwidth function, the trace data points are recovered and directly summed in power units. The recovered amplitude data points, beginning at the lowest frequency, are placed in a running sum until 0.5 % of the total is reached; that frequency is recorded as the lower frequency. The process is repeated until 99.5 % of the total is reached; that frequency is recorded as the upper frequency. The 99% occupied bandwidth is the difference between these two frequencies.

8.1.5 Test Results

5150-5250MHz

Test Mode	Test Channel MHz		26 dB Bandwidth MHz	99% Bandwidth MHz	Verdict
802.11a	CH36	5180	20.06	16.701	Pass
	CH40	5200	20.12	16.671	Pass
	CH48	5240	19.82	16.624	Pass
802.11n-HT20	CH36	5180	20.50	17.696	Pass
	CH40	5200	20.40	17.700	Pass
	CH48	5240	20.42	17.648	Pass
802.11ac(HT20)	CH36	5180	20.29	17.661	Pass
	CH40	5200	20.33	17.673	Pass
	CH48	5240	20.28	17.680	Pass
802.11n-HT40	CH38	5190	40.71	36.123	Pass
	CH46	5230	40.21	36.049	Pass
802.11ac(HT40)	CH38	5190	40.69	36.113	Pass
	CH46	5230	40.29	36.078	Pass
802.11ac(HT80)	CH42	5210	81.36	75.547	Pass

99% & -26 dB Emission Bandwidth
Test Model 802.11a

U-NII - 1
Frequency(MHz)

5180

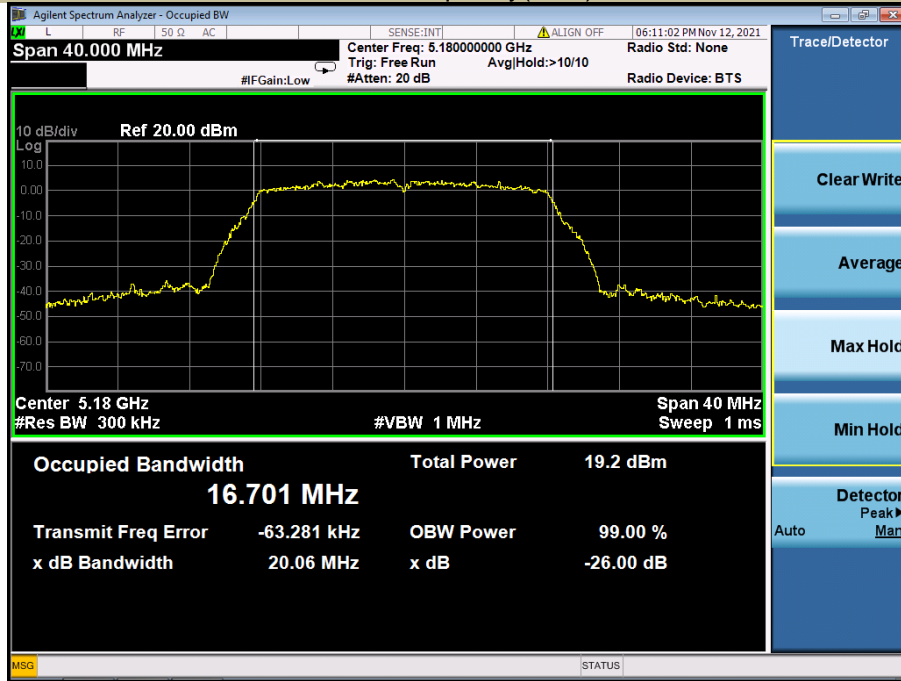

99% & -26 dB Emission Bandwidth
Test Model 802.11a

U-NII - 1
Frequency(MHz)

5200

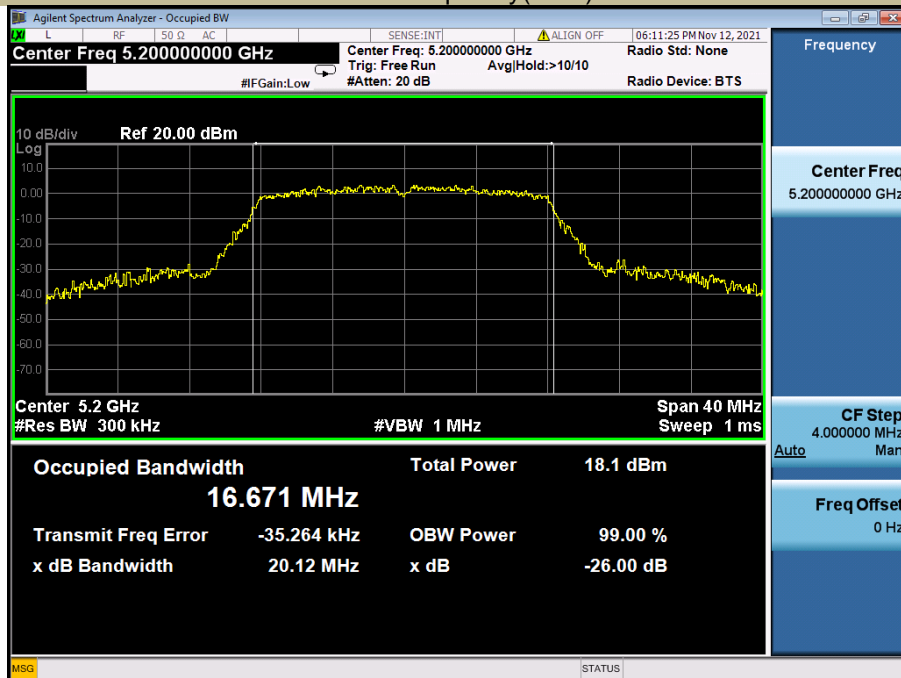

99% & -26 dB Emission Bandwidth
Test Model 802.11a

U-NII - 1
Frequency(MHz)

5240

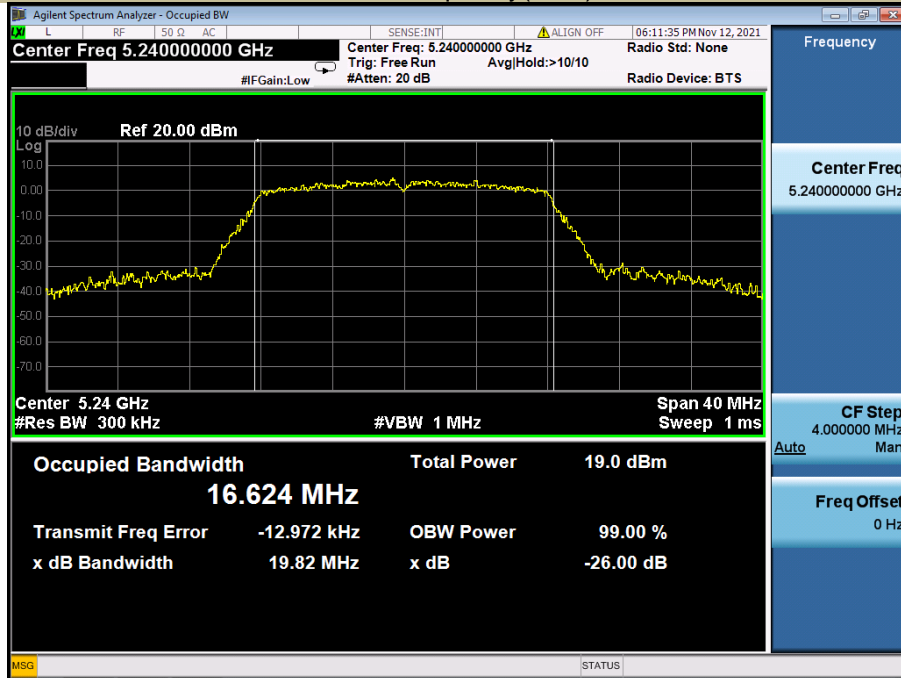

99% & -26 dB Emission Bandwidth
Test Model 802.11n-HT20

U-NII - 1
Frequency(MHz)

5180

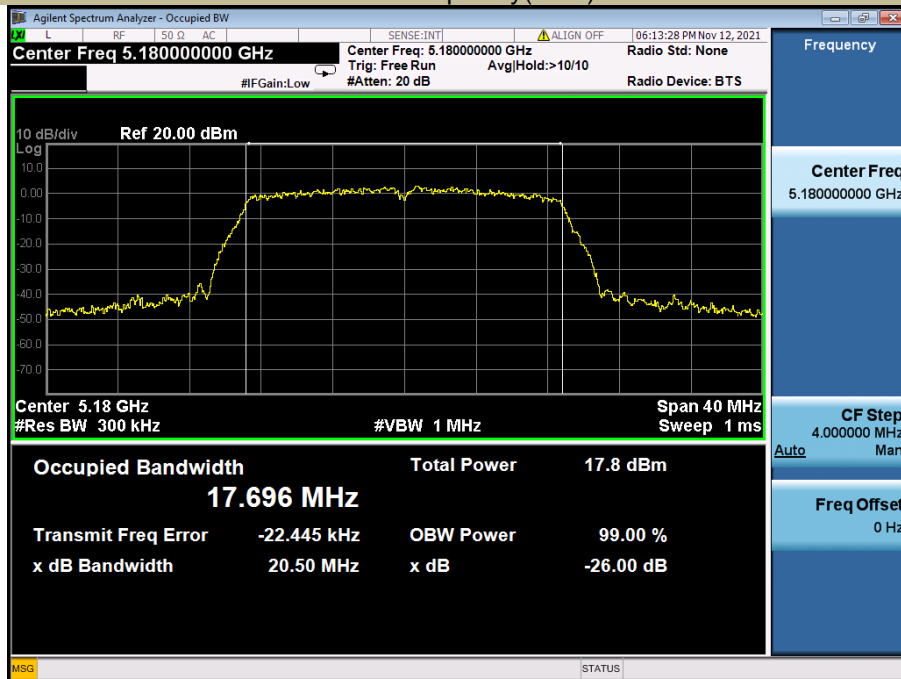

99% & -26 dB Emission Bandwidth
Test Model 802.11n-HT20

U-NII - 1
Frequency(MHz)

5200

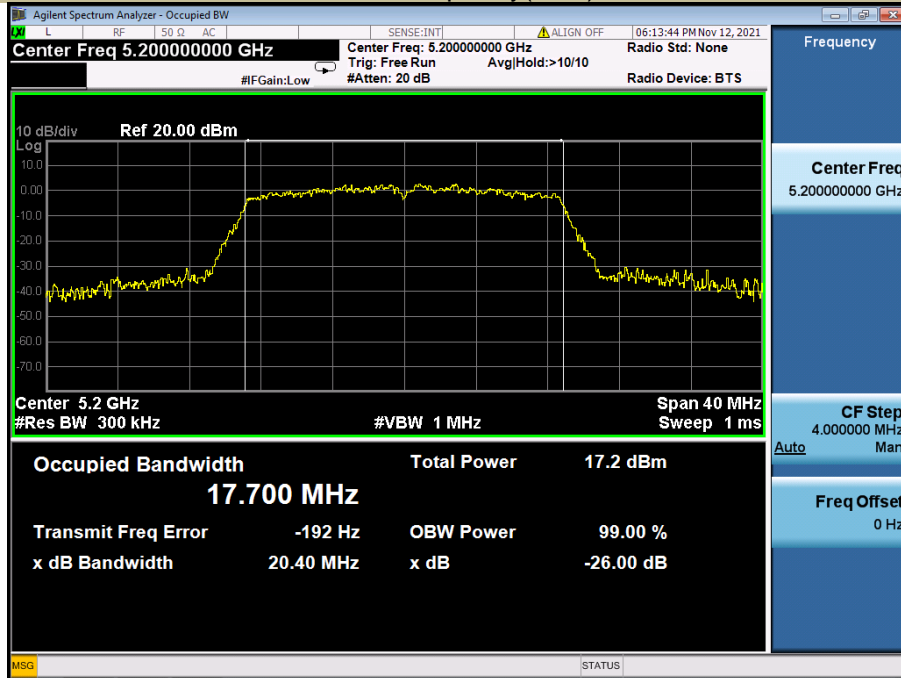

99% & -26 dB Emission Bandwidth
Test Model 802.11n-HT20

U-NII - 1
Frequency(MHz)

5240

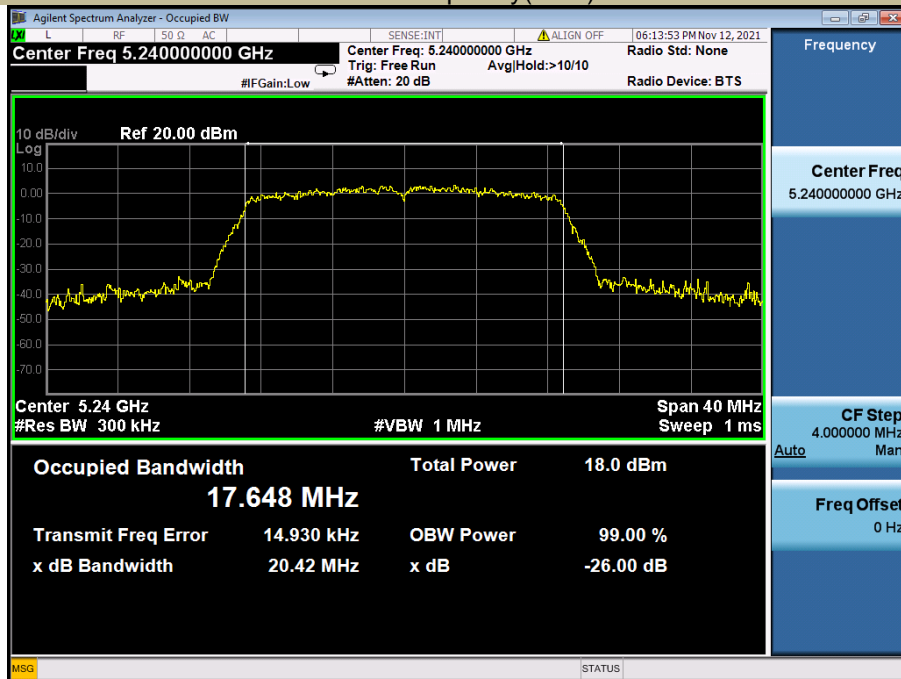

99% & -26 dB Emission Bandwidth
Test Model 802.11ac(HT20)

U-NII - 1
Frequency(MHz)

5180

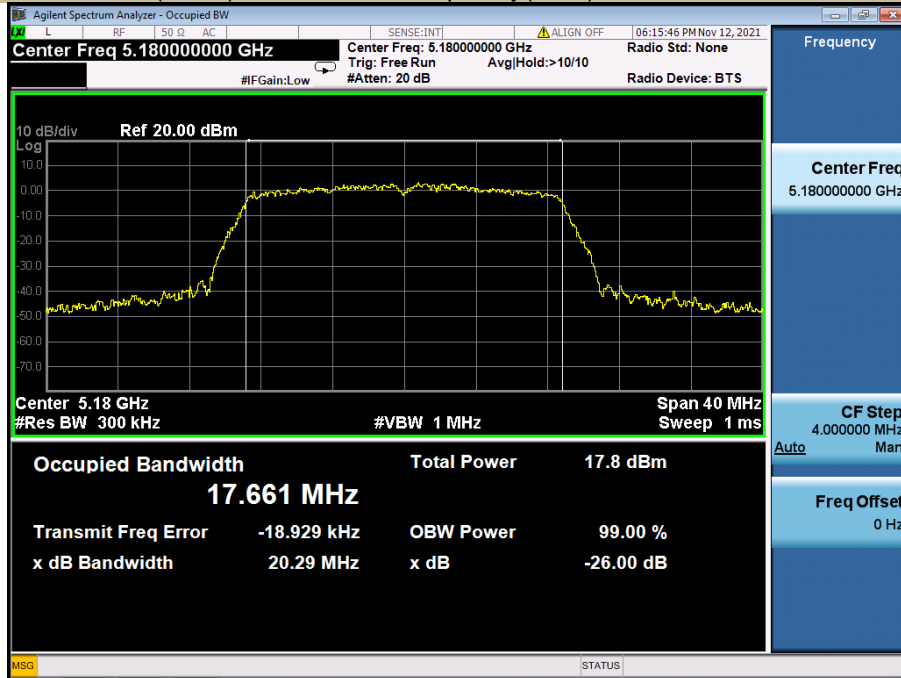

99% & -26 dB Emission Bandwidth
Test Model 802.11ac(HT20)

U-NII - 1
Frequency(MHz)

5200

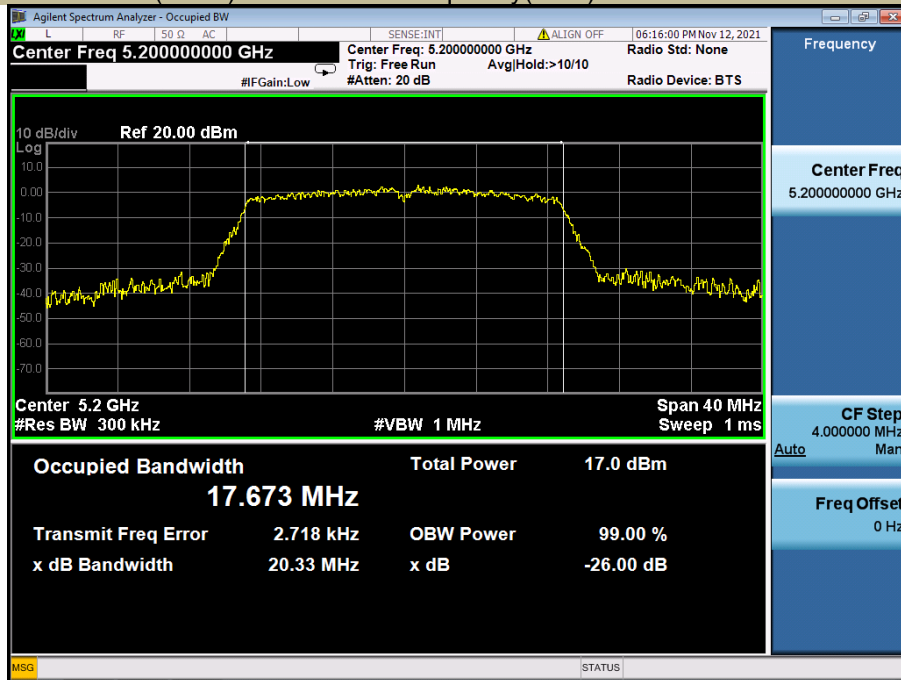

99% & -26 dB Emission Bandwidth U-NII - 1
 Test Model 802.11ac(HT20) Frequency(MHz) 5240

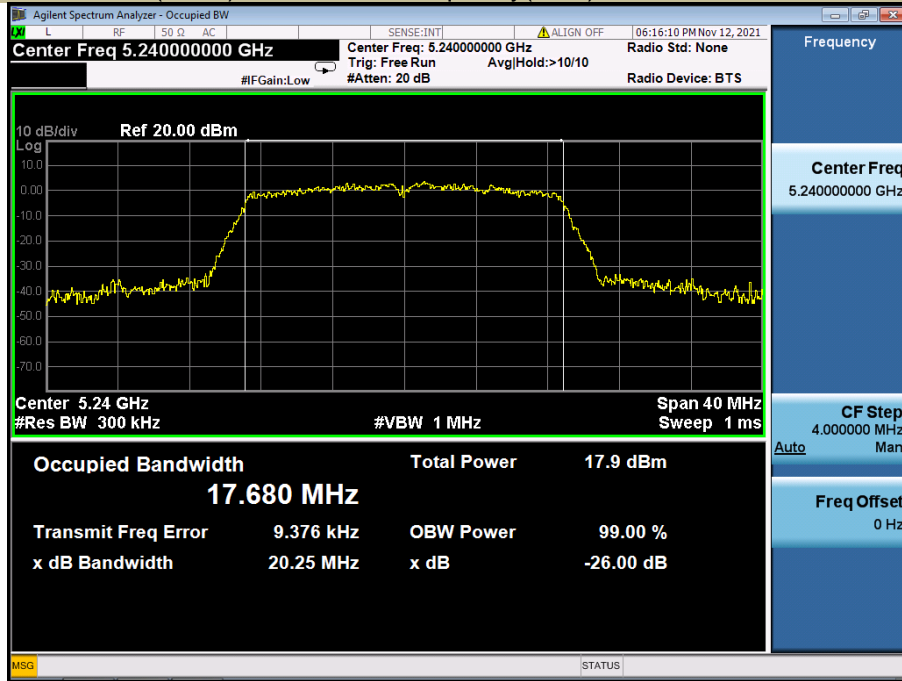

99% & -26 dB Emission Bandwidth U-NII - 1
 Test Model 802.11n-HT40 Frequency(MHz) 5190

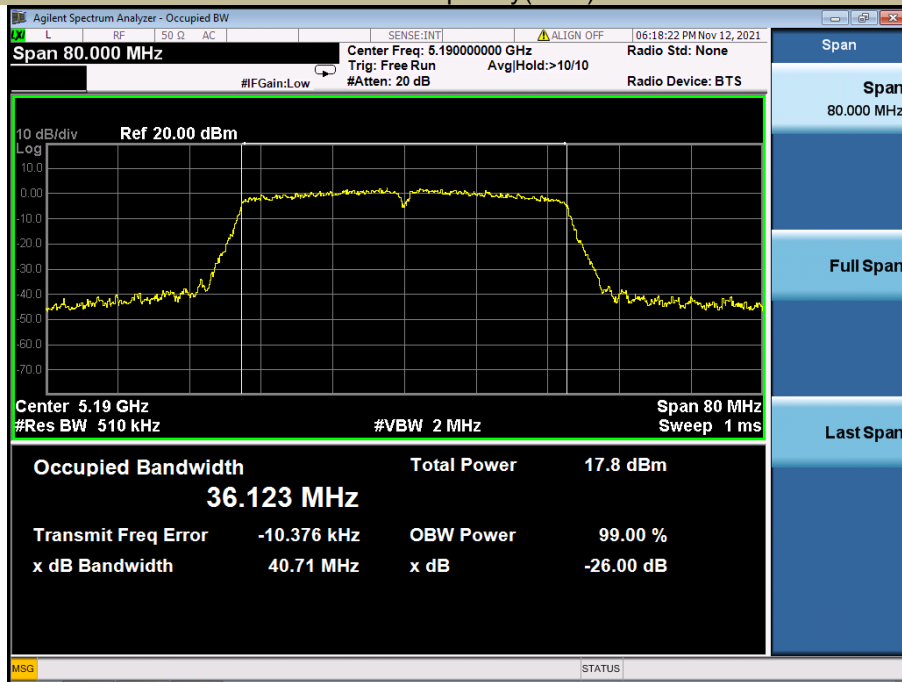

99% & -26 dB Emission Bandwidth
Test Model 802.11n-HT40

U-NII - 1
Frequency(MHz)

5230

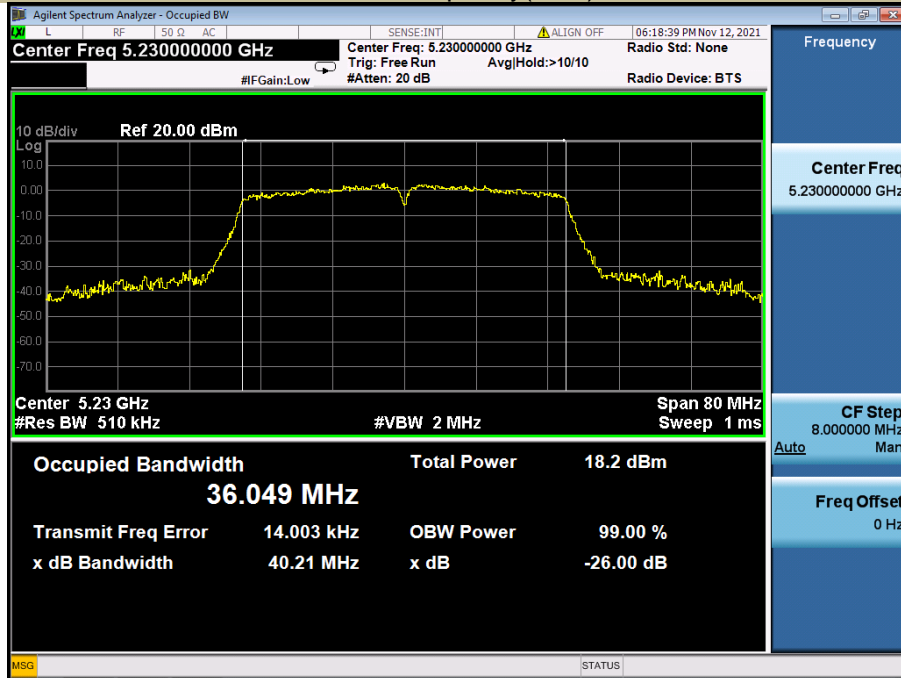

99% & -26 dB Emission Bandwidth
Test Model 802.11ac(HT40)

U-NII - 1
Frequency(MHz)

5190

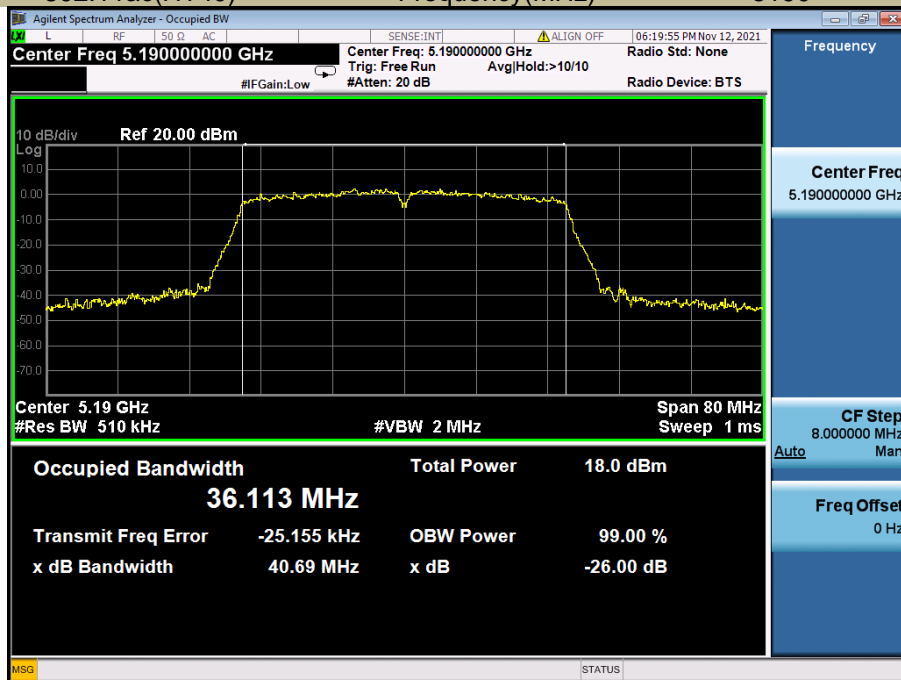

99% & -26 dB Emission Bandwidth
Test Model 802.11ac(HT40)

U-NII - 1
Frequency(MHz)

5230

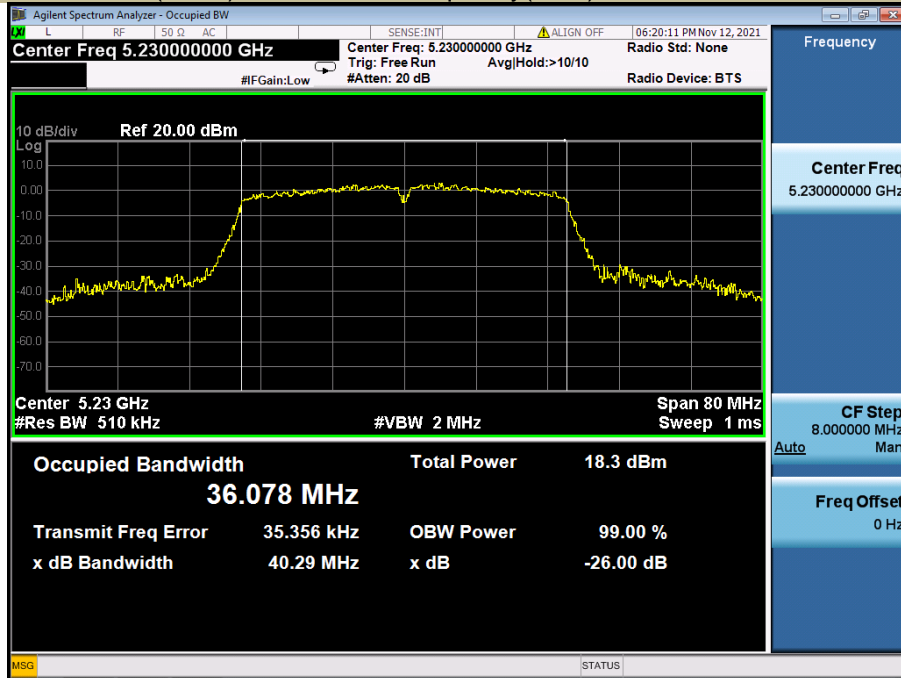

99% & -26 dB Emission Bandwidth
Test Model 802.11ac 80

U-NII - 1
Frequency(MHz)

5210

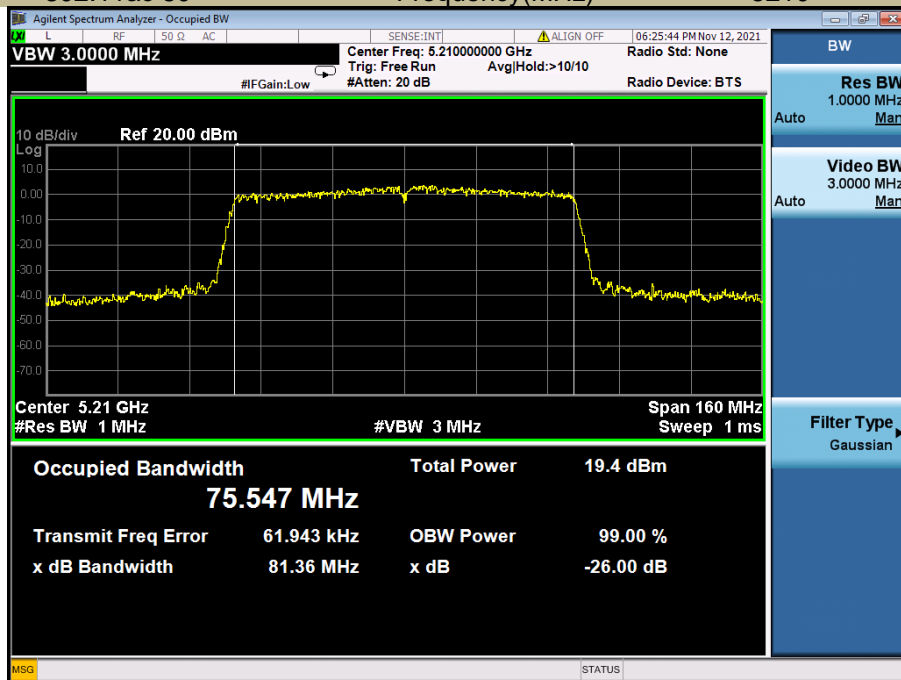

5250-5350MHz

Test Mode	Test Channel MHz		26 dB Bandwidth MHz	99% Bandwidth MHz	Verdict
802.11a	CH52	5260	20.22	16.675	Pass
	CH56	5280	19.92	16.636	Pass
	CH64	5320	19.98	16.628	Pass
802.11n-HT20	CH52	5260	20.40	17.666	Pass
	CH56	5280	20.33	17.689	Pass
	CH64	5320	20.40	17.634	Pass
802.11ac(HT20)	CH52	5260	20.50	17.691	Pass
	CH56	5280	20.39	17.664	Pass
	CH64	5320	20.29	17.651	Pass
802.11n-HT40	CH54	5270	40.44	36.121	Pass
	CH62	5310	40.60	36.090	Pass
802.11ac(HT40)	CH54	5270	40.57	36.109	Pass
	CH62	5310	40.41	36.062	Pass
802.11ac(HT80)	CH58	5290	81.49	75.507	Pass

99% & -26 dB Emission Bandwidth
Test Model 802.11a

U-NII – 2A
Frequency(MHz) 5260

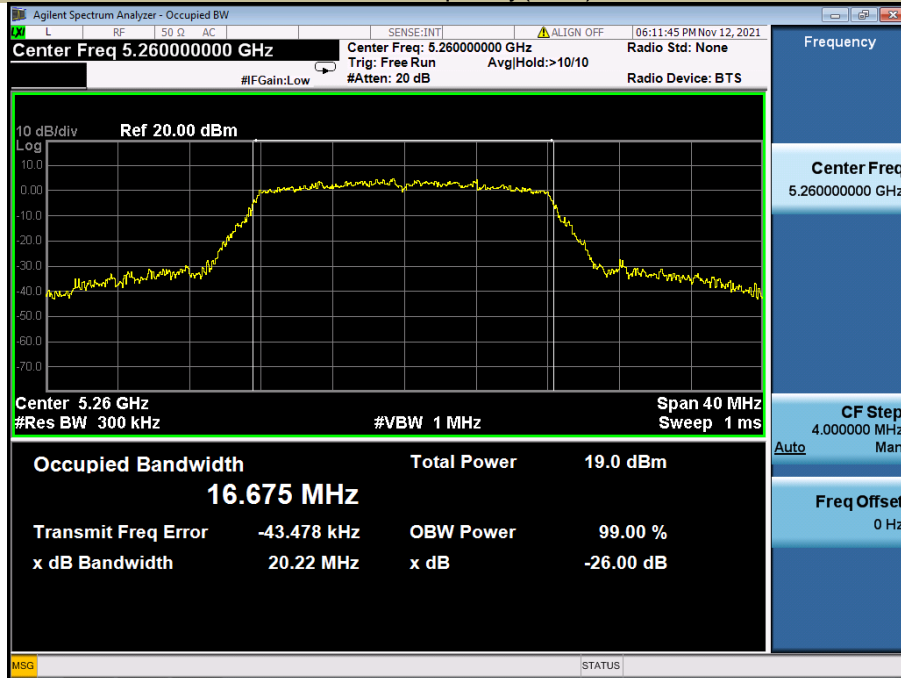

99% & -26 dB Emission Bandwidth
Test Model 802.11a

U-NII – 2A
Frequency(MHz) 5280

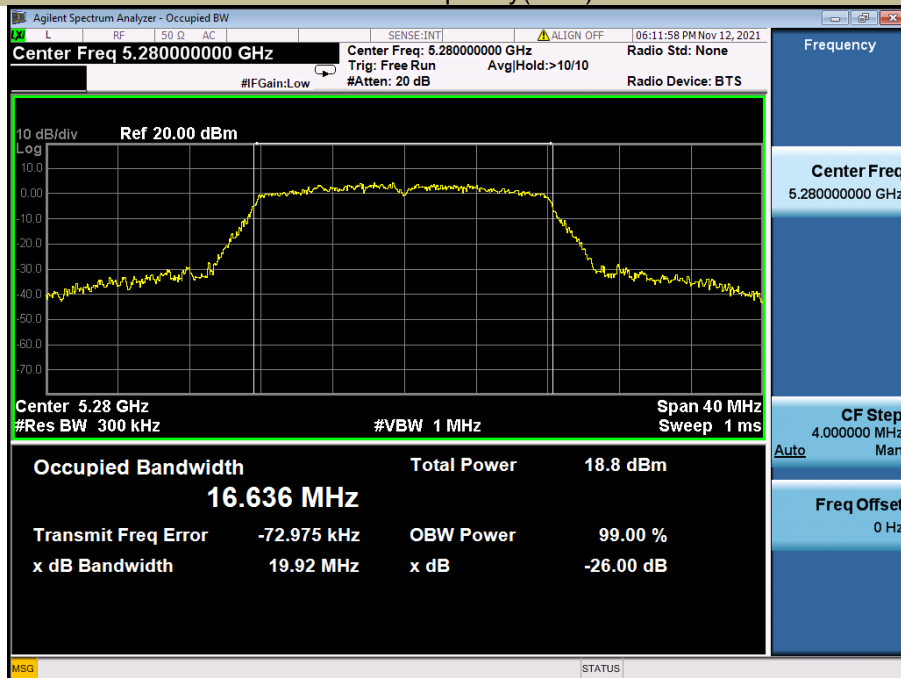

99% & -26 dB Emission Bandwidth
Test Model 802.11a

U-NII – 2A
Frequency(MHz) 5320

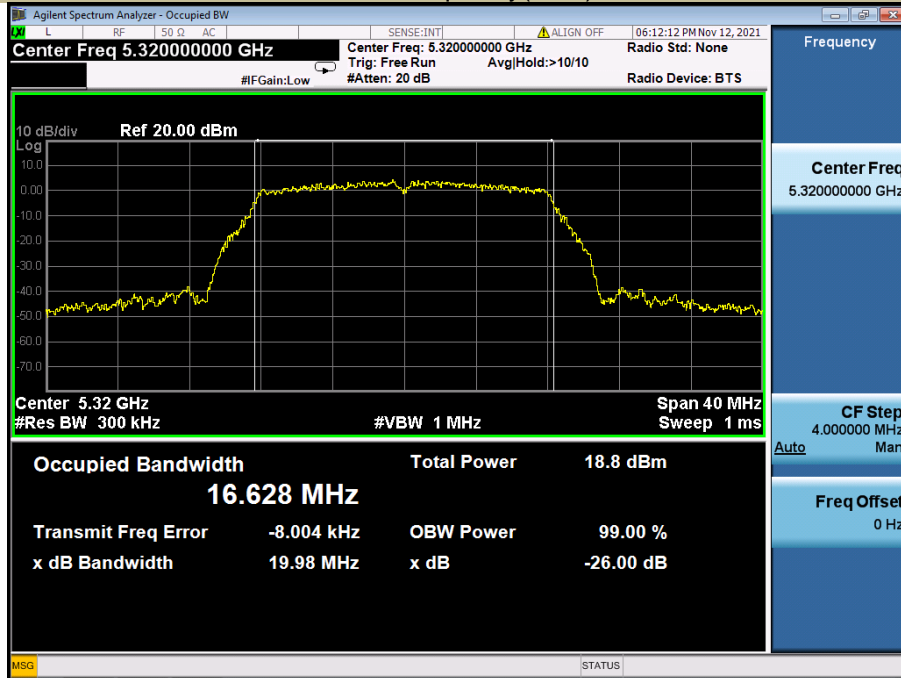

99% & -26 dB Emission Bandwidth
Test Model 802.11n-HT20

U-NII – 2A
Frequency(MHz) 5260

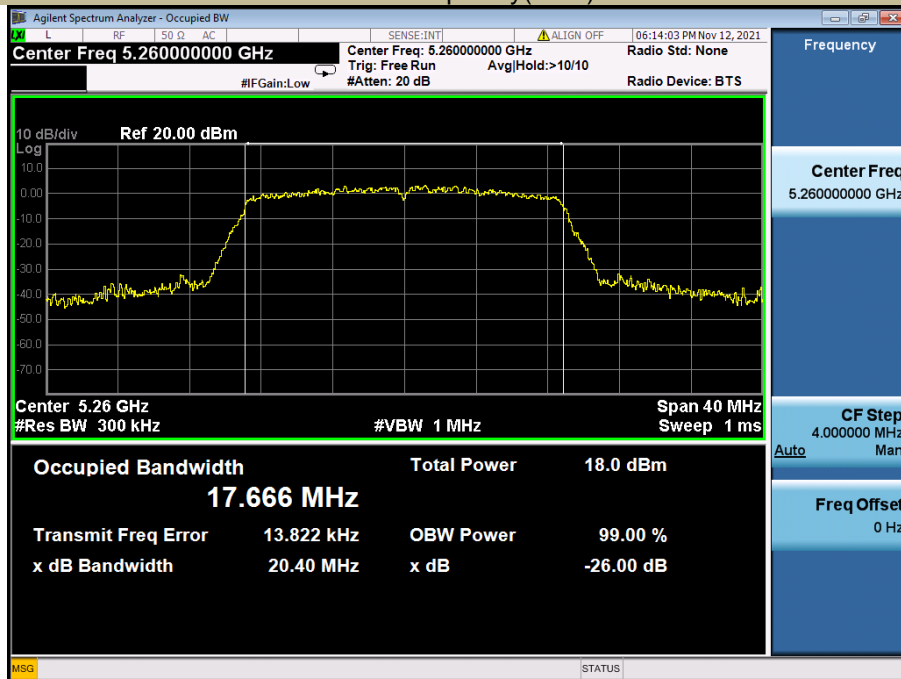

99% & -26 dB Emission Bandwidth
Test Model 802.11n-HT20

U-NII – 2A
Frequency(MHz) 5280

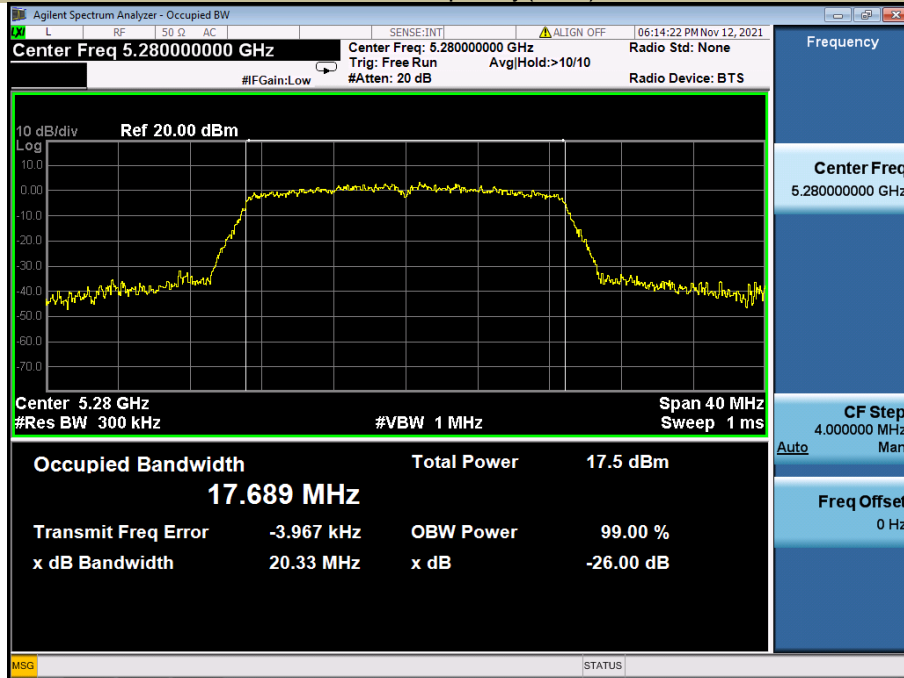

99% & -26 dB Emission Bandwidth
Test Model 802.11n-HT20

U-NII – 2A
Frequency(MHz) 5320

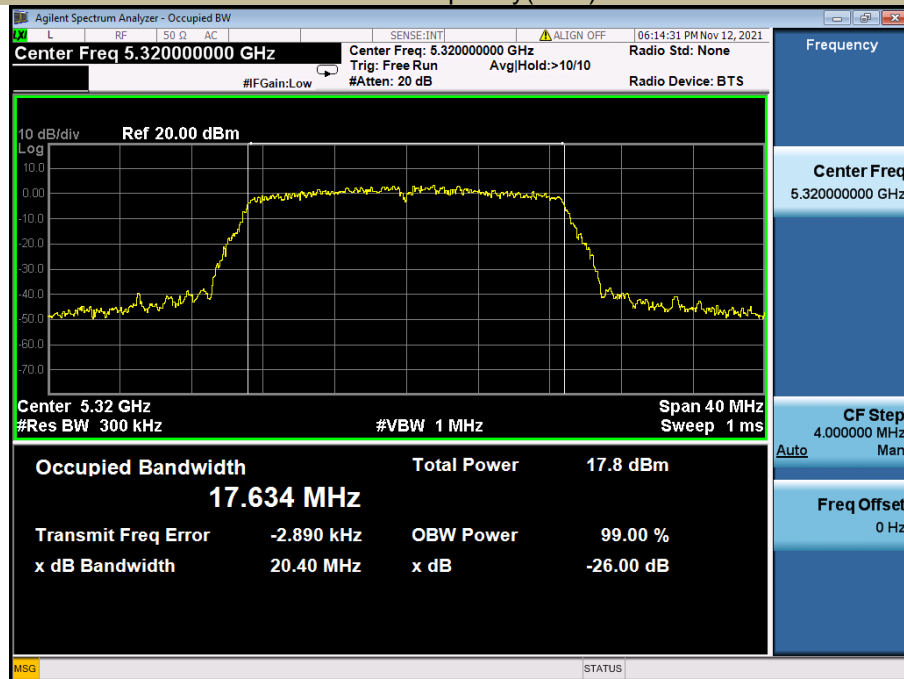

99% & -26 dB Emission Bandwidth U-NII – 2A
 Test Model 802.11ac(HT20) Frequency(MHz) 5260

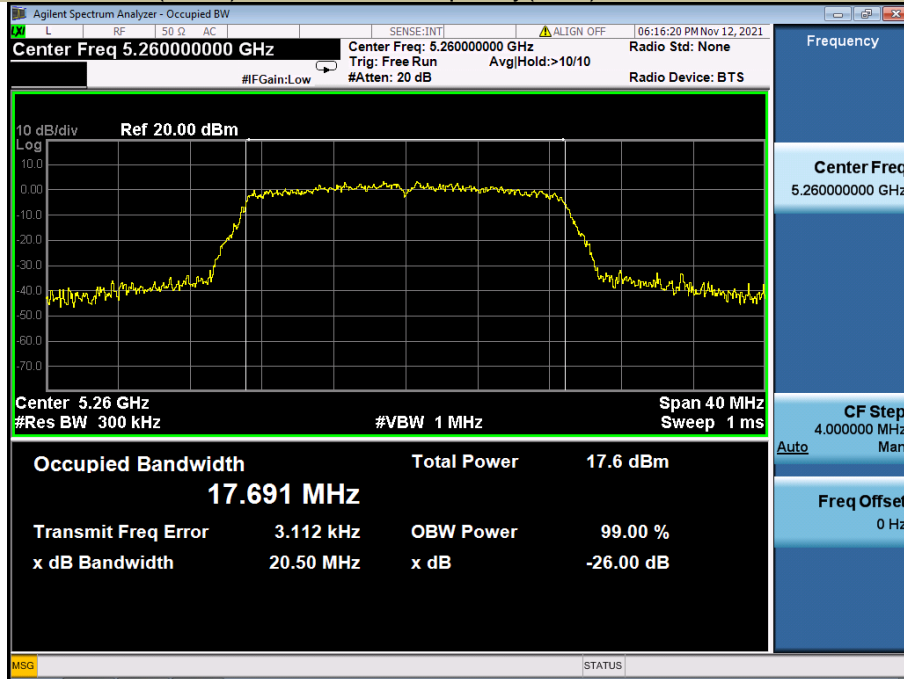

99% & -26 dB Emission Bandwidth U-NII – 2A
 Test Model 802.11ac(HT20) Frequency(MHz) 5280

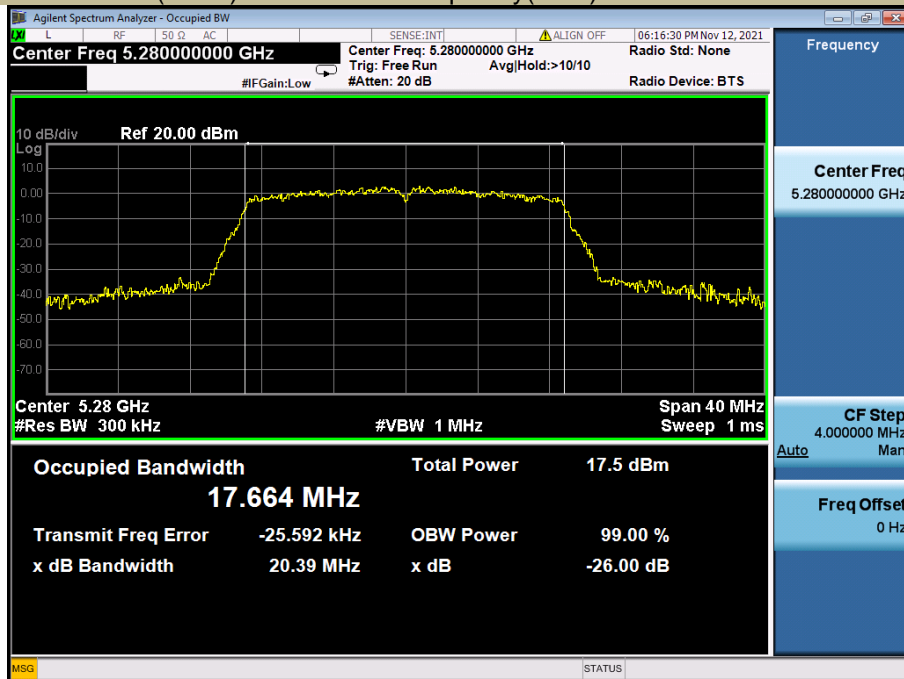

99% & -26 dB Emission Bandwidth
Test Model 802.11ac(HT20)

U-NII – 2A
Frequency(MHz) 5320

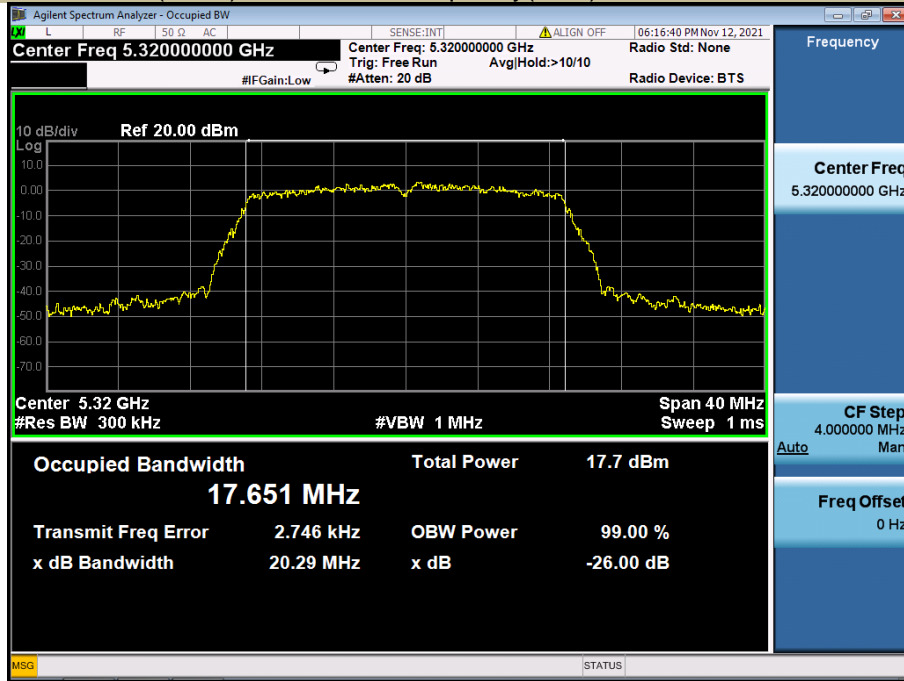

99% & -26 dB Emission Bandwidth
Test Model 802.11n-HT40

U-NII – 2A
Frequency(MHz) 5270

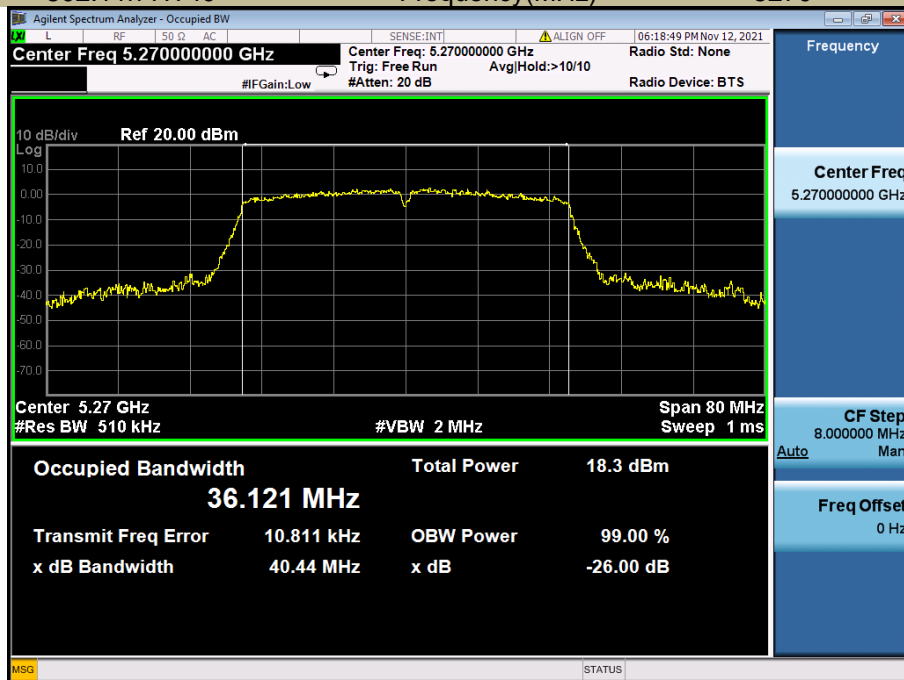

99% & -26 dB Emission Bandwidth
Test Model 802.11n-HT40

U-NII – 2A
Frequency(MHz) 5310

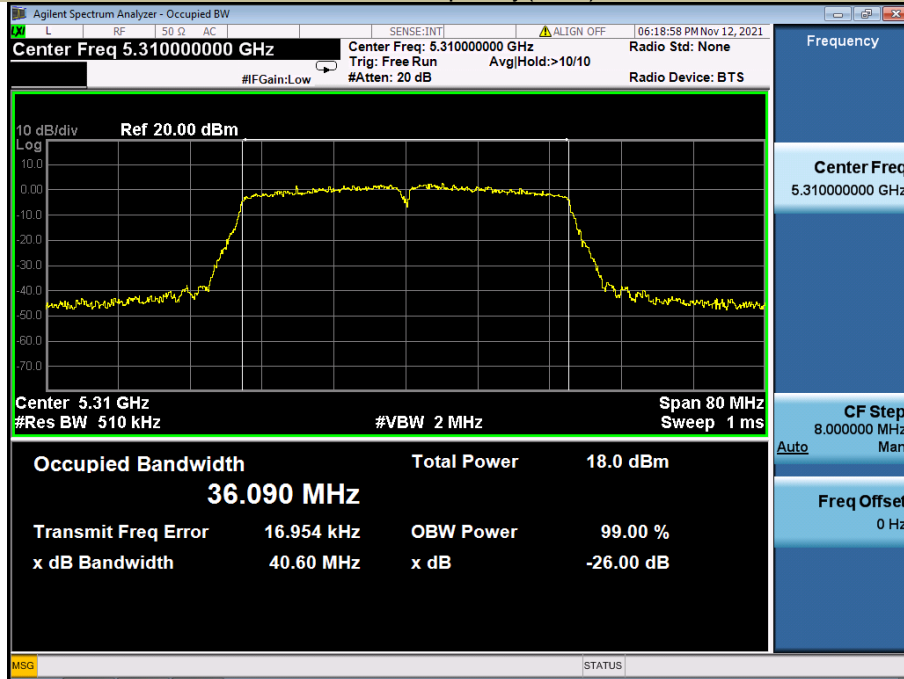

99% & -26 dB Emission Bandwidth
Test Model 802.11ac(HT40)

U-NII – 2A
Frequency(MHz) 5270

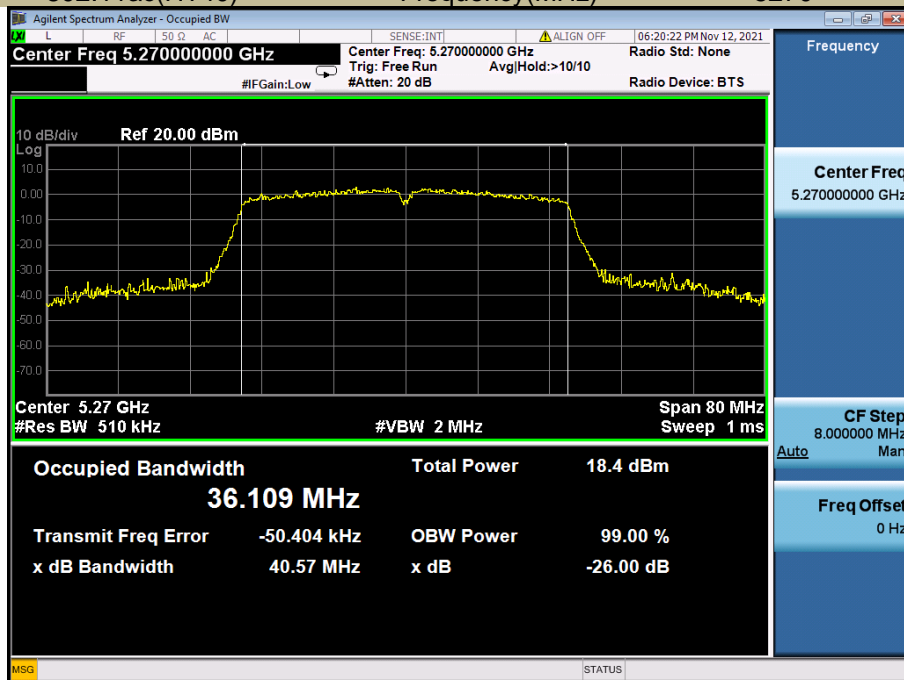

99% & -26 dB Emission Bandwidth
Test Model 802.11ac(HT40)

U-NII – 2A
Frequency(MHz) 5310

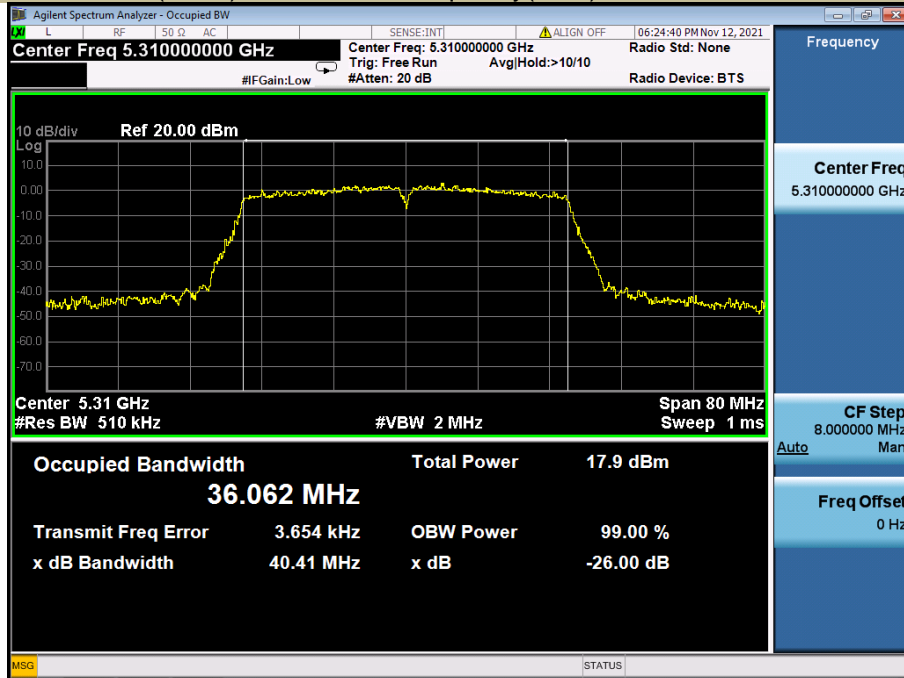

99% & -26 dB Emission Bandwidth
Test Model 802.11ac 80

U-NII – 2A
Frequency(MHz) 5290

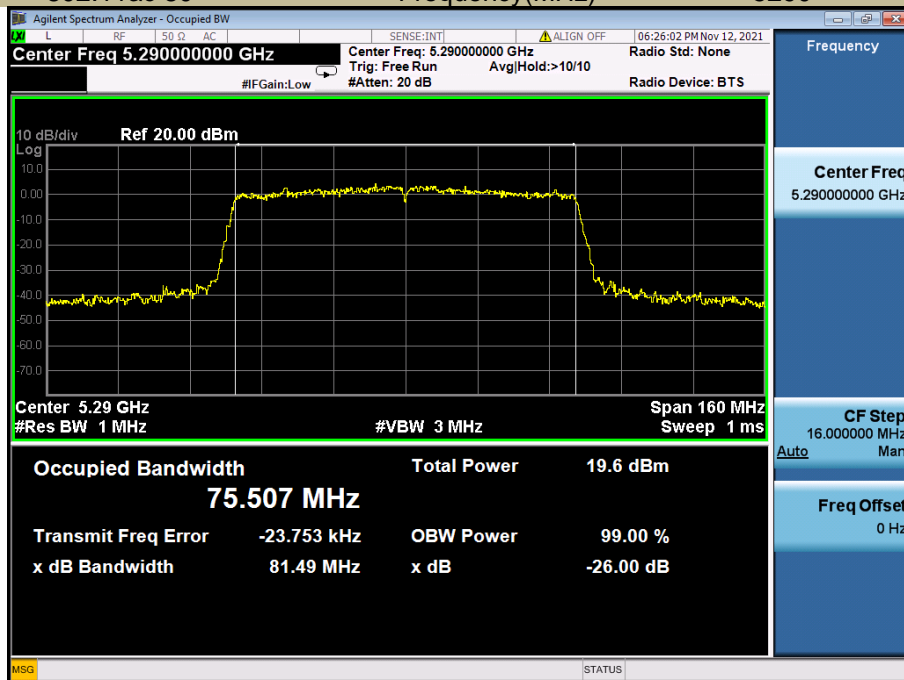

5470-5725MHz

Test Mode	Test Channel MHz		26dB Bandwidth MHz	99% Bandwidth MHz	Verdict
802.11a	CH100	5500	20.09	16.653	Pass
	CH116	5580	20.01	16.666	Pass
	CH140	5700	19.93	16.645	Pass
802.11n-HT20	CH100	5500	20.36	17.640	Pass
	CH116	5580	20.38	17.672	Pass
	CH140	5700	20.51	17.672	Pass
802.11ac(HT20)	CH100	5500	20.32	17.654	Pass
	CH116	5580	20.54	17.676	Pass
	CH140	5700	20.47	17.656	Pass
802.11n-HT40	CH102	5510	40.63	36.109	Pass
	CH134	5670	40.42	36.116	Pass
802.11ac(HT40)	CH102	5510	40.81	36.044	Pass
	CH134	5670	40.30	36.061	Pass
802.11ac(HT80)	CH106	5530	81.16	75.451	Pass

99% & -26 dB Emission Bandwidth
Test Model 802.11a

U-NII – 2C
Frequency(MHz)

5500

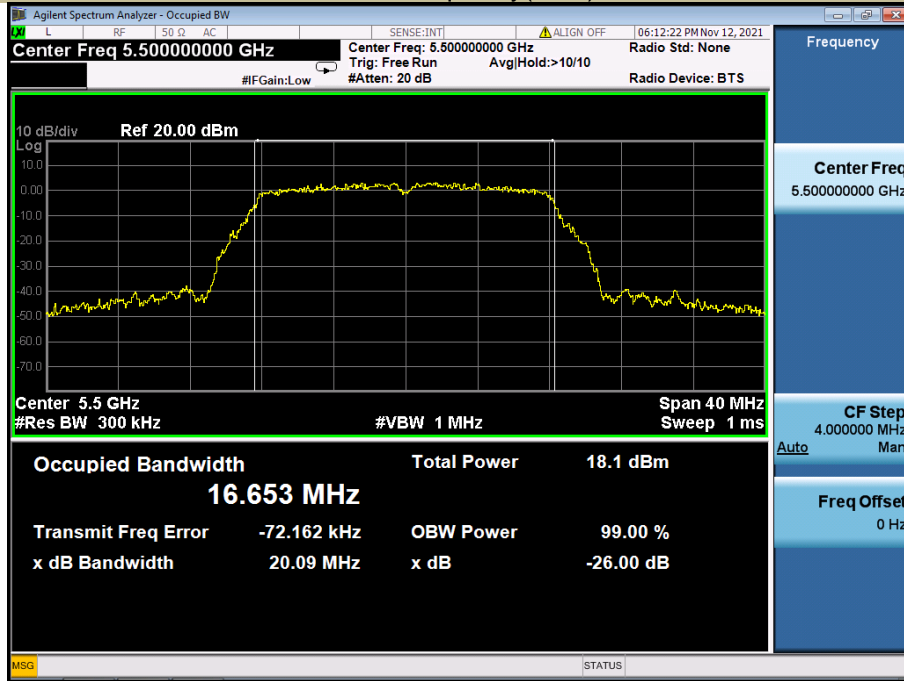

99% & -26 dB Emission Bandwidth
Test Model 802.11a

U-NII – 2C
Frequency(MHz)

5580

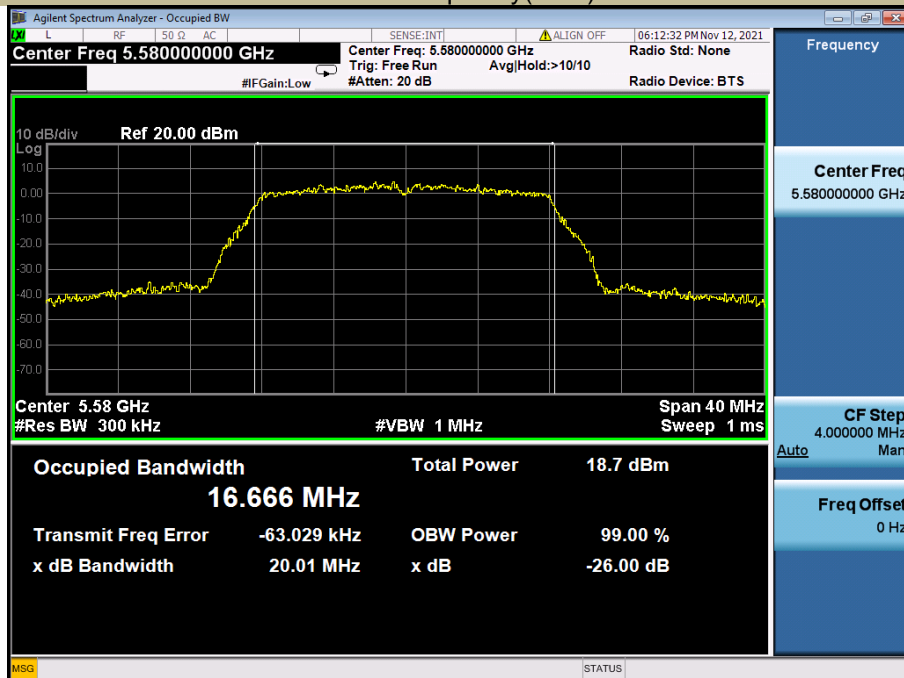

99% & -26 dB Emission Bandwidth
Test Model 802.11a

U-NII – 2C
Frequency(MHz) 5700

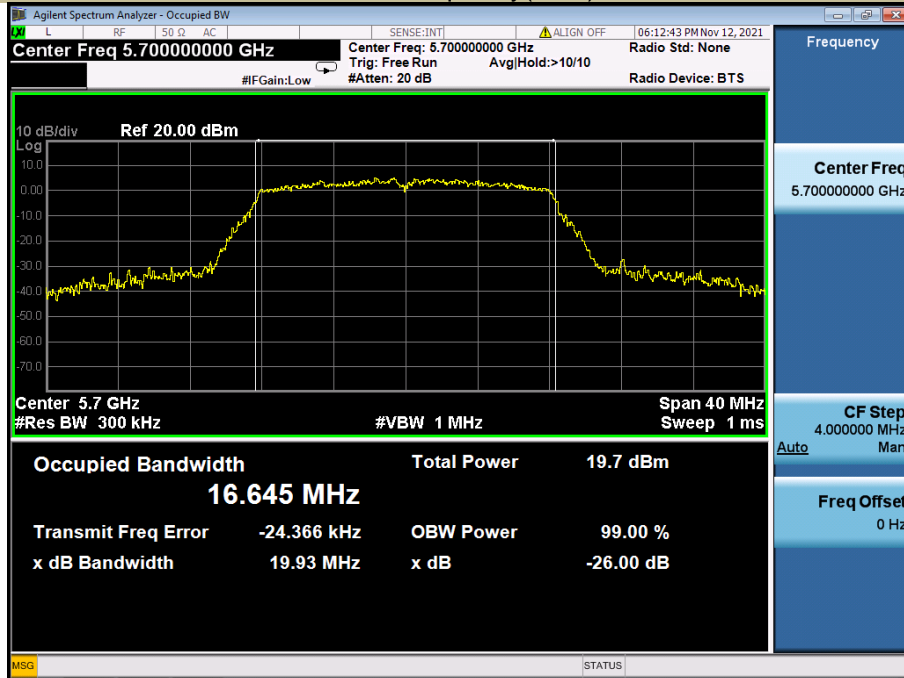

99% & -26 dB Emission Bandwidth
Test Model 802.11n-HT20

U-NII – 2C
Frequency(MHz) 5500

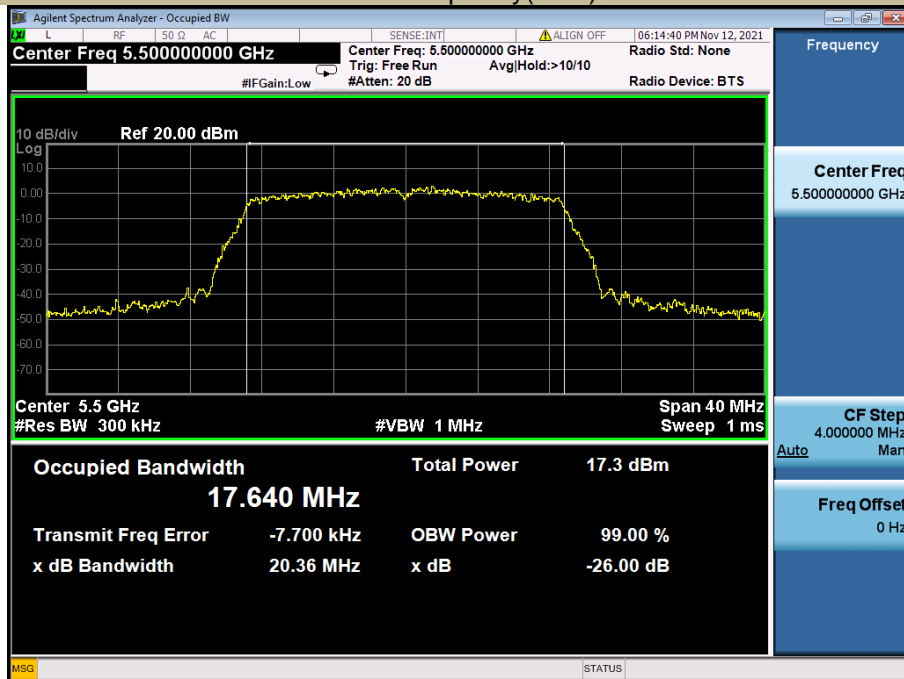

99% & -26 dB Emission Bandwidth
Test Model 802.11n-HT20

U-NII – 2C
Frequency(MHz)

5580

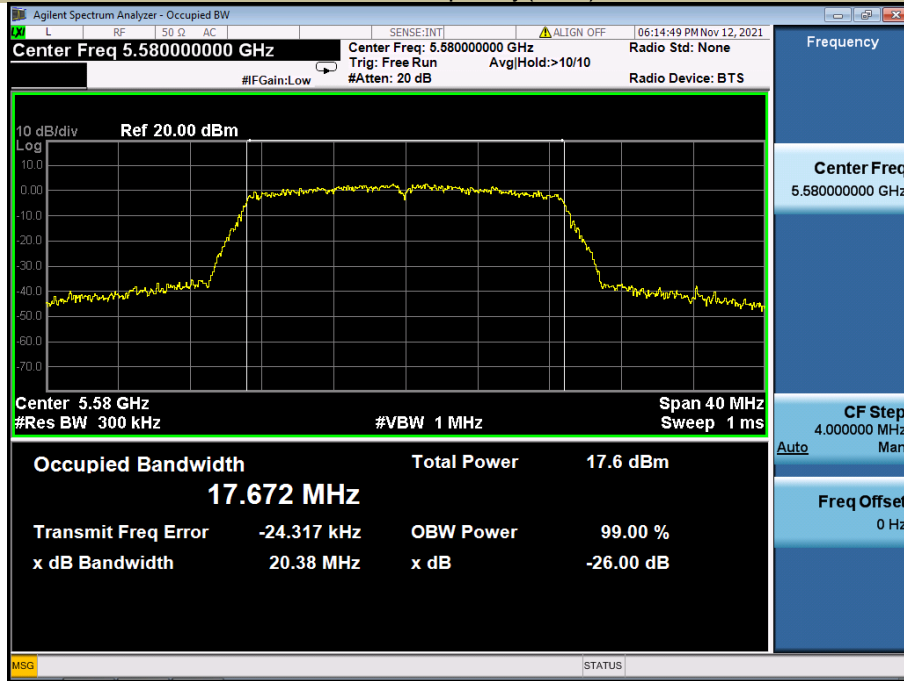

99% & -26 dB Emission Bandwidth
Test Model 802.11n-HT20

U-NII – 2C
Frequency(MHz)

5700

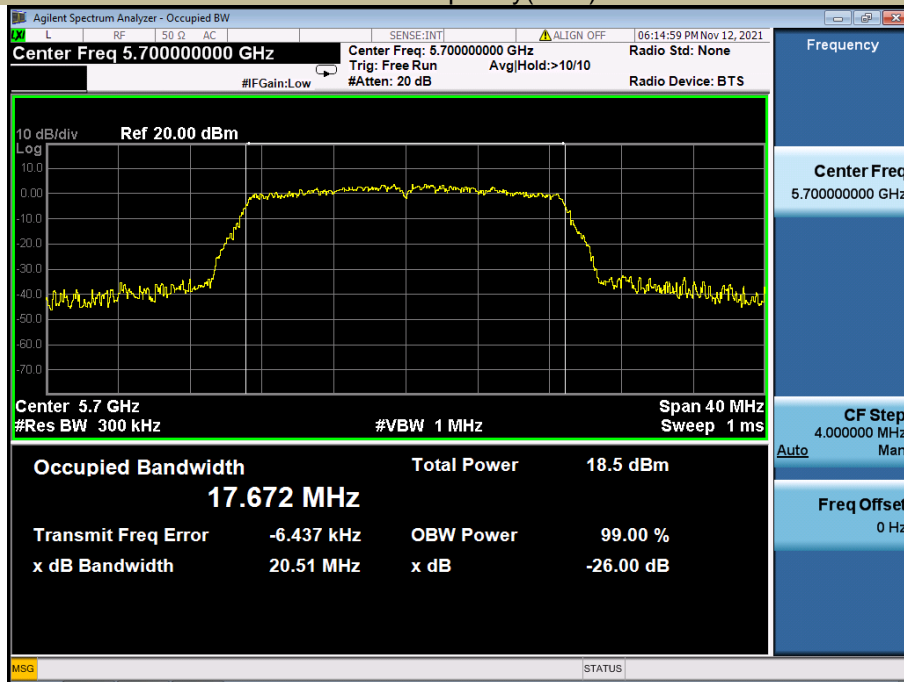

99% & -26 dB Emission Bandwidth
Test Model 802.11ac(HT20)

U-NII – 2C
Frequency(MHz) 5500

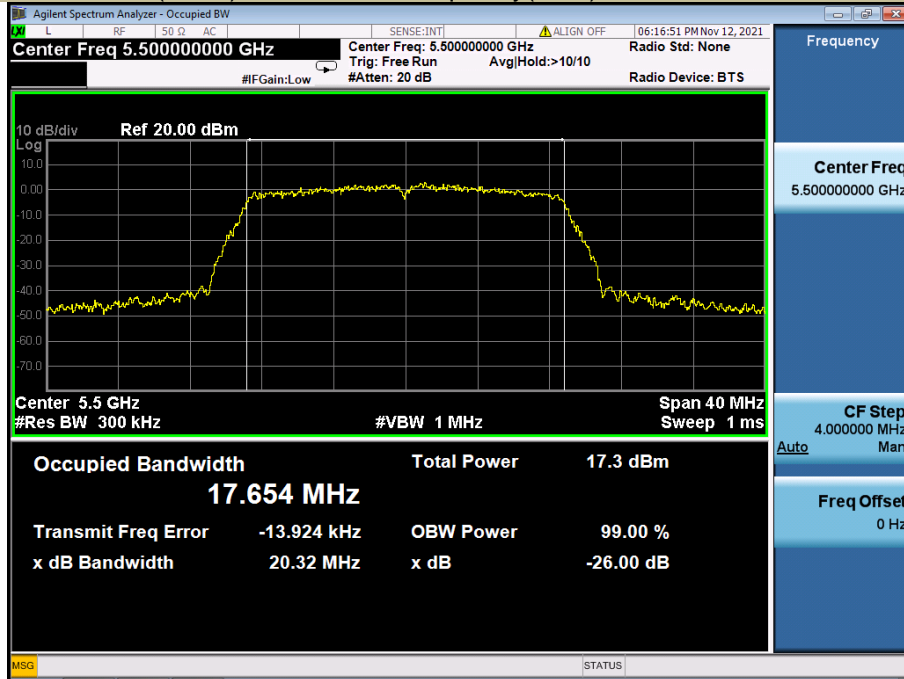

99% & -26 dB Emission Bandwidth
Test Model 802.11ac(HT20)

U-NII – 2C
Frequency(MHz) 5580

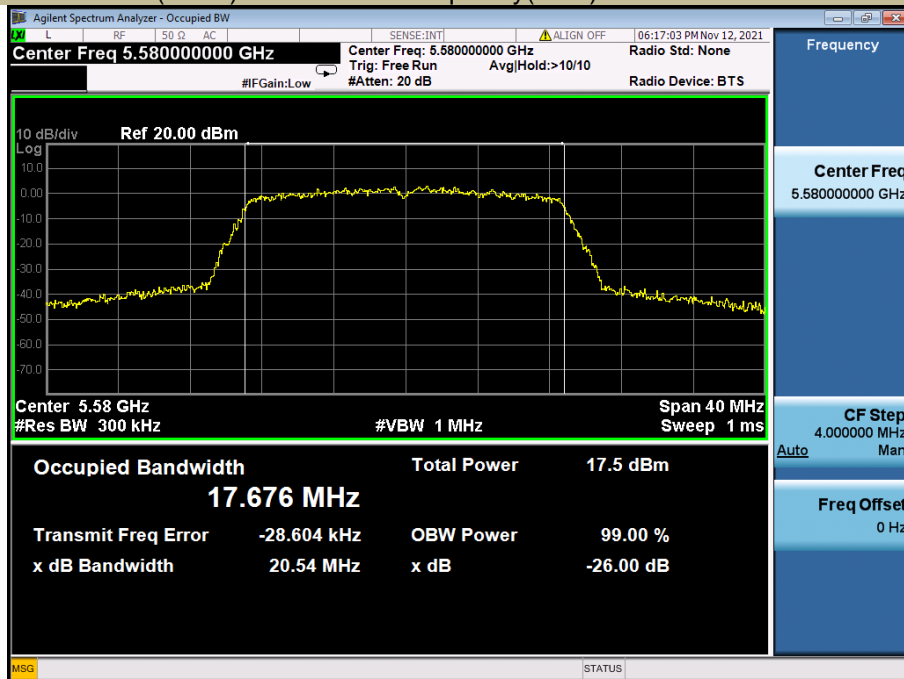

99% & -26 dB Emission Bandwidth
Test Model 802.11ac(HT20)

U-NII – 2C
Frequency(MHz) 5700

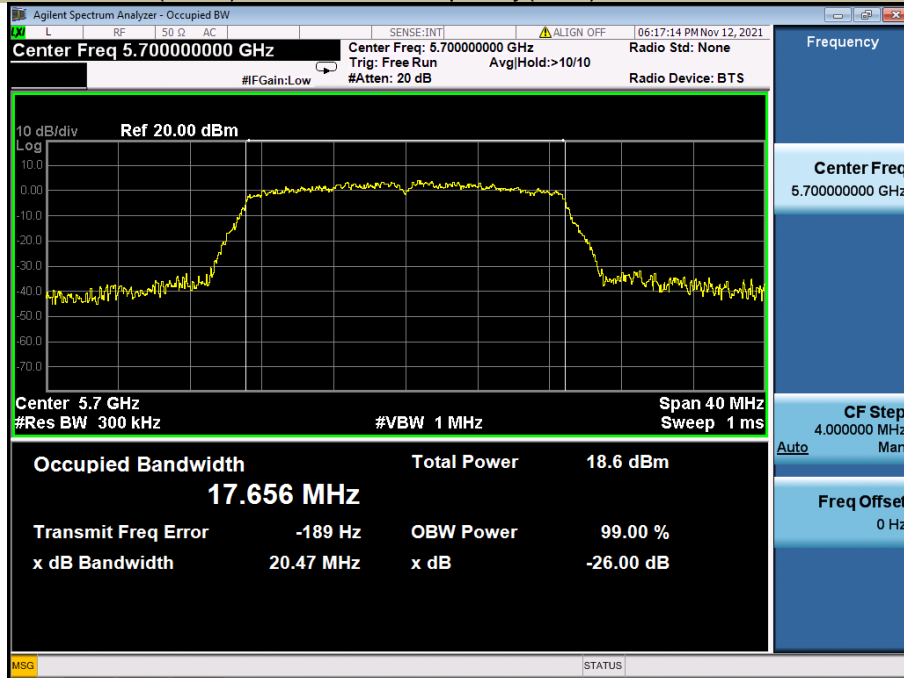

99% & -26 dB Emission Bandwidth
Test Model 802.11n-HT40

U-NII – 2C
Frequency(MHz) 5510

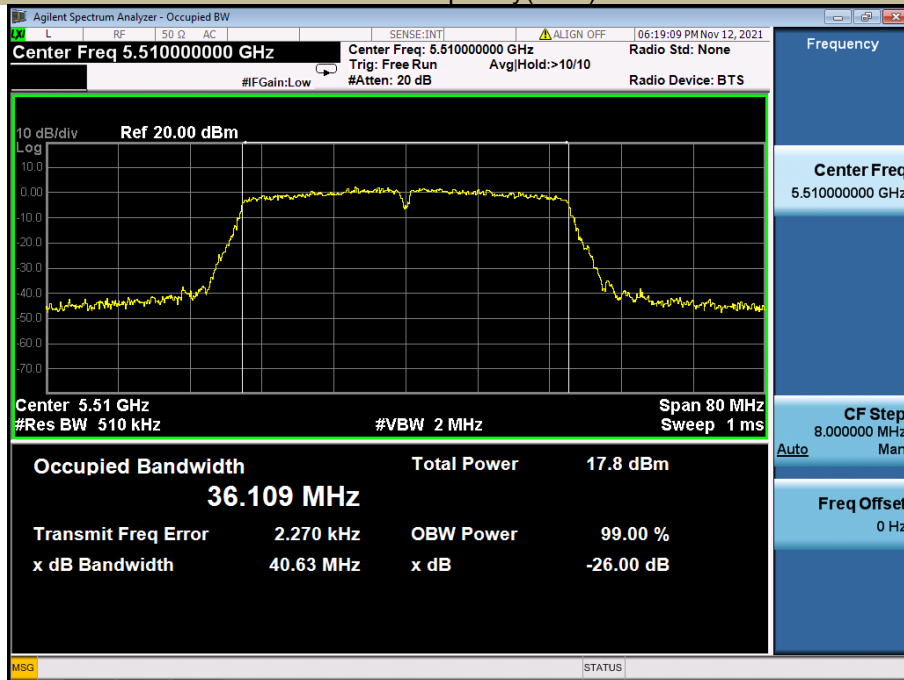

99% & -26 dB Emission Bandwidth
Test Model 802.11n-HT40

U-NII – 2C
Frequency(MHz) 5670

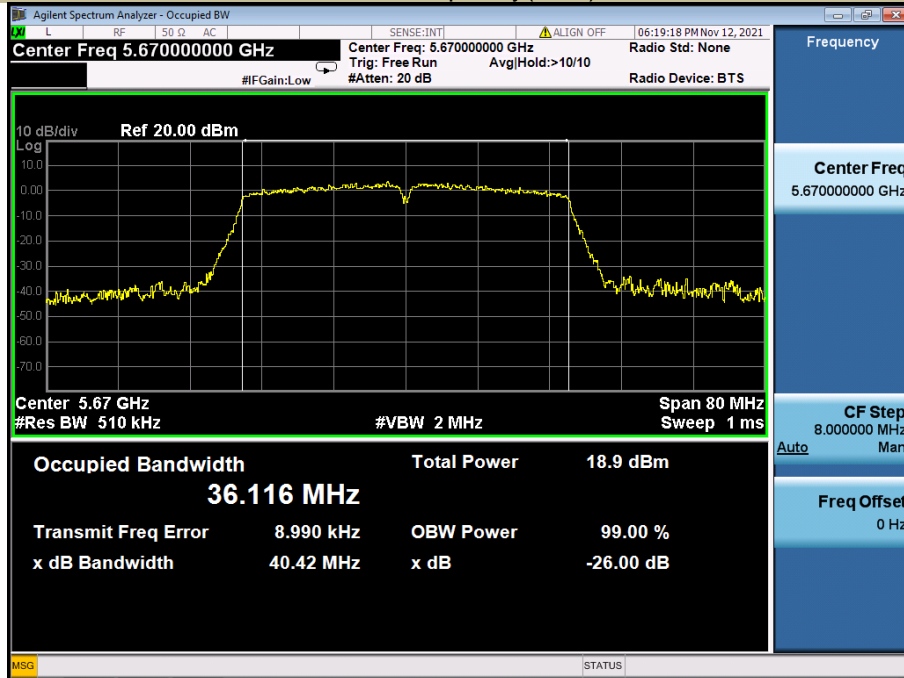

99% & -26 dB Emission Bandwidth
Test Model 802.11ac(HT40)

U-NII – 2C
Frequency(MHz) 5510

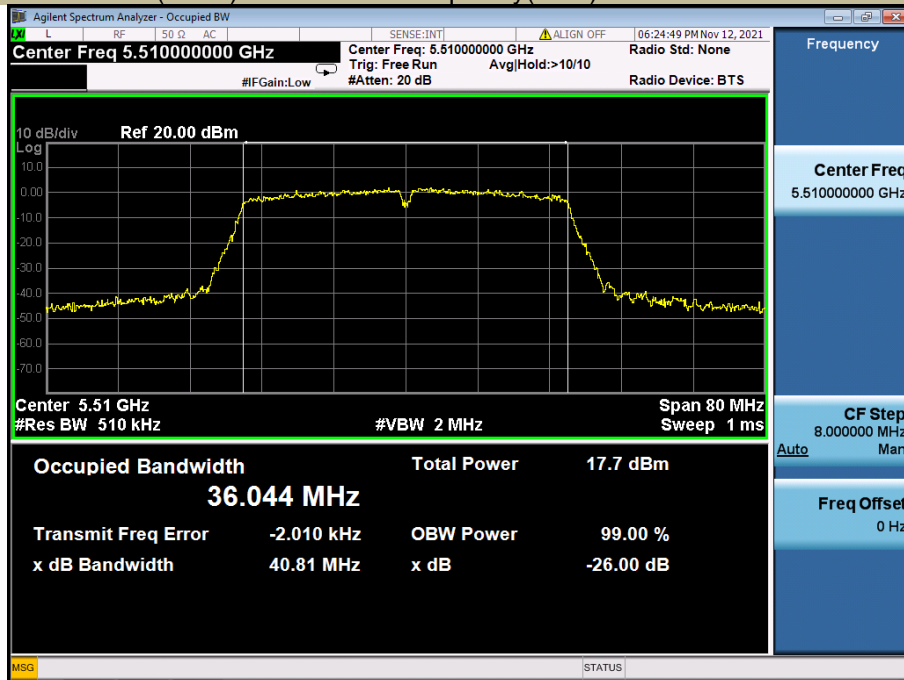

99% & -26 dB Emission Bandwidth
Test Model 802.11ac(HT40)

U-NII – 2C
Frequency(MHz)

5670

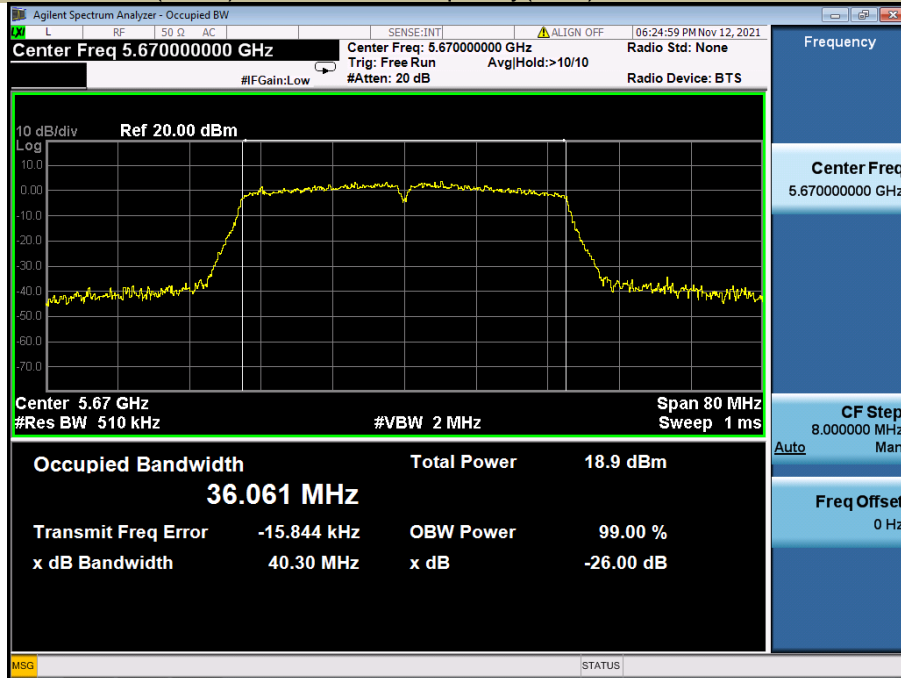

99% & -26 dB Emission Bandwidth
Test Model 802.11ac 80

U-NII – 2C
Frequency(MHz)

5530

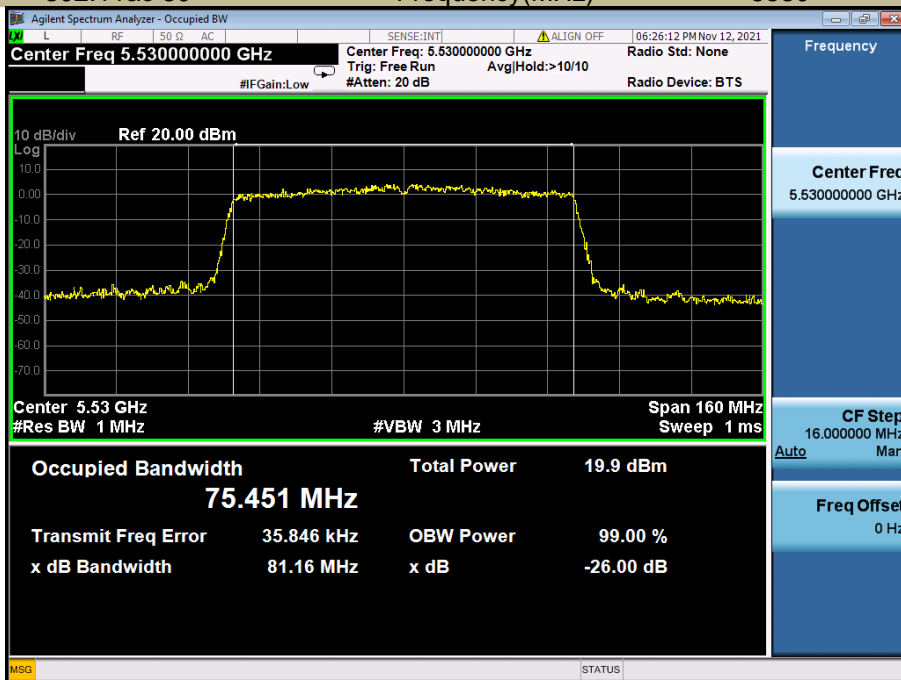

5725-5850MHz

Test Mode	Test Channel MHz		6 dB Bandwidth MHz	99% Bandwidth MHz	Limit kHz
802.11a	CH149	5745	15.16	16.686	≥500
	CH157	5785	15.15	16.579	≥500
	CH165	5825	13.85	16.612	≥500
802.11n-HT20	CH149	5745	15.12	17.661	≥500
	CH157	5785	15.15	17.645	≥500
	CH165	5825	15.16	17.699	≥500
802.11ac(HT20)	CH149	5745	15.13	17.649	≥500
	CH157	5785	15.15	17.611	≥500
	CH165	5825	15.15	17.693	≥500
802.11n-HT40	CH151	5755	35.18	36.088	≥500
	CH159	5795	35.19	35.996	≥500
802.11ac(HT40)	CH151	5755	35.20	36.075	≥500
	CH159	5795	35.13	36.011	≥500
802.11ac(HT80)	CH155	5775	75.30	75.327	≥500

99% Occupied Bandwidth
Test Model 802.11a

U-NII - 3
Frequency(MHz)

5745

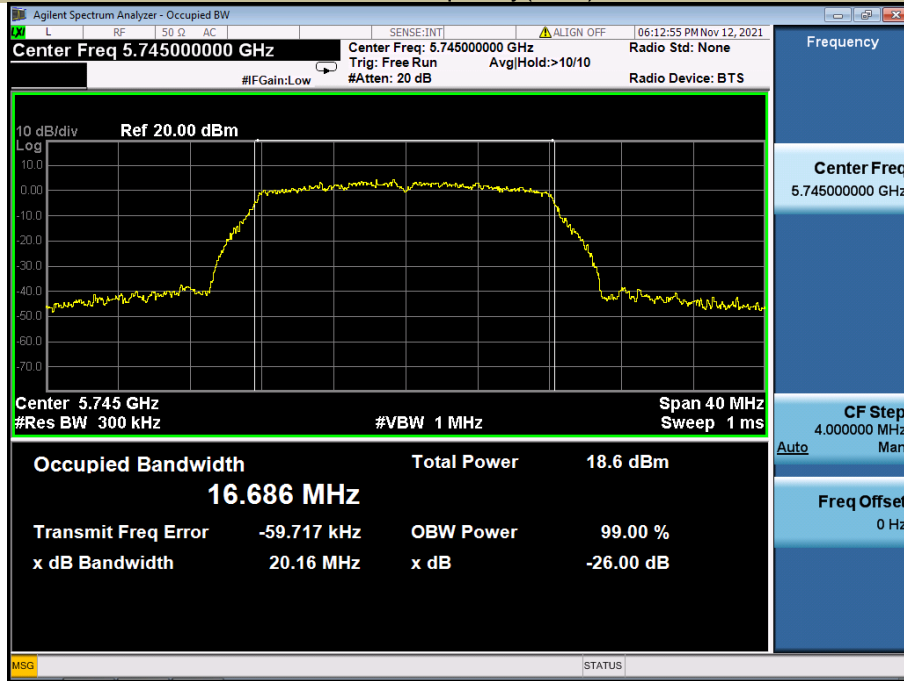

99% Occupied Bandwidth
Test Model 802.11a

U-NII - 3
Frequency(MHz)

5785

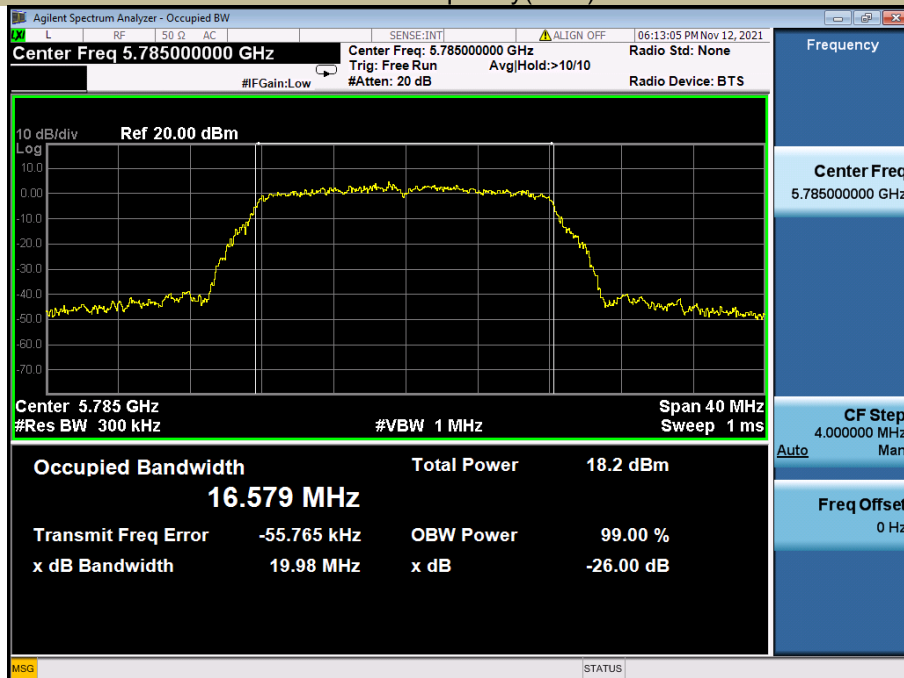

99% Occupied Bandwidth
Test Model 802.11a

U-NII - 3
Frequency(MHz)

5825

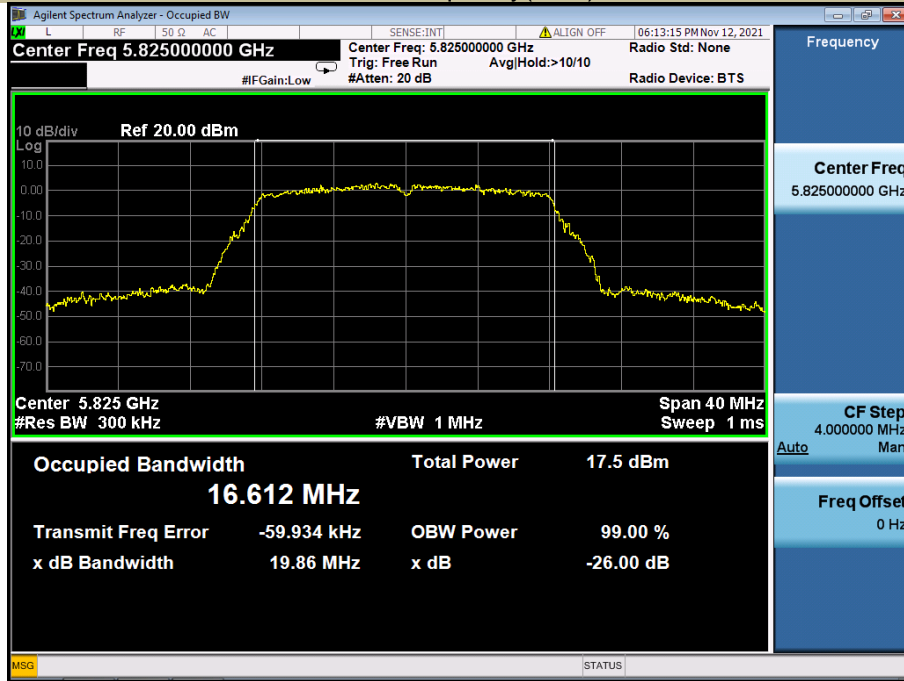

99% Occupied Bandwidth
Test Model 802.11n-HT20

U-NII - 3
Frequency(MHz)

5745

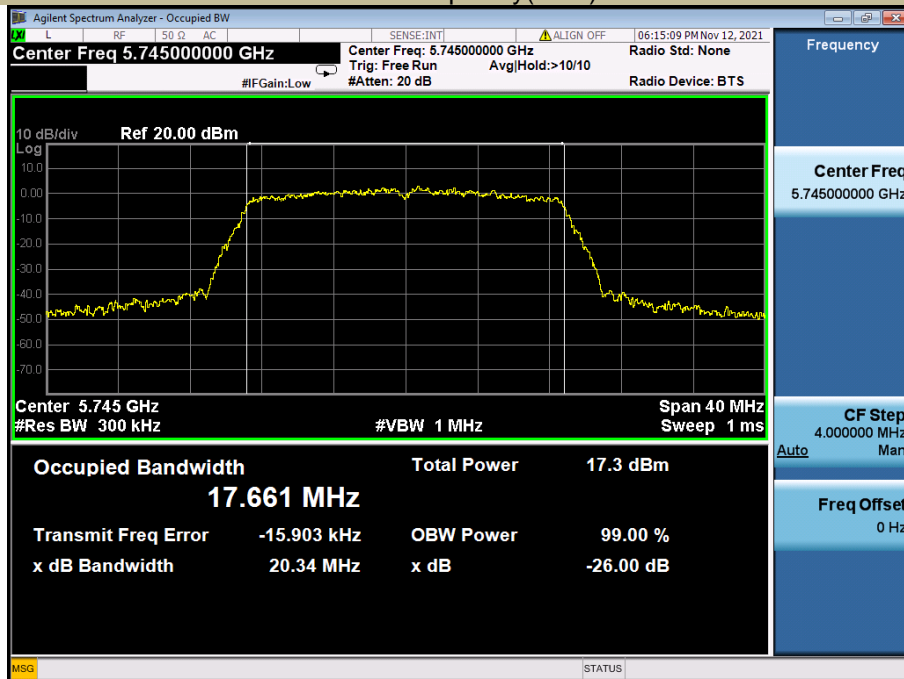

99% Occupied Bandwidth
Test Model 802.11n-HT20

U-NII - 3
Frequency(MHz)

5785

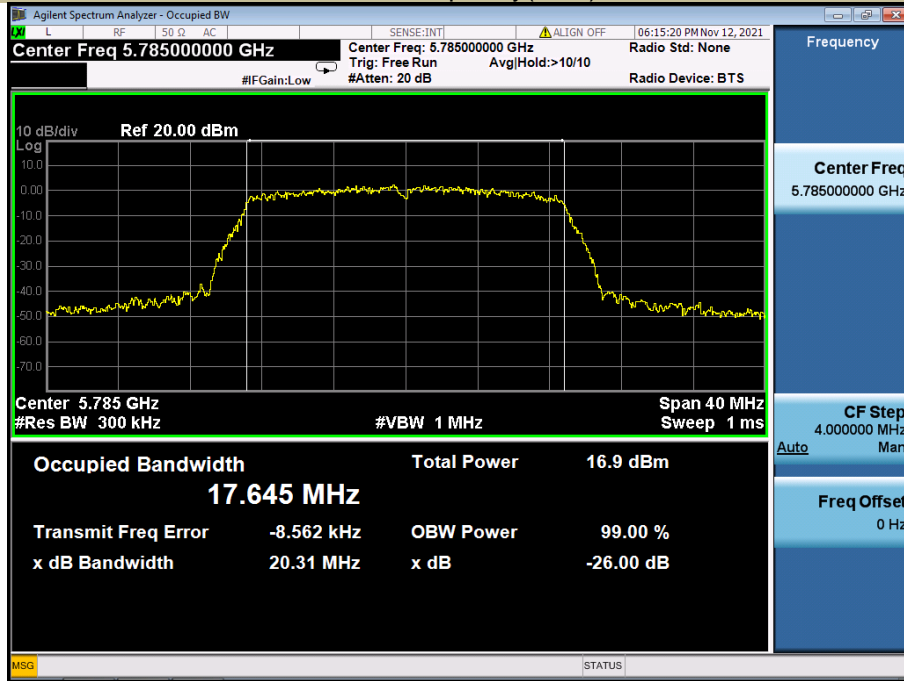

99% Occupied Bandwidth
Test Model 802.11n-HT20

U-NII - 3
Frequency(MHz)

5825

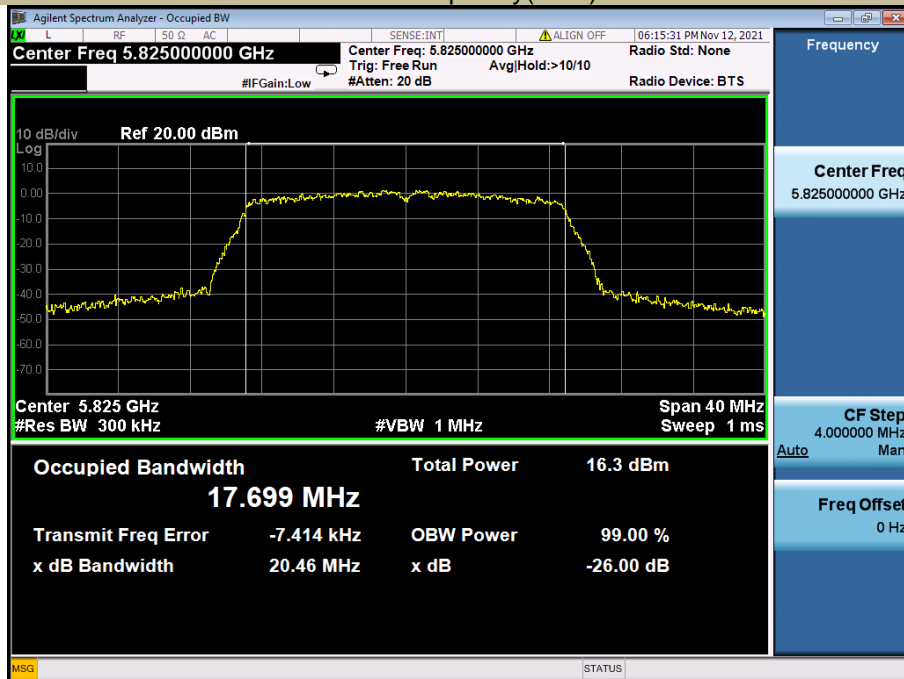

99% Occupied Bandwidth
Test Model 802.11ac(HT20)

U-NII - 3
Frequency(MHz) 5745

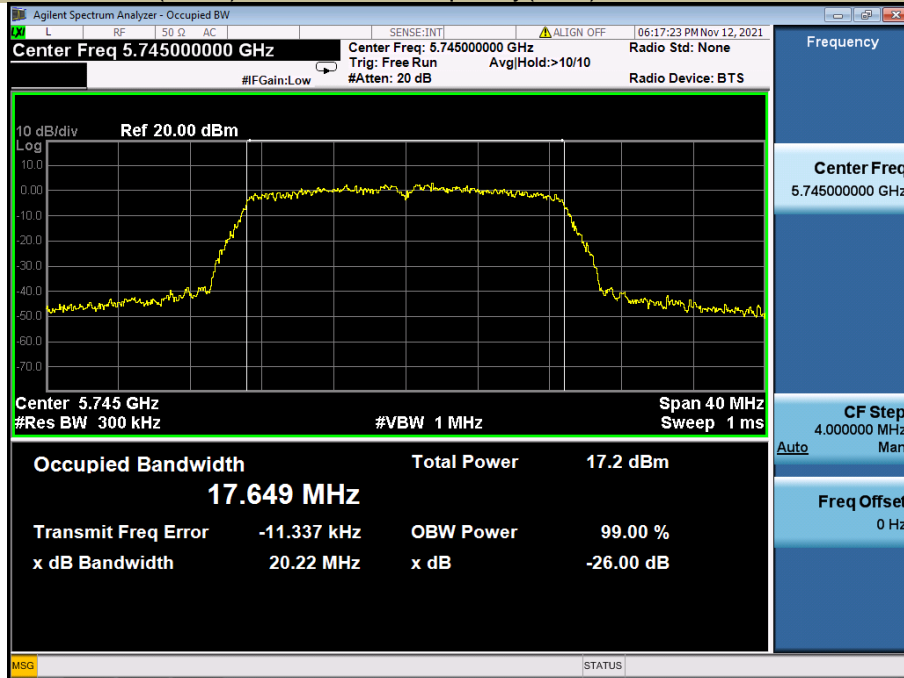

99% Occupied Bandwidth
Test Model 802.11ac(HT20)

U-NII - 3
Frequency(MHz) 5785

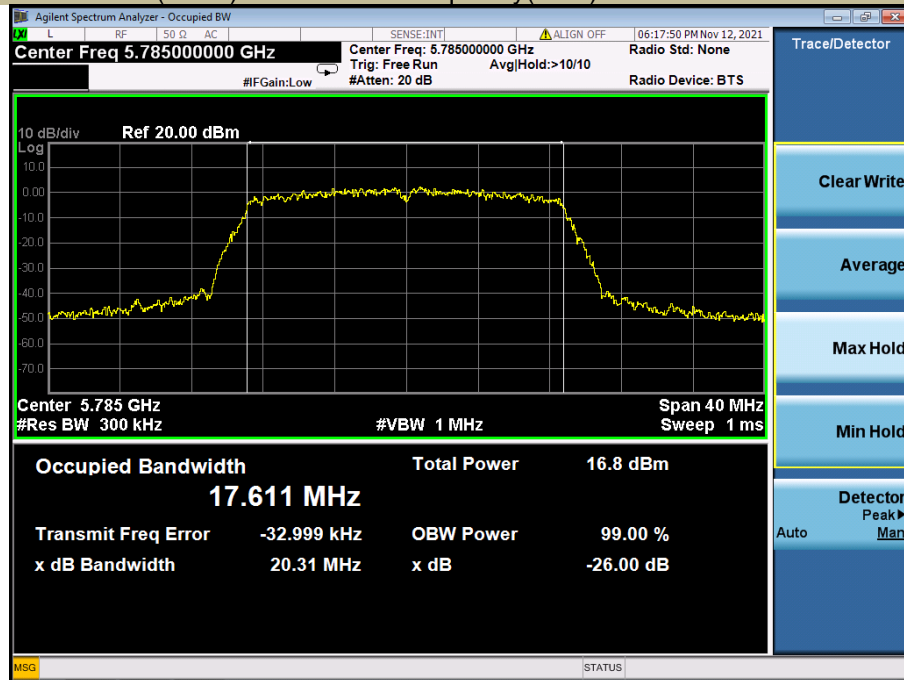

99% Occupied Bandwidth
Test Model 802.11ac(HT20)

U-NII - 3
Frequency(MHz) 5825

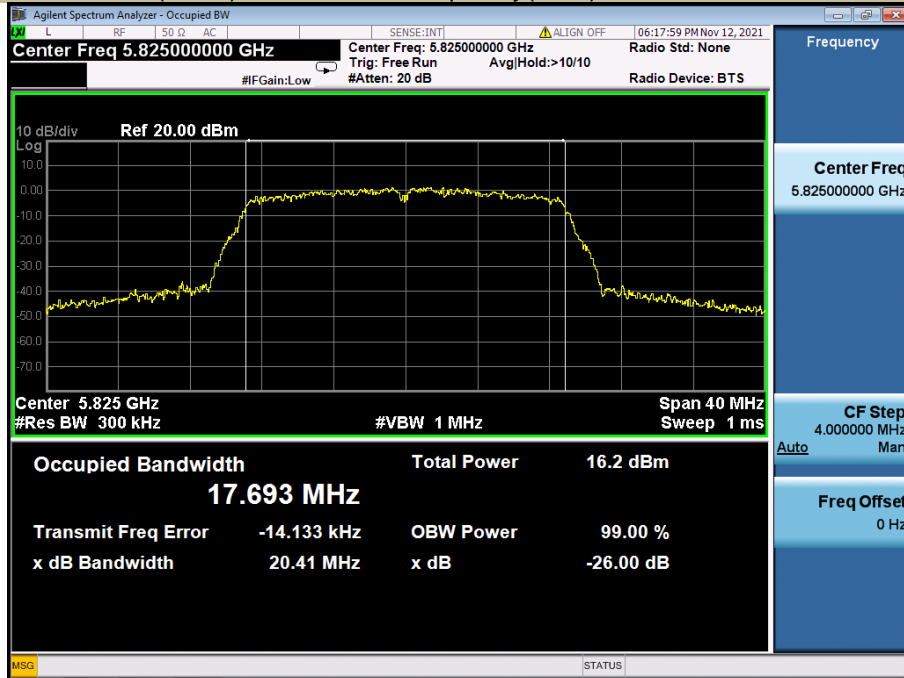

99% Occupied Bandwidth
Test Model 802.11n-HT40

U-NII - 3
Frequency(MHz) 5755

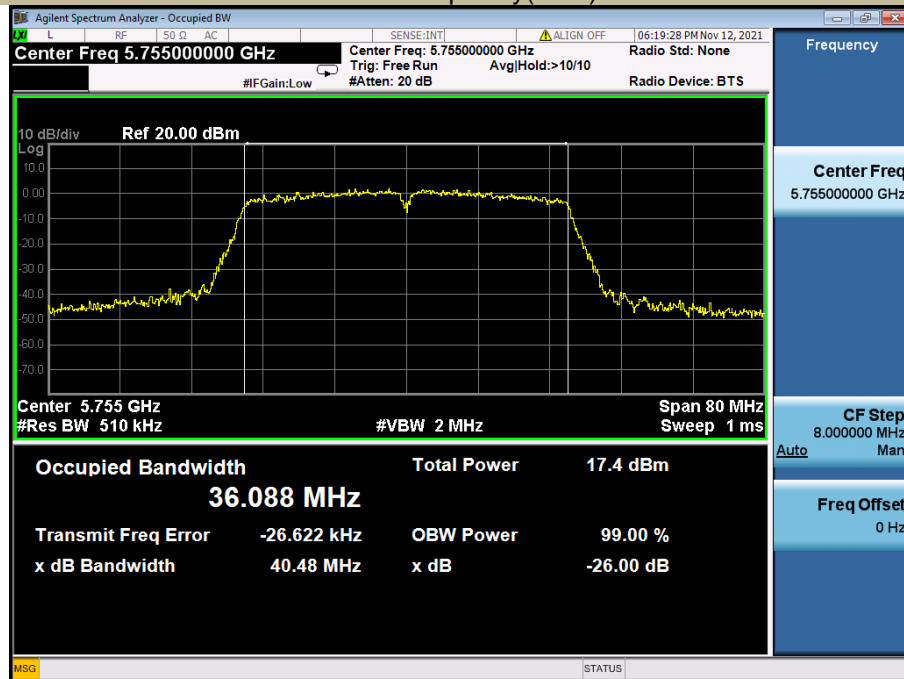

99% Occupied Bandwidth
Test Model 802.11n-HT40

U-NII - 3
Frequency(MHz)

5795

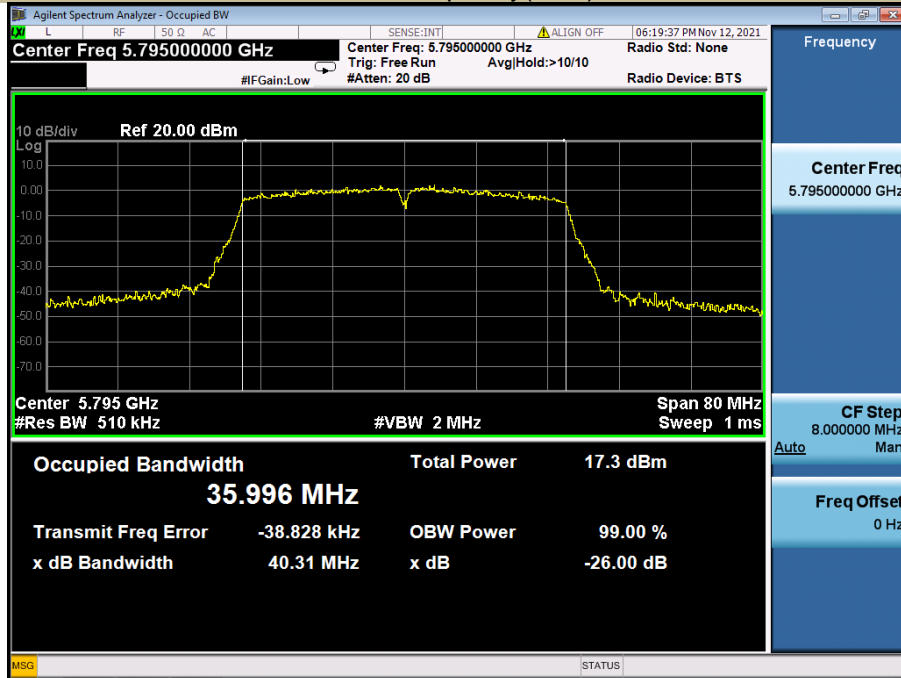

99% Occupied Bandwidth
Test Model 802.11ac(HT40)

U-NII - 3
Frequency(MHz)

5755

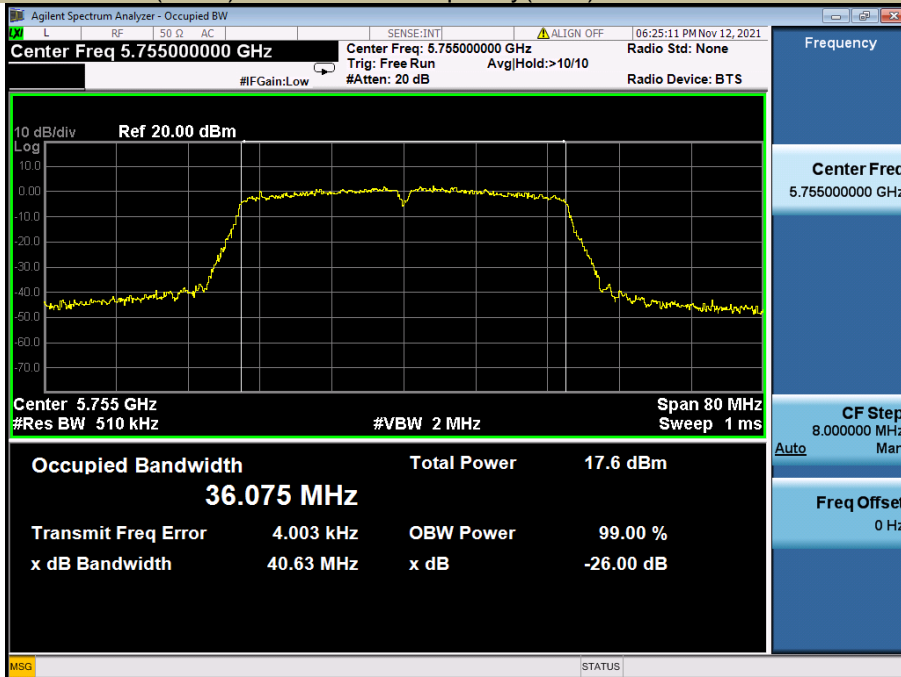

99% Occupied Bandwidth
Test Model 802.11ac(HT40)

U-NII - 3
Frequency(MHz) 5795

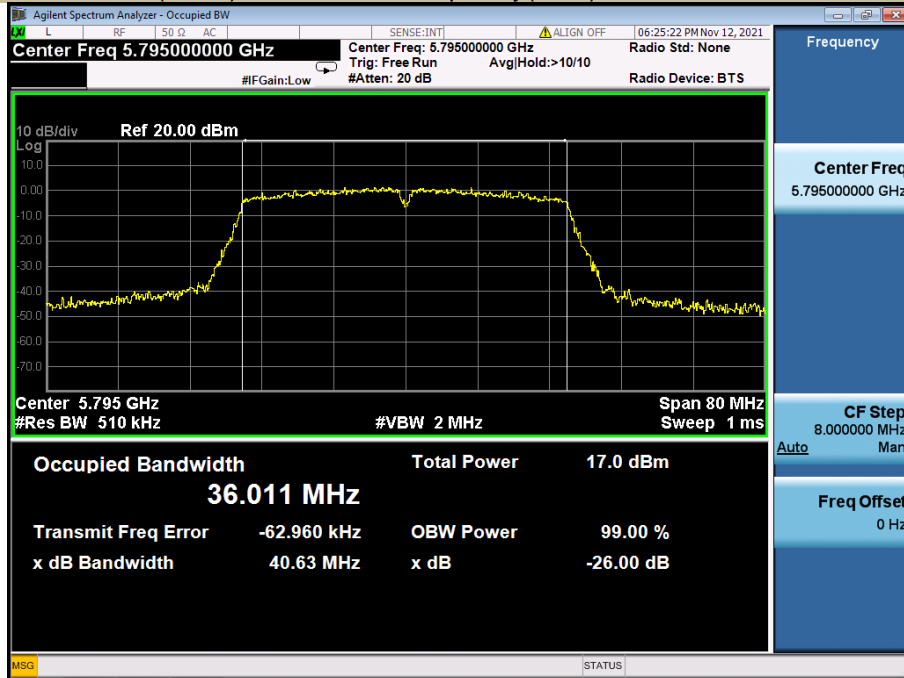

99% Occupied Bandwidth
Test Model 802.11ac 80

U-NII - 3
Frequency(MHz) 5775

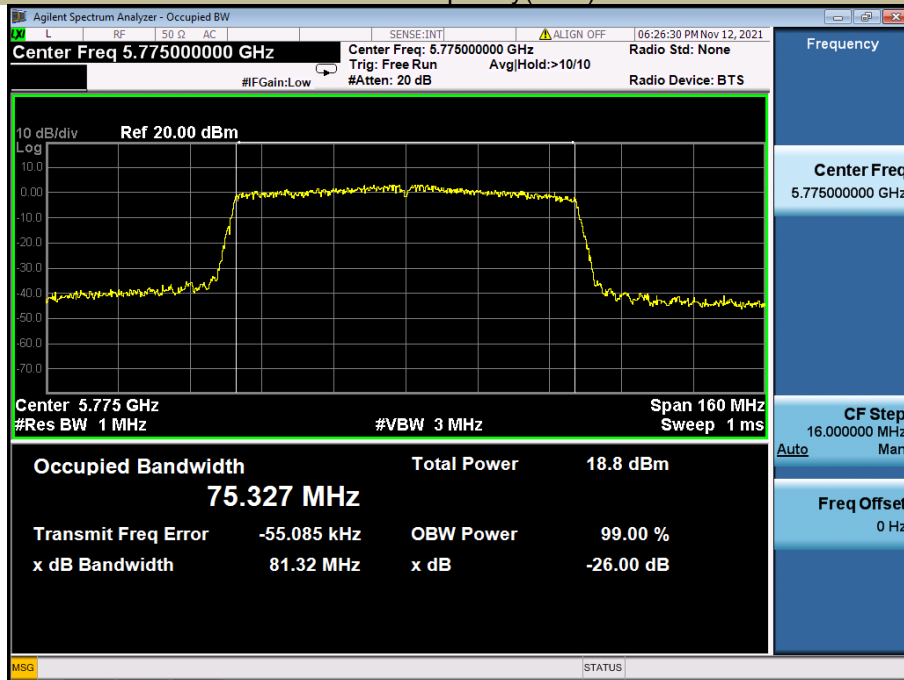

-6 dB Emission Bandwidth U-NII - 3
 Test Model 802.11a Frequency(MHz) 5745

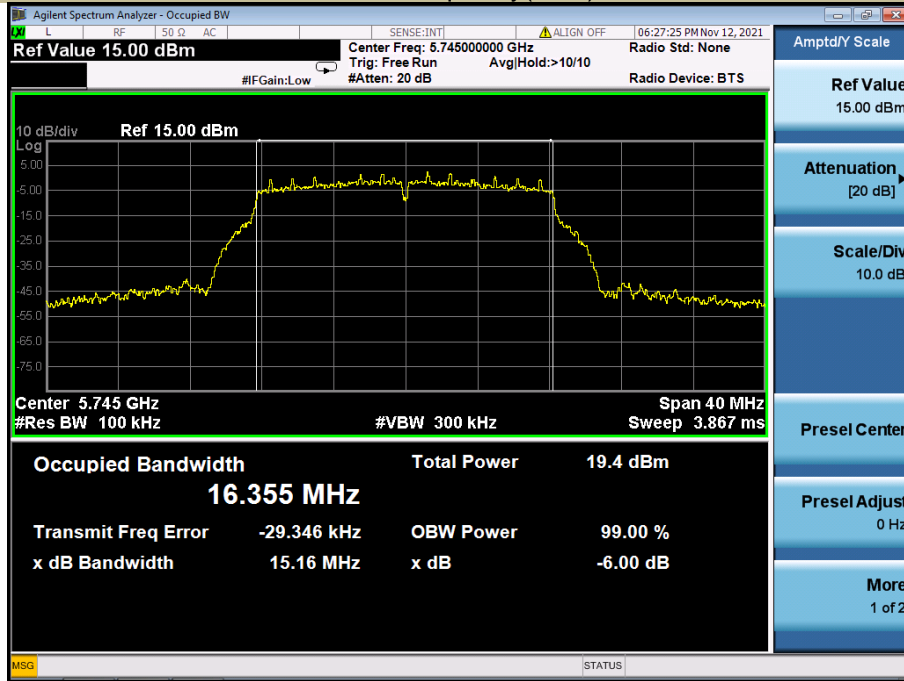

-6 dB Emission Bandwidth U-NII - 3
 Test Model 802.11a Frequency(MHz) 5785

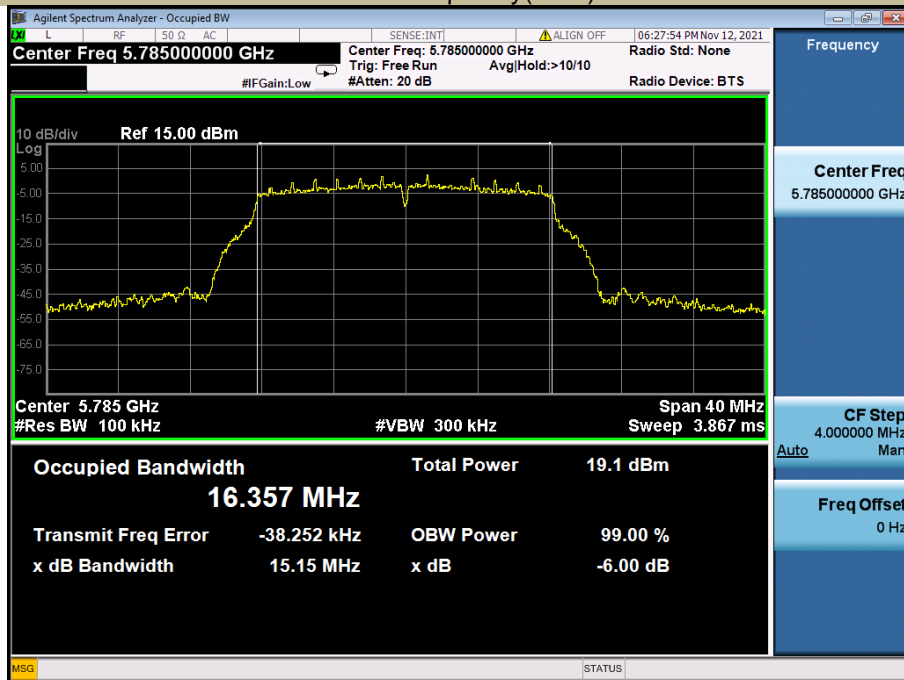

-6 dB Emission Bandwidth U-NII - 3
 Test Model 802.11a Frequency(MHz) 5825

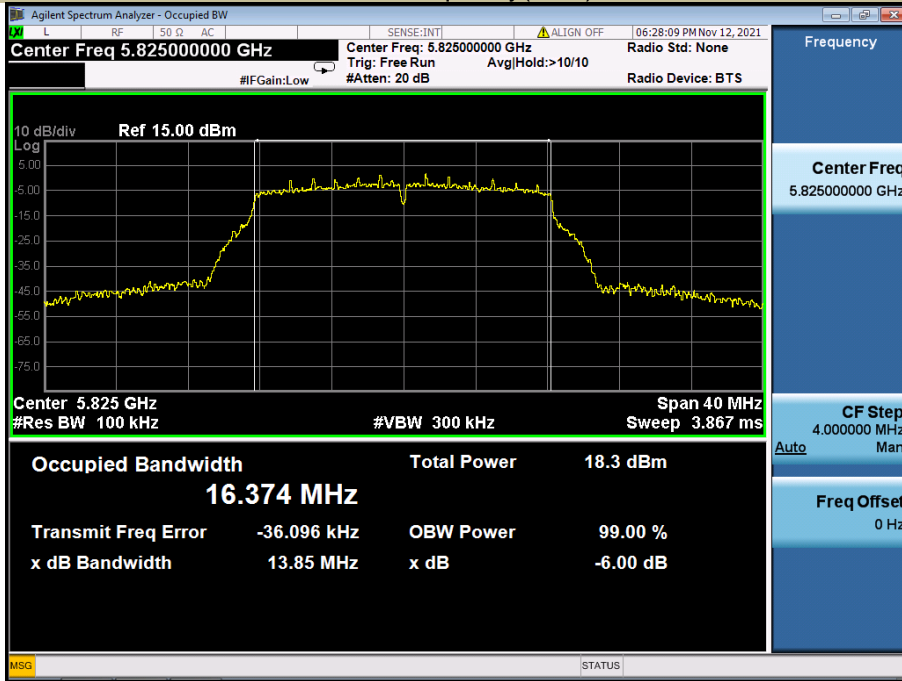

-6 dB Emission Bandwidth U-NII - 3
 Test Model 802.11n-HT20 Frequency(MHz) 5745

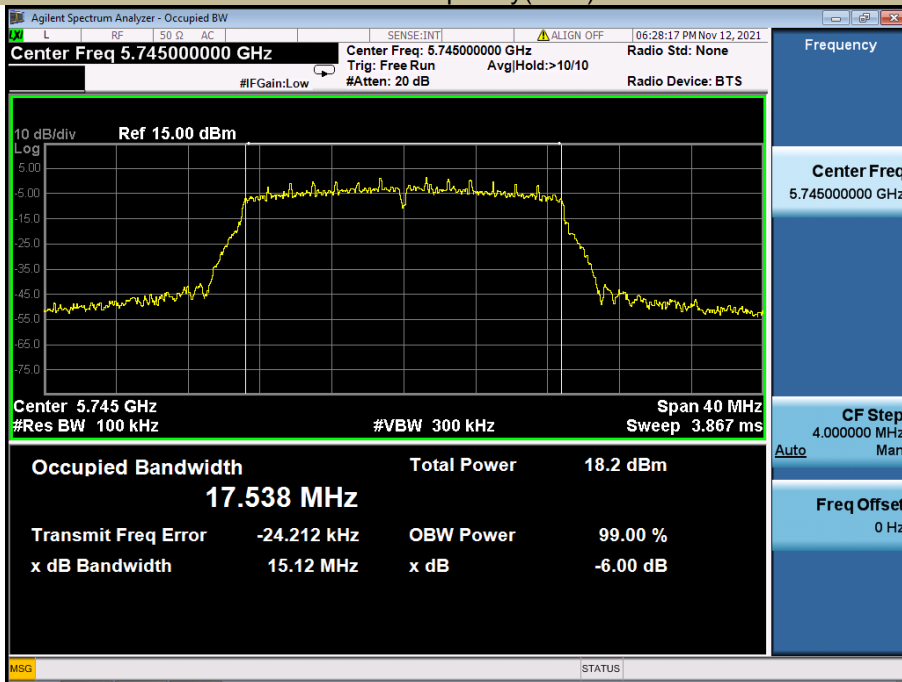

-6 dB Emission Bandwidth **U-NII - 3**
Test Model 802.11n-HT20 **Frequency(MHz)** **5785**

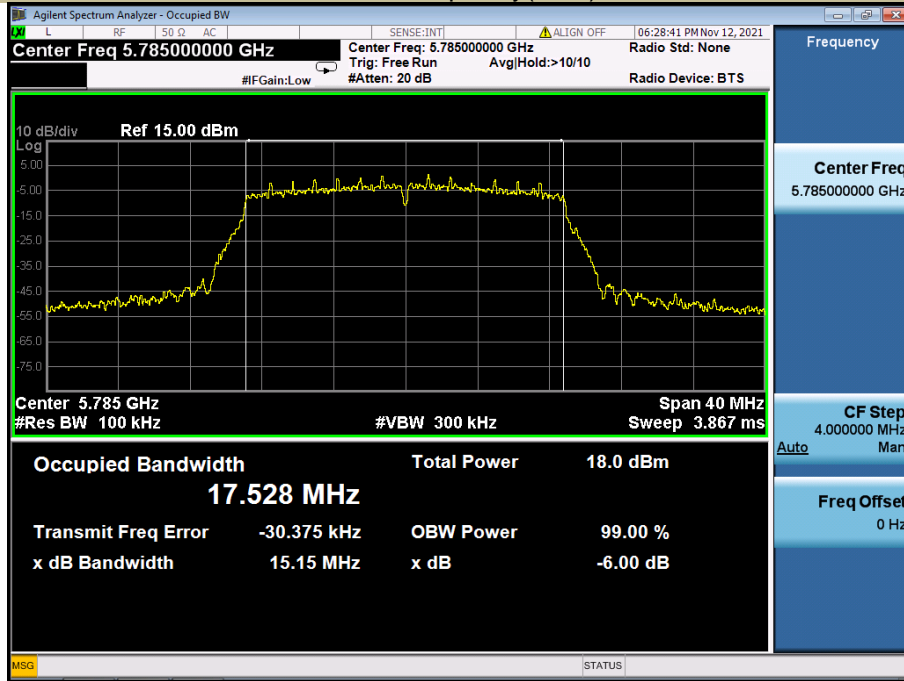

-6 dB Emission Bandwidth **U-NII - 3**
Test Model 802.11n-HT20 **Frequency(MHz)** **5825**

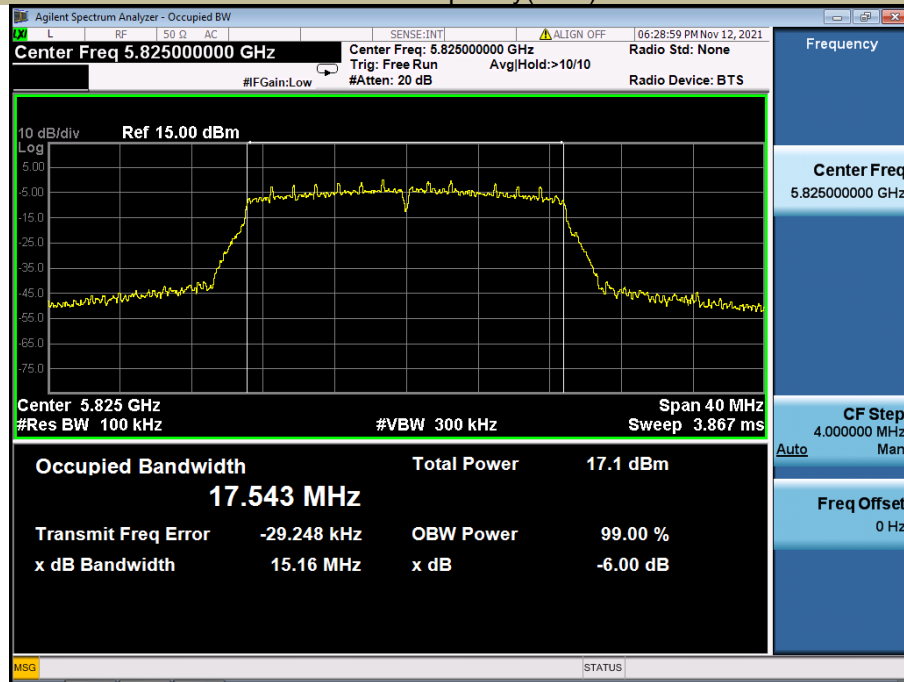

-6 dB Emission Bandwidth **U-NII - 3**
Test Model 802.11ac(HT20) **Frequency(MHz)** **5745**

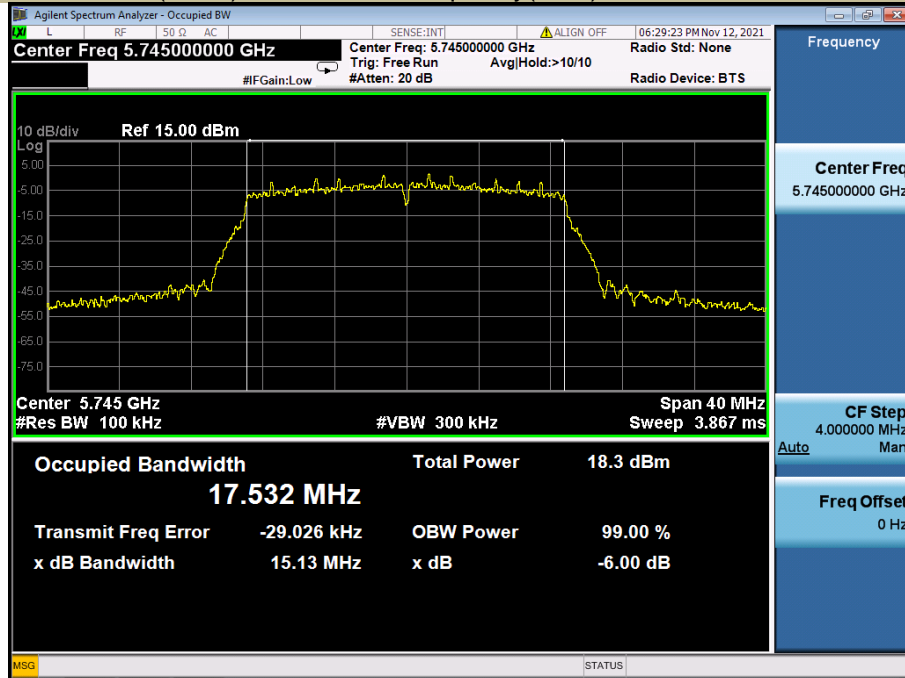

-6 dB Emission Bandwidth **U-NII - 3**
Test Model 802.11ac(HT20) **Frequency(MHz)** **5785**

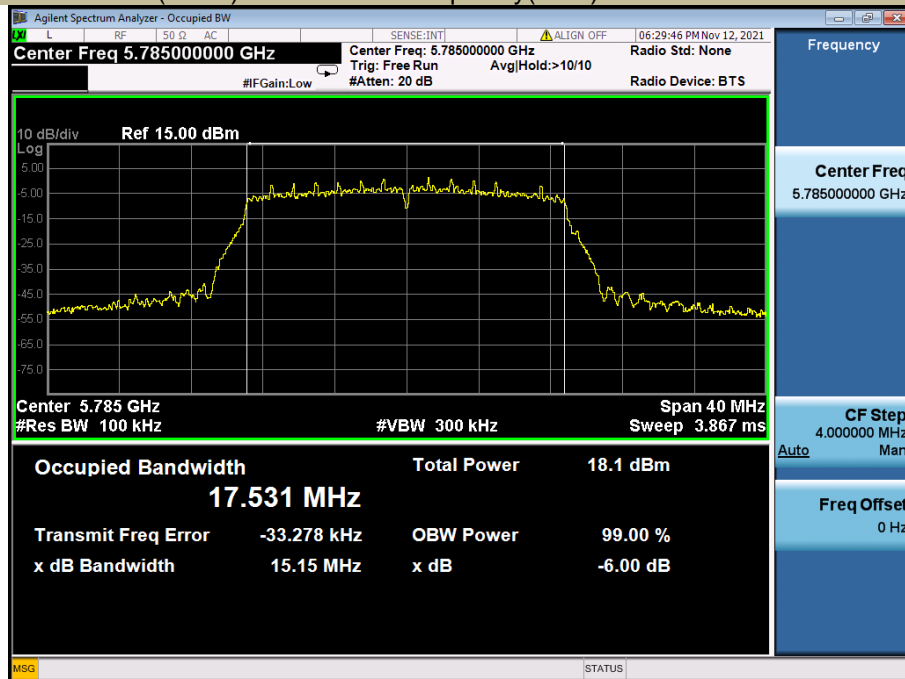

-6 dB Emission Bandwidth U-NII - 3
 Test Model 802.11ac(HT20) Frequency(MHz) 5825

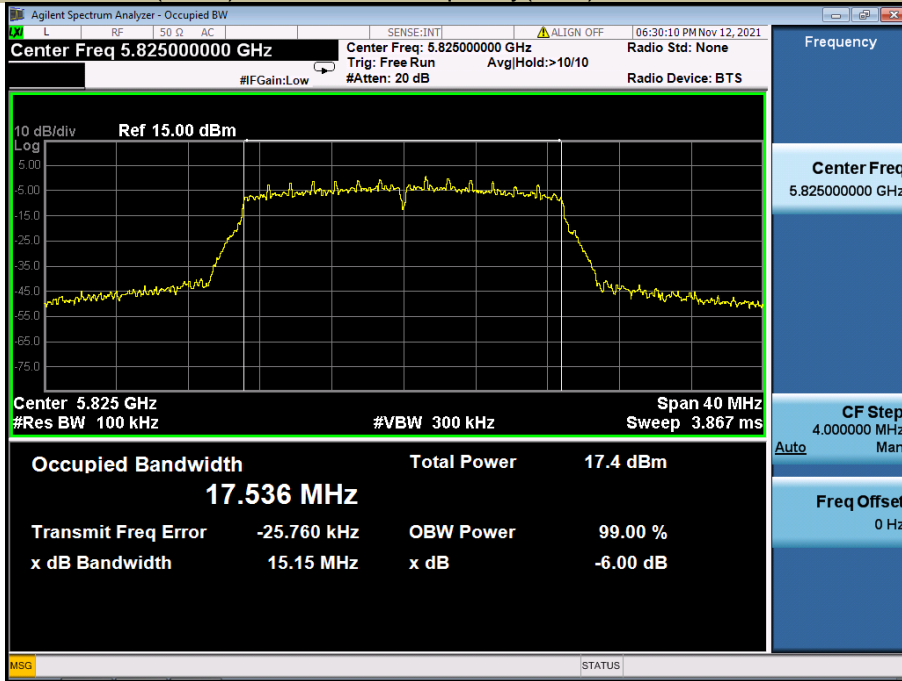

-6 dB Emission Bandwidth U-NII - 3
 Test Model 802.11n-HT40 Frequency(MHz) 5755

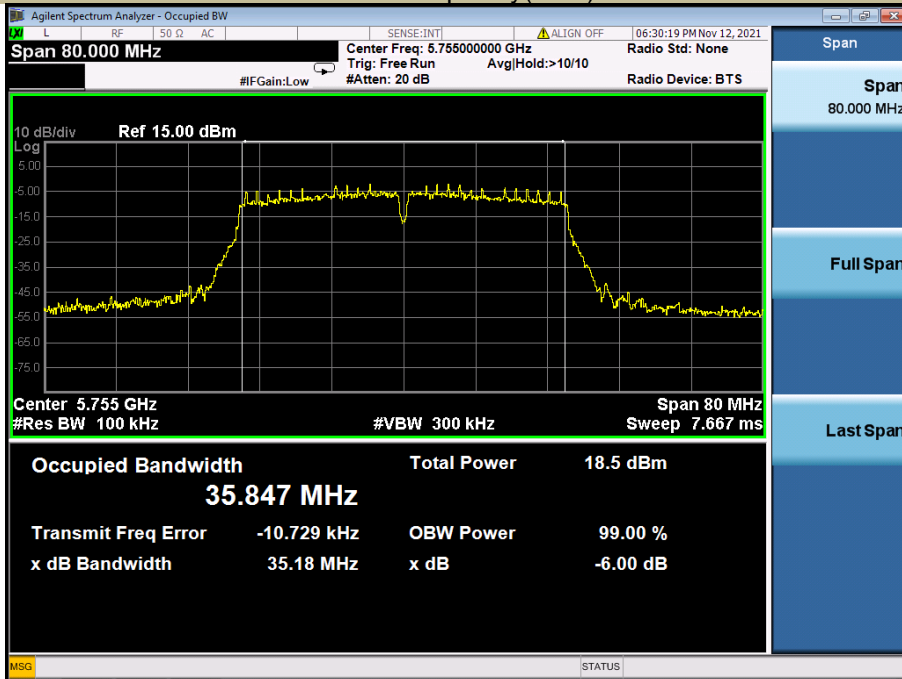

-6 dB Emission Bandwidth **U-NII - 3**
Test Model **802.11n-HT40** Frequency(MHz) **5795**

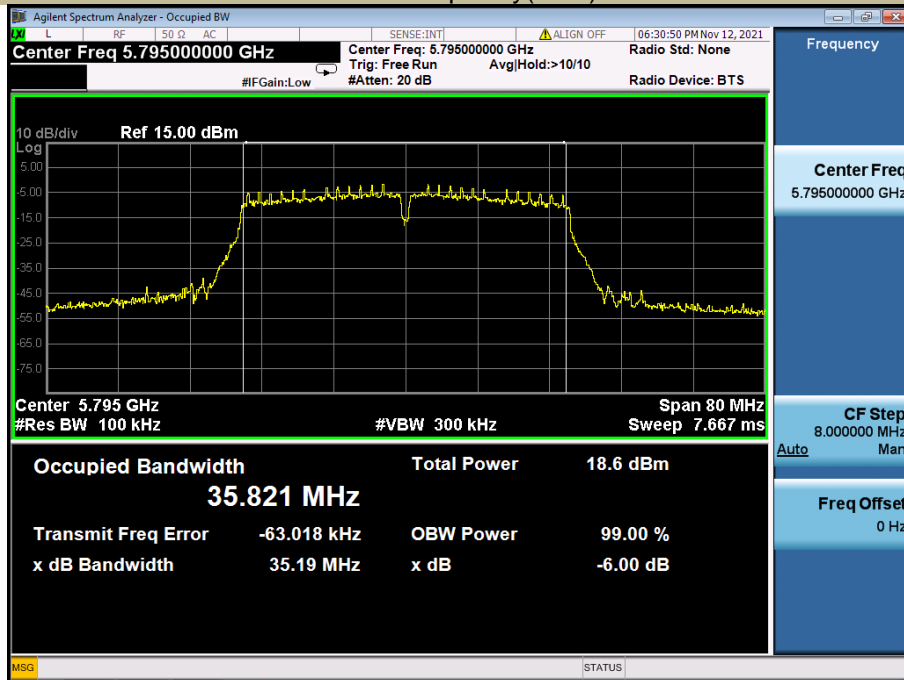

-6 dB Emission Bandwidth **U-NII - 3**
Test Model **802.11ac(HT40)** Frequency(MHz) **5755**

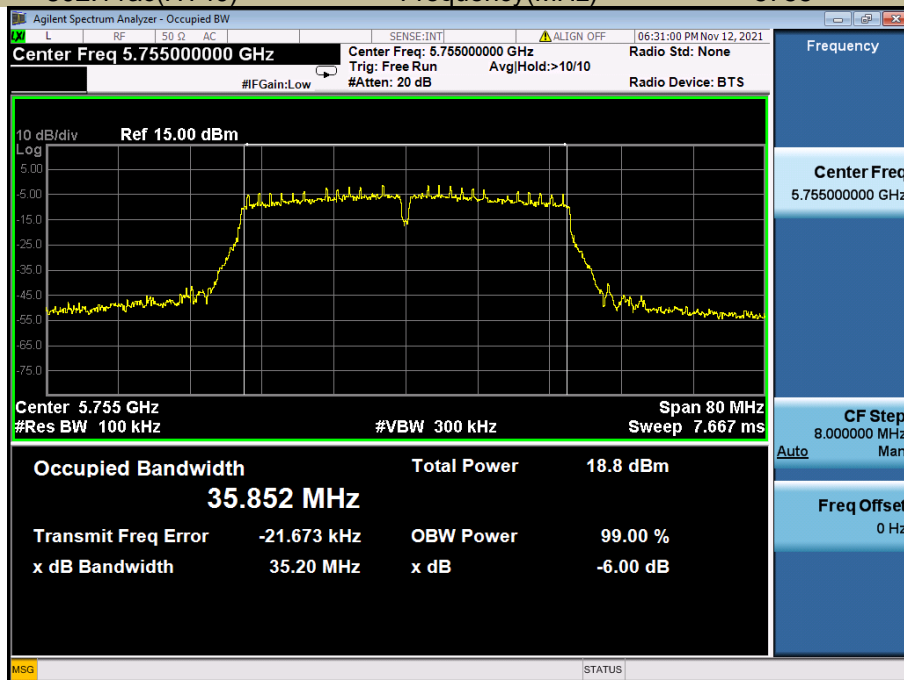

-6 dB Emission Bandwidth

Test Model 802.11ac(HT40)

U-NII - 3

Frequency(MHz)

5795

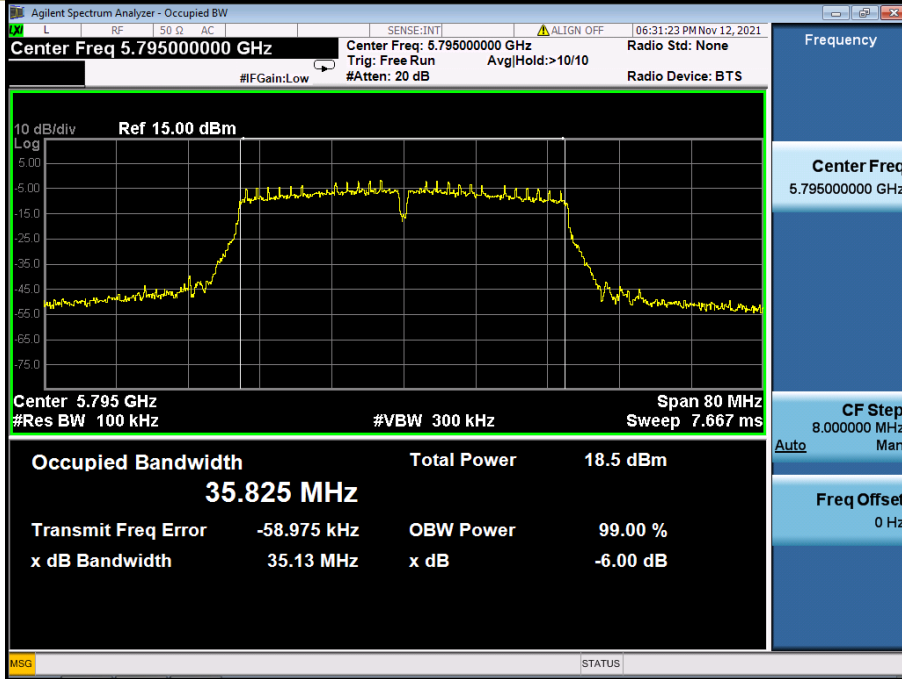

-6 dB Emission Bandwidth

Test Model 802.11ac 80

U-NII - 3

Frequency(MHz)

5775

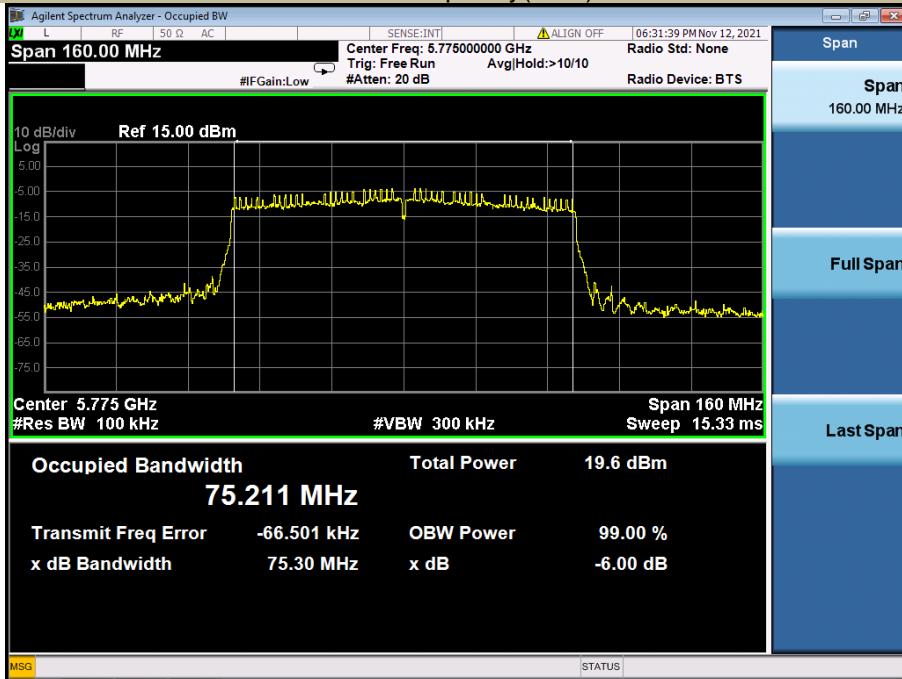

8.2 MAXIMUM CONDUCTED OUTPUT POWER

8.2.1 Applicable Standard

According to FCC Part 15.407(a)(1) for UNII Band I
According to FCC Part 15.407(a)(2) for UNII Band II-A and UNII Band II-C
According to FCC Part 15.407(a)(3) for UNII Band III
According to 789033 D02 Section II(E)

8.2.2 Conformance Limit

■ For the band 5.15-5.25 GHz,

(a) (1) (i) For an outdoor access point operating in the band 5.15-5.25 GHz, the maximum conducted output power over the frequency band of operation shall not exceed 1 W provided the maximum antenna gain does not exceed 6 dBi. In addition, the maximum power spectral density shall not exceed 17 dBm in any 1 megahertz band. If transmitting antennas of directional gain greater than 6 dBi are used, both the maximum conducted output power and the maximum power spectral density shall be reduced by the amount in dB that the directional gain of the antenna exceeds 6 dBi. The maximum e.i.r.p. at any elevation angle above 30 degrees as measured from the horizon must not exceed 125 mW (21 dBm).

(a) (1) (ii) For an indoor access point operating in the band 5.15-5.25 GHz, the maximum conducted output power over the frequency band of operation shall not exceed 1 W provided the maximum antenna gain does not exceed 6 dBi. In addition, the maximum power spectral density shall not exceed 17 dBm in any 1 megahertz band. If transmitting antennas of directional gain greater than 6 dBi are used, both the maximum conducted output power and the maximum power spectral density shall be reduced by the amount in dB that the directional gain of the antenna exceeds 6 dBi.

(a) (1) (iii) For fixed point-to-point access points operating in the band 5.15-5.25 GHz, the maximum conducted output power over the frequency band of operation shall not exceed 1 W. In addition, the maximum power spectral density shall not exceed 17 dBm in any 1 megahertz band. Fixed point-to-point U-NII devices may employ antennas with directional gain up to 23 dBi without any corresponding reduction in the maximum conducted output power or maximum power spectral density. For fixed point-to-point transmitters that employ a directional antenna gain greater than 23 dBi, a 1 dB reduction in maximum conducted output power and maximum power spectral density is required for each 1 dB of antenna gain in excess of 23 dBi. Fixed, point-to-point operations exclude the use of point-to-multipoint systems, omnidirectional applications, and multiple collocated transmitters transmitting the same information. The operator of the U-NII device, or if the equipment is professionally installed, the installer, is responsible for ensuring that systems employing high gain directional antennas are used exclusively for fixed, point-to-point operations.

(a) (1) (iv) For client devices in the 5.15-5.25 GHz band, the maximum conducted output power over the frequency band of operation shall not exceed 250 mW provided the maximum antenna gain does not exceed 6 dBi. In addition, the maximum power spectral density shall not exceed 11 dBm in any 1 megahertz band. If transmitting antennas of directional gain greater than 6 dBi are used, both the maximum conducted output power and the maximum power spectral density shall be reduced by the amount in dB that the directional gain of the antenna exceeds 6 dBi.

■ For the 5.25-5.35 GHz and 5.47-5.725 GHz bands

(a) (2) The maximum conducted output power over the frequency bands of operation shall not exceed the lesser of 250 mW or $11 \text{ dBm} + 10 \log B$, where B is the 26 dB emission bandwidth in megahertz. In addition, the maximum power spectral density shall not exceed 11 dBm in any 1 megahertz band. If transmitting antennas of directional gain greater than 6 dBi are used, both the maximum conducted output power and the maximum power spectral density shall be reduced by the amount in dB that the directional gain of the antenna exceeds 6 dBi.

■ For the band 5.725-5.85 GHz

(a) (3) for the band 5.725-5.85 GHz, the maximum conducted output power over the frequency band of operation shall not exceed 1 W. In addition, the maximum power spectral density shall not exceed 30

dBm in any 500-kHz band. If transmitting antennas of directional gain greater than 6 dBi are used, both the maximum conducted output power and the maximum power spectral density shall be reduced by the amount in dB that the directional gain of the antenna exceeds 6 dBi. However, fixed point-to-point U-NII devices operating in this band may employ transmitting antennas with directional gain greater than 6 dBi without any corresponding reduction in transmitter conducted power. Fixed, point-to-point operations exclude the use of point-to-multipoint systems, omnidirectional applications, and multiple collocated transmitters transmitting the same information. The operator of the U-NII device, or if the equipment is professionally installed, the installer, is responsible for ensuring that systems employing high gain directional antennas are used exclusively for fixed, point-to-point operations

8.2.3 Test Configuration

Test according to clause 6.1 radio frequency test setup

8.2.4 Test Procedure

The maximum average conducted output power can be measured using Method PM-G (Measurement using a gated RF average power meter):

Measurements may be performed using a wideband gated RF power meter provided that the gate parameters are adjusted such that the power is measured only when the EUT is transmitting at its maximum power control level. Since the measurement is made only during the ON time of the transmitter, no duty cycle correction factor is required.

- a. The Transmitter output (antenna port) was connected to the power meter.
- b. Turn on the EUT and power meter and then record the power value.
- c. Repeat above procedures on all channels needed to be tested.

8.2.5 Test Results

For 1T1R

Band	Operating mode	Channel Number	Channel Freq. (MHz)	Conducted Output Power(dBm)		Limit (dBm)	Verdict
				Antenna 1	Antenna 2		
U-NII – 1	802.11a	CH36	5180	8.64	9.11	24	Pass
		CH40	5200	8.15	8.98	24	Pass
		CH48	5240	8.02	8.64	24	Pass
	802.11n-HT20	CH36	5180	8.45	8.62	24	Pass
		CH40	5200	8.47	8.4	24	Pass
		CH48	5240	8.39	8.82	24	Pass
	802.11ac(HT20)	CH36	5180	8.45	8.32	24	Pass
		CH40	5200	8.81	8.45	24	Pass
		CH48	5240	8.63	8.55	24	Pass
	802.11n-HT40	CH38	5190	8.45	8.63	24	Pass
		CH46	5230	8.78	8.14	24	Pass
	802.11ac(HT40)	CH38	5190	8.62	8.47	24	Pass
		CH46	5230	8.31	8.72	24	Pass
	802.11ac(HT80)	CH42	5210	8.69	8.47	24	Pass

Band	Operating mode	Channel Number	Channel Freq. (MHz)	Conducted Output Power(dBm)		Limit (dBm)	Verdict
				Antenna 1	Antenna 2		
U-NII – 2A	802.11a	CH52	5260	12.78	12.46	24	Pass
		CH56	5280	12.46	11.75	24	Pass
		CH64	5320	12.72	11.41	24	Pass
	802.11n-HT20	CH52	5260	11.66	11.96	24	Pass
		CH56	5280	11.26	11.44	24	Pass
		CH64	5320	11.63	11.30	24	Pass
	802.11ac(HT20)	CH52	5260	11.61	12.00	24	Pass
		CH56	5280	11.30	11.51	24	Pass
		CH64	5320	11.69	11.37	24	Pass
	802.11n-HT40	CH54	5270	11.68	11.93	24	Pass
		CH62	5310	11.55	11.37	24	Pass
	802.11ac(HT40)	CH54	5270	11.64	11.90	24	Pass
		CH62	5310	11.41	11.32	24	Pass
	802.11ac(HT80)	CH58	5290	11.64	11.68	24	Pass

Band	Operating mode	Channel Number	Channel Freq. (MHz)	Conducted Output Power(dBm)		Limit (dBm)	Verdict
				Antenna 1	Antenna 2		
U-NII – 2C	802.11a	CH100	5500	12.01	9.92	24	Pass
		CH116	5580	12.37	10.79	24	Pass
		CH140	5700	13.33	12.47	24	Pass
	802.11n-HT20	CH100	5500	10.90	9.81	24	Pass
		CH116	5580	11.25	10.40	24	Pass
		CH140	5700	12.14	11.96	24	Pass
	802.11ac(HT20)	CH100	5500	10.91	9.85	24	Pass
		CH116	5580	11.30	10.44	24	Pass
		CH140	5700	12.22	12.01	24	Pass
	802.11n-HT40	CH102	5510	11.18	10.22	24	Pass
		CH134	5670	12.23	11.73	24	Pass
	802.11ac(HT40)	CH102	5510	11.13	10.26	24	Pass
		CH134	5670	12.20	11.73	24	Pass
	802.11ac(HT80)	CH106	5530	11.96	11.09	24	Pass

Band	Operating mode	Channel Number	Channel Freq. (MHz)	Conducted Output Power(dBm)		Limit (dBm)	Verdict
				Antenna 1	Antenna 2		
U-NII – 3	802.11a	CH149	5745	12.21	10.90	30	Pass
		CH157	5785	12.08	11.26	30	Pass
		CH165	5825	11.13	9.80	30	Pass
	802.11n-HT20	CH149	5745	10.88	10.23	30	Pass
		CH157	5785	10.82	10.12	30	Pass
		CH165	5825	9.99	8.68	30	Pass
	802.11ac(HT20)	CH149	5745	10.99	10.27	30	Pass
		CH157	5785	10.87	10.16	30	Pass
		CH165	5825	10.01	8.74	30	Pass
	802.11n-HT40	CH151	5755	11.20	10.41	30	Pass
		CH159	5795	10.81	9.95	30	Pass
	802.11ac(HT40)	CH151	5755	11.19	10.48	30	Pass
		CH159	5795	10.78	10.02	30	Pass
	802.11ac(HT80)	CH155	5775	11.08	10.31	30	Pass

For 2T2R

Band	Operating mode	Channel Number	Channel Freq. (MHz)	Conducted Output Power(dBm)	Limit (dBm)	Verdict
U-NII – 1	802.11n-HT20	CH36	5180	11.55	21.5	Pass
		CH40	5200	11.45	21.5	Pass
		CH48	5240	11.62	21.5	Pass
	802.11ac(HT20)	CH36	5180	11.40	21.5	Pass
		CH40	5200	11.64	21.5	Pass
		CH48	5240	11.60	21.5	Pass
	802.11n-HT40	CH38	5190	11.55	21.5	Pass
		CH46	5230	11.48	21.5	Pass
	802.11ac(HT40)	CH38	5190	11.56	21.5	Pass
		CH46	5230	11.53	21.5	Pass
	802.11ac(HT80)	CH42	5210	11.59	21.5	Pass