

TRU-BOLT.

ENGLISH

Luna

Biometric Enabled Deadbolt

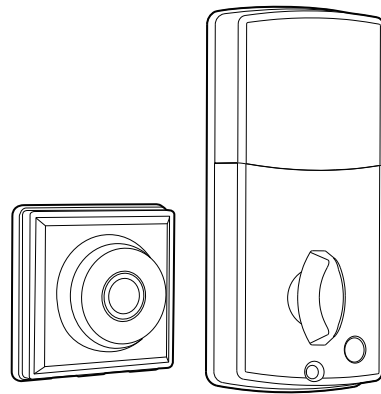

Important

Use the QR code below for the most up to date instructions:



Tools Needed for Lock Installation:

- Phillips Screwdriver



Read this manual carefully before installing and operating!

1 Installation Overview

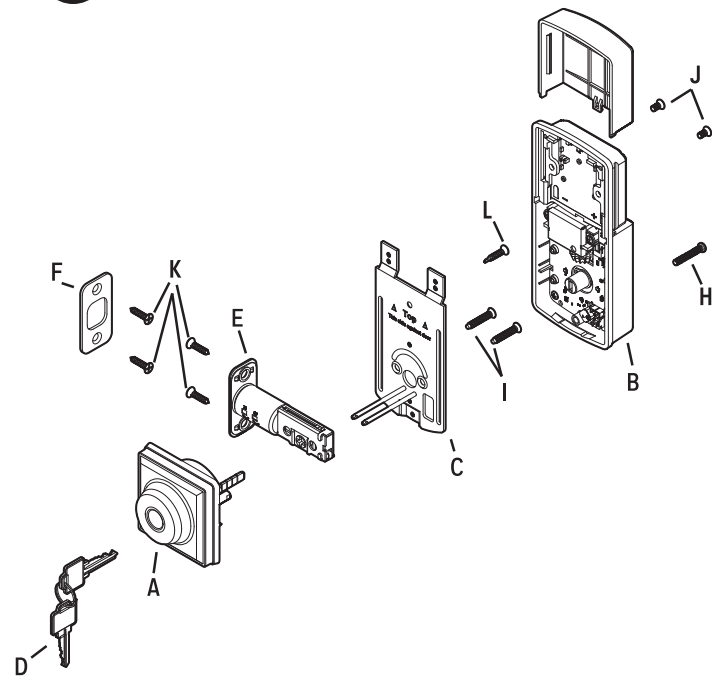

Package Includes:

- 1 - Exterior Assembly
- 1 - Interior Assembly
- 1 - User Guide
- 2 - Keys
- 1 - Strike Plate
- 1 - Mounting Plate
- 1 - Latch
- 1 - 3/8" Screw
- 2 - 5/16" Screws
- 2 - 1" Screws
- 4 - 3/4" Screws
- 1 - Optional Set Screw

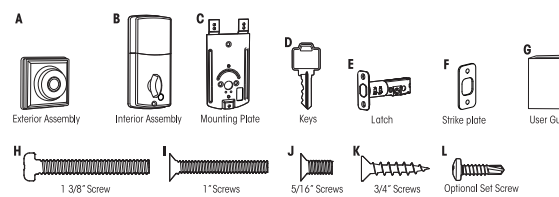

Please carefully check the above list to confirm all items have been received. If any items are missing, please contact Consumer Assistance. (See back for contact information)

Read this manual carefully before installing and operating!

2 Install Enclosed Latch and Strike Plate

Do not over-tighten latch screws.

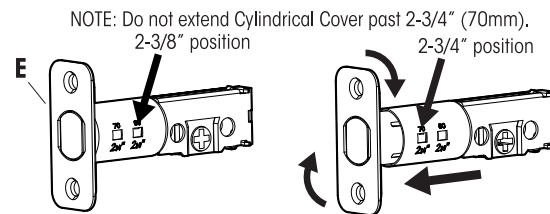

- TO CONVERT FROM 2-3/8" (60mm) BACKSET TO 2-3/4" (70mm) BACKSET:
1. Hold latch with numbers facing forward and thumb pressing on the bolt.
 2. Rotate the cylinder cover clockwise.
 3. Pull and twist the extension plate all the way out.
 4. Rotate the cylinder counter clockwise so that the marking aligns with the 2-3/4" position indicator.

The latch plate on the door needs to be straight and not protruding from door. Make adjustment before installing or this will cause problems with bolt fitting into latch hole.

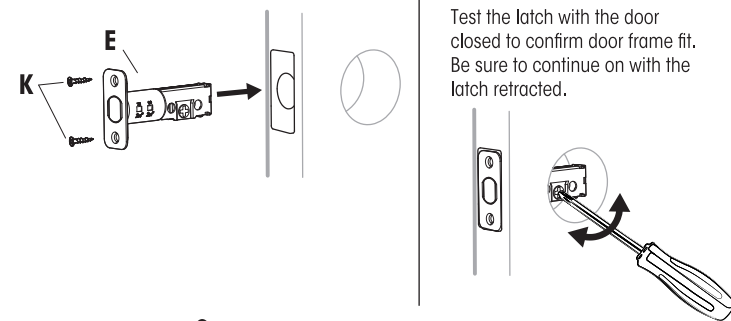

Deadbolt Latch Must Be Retracted During Installation.

Preparation for Interior Assembly

Remove (J) Screw from inside the battery compartment within the (B) Housing to release the Mounting Plate (C).

Ensure screw posts are fully tightened.

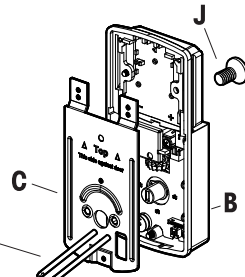

3 Install Exterior Assembly

2 1/8" Door Holes

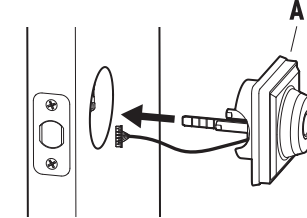

1 1/2" Door Holes

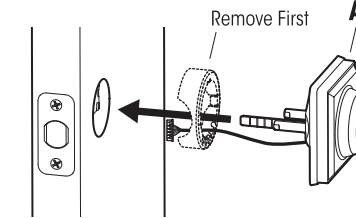

Check that the Rubber Gasket is secured on the Exterior Assembly (A). Insert the Exterior Assembly onto the door with the tailpiece going through the Deadbolt Latch in the VERTICAL POSITION.

Route the Control Wire through the door UNDER the Deadbolt Latch. **Make sure the door is shut, lock and unlock using the key, to ensure that the latch is operating smoothly and is aligned properly without scraping the strike plate.** If not, go back to step 2 and ensure you followed the steps.

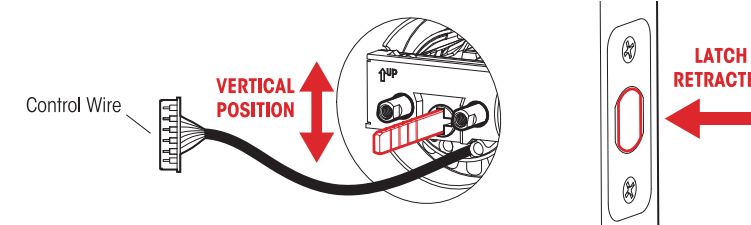

Work with the door open

Install mounting plate by inserting screw posts into exterior assembly

Secure mounting plate to door

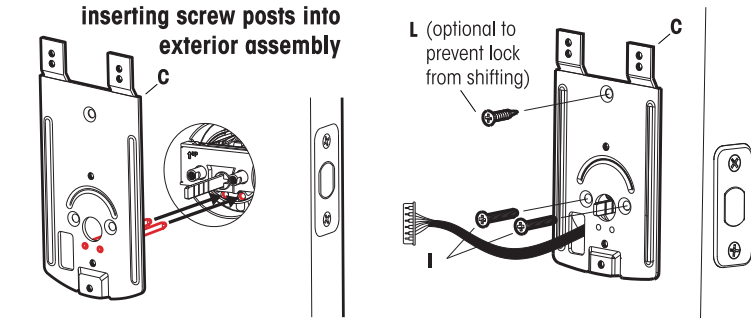

4 Install Interior Assembly

Carefully insert control wire into the wire connector

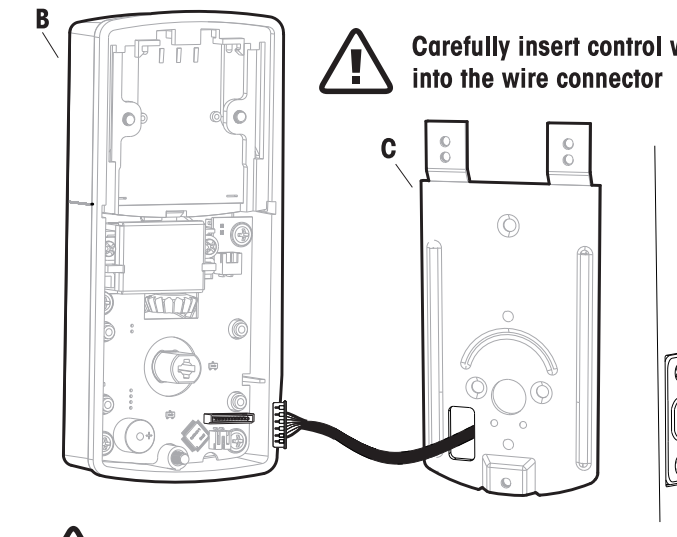

Work with the door open

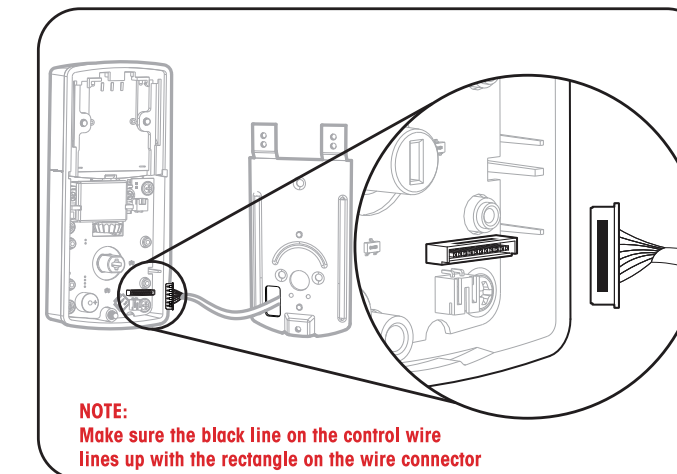

5 Install Interior Assembly

NOTE: Make sure the Turn Knob is in the vertical position. Be careful not to pinch the control wire when assembling.

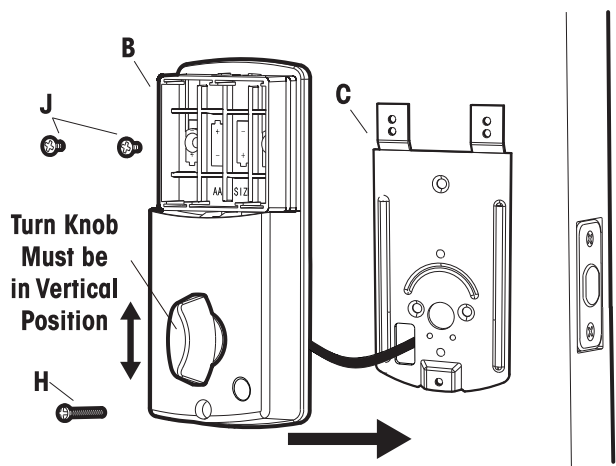

NOTE: Tailpiece and Turn Knob Must be in Vertical Position

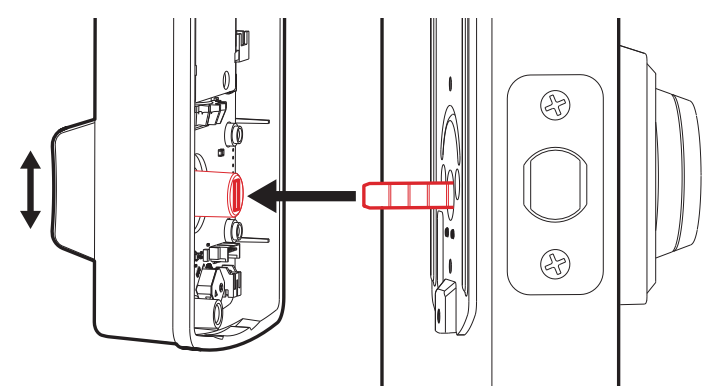

6 Install Batteries and Cover

NOTE: Do not touch the Fingerprint Reader until the light turns off.

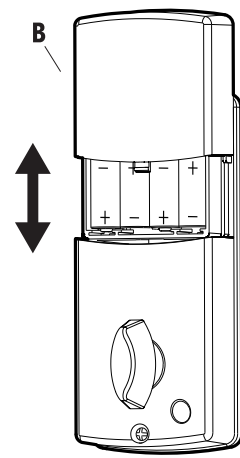

This Electronic lock requires (4) High Quality AA Alkaline batteries. Do not use rechargeable batteries or non-alkaline batteries.

When all 4 batteries are installed in the correct position, the Lock will engage in order to automatically determine your door "Handing" (left or right handed door).

When completed the lock will beep and the Fingerprint Reader will flash.

7 Testing Operation

Keep door open during testing

NOTE: Any fingerprint can unlock the door until you set up your fingerprint in the My Key Mobile APP. See reverse side of this manual for detailed instructions.

Place finger on Fingerprint Reader to lock and unlock door



Press the button to lock and unlock door

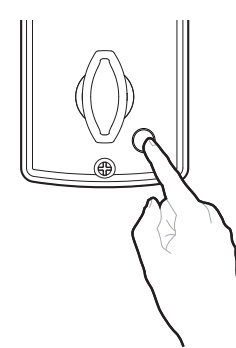

Key slot behind Fingerprint Reader can also be used to lock and unlock door

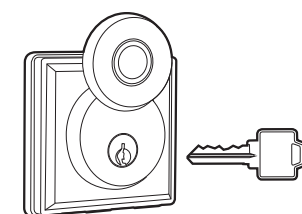

Lock and unlock using the turn knob, make sure the latch is opening and closing easily. If not, go back to step 2 and ensure you followed the steps

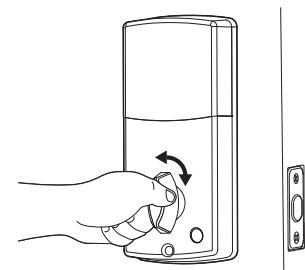

The lock will beep twice after locking and once after unlocking.

Preparing Door

Tools Needed for Door Preparation (if there is no knob hole):

NOTE: Skip this step if your door comes with pre-drilled holes.

- Drill
- 2 1/8" Hole Saw
- 1" Hole Saw
- 3/4" Chisel

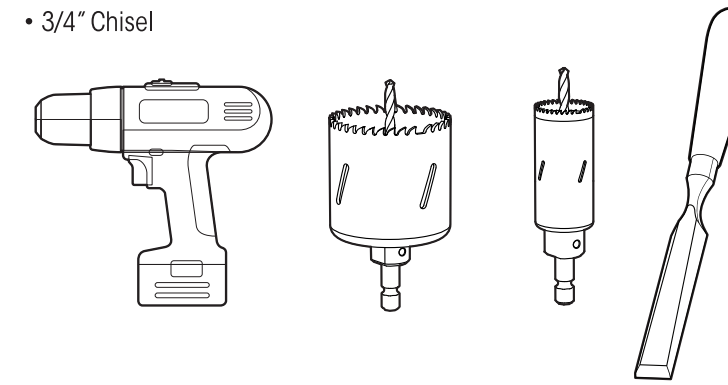

Refer to Template included for Door Prep Instructions

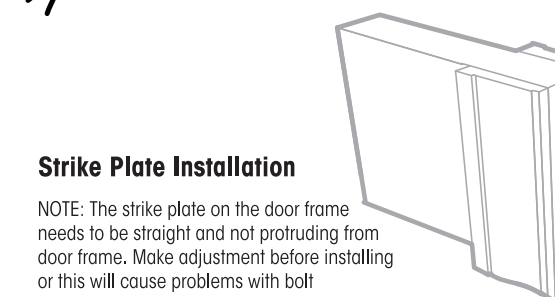
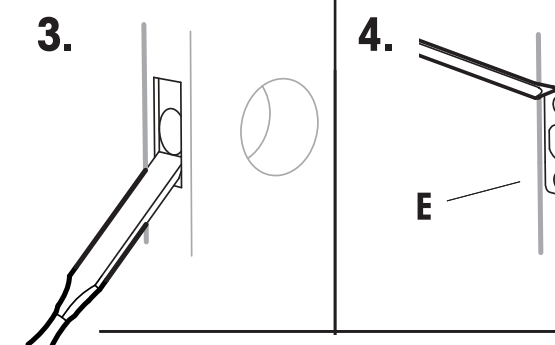
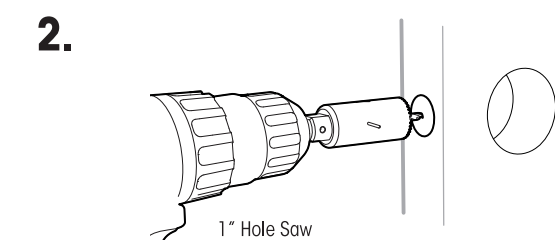
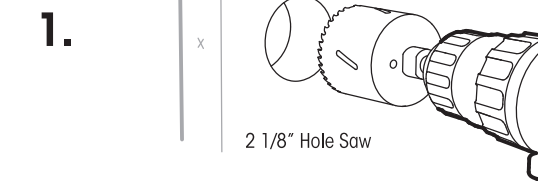
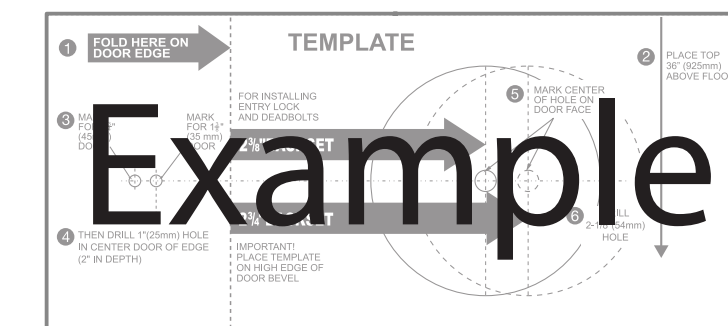

Strike Plate Installation
NOTE: The strike plate on the door frame needs to be straight and not protruding from door frame. Make adjustment before installing or this will cause problems with bolt fitting into latch hole.

Programming Instructions



Download the My Key Mobile App from the APP store or Google Play

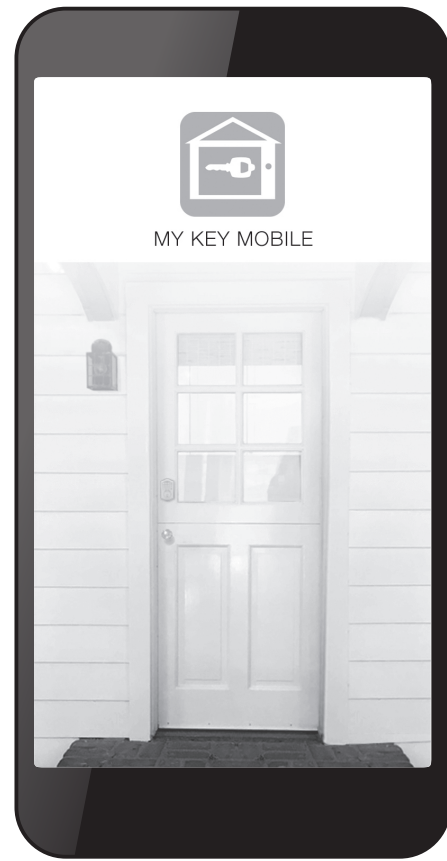

1 Register an Account

1. Press "REGISTER" on the login screen
2. Enter your phone number and preferred password
3. Press "Get Code" and enter the verification code received via text msg in the required field
4. Success! Use the selected phone # and password to log into your My Key Mobile App

2 Add a Lock

Press the Fingerprint Reader to wake up Lock. The Fingerprint Reader must be lit in order to add the Lock

1. Press "+"
2. Press "Door Lock"
3. Activate the lock, then press "Next"
4. Press the "+" next to the lock you wish to add. The lock will beep when selected.
5. Success! Name your lock and press "OK"

3 Add a Fingerprint

1. Press "Fingerprint"
2. Press "Add Fingerprint"
3. Enter a name, then press "Next"
4. Press "Start"
5. Wait for the blue light, then place your finger on the Fingerprint Reader to scan. The lock will beep once. Repeat to completion, 5 additional times.

The lock will flash green and beep once when scanning is complete.

4 Locking and Unlocking via APP

Press the Lock Icon to lock door

Press and hold the Lock Icon to lock door

Press the Lock Icon to unlock door

Press and hold the Lock Icon to unlock door

5 Creating and Sending eKeys

1. Select "eKeys"
2. Select "SEND eKEYS"
3. Select a Validity Period (Timed, Permanent, etc.)
4. Enter the recipient's Phone # and Name. Press "Send" to confirm

Selecting "Authorized Admin" allows recipient to make changes to the lock

6 Additional Programming Functions

You will use the APP to make these changes in settings

The Additional Programming Functions allow you to make adjustments to your lock that suit your lifestyle and needs.

- Unlock Remotely: This feature can only be used with a Gateway (sold separately)
- Auto Lock: Enable or disable Auto Lock
- Passage Mode: Enable or disable Passage Mode (see next step for details)
- Lock Sound: Update the lock's internal clock
- Diagnosis
- Read Operation Records
- Firmware Update
- In vacation mode: Enable or disable Vacation Mode
- In vacation, only mechanical key works
- Unlock Notification

Delete the lock from the app (must be done near lock)

7 Passage Mode

You will use the APP to make these changes in settings

Passage Mode keeps the lock open on a set schedule. When Passage Mode is enabled, the lock will remain open until it is manually closed.

- Enable or disable Passage Mode
- Select days when Passage Mode will be active
- Configure time of day when Passage Mode will be active

8 Restore Factory Settings

The lock restores to factory settings when the Administrator deletes the lock from the App (see Step 6). A green light will flash and the lock will beep when it has been restored to factory settings.

Troubleshooting

Issue	Solution
Lock will not function electronically.	<ul style="list-style-type: none"> Check that all batteries are fresh high quality Alkaline Batteries Check for proper polarity (+ -) of all batteries Check that the Control Wire is attached to the Interior Assembly
Lock gives error signal when opening or locking and Latch will not extend or retract completely when closed.	<ul style="list-style-type: none"> Unlock door using Key or Interior Knob While door is open, check that the Latch operates smoothly Check for proper alignment of the strike plate, adjust as needed to assure there is no binding against the Latch
The Latch is sticking.	<ul style="list-style-type: none"> Installation screws of the lock may be too tight and have to be loosened Remove Interior Assembly Slightly loosen the Mounting Plate screws Lock and unlock using the Key Reattach Control Wire and Interior Assembly
The App is unable to connect to a lock.	<ul style="list-style-type: none"> Bluetooth is off, smart device is not compatible, or the lock may not be activated Contact customer assistance regarding compatibility issues, but iPhone 5 and later models, and most Android devices are compatible Turn Bluetooth on, and ensure the lock is activated by pressing the Fingerprint Reader on the physical lock until you see the icon to add the lock
eKeys will not send.	<ul style="list-style-type: none"> Only registered users of the App can receive eKeys. Ensure that whoever is receiving the eKey has a registered account, and their information is entered correctly Ensure you are connected to the lock via Bluetooth, and that the smart device is updated
Fingerprint is invalid.	<ul style="list-style-type: none"> Make sure your fingers and the Fingerprint Reader are both clean Keep your finger on the Fingerprint Reader until you hear a beep Try using another recorded fingerprint For consistent failures, delete and re-add the fingerprint
Fingerprint Does not work.	<ul style="list-style-type: none"> Hold finger on Fingerprint Reader longer
Latch is not locking in inclement weather.	<ul style="list-style-type: none"> Push or pull door to direct latch Re-adjust latch for smoother operations

Contact Us First! Do Not Return to Store

EMAIL: locks@lewishymaninc.com
 WEBSITE: www.trubollocks.info
 ADDRESS: Consumer Assistance Dept.
 Lewis Hyman, Inc.
 860 East Sandhill Avenue
 Carson, CA 90746 USA
 TELEPHONE: US/Canada 800-860-1677 Ext. 1801 (Toll Free)

Don't forget to register your lock at Trubollocks.info for updates.

Limited 1-Year Electronic Warranty - Limited Lifetime Mechanical and Finish Warranty
 This Tru-Bolt® product comes with a 1-Year Limited Warranty on Electronic Parts and a Limited Lifetime Mechanical and Finish Warranty against defects in materials and workmanship under normal use to the original residential user. Proof of purchase and ownership is required for the warranty to be in effect. This warranty is non transferable and applies to the original purchaser only, as long as the original purchaser occupies the residential premises upon which the product(s) was originally installed. This warranty DOES NOT COVER removal and reinstallation of product(s), scratches, abrasions, deterioration due to the use of paints, solvents or other chemicals, abuse, misuse, or product(s) used in commercial applications, does not cover any losses, injuries to persons/property or costs, and shipping and freight expenses required to return product(s). In no event shall Tru-Bolt® be liable for any special, incidental or consequential damages. If this product(s) is considered a consumer product, please be advised that some local and state laws do not allow limitations on incidental or consequential damages or how long an implied warranty lasts, so that the above limitations may not fully apply. Refer to your local laws for your specific rights under this warranty. If there are any problems please call our customer service with any questions or concerns.

Package Warranty:
 Limited Lifetime Mechanical & Finish Warranty:
 This Tru-Bolt® product(s) comes with a 1-Year Limited Warranty on Electronic Parts and a Limited Lifetime Mechanical and Finish Warranty against defects in materials and workmanship under normal use to the original residential user. If there are any problems please call our customer service with any questions or concerns. See installation instructions for full terms and conditions.
 DO NOT RETURN TO STORE
 For questions / comments, technical assistance or repair parts - please call toll free at: 1-800-860-1677 x 1801 (M-F 7am-5pm PST)

Regulatory Compliance
 This product complies with standards established by following regulatory bodies:
 - Federal Communications Commission (FCC)

FCC ID: 2AYCK1745XXX
 This device complies with Part 15 of the FCC rules. Operation is subject to the following two conditions:
 (1) This device may not cause harmful interference, and
 (2) This device must accept any interference, including interference that may cause undesired operation

IMPORTANT! Changes or modifications not expressly approved by the manufacturer could void the user's authority to operate the equipment.
 NOTE: This equipment has been tested and found to comply with the limits for a Class B digital device, pursuant to Part 15 of the FCC Rules. These limits are designed to provide reasonable protection against harmful interference in a residential installation. This equipment generates uses and can radiate radio frequency energy and, if not installed and used in accordance with the instructions, may cause harmful interference to radio communications.
 However, there is no guarantee that interference will not occur in a particular installation. If this equipment does cause harmful interference to radio or television reception, which can be determined by turning the equipment off and on, the user is encouraged to try to correct the interference by one or more of the following measures:
 • Reorient or relocate the receiving antenna.
 • Increase the separation between the equipment and receiver.
 • Connect the equipment into an outlet on a circuit different from that to which the receiver is connected.
 • Consult the dealer or an experienced radio/TV technician for help.