

BWC-R3

User manual



Content

1. Introduction.....	1
2. Structure design.....	2
2.1 Front view	2
2.2 Back view.....	3
3. Basic Operations	4
3.1 Live view window.....	4
3.2 Main menu	6
4. Device using	13

1. Introduction

BWC-R3 is a intelligent body worn camera specifically designed for Law Enforcement. The camera features real time HD video, 4K recording, support built-in 4G, WIFI and GPS function, and a high resolution still image capture visible on the LCD screen for instant playback, with wide angle; The rugged design is resilient to withstand demanding work environments faced by law enforcement officers, corrections, military and security detail.

Package Contents

- * Body worn camera
- * USB cable
- * USB power adapter
- * CD with manual and software
- * Universal metal clip

2. Structure design

2.1 Front view

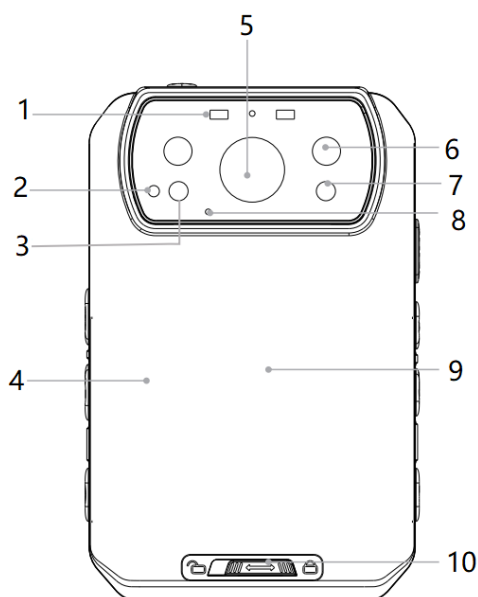

Item	Name	Description
1	Working indicator	Red blinking means video recording, yellow blinking means audio recording, solid green means standby or preview mode. Blue light means live video transmission.
2	IR sensor	The sensor will detect the brightness of the environment, and then activate the IR light and switch to night vision mode.
3	Lighting	Short press the F button to enable the light for auxiliary lighting.
4	Battery cover	Remove this cover, you can take out the battery for replacement
5	Camera Lens	Full HD wide angle camera lens
6	IR light	There are two IR light for night vision
7	Laser light	Pinpointing an object from a distance, solid or blinking mode
8	Microphone	Capture the environment voice during recording
9	NFC area	If the camera support NFC function, you can put the NFC card here for scanning.
10	Battery lock	You have to unlock this cover and then you can replace the battery.

2.2 Back view

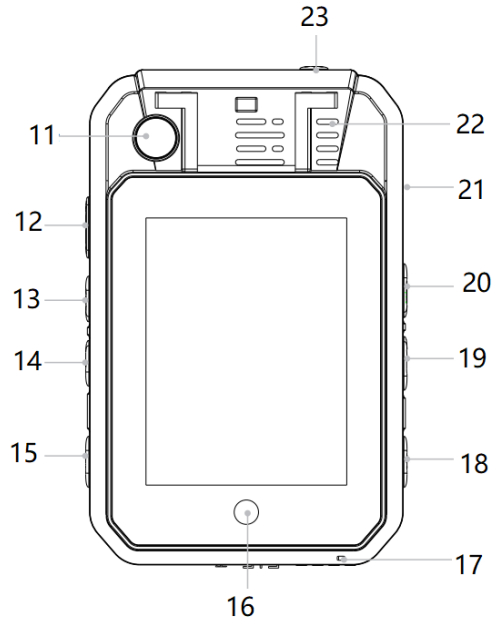

Item	Name	Description
11	Second camera	The second camera, which for video call, face unlock and so on.
12	PTT button	Press this button can start to talk with other devices that connected to the server.
13	Snapshot	Press this button to start capture the snapshots, even during video recording mode.
14	Audio REC button	Press the button to start the audio recording only.
15	Flag button	Press this button during recording, it will make the recorded video as a marked video file.
16	Home key	Press this icon to make the operation back to the home interface
17	Second Microphone	Mainly for the voice communicate with the center server.
18	ON/OFF button	Short press the button to open or close the lighting, long press it to power on or power off.
19	Video REC button	Press this button to start the video recording
20	Muti-functional button	You can define this function of this button, the default one is enable withe light.
21	USB port	Connect USB cable for charging or connection to PC.
22	Speaker	It's the speaker to audio playback and voice report.
23	SOS button	Press this button to trigger the SOS alarm, it will send the SOS alert to the center server.

3. Basic Operations





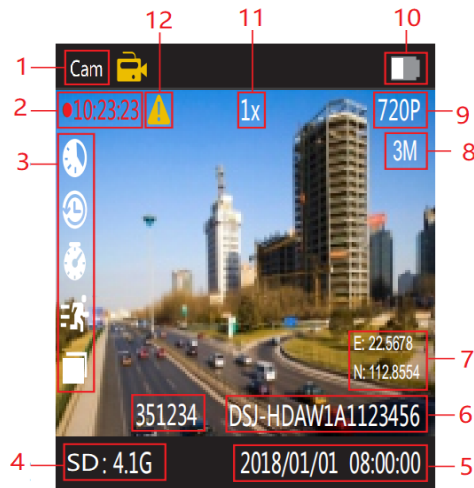







3.1 Live view window

The body worn camera LCD screen is a small monitor to display various camera information and operation status.



Item	Name	Description
1	Video recording icon	Yellow icon means video recording is working.
2	Recording status	How long time the camera already recorded
3	Function icon area	Here will display the function icon, such as post-recording, pe-recording, timing snapshot, motion detect and so on
4	Storage info	Display the capacity and remaining size of the storage
5	Date/Time	The current date/time
6	ID information	The officer ID and Device ID of this camera
7	GPS Info	It will show the latitude and longitude info of the camera.
8	Snapshot resolution	When press the snapshot button, it will capture the picture based on this resolution
9	Recording resolution	The resolution that camera will recording
10	Battery status	The current status of the battery
11	Zoom in/out	The Zoom in and zoom out info
12	Video mark	Yellow “!” means the video is with flag.

Icon definition: This table will mentioned all the details about the icon that will display on the top line in the preview screen of the camera.

	Recording Icon	This icon means the camera is under video recording status.
	Snapshot Icon	This icon means the camera is capturing the pictures
	Audio REC Icon	This icon means the camera is recording audio only.
	SOS Alert	This icon means the camera triggered SOS alert success. Only when the camera connected to server can trigger this alert.
	SMS Recording	This icon mean, the camera received the SMS info from the center server.
	Server connected	This icon means the camera is connected to the center server.
	GPS location	This icon means the camera enabled the GPS function, grey icon means not GPS signal, white icon means GPS signal OK.
	Bluetooth	This icon means the Bluetooth function is enabled.
	Wifi Network	This icon means the wifi network is enabled
	Hotspot	This icon means the Hotspot function is enabled
	4G network	This icon means the 4G network is enabled
	Battery Status	This icon means the battery status, you will know how many power it remain.
	Recharging status	This icon means the camera is in charging.

3.2 Main menu

In preview mode, press home key to enter into main menu interface, you will see the interface as follow:

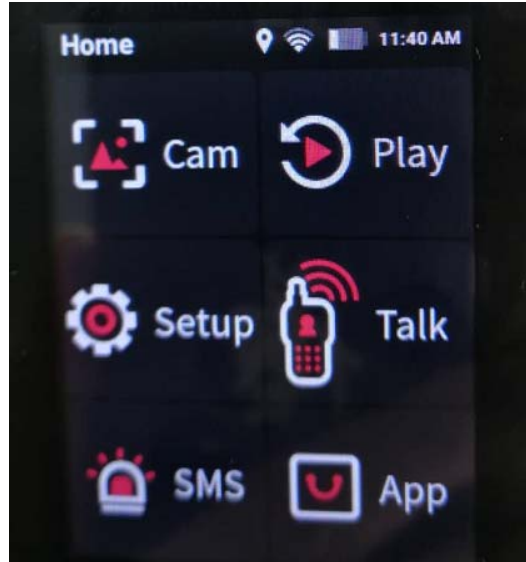

1	Cam	Enter into the preview of the camera
2	Play	Playback the local video, audio and images.
3	Setup	Setup all the parameters of the camera
4	Talk	Start the intercom function with other camera, video and audio call, as well as group talk.
5	SMS	Check the SMS or picture message sent from center server, and start the associated recording
6	App	Some other functions of the camera, such as app, Hotspot, pointing and so on

Click “SETUP” option to enter into the parameters setup interface, it mainly include “DEVICE”, “MEDIA”, “SERVER” and “SYSTEM”

SETUP>>DEVICE

Select the “Setup”, you will enter into all the parameters configurations, the all items are as follow:

ID	Menu	Options
1	Brightness	Drag the icon to adjust
2	Screen off	30sec,1min,3min,5min,OFF
3	Vibration	ON,OFF
4	Mute	Turn off all the sound
5	Infrared	ON, OFF
6	F button	Flash, sound, laser light, IR manually, playback, setup

7	Security password	Turn on the login password or not
8	Device password	Setup the device password
9	Indicator light	ON, OFF
10	Face encryption	Enable the face encryption function
11	Watermark	Type the watermark info here
12	Preview mode	Select the preview screen mode
13	Preview mode	Select the preview screen mode

1. Brightness

Adjust the brightness of the screen, just drag the icon to adjust.

2. Screen off

Switch off the screen after a certain time if there is any operation, which will save the power consumption.

3. Vibration

When option is on, It will remind the users that the function is in use through vibration.

4. Mute

When option is on, It will turn off all the sound of the camera.

5. Infrared

This option means you can enable or disable the Infrared function.

6. F button

You can define a function for the F button: Flash, sound, laser light, IR manually, playback, or enter into setup interface.

7. Security password

When is option is ON, you need the password when you login the menu setup interface, as well as the playback interface.

8. Device password

You can setup the new password of the camera, the default password is "000000".

9. Indicator light

When the option is OFF, which means all the indicator light will be off when camera is start up, ON means it will display all the LED normally..

10. Face encryption

In this interface, you can enable the face encryption for different option, such as start up, recording, playback and setup the parameters, firstly, you need to register a face, and then enable the function,

when you want to use the function, you need to unlock by face recognition.

11. Watermark

In this option, you can setup the information that will overlay on the recording files, support 20 characters at most.

12. Preview mode

Choose the preview mode, 16:9 is not full screen, 1:1 is full screen.

SETUP>>>>>MEDIA :

ID	Menu	Options
	REC codec	H.264, H.265
	Video resolution	4K, 2K, 1080P, 720P, 480P
2	Video quality	High,Low,Medium
3	Segment time	Auto,1min,3min,5min, 10min,20min,30min
	Photo pixel (Cam1)	2M,5M,8M,10M,13M,16M,21M,32M,36M,42M,48M
7	Photo pixel(Cam2)	4M,5M,8M,13M
8	Snapshot	1PCS,3 PCS,5 PCS,10 PCS,20 PCS,30 PCS
9	Snapshot timing	OFF, 30sec, 1min,2min,4min, 5min
1	Post-recording	10sec,30sec,1min,2min,5min,10min,30min,OFF
2	Pre-recording	OFF,ON
3	Motion detect	ON, OFF
5	GPS watermark	OFF,ON
6	Communication tone	Voice, beep
7	Media Volume	Drag the icon to adjust
8	Warning tone	Beep,Voice
9	Hourly notice	ON,OFF

1. REC codec

You can select the video encoding type here, H.264 or H.265.

1. Video resolution

The body worn camera offers five different recording resolutions. Resolution and frame rate options feature a proper balance between video quality and maximizing amount of video stored.

Options	Display resolution	Images per second
480P	720*480	30FPS
720P30	1280*720	30FPS
1080P30	1920*1080	30FPS

2K	2560*1440	30FPS
4K	3840*2160	30FPS

2. Video quality

Select video quality based on the need of video recording. High means the best quality, which will encoding with big bit rate.

3. Segment time

Segment time selection defines the length of each video segment, and this option only is used for video recording, invalid for audio recording.

Sub-option: Auto, 1 minutes, 3 minutes, 5 minutes,10 minutes, 20 minutes, 30 minutes; auto means it will create a file in almost 2GB size, and the time is about one hour, depends on the video resolution.

4. Photo pixel (Cam1)

Cam 1 means the front main camera. The photo pixel provides options for still image resolution, 3M~48M optional.

5. Photo pixel (Cam2)

Cam 2 means the rear second camera. The photo pixel provides options for still image resolution

6. Snapshot

In preview mode, Long press the snapshot button to shoot the selected number of pictures, and you can set the option as 1PCS, 2 PCS, 3 PCS, 5 PCS,10PCS, 20PCS, 30PCS. When video recording is working, the function will not work; When video recording is working, short press snapshot button can take one single photo.

7. Snapshot timing

OFF means disable this function, and for the timing option: 30sec, 1min, 2min, 4 min, 5 min, it means every this time it will take a snapshot.

Pre-recording saves an additional seconds of video before the video recording button is pressed, and the additional seconds is about 30 seconds. After the option of pre-recording is enabled, the camera can not snapshot, but the snapshot will work during the video recording.

For example, we set the value(between setting the pre-recording and pressing the video recording button) as X, if $X < 30s$, the camera will store an additional video for X seconds before the video recording button is pressed, if $X \geq 30s$, the camera will store an additional video for 30 seconds

before the video recording button is pressed.

8. Post-recording

Post-recording means how long the camera should continue to record after the video recording button is pressed to stop recording.

9. Motion detect

When the option is on, if there is something moving in the camera, the camera will start to recording. You can press the recording button to stop recording.

10. GPS watermark

When the option is on, the GPS info will display in the video image, even in the recorded video and streaming video.

11. Communication tone

The is option means when the two-way audio communication function is enabled, the tone is vibration or use the incall tone, and adjust the volume.

12. Media Volume

Select volume level option to increase or decrease all the volume of camera, including playback, key sound, indicate sound and so on.

13. Warning tone

There are two options, voice and beep, voice option means when the user operates camera, it will give the corresponding response, OFF, beep or voice, and it will applied to the operations as follows:

1. Start video recording;
2. Stop video recording;
3. Start audio recording;
4. Stop audio recording;
5. Power on the camera;
6. Power off the camera;
7. Low battery;
8. Inadequate storage space;

Beep option means it only beep when do the operations.

14. Hourly notice

Select to turn the hourly notice ON or OFF, it will give the voice report hourly if the switch is ON.

SETUP>>>>SEVER

ID	Menu	Options
1	Sever	Configure the server IP, port and user number.
2	Platform QR code	Scan a QR code to setup the server IP
3	Stream	H.264, H.265
4	Bitrate	Select different resolution and bitrate for streaming
5	Upload frequency	0~999 seconds optional
6	FTP	Setup the FPT information for uploading
7	Geo-fence alert	ON,OFF

1. Server

Setup the server IP, port, and user number, make sure the camera can connect to the center server.

2. Platform QR code

Scan the QR code, it can setup the server IP automatically.

3. Stream

Setup the live streaming encoding mode, H.264 or H.265.

4. Stream bitrate

Select the bitrate for the live video streaming.

5. Upload frequency

Select the GPS upload frequency time, it means every this certain time, it will upload a GPS info to center server.

6. FTP

Setup the FTP information, such as FTP IP, FTP port, username and password, as well as the http port, as long as the FTP network is normal, you can go to APP>>>>upload, select the video or pictures, upload to the center server.

7. Geo-fence alert

Option is ON or OFF, when it's ON, it will have beep alert when camera enter into a special area, this area will setup in the center server.

SETUP>>>>SYSTEM

ID	Menu	Options
1	WAN	OFF,ON
2	Mobile data	OFF,ON
3	Bluetooth	OFF,ON
4	Location	GPS, GPS+Beidou, Beidou
5	Date and Time	Setup the time of camera
6	Offline connection	OFF,ON
7	About	All the information of camera
8	Default setting	Drag the icon to adjust

1. WAN

Enable it, so the camera can connect to WIFI network.

2. Mobile data

Only when this option is on, the 4G network can transmit the live video to center server.

3. Bluetooth

Enable the Bluetooth function, which can connect to an earphone.

4. Location

It means the frequency that camera upload the GPS data to the center server.

5. Date and Time

Enter into the interface to setup the date and time of the camera, or use time sync function.

6. Offline connection

It means when the camera connect to PC or docking station through USB port, the camera will disconnect the wireless connection.

7. About

It will show the information of the camera, network status, firmware version, and so on.

Mark:For the internal battery, only when the voltage more than 3.5v, it can works when remove the main battery.

8. Default

When it is set as ON, the camera will auto-reboot to clear all the settings of menu, but all the playback files will still be in the camera.

4. Device using



1. Turning On the Camera

In power off status, long press  for 3 seconds, the camera will be turn on and enter into preview mode automatically. Meanwhile, the status indicator will turn green.

2. Turning off the camera



In preview mode, long press  for 3 seconds, the camera will save the current status and power off. Meanwhile, the status indicator will turn off.

3. Recording Video



In preview mode, short press  to start recording. Meanwhile, the status indicator will turn red and flash, and the recording icon will turn to red. Short press  again to stop recording, and the video will be saved in MP4 format automatically.

Remark: During video recording, can zoom in and zoom out by sliding the icon in the screen.



4. Snapshot

In preview mode, press  to take a photo; long press  to take more photos continuously, the quantity of photo can be configure in the menu. Meanwhile, the status indicator will turn red and flash, snapshot icon will turn to red. and the photo will be saved in JPG format automatically.



5. Audio recording

In preview mode, short press  to start audio recording. The recording icon display on the screen, the status indicator will turn to yellow and flash. Short press  again, the camera will stop audio recording, and the audio will be saved in WAV format automatically.

6. Playback



Click HOME key  to enter the menu interface, and then click Playback  to enter into playback interface and play the selected file

7. Make a flag for the file



In video/audio recording mode, short press flag button  to mark it as important file, the icon  will display on the top of screen. Short press key mark button  again to cancel the mark.

When playback the file, short press key mark button  to mark it as important file or cancel the mark. The name of the marked file has the characters “IMP”.



8. Parameter configuration

Click HOME key  to enter the menu interface, and click Setup icon  to enter into the parameters configure interface, you can setup all the camera parameters here, such as resolution, network settings and so on.



9. Intercom

Click HOME key  to enter the menu interface, and click Intercom icon , enter into the intercom interface, and select online users for video or voice intercom, you can finish it by sliding the end button.

10. Alarm

Click HOME key  to enter the menu, and click Alarm  to enter into the Alarm interface, you can browse the received alarm, select and check the details, open the video, the video files will be automatically associated with the alarm and marked as important documents.

11. Application

Click HOME key  to enter the menu, and click APP , enter APP interface and select the corresponding application.

12. SOS

Short press SOS button , the camera will send emergency alert to the Center management platform.

13. 13 Reset

If the system crash and the operation is no respond, long press power button for about 10 seconds, the camera will be forced to reset

Remark:Reset operation will not cause data loss or damage, and it will not change the system settings.

1. Replace battery

- ① Press the battery cover lock down, and do not loose it
- ② Push the battery cover parallel to the direction of the arrow and remove it.

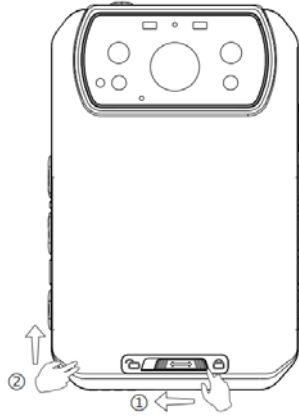

2. Charging the Battery

Remark: When you recharge the body camera, please make sure it is OFF. Also, even you don't use the camera for a long time; please recharge it every 3 months.

1.Charge the camera

Connect this camera and adapter via USB cable, and connect adapter to power supply to charge the battery. In charging status, the status indicator will turn red. Once the battery is fully charged, the status indicator will turn green.

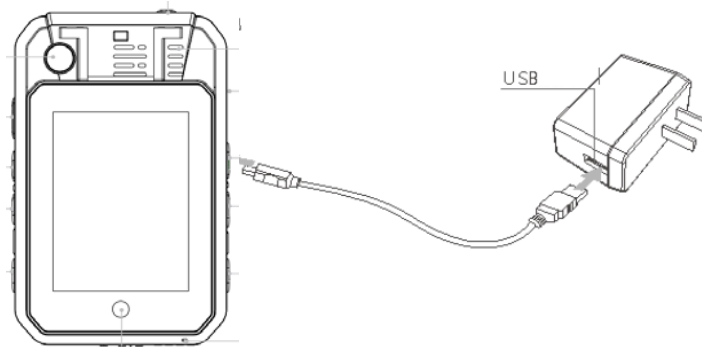

FCC Caution: Any changes or modifications not expressly approved by the party responsible for compliance could void the user's authority to operate this equipment.

This device complies with Part 15 of the FCC Rules. Operation is subject to the following two conditions:

- (1) This device may not cause harmful interference, and
- (2) this device must accept any interference received, including interference that may cause undesired operation.

This Product meets the government's requirements for exposure to radio waves. The guidelines are based on standards that were developed by independent scientific organizations through periodic and thorough evaluation of scientific studies.

The standards include a substantial safety margin designed to assure the safety of all persons regardless of age or health.

FCC RF Exposure Information and Statement the SAR limit of USA (FCC) is 1.6 W/kg averaged over one gram of this Device BWC-R3 (FCC ID: 2AY9QBWC-R3) has been tested against this SAR limit. SAR information on this can be viewed on-line at <http://www.fcc.gov/oet/ea/fccid/>. Please use the device FCC ID number for search. This device was tested for typical operations 10mm from the body. To maintain compliance with FCC RF exposure requirements, 10mm separation distance should be maintained to the user's bodies

NOTE:

This equipment has been tested and found to comply with the limits for a Class B digital device, pursuant to Part 15 of the FCC Rules.

These limits are designed to provide reasonable protection against harmful interference in a residential installation. This equipment generates, uses and can radiate radio frequency energy and, if not installed and used in accordance with the instructions, may cause harmful interference to radio communications.

However, there is no guarantee that interference will not occur in a particular installation. If this equipment does cause harmful interference to radio or television reception, which can be determined by turning the equipment off and on, the user is encouraged to try to correct the interference by one or more of the following measures:

- Reorient or relocate the receiving antenna.
- Increase the separation between the equipment and receiver.
- Connect the equipment into an outlet on a circuit different from that to which the receiver is connected.
- Consult the dealer or an experienced radio/TV technician for help.