

# FCC SAR EVALUATION REPORT

In accordance with the requirements of  
FCC 47 CFR Part 2(2.1093), ANSI/IEEE C95.1-1992 and  
IEEE Std 1528-2013

**Product Name :** Body worn camera

**Brand Name :** YULONG

**Model Name :** BWC-R3

**Family Model :** BWC-R3S, BWC-R3L, BWC-R5, BWC-R5S,  
BWC-R5L, BWC-R3H, DSJ-YDTK2A1,  
DSJ-YDTK3A1, DSJ-YDTK4A1,  
DSJ-YDTF2A1, DSJ-YDTF3A1,  
DSJ-YDTF4A1, DSJ-K2 , DSJ-K3, DSJ-K4

**Report No. :** S20110700106001

**FCC ID :** 2AY9QBWC-R3

## Prepared for

Shenzhen YULONG Digital Technology Co., Ltd  
601, Building F1, TCL Science Park, No. 1001 Zhongshanyuan Road, Nanshan  
District, Shenzhen, P.R.China

## Prepared by

Shenzhen NTEK Testing Technology Co., Ltd.  
1/F, Building E, Fenda Science Park, Sanwei Community, Xixiang Street,  
Bao'an District, Shenzhen 518126 P.R.China.  
Tel. 400-800-6106, 0755-2320 0050, 0755-2320 0090  
Website: <http://www.ntek.org.cn>

## TEST RESULT CERTIFICATION

**Applicant's name**.....: Shenzhen YULONG Digital Technology Co., Ltd  
 Address .....: 601, Building F1,TCL Science Park,No. 1001 Zhongshanyuan  
 Road, Nanshan District,Shenzhen, P.R.China  
**Manufacturer's Name**.....: Shenzhen YULONG Digital Technology Co., Ltd  
 Address .....: 601, Building F1,TCL Science Park,No. 1001 Zhongshanyuan  
 Road, Nanshan District,Shenzhen, P.R.China

**Product description**

Product name.....: Body worn camera  
 Brand Name .....: YULONG  
 Model and/or type reference : BWC-R3  
 BWC-R3S, BWC-R3L, BWC-R5, BWC-R5S, BWC-R5L, BWC-R3H,  
 Family Model.....: DSJ-YDTK2A1, DSJ-YDTK3A1, DSJ-YDTK4A1, DSJ-YDTF2A1,  
 DSJ-YDTF3A1, DSJ-YDTF4A1, DSJ-K2 , DSJ-K3, DSJ-K4  
 FCC 47 CFR Part 2(2.1093)  
 ANSI/IEEE C95.1-1992

**Standards**.....: IEEE Std 1528-2013  
 Published RF exposure KDB procedures

This device described above has been tested by Shenzhen NTEK. In accordance with the measurement methods and procedures specified in IEEE Std 1528-2013 and KDB 865664 D01. Testing has shown that this device is capable of compliance with localized specific absorption rate (SAR) specified in FCC 47 CFR Part 2(2.1093) and ANSI/IEEE C95.1-1992. The test results in this report apply only to the tested sample of the stated device/equipment. Other similar device/equipment will not necessarily produce the same results due to production tolerance and measurement uncertainties.

This report shall not be reproduced except in full, without the written approval of Shenzhen NTEK, this document may be altered or revised by Shenzhen NTEK, personal only, and shall be noted in the revision of the document.

**Date of Test**

Date (s) of performance of tests..... : Jan. 06, 2021 ~ Jan. 16, 2021  
 Date of Issue ..... : Mar. 15, 2021  
 Test Result ..... : **Pass**

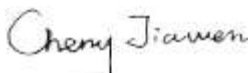
Prepared By :   
 (Test Engineer) : \_\_\_\_\_  
 (Cheng Jiawen)

Approved By :   
 (Lab Manager) : \_\_\_\_\_  
 (Alex Li)

※ ※ Revision History ※ ※

REV.	DESCRIPTION	ISSUED DATE	REMARK
Rev.1.0	Initial Test Report Release	Mar. 15, 2021	Cheng Jiawen

## TABLE OF CONTENTS

1. General Information .....	6
1.1. RF exposure limits.....	6
1.2. Statement of Compliance .....	7
1.3. EUT Description .....	7
1.4. Test specification(s) .....	9
1.5. Ambient Condition.....	9
2. SAR Measurement System .....	10
2.1. SATIMO SAR Measurement Set-up Diagram .....	10
2.2. Robot .....	11
2.3. E-Field Probe.....	12
2.3.1. E-Field Probe Calibration .....	13
2.4. SAM phantoms .....	13
2.4.1. Technical Data .....	14
2.5. Device Holder .....	15
2.6. Test Equipment List .....	16
3. SAR Measurement Procedures .....	18
3.1. Power Reference .....	18
3.2. Area scan & Zoom scan.....	18
3.3. Description of interpolation/extrapolation scheme .....	20
3.4. Volumetric Scan .....	20
3.5. Power Drift .....	20
4. System Verification Procedure .....	21
4.1. Tissue Verification .....	21
4.1.1. Tissue Dielectric Parameter Check Results .....	22
4.2. System Verification Procedure .....	23
4.2.1. System Verification Results.....	24
5. SAR Measurement variability and uncertainty .....	25
5.1. SAR measurement variability.....	25
5.2. SAR measurement uncertainty .....	25
6. RF Exposure Positions.....	26
6.1. Body Worn Accessory .....	26
6.2. Wireless Router Devices .....	27
7. RF Output Power .....	28
7.1. GSM Conducted Power .....	28
7.2. WCDMA Conducted Power .....	28
7.3. LTE Conducted Power .....	30
7.4. WLAN & Bluetooth Output Power .....	43
8. Antenna Location.....	45
9. Stand-alone SAR test exclusion.....	46

10.	SAR Results .....	46
10.1.	SAR measurement Result.....	46
10.1.1.	SAR measurement Result of GSM850.....	46
10.1.2.	SAR measurement Result of GSM1900.....	47
10.1.3.	SAR measurement Result of WCDMA Band 2.....	47
10.1.4.	SAR measurement Result of WCDMA Band 5.....	48
10.1.5.	SAR measurement Result of LTE Band 2 .....	48
10.1.6.	SAR measurement Result of LTE Band 4 .....	49
10.1.7.	SAR measurement Result of LTE Band 5 .....	50
10.1.8.	SAR measurement Result of LTE Band 7 .....	50
10.1.9.	SAR measurement Result of LTE Band 40A.....	51
10.1.10.	SAR measurement Result of LTE Band 40B .....	52
10.1.11.	SAR measurement Result of LTE Band 41 .....	53
10.1.12.	SAR measurement Result of WLAN 2.4G .....	53
10.2.	Simultaneous Transmission Analysis.....	54
11.	Appendix A. Photo documentation .....	54
12.	Appendix B. System Check Plots.....	55
13.	Appendix C. Plots of High SAR Measurement.....	68
14.	Appendix D. Calibration Certificate .....	93

## 1. General Information

### 1.1. RF exposure limits

(A).Limits for Occupational/Controlled Exposure (W/kg)

Whole-Body	Partial-Body	Hands, Wrists, Feet and Ankles
0.4	8.0	20.0

(B).Limits for General Population/Uncontrolled Exposure (W/kg)

Whole-Body	Partial-Body	Hands, Wrists, Feet and Ankles
0.08	1.6	4.0

NOTE: **Whole-Body SAR** is averaged over the entire body, **partial-body SAR** is averaged over any 1 gram of tissue defined as a tissue volume in the shape of a cube. **SAR for hands, wrists, feet and ankles** is averaged over any 10 grams of tissue defined as a tissue volume in the shape of a cube.

#### **Occupational/Controlled Environments:**

Are defined as locations where there is exposure that may be incurred by people who are aware of the potential for exposure, (i.e. as a result of employment or occupation).

#### **General Population/Uncontrolled Environments:**

Are defined as locations where there is the exposure of individuals who have no knowledge or control of their exposure.

NOTE  
TRUNK LIMIT  
1.6 W/kg  
APPLIED TO THIS EUT

## 1.2. Statement of Compliance

The maximum results of Specific Absorption Rate (SAR) found during testing for BWC-R3 are as follows.

RF Exposure Conditions		Equipment Class - Highest Reported SAR (W/kg)			
		PCE	DTS	NII	DSS
1-g Body-Worn (Separation distance of 10mm)		0.727	0.109	N/A	N/A
Max Simultaneous Tx	Body-Worn	0.930	0.781	0.930	0.760

Note: The Max Simultaneous Tx is calculated based on the same configuration and test position.

This device is in compliance with Specific Absorption Rate (SAR) for general population/uncontrolled exposure limits (1.6 W/kg) specified in FCC 47 CFR Part 2(2.1093) and ANSI/IEEE C95.1-1992, and had been tested in accordance with the measurement methods and procedures specified in IEEE Std 1528-2013 & KDB 865664 D01.

## 1.3. EUT Description

Device Information			
Product Name	Body worn camera		
Brand Name	YULONG		
Model Name	BWC-R3		
Family Model	BWC-R3S, BWC-R3L, BWC-R5, BWC-R5S, BWC-R5L, BWC-R3H, DSJ-YDTK2A1, DSJ-YDTK3A1, DSJ-YDTK4A1, DSJ-YDTF2A1, DSJ-YDTF3A1, DSJ-YDTF4A1, DSJ-K2, DSJ-K3, DSJ-K4		
FCC ID	2AY9QBWC-R3		
Device Phase	Identical Prototype		
Exposure Category	General population / Uncontrolled environment		
Antenna Type	BT/WIFI / GPS: PIFA Antenna; GSM/WCDMA/LTE: monopole Antenna;		
Battery Information	DC 3.8V, 3050mAh		
Device Operating Configurations			
Supporting Mode(s)	GSM 850/1900, WCDMA Band 2/5, LTE Band 2/4/5/7/40/41, WLAN 2.4G/5.8G, Bluetooth, GPS, NFC		
Test Modulation	GSM(GMSK/8PSK), WCDMA(QPSK), LTE(QPSK/16QAM), WLAN(DSSS/OFDM), Bluetooth(GFSK, π/4-DQPSK, 8DPSK), NFC(ASK)		
Device Class	B		
Operating Frequency Range(s)	Band	Tx (MHz)	Rx (MHz)
	GSM 850	824-849	869-894

	GSM 1900	1850-1910	1930-1990
	WCDMA Band 2	1850-1910	1930-1990
	WCDMA Band 5	824-849	869-894
	LTE Band 2	1850-1910	1930-1990
	LTE Band 4	1710-1755	2110-2155
	LTE Band 5	824-849	869-894
	LTE Band 7	2500-2570	2620-2690
	LTE Band 40A	2305-2315	
	LTE Band 40B	2350-2360	
	LTE Band 41	2496-2690	
	WLAN 2.4G	2412-2462	
	WLAN 5.8G	5745-5825	
	Bluetooth	2402-2480	
	NFC	13.56	
GPRS Multislot Class(12)	Max Number of Timeslots in Uplink		4
	Max Number of Timeslots in Downlink		4
	Max Total Timeslot		5
EDGE Multislot Class(12)	Max Number of Timeslots in Uplink		4
	Max Number of Timeslots in Downlink		4
	Max Total Timeslot		5
Power Class	4, tested with power level 5(GSM 850)		
	1, tested with power level 0(GSM 1900)		
	3, tested with power control "all 1"(WCDMA Band 2)		
	3, tested with power control "all 1"(WCDMA Band 5)		
	3, tested with power control all Max.(LTE Band 2)		
	3, tested with power control all Max.(LTE Band 4)		
	3, tested with power control all Max.(LTE Band 5)		
	3, tested with power control all Max.(LTE Band 7)		
	3, tested with power control all Max.(LTE Band 40)		
	3, tested with power control all Max.(LTE Band 41)		



**1.4. Test specification(s)**

FCC 47 CFR Part 2(2.1093)
ANSI/IEEE C95.1-1992
IEEE Std 1528-2013
KDB 865664 D01 SAR measurement 100 MHz to 6 GHz
KDB 865664 D02 RF Exposure Reporting
KDB 447498 D01 General RF Exposure Guidance
KDB 248227 D01 802.11 Wi-Fi SAR
KDB 941225 D01 3G SAR Procedures
KDB 941225 D05 SAR for LTE Devices

**1.5. Ambient Condition**

Ambient temperature	20°C – 24°C
Relative Humidity	30% – 70%

## 2. SAR Measurement System

### 2.1. SATIMO SAR Measurement Set-up Diagram

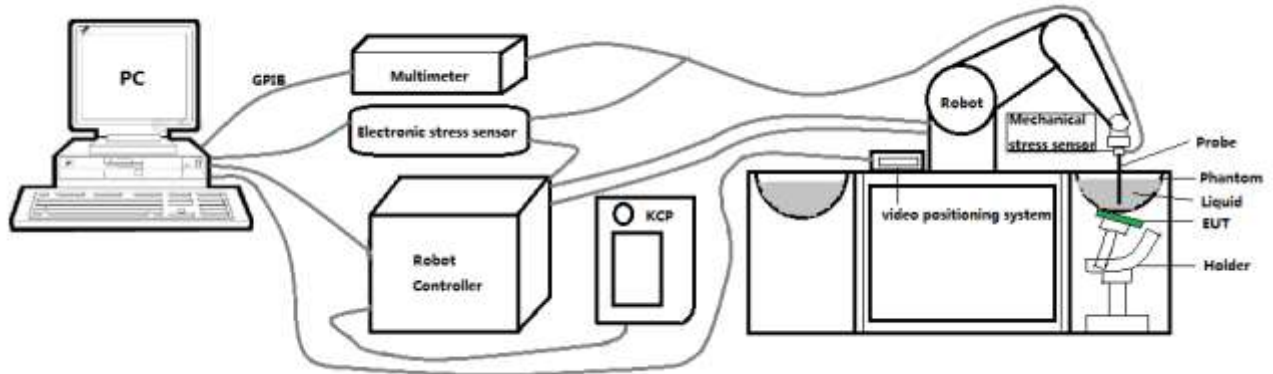

These measurements were performed with the automated near-field scanning system OPENSAR from SATIMO. The system is based on a high precision robot (working range: 901 mm), which positions the probes with a positional repeatability of better than  $\pm 0.03$  mm. The SAR measurements were conducted with dosimetric probe (manufactured by SATIMO), designed in the classical triangular configuration and optimized for dosimetric evaluation.

The first step of the field measurement is the evaluation of the voltages induced on the probe by the device under test. Probe diode detectors are nonlinear. Below the diode compression point, the output voltage is proportional to the square of the applied E-field; above the diode compression point, it is linear to the applied E-field. The compression point depends on the diode, and a calibration procedure is necessary for each sensor of the probe.

The Keithley multimeter reads the voltage of each sensor and send these three values to the PC. The corresponding E field value is calculated using the probe calibration factors, which are stored in the working directory. This evaluation includes linearization of the diode characteristics. The field calculation is done separately for each sensor. Each component of the E field is displayed on the "Dipole Area Scan Interface" and the total E field is displayed on the "3D Interface"

## 2.2. Robot

The SATIMO SAR system uses the high precision robots from KUKA. For the 6-axis controller system, the robot controller version (KUKA) from KUKA is used. The KUKA robot series have many features that are important for our application:



- High precision (repeatability  $\pm 0.03$  mm)
- High reliability (industrial design)
- Jerk-free straight movements
- Low ELF interference (the closed metallic construction shields against motor control fields)

### 2.3. E-Field Probe

This E-field detection probe is composed of three orthogonal dipoles linked to special Schottky diodes with low detection thresholds. The probe allows the measurement of electric fields in liquids such as the one defined in the IEEE and CENELEC standards.

For the measurements the Specific Dosimetric E-Field Probe SN 41/18 EPGO330 with following specifications is used



- Dynamic range: 0.01-100 W/kg
  - Tip Diameter: 2.5 mm
  - Distance between probe tip and sensor center: 1 mm
  - Distance between sensor center and the inner phantom surface: 2 mm (repeatability better than  $\pm 1$  mm).
  - Probe linearity:  $\pm 0.10$  dB
  - Axial isotropy: 0.06 dB
  - Hemispherical Isotropy: 0.09 dB
  - Calibration range: 650MHz to 5900MHz for head & body simulating liquid.
  - Lower detection limit: 9mW/kg
- Angle between probe axis (evaluation axis) and surface normal line: less than  $30^\circ$ .

For the measurements the Specific Dosimetric E-Field Probe SN 07/15 EP247 with following specifications is used



- Dynamic range: 0.01-100 W/kg
  - Tip Diameter : 5 mm
  - Distance between probe tip and sensor center: 2.7 mm
  - Distance between sensor center and the inner phantom surface: 4 mm (repeatability better than  $\pm 1$  mm).
  - Probe linearity:  $\pm 0.05$  dB
  - Axial isotropy: 0.05 dB
  - Hemispherical Isotropy: 0.08 dB
  - Calibration range: 440MHz to 2700MHz for head & body simulating liquid.
  - Lower detection limit: 8mW/kg
- Angle between probe axis (evaluation axis) and surface normal line: less than  $30^\circ$ .

### 2.3.1. E-Field Probe Calibration

Each probe needs to be calibrated according to a dosimetric assessment procedure with accuracy better than  $\pm 10\%$ . The spherical isotropy shall be evaluated and within  $\pm 0.25\text{dB}$ . The sensitivity parameters (Norm X, Norm Y, and Norm Z), the diode compression parameter (DCP) and the conversion factor (Conv F) of the probe are tested. The calibration data can be referred to appendix D of this report.

### 2.4. SAM phantoms

Photo of SAM phantom SN 16/15 SAM119



The SAM phantom is used to measure the SAR relative to people exposed to electro-magnetic field radiated by mobile phones.

**2.4.1. Technical Data**

Serial Number	Shell thickness	Filling volume	Dimensions	Positionner Material	Permittivity	Loss Tangent
<b>SN 16/15 SAM119</b>	2 mm ±0.2 mm	27 liters	Length:1000 mm Width:500 mm Height:200 mm	Gelcoat with fiberglass	3.4	0.02

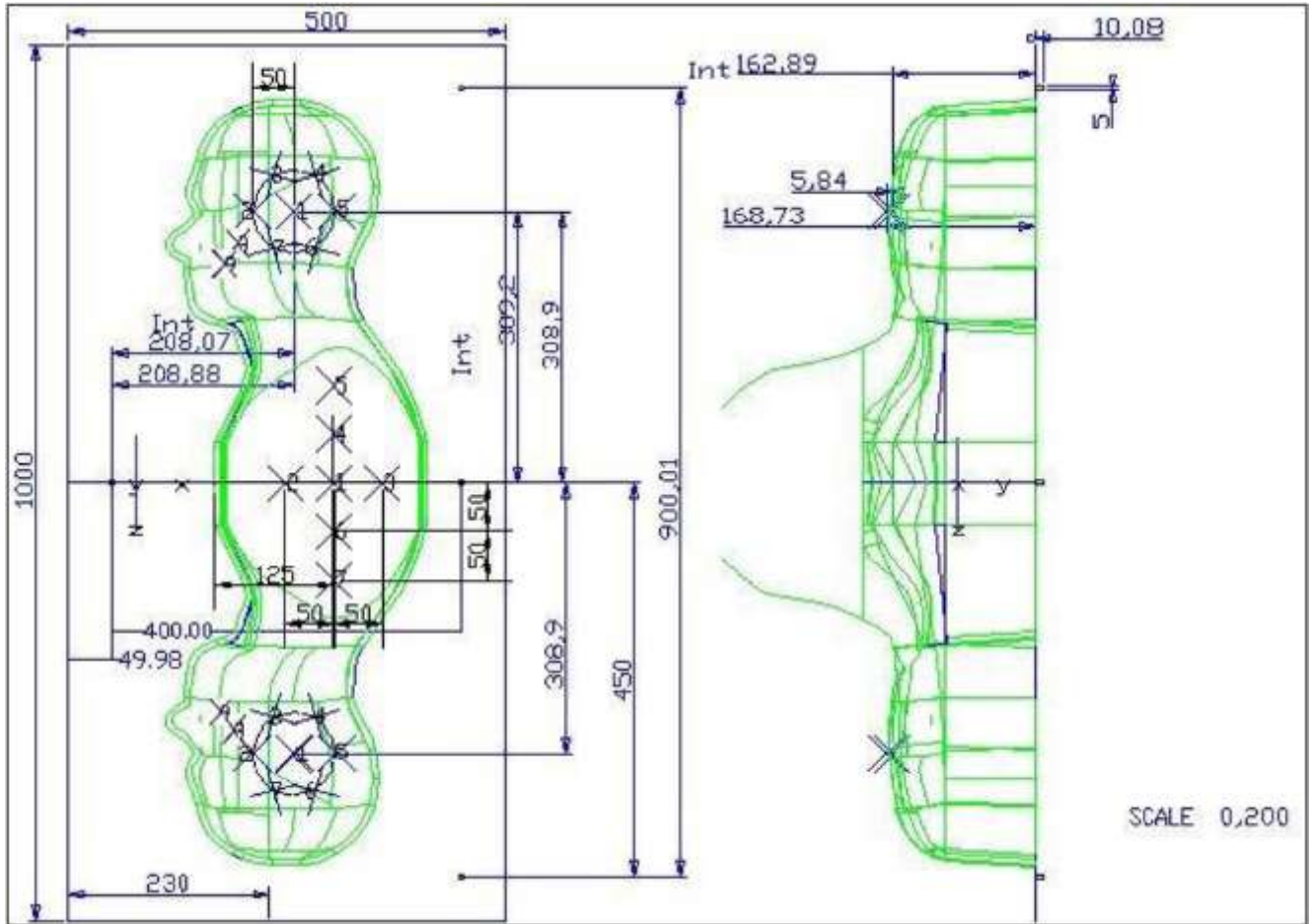

Serial Number	Left Head(mm)		Right Head(mm)		Flat Part(mm)	
	1	2	1	2	1	2
<b>SN 16/15 SAM119</b>	2	2.02	2	2.08	1	2.09
	3	2.05	3	2.06	2	2.06
	4	2.07	4	2.07	3	2.08
	5	2.08	5	2.08	4	2.10
	6	2.05	6	2.07	5	2.10
	7	2.05	7	2.05	6	2.07
	8	2.07	8	2.06	7	2.07
	9	2.08	9	2.06	-	-

The test, based on ultrasonic system, allows measuring the thickness with an accuracy of 10 µm.

## 2.5. Device Holder

The positioning system allows obtaining cheek and tilting position with a very good accuracy. In compliance with CENELEC, the tilt angle uncertainty is lower than 1 degree.

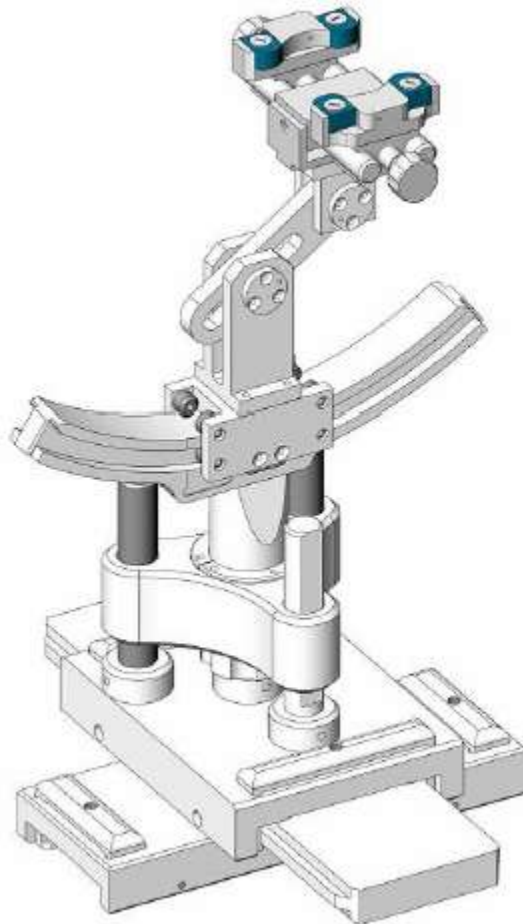

Serial Number	Holder Material	Permittivity	Loss Tangent
SN 16/15 MSH100	Delrin	3.7	0.005

## 2.6. Test Equipment List

This table gives a complete overview of the SAR measurement equipment.

Devices used during the test described are marked

	Manufacturer	Name of Equipment	Type/Model	Serial Number	Calibration	
					Last Cal.	Due Date
<input checked="" type="checkbox"/>	MVG	E FIELD PROBE	SSE2	SN 41/18 EPGO330	Sep. 21, 2020	Sep. 20, 2021
<input checked="" type="checkbox"/>	MVG	E FIELD PROBE	SSE5	SN 07/15 EP247	Sep. 25, 2020	Sep. 24, 2021
<input type="checkbox"/>	MVG	750 MHz Dipole	SID750	SN 03/15 DIP 0G750-355	Apr. 19, 2018	Apr. 18, 2021
<input checked="" type="checkbox"/>	MVG	835 MHz Dipole	SID835	SN 03/15 DIP 0G835-347	Apr. 19, 2018	Apr. 18, 2021
<input type="checkbox"/>	MVG	900 MHz Dipole	SID900	SN 03/15 DIP 0G900-348	Apr. 19, 2018	Apr. 18, 2021
<input checked="" type="checkbox"/>	MVG	1800 MHz Dipole	SID1800	SN 03/15 DIP 1G800-349	Apr. 19, 2018	Apr. 18, 2021
<input checked="" type="checkbox"/>	MVG	1900 MHz Dipole	SID1900	SN 03/15 DIP 1G900-350	Apr. 19, 2018	Apr. 18, 2021
<input type="checkbox"/>	MVG	2000 MHz Dipole	SID2000	SN 03/15 DIP 2G000-351	Apr. 19, 2018	Apr. 18, 2021
<input checked="" type="checkbox"/>	MVG	2300 MHz Dipole	SID2300	SN 03/16 DIP 2G300-358	Nov. 08, 2018	Nov. 07, 2021
<input checked="" type="checkbox"/>	MVG	2450 MHz Dipole	SID2450	SN 03/15 DIP 2G450-352	Apr. 19, 2018	Apr. 18, 2021
<input checked="" type="checkbox"/>	MVG	2600 MHz Dipole	SID2600	SN 03/15 DIP 2G600-356	Apr. 19, 2018	Apr. 18, 2021
<input type="checkbox"/>	MVG	5000 MHz Dipole	SWG5500	SN 13/14 WGA 33	Apr. 19, 2018	Apr. 18, 2021
<input checked="" type="checkbox"/>	MVG	Liquid measurement Kit	SCLMP	SN 21/15 OCPG 72	NCR	NCR
<input checked="" type="checkbox"/>	MVG	Power Amplifier	N.A	AMPLISAR_28/14_0 03	NCR	NCR
<input checked="" type="checkbox"/>	KEITHLEY	Millivoltmeter	2000	4072790	NCR	NCR
<input checked="" type="checkbox"/>	R&S	Universal radio communication tester	CMU200	117858	Jul. 13, 2020	Jul. 12, 2021
<input checked="" type="checkbox"/>	R&S	Wideband radio communication	CMW500	103917	Jul. 13, 2020	Jul. 12, 2021



		tester				
<input checked="" type="checkbox"/>	HP	Network Analyzer	8753D	3410J01136	Jul. 13, 2020	Jul. 12, 2021
<input checked="" type="checkbox"/>	Agilent	PSG Analog Signal Generator	E8257D	MY51110112	Jul. 13, 2020	Jul. 12, 2021
<input checked="" type="checkbox"/>	Agilent	Power meter	E4419B	MY45102538	Jul. 13, 2020	Jul. 12, 2021
<input checked="" type="checkbox"/>	Agilent	Power sensor	E9301A	MY41495644	Jul. 13, 2020	Jul. 12, 2021
<input checked="" type="checkbox"/>	Agilent	Power sensor	E9301A	US39212148	Jul. 13, 2020	Jul. 12, 2021
<input checked="" type="checkbox"/>	MCLI/USA	Directional Coupler	CB11-20	0D2L51502	Jul. 17, 2020	Jul. 16, 2023

### 3. SAR Measurement Procedures

The measurement procedures are as follows:

<Conducted power measurement>

- (a) For WWAN power measurement, use base station simulator to configure EUT WWAN transmission in conducted connection with RF cable, at maximum power in each supported wireless interface and frequency band.
- (b) Read the WWAN RF power level from the base station simulator.
- (c) For Wi-Fi/BT power measurement, use engineering software to configure EUT Wi-Fi/BT continuously transmission, at maximum RF power in each supported wireless interface and frequency band.
- (d) Connect EUT RF port through RF cable to the power meter, and measure Wi-Fi/BT output power.

<SAR measurement>

- (a) Use base station simulator to configure EUT WWAN transmission in radiated connection, and engineering software to configure EUT Wi-Fi/BT continuously transmission, at maximum RF power, in the highest power channel.
- (b) Place the EUT in the positions as Appendix A demonstrates.
- (c) Set scan area, grid size and other setting on the OPENSAR software.
- (d) Measure SAR results for the highest power channel on each testing position.
- (e) Find out the largest SAR result on these testing positions of each band.
- (f) Measure SAR results for other channels in worst SAR testing position if the reported SAR of highest power channel is larger than 0.8 W/kg.

According to the test standard, the recommended procedure for assessing the peak spatial-average SAR value consists of the following steps:

- (a) Power reference measurement
- (b) Area scan
- (c) Zoom scan
- (d) Power drift measurement

#### 3.1. Power Reference

The Power Reference Measurement and Power Drift Measurements are for monitoring the power drift of the device under test in the batch process. The minimum distance of probe sensors to surface determines the closest measurement point to phantom surface. This distance cannot be smaller than the distance of sensor calibration points to probe tip as defined in the probe properties.

#### 3.2. Area scan & Zoom scan

The area scan is a 2D scan to find the hot spot location on the DUT. The zoom scan is a 3D scan above the hot spot to calculate the 1g and 10g SAR value.

Measurement of the SAR distribution with a grid of 8 to 16 mm \* 8 to 16 mm and a constant distance to

the inner surface of the phantom. Since the sensors cannot directly measure at the inner phantom surface, the values between the sensors and the inner phantom surface are extrapolated. With these values the area of the maximum SAR is calculated by an interpolation scheme. Around this point, a cube of 30 \* 30 \* 30 mm or 32 \* 32 \* 32 mm is assessed by measuring 5 or 8 \* 5 or 8 \* 4 or 5 mm. With these data, the peak spatial-average SAR value can be calculated.

From the scanned SAR distribution, identify the position of the maximum SAR value, in addition identify the positions of any local maxima with SAR values within 2 dB of the maximum value that will not be within the zoom scan of other peaks; additional peaks shall be measured only when the primary peak is within 2 dB of the SAR compliance limit (e.g., 1 W/kg for 1,6 W/kg 1 g limit, or 1,26 W/kg for 2 W/kg, 10 g limit).

Area scan & Zoom scan scan parameters extracted from FCC KDB 865664 D01 SAR measurement 100 MHz to 6 GHz.

		$\leq 3$ GHz	$> 3$ GHz	
Maximum distance from closest measurement point (geometric center of probe sensors) to phantom surface		$5 \pm 1$ mm	$\frac{1}{2} \cdot \delta \cdot \ln(2) \pm 0.5$ mm	
Maximum probe angle from probe axis to phantom surface normal at the measurement location		$30^\circ \pm 1^\circ$	$20^\circ \pm 1^\circ$	
Maximum area scan spatial resolution: $\Delta x_{Area}$ , $\Delta y_{Area}$		$\leq 2$ GHz: $\leq 15$ mm 2 – 3 GHz: $\leq 12$ mm	3 – 4 GHz: $\leq 12$ mm 4 – 6 GHz: $\leq 10$ mm	
		When the x or y dimension of the test device, in the measurement plane orientation, is smaller than the above, the measurement resolution must be $\leq$ the corresponding x or y dimension of the test device with at least one measurement point on the test device.		
Maximum zoom scan spatial resolution: $\Delta x_{Zoom}$ , $\Delta y_{Zoom}$		$\leq 2$ GHz: $\leq 8$ mm 2 – 3 GHz: $\leq 5$ mm*	3 – 4 GHz: $\leq 5$ mm* 4 – 6 GHz: $\leq 4$ mm*	
Maximum zoom scan spatial resolution, normal to phantom surface	uniform grid: $\Delta z_{Zoom}(n)$	$\leq 5$ mm	3 – 4 GHz: $\leq 4$ mm 4 – 5 GHz: $\leq 3$ mm 5 – 6 GHz: $\leq 2$ mm	
	graded grid	$\Delta z_{Zoom}(1)$ : between 1 <sup>st</sup> two points closest to phantom surface	$\leq 4$ mm	3 – 4 GHz: $\leq 3$ mm 4 – 5 GHz: $\leq 2.5$ mm 5 – 6 GHz: $\leq 2$ mm
		$\Delta z_{Zoom}(n>1)$ : between subsequent points	$\leq 1.5 \cdot \Delta z_{Zoom}(n-1)$	
Minimum zoom scan volume	x, y, z	$\geq 30$ mm	3 – 4 GHz: $\geq 28$ mm 4 – 5 GHz: $\geq 25$ mm 5 – 6 GHz: $\geq 22$ mm	

Note:  $\delta$  is the penetration depth of a plane-wave at normal incidence to the tissue medium; see draft standard IEEE P1528-2011 for details.

\* When zoom scan is required and the *reported* SAR from the *area scan based 1-g SAR estimation* procedures of KDB 447498 is  $\leq 1.4$  W/kg,  $\leq 8$  mm,  $\leq 7$  mm and  $\leq 5$  mm zoom scan resolution may be applied, respectively, for 2 GHz to 3 GHz, 3 GHz to 4 GHz and 4 GHz to 6 GHz.

### **3.3. Description of interpolation/extrapolation scheme**

The local SAR inside the phantom is measured using small dipole sensing elements inside a probe body. The probe tip must not be in contact with the phantom surface in order to minimise measurements errors, but the highest local SAR will occur at the surface of the phantom.

An extrapolation is using to determinate this highest local SAR values. The extrapolation is based on a fourth-order least-square polynomial fit of measured data. The local SAR value is then extrapolated from the liquid surface with a 1 mm step.

The measurements have to be performed over a limited time (due to the duration of the battery) so the step of measurement is high. It could vary between 5 and 8 mm. To obtain an accurate assessment of the maximum SAR averaged over 10 grams and 1 gram requires a very fine resolution in the three dimensional scanned data array.

### **3.4. Volumetric Scan**

The volumetric scan consists to a full 3D scan over a specific area. This 3D scan is useful form multi Tx SAR measurement. Indeed, it is possible with OpenSAR to add, point by point, several volumetric scan to calculate the SAR value of the combined measurement as it is define in the standard IEEE1528 and IEC62209.

### **3.5. Power Drift**

All SAR testing is under the EUT install full charged battery and transmit maximum output power. In OpenSAR measurement software, the power reference measurement and power drift measurement procedures are used for monitoring the power drift of EUT during SAR test. Both these procedures measure the field at a specified reference position before and after the SAR testing. The software will calculate the field difference in V/m. If the power drifts more than  $\pm 5\%$ , the SAR will be retested.

## 4. System Verification Procedure

### 4.1. Tissue Verification

The following tissue formulations are provided for reference only as some of the parameters have not been thoroughly verified. The composition of ingredients may be modified accordingly to achieve the desired target tissue parameters required for routine SAR evaluation.

Ingredients (% of weight)	Head Tissue									
	750	835	900	1800	1900	2000	2450	2600	5200	5800
Frequency Band (MHz)										
Water	34.40	34.40	34.40	55.36	55.36	57.87	57.87	57.87	65.53	65.53
NaCl	0.79	0.79	0.79	0.35	0.35	0.16	0.16	0.16	0.00	0.00
1,2-Propanediol	64.81	64.81	64.81	0.00	0.00	0.00	0.00	0.00	0.00	0.00
Triton X-100	0.00	0.00	0.00	30.45	30.45	19.97	19.97	19.97	24.24	24.24
DGBE	0.00	0.00	0.00	13.84	13.84	22.00	22.00	22.00	10.23	10.23

For SAR measurement of the field distribution inside the phantom, the phantom must be filled with homogeneous tissue simulating liquid to a depth of at least 15 cm. For head SAR testing, the liquid depth from the ear reference point (ERP) of the phantom to the liquid top surface is larger than 15 cm.

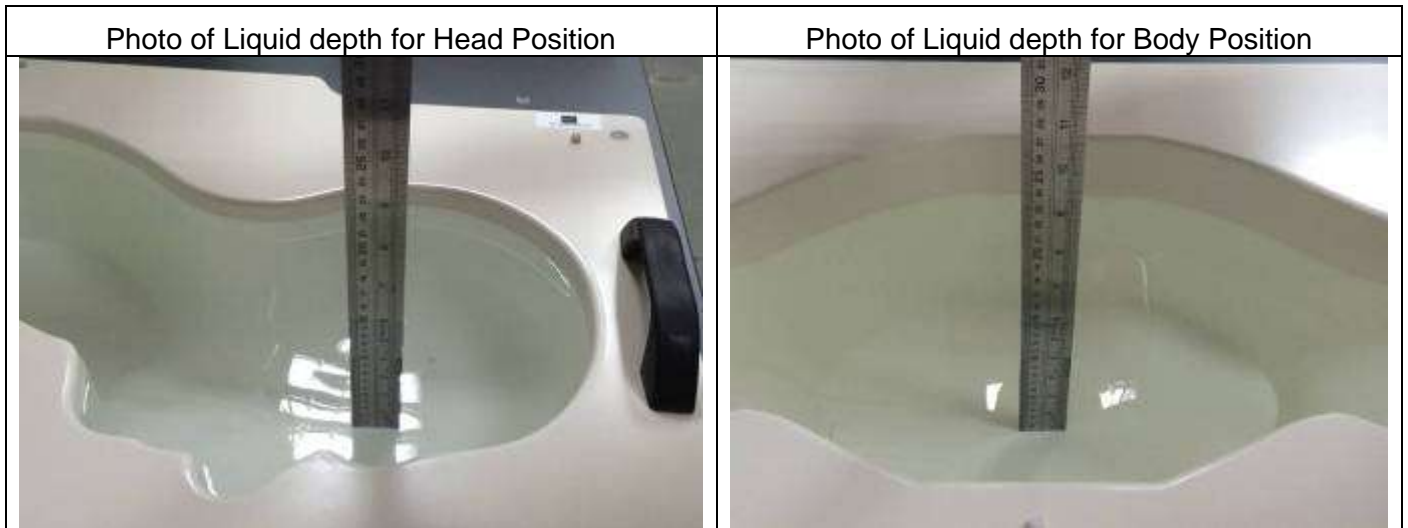

#### 4.1.1. Tissue Dielectric Parameter Check Results

The simulating liquids should be checked at the beginning of a series of SAR measurements to determine if the dielectric parameters are within the tolerances of the specified target values. The measured conductivity and relative permittivity should be within  $\pm 5\%$  of the target values.

Tissue Type	Measured Frequency (MHz)	Target Tissue		Measured Tissue		Liquid Temp.	Test Date
		$\epsilon_r$ ( $\pm 5\%$ )	$\sigma$ (S/m) ( $\pm 5\%$ )	$\epsilon_r$	$\sigma$ (S/m)		
Head 850	835	41.50 (39.43~43.58)	0.90 (0.86~0.95)	41.72	0.92	21.5 °C	Jan. 06, 2021
Head 1800	1800	40.00 (38.00~42.00)	1.40 (1.33~1.47)	39.50	1.42	21.4 °C	Jan. 07, 2021
Head 1900	1900	40.00 (38.00~42.00)	1.40 (1.33~1.47)	39.25	1.44	21.4 °C	Jan. 08, 2021
Head 2300	2300	39.47 (37.50~41.44)	1.66 (1.58~1.74)	39.88	1.72	21.7 °C	Jan. 12, 2021
Head 2450	2450	39.20 (37.24~41.16)	1.80 (1.71~1.89)	39.30	1.87	21.5 °C	Jan. 15, 2021
Head 2600	2600	39.01 (37.06~40.96)	1.96 (1.86~2.06)	38.85	2.03	21.4 °C	Jan. 16, 2021

NOTE: The dielectric parameters of the tissue-equivalent liquid should be measured under similar ambient conditions and within 2 °C of the conditions expected during the SAR evaluation to satisfy protocol requirements.

## 4.2. System Verification Procedure

The system verification is performed for verifying the accuracy of the complete measurement system and performance of the software. The dipole is connected to the signal source consisting of signal generator and amplifier via a directional coupler, N-connector cable and adaption to SMA. It is fed with a power of 100mW (below 5GHz) or 100mW (above 5GHz). To adjust this power a power meter is used. The power sensor is connected to the cable before the system verification to measure the power at this point and do adjustments at the signal generator. At the outputs of the directional coupler both return loss as well as forward power are controlled during the system verification to make sure that emitted power at the dipole is kept constant. This can also be checked by the power drift measurement after the test (result on plot).

The system verification is shown as below picture:

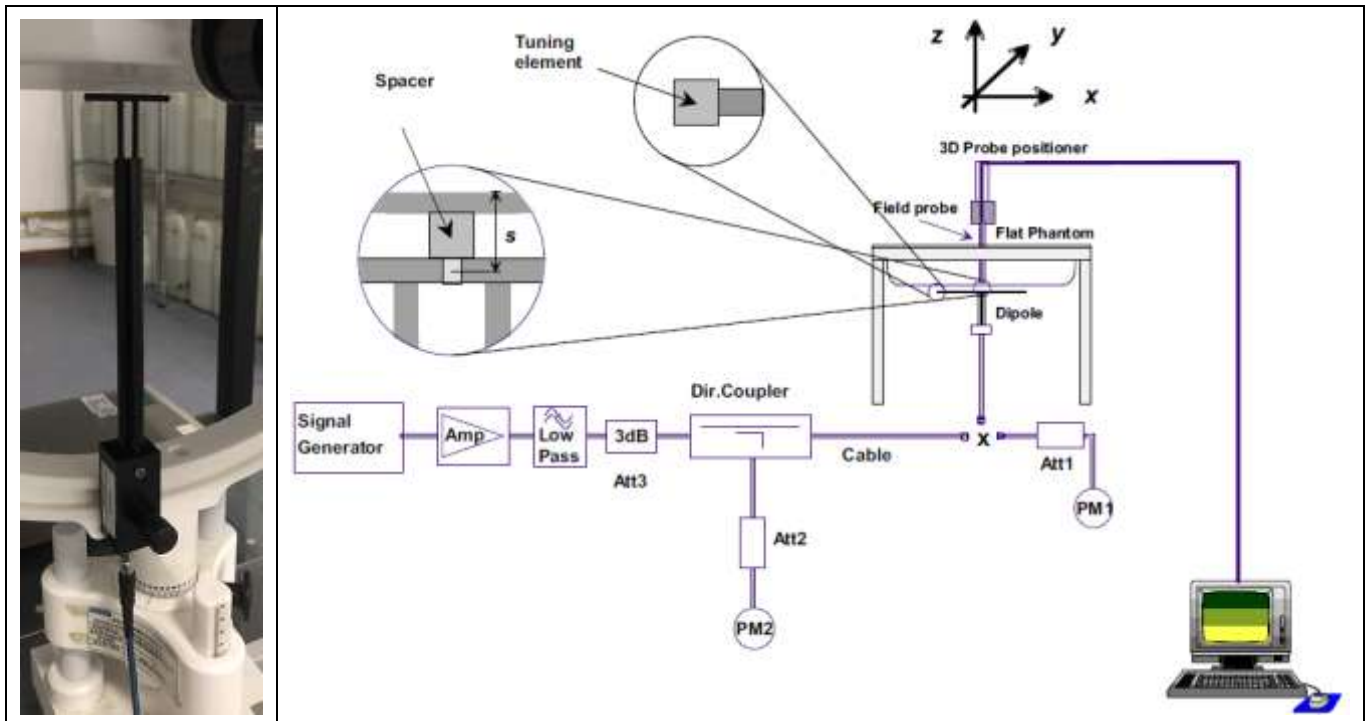

#### 4.2.1. System Verification Results

Comparing to the original SAR value provided by SATIMO, the verification data should be within its specification of  $\pm 10\%$ . Below table shows the target SAR and measured SAR after normalized to 1W input power. The table below indicates the system performance verification can meet the variation criterion and the plots can be referred to Appendix B of this report.

System Verification	Target SAR (1W) ( $\pm 10\%$ )		Measured SAR (Normalized to 1W)		Liquid Temp.	Test Date
	1-g (W/Kg)	10-g (W/Kg)	1-g (W/Kg)	10-g (W/Kg)		
835MHz Head	9.55 (8.60~10.51)	6.10 (5.49~6.71)	9.92	5.88	21.5 °C	Jan. 06, 2021
1800MHz Head	38.11 (34.30~41.92)	20.05 (18.05~22.06)	36.81	20.54	21.4 °C	Jan. 07, 2021
1900MHz Head	38.92 (35.03~42.81)	20.09 (18.08~22.10)	39.70	19.26	21.4 °C	Jan. 08, 2021
2300MHz Head	48.58 (43.72~53.44)	23.10 (20.79~25.41)	48.83	22.39	21.7 °C	Jan. 12, 2021
2450MHz Head	53.76 (48.38~59.14)	24.12 (21.71~26.53)	52.23	24.08	21.5 °C	Jan. 15, 2021
2600MHz Head	55.60 (50.04~61.16)	24.60 (22.14~27.06)	55.44	23.69	21.4 °C	Jan. 16, 2021



## **5. SAR Measurement variability and uncertainty**

### **5.1. SAR measurement variability**

Per KDB865664 D01 SAR measurement 100 MHz to 6 GHz, SAR measurement variability must be assessed for each frequency band, which is determined by the SAR probe calibration point and tissue-equivalent medium used for the device measurements. The additional measurements are repeated after the completion of all measurements requiring the same head or body tissue-equivalent medium in a frequency band. The test device should be returned to ambient conditions (normal room temperature) with the battery fully charged before it is re-mounted on the device holder for the repeated measurement(s) to minimize any unexpected variations in the repeated results.

- 1) Repeated measurement is not required when the original highest measured SAR is  $< 0.80$  W/kg; steps 2) through 4) do not apply.
- 2) When the original highest measured SAR is  $\geq 0.80$  W/kg, repeat that measurement once.
- 3) Perform a second repeated measurement only if the ratio of largest to smallest SAR for the original and first repeated measurements is  $> 1.20$  or when the original or repeated measurement is  $\geq 1.45$  W/kg (~ 10% from the 1-g SAR limit).
- 4) Perform a third repeated measurement only if the original, first or second repeated measurement is  $\geq 1.5$  W/kg and the ratio of largest to smallest SAR for the original, first and second repeated measurements is  $> 1.20$ .

### **5.2. SAR measurement uncertainty**

Per KDB865664 D01 SAR Measurement 100 MHz to 6 GHz, when the highest measured 1-g SAR within a frequency band is  $< 1.5$  W/kg, the extensive SAR measurement uncertainty analysis described in IEEE Std 1528-2013 is not required in SAR reports submitted for equipment approval. The equivalent ratio (1.5/1.6) is applied to extremity and occupational exposure conditions.

## 6. RF Exposure Positions

### 6.1. Body Worn Accessory

1. Body-worn operating configurations are tested with the belt-clips and holsters attached to the device and positioned against a flat phantom in a normal use configuration (see Figure 6.4.1). Per KDB 648474 D04, body-worn accessory exposure is typically related to voice mode operations when handsets are carried in body-worn accessories. The body-worn accessory procedures in FCC KDB 447498 D01 should be used to test for body-worn accessory SAR compliance, without a headset connected to it. This enables the test results for such configuration to be compatible with that required for hotspot mode when the body-worn accessory test separation distance is greater than or equal to that required for hotspot mode, when applicable. When the reported SAR for body-worn accessory, measured without a headset connected to the handset is  $< 1.2 \text{ W/kg}$ , the highest reported SAR configuration for that wireless mode and frequency band should be repeated for that body-worn accessory with a headset attached to the handset.
2. Accessories for body-worn operation configurations are divided into two categories: those that do not contain metallic components and those that do contain metallic components and those that do contain metallic components. When multiple accessories that do not contain metallic components are supplied with the device, the device is tested with only the accessory that dictates the closest spacing to the body. Then multiple accessories that contain metallic components are test with the device with each accessory. If multiple accessories share an identical metallic component (i.e. the same metallic belt-chip used with different holsters with no other metallic components) only the accessory that dictates the closest spacing to the body is tested.

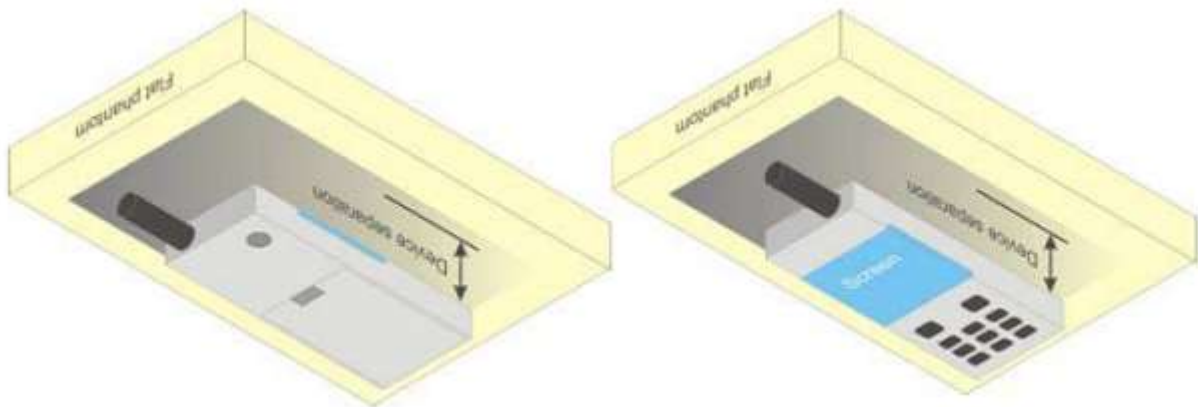

Figure 6.4.1 – Test positions for body-worn devices

## 6.2. Wireless Router Devices

Some battery-operated handsets have the capability to transmit and receive user through simultaneous transmission of WLAN simultaneously with a separate licensed transmitter. The FCC has provided guidance in FCC KDB Publication 941225 D06 where SAR test considerations for handsets ( $L \times W \geq 9 \text{ cm} \times 5 \text{ cm}$ ) are based on a composite test separation distance of 10mm from the front, back and edges of the device containing transmitting antennas within 2.5cm of their edges, determined from general mixed use conditions for this type of devices. Since the hotspot SAR results may overlap with the body-worn accessory SAR requirements, the more conservative configurations can be considered, thus excluding some body-worn accessory SAR tests.

When the user enables the personal wireless router functions for the handset, actual operations include simultaneous transmission of both the WLAN transmitter and another licensed transmitter. Both transmitters often do not transmit at the same transmitting frequency and thus cannot be evaluated for SAR under actual use conditions due to the limitations of the SAR assessment probes. Therefore, SAR must be evaluated for each frequency transmission and mode separately and spatially summed with the WLAN transmitter according to FCC KDB Publication 447498 D01 publication procedures. The "Portable Hotspot" feature on the handset was NOT activated during SAR assessments, to ensure the SAR measurements were evaluated for a single transmission frequency RF signal at a time.

## 7. RF Output Power

### 7.1. GSM Conducted Power

Band GSM850		Burst-Averaged output Power (dBm)			Frame-Averaged output Power (dBm)			
Tx Channel	Tune-up (dBm)	128	189	251	Tune-up	128	189	251
Frequency (MHz)		824.2	836.4	848.8	(dBm)	824.2	836.4	848.8
GSM (GMSK)	33.00	31.92	32.14	32.06	23.97	22.89	23.11	23.03
GPRS(GMSK, 1 TS)	33.00	31.87	32.11	32.02	23.97	22.84	23.08	22.99
GPRS(GMSK, 2 TS)	32.00	31.35	31.58	31.48	25.98	25.33	25.56	25.46
GPRS(GMSK, 3 TS)	31.00	29.84	30.06	29.93	26.74	25.58	25.80	25.67
GPRS(GMSK, 4 TS)	30.00	28.78	29.02	28.91	26.99	25.77	26.01	25.90
EDGE(GMSK, 1 TS)	27.00	25.91	26.54	25.81	17.97	16.88	17.51	16.78
EDGE(GMSK, 2 TS)	26.00	24.79	25.27	24.76	19.98	18.77	19.25	18.74
EDGE(GMSK, 3 TS)	24.00	22.41	22.60	23.04	19.74	18.15	18.34	18.78
EDGE(GMSK, 4 TS)	22.00	20.97	21.26	21.08	18.99	17.96	18.25	18.07
Band GSM1900		Burst-Averaged output Power (dBm)			Frame-Averaged output Power (dBm)			
Tx Channel	Tune-up (dBm)	512	661	810	Tune-up	512	661	810
Frequency (MHz)		1850.2	1880.0	1909.8	(dBm)	1850.2	1880.0	1909.8
GSM (GMSK)	29.50	28.86	28.99	29.16	20.47	19.83	19.96	20.13
GPRS(GMSK, 1 TS)	29.50	28.86	28.99	29.15	20.47	19.83	19.96	20.12
GPRS(GMSK, 2 TS)	28.50	28.10	28.19	28.35	22.48	22.08	22.17	22.33
GPRS(GMSK, 3 TS)	27.00	26.30	26.38	26.55	22.74	22.04	22.12	22.29
GPRS(GMSK, 4 TS)	25.50	25.20	25.31	25.48	22.49	22.19	22.30	22.47
EDGE(GMSK, 1 TS)	28.00	27.55	27.99	27.83	18.97	18.52	18.96	18.80
EDGE(GMSK, 2 TS)	27.50	26.58	26.61	27.01	21.48	20.56	20.59	20.99
EDGE(GMSK, 3 TS)	25.00	24.47	24.80	24.50	20.74	20.21	20.54	20.24
EDGE(GMSK, 4 TS)	23.50	22.79	23.21	22.86	20.49	19.78	20.20	19.85

Note: The frame-averaged power is linearly scaled the maximum burst averaged power over 8 time slots.

The calculated method are shown as below:

Frame-averaged power = Maximum burst averaged power (1 TS) - 9.03 dB

Frame-averaged power = Maximum burst averaged power (2 TS) - 6.02 dB

Frame-averaged power = Maximum burst averaged power (3 TS) - 4.26 dB

Frame-averaged power = Maximum burst averaged power (4 TS) - 3.01 dB

### 7.2. WCDMA Conducted Power

Band	WCDMA Band 2			
Tx Channel	Tune-up	9262	9400	9538
Frequency (MHz)		1852.4	1880	1907.6

RMC 12.2Kbps	25.00	25.00	24.90	23.22
HSDPA Subtest-1	23.50	23.28	22.21	22.09
HSDPA Subtest-2	22.00	21.75	20.96	20.39
HSDPA Subtest-3	21.00	20.60	19.65	19.40
HSDPA Subtest-4	20.50	20.47	19.81	19.21
HSUPA Subtest-1	22.50	22.14	21.60	20.81
HSUPA Subtest-2	23.00	22.54	21.75	21.04
HSUPA Subtest-3	21.00	20.72	20.37	19.83
HSUPA Subtest-4	23.00	22.94	22.15	21.02
HSUPA Subtest-5	21.50	21.27	20.88	20.26
Band	WCDMA Band 5			
Tx Channel	Tune-up	4132	4182	4233
Frequency (MHz)		826.4	836.4	846.6
RMC 12.2Kbps	23.00	22.84	22.88	22.86
HSDPA Subtest-1	22.00	21.84	21.53	21.48
HSDPA Subtest-2	21.50	21.27	21.20	21.13
HSDPA Subtest-3	20.50	20.38	20.27	19.67
HSDPA Subtest-4	20.50	19.92	20.23	19.63
HSUPA Subtest-1	21.50	21.09	21.35	21.28
HSUPA Subtest-2	22.00	21.80	21.50	21.40
HSUPA Subtest-3	20.50	20.32	20.47	20.27
HSUPA Subtest-4	22.00	21.85	21.56	21.48
HSUPA Subtest-5	21.00	20.69	20.94	20.86

### 7.3. LTE Conducted Power

Band	Band Width	Modulation	RB Configuration		Tune-up	Channel/Frequency(MHz)		
			RB Size	RB Offset		18607/1850.7	18900/1880	19193/1909.3
LTE Band 2	1.4MHz	QPSK	1	0	23.50	22.88	23.00	23.04
			1	2	23.50	22.92	23.00	23.02
			1	5	23.50	22.87	22.97	23.03
			3	0	23.50	22.92	23.05	23.17
			3	1	23.50	22.93	23.04	23.18
			3	2	23.50	22.89	23.00	23.16
		16QAM	6	0	22.50	21.84	22.00	22.12
			1	0	22.50	21.80	22.21	22.34
			1	2	22.50	21.82	22.19	22.34
			1	5	22.50	21.79	22.18	22.38
			3	0	22.50	21.99	22.21	22.26
			3	1	22.50	22.01	22.20	22.27
			3	2	22.50	22.00	22.13	22.28
			6	0	21.50	20.98	21.24	21.26
Band	Band Width	Modulation	RB Configuration		Tune-up	Channel/Frequency(MHz)		
			RB Size	RB Offset		18615/1851.5	18900/1880	19185/1908.5
LTE Band 2	3MHz	QPSK	1	0	23.50	22.86	23.00	23.10
			1	7	23.50	22.84	23.01	23.17
			1	14	23.50	22.82	22.98	23.14
			8	0	22.50	21.84	22.01	22.09
			8	4	22.50	21.82	22.03	22.09
			8	7	22.50	21.84	22.00	22.09
			15	0	22.50	21.84	21.98	22.11
		16QAM	1	0	22.50	22.36	22.29	22.07
			1	7	22.50	22.37	22.26	22.11
			1	14	22.50	22.34	22.25	22.05
			8	0	21.50	20.89	21.03	21.11
			8	4	21.50	20.89	21.01	21.10
			8	7	21.50	20.86	20.95	21.10
			15	0	21.50	20.86	20.90	21.15
Band	Band Width	Modulation	RB Configuration		Tune-up	Channel/Frequency(MHz)		



2			1	74	23.50	22.91	22.85	22.92			
			36	0	22.50	21.83	21.90	22.03			
			36	18	22.50	21.78	21.97	21.98			
			36	37	22.50	21.77	21.96	22.12			
			75	0	22.50	21.77	22.00	22.10			
		16QAM	1	0	22.50	22.10	22.13	22.09			
			1	37	22.50	22.11	22.26	22.12			
			1	74	22.50	22.04	22.08	22.17			
			36	0	21.50	20.88	20.96	20.99			
			36	18	21.50	20.89	21.02	20.93			
			36	37	21.50	20.83	21.00	21.09			
			75	0	21.00	20.76	20.89	20.97			
			Band	Band Width	Modulation	RB Configuration		Tune-up	Channel/Frequency(MHz)		
						RB Size	RB Offset		18700/1860	18900/1880	19100/1900
LTE Band 2	20MHz	QPSK	1	0	23.50	22.92	23.19	22.95			
			1	49	23.50	23.05	23.33	23.12			
			1	99	23.50	22.98	22.96	23.01			
			50	0	23.00	22.79	21.95	22.17			
			50	24	23.00	22.80	21.99	22.01			
			50	49	23.00	22.75	22.03	22.13			
			100	0	23.00	22.77	22.00	22.13			
		16QAM	1	0	23.00	22.77	22.32	22.15			
			1	49	23.00	22.69	22.45	22.27			
			1	99	23.00	22.79	22.32	22.14			
			50	0	22.00	21.79	20.97	21.08			
			50	24	22.00	21.81	21.01	21.01			
			50	49	22.00	21.75	21.02	21.08			
			100	0	22.00	21.75	20.95	21.09			

Band	Band Width	Modulation	RB Configuration		Tune-up	Channel/Frequency(MHz)		
			RB Size	RB Offset		19957/1710.7	20175/1732.5	20393/1754.3
LTE Band 4	1.4MHz	QPSK	1	0	23.00	22.80	22.77	22.88
			1	2	23.00	22.81	22.74	22.93
			1	5	23.00	22.79	22.79	22.85
			3	0	23.00	22.72	22.79	22.88
			3	1	23.00	22.73	22.78	22.87



		16QAM	3	2	23.00	22.69	22.75	22.87
			6	0	22.00	21.81	21.75	21.83
			1	0	22.50	22.05	21.71	22.01
			1	2	22.50	22.04	21.68	22.02
			1	5	22.50	22.07	21.66	21.98
			3	0	22.50	21.98	21.87	22.01
			3	1	22.50	22.03	21.86	22.02
			3	2	22.50	21.97	21.87	21.98
			6	0	21.00	20.93	20.84	20.98
Band	Band Width	Modulation	RB Configuration		Tune-up	Channel/Frequency(MHz)		
			RB Size	RB Offset		19965/1711.5	20175/1732.5	20385/1753.5
LTE Band 4	3MHz	QPSK	1	0	23.00	22.77	22.80	22.88
			1	7	23.00	22.84	22.82	22.92
			1	14	23.00	22.86	22.80	22.85
			8	0	22.00	21.79	21.68	21.82
			8	4	22.00	21.78	21.69	21.82
			8	7	22.00	21.78	21.70	21.83
			15	0	22.00	21.81	21.71	21.82
		16QAM	1	0	22.50	22.06	21.75	22.31
			1	7	22.50	22.07	21.71	22.37
			1	14	22.50	22.07	21.65	22.30
			8	0	21.00	20.78	20.71	20.86
			8	4	21.00	20.78	20.69	20.86
			8	7	21.00	20.79	20.68	20.85
			15	0	21.00	20.70	20.77	20.85
Band	Band Width	Modulation	RB Configuration		Tune-up	Channel/Frequency(MHz)		
			RB Size	RB Offset		19975/1712.5	20175/1732.5	20375/1752.5
LTE Band 4	5MHz	QPSK	1	0	23.00	22.96	22.75	22.93
			1	12	23.00	23.00	22.83	22.88
			1	24	23.00	22.94	22.79	22.92
			12	0	22.00	21.84	21.78	21.81
			12	6	22.00	21.82	21.75	21.85
			12	11	22.00	21.80	21.74	21.82
			25	0	22.00	21.83	21.75	21.85
		16QAM	1	0	22.50	22.36	22.21	22.19
			1	12	22.50	22.37	22.19	22.24

Band	Band Width	Modulation	RB Configuration		Tune-up	Channel/Frequency(MHz)		
			RB Size	RB Offset		20000/1715	20175/1732.5	20350/1750
			1	24	22.50	22.30	22.21	22.25
			12	0	21.00	20.81	20.68	20.81
			12	6	21.00	20.78	20.64	20.86
			12	11	21.00	20.75	20.64	20.82
			25	0	21.00	20.76	20.78	20.80
LTE Band 4	10MHz	QPSK	1	0	23.00	22.89	22.84	22.77
			1	24	23.00	22.96	22.85	22.80
			1	49	23.00	22.88	22.83	22.88
			25	0	22.00	21.79	21.82	21.70
			25	12	22.00	21.82	21.73	21.82
			25	24	22.00	21.81	21.75	21.85
			50	0	22.00	21.80	21.78	21.83
		16QAM	1	0	22.50	21.80	22.21	21.99
			1	24	22.50	21.80	22.25	22.02
			1	49	22.50	21.74	22.23	22.08
			25	0	21.00	20.77	20.82	20.71
			25	12	21.00	20.81	20.77	20.79
			25	24	21.00	20.78	20.78	20.85
			50	0	21.00	20.74	20.77	20.83
Band	Band Width	Modulation	RB Configuration		Tune-up	Channel/Frequency(MHz)		
			RB Size	RB Offset		20025/1717.5	20175/1732.5	20325/1747.5
LTE Band 4	15MHz	QPSK	1	0	23.00	22.87	22.67	22.70
			1	37	23.00	22.92	22.76	22.81
			1	74	23.00	22.79	22.66	22.74
			36	0	22.00	21.73	21.74	21.72
			36	18	22.00	21.76	21.71	21.76
			36	37	22.00	21.69	21.73	21.80
			75	0	22.00	21.74	21.80	21.83
		16QAM	1	0	22.50	22.00	21.93	21.85
			1	37	22.50	22.04	22.00	21.94
			1	74	22.50	21.92	21.91	21.92
			36	0	21.00	20.84	20.82	20.66
			36	18	21.00	20.84	20.77	20.72
			36	37	21.00	20.74	20.82	20.74

Band	Band Width	Modulation	RB Configuration		Tune-up	Channel/Frequency(MHz)		
			RB Size	RB Offset		20050/1720	20175/1732.5	20300/1745
			75	0		21.00	20.71	20.76
LTE Band 4	20MHz	QPSK	1	0	23.00	22.89	22.82	22.71
			1	49	23.00	22.78	23.00	22.83
			1	99	23.00	22.76	22.89	22.88
			50	0	22.00	21.98	21.92	21.66
			50	24	22.00	21.84	21.75	21.88
			50	49	22.00	21.68	21.83	21.90
			100	0	22.00	21.72	21.90	21.79
		16QAM	1	0	22.50	22.35	22.36	21.95
			1	49	22.50	22.25	22.47	22.08
			1	99	22.50	22.16	22.23	22.12
			50	0	22.00	21.78	21.90	20.65
			50	24	22.00	21.84	21.70	20.84
			50	49	22.00	21.59	21.77	20.87
			100	0	21.00	20.67	20.87	20.75

Band	Band Width	Modulation	RB Configuration		Tune-up	Channel/Frequency(MHz)		
			RB Size	RB Offset		20407/824.7	20525/836.5	20643/848.3
			75	0		21.00	20.71	20.76
LTE Band 5	1.4MHz	QPSK	1	0	23.00	22.56	22.86	22.87
			1	2	23.00	22.51	22.87	22.87
			1	5	23.00	22.47	22.87	22.82
			3	0	23.00	22.54	22.91	22.88
			3	1	23.00	22.50	22.89	22.88
			3	2	23.00	22.50	22.87	22.82
			6	0	22.00	21.45	21.87	21.85
		16QAM	1	0	22.50	21.78	21.80	22.02
			1	2	22.50	21.83	21.80	22.05
			1	5	22.50	21.84	21.80	22.04
			3	0	22.50	22.04	22.03	22.01
			3	1	22.50	22.04	22.01	22.02
			3	2	22.50	22.05	22.01	21.99
			6	0	21.50	21.03	21.03	21.01

Band	Band Width	Modulation	RB Configuration		Tune-up	Channel/Frequency(MHz)		
			RB Size	RB Offset		20425/826.5	20525/836.5	20625/846.5
LTE Band 5	3MHz	QPSK	1	0	23.00	20415/825.5	20525/836.5	20635/847.5
			1	7	23.00	22.87	22.88	22.86
			1	14	23.00	22.91	22.86	22.86
			8	0	22.00	22.89	22.89	22.87
			8	4	22.00	21.88	21.85	21.85
			8	7	22.00	21.86	21.87	21.85
			15	0	22.00	21.81	21.86	21.82
		16QAM	1	0	22.00	21.89	21.89	21.86
			1	7	22.50	22.29	22.07	21.79
			1	14	22.50	22.35	22.13	21.76
			8	0	21.00	22.29	22.07	21.75
			8	4	21.00	20.87	20.87	20.85
			8	7	21.00	20.88	20.88	20.83
			15	0	21.00	20.84	20.88	20.80
LTE Band 5	5MHz	QPSK	1	0	23.00	20425/826.5	20525/836.5	20625/846.5
			1	12	23.00	22.90	22.98	22.90
			1	24	23.00	22.84	22.95	22.90
			12	0	22.00	22.95	22.93	22.89
			12	6	22.00	21.91	21.92	21.91
			12	11	22.00	21.89	21.88	21.86
			25	0	22.00	21.82	21.86	21.84
		16QAM	1	0	22.00	21.87	21.89	21.86
			1	12	22.50	22.27	22.47	22.36
			1	24	22.50	22.26	22.43	22.31
			1	24	22.50	22.33	22.44	22.31
			12	0	21.00	20.89	20.91	20.80
			12	6	21.00	20.88	20.89	20.77
			12	11	21.00	20.81	20.86	20.75
LTE Band	10MHz	QPSK	1	0	23.00	20450/829	20525/836.5	20600/844
			1	24	23.00	22.92	22.97	22.88
			1	0	23.00	23.00	22.96	22.92
			1	24	23.00	23.00	22.96	22.92

5			1	49	23.00	23.00	22.93	22.90	
			25	0	22.00	21.94	21.93	21.90	
			25	12	22.00	21.95	21.89	21.87	
			25	24	22.00	21.92	21.93	21.83	
			50	0	22.00	21.95	21.97	21.92	
	16QAM			1	0	22.50	22.38	21.86	22.28
				1	24	22.50	22.48	21.82	22.30
				1	49	22.50	22.44	21.80	22.29
				25	0	21.00	20.94	20.93	20.92
				25	12	21.00	20.93	20.87	20.89
				25	24	21.00	20.93	20.92	20.85
				50	0	21.00	20.98	20.92	20.90

Band	Band Width	Modulation	RB Configuration		Tune-up	Channel/Frequency(MHz)		
			RB Size	RB Offset		20775/2502.5	21100/2535	21425/2567.5
LTE Band 7	5MHz	QPSK	1	0	24.00	23.33	23.51	23.78
			1	12	24.00	23.51	23.65	23.83
			1	24	24.00	23.56	23.62	23.73
			12	0	23.00	22.75	22.84	22.91
			12	6	23.00	22.71	22.86	22.88
			12	11	23.00	22.69	22.78	22.90
		16QAM	1	0	23.50	23.10	23.03	23.15
			1	12	23.50	23.13	23.13	23.14
			1	24	23.50	23.02	23.11	23.12
			12	0	22.00	21.69	21.87	21.91
			12	6	22.00	21.68	21.88	21.89
			12	11	22.00	21.65	21.82	21.87
			25	0	22.00	21.76	21.80	21.89

Band	Band Width	Modulation	RB Configuration		Tune-up	Channel/Frequency(MHz)		
			RB Size	RB Offset		20800/2505	21100/2535	21400/2565
LTE Band 7	10MHz	QPSK	1	0	24.00	23.84	23.85	23.78
			1	24	24.00	23.81	23.86	23.86
			1	49	24.00	23.75	23.77	23.85
			25	0	23.00	22.70	22.88	22.82
			25	12	23.00	22.76	22.86	22.82

Band	Band Width	Modulation	RB Configuration		Tune-up	Channel/Frequency(MHz)		
			RB Size	RB Offset		20825/2507.5	21100/2535	21375/2562.5
		16QAM	25	24	23.00	22.78	22.88	22.85
			50	0	23.00	22.78	22.91	22.90
			1	0	23.50	22.70	23.24	23.01
			1	24	23.50	22.66	23.28	23.04
			1	49	23.50	22.76	23.29	23.04
			25	0	22.00	21.72	21.87	21.86
			25	12	22.00	21.77	21.90	21.86
			25	24	22.00	21.77	21.90	21.88
			50	0	22.00	21.74	21.89	21.89
LTE Band 7	15MHz	QPSK	1	0	24.00	23.62	23.78	23.63
			1	37	24.00	23.71	23.85	23.77
			1	74	24.00	23.61	23.80	23.70
			36	0	23.00	22.66	22.81	22.79
			36	18	23.00	22.71	22.80	22.80
			36	37	23.00	22.70	22.76	22.87
			75	0	23.00	22.71	22.80	22.84
		16QAM	1	0	23.50	23.16	22.93	22.85
			1	37	23.50	23.21	22.98	23.04
			1	74	23.50	23.14	22.92	22.95
			36	0	22.00	21.70	21.87	21.76
			36	18	22.00	21.74	21.89	21.80
			36	37	22.00	21.75	21.85	21.82
			75	0	22.00	21.68	21.79	21.86
Band	Band Width	Modulation	RB Configuration		Tune-up	Channel/Frequency(MHz)		
			RB Size	RB Offset		20850/2510	21100/2535	21350/2560
LTE Band 7	20MHz	QPSK	1	0	24.00	23.62	23.70	23.85
			1	49	24.00	23.73	23.84	24.00
			1	99	24.00	23.66	23.75	23.97
			50	0	23.00	22.70	22.81	22.93
			50	24	23.00	22.77	22.89	22.94
			50	49	23.00	22.74	22.84	22.90
			100	0	23.00	22.71	22.83	22.90
		16QAM	1	0	23.50	23.14	22.94	23.05
			1	49	23.50	23.31	23.08	23.22

			1	99	23.50	23.22	23.07	23.15
			50	0	22.00	21.68	21.85	21.94
			50	24	22.00	21.80	21.84	21.94
			50	49	22.00	21.78	21.79	21.92
			100	0	22.00	21.67	21.80	21.90

Band	Band Width	Modulation	RB Configuration		Tune-up	Channel/Frequency(MHz)		
			RB Size	RB Offset		38725/2307.5	38750/2310	38775/2312.5
LTE Band 40A	5MHz	QPSK	1	0	22.50	22.26	22.17	22.10
			1	12	22.50	22.47	22.36	22.32
			1	24	22.50	22.20	22.10	22.05
			12	0	21.50	21.29	21.23	21.23
			12	6	21.50	21.29	21.26	21.25
			12	11	21.50	21.17	21.12	21.13
		16QAM	25	0	21.50	21.23	21.19	21.18
			1	0	22.50	21.91	21.52	21.50
			1	12	22.50	22.03	21.70	21.72
			1	24	22.50	21.83	21.45	21.44
			12	0	20.50	20.31	20.26	20.34
			12	6	20.50	20.39	20.29	20.36
			12	11	20.50	20.27	20.17	20.18
			25	0	20.50	20.30	20.32	20.23

Band	Band Width	Modulation	RB Configuration		Tune-up	Channel/Frequency(MHz)		
			RB Size	RB Offset		38750/2310		

LTE Band 40A	10MHz	QPSK	1	0	22.50	22.34
			1	24	22.50	22.48
			1	49	22.50	22.18
			25	0	21.50	21.35
			25	12	21.50	21.27
			25	24	21.50	21.11
			50	0	21.50	21.20
		16QAM	1	0	22.50	21.97
			1	24	22.50	22.06
			1	49	22.50	21.87
			25	0	21.50	21.49
			25	12	21.50	21.41

Band	Band Width	Modulation	RB Configuration		Tune-up	Channel/Frequency(MHz)		
			RB Size	RB Offset		39175/2352.5	39200/2355	39225/2357.5
			25	24	21.50	21.26		
			50	0	20.20	22.34		
LTE Band 40B	5MHz	QPSK	1	0	22.50	21.86	21.94	21.90
			1	12	22.50	22.10	22.16	22.10
			1	24	22.50	21.84	21.91	21.84
			12	0	21.50	20.89	20.88	20.91
			12	6	21.50	21.05	20.96	21.00
			12	11	21.50	20.91	20.93	20.95
			25	0	21.00	20.92	20.91	20.90
		16QAM	1	0	22.00	21.27	21.56	21.23
			1	12	22.00	21.47	21.81	21.47
			1	24	22.00	21.22	21.57	21.21
			12	0	20.50	20.02	19.99	19.95
			12	6	20.50	20.17	20.05	19.98
			12	11	20.50	20.04	20.06	19.95
			25	0	20.00	19.99	19.98	20.00
Band	Band Width	Modulation	RB Configuration		Tune-up	Channel/Frequency(MHz)		
			RB Size	RB Offset		39200/2355		
LTE Band 40B	10MHz	QPSK	1	0	22.50	22.00		
			1	24	22.50	22.18		
			1	49	22.50	21.93		
			25	0	21.50	20.94		
			25	12	21.50	21.00		
			25	24	21.50	21.02		
			50	0	21.00	20.99		
		16QAM	1	0	22.00	21.44		
			1	24	22.00	21.85		
			1	49	22.00	21.48		
			25	0	20.50	20.07		
			25	12	20.50	20.10		
			25	24	20.50	20.15		
			50	0	20.50	20.08		



Band	Band Width	Modulation	RB Configuration		Tune-up	Channel/Frequency(MHz)		
			RB Size	RB Offset		39675/2498.5	40620/2593	41565/2687.5
LTE Band 41	5MHz	QPSK	1	0	25.00	24.61	24.65	24.57
			1	12	25.00	24.68	24.66	24.64
			1	24	25.00	24.65	24.63	24.64
			12	0	25.00	24.55	24.80	24.65
			12	6	25.00	24.54	24.81	24.64
			12	11	25.00	24.54	24.75	24.63
			25	0	25.00	24.53	24.88	24.69
		16QAM	1	0	25.00	24.76	24.79	24.70
			1	12	25.00	24.67	24.64	24.63
			1	24	25.00	24.57	24.71	24.73
			12	0	25.00	24.60	24.69	24.71
			12	6	25.00	24.57	24.65	24.69
			12	11	25.00	24.57	24.70	24.69
			25	0	25.00	24.58	24.81	24.71
Band	Band Width	Modulation	RB Configuration		Tune-up	Channel/Frequency(MHz)		
			RB Size	RB Offset		39700/2501	40620/2593	41540/2685
LTE Band 41	10MHz	QPSK	1	0	25.00	24.49	24.61	24.66
			1	24	25.00	24.57	24.65	24.71
			1	49	25.00	24.61	24.64	24.70
			25	0	25.00	24.52	24.69	24.73
			25	12	25.00	24.57	24.64	24.76
			25	24	25.00	24.57	24.58	24.75
			50	0	25.00	24.64	24.85	24.74
		16QAM	1	0	25.00	24.53	24.29	24.60
			1	24	25.00	24.59	24.27	24.69
			1	49	25.00	24.59	24.29	24.67
			25	0	25.00	24.58	24.40	24.53
			25	12	25.00	24.60	24.37	24.55
			25	24	25.00	24.61	24.23	24.57
			50	0	25.00	24.62	24.27	24.49

Band	Band Width	Modulation	RB Configuration		Tune-up	Channel/Frequency(MHz)		
			RB Size	RB Offset		39725/2503.5	40620/2593	41515/2682.5
LTE Band 41	15MHz	QPSK	1	0	25.00	24.51	24.74	24.50
			1	37	25.00	24.64	24.74	24.57
			1	74	25.00	24.49	24.73	24.54
			36	0	25.00	24.49	24.62	24.65
			36	18	25.00	24.54	24.63	24.65
			36	37	25.00	24.57	24.66	24.64
			75	0	25.00	24.56	24.81	24.68
		16QAM	1	0	25.00	24.67	24.66	24.51
			1	37	25.00	24.77	24.65	24.66
			1	74	25.00	24.67	24.77	24.64
			36	0	25.00	24.63	24.61	24.76
			36	18	25.00	24.68	24.65	24.71
			36	37	25.00	24.69	24.70	24.65
			75	0	25.00	24.56	24.73	24.74
Band	Band Width	Modulation	RB Configuration		Tune-up	Channel/Frequency(MHz)		
			RB Size	RB Offset		39700/2501	40620/2593	41540/2685
LTE Band 41	20MHz	QPSK	1	0	25.00	24.54	24.63	24.58
			1	49	25.00	24.68	24.76	24.78
			1	99	25.00	24.60	24.68	24.65
			50	0	25.00	24.52	24.83	24.68
			50	24	25.00	24.62	24.93	24.72
			50	49	25.00	24.60	24.79	24.69
			100	0	25.00	24.57	24.81	24.70
		16QAM	1	0	25.00	24.68	24.91	24.87
			1	49	25.00	24.80	24.97	24.96
			1	99	25.00	24.72	24.88	24.91
			50	0	25.00	24.62	24.90	24.77
			50	24	25.00	24.66	24.91	24.78
			50	49	25.00	24.64	24.87	24.75
			100	0	25.00	24.59	24.83	24.72

#### 7.4. WLAN & Bluetooth Output Power

Mode	Channel	Frequency (MHz)	Tune-up	Output Power (dBm)
802.11b	1	2412	14.00	13.52
	6	2437	14.00	13.31
	11	2462	14.00	13.40
802.11g	1	2412	12.00	11.54
	6	2437	12.00	10.88
	11	2462	12.00	11.08
802.11n HT20	1	2412	12.00	11.70
	6	2437	12.00	11.24
	11	2462	12.00	11.36
802.11n HT40	3	2422	10.90	10.65
	6	2437	10.90	10.84
	9	2452	10.90	8.97

NOTE: Power measurement results of WLAN 2.4G.

Mode	Channel	Frequency (MHz)	Tune-up	Output Power (dBm)
802.11a	149	5745	8.000	7.400
	157	5785	8.000	7.639
	165	5825	8.000	7.380
802.11n HT20	149	5745	7.500	6.934
	157	5785	7.500	7.442
	165	5825	7.500	7.157
802.11n HT40	151	5755	8.000	7.337
	159	5795	8.000	7.839
802.11ac VHT20	149	5745	8.000	6.841
	157	5785	8.000	7.538
	165	5825	8.000	7.153
802.11ac VHT40	151	5755	8.000	7.321
	159	5795	8.000	7.850
802.11ac VHT80	155	5775	8.000	7.675

NOTE: Power measurement results of WLAN 5.8G.

BR+EDR	Output Power (dBm)				
	Channel	Tune-up	Data Rates		
			1M	2M	3M
	0CH	2.000	1.852	1.768	1.832
	39CH	0.000	-0.279	-0.745	-0.605

	78CH	2.000	1.606	1.183	1.333
--	------	-------	-------	-------	-------

	Channel	Tune-up	Output Power (dBm)
BLE	0CH	2.000	1.757
	19CH	0.000	-0.307
	39CH	2.000	1.420

NOTE: Power measurement results of Bluetooth.

### 8. Antenna Location

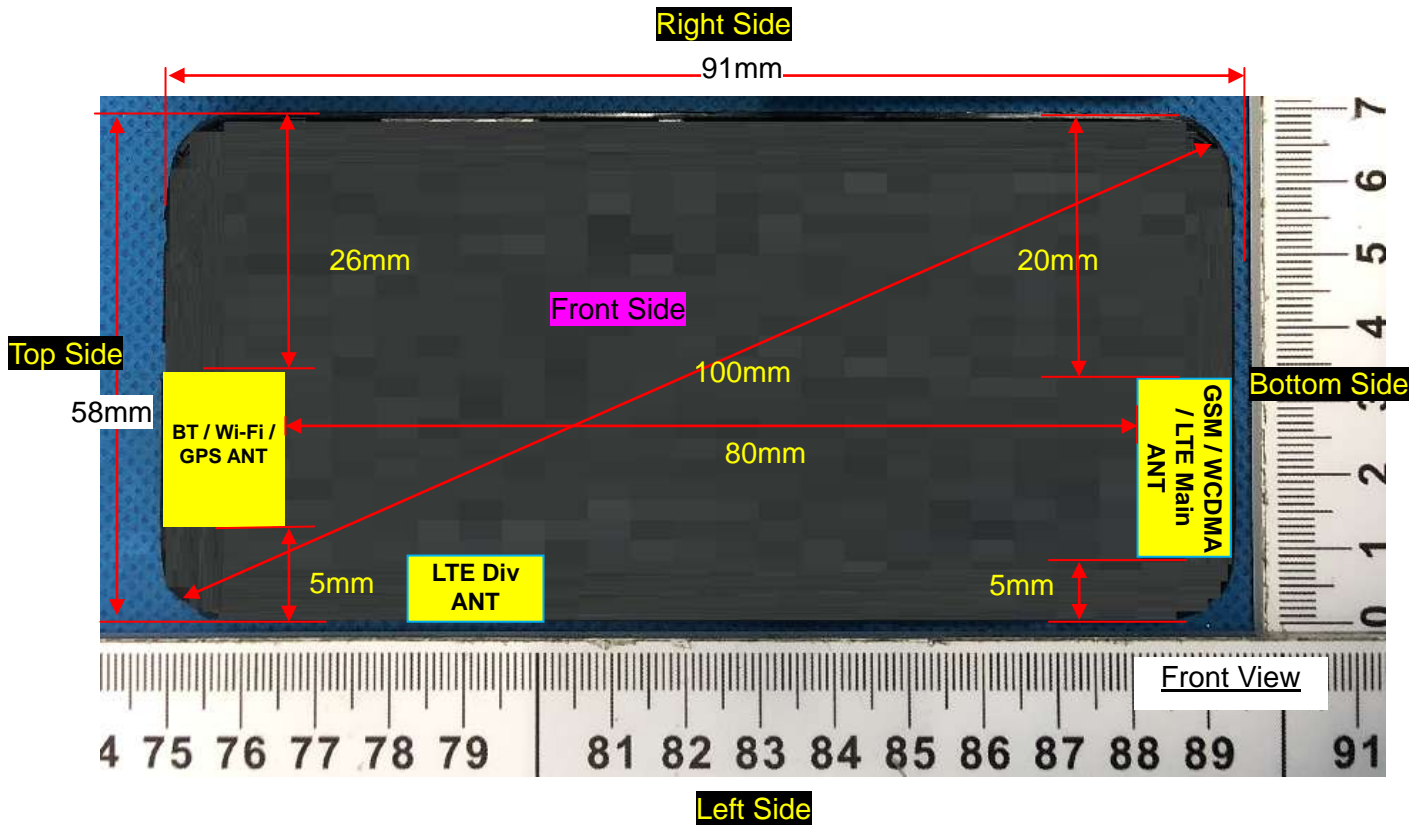

Note: Since the confidentiality request of EUT, the antenna location example diagram see as above.

Distance of the Antenna to the EUT surface/edge						
Antennas	Front Side	Back Side	Left Side	Right Side	Top Side	Bottom Side
WWAN Main	≤ 25mm	≤ 25mm	≤ 25mm	≤ 25mm	>25mm	≤ 25mm
WLAN & Bluetooth	≤ 25mm	≤ 25mm	≤ 25mm	>25mm	≤ 25mm	>25mm
Positions for SAR tests						
Antennas	Front Side	Back Side	Left Side	Right Side	Top Side	Bottom Side
WWAN Main	Yes	Yes	Yes	Yes	NO	Yes
WLAN & Bluetooth	Yes	Yes	Yes	NO	Yes	NO

## 9. Stand-alone SAR test exclusion

Refer to FCC KDB 447498D01, the 1-g SAR and 10-g SAR test exclusion thresholds for 100 MHz to 6 GHz at test separation distances  $\leq 50$  mm are determined by:

$[(\text{max. power of channel, including tune-up tolerance, mW})/(\text{min. test separation distance, mm})] \cdot [\sqrt{f_{(\text{GHz})}}] \leq 3.0$  for 1-g SAR and  $\leq 7.5$  for 10-g extremity SAR, where:

- $f_{(\text{GHz})}$  is the RF channel transmit frequency in GHz
- Power and distance are rounded to the nearest mW and mm before calculation
- The result is rounded to one decimal place for comparison

When the minimum test separation distance is  $< 5$  mm, a distance of 5 mm is applied to determine SAR test exclusion.

Mode	Pmax (dBm)	Pmax (mW)	Distance (mm)	f (GHz)	Calculation Result	SAR Exclusion threshold	SAR test exclusion
Bluetooth	2.00	1.58	10	2.480	0.25	3	Yes
WLAN 5.8G	8.00	6.31	10	5.825	1.52	3	YES

NOTE: Standalone SAR test exclusion for Bluetooth.

When standalone SAR test exclusion applies to an antenna that transmits simultaneously with other antennas, the standalone SAR must be estimated according to following to determine simultaneous transmission SAR test exclusion:

$[(\text{max. power of channel, including tune-up tolerance, mW})/(\text{min. test separation distance, mm})] \cdot [\sqrt{f_{(\text{GHz})}/x}] \text{ W/kg}$  for test separation distances  $\leq 50$ mm, where  $x = 7.5$  for 1-g SAR and  $x = 18.75$  for 10-g SAR.

When the minimum test separation distance is  $< 5$  mm, a distance of 5 mm is applied to determine SAR test exclusion.

Mode	Position	Pmax (dBm)	Pmax (mW)	Distance (mm)	f (GHz)	x	Estimated SAR (W/Kg)
Bluetooth	Body-Worn	2.00	1.58	10	2.48	7.5	0.033
WLAN 5.8G	Body-Worn	8.00	6.31	10	5.825	7.5	0.203

NOTE: Estimated SAR calculation for Bluetooth

## 10. SAR Results

### 10.1. SAR measurement Result

#### 10.1.1. SAR measurement Result of GSM850

Test Position of Body-Worn	Test channel /Freq.	Test Mode	SAR Value (W/kg)		Power Drift ( $\pm 5\%$ )	Conducted power (dBm)	Tune-up power (dBm)	Scaled SAR 1g	Date
			1g	10g					

with 10mm								(W/Kg)	
Front Side	189/836.4	GPRS(GMSK 4TS)	0.265	0.179	-1.88	29.02	30.00	0.332	2021/1/6
Back Side	189/836.4	GPRS(GMSK 4TS)	0.441	0.305	-0.11	29.02	30.00	0.553	2021/1/6
Left Side	189/836.4	GPRS(GMSK 4TS)	0.205	0.141	-0.78	29.02	30.00	0.257	2021/1/6
Right Side	189/836.4	GPRS(GMSK 4TS)	0.136	0.097	-0.22	29.02	30.00	0.170	2021/1/6
Bottom Side	189/836.4	GPRS(GMSK 4TS)	0.163	0.094	-0.25	29.02	30.00	0.204	2021/1/6

NOTE: Body-Worn SAR test results of GSM850

### 10.1.2. SAR measurement Result of GSM1900

Test Position of Body-Worn with 10mm	Test channel /Freq.	Test Mode	SAR Value (W/kg)		Power Drift (±5%)	Conducted power (dBm)	Tune-up power (dBm)	Scaled SAR 1g (W/Kg)	Date
			1g	10g					
Front Side	661/1880	GPRS(GMSK 3TS)	0.630	0.345	-1.96	26.38	27.00	0.727	2021/1/8
Back Side	661/1880	GPRS(GMSK 3TS)	0.227	0.130	-1.92	26.38	27.00	0.262	2021/1/8
Left Side	661/1880	GPRS(GMSK 3TS)	0.256	0.143	0.34	26.38	27.00	0.295	2021/1/8
Right Side	661/1880	GPRS(GMSK 3TS)	0.153	0.101	1.23	26.38	27.00	0.176	2021/1/8
Bottom Side	661/1880	GPRS(GMSK 3TS)	0.335	0.164	0.25	26.38	27.00	0.386	2021/1/8

NOTE: Body-Worn SAR test results of GSM1900

### 10.1.3. SAR measurement Result of WCDMA Band 2

Test Position of Body-Worn with 10mm	Test channel /Freq.	Test Mode	SAR Value (W/kg)		Power Drift (±5%)	Conducted power (dBm)	Tune-up power (dBm)	Scaled SAR 1g (W/Kg)	Date
			1g	10g					
Front Side	9400/1880	RMC12.2K	0.665	0.368	-3.28	24.90	25.00	0.680	2021/1/8
Back Side	9400/1880	RMC12.2K	0.303	0.173	-2.35	24.90	25.00	0.310	2021/1/8
Left Side	9400/1880	RMC12.2K	0.345	0.197	-3.20	24.90	25.00	0.353	2021/1/8
Right Side	9400/1880	RMC12.2K	0.134	0.083	-0.30	24.90	25.00	0.137	2021/1/8
Bottom Side	9400/1880	RMC12.2K	0.494	0.266	-1.31	24.90	25.00	0.506	2021/1/8

NOTE: Body-Worn SAR test results of WCDMA Band 2

### 10.1.4. SAR measurement Result of WCDMA Band 5

Test Position of Body-Worn with 10mm	Test channel /Freq.	Test Mode	SAR Value (W/kg)		Power Drift (±5%)	Conducted power (dBm)	Tune-up power (dBm)	Scaled SAR 1g (W/Kg)	Date
			1g	10g					
Front Side	4182/836.4	RMC12.2K	0.189	0.106	0.34	22.88	23.00	0.194	2021/1/6
Back Side	4182/836.4	RMC12.2K	0.346	0.246	-1.21	22.88	23.00	0.356	2021/1/6
Left Side	4182/836.4	RMC12.2K	0.164	0.089	1.48	22.88	23.00	0.169	2021/1/6
Right Side	4182/836.4	RMC12.2K	0.102	0.067	-2.22	22.88	23.00	0.105	2021/1/6
Bottom Side	4182/836.4	RMC12.2K	0.145	0.077	4.56	22.88	23.00	0.149	2021/1/6

NOTE: Body-Worn SAR test results of WCDMA Band 5

### 10.1.5. SAR measurement Result of LTE Band 2

Test Position of Body-Worn with 10mm	Test channel /Freq.	Test Mode	SAR Value (W/kg)		Power Drift (±5%)	Conducted power (dBm)	Tune-up power (dBm)	Scaled SAR 1g (W/Kg)	Date
			1g	10g					
1RB									
Front Side	18900/1880	20M QPSK(1,49)	0.641	0.358	-0.57	23.33	23.50	0.667	2021/1/8
Front Side	18900/1880	20M QPSK(1,49)	0.375	0.186	0.34	23.33	23.50	0.390	2021/1/8
Back Side	18900/1880	20M QPSK(1,49)	0.384	0.190	0.48	23.33	23.50	0.399	2021/1/8
Left Side	18900/1880	20M QPSK(1,49)	0.201	0.103	2.48	23.33	23.50	0.209	2021/1/8
Right Side	18900/1880	20M QPSK(1,49)	0.456	0.228	0.11	23.33	23.50	0.474	2021/1/8
50%RB									
Front Side	18900/1880	1.4M QPSK(3,1)	0.590	0.319	-2.05	23.04	23.50	0.656	2021/1/8
Back Side	18900/1880	1.4M QPSK(3,1)	0.326	0.169	-2.42	23.04	23.50	0.362	2021/1/8
Left Side	18900/1880	1.4M QPSK(3,1)	0.351	0.163	-2.71	23.04	23.50	0.390	2021/1/8
Right Side	18900/1880	1.4M	0.172	0.095	-4.43	23.04	23.50	0.191	2021/1/8



		QPSK(3,1)							
Bottom Side	18900/1880	1.4M QPSK(3,1)	0.394	0.211	-1.38	23.04	23.50	0.438	2021/1/8

NOTE: Body-Worn SAR test results of LTE Band 2

#### 10.1.6. SAR measurement Result of LTE Band 4

Test Position of Body-Worn with 10mm	Test channel /Freq.	Test Mode	SAR Value (W/kg)		Power Drift (±5%)	Conducted power (dBm)	Tune-up power (dBm)	Scaled SAR 1g (W/Kg)	Date
			1g	10g					
1RB									
Front Side	20175/1732.5	20M QPSK(1,49)	0.219	0.127	-2.24	23.00	23.00	0.219	2021/1/7
Back Side	20175/1732.5	20M QPSK(1,49)	0.114	0.073	1.24	23.00	23.00	0.114	2021/1/7
Left Side	20175/1732.5	20M QPSK(1,49)	0.125	0.080	0.61	23.00	23.00	0.125	2021/1/7
Right Side	20175/1732.5	20M QPSK(1,49)	0.098	0.063	1.25	23.00	23.00	0.098	2021/1/7
Bottom Side	20175/1732.5	20M QPSK(1,49)	0.156	0.101	0.77	23.00	23.00	0.156	2021/1/7
50%RB									
Front Side	20175/1732.5	1.4M QPSK(3,0)	0.202	0.120	2.01	22.79	23.00	0.212	2021/1/7
Back Side	20175/1732.5	1.4M QPSK(3,0)	0.101	0.065	-3.64	22.79	23.00	0.106	2021/1/7
Left Side	20175/1732.5	1.4M QPSK(3,0)	0.110	0.069	4.30	22.79	23.00	0.115	2021/1/7
Right Side	20175/1732.5	1.4M QPSK(3,0)	0.093	0.054	2.13	22.79	23.00	0.098	2021/1/7
Bottom Side	20175/1732.5	1.4M QPSK(3,0)	0.143	0.087	4.73	22.79	23.00	0.150	2021/1/7

NOTE: Body-Worn SAR test results of LTE Band 4

### 10.1.7. SAR measurement Result of LTE Band 5

Test Position of Body-Worn with 10mm	Test channel /Freq.	Test Mode	SAR Value (W/kg)		Power Drift ( $\pm 5\%$ )	Conducted power (dBm)	Tune-up power (dBm)	Scaled SAR 1g (W/Kg)	Date
			1g	10g					
1RB									
Front Side	20525/836.5	10M QPSK(1,24)	0.202	0.112	0.34	22.96	23.00	0.204	2021/1/6
Back Side	20525/836.5	10M QPSK(1,24)	0.428	0.303	0.62	22.96	23.00	0.432	2021/1/6
Left Side	20525/836.5	10M QPSK(1,24)	0.195	0.103	1.24	22.96	23.00	0.197	2021/1/6
Right Side	20525/836.5	10M QPSK(1,24)	0.128	0.086	3.31	22.96	23.00	0.129	2021/1/6
Bottom Side	20525/836.5	10M QPSK(1,24)	0.172	0.096	2.74	22.96	23.00	0.174	2021/1/6
50%RB									
Front Side	20525/836.5	1.4M QPSK(3,0)	0.173	0.103	0.86	22.91	23.00	0.177	2021/1/6
Back Side	20525/836.5	1.4M QPSK(3,0)	0.387	0.273	-0.67	22.91	23.00	0.395	2021/1/6
Left Side	20525/836.5	1.4M QPSK(3,0)	0.176	0.090	-0.54	22.91	23.00	0.180	2021/1/6
Right Side	20525/836.5	1.4M QPSK(3,0)	0.110	0.077	3.78	22.91	23.00	0.112	2021/1/6
Bottom Side	20525/836.5	1.4M QPSK(3,0)	0.148	0.082	-3.98	22.91	23.00	0.151	2021/1/6

NOTE: Body-Worn SAR test results of LTE Band 5

### 10.1.8. SAR measurement Result of LTE Band 7

Test Position of Body-Worn with 10mm	Test channel /Freq.	Test Mode	SAR Value (W/kg)		Power Drift ( $\pm 5\%$ )	Conducted power (dBm)	Tune-up power (dBm)	Scaled SAR 1g (W/Kg)	Date
			1g	10g					
1RB									
Front Side	21100/2535	20M QPSK(1,49)	0.201	0.103	0.24	23.84	24.00	0.209	2021/1/16
Back Side	21100/2535	20M	0.224	0.110	1.24	23.84	24.00	0.232	2021/1/16

		QPSK(1,49)							
Back Side Repeated	21100/2535	20M QPSK(1,49)	0.215	0.105	-2.31	23.84	24.00	0.223	2021/1/16
Back Side	20850/2510	20M QPSK(1,49)	0.102	0.059	1.26	23.84	24.00	0.106	2021/1/16
Back Side	21350/2560	20M QPSK(1,49)	0.538	0.261	-4.56	23.84	24.00	0.558	2021/1/16
50%RB									
Front Side	21100/2535	20M QPSK(50,24)	0.183	0.096	-4.87	22.89	23.00	0.188	2021/1/16
Back Side	21100/2535	20M QPSK(50,24)	0.209	0.099	-1.65	22.89	23.00	0.214	2021/1/16
Left Side	21100/2535	20M QPSK(50,24)	0.193	0.095	0.37	22.89	23.00	0.198	2021/1/16
Right Side	21100/2535	20M QPSK(50,24)	0.095	0.056	-4.22	22.89	23.00	0.097	2021/1/16
Bottom Side	21100/2535	20M QPSK(50,24)	0.485	0.235	-0.65	22.89	23.00	0.497	2021/1/16

NOTE: Body-Worn SAR test results of LTE Band 7

#### 10.1.9. SAR measurement Result of LTE Band 40A

Test Position of Body-Worn with 10mm	Test channel /Freq.	Test Mode	SAR Value (W/kg)		Power Drift (±5%)	Conducted power (dBm)	Tune-up power (dBm)	Scaled SAR 1g (W/Kg)	Date
			1g	10g					
1RB									
Front Side	38750/2310	10M QPSK(1,24)	0.090	0.056	0.24	22.48	22.50	0.090	2021/1/12
Back Side	38750/2310	10M QPSK(1,24)	0.110	0.065	1.37	22.48	22.50	0.111	2021/1/12
Left Side	38750/2310	10M QPSK(1,24)	0.096	0.058	2.37	22.48	22.50	0.096	2021/1/12
Right Side	38750/2310	10M QPSK(1,24)	0.035	0.028	3.22	22.48	22.50	0.035	2021/1/12
Bottom Side	38750/2310	10M QPSK(1,24)	0.140	0.079	0.99	22.48	22.50	0.141	2021/1/12
50%RB									
Front Side	38750/2310	10M QPSK(25,0)	0.078	0.049	-1.13	21.35	21.50	0.081	2021/1/12
Back Side	38750/2310	10M	0.097	0.059	-1.54	21.35	21.50	0.100	2021/1/12

		QPSK(25,0)							
Left Side	38750/2310	10M QPSK(25,0)	0.083	0.053	-1.06	21.35	21.50	0.086	2021/1/12
Right Side	38750/2310	10M QPSK(25,0)	0.032	0.025	0.78	21.35	21.50	0.033	2021/1/12
Bottom Side	38750/2310	10M QPSK(25,0)	0.131	0.069	0.78	21.35	21.50	0.136	2021/1/12

NOTE: Body-Worn SAR test results of LTE Band 40A

#### 10.1.10. SAR measurement Result of LTE Band 40B

Test Position of Body-Worn with 10mm	Test channel /Freq.	Test Mode	SAR Value (W/kg)		Power Drift (±5%)	Conducted power (dBm)	Tune-up power (dBm)	Scaled SAR 1g (W/Kg)	Date
			1g	10g					
1RB									
Front Side	39200/2355	10M QPSK(1,24)	0.120	0.075	1.24	22.18	22.50	0.129	2021/1/12
Back Side	39200/2355	10M QPSK(1,24)	0.135	0.080	0.38	22.18	22.50	0.145	2021/1/12
Left Side	39200/2355	10M QPSK(1,24)	0.125	0.077	2.41	22.18	22.50	0.135	2021/1/12
Right Side	39200/2355	10M QPSK(1,24)	0.045	0.032	1.34	22.18	22.50	0.048	2021/1/12
Bottom Side	39200/2355	10M QPSK(1,24)	0.192	0.090	4.24	22.18	22.50	0.207	2021/1/12
50%RB									
Front Side	39200/2355	10M QPSK(25,24)	0.108	0.066	0.35	21.02	21.50	0.121	2021/1/12
Back Side	39200/2355	10M QPSK(25,24)	0.120	0.074	-0.63	21.02	21.50	0.134	2021/1/12
Left Side	39200/2355	10M QPSK(25,24)	0.109	0.070	-2.69	21.02	21.50	0.122	2021/1/12
Right Side	39200/2355	10M QPSK(25,24)	0.043	0.029	-2.27	21.02	21.50	0.048	2021/1/12
Bottom Side	39200/2355	10M QPSK(25,24)	0.177	0.080	-0.71	21.02	21.50	0.198	2021/1/12

NOTE: Body-Worn SAR test results of LTE Band 40B

### 10.1.11. SAR measurement Result of LTE Band 41

Test Position of Body-Worn with 10mm	Test channel /Freq.	Test Mode	SAR Value (W/kg)		Power Drift (±5%)	Conducted power (dBm)	Tune-up power (dBm)	Scaled SAR 1g (W/Kg)	Date
			1g	10g					
1RB									
Front Side	40620/2593	20M QPSK(1,49)	0.096	0.054	1.54	24.76	25.00	0.101	2021/1/16
Back Side	40620/2593	20M QPSK(1,49)	0.125	0.096	2.24	24.76	25.00	0.132	2021/1/16
Left Side	40620/2593	20M QPSK(1,49)	0.104	0.088	2.14	24.76	25.00	0.110	2021/1/16
Right Side	40620/2593	20M QPSK(1,49)	0.055	0.034	-2.01	24.76	25.00	0.058	2021/1/16
Bottom Side	40620/2593	20M QPSK(1,49)	0.217	0.110	-0.59	24.76	25.00	0.229	2021/1/16
50%RB									
Front Side	40620/2593	20M QPSK(50,24)	0.086	0.048	-1.70	24.93	25.00	0.087	2021/1/16
Back Side	40620/2593	20M QPSK(50,24)	0.108	0.088	-1.32	24.93	25.00	0.110	2021/1/16
Left Side	40620/2593	20M QPSK(50,24)	0.091	0.081	4.57	24.93	25.00	0.092	2021/1/16
Right Side	40620/2593	20M QPSK(50,24)	0.052	0.032	1.27	24.93	25.00	0.053	2021/1/16
Bottom Side	40620/2593	20M QPSK(50,24)	0.193	0.101	4.91	24.93	25.00	0.196	2021/1/16

### 10.1.12. SAR measurement Result of WLAN 2.4G

Test Position of Body-Worn with 10mm	Test channel /Freq.	Test Mode	SAR Value (W/kg)		Power Drift (±5%)	Conducted power (dBm)	Tune-up power (dBm)	Scaled SAR 1g (W/Kg)	Date
			1g	10g					
Front Side	6/2437	802.11 b	0.046	0.037	0.34	13.31	14.00	0.054	2021/1/15
Back Side	6/2437	802.11 b	0.085	0.052	1.24	13.31	14.00	0.100	2021/1/15
Left Side	6/2437	802.11 b	0.060	0.045	-3.01	13.31	14.00	0.070	2021/1/15
Top Side	6/2437	802.11 b	0.093	0.057	2.05	13.31	14.00	0.109	2021/1/15

NOTE: Body-Worn SAR test results of WLAN 2.4G

## 10.2. Simultaneous Transmission Analysis

Per KDB 447498 D01, simultaneous transmission SAR is compliant if,

- 1) Scalar SAR summation < 1.6W/kg.
- 2) SPLSR =  $(SAR_1 + SAR_2)^{1.5} / (\text{min. separation distance, mm})$ , and the peak separation distance is determined from the square root of  $[(x_1-x_2)^2 + (y_1-y_2)^2 + (z_1-z_2)^2]$ , where  $(x_1, y_1, z_1)$  and  $(x_2, y_2, z_2)$  are the coordinates of the extrapolated peak SAR locations in the zoom scan. If  $SPLSR \leq 0.04$ , simultaneously transmission SAR measurement is not necessary.

Test Position		Scaled SAR <sub>MAX</sub>		Σ 1-g SAR (W/Kg)	SPLSR	Remark
		PCE	DTS			
Body-Worn	Front Side	0.727	0.054	0.781	N/A	N/A
	Back Side	0.553	0.100	0.653	N/A	N/A
	Left Side	0.399	0.070	0.469	N/A	N/A
	Right Side	0.209	N/A	0.209	N/A	N/A
	Top Side	N/A	0.109	0.109	N/A	N/A
	Bottom Side	0.558	N/A	0.558	N/A	N/A

Test Position		Scaled SAR <sub>MAX</sub>		Σ 1-g SAR (W/Kg)	SPLSR	Remark
		PCE	NII			
Body-Worn	Front Side	0.727	0.203	0.930	N/A	N/A
	Back Side	0.553	0.203	0.756	N/A	N/A
	Left Side	0.399	0.203	0.602	N/A	N/A
	Right Side	0.209	N/A	0.209	N/A	N/A
	Top Side	N/A	0.203	0.203	N/A	N/A
	Bottom Side	0.558	N/A	0.558	N/A	N/A

Test Position		Scaled SAR <sub>MAX</sub>		Σ 1-g SAR (W/Kg)	SPLSR	Remark
		PCE	DSS			
Body-Worn	Front Side	0.727	0.033	0.760	N/A	N/A
	Back Side	0.553	0.033	0.586	N/A	N/A
	Left Side	0.399	0.033	0.432	N/A	N/A
	Right Side	0.209	N/A	0.209	N/A	N/A
	Top Side	N/A	0.033	0.033	N/A	N/A
	Bottom Side	0.558	N/A	0.558	N/A	N/A

## 11. Appendix A. Photo documentation

Refer to appendix Test Setup photo---SAR

## 12. Appendix B. System Check Plots

Table of contents
<b>MEASUREMENT 1 System Performance Check - 850MHz</b>
<b>MEASUREMENT 2 System Performance Check - 1800MHz</b>
<b>MEASUREMENT 3 System Performance Check - 1900MHz</b>
<b>MEASUREMENT 4 System Performance Check - 2300MHz</b>
<b>MEASUREMENT 5 System Performance Check - 2450MHz</b>
<b>MEASUREMENT 6 System Performance Check - 2600MHz</b>

# MEASUREMENT 1

Date of measurement: 6/1/2021

## A. Experimental conditions.

<b>Area Scan</b>	<u>dx=15mm dy=15mm, h= 5.00 mm</u>
<b>ZoomScan</b>	<u>5x5x7, dx=8mm dy=8mm dz=5mm</u>
<b>Phantom</b>	<u>Validation plane</u>
<b>Device Position</b>	<u>Dipole</u>
<b>Band</b>	<u>CW835</u>
<b>Channels</b>	<u>Middle</u>
<b>Signal</b>	<u>CW (Crest factor: 1.0)</u>

## B. SAR Measurement Results

<b>Frequency (MHz)</b>	835.000000
<b>Relative permittivity (real part)</b>	41.723500
<b>Relative permittivity (imaginary part)</b>	19.741602
<b>Conductivity (S/m)</b>	0.920502
<b>Variation (%)</b>	1.870000

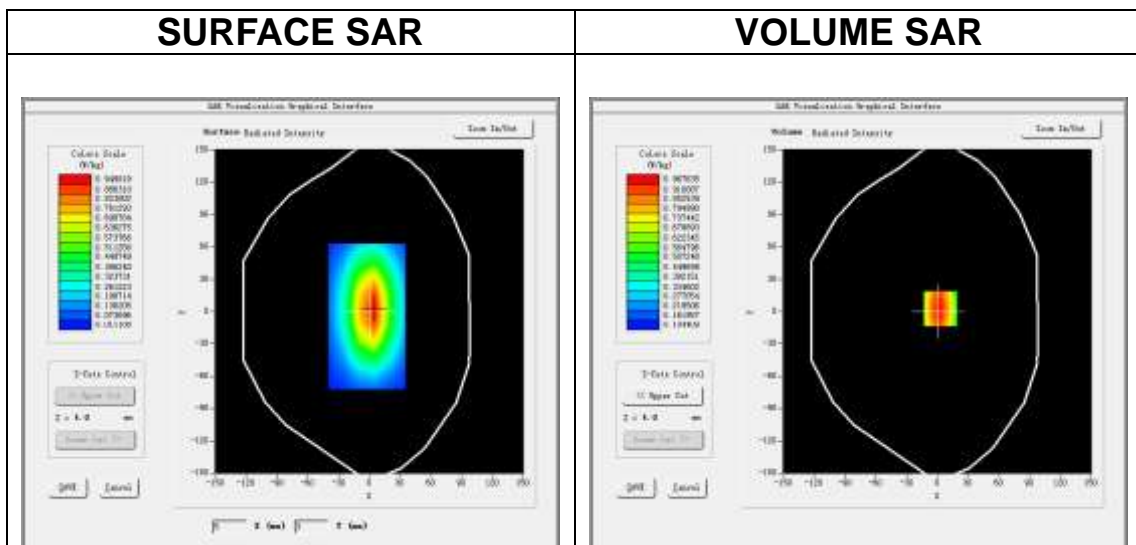

**Maximum location: X=3.00, Y=3.00**

**SAR Peak: 1.30 W/kg**

<b>SAR 10g (W/Kg)</b>	0.588433
<b>SAR 1g (W/Kg)</b>	0.992035



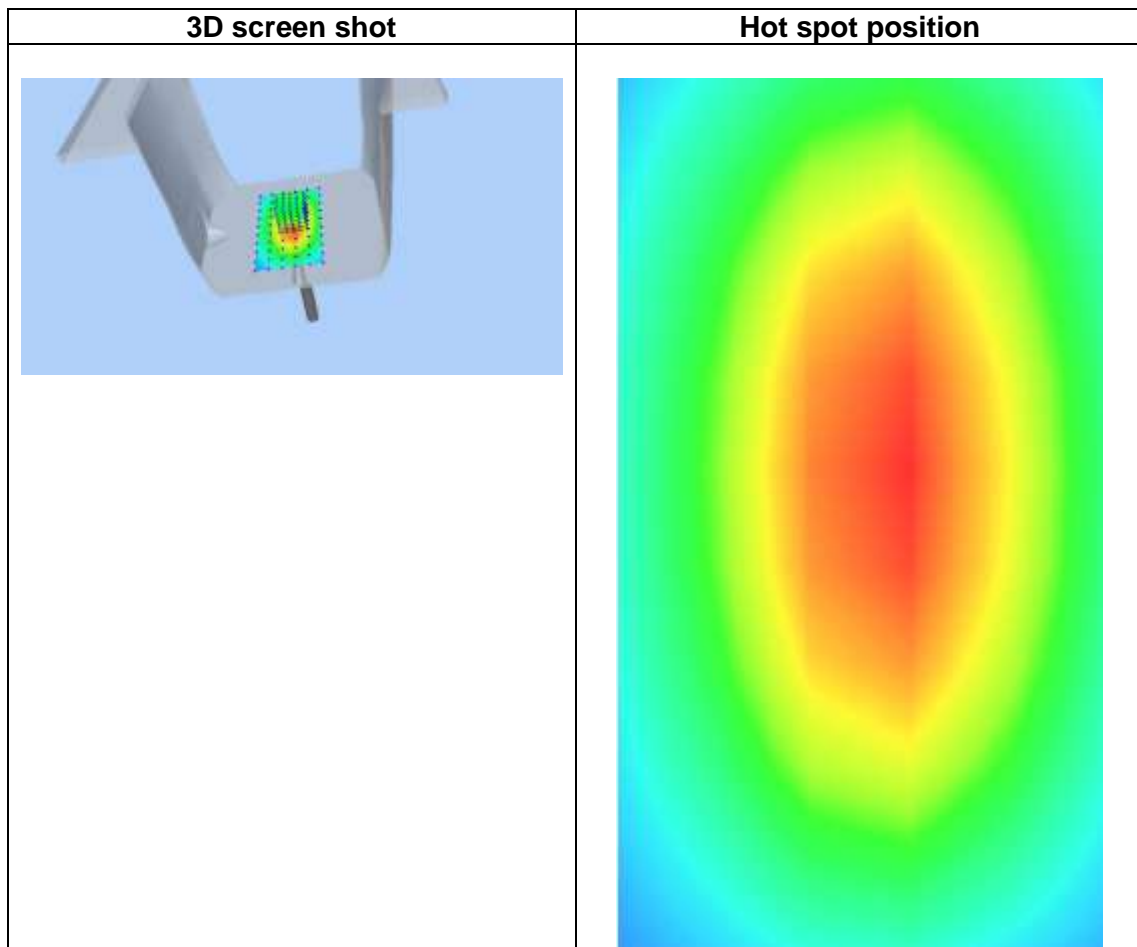
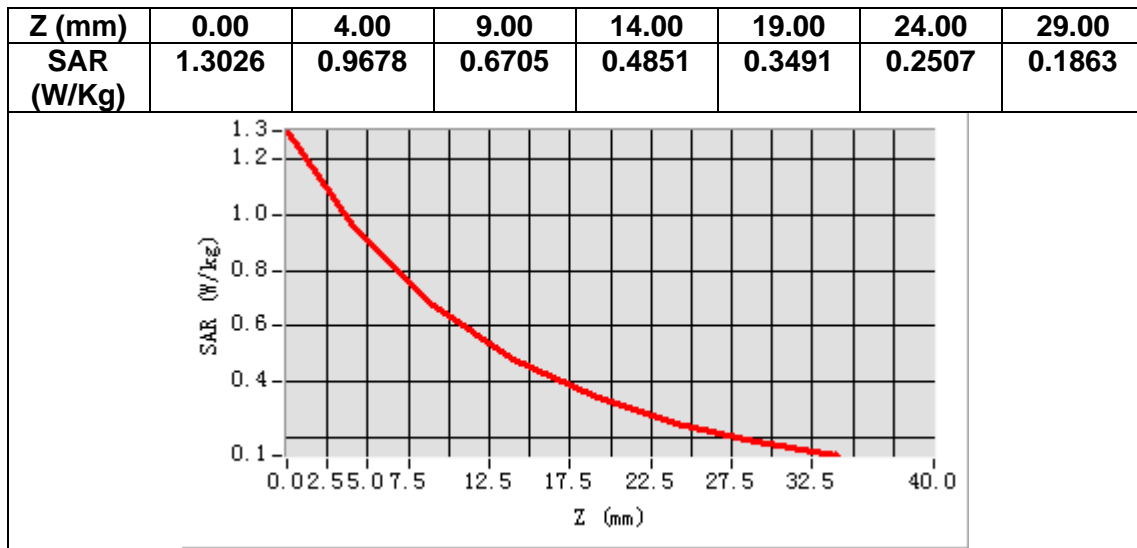

# MEASUREMENT 2

Date of measurement: 7/1/2021

## A. Experimental conditions.

<b>Area Scan</b>	<u>dx=15mm dy=15mm, h= 5.00 mm</u>
<b>ZoomScan</b>	<u>5x5x7, dx=8mm dy=8mm dz=5mm</u>
<b>Phantom</b>	<u>Validation plane</u>
<b>Device Position</b>	<u>Dipole</u>
<b>Band</b>	<u>CW1800</u>
<b>Channels</b>	<u>Middle</u>
<b>Signal</b>	<u>CW (Crest factor: 1.0)</u>

## B. SAR Measurement Results

<b>Frequency (MHz)</b>	1800.000000
<b>Relative permittivity (real part)</b>	39.502128
<b>Relative permittivity (imaginary part)</b>	14.232843
<b>Conductivity (S/m)</b>	1.422481
<b>Variation (%)</b>	-0.830000

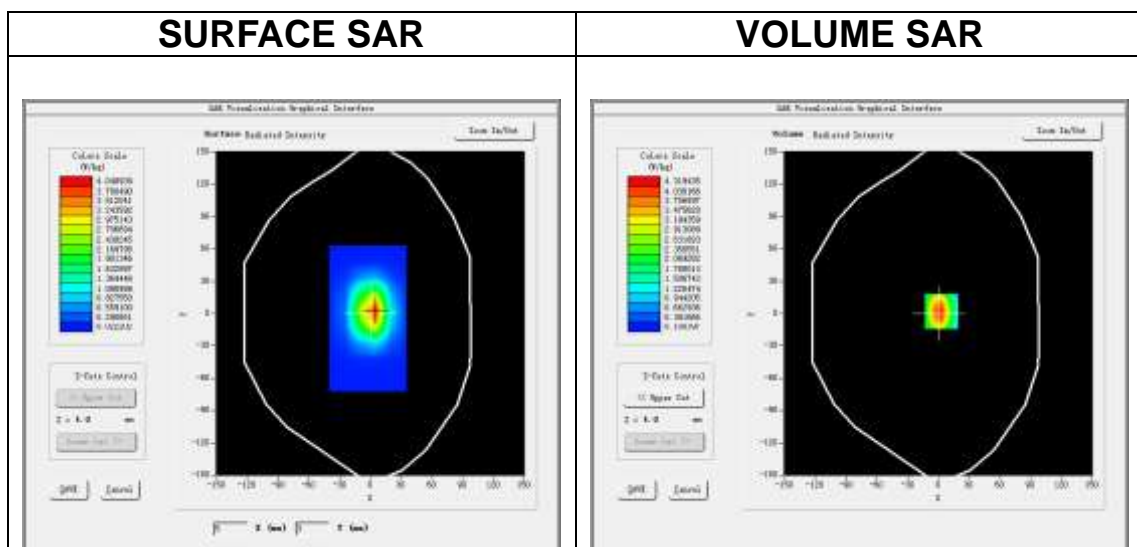

**Maximum location: X=3.00, Y=2.00**

**SAR Peak: 6.82 W/kg**

<b>SAR 10g (W/Kg)</b>	2.054241
<b>SAR 1g (W/Kg)</b>	3.681218

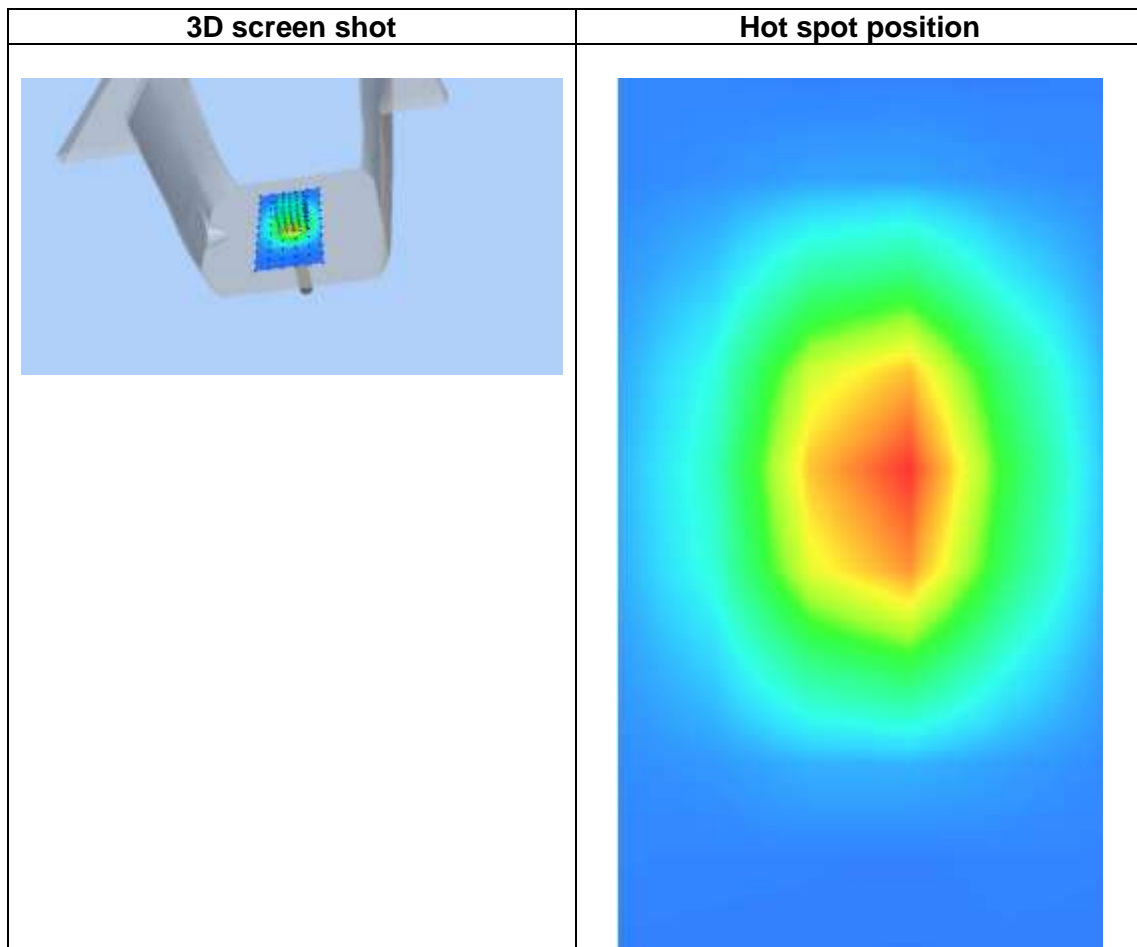
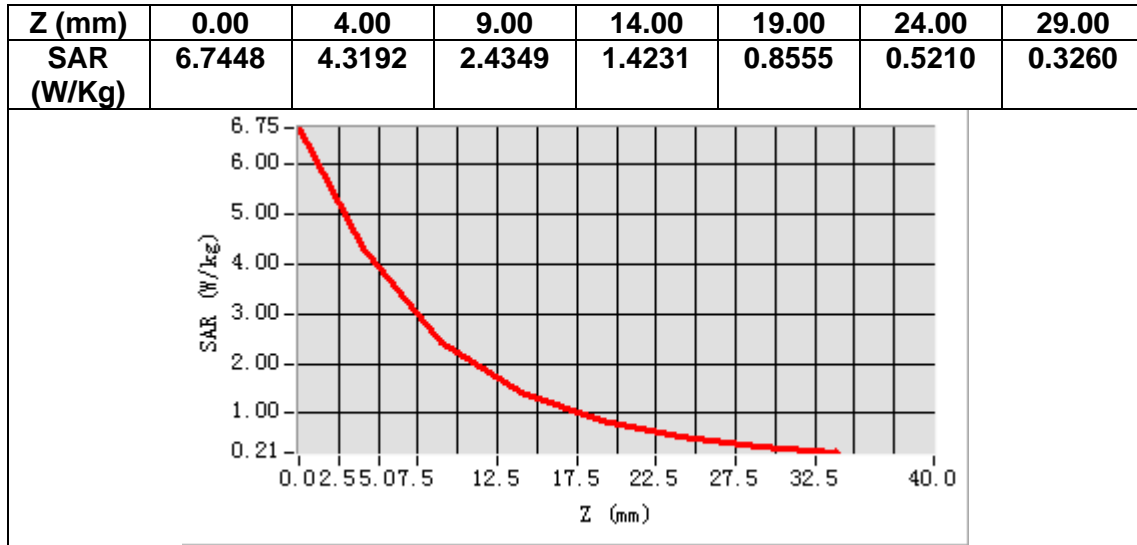

# MEASUREMENT 3

Date of measurement: 8/1/2021

## A. Experimental conditions.

<b>Area Scan</b>	<u>dx=15mm dy=15mm, h= 5.00 mm</u>
<b>ZoomScan</b>	<u>5x5x7, dx=8mm dy=8mm dz=5mm</u>
<b>Phantom</b>	<u>Validation plane</u>
<b>Device Position</b>	<u>Dipole</u>
<b>Band</b>	<u>CW1900</u>
<b>Channels</b>	<u>Middle</u>
<b>Signal</b>	<u>CW (Crest factor: 1.0)</u>

## B. SAR Measurement Results

<b>Frequency (MHz)</b>	1900.000000
<b>Relative permittivity (real part)</b>	39.251017
<b>Relative permittivity (imaginary part)</b>	13.653006
<b>Conductivity (S/m)</b>	1.440302
<b>Variation (%)</b>	-1.430000

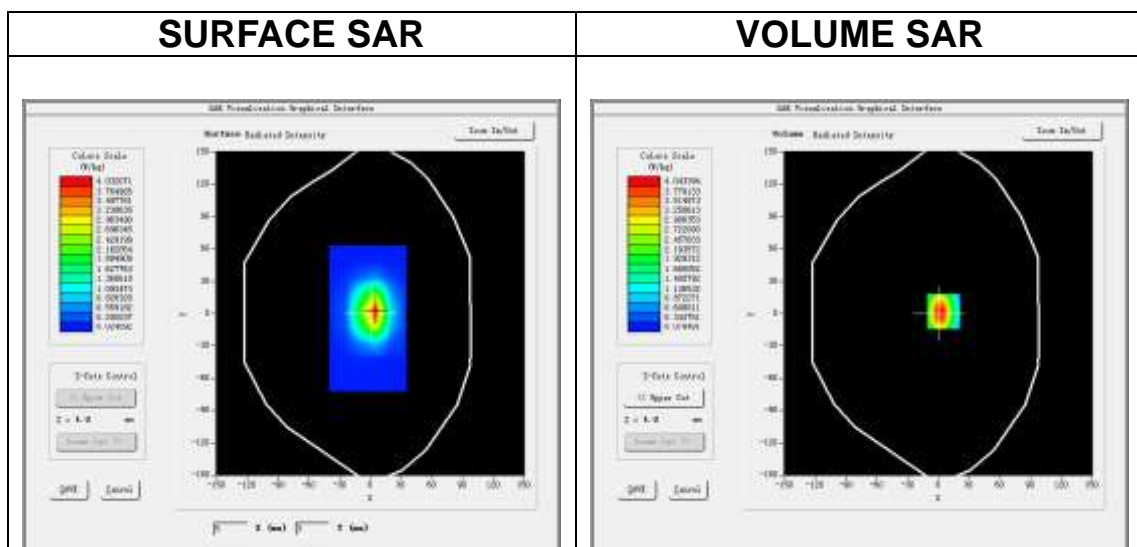

**Maximum location: X=5.00, Y=2.00**

**SAR Peak: 6.70 W/kg**

<b>SAR 10g (W/Kg)</b>	1.926452
<b>SAR 1g (W/Kg)</b>	3.970361

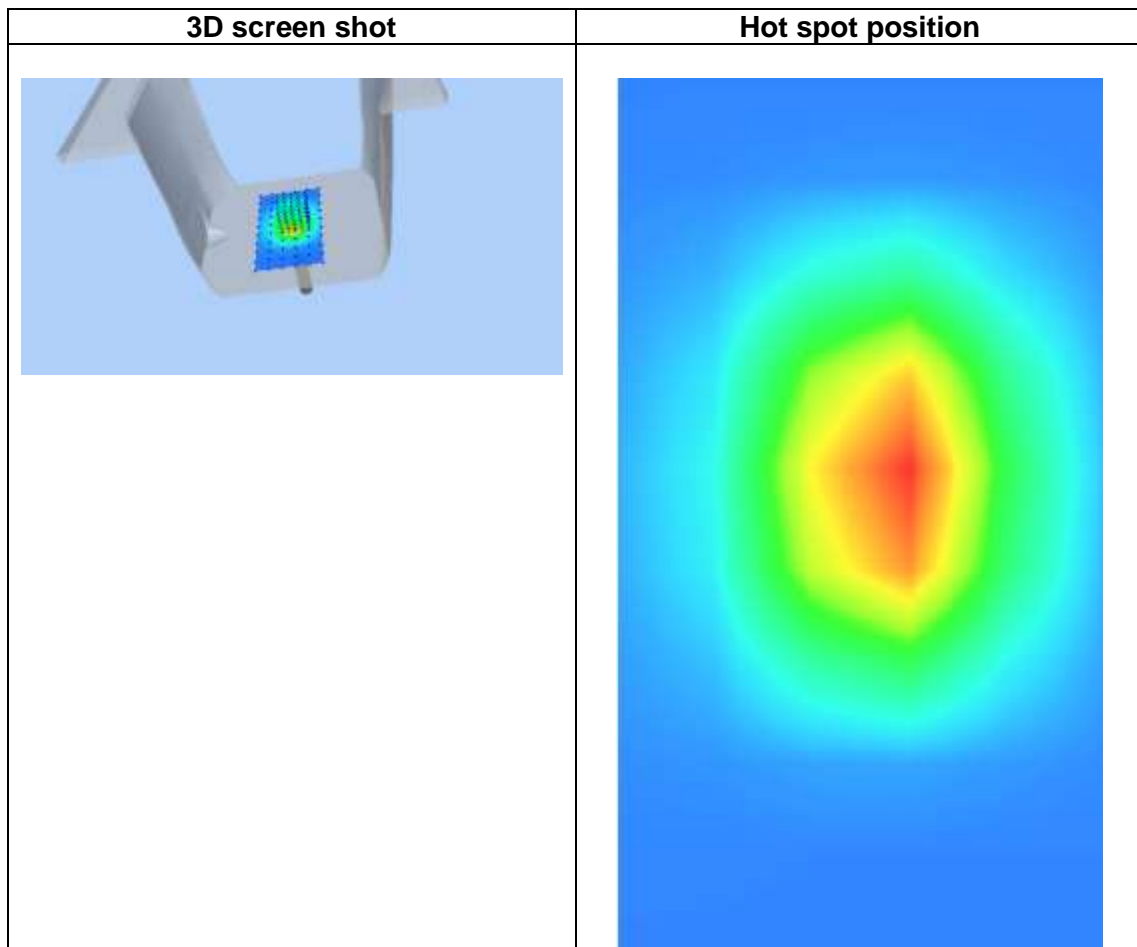
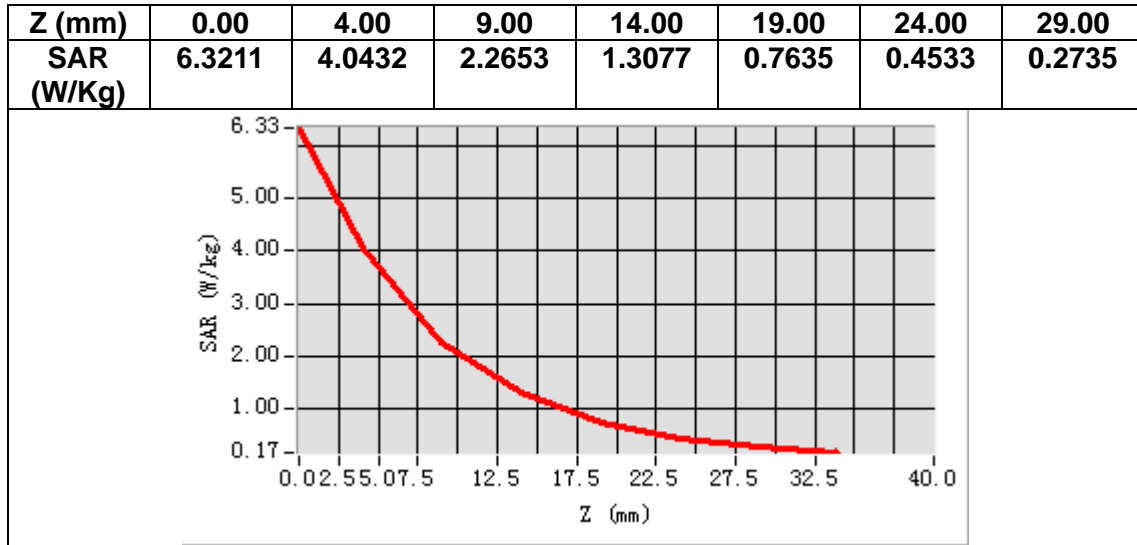

# MEASUREMENT 4

Date of measurement: 12/1/2021

## A. Experimental conditions.

<u>Area Scan</u>	<u>dx=12mm dy=12mm, h= 5.00 mm</u>
<u>ZoomScan</u>	<u>7x7x7,dx=5mm dy=5mm dz=5mm</u>
<u>Phantom</u>	<u>Validation plane</u>
<u>Device Position</u>	<u>Dipole</u>
<u>Band</u>	<u>CW2300</u>
<u>Channels</u>	<u>Middle</u>
<u>Signal</u>	<u>CW (Crest factor: 1.0)</u>

## B. SAR Measurement Results

Frequency (MHz)	2300.000000
Relative permittivity (real part)	39.882871
Relative permittivity (imaginary part)	13.491218
Conductivity (S/m)	1.723624
Variation (%)	-3.470000

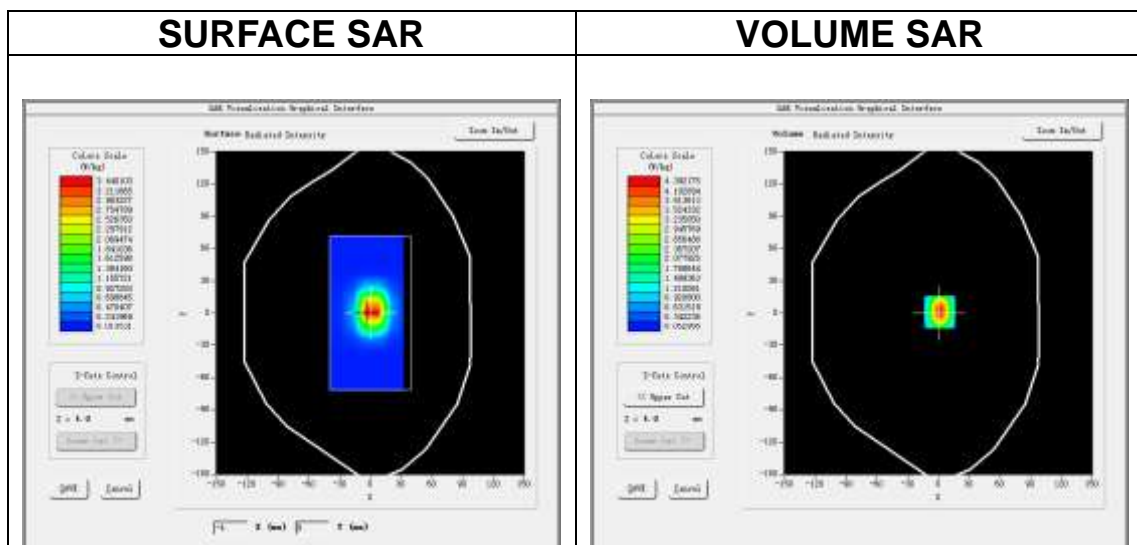

Maximum location: X=1.00, Y=1.00

SAR Peak: 7.04 W/kg

SAR 10g (W/Kg)	2.239453
SAR 1g (W/Kg)	4.883264

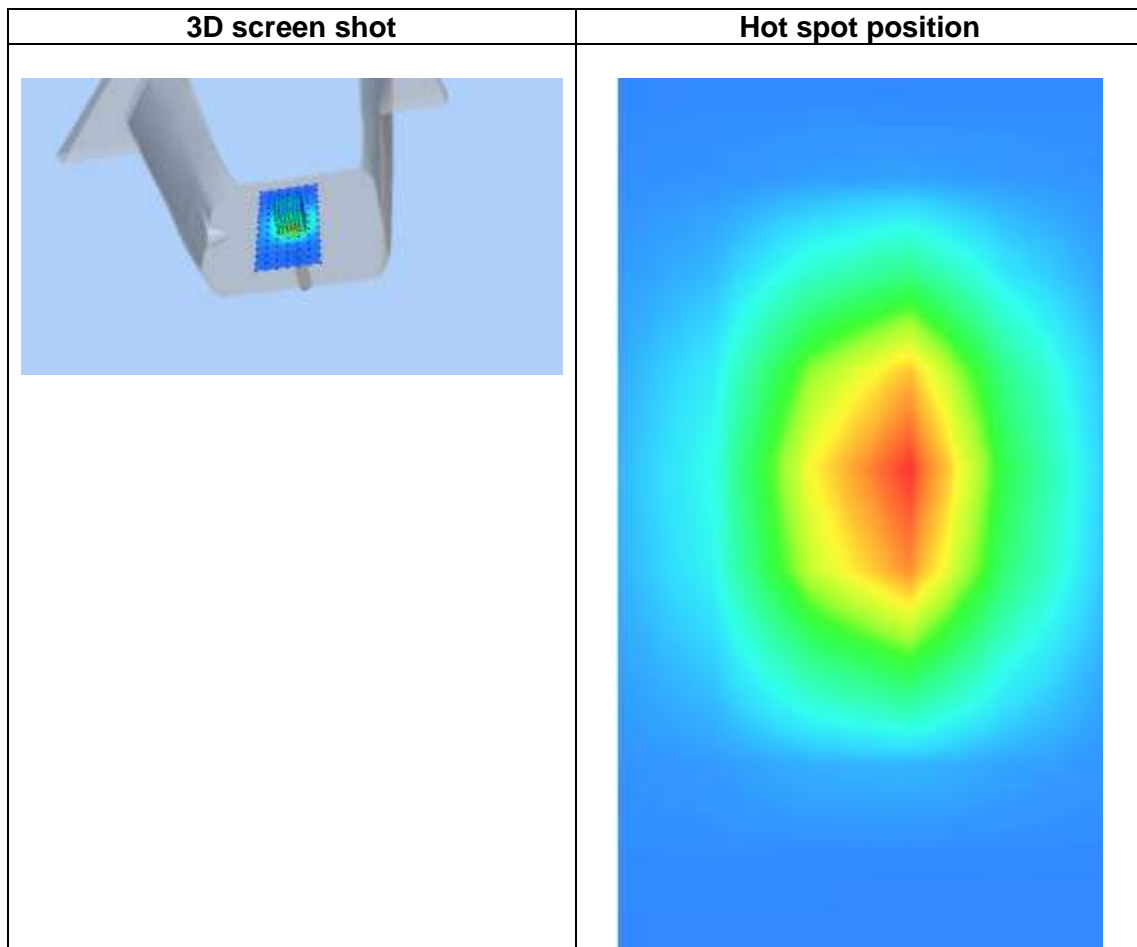
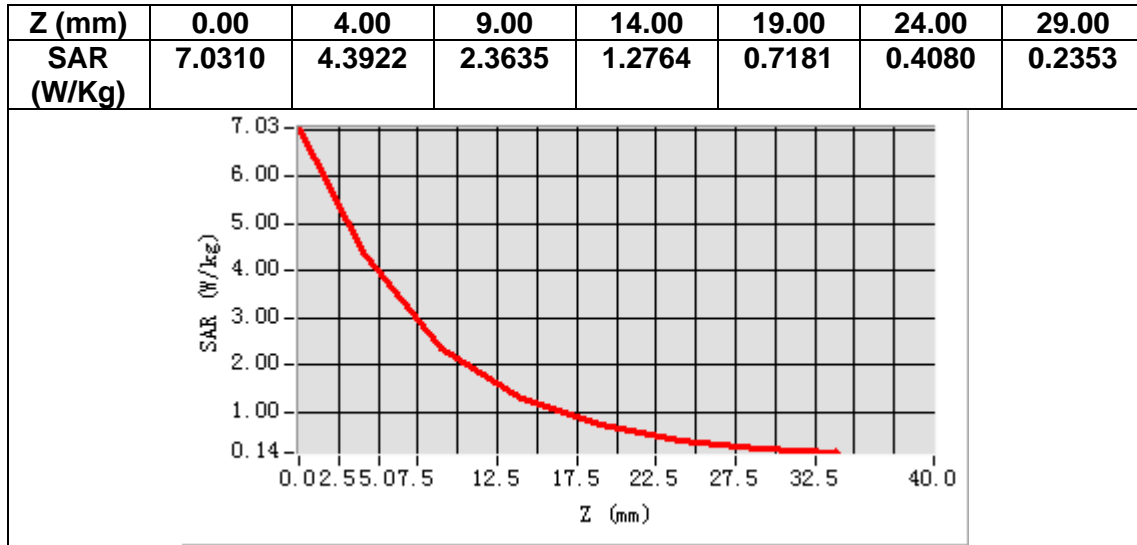

# MEASUREMENT 5

Date of measurement: 15/1/2021

## A. Experimental conditions.

<b>Area Scan</b>	<u>dx=12mm dy=12mm, h= 5.00 mm</u>
<b>ZoomScan</b>	<u>7x7x7, dx=5mm dy=5mm dz=5mm</u>
<b>Phantom</b>	<u>Validation plane</u>
<b>Device Position</b>	<u>Dipole</u>
<b>Band</b>	<u>CW2450</u>
<b>Channels</b>	<u>Middle</u>
<b>Signal</b>	<u>CW (Crest factor: 1.0)</u>

## B. SAR Measurement Results

<b>Frequency (MHz)</b>	2450.000000
<b>Relative permittivity (real part)</b>	39.302421
<b>Relative permittivity (imaginary part)</b>	13.732624
<b>Conductivity (S/m)</b>	1.872144
<b>Variation (%)</b>	1.300000

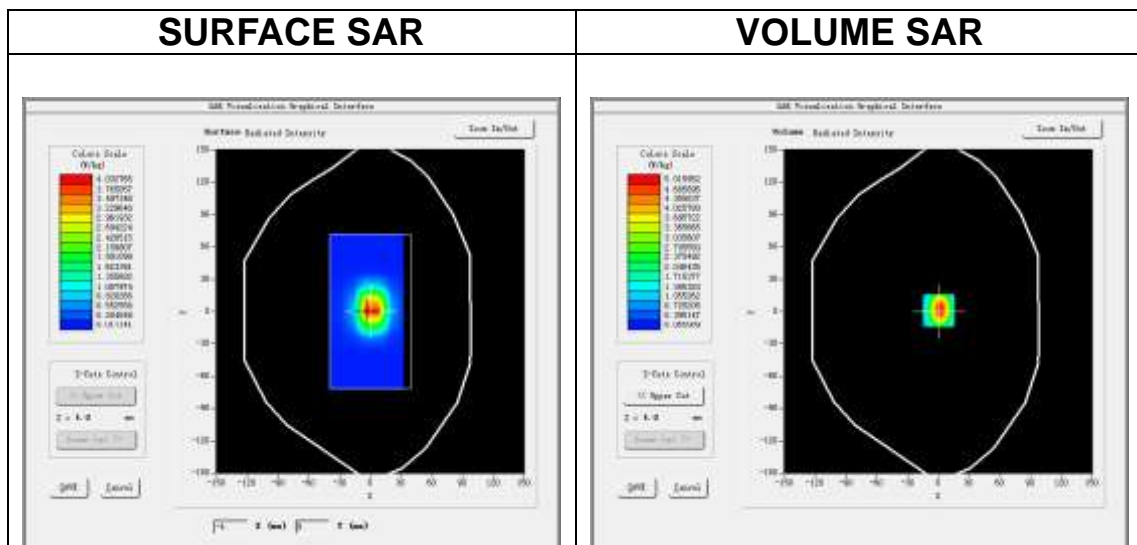

**Maximum location: X=0.00, Y=1.00**

**SAR Peak: 8.14 W/kg**

<b>SAR 10g (W/Kg)</b>	2.408250
<b>SAR 1g (W/Kg)</b>	5.223460



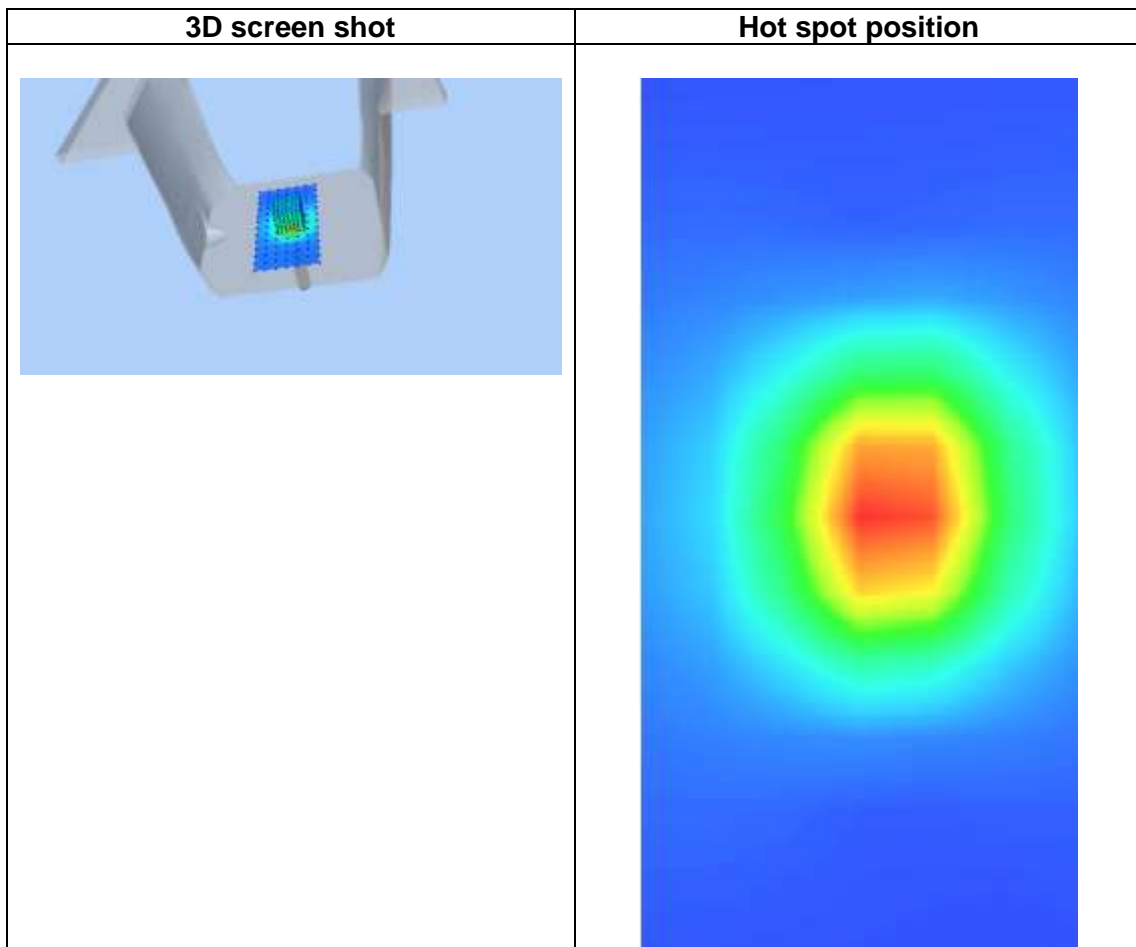
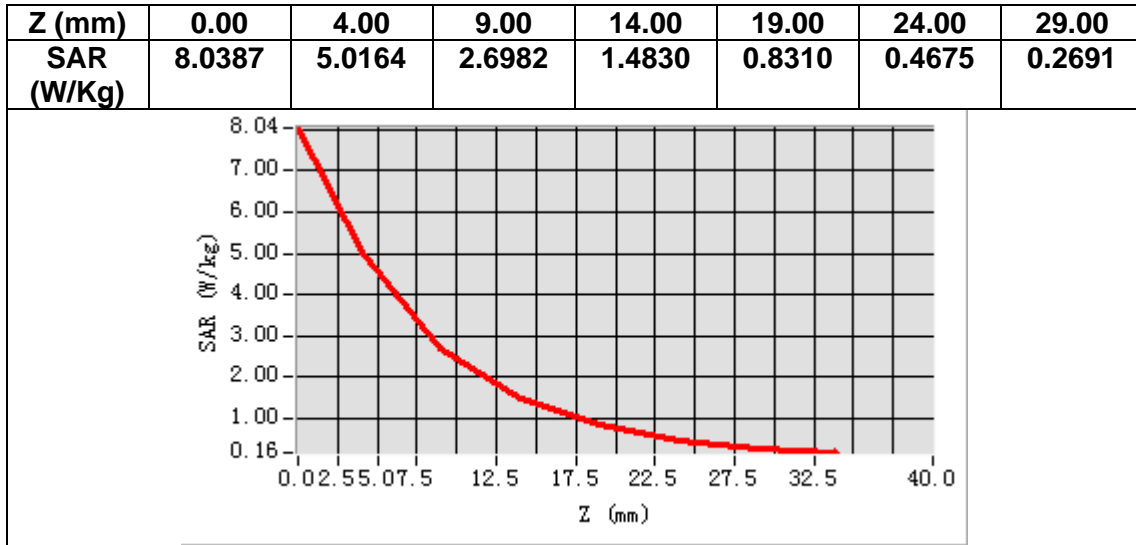

# MEASUREMENT 6

Date of measurement: 16/1/2021

## A. Experimental conditions.

<b>Area Scan</b>	<u>dx=12mm dy=12mm, h= 5.00 mm</u>
<b>ZoomScan</b>	<u>7x7x7, dx=5mm dy=5mm dz=5mm</u>
<b>Phantom</b>	<u>Validation plane</u>
<b>Device Position</b>	<u>Dipole</u>
<b>Band</b>	<u>CW2600</u>
<b>Channels</b>	<u>Middle</u>
<b>Signal</b>	<u>CW (Crest factor: 1.0)</u>

## B. SAR Measurement Results

<b>Frequency (MHz)</b>	2600.000000
<b>Relative permittivity (real part)</b>	38.852631
<b>Relative permittivity (imaginary part)</b>	14.050962
<b>Conductivity (S/m)</b>	2.033114
<b>Variation (%)</b>	1.940000

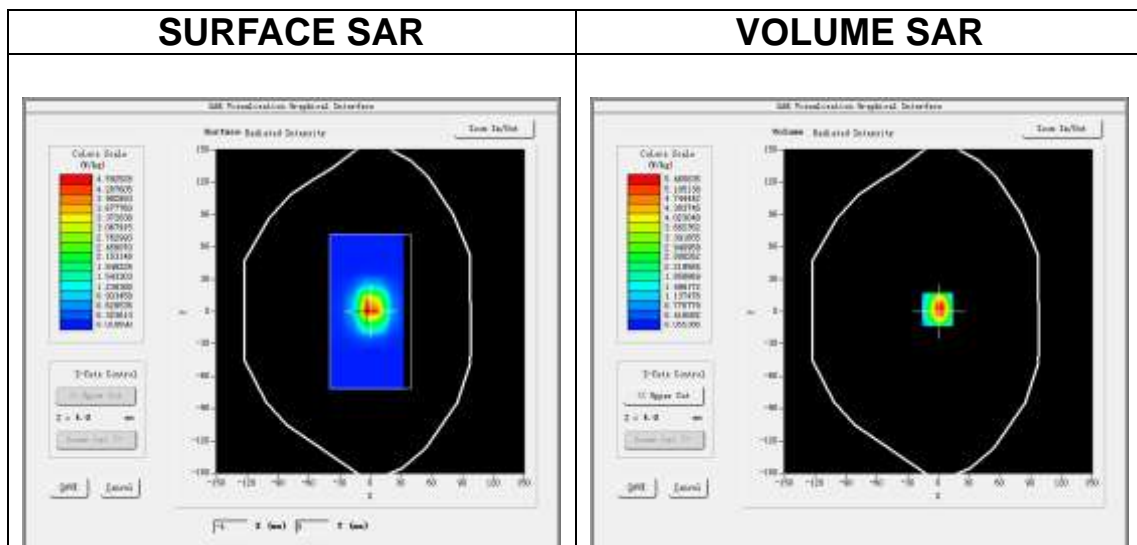

**Maximum location: X=-1.00, Y=2.00**

**SAR Peak: 9.07 W/kg**

<b>SAR 10g (W/Kg)</b>	2.369252
<b>SAR 1g (W/Kg)</b>	5.544083

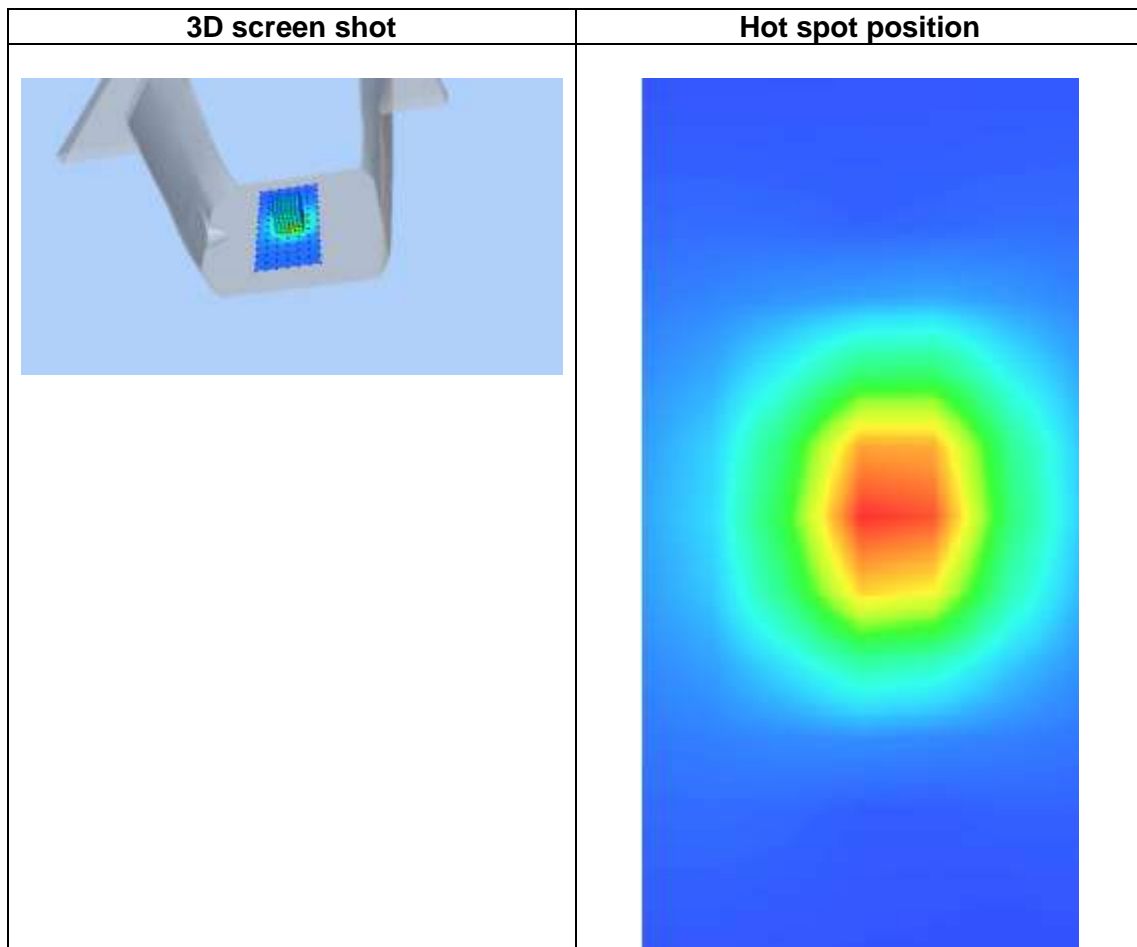
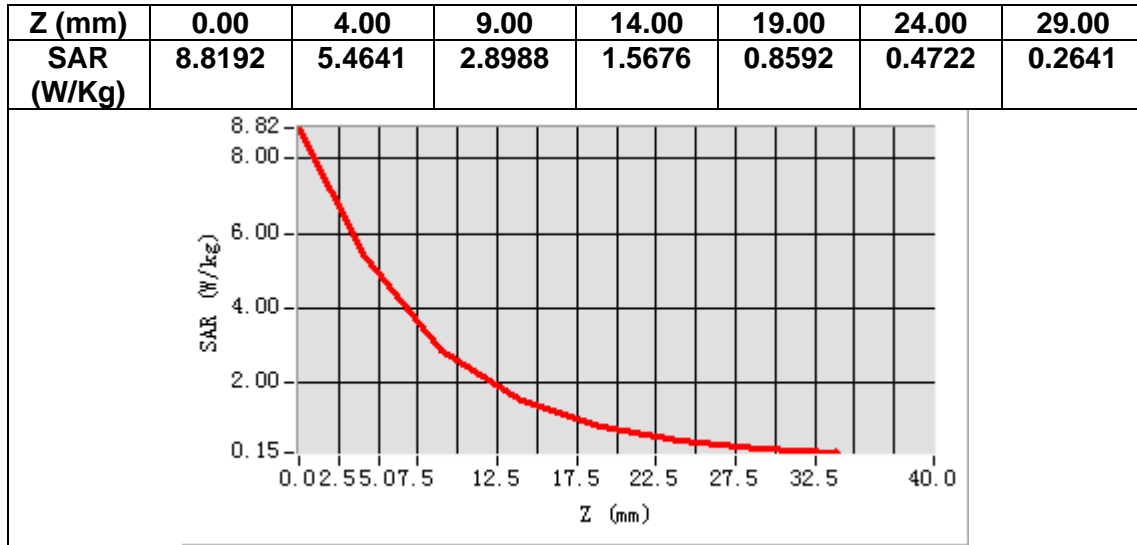

### 13. Appendix C. Plots of High SAR Measurement

Table of contents
MEASUREMENT 1 GSM 850
MEASUREMENT 2 GSM 1900
MEASUREMENT 3 WCDMA Band 2
MEASUREMENT 4 WCDMA Band 5
MEASUREMENT 5 WLAN 2.4G
MEASUREMENT 6 LTE Band 2
MEASUREMENT 7 LTE Band 4
MEASUREMENT 8 LTE Band 5
MEASUREMENT 9 LTE Band 7
MEASUREMENT 10 LTE Band 40A
MEASUREMENT 11 LTE Band 40B
MEASUREMENT 12 LTE Band 41

# MEASUREMENT 1

Date of measurement: 6/1/2021

## A. Experimental conditions.

<b>Area Scan</b>	<u>dx=15mm dy=15mm, h= 5.00 mm</u>
<b>ZoomScan</b>	<u>5x5x7, dx=8mm dy=8mm dz=5mm</u>
<b>Phantom</b>	<u>Validation plane</u>
<b>Device Position</b>	<u>Body</u>
<b>Band</b>	<u>GSM850</u>
<b>Channels</b>	<u>Middle</u>
<b>Signal</b>	<u>TDMA (Crest factor: 2.0)</u>

## B. SAR Measurement Results

<b>Frequency (MHz)</b>	836.400000
<b>Relative permittivity (real part)</b>	41.632114
<b>Relative permittivity (imaginary part)</b>	19.769276
<b>Conductivity (S/m)</b>	0.918612
<b>Variation (%)</b>	-0.110000

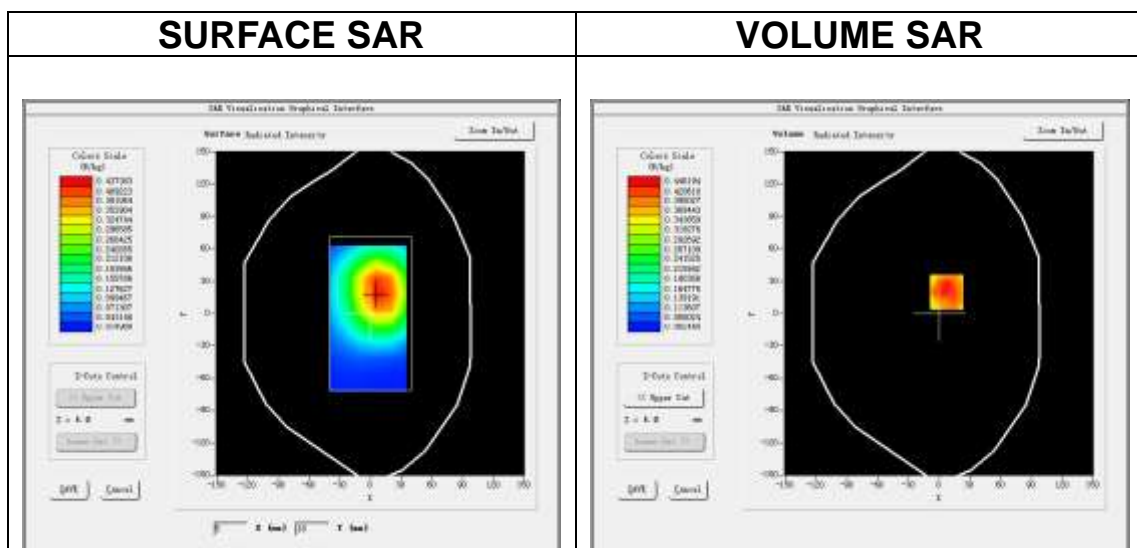

**Maximum location: X=7.00, Y=20.00**

**SAR Peak: 0.64 W/kg**

<b>SAR 10g (W/Kg)</b>	0.305029
<b>SAR 1g (W/Kg)</b>	0.441462

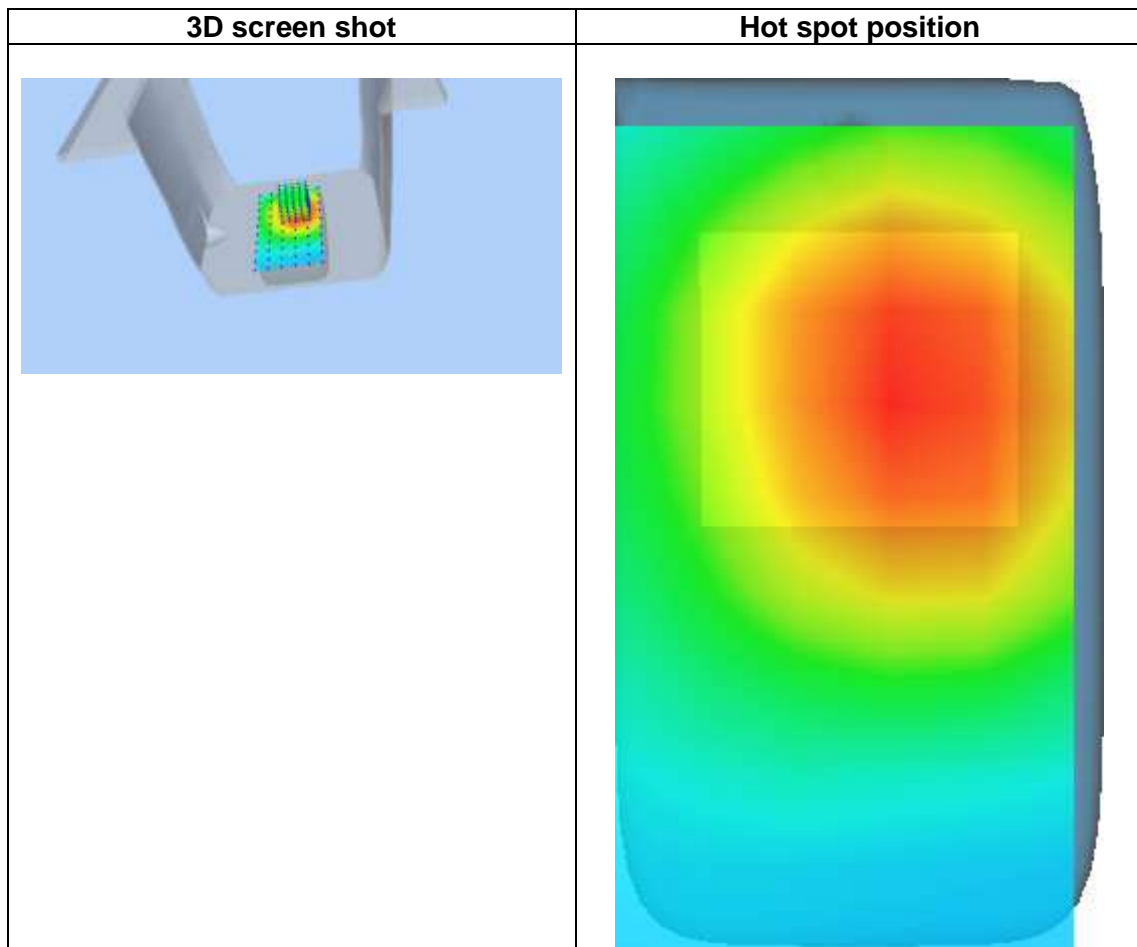
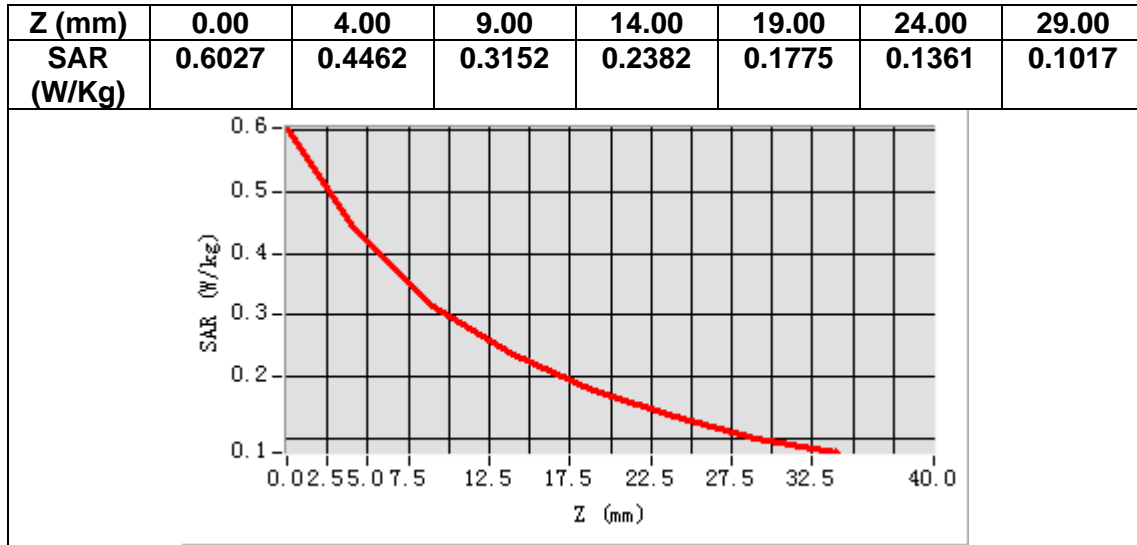

## MEASUREMENT 2

Date of measurement: 8/1/2021

### A. Experimental conditions.

<u>Area Scan</u>	<u>dx=15mm dy=15mm, h= 5.00 mm</u>
<u>ZoomScan</u>	<u>5x5x7, dx=8mm dy=8mm dz=5mm</u>
<u>Phantom</u>	<u>Validation plane</u>
<u>Device Position</u>	<u>Body</u>
<u>Band</u>	<u>GSM1900</u>
<u>Channels</u>	<u>Middle</u>
<u>Signal</u>	<u>TDMA (Crest factor: 2.7)</u>

### B. SAR Measurement Results

Frequency (MHz)	1880.000000
Relative permittivity (real part)	39.623692
Relative permittivity (imaginary part)	13.302464
Conductivity (S/m)	1.389368
Variation (%)	-1.960000

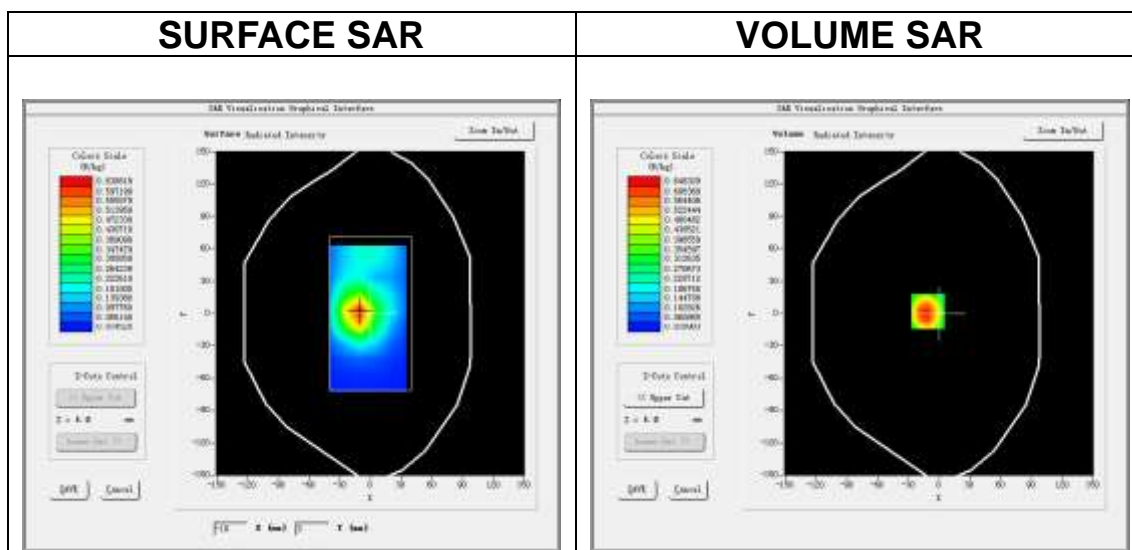

**Maximum location: X=-11.00, Y=2.00**

**SAR Peak: 1.02 W/kg**

SAR 10g (W/Kg)	0.344591
SAR 1g (W/Kg)	0.630928

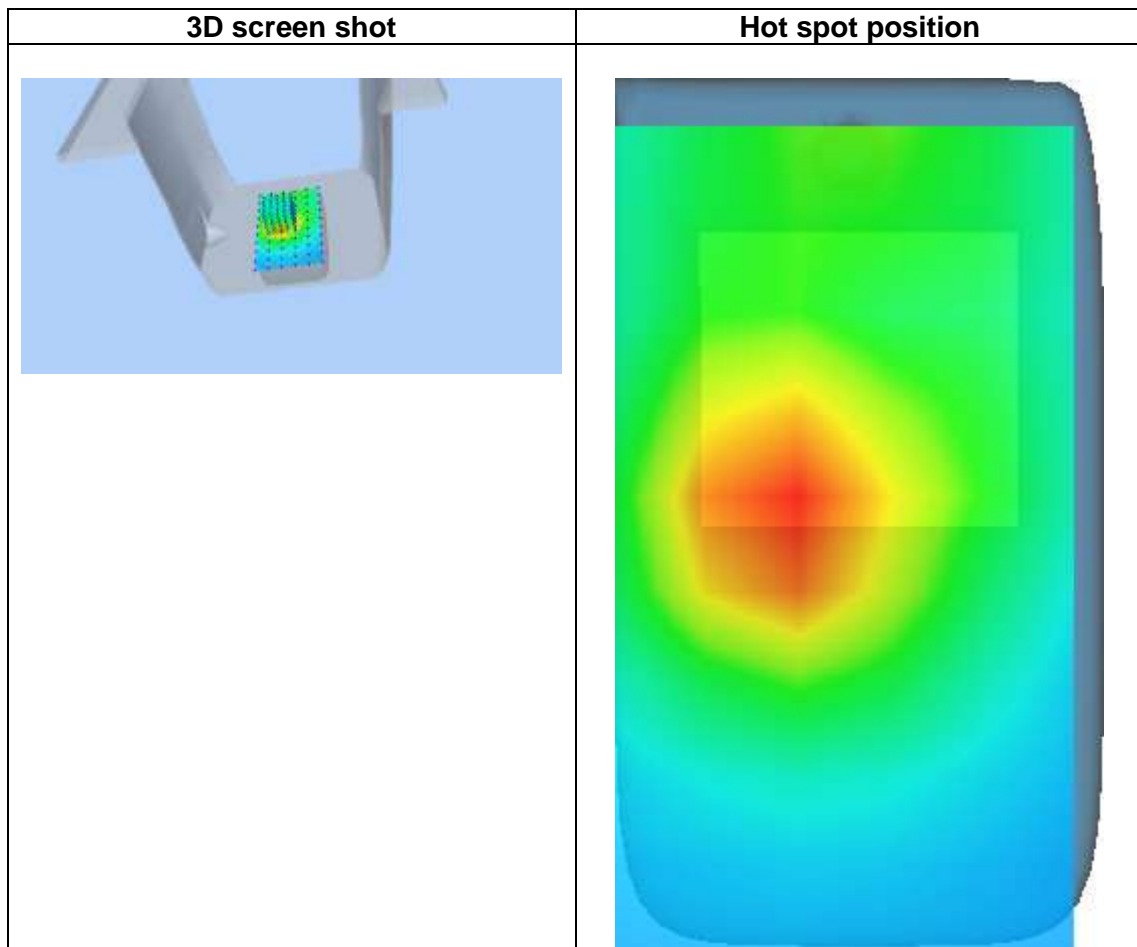
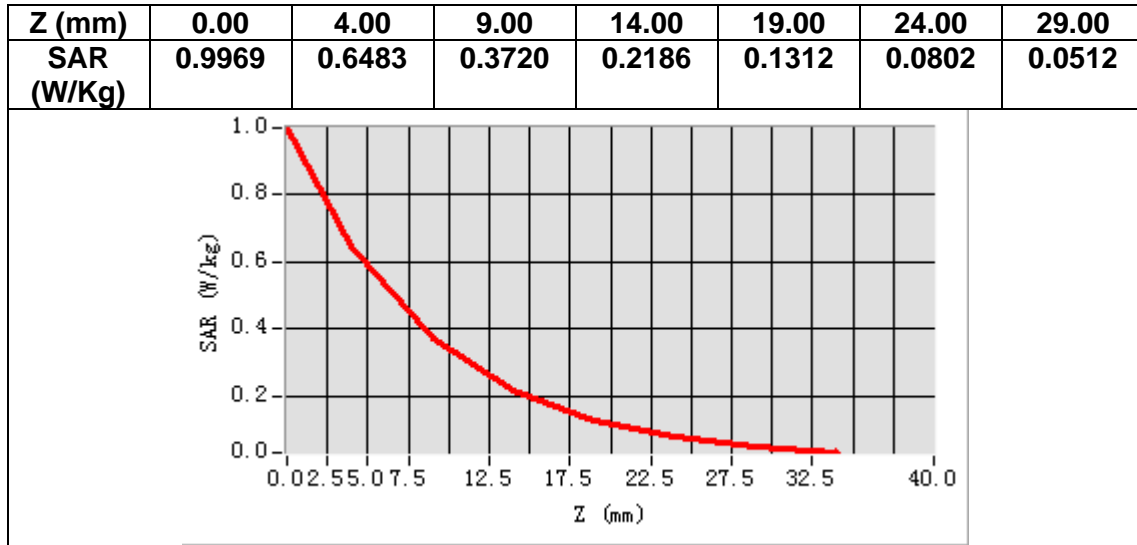



## MEASUREMENT 3

Date of measurement: 8/1/2021

### A. Experimental conditions.

<u>Area Scan</u>	<u>dx=15mm dy=15mm, h= 5.00 mm</u>
<u>ZoomScan</u>	<u>5x5x7, dx=8mm dy=8mm dz=5mm</u>
<u>Phantom</u>	<u>Validation plane</u>
<u>Device Position</u>	<u>Body</u>
<u>Band</u>	<u>Band2 WCDMA1900</u>
<u>Channels</u>	<u>Middle</u>
<u>Signal</u>	<u>WCDMA (Crest factor: 1.0)</u>

### B. SAR Measurement Results

<b>Frequency (MHz)</b>	1880.000000
<b>Relative permittivity (real part)</b>	39.623692
<b>Relative permittivity (imaginary part)</b>	13.302464
<b>Conductivity (S/m)</b>	1.389368
<b>Variation (%)</b>	-3.280000

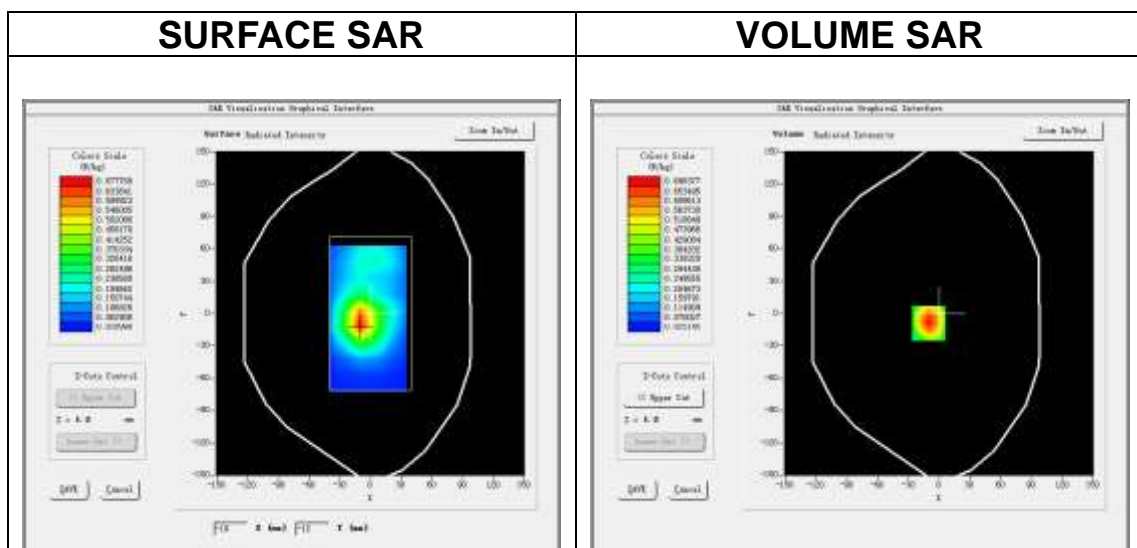

**Maximum location: X=-10.00, Y=-9.00**

**SAR Peak: 1.07 W/kg**

<b>SAR 10g (W/Kg)</b>	0.368465
<b>SAR 1g (W/Kg)</b>	0.665005

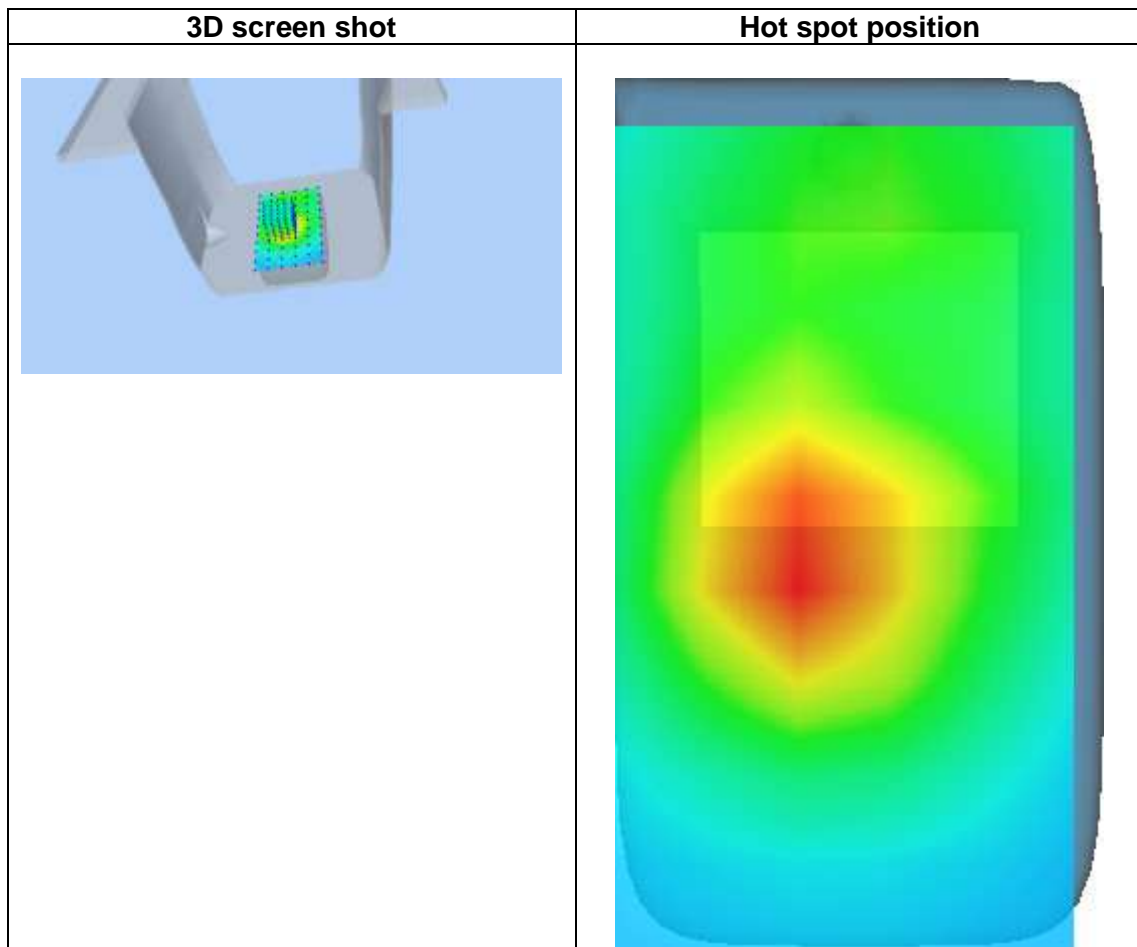
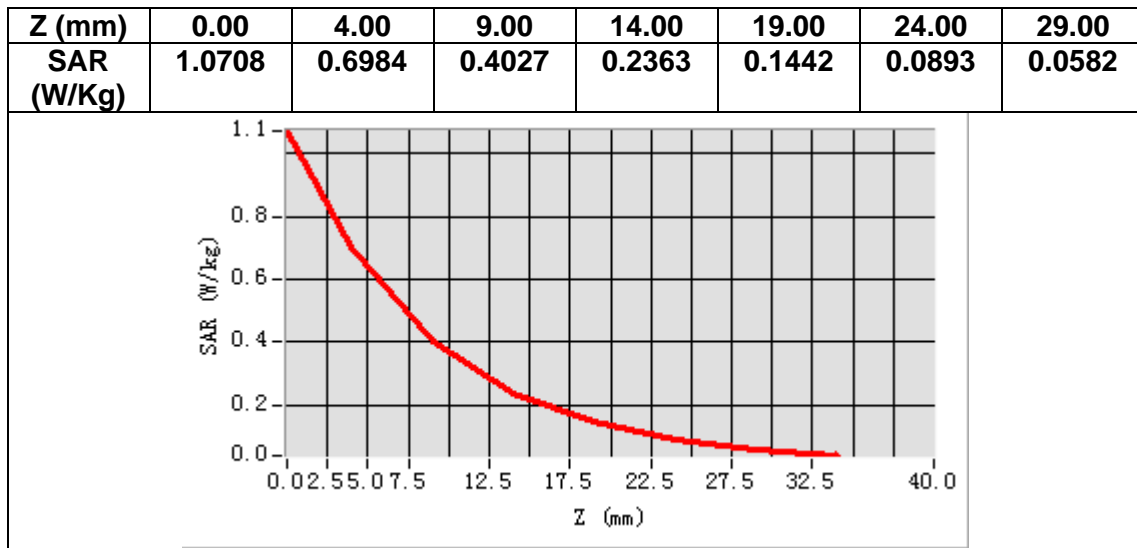

# MEASUREMENT 4

Date of measurement: 6/1/2021

## A. Experimental conditions.

<b>Area Scan</b>	<u>dx=15mm dy=15mm, h= 5.00 mm</u>
<b>ZoomScan</b>	<u>5x5x7, dx=8mm dy=8mm dz=5mm</u>
<b>Phantom</b>	<u>Validation plane</u>
<b>Device Position</b>	<u>Body</u>
<b>Band</b>	<u>Band5_WCDMA850</u>
<b>Channels</b>	<u>Middle</u>
<b>Signal</b>	<u>WCDMA (Crest factor: 1.0)</u>

## B. SAR Measurement Results

<b>Frequency (MHz)</b>	836.400000
<b>Relative permittivity (real part)</b>	41.632114
<b>Relative permittivity (imaginary part)</b>	19.769276
<b>Conductivity (S/m)</b>	0.918612
<b>Variation (%)</b>	-1.210000

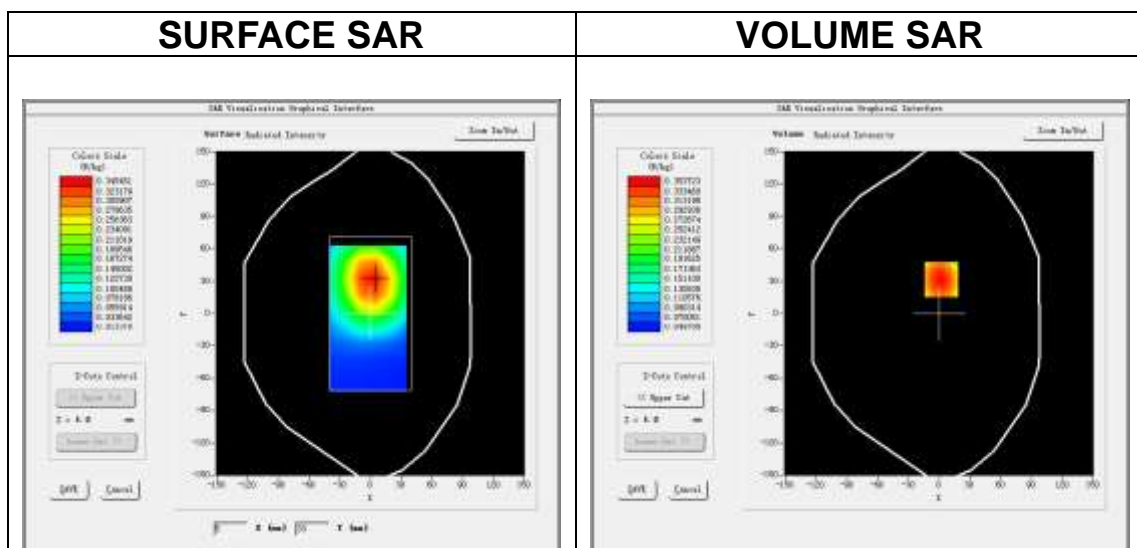

**Maximum location: X=2.00, Y=32.00**

**SAR Peak: 0.45 W/kg**

<b>SAR 10g (W/Kg)</b>	0.246385
<b>SAR 1g (W/Kg)</b>	0.346143

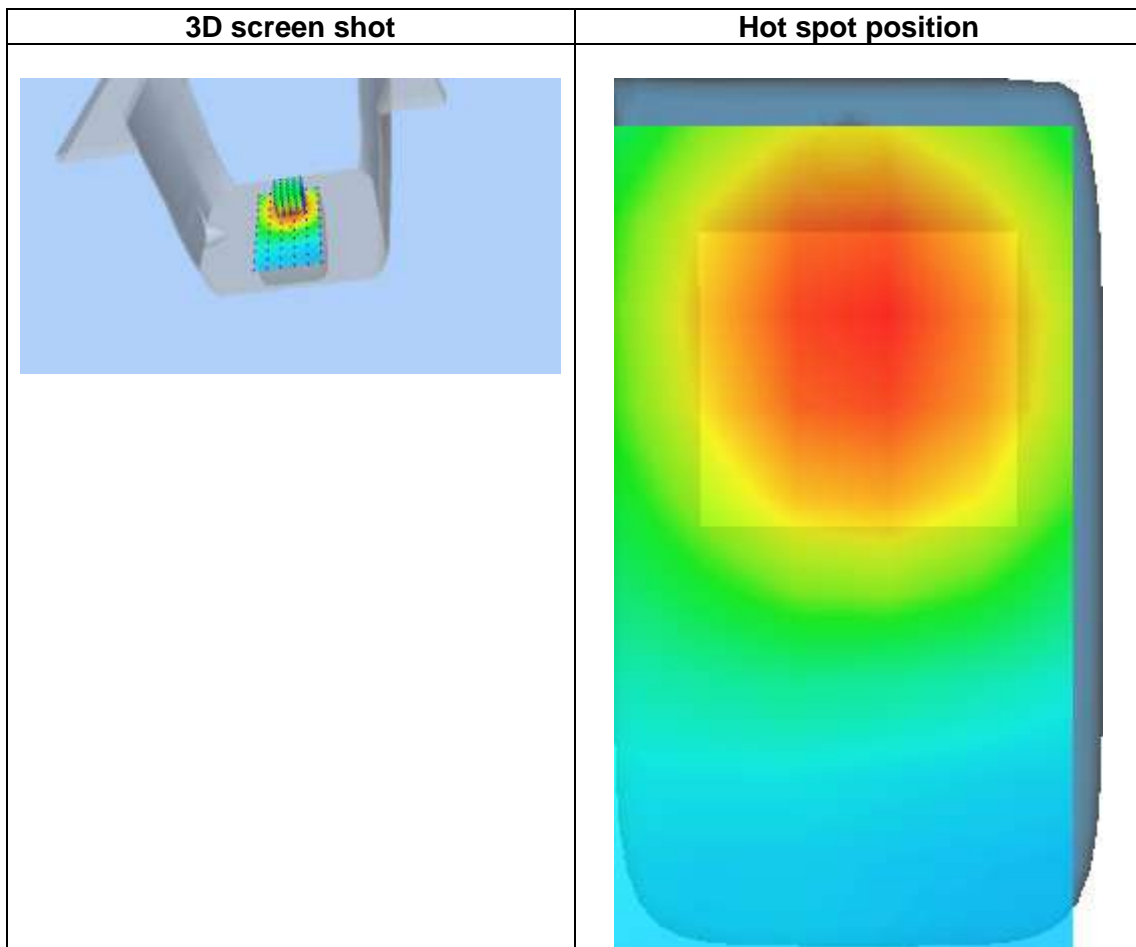
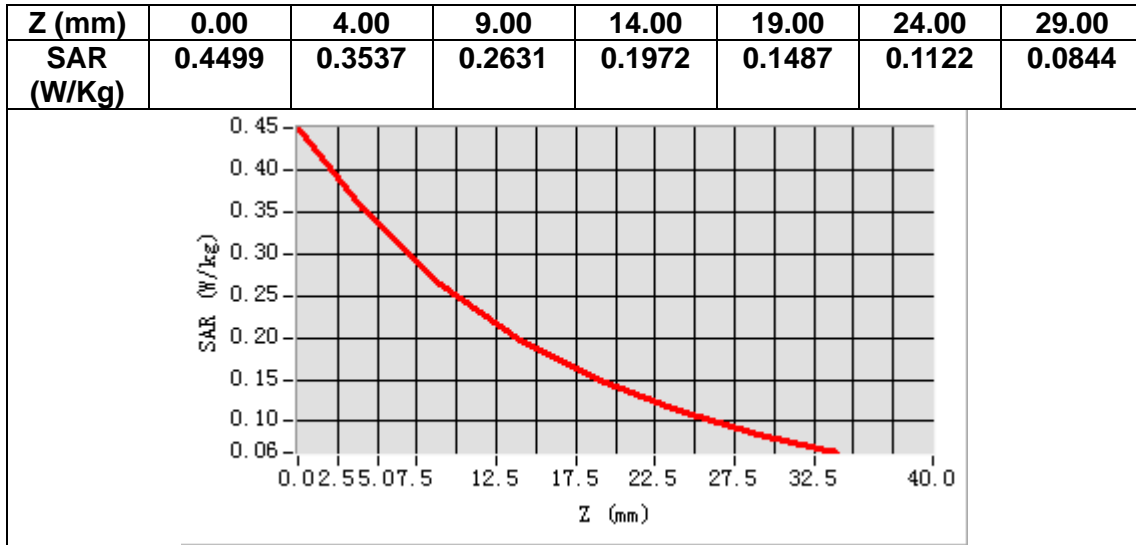

# MEASUREMENT 5

Date of measurement: 15/1/2021

## A. Experimental conditions.

<u>Area Scan</u>	<u>dx=12mm dy=12mm, h= 5.00 mm</u>
<u>ZoomScan</u>	<u>7x7x7, dx=5mm dy=5mm dz=5mm</u>
<u>Phantom</u>	<u>Validation plane</u>
<u>Device Position</u>	<u>Body</u>
<u>Band</u>	<u>IEEE 802.11b ISM</u>
<u>Channels</u>	<u>Middle</u>
<u>Signal</u>	<u>IEEE802.11b (Crest factor: 1.0)</u>

## B. SAR Measurement Results

<b>Frequency (MHz)</b>	2437.000000
<b>Relative permittivity (real part)</b>	39.348217
<b>Relative permittivity (imaginary part)</b>	13.646021
<b>Conductivity (S/m)</b>	1.847520
<b>Variation (%)</b>	2.050000

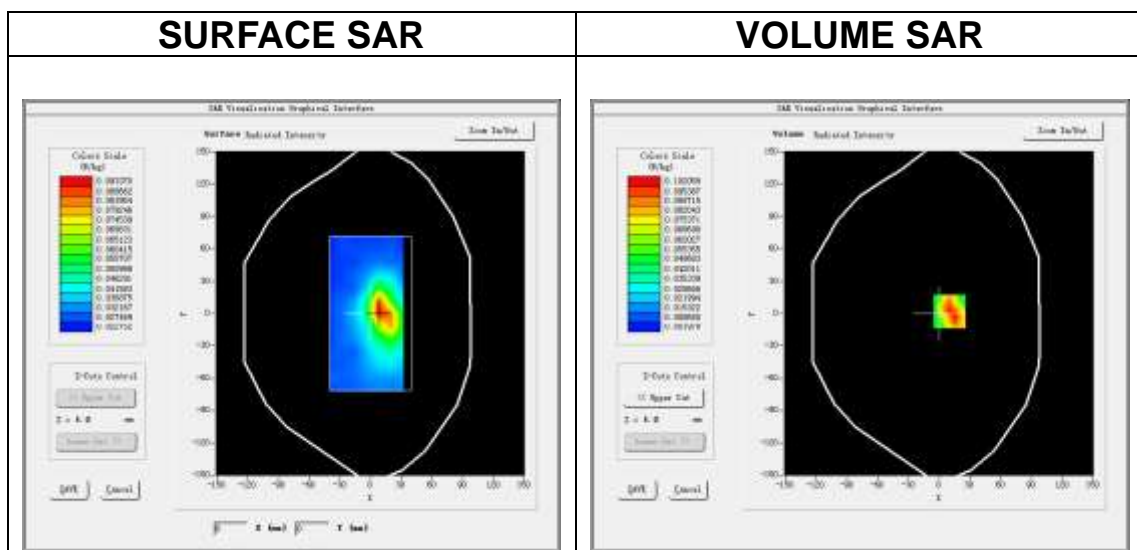

**Maximum location: X=10.00, Y=2.00**

**SAR Peak: 0.15 W/kg**

<b>SAR 10g (W/Kg)</b>	0.057496
<b>SAR 1g (W/Kg)</b>	0.093190

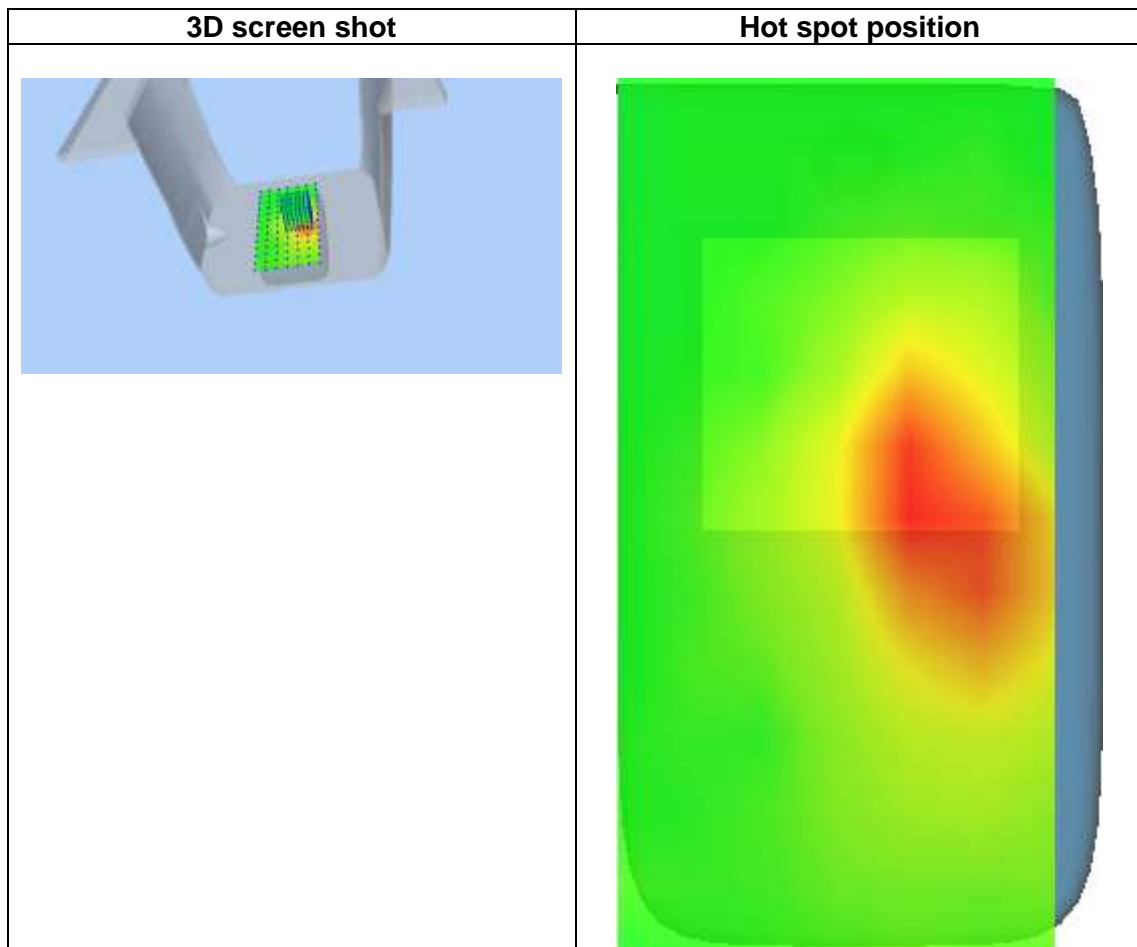
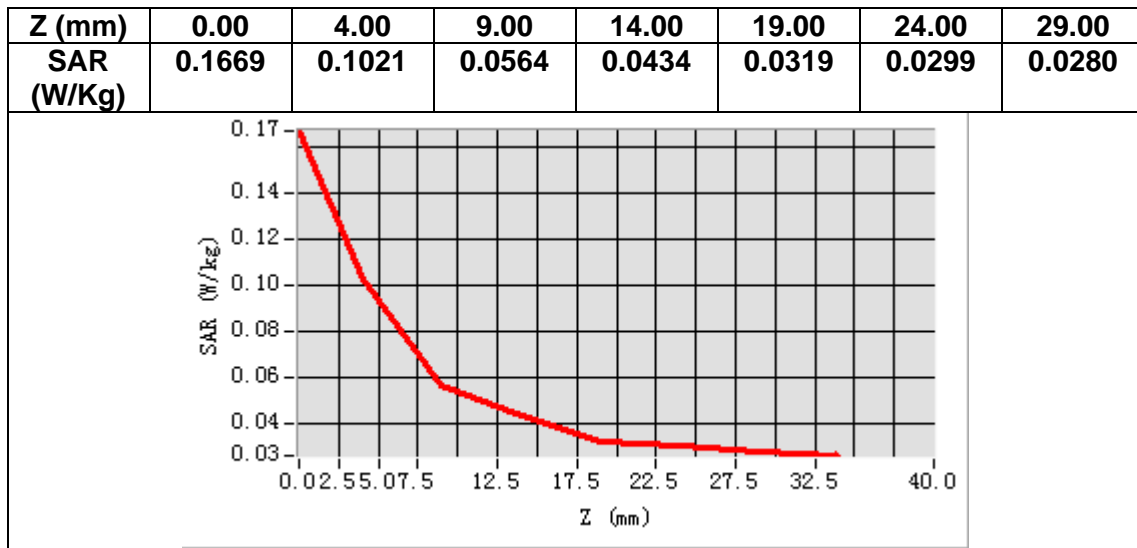

# MEASUREMENT 6

Date of measurement: 8/1/2021

## A. Experimental conditions.

<b>Area Scan</b>	<u>dx=15mm dy=15mm, h= 5.00 mm</u>
<b>ZoomScan</b>	<u>5x5x7, dx=8mm dy=8mm dz=5mm</u>
<b>Phantom</b>	<u>Validation plane</u>
<b>Device Position</b>	<u>Body</u>
<b>Band</b>	<u>LTE band 2</u>
<b>Channels</b>	<u>Middle</u>
<b>Signal</b>	<u>LTE (Crest factor: 1.0)</u>

## B. SAR Measurement Results

<b>Frequency (MHz)</b>	1880.000000
<b>Relative permittivity (real part)</b>	39.623692
<b>Relative permittivity (imaginary part)</b>	13.302464
<b>Conductivity (S/m)</b>	1.389368
<b>Variation (%)</b>	-0.570000

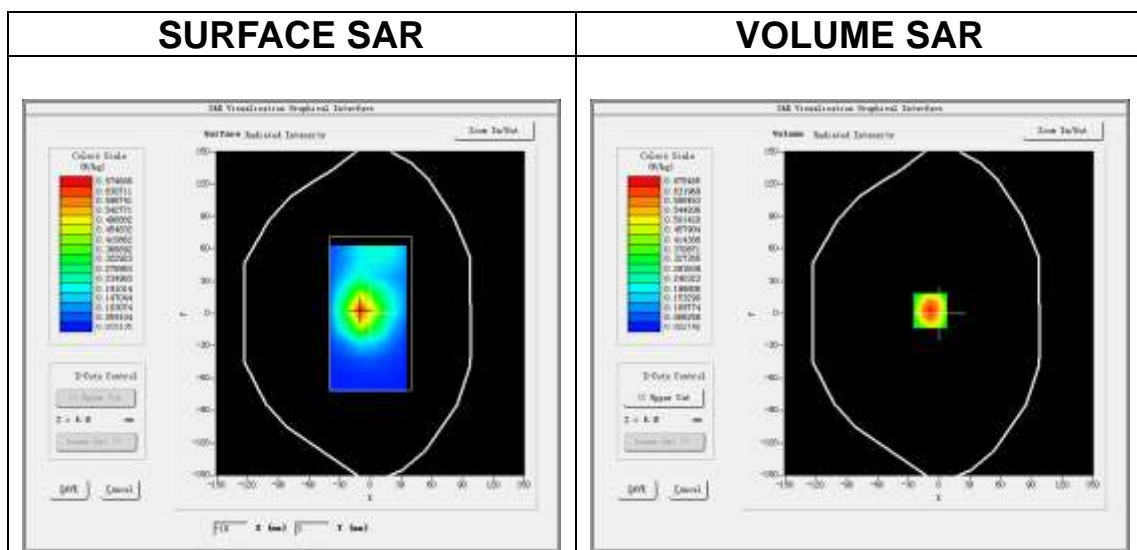

**Maximum location: X=-9.00, Y=3.00**

**SAR Peak: 1.01 W/kg**

<b>SAR 10g (W/Kg)</b>	0.357946
<b>SAR 1g (W/Kg)</b>	0.641064

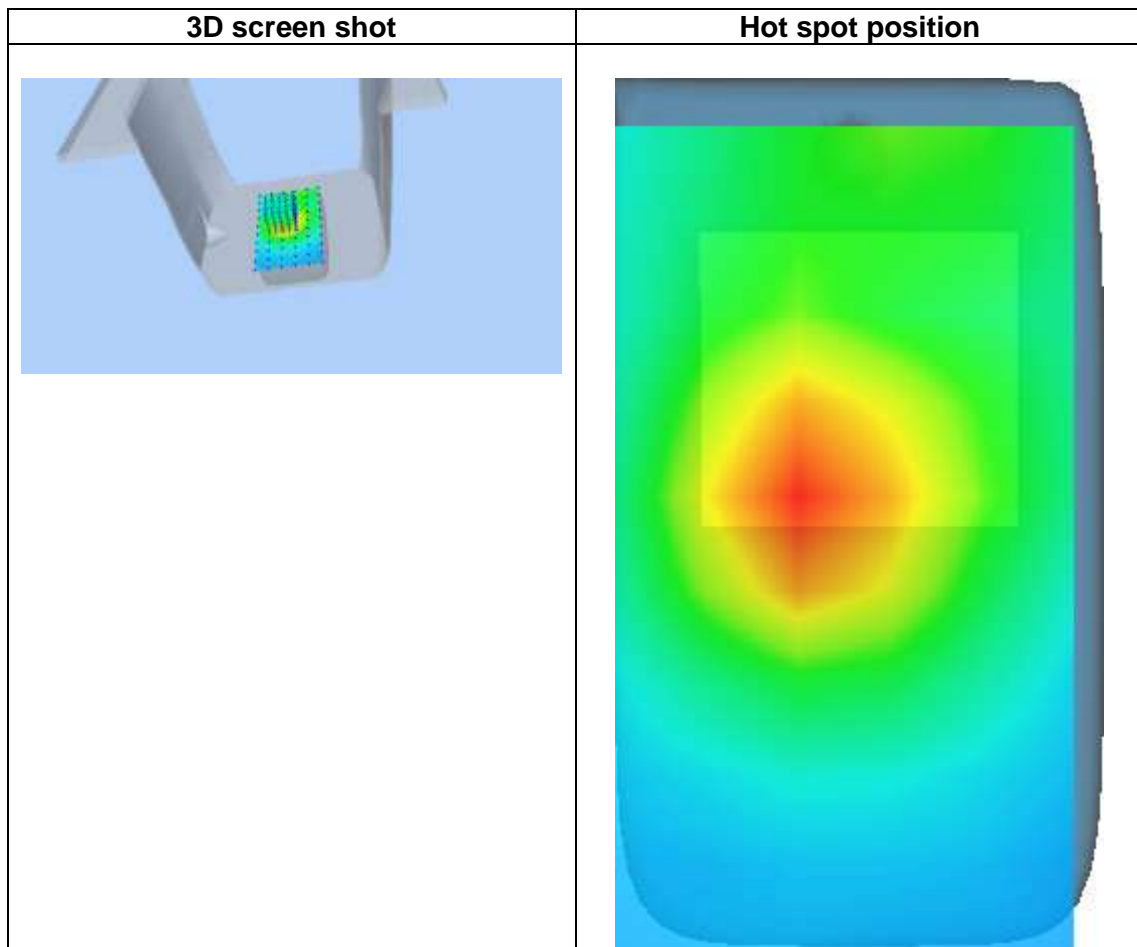
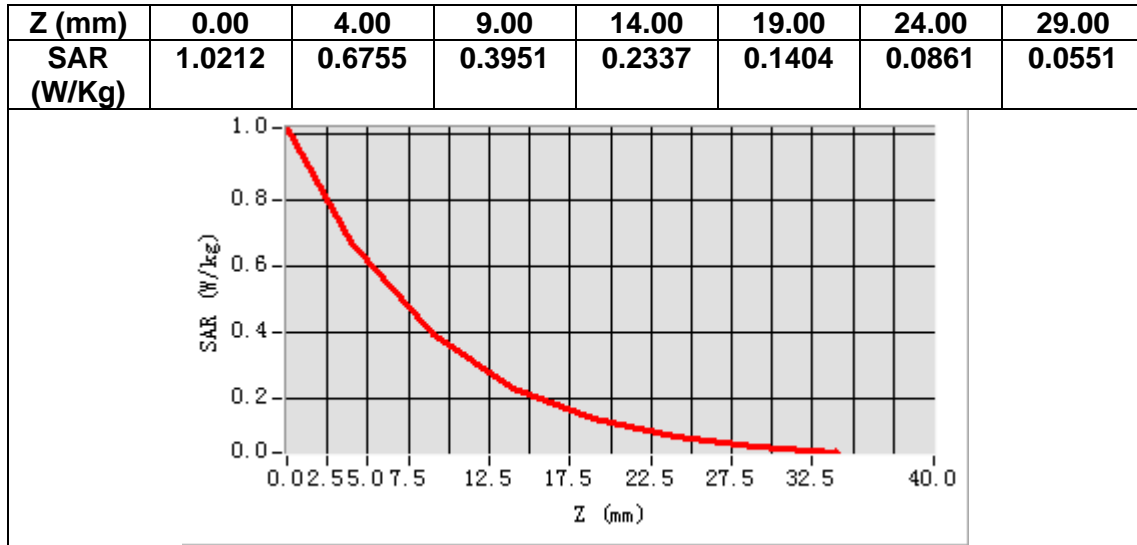



# MEASUREMENT 7

Date of measurement: 7/1/2021

## A. Experimental conditions.

<u>Area Scan</u>	<u>dx=15mm dy=15mm, h= 5.00 mm</u>
<u>ZoomScan</u>	<u>5x5x7, dx=8mm dy=8mm dz=5mm</u>
<u>Phantom</u>	<u>Validation plane</u>
<u>Device Position</u>	<u>Body</u>
<u>Band</u>	<u>LTE band 4</u>
<u>Channels</u>	<u>Middle</u>
<u>Signal</u>	<u>LTE (Crest factor: 1.0)</u>

## B. SAR Measurement Results

<b>Frequency (MHz)</b>	1732.500000
<b>Relative permittivity (real part)</b>	39.964214
<b>Relative permittivity (imaginary part)</b>	14.170592
<b>Conductivity (S/m)</b>	1.363919
<b>Variation (%)</b>	-2.240000

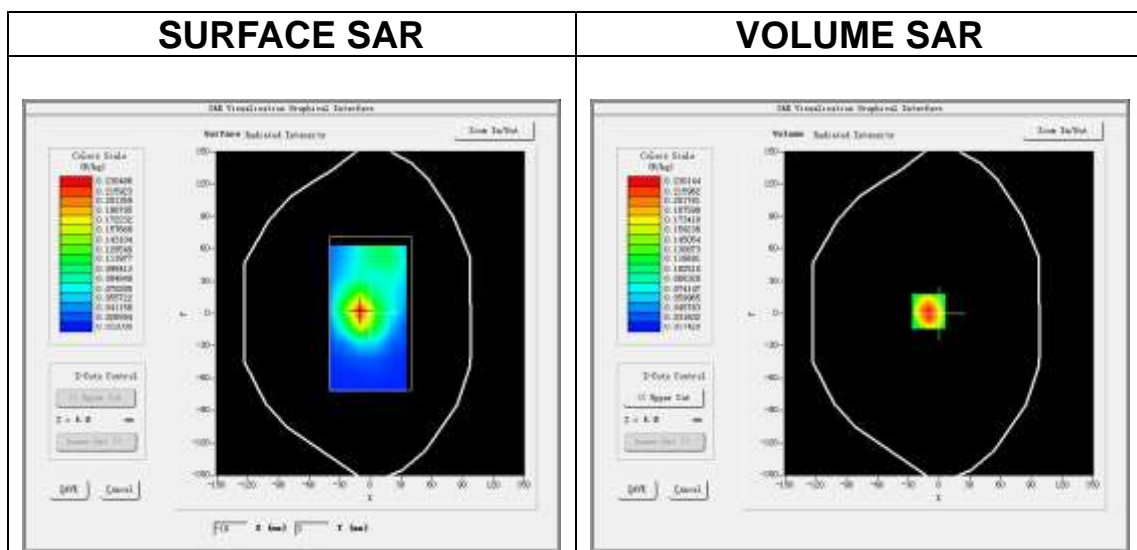

**Maximum location: X=-10.00, Y=2.00**

**SAR Peak: 0.34 W/kg**

<b>SAR 10g (W/Kg)</b>	0.126508
<b>SAR 1g (W/Kg)</b>	0.219362

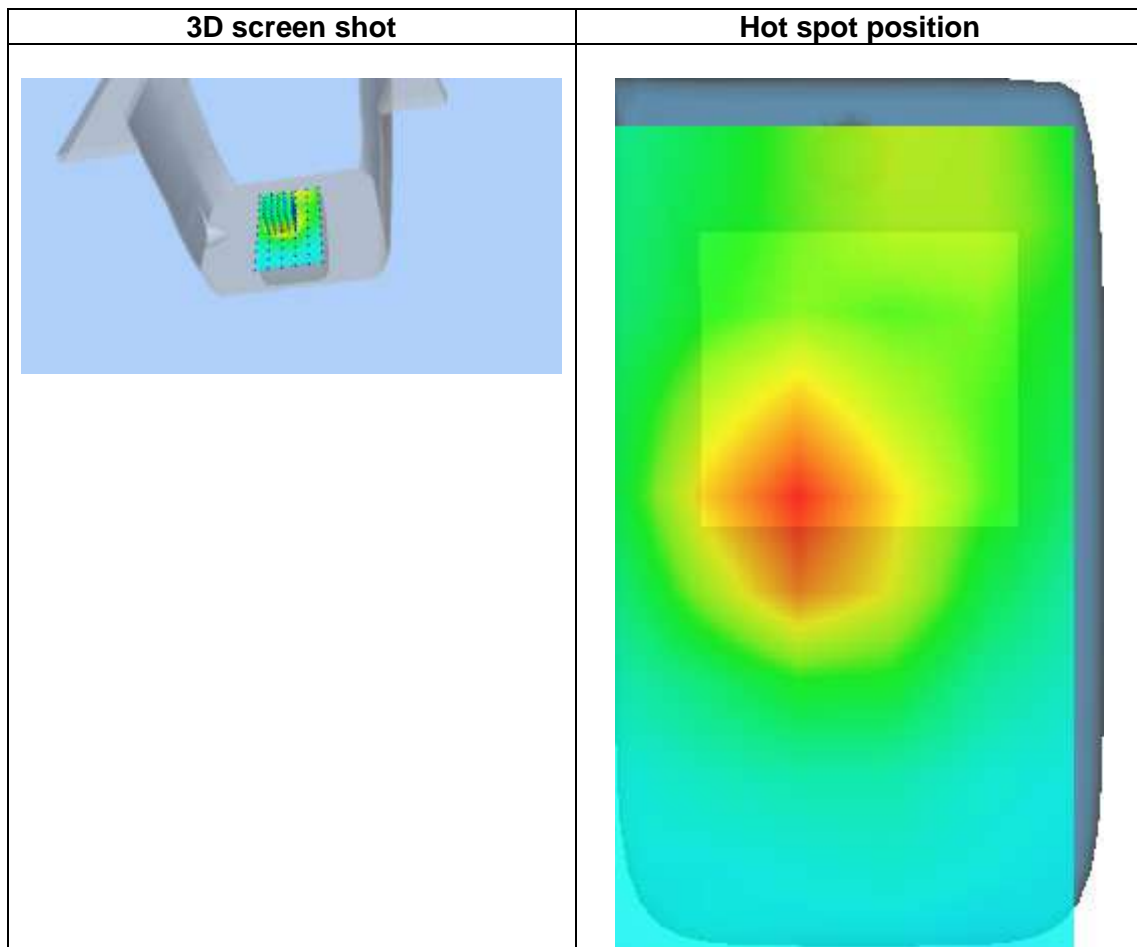
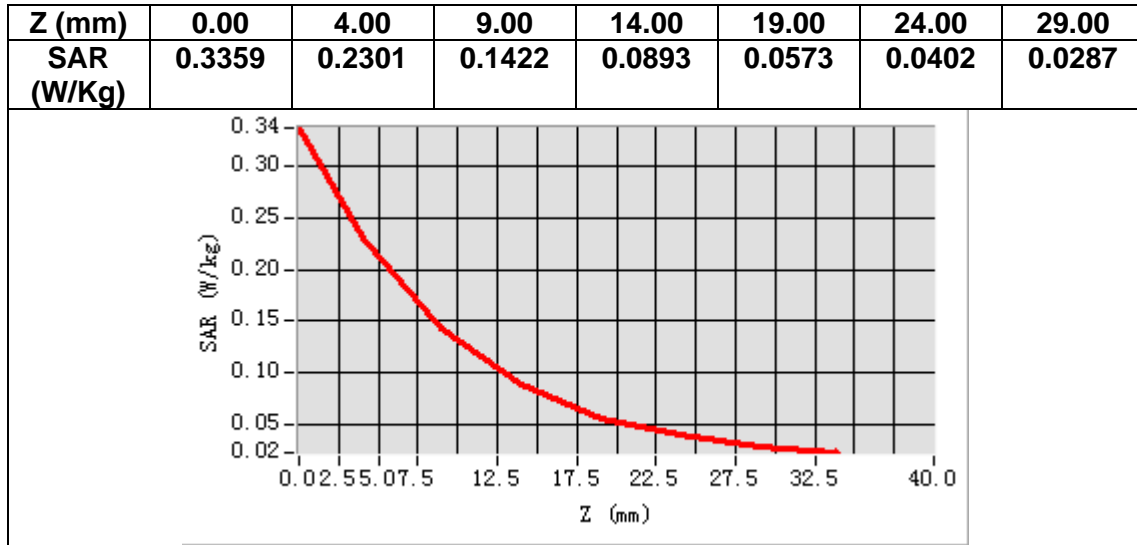

# MEASUREMENT 8

Date of measurement: 6/1/2021

## A. Experimental conditions.

<u>Area Scan</u>	<u>dx=15mm dy=15mm, h= 5.00 mm</u>
<u>ZoomScan</u>	<u>5x5x7, dx=8mm dy=8mm dz=5mm</u>
<u>Phantom</u>	<u>Validation plane</u>
<u>Device Position</u>	<u>Body</u>
<u>Band</u>	<u>LTE band 5</u>
<u>Channels</u>	<u>Middle</u>
<u>Signal</u>	<u>LTE (Crest factor: 1.0)</u>

## B. SAR Measurement Results

<b>Frequency (MHz)</b>	836.500000
<b>Relative permittivity (real part)</b>	41.634705
<b>Relative permittivity (imaginary part)</b>	19.767937
<b>Conductivity (S/m)</b>	0.918660
<b>Variation (%)</b>	0.620000

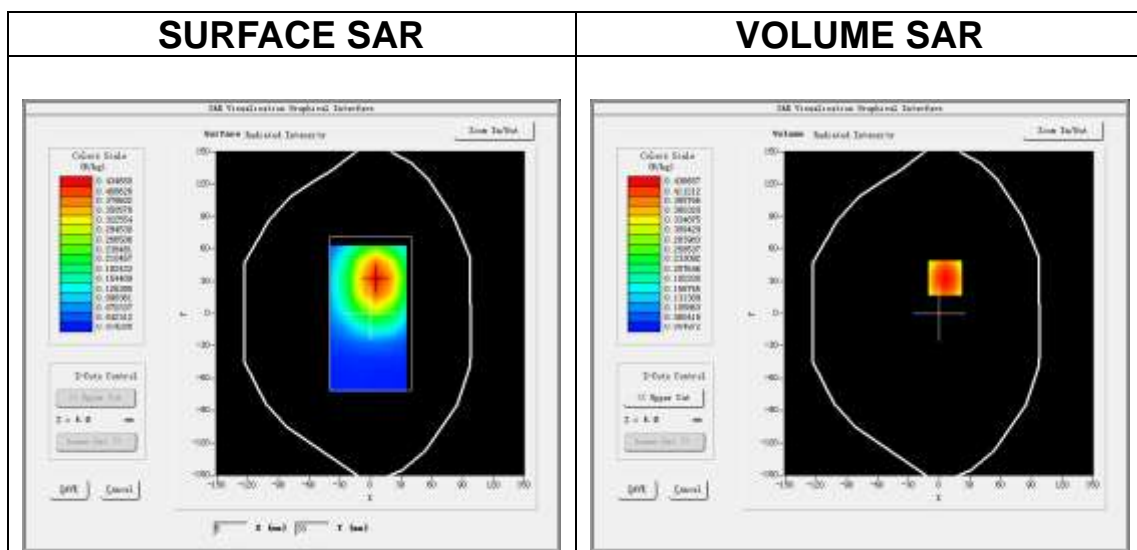

**Maximum location: X=6.00, Y=33.00**

**SAR Peak: 0.56 W/kg**

<b>SAR 10g (W/Kg)</b>	0.303008
<b>SAR 1g (W/Kg)</b>	0.427606

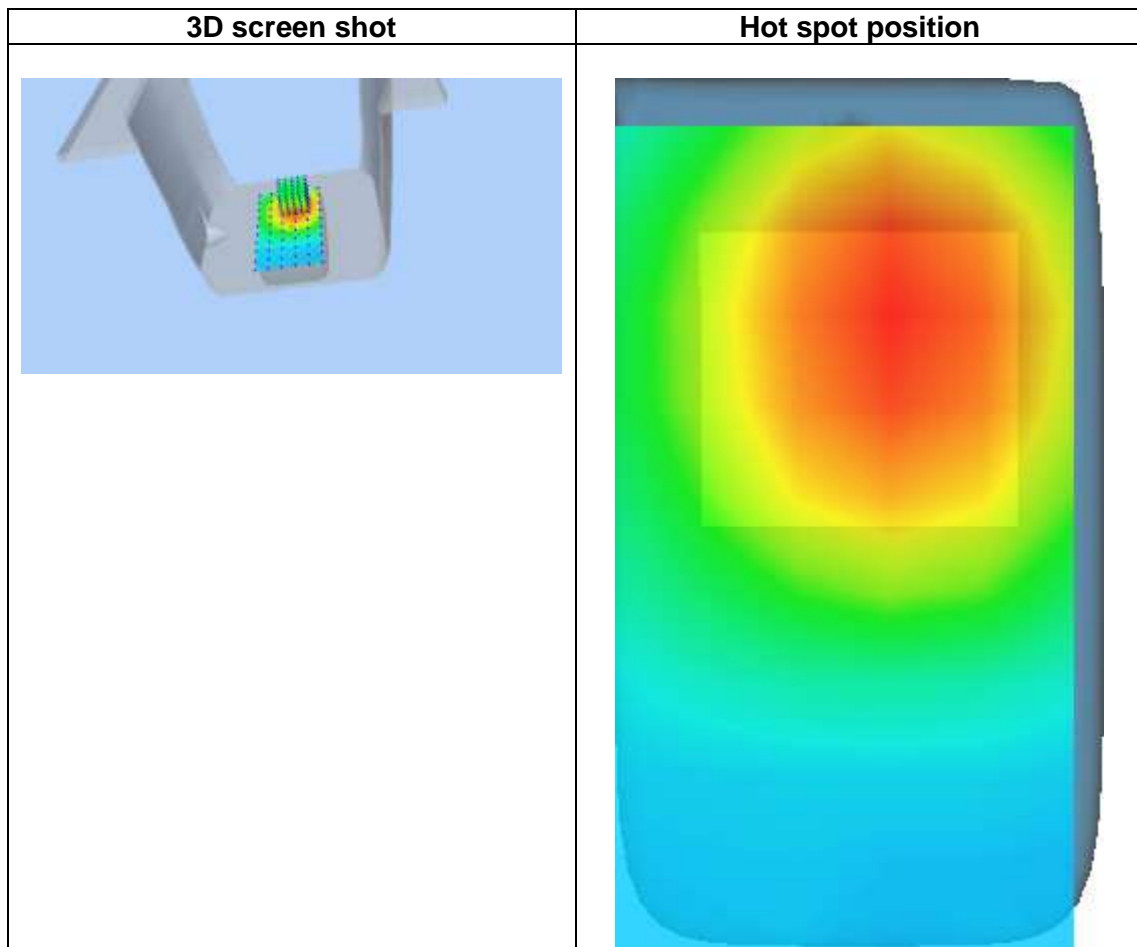
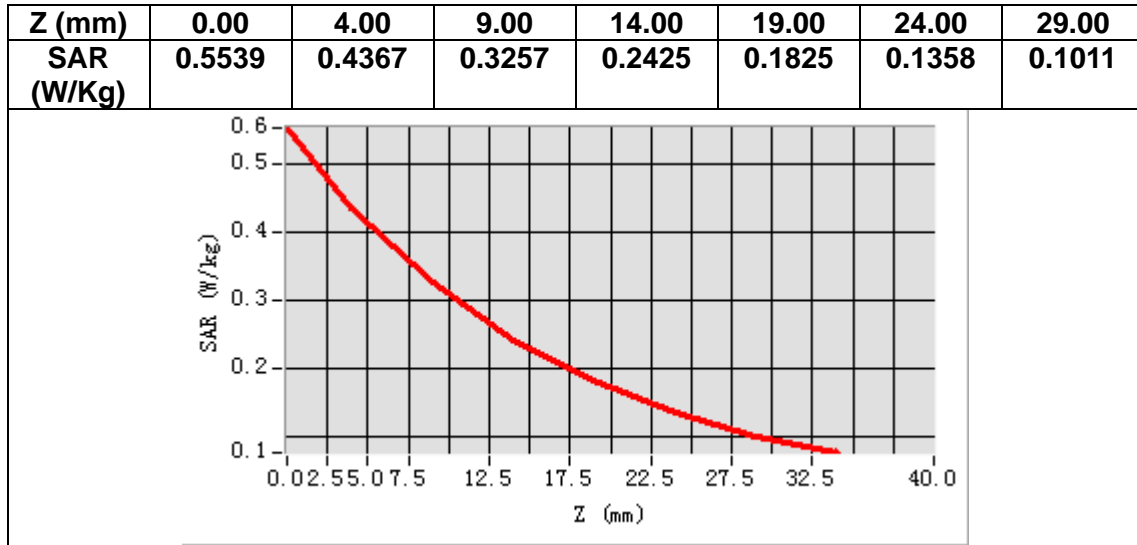

# MEASUREMENT 9

Date of measurement: 16/1/2021

## A. Experimental conditions.

<u>Area Scan</u>	<u>dx=12mm dy=12mm, h= 5.00 mm</u>
<u>ZoomScan</u>	<u>7x7x7, dx=5mm dy=5mm dz=5mm</u>
<u>Phantom</u>	<u>Validation plane</u>
<u>Device Position</u>	<u>Body</u>
<u>Band</u>	<u>LTE band 7</u>
<u>Channels</u>	<u>Middle</u>
<u>Signal</u>	<u>LTE (Crest factor: 1.0)</u>

## B. SAR Measurement Results

<b>Frequency (MHz)</b>	2535.000000
<b>Relative permittivity (real part)</b>	39.182701
<b>Relative permittivity (imaginary part)</b>	13.922560
<b>Conductivity (S/m)</b>	1.960761
<b>Variation (%)</b>	-4.560000

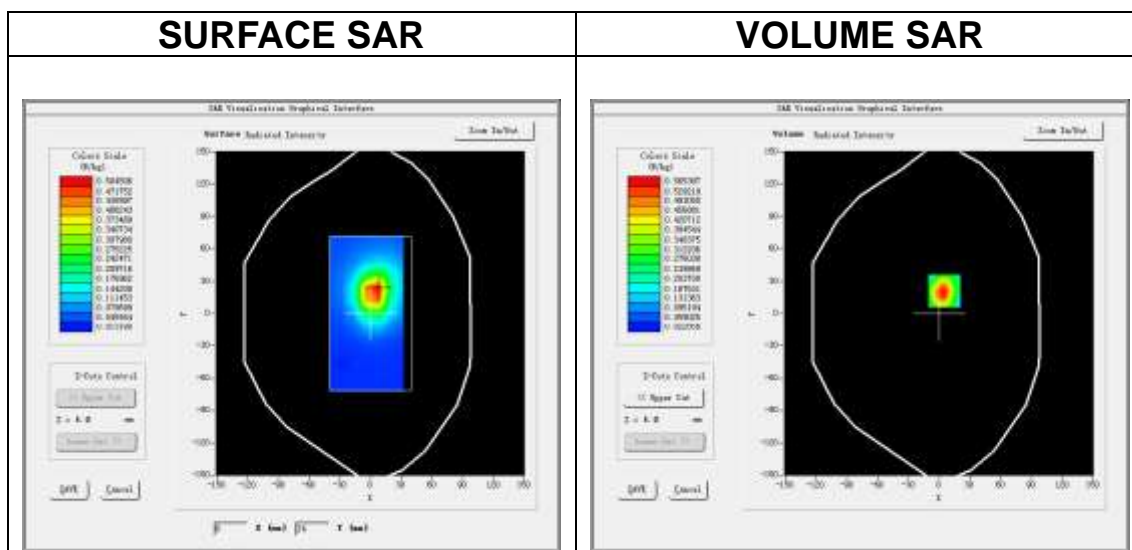

**Maximum location: X=5.00, Y=21.00**

**SAR Peak: 0.95 W/kg**

<b>SAR 10g (W/Kg)</b>	0.260589
<b>SAR 1g (W/Kg)</b>	0.537871

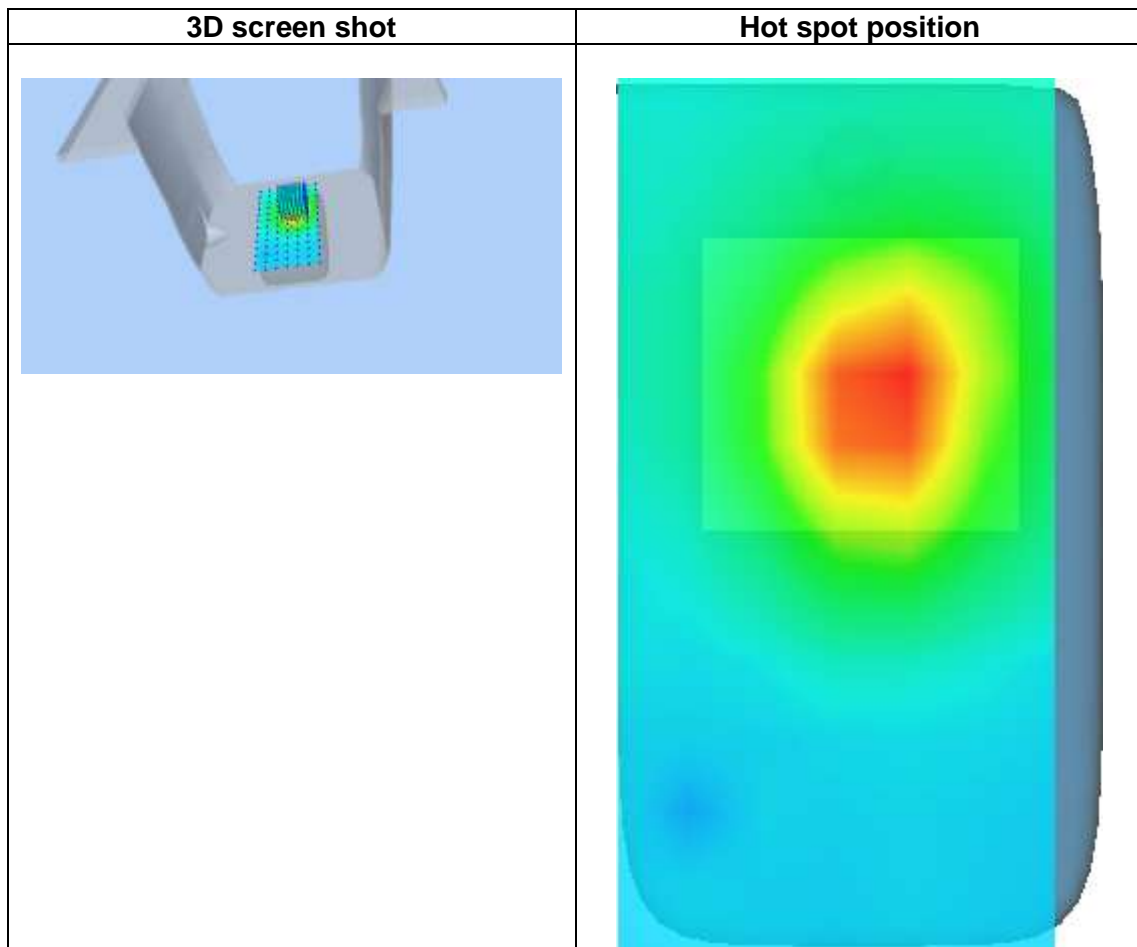
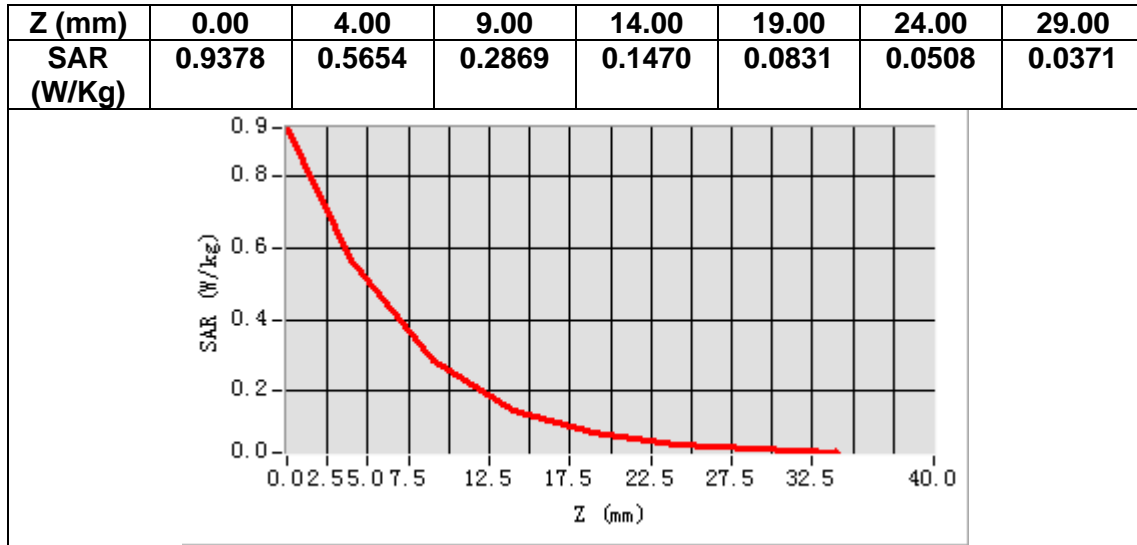

# MEASUREMENT 10

Date of measurement: 12/1/2021

## A. Experimental conditions.

<u>Area Scan</u>	<u>dx=12mm dy=12mm, h= 5.00 mm</u>
<u>ZoomScan</u>	<u>7x7x7, dx=5mm dy=5mm dz=5mm</u>
<u>Phantom</u>	<u>Validation plane</u>
<u>Device Position</u>	<u>Body</u>
<u>Band</u>	<u>LTE band 40A</u>
<u>Channels</u>	<u>Middle</u>
<u>Signal</u>	<u>LTE (Crest factor: 1.6)</u>

## B. SAR Measurement Results

<b>Frequency (MHz)</b>	2310.000000
<b>Relative permittivity (real part)</b>	39.823516
<b>Relative permittivity (imaginary part)</b>	13.661197
<b>Conductivity (S/m)</b>	1.753187
<b>Variation (%)</b>	0.990000

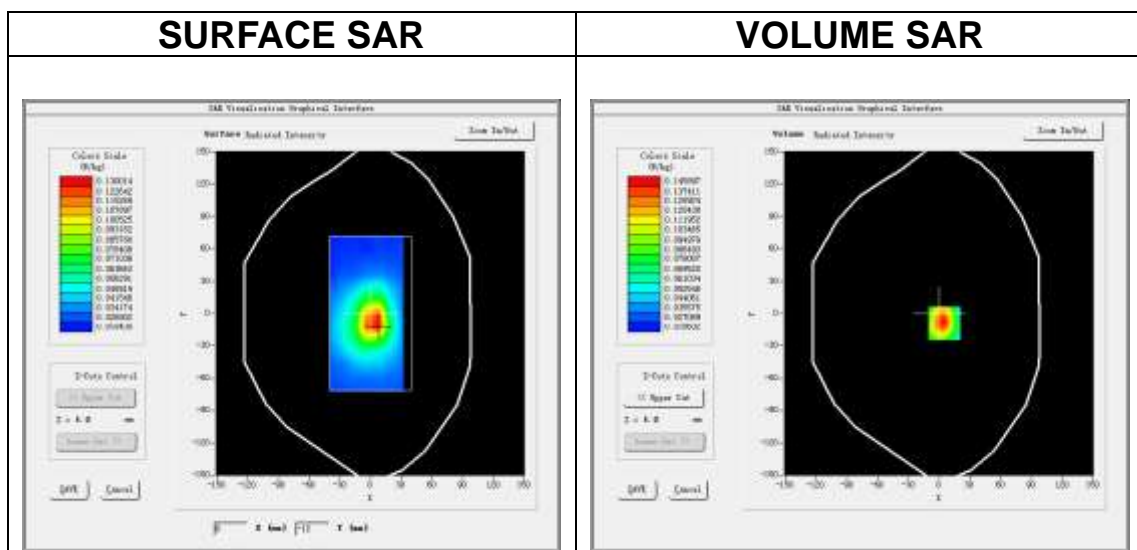

**Maximum location: X=5.00, Y=-9.00**

**SAR Peak: 0.23 W/kg**

<b>SAR 10g (W/Kg)</b>	0.078890
<b>SAR 1g (W/Kg)</b>	0.139774

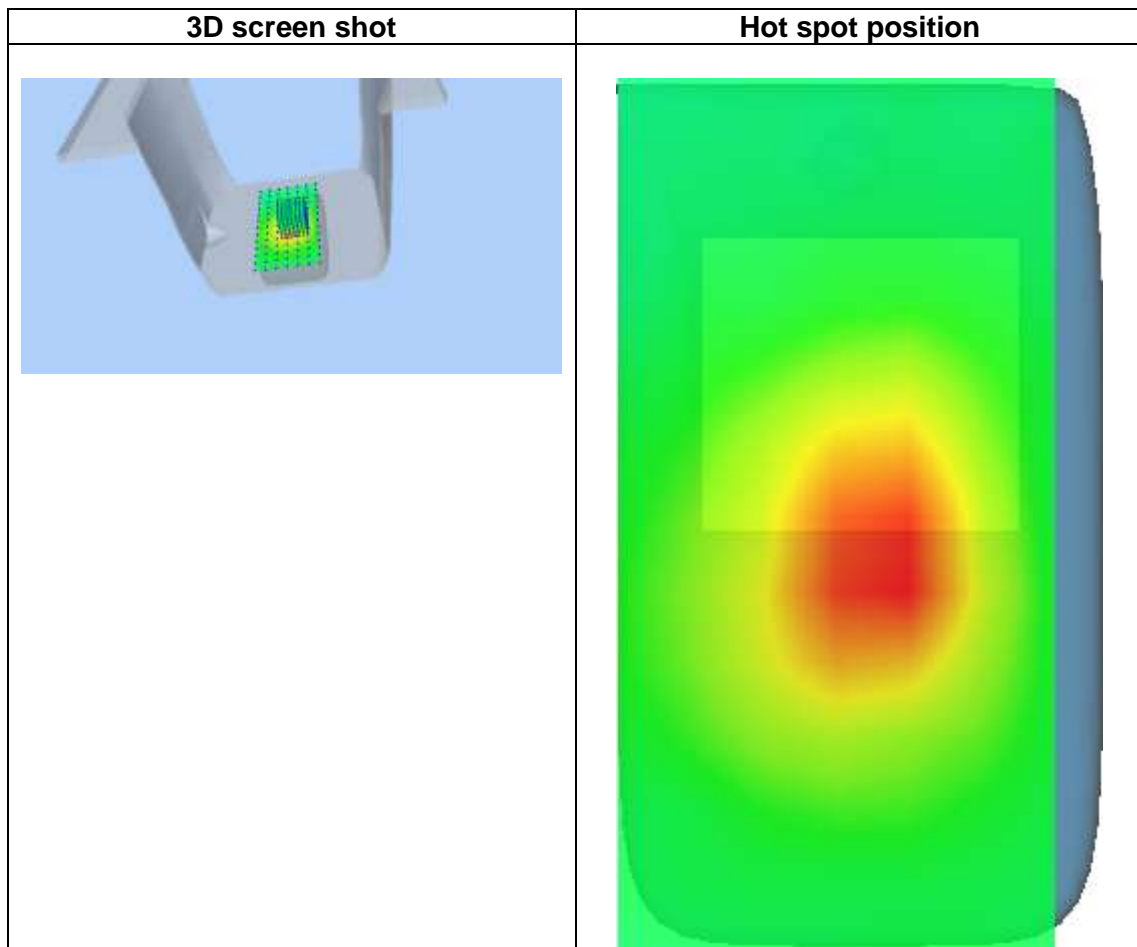
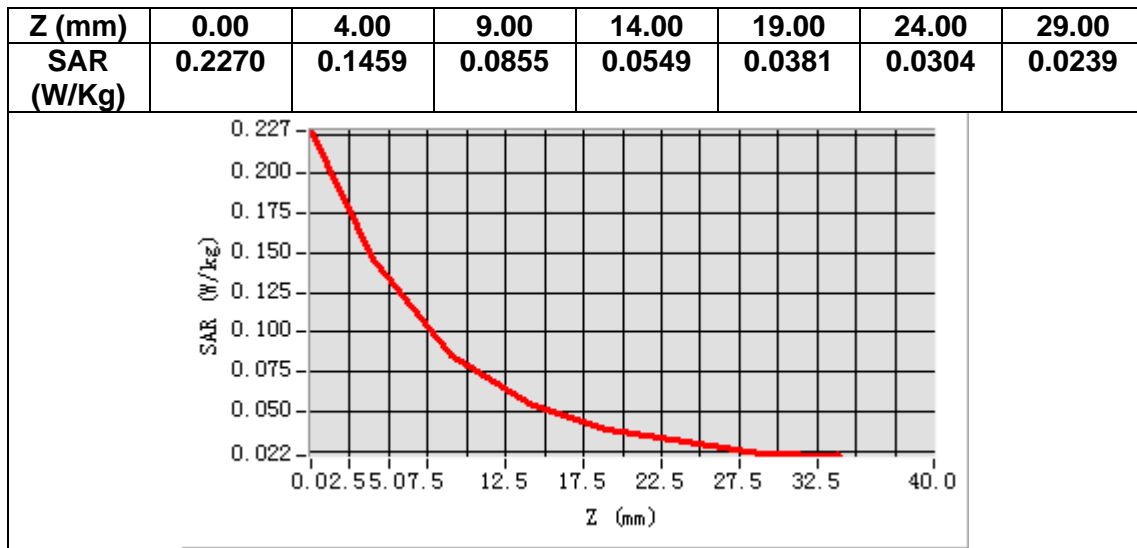



# MEASUREMENT 11

Date of measurement: 12/1/2021

## A. Experimental conditions.

<b>Area Scan</b>	<u>dx=12mm dy=12mm, h= 5.00 mm</u>
<b>ZoomScan</b>	<u>7x7x7,dx=5mm dy=5mm dz=5mm</u>
<b>Phantom</b>	<u>Validation plane</u>
<b>Device Position</b>	<u>Body</u>
<b>Band</b>	<u>LTE band 40B</u>
<b>Channels</b>	<u>Middle</u>
<b>Signal</b>	<u>LTE (Crest factor: 1.6)</u>

## B. SAR Measurement Results

<b>Frequency (MHz)</b>	2355.000000
<b>Relative permittivity (real part)</b>	39.706316
<b>Relative permittivity (imaginary part)</b>	13.800397
<b>Conductivity (S/m)</b>	1.805552
<b>Variation (%)</b>	4.240002

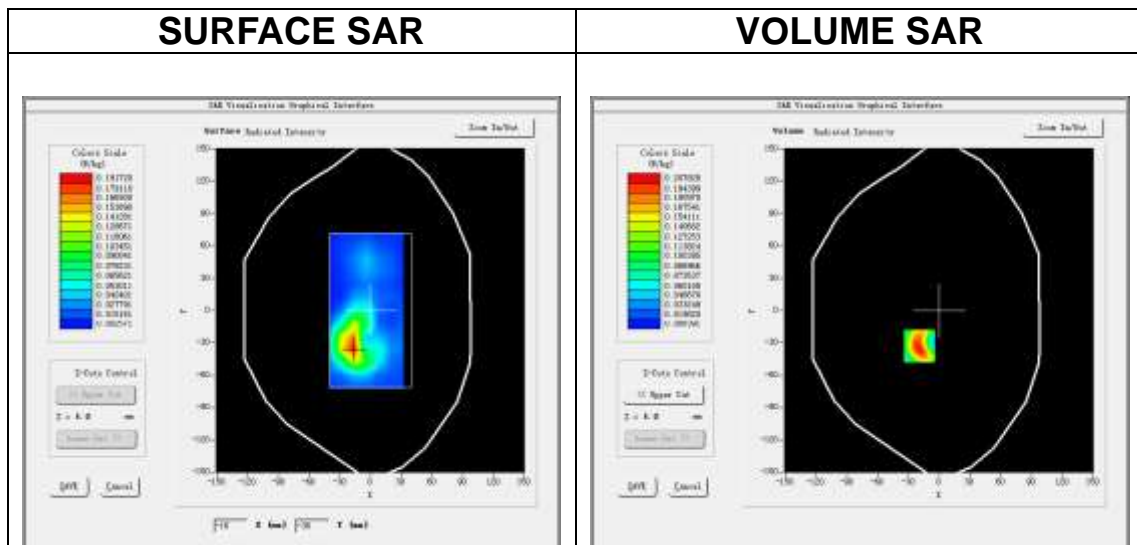

**Maximum location: X=-19.00, Y=-33.00**

**SAR Peak: 0.36 W/kg**

<b>SAR 10g (W/Kg)</b>	0.089680
<b>SAR 1g (W/Kg)</b>	0.192323

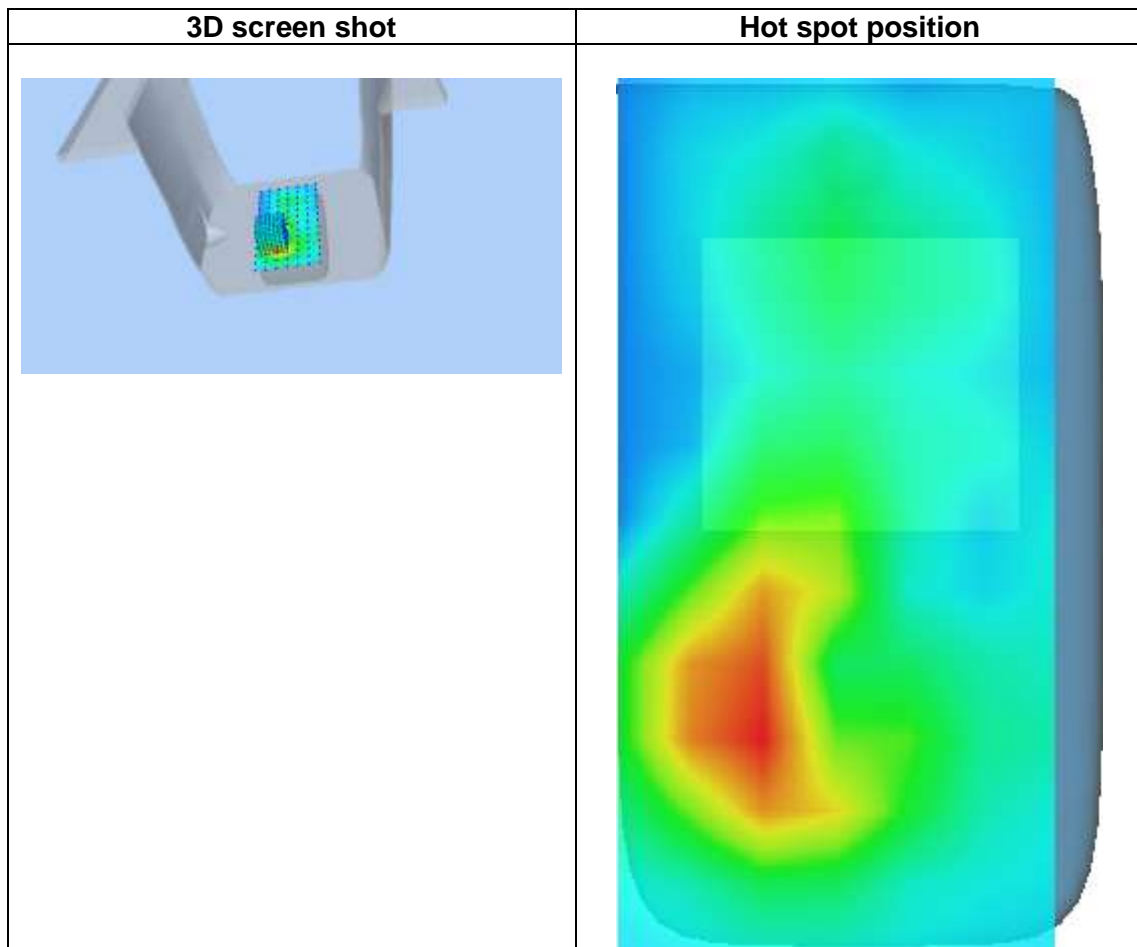
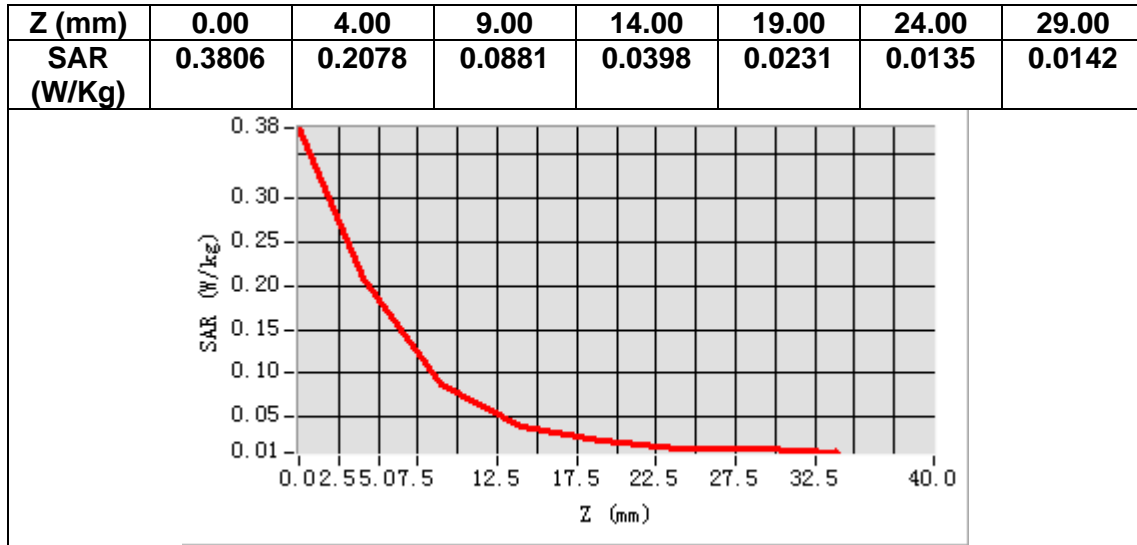

## MEASUREMENT 12

Date of measurement: 16/1/2021

### A. Experimental conditions.

<b>Area Scan</b>	<u>dx=12mm dy=12mm, h= 5.00 mm</u>
<b>ZoomScan</b>	<u>7x7x7, dx=5mm dy=5mm dz=5mm</u>
<b>Phantom</b>	<u>Validation plane</u>
<b>Device Position</b>	<u>Body</u>
<b>Band</b>	<u>LTE band 41</u>
<b>Channels</b>	<u>Middle</u>
<b>Signal</b>	<u>LTE (Crest factor: 1.6)</u>

### B. SAR Measurement Results

<b>Frequency (MHz)</b>	2593.000000
<b>Relative permittivity (real part)</b>	38.901203
<b>Relative permittivity (imaginary part)</b>	14.086160
<b>Conductivity (S/m)</b>	2.029190
<b>Variation (%)</b>	-0.590000

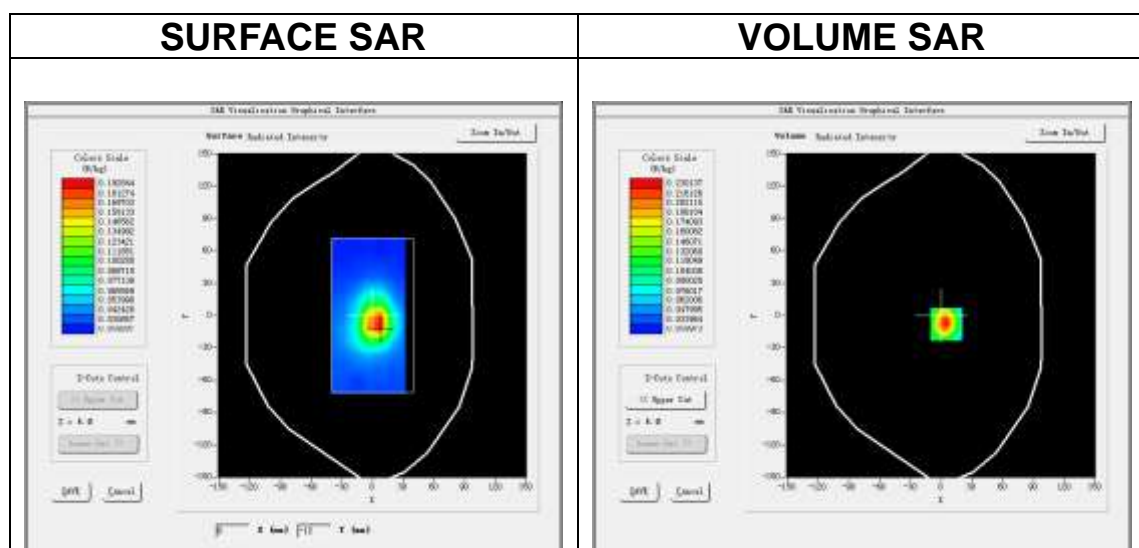

**Maximum location: X=5.00, Y=-8.00**

**SAR Peak: 0.38 W/kg**

<b>SAR 10g (W/Kg)</b>	0.109677
<b>SAR 1g (W/Kg)</b>	0.217459

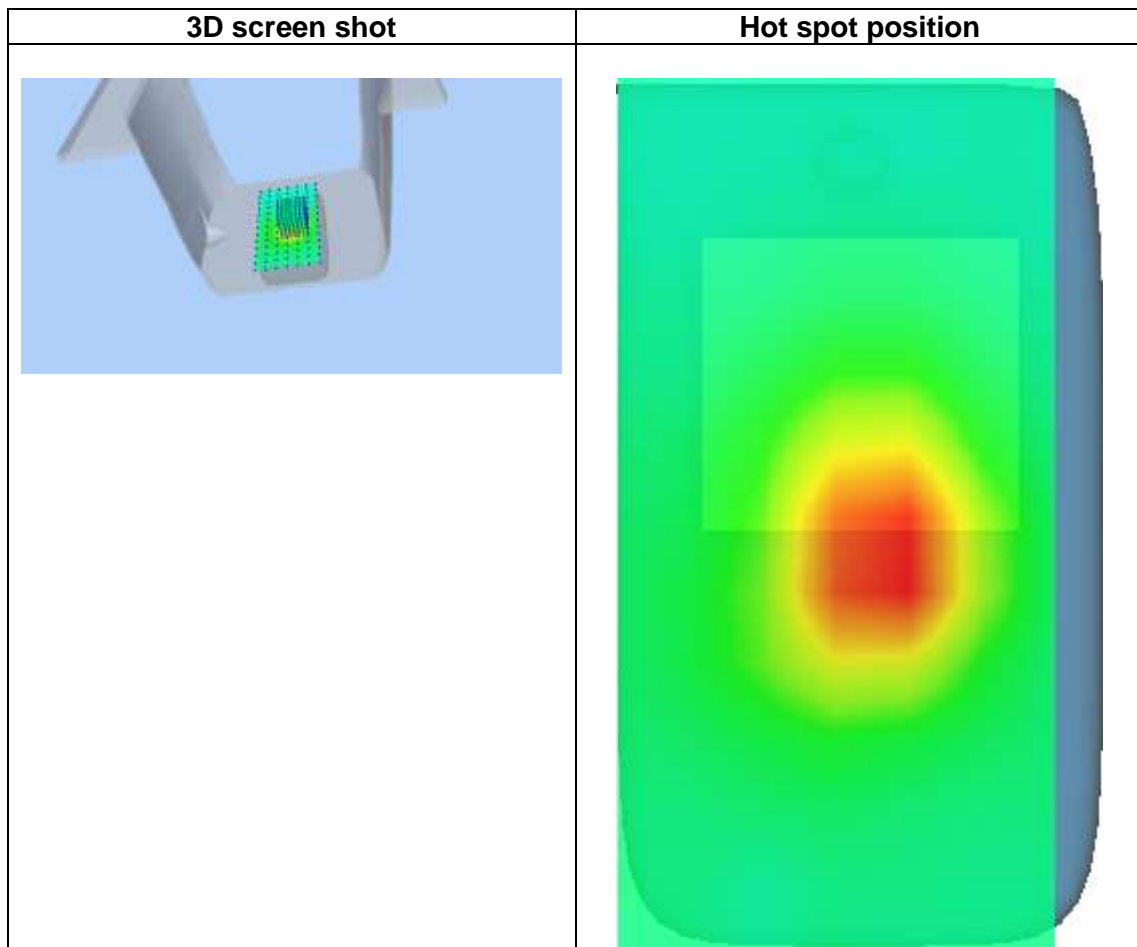
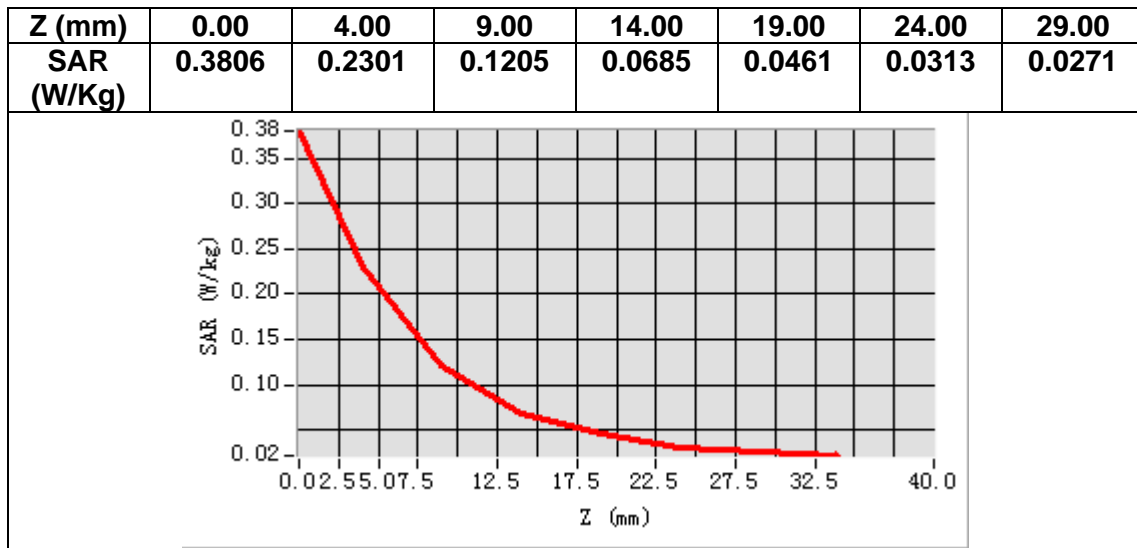

## 14. Appendix D. Calibration Certificate

<b>Table of contents</b>
E Field Probe - SN 41/18 EPGO330
E Field Probe - SN 07/15 EP247
835 MHz Dipole - SN 03/15 DIP 0G835-347
1800 MHz Dipole - SN 03/15 DIP 1G800-349
1900 MHz Dipole - SN 03/15 DIP 1G900-350
2300 MHz Dipole - SN 03/16 DIP 2G300-358
2450 MHz Dipole - SN 03/15 DIP 2G450-352
2600 MHz Dipole - SN 03/15 DIP 2G600-356
Extended Calibration Certificate



## COMOSAR E-Field Probe Calibration Report

Ref : ACR.142.6.20.SATU.B

**SHENZHEN NTEK TESTING TECHNOLOGY CO., LTD.  
BUILDING E, FENDA SCIENCE PARK, SANWEI  
COMMUNITY, XIXIANG STREET,  
BAO'AN DISTRICT, SHENZHEN GUANGDONG, CHINA  
MVG COMOSAR DOSIMETRIC E-FIELD PROBE  
SERIAL NO.: SN 41/18 EPGO330**

**Calibrated at MVG US  
2105 Barrett Park Dr. - Kennesaw, GA 30144**



**Calibration Date: 09/21/20**

*Summary:*

This document presents the method and results from an accredited COMOSAR Dosimetric E-Field Probe calibration performed in MVG USA using the CALISAR / CALIBAIR test bench, for use with a COMOSAR system only. All calibration results are traceable to national metrology institutions.



COMOSAR E-FIELD PROBE CALIBRATION REPORT

Ref: ACR.142.6.20.SATU.B

	<i>Name</i>	<i>Function</i>	<i>Date</i>	<i>Signature</i>
<i>Prepared by :</i>	Jérôme LUC	Product Manager	9/22/2020	<i>JS</i>
<i>Checked by :</i>	Jérôme LUC	Product Manager	9/22/2020	<i>JS</i>
<i>Approved by :</i>	Kim RUTKOWSKI	Quality Manager	9/22/2020	<i>Kim Rutkowski</i>

	<i>Customer Name</i>
<i>Distribution :</i>	SHENZHEN NTEK TESTING TECHNOLOGY CO., LTD.

<i>Issue</i>	<i>Date</i>	<i>Modifications</i>
A	9/22/2020	Initial release
B	9/27/2020	Change customer name and address



COMOSAR E-FIELD PROBE CALIBRATION REPORT

Ref: ACR-142.6.20.SATU.B

TABLE OF CONTENTS

1 Device Under Test ..... 4

2 Product Description ..... 4

    2.1 General Information ..... 4

3 Measurement Method ..... 4

    3.1 Linearity ..... 4

    3.2 Sensitivity ..... 5

    3.3 Lower Detection Limit ..... 5

    3.4 Isotropy ..... 5

    3.5 Boundary Effect ..... 5

4 Measurement Uncertainty ..... 5

5 Calibration Measurement Results ..... 6

    5.1 Sensitivity in air ..... 6

    5.2 Linearity ..... 7

    5.3 Sensitivity in liquid ..... 7

    5.4 Isotropy ..... 8

6 List of Equipment ..... 10





COMOSAR E-FIELD PROBE CALIBRATION REPORT

Ref: ACR.142.6.20.SATU.B

**1 DEVICE UNDER TEST**

Device Under Test	
Device Type	COMOSAR DOSIMETRIC E FIELD PROBE
Manufacturer	MVG
Model	SSE2
Serial Number	SN 41/18 EPGO330
Product Condition (new / used)	Used
Frequency Range of Probe	0.15 GHz-6GHz
Resistance of Three Dipoles at Connector	Dipole 1: R1=0.186 MΩ Dipole 2: R2=0.191 MΩ Dipole 3: R3=0.201 MΩ

A yearly calibration interval is recommended.

**2 PRODUCT DESCRIPTION**

**2.1 GENERAL INFORMATION**

MVG’s COMOSAR E field Probes are built in accordance to the IEEE 1528, OET 65 Bulletin C and CEI/IEC 62209 standards.



**Figure 1 – MVG COMOSAR Dosimetric E field Dipole**

Probe Length	330 mm
Length of Individual Dipoles	2 mm
Maximum external diameter	8 mm
Probe Tip External Diameter	2.5 mm
Distance between dipoles / probe extremity	1 mm

**3 MEASUREMENT METHOD**

The IEEE 1528, OET 65 Bulletin C, CENELEC EN50361 and CEI/IEC 62209 standards provide recommended practices for the probe calibrations, including the performance characteristics of interest and methods by which to assess their affect. All calibrations / measurements performed meet the fore mentioned standards.

**3.1 LINEARITY**

The evaluation of the linearity was done in free space using the waveguide, performing a power sweep to cover the SAR range 0.01W/kg to 100W/kg.



**COMOSAR E-FIELD PROBE CALIBRATION REPORT**

Ref: ACR-142.6.20.SATU.B

**3.2 SENSITIVITY**

The sensitivity factors of the three dipoles were determined using a two step calibration method (air and tissue simulating liquid) using waveguides as outlined in the standards.

**3.3 LOWER DETECTION LIMIT**

The lower detection limit was assessed using the same measurement set up as used for the linearity measurement. The required lower detection limit is 10 mW/kg.

**3.4 ISOTROPY**

The axial isotropy was evaluated by exposing the probe to a reference wave from a standard dipole with the dipole mounted under the flat phantom in the test configuration suggested for system validations and checks. The probe was rotated along its main axis from 0 - 360 degrees in 15 degree steps. The hemispherical isotropy is determined by inserting the probe in a thin plastic box filled with tissue-equivalent liquid, with the plastic box illuminated with the fields from a half wave dipole. The dipole is rotated about its axis (0°-180°) in 15° increments. At each step the probe is rotated about its axis (0°-360°).

**3.5 BOUNDARY EFFECT**

The boundary effect is defined as the deviation between the SAR measured data and the expected exponential decay in the liquid when the probe is oriented normal to the interface. To evaluate this effect, the liquid filled flat phantom is exposed to fields from either a reference dipole or waveguide. With the probe normal to the phantom surface, the peak spatial average SAR is measured and compared to the analytical value at the surface.

**4 MEASUREMENT UNCERTAINTY**

The guidelines outlined in the IEEE 1528, OET 65 Bulletin C, CENELEC EN50361 and CEI/IEC 62209 standards were followed to generate the measurement uncertainty associated with an E-field probe calibration using the waveguide technique. All uncertainties listed below represent an expanded uncertainty expressed at approximately the 95% confidence level using a coverage factor of k=2, traceable to the Internationally Accepted Guides to Measurement Uncertainty.

Uncertainty analysis of the probe calibration in waveguide					
ERROR SOURCES	Uncertainty value (%)	Probability Distribution	Divisor	ci	Standard Uncertainty (%)
Incident or forward power	3.00%	Rectangular	$\sqrt{3}$	1	1.732%
Reflected power	3.00%	Rectangular	$\sqrt{3}$	1	1.732%
Liquid conductivity	5.00%	Rectangular	$\sqrt{3}$	1	2.887%
Liquid permittivity	4.00%	Rectangular	$\sqrt{3}$	1	2.309%
Field homogeneity	3.00%	Rectangular	$\sqrt{3}$	1	1.732%
Field probe positioning	5.00%	Rectangular	$\sqrt{3}$	1	2.887%



COMOSAR E-FIELD PROBE CALIBRATION REPORT

Ref: ACR.142.6.20.SATU.B

Field probe linearity	3.00%	Rectangular	$\sqrt{3}$	1	1.732%
<b>Combined standard uncertainty</b>					5.831%
<b>Expanded uncertainty</b> 95 % confidence level k = 2					12.0%

5 CALIBRATION MEASUREMENT RESULTS

Calibration Parameters	
Liquid Temperature	21 °C
Lab Temperature	21 °C
Lab Humidity	45 %

5.1 SENSITIVITY IN AIR

Normx dipole 1 ( $\mu\text{V}/(\text{V}/\text{m})^2$ )	Normy dipole 2 ( $\mu\text{V}/(\text{V}/\text{m})^2$ )	Normz dipole 3 ( $\mu\text{V}/(\text{V}/\text{m})^2$ )
0.92	0.79	0.63

DCP dipole 1 (mV)	DCP dipole 2 (mV)	DCP dipole 3 (mV)
90	97	92

Calibration curves  $e_i=f(V)$  ( $i=1,2,3$ ) allow to obtain H-field value using the formula:

$$E = \sqrt{E_1^2 + E_2^2 + E_3^2}$$

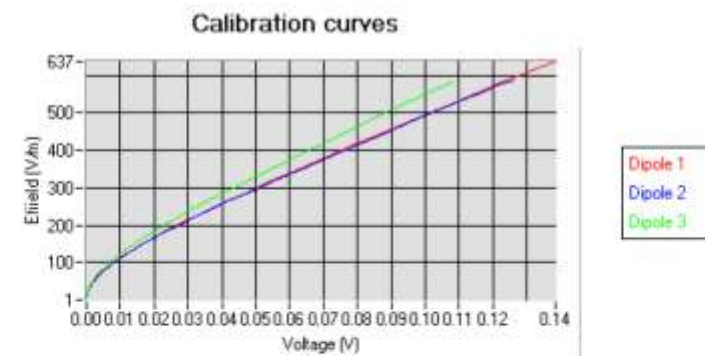



COMOSAR E-FIELD PROBE CALIBRATION REPORT

Ref: ACR.142.6.20.SATU.B

5.2 LINEARITY

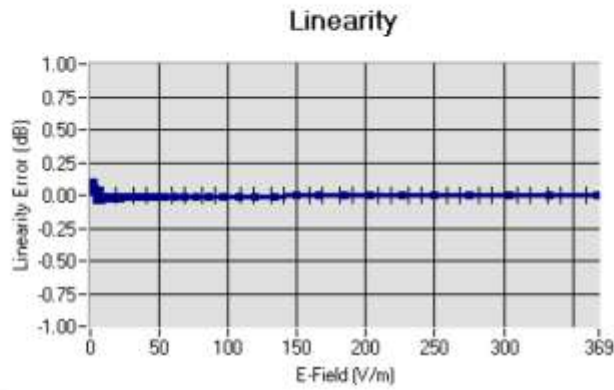

Linearity:  $\pm 2.36\%$  ( $\pm 0.10\text{dB}$ )

5.3 SENSITIVITY IN LIQUID

Liquid	Frequency (MHz +/- 100MHz)	Permittivity	Epsilon (S/m)	ConvF
HL750	750	40.76	0.93	1.54
BL750	750	56.70	0.98	1.59
HL850	835	40.86	0.92	1.60
BL850	835	56.35	0.99	1.64
HL900	900	42.84	0.95	1.61
BL900	900	53.25	1.05	1.65
HL1800	1800	39.56	1.40	1.74
BL1800	1800	52.84	1.45	1.81
HL1900	1900	39.67	1.38	2.03
BL1900	1900	52.84	1.59	2.08
HL2000	2000	38.71	1.42	1.86
BL2000	2000	52.03	1.52	1.92
HL2450	2450	38.72	1.80	2.05
BL2450	2450	54.91	1.97	2.12
HL2600	2600	39.98	1.89	2.06
BL2600	2600	54.42	2.18	2.11
HL5200	5200	36.68	4.45	1.85
BL5200	5200	49.02	5.46	1.92
HL5400	5400	36.08	4.69	1.75
BL5400	5400	49.55	5.53	1.83
HL5600	5600	35.34	4.95	1.88
BL5600	5600	47.60	5.77	1.95
HL5800	5800	34.81	5.08	1.89
BL5800	5800	47.81	6.12	1.94

LOWER DETECTION LIMIT: 9mW/kg



COMOSAR E-FIELD PROBE CALIBRATION REPORT

Ref: ACR-142.6.20.SATU.B

5.4 ISOTROPY

**HL900 MHz**

- Axial isotropy: 0.05 dB
- Hemispherical isotropy: 0.07 dB

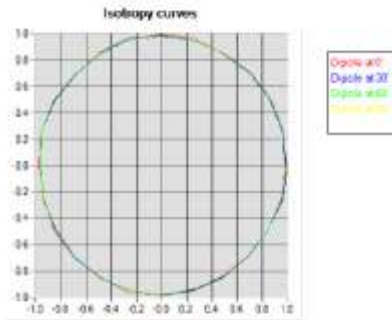

**HL1800 MHz**

- Axial isotropy: 0.06 dB
- Hemispherical isotropy: 0.07 dB

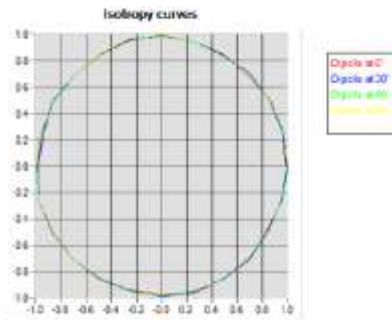



COMOSAR E-FIELD PROBE CALIBRATION REPORT

Ref: ACR-142.6.20.SATU.B

**HL5600 MHz**

- Axial isotropy: 0.06 dB
- Hemispherical isotropy: 0.09 dB

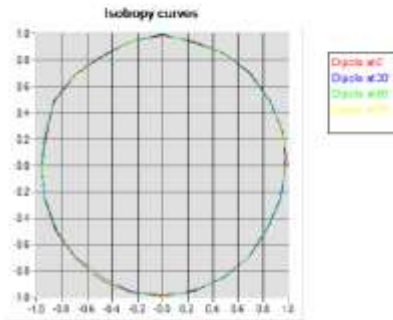



COMOSAR E-FIELD PROBE CALIBRATION REPORT

Ref: ACR.142.6.20.SATU.B

6 LIST OF EQUIPMENT

Equipment Summary Sheet				
Equipment Description	Manufacturer / Model	Identification No.	Current Calibration Date	Next Calibration Date
Flat Phantom	MVG	SN-20/09-SAM71	Validated. No cal required.	Validated. No cal required.
COMOSAR Test Bench	Version 3	NA	Validated. No cal required.	Validated. No cal required.
Network Analyzer	Rhode & Schwarz ZVA	SN100132	02/2019	02/2022
Reference Probe	MVG	EP 94 SN 37/08	10/2019	10/2020
Multimeter	Keithley 2000	1188656	01/2020	01/2023
Signal Generator	Agilent E4438C	MY49070581	01/2020	01/2023
Amplifier	Aethercomm	SN 046	Characterized prior to test. No cal required.	Characterized prior to test. No cal required.
Power Meter	HP E4418A	US38261498	01/2020	01/2023
Power Sensor	HP ECP-E26A	US37181460	01/2020	01/2023
Directional Coupler	Narda 4216-20	01386	Characterized prior to test. No cal required.	Characterized prior to test. No cal required.
Waveguide	Mega Industries	069Y7-158-13-712	Validated. No cal required.	Validated. No cal required.
Waveguide Transition	Mega Industries	069Y7-158-13-701	Validated. No cal required.	Validated. No cal required.
Waveguide Termination	Mega Industries	069Y7-158-13-701	Validated. No cal required.	Validated. No cal required.
Temperature / Humidity Sensor	Control Company	150798832	11/2020	11/2023



## COMOSAR E-Field Probe Calibration Report

Ref : ACR.139.5.20.SATU.A

**SHEN ZHEN NTEK TESTING TECHNOLOGY CO., LTD.**  
**BUILDING E, FENDA SCIENCE PARK,**  
**SANWEI COMMUNITY, XIXIANG STREET,**  
**BAO'AN DISTRICT, SHENZHEN GUANGDONG, CHINA**  
**MVG COMOSAR DOSIMETRIC E-FIELD PROBE**  
**SERIAL NO.: SN 07/15 EP247**

**Calibrated at MVG US**  
**2105 Barrett Park Dr. - Kennesaw, GA 30144**



**09/25/2020**

*Summary:*

This document presents the method and results from an accredited COMOSAR Dosimetric E-Field Probe calibration performed in MVG USA using the CALISAR / CALIBAIR test bench, for use with a COMOSAR system only. All calibration results are traceable to national metrology institutions.





COMOSAR E-FIELD PROBE CALIBRATION REPORT

Ref: ACR.159.5.20.SATU.A

	<i>Name</i>	<i>Function</i>	<i>Date</i>	<i>Signature</i>
<i>Prepared by :</i>	Jérôme LUC	Product Manager	09/25/2020	<i>JS</i>
<i>Checked by :</i>	Jérôme LUC	Product Manager	09/25/2020	<i>JS</i>
<i>Approved by :</i>	Kim RUTKOWSKI	Quality Manager	09/25/2020	<i>Kim Rutkowski</i>

	<i>Customer Name</i>
<i>Distribution :</i>	SHEN ZHEN NTEK TESTING TECHNOLOGY CO., LTD.

<i>Issue</i>	<i>Date</i>	<i>Modifications</i>
A	09/25/2020	Initial release



COMOSAR E-FIELD PROBE CALIBRATION REPORT

Ref: ACR.139.5.20.SATU.A

TABLE OF CONTENTS

1	Device Under Test .....	4
2	Product Description .....	4
2.1	General Information .....	4
3	Measurement Method .....	4
3.1	Linearity .....	4
3.2	Sensitivity .....	5
3.3	Lower Detection Limit .....	5
3.4	Isotropy .....	5
3.5	Boundary Effect .....	5
4	Measurement Uncertainty .....	5
5	Calibration Measurement Results .....	6
5.1	Sensitivity in air .....	6
5.2	Linearity .....	7
5.3	Sensitivity in liquid .....	7
5.4	Isotropy .....	8
6	List of Equipment .....	9



**COMOSAR E-FIELD PROBE CALIBRATION REPORT**

Ref: ACR.139.5.20.SATU.A

**1 DEVICE UNDER TEST**

Device Under Test	
Device Type	COMOSAR DOSIMETRIC E FIELD PROBE
Manufacturer	MVG
Model	SSE5
Serial Number	SN 07/15 EP247
Product Condition (new / used)	Used
Frequency Range of Probe	0.7 GHz-3GHz
Resistance of Three Dipoles at Connector	Dipole 1: R1=0.181 MΩ Dipole 2: R2=0.167 MΩ Dipole 3: R3=0.175 MΩ

A yearly calibration interval is recommended.

**2 PRODUCT DESCRIPTION**

**2.1 GENERAL INFORMATION**

MVG’s COMOSAR E field Probes are built in accordance to the IEEE 1528, OET 65 Bulletin C and CEI/IEC 62209 standards.



**Figure 1 – MVG COMOSAR Dosimetric E field Dipole**

Probe Length	330 mm
Length of Individual Dipoles	4.5 mm
Maximum external diameter	8 mm
Probe Tip External Diameter	5 mm
Distance between dipoles / probe extremity	2.7 mm

**3 MEASUREMENT METHOD**

The IEEE 1528, OET 65 Bulletin C, CENELEC EN50361 and CEI/IEC 62209 standards provide recommended practices for the probe calibrations, including the performance characteristics of interest and methods by which to assess their affect. All calibrations / measurements performed meet the fore mentioned standards.

**3.1 LINEARITY**

The evaluation of the linearity was done in free space using the waveguide, performing a power sweep to cover the SAR range 0.01W/kg to 100W/kg.



**COMOSAR E-FIELD PROBE CALIBRATION REPORT**

Ref: ACR.139.5.20.SATU.A

**3.2 SENSITIVITY**

The sensitivity factors of the three dipoles were determined using a two step calibration method (air and tissue simulating liquid) using waveguides as outlined in the standards.

**3.3 LOWER DETECTION LIMIT**

The lower detection limit was assessed using the same measurement set up as used for the linearity measurement. The required lower detection limit is 10 mW/kg.

**3.4 ISOTROPY**

The axial isotropy was evaluated by exposing the probe to a reference wave from a standard dipole with the dipole mounted under the flat phantom in the test configuration suggested for system validations and checks. The probe was rotated along its main axis from 0 - 360 degrees in 15 degree steps. The hemispherical isotropy is determined by inserting the probe in a thin plastic box filled with tissue-equivalent liquid, with the plastic box illuminated with the fields from a half wave dipole. The dipole is rotated about its axis (0°-180°) in 15° increments. At each step the probe is rotated about its axis (0°-360°).

**3.5 BOUNDARY EFFECT**

The boundary effect is defined as the deviation between the SAR measured data and the expected exponential decay in the liquid when the probe is oriented normal to the interface. To evaluate this effect, the liquid filled flat phantom is exposed to fields from either a reference dipole or waveguide. With the probe normal to the phantom surface, the peak spatial average SAR is measured and compared to the analytical value at the surface.

**4 MEASUREMENT UNCERTAINTY**

The guidelines outlined in the IEEE 1528, OET 65 Bulletin C, CENELEC EN50361 and CEI/IEC 62209 standards were followed to generate the measurement uncertainty associated with an E-field probe calibration using the waveguide technique. All uncertainties listed below represent an expanded uncertainty expressed at approximately the 95% confidence level using a coverage factor of k=2, traceable to the Internationally Accepted Guides to Measurement Uncertainty.

Uncertainty analysis of the probe calibration in waveguide					
ERROR SOURCES	Uncertainty value (%)	Probability Distribution	Divisor	ci	Standard Uncertainty (%)
Incident or forward power	3.00%	Rectangular	$\sqrt{3}$	1	1.732%
Reflected power	3.00%	Rectangular	$\sqrt{3}$	1	1.732%
Liquid conductivity	5.00%	Rectangular	$\sqrt{3}$	1	2.887%
Liquid permittivity	4.00%	Rectangular	$\sqrt{3}$	1	2.309%
Field homogeneity	3.00%	Rectangular	$\sqrt{3}$	1	1.732%
Field probe positioning	5.00%	Rectangular	$\sqrt{3}$	1	2.887%



COMOSAR E-FIELD PROBE CALIBRATION REPORT

Ref: ACR.139.5.20.SATU.A

Field probe linearity	3.00%	Rectangular	$\sqrt{3}$	1	1.732%
<b>Combined standard uncertainty</b>					5.831%
<b>Expanded uncertainty</b> 95 % confidence level k = 2					12.0%

5 CALIBRATION MEASUREMENT RESULTS

Calibration Parameters	
Liquid Temperature	21 °C
Lab Temperature	21 °C
Lab Humidity	45 %

5.1 SENSITIVITY IN AIR

Normx dipole 1 ( $\mu\text{V}/(\text{V}/\text{m})^2$ )	Normy dipole 2 ( $\mu\text{V}/(\text{V}/\text{m})^2$ )	Normz dipole 3 ( $\mu\text{V}/(\text{V}/\text{m})^2$ )
6.82	6.16	6.12

DCP dipole 1 (mV)	DCP dipole 2 (mV)	DCP dipole 3 (mV)
95	93	90

Calibration curves  $e_i=f(V)$  ( $i=1,2,3$ ) allow to obtain H-field value using the formula:

$$E = \sqrt{E_1^2 + E_2^2 + E_3^2}$$

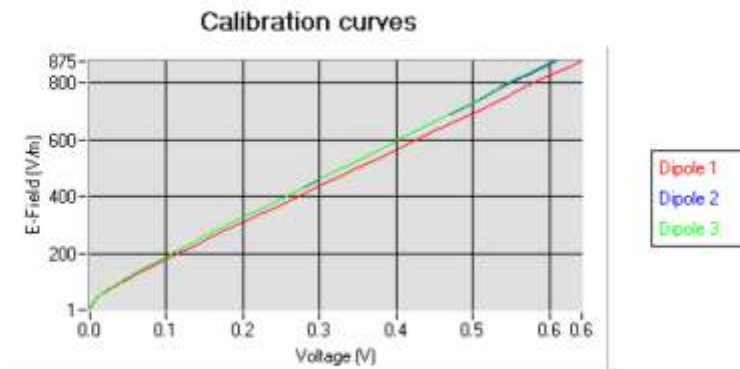



COMOSAR E-FIELD PROBE CALIBRATION REPORT

Ref: ACR-139.5.20.SATU-A

5.2 LINEARITY

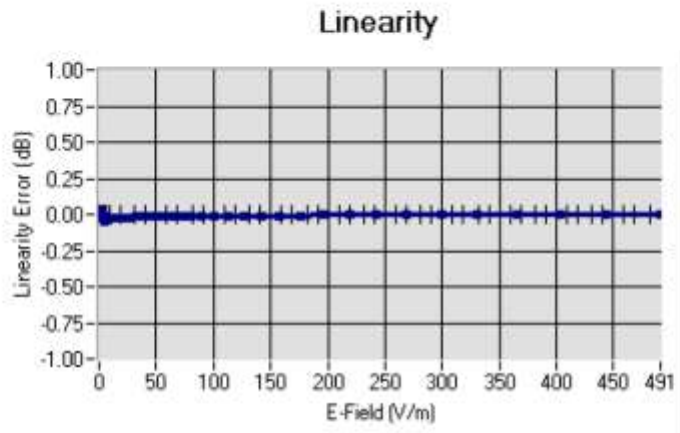

Linearity:  $\pm 1.05\%$  ( $\pm 0.05\text{dB}$ )

5.3 SENSITIVITY IN LIQUID

Liquid	Frequency (MHz +/- 100MHz)	Permittivity	Epsilon (S/m)	ConvF
HL450	450	43.68	0.87	5.01
BL450	450	58.34	0.99	5.35
HL750	750	41.82	0.90	4.23
BL750	750	56.28	0.98	4.39
HL850	835	42.59	0.90	4.54
BL850	835	53.19	0.97	4.71
HL900	900	42.05	0.98	4.25
BL900	900	56.41	1.08	4.39
HL1800	1800	41.82	1.38	3.77
BL1800	1800	53.00	1.52	3.85
HL1900	1900	40.38	1.41	4.27
BL1900	1900	53.93	1.55	4.39
HL2300	2300	40.12	1.43	3.90
BL2300	2300	53.65	1.54	4.05
HL2450	2450	38.34	1.80	3.72
BL2450	2450	52.70	1.94	3.84
HL2600	2600	38.16	1.93	3.65
BL2600	2600	51.55	2.21	3.75

LOWER DETECTION LIMIT: 8mW/kg



COMOSAR E-FIELD PROBE CALIBRATION REPORT

Ref: ACR.139.5.20.SATU.A

5.4 ISOTROPY

**HL900 MHz**

- Axial isotropy: 0.04 dB
- Hemispherical isotropy: 0.05 dB

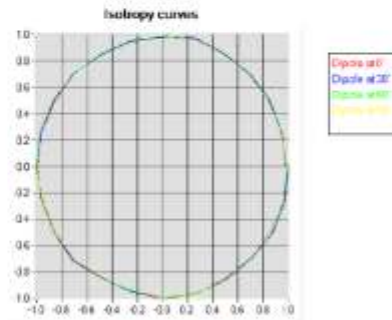

**HL1800 MHz**

- Axial isotropy: 0.05 dB
- Hemispherical isotropy: 0.08 dB

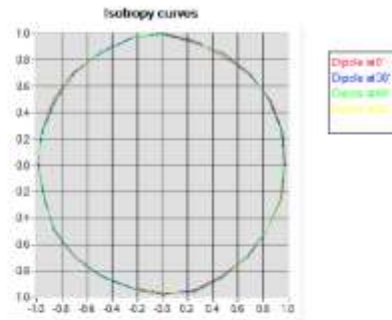



COMOSAR E-FIELD PROBE CALIBRATION REPORT

Ref: ACR.139.5.20.SATU.A

6 LIST OF EQUIPMENT

Equipment Summary Sheet				
Equipment Description	Manufacturer / Model	Identification No.	Current Calibration Date	Next Calibration Date
Flat Phantom	MVG	SN-20/09-SAM71	Validated. No cal required.	Validated. No cal required.
COMOSAR Test Bench	Version 3	NA	Validated. No cal required.	Validated. No cal required.
Network Analyzer	Rhode & Schwarz ZVA	SN100132	02/2019	02/2022
Reference Probe	MVG	EP 94 SN 37/08	10/2019	10/2020
Multimeter	Keithley 2000	1188656	01/2020	01/2023
Signal Generator	Agilent E4438C	MY49070581	01/2020	01/2023
Amplifier	Aethercomm	SN 046	Characterized prior to test. No cal required.	Characterized prior to test. No cal required.
Power Meter	HP E4418A	US38261498	01/2020	01/2023
Power Sensor	HP ECP-E26A	US37181460	01/2020	01/2023
Directional Coupler	Narda 4216-20	01386	Characterized prior to test. No cal required.	Characterized prior to test. No cal required.
Waveguide	Mega Industries	069Y7-158-13-712	Validated. No cal required.	Validated. No cal required.
Waveguide Transition	Mega Industries	069Y7-158-13-701	Validated. No cal required.	Validated. No cal required.
Waveguide Termination	Mega Industries	069Y7-158-13-701	Validated. No cal required.	Validated. No cal required.
Temperature / Humidity Sensor	Control Company	11-661-9	11/2020	11/2023





## SAR Reference Dipole Calibration Report

Ref : ACR.109.2.18.SATU.A

### **SHENZHEN NTEK TESTING TECHNOLOGY CO., LTD.**

**BUILDING E, FENDA SCIENCE PARK, SANWEI  
COMMUNITY, XIXIANG STREET,  
BAO'AN DISTRICT, SHENZHEN GUANGDONG, CHINA**

#### **MVG COMOSAR REFERENCE DIPOLE**

**FREQUENCY: 835 MHZ**

**SERIAL NO.: SN 03/15 DIP 0G835-347**

**Calibrated at MVG US**

**2105 Barrett Park Dr. - Kennesaw, GA 30144**



**Calibration Date: 04/19/2018**

#### *Summary:*

This document presents the method and results from an accredited SAR reference dipole calibration performed in MVG USA using the COMOSAR test bench. All calibration results are traceable to national metrology institutions.



SAR REFERENCE DIPOLE CALIBRATION REPORT

Ref: ACR.109.2.18.SATU.A

	<i>Name</i>	<i>Function</i>	<i>Date</i>	<i>Signature</i>
<i>Prepared by :</i>	Jérôme LUC	Product Manager	4/19/2018	<i>JS</i>
<i>Checked by :</i>	Jérôme LUC	Product Manager	4/19/2018	<i>JS</i>
<i>Approved by :</i>	Kim RUTKOWSKI	Quality Manager	4/19/2018	<i>Kim Rutkowski</i>

	<i>Customer Name</i>
<i>Distribution :</i>	SHENZHEN NTEK TESTING TECHNOLOGY CO., LTD.

<i>Issue</i>	<i>Date</i>	<i>Modifications</i>
A	4/19/2018	Initial release



SAR REFERENCE DIPOLE CALIBRATION REPORT

Ref: ACR.109.2.18.SATU.A

TABLE OF CONTENTS

1	Introduction.....	4
2	Device Under Test .....	4
3	Product Description .....	4
3.1	General Information .....	4
4	Measurement Method .....	5
4.1	Return Loss Requirements .....	5
4.2	Mechanical Requirements .....	5
5	Measurement Uncertainty .....	5
5.1	Return Loss .....	5
5.2	Dimension Measurement .....	5
5.3	Validation Measurement .....	5
6	Calibration Measurement Results .....	6
6.1	Return Loss and Impedance In Head Liquid .....	6
6.2	Return Loss and Impedance In Body Liquid .....	6
6.3	Mechanical Dimensions .....	6
7	Validation measurement .....	7
7.1	Head Liquid Measurement .....	7
7.2	SAR Measurement Result With Head Liquid .....	8
7.3	Body Liquid Measurement .....	9
7.4	SAR Measurement Result With Body Liquid .....	10
8	List of Equipment .....	11



**SAR REFERENCE DIPOLE CALIBRATION REPORT**

Ref: ACR.109.2.18.SATU.A

**1 INTRODUCTION**

This document contains a summary of the requirements set forth by the IEEE 1528, FCC KDBs and CEI/IEC 62209 standards for reference dipoles used for SAR measurement system validations and the measurements that were performed to verify that the product complies with the fore mentioned standards.

**2 DEVICE UNDER TEST**

Device Under Test	
Device Type	COMOSAR 835 MHz REFERENCE DIPOLE
Manufacturer	MVG
Model	SID835
Serial Number	SN 03/15 DIP 0G835-347
Product Condition (new / used)	Used

A yearly calibration interval is recommended.

**3 PRODUCT DESCRIPTION**

**3.1 GENERAL INFORMATION**

MVG's COMOSAR Validation Dipoles are built in accordance to the IEEE 1528, FCC KDBs and CEI/IEC 62209 standards. The product is designed for use with the COMOSAR test bench only.



**Figure 1 – MVG COMOSAR Validation Dipole**



**4 MEASUREMENT METHOD**

The IEEE 1528, FCC KDBs and CEI/IEC 62209 standards provide requirements for reference dipoles used for system validation measurements. The following measurements were performed to verify that the product complies with the fore mentioned standards.

**4.1 RETURN LOSS REQUIREMENTS**

The dipole used for SAR system validation measurements and checks must have a return loss of -20 dB or better. The return loss measurement shall be performed against a liquid filled flat phantom, with the phantom constructed as outlined in the fore mentioned standards.

**4.2 MECHANICAL REQUIREMENTS**

The IEEE Std. 1528 and CEI/IEC 62209 standards specify the mechanical components and dimensions of the validation dipoles, with the dimensions frequency and phantom shell thickness dependent. The COMOSAR test bench employs a 2 mm phantom shell thickness therefore the dipoles sold for use with the COMOSAR test bench comply with the requirements set forth for a 2 mm phantom shell thickness.

**5 MEASUREMENT UNCERTAINTY**

All uncertainties listed below represent an expanded uncertainty expressed at approximately the 95% confidence level using a coverage factor of k=2, traceable to the Internationally Accepted Guides to Measurement Uncertainty.

**5.1 RETURN LOSS**

The following uncertainties apply to the return loss measurement:

Frequency band	Expanded Uncertainty on Return Loss
400-6000MHz	0.1 dB

**5.2 DIMENSION MEASUREMENT**

The following uncertainties apply to the dimension measurements:

Length (mm)	Expanded Uncertainty on Length
3 - 300	0.05 mm

**5.3 VALIDATION MEASUREMENT**

The guidelines outlined in the IEEE 1528, FCC KDBs, CENELEC EN50361 and CEI/IEC 62209 standards were followed to generate the measurement uncertainty for validation measurements.

Scan Volume	Expanded Uncertainty
1 g	20.3 %



SAR REFERENCE DIPOLE CALIBRATION REPORT

Ref: ACR.109.2.18.SATU.A

10 g	20.1 %
------	--------

6 CALIBRATION MEASUREMENT RESULTS

6.1 RETURN LOSS AND IMPEDANCE IN HEAD LIQUID

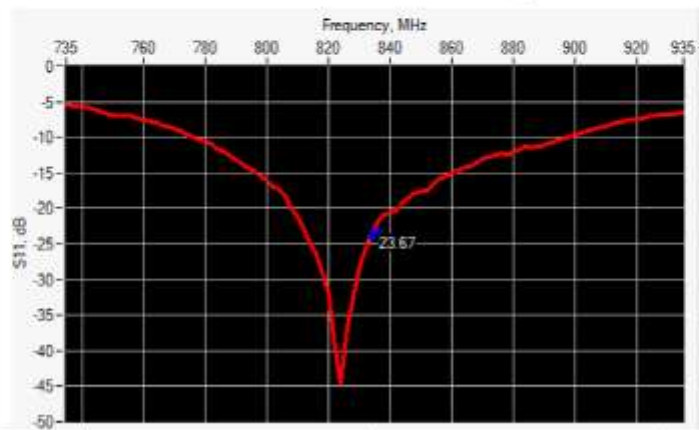

Frequency (MHz)	Return Loss (dB)	Requirement (dB)	Impedance
835	-23.67	-20	56.8 Ω - 1.5 jΩ

6.2 RETURN LOSS AND IMPEDANCE IN BODY LIQUID

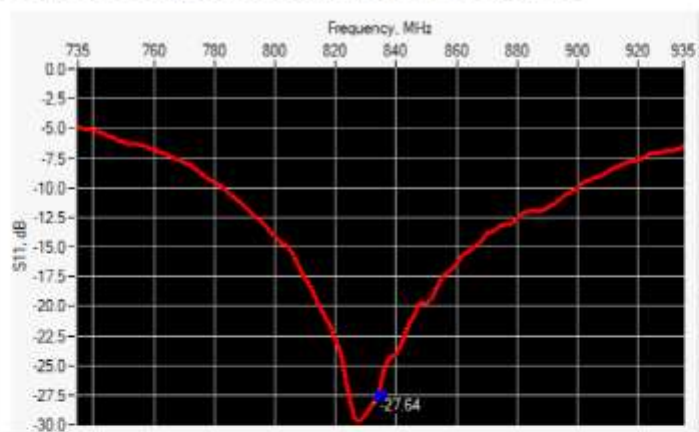

Frequency (MHz)	Return Loss (dB)	Requirement (dB)	Impedance
835	-27.64	-20	53.5 Ω + 2.3 jΩ

6.3 MECHANICAL DIMENSIONS

Frequency MHz	L mm		h mm		d mm	
	required	measured	required	measured	required	measured
300	420.0 ±1 %		250.0 ±1 %		6.35 ±1 %	



SAR REFERENCE DIPOLE CALIBRATION REPORT

Ref: ACR.109.2.18.SATU.A

450	290.0 ±1 %		166.7 ±1 %		6.35 ±1 %	
750	176.0 ±1 %		100.0 ±1 %		6.35 ±1 %	
835	161.0 ±1 %	PASS	89.8 ±1 %	PASS	3.6 ±1 %	PASS
900	149.0 ±1 %		83.3 ±1 %		3.6 ±1 %	
1450	89.1 ±1 %		51.7 ±1 %		3.6 ±1 %	
1500	80.5 ±1 %		50.0 ±1 %		3.6 ±1 %	
1640	79.0 ±1 %		45.7 ±1 %		3.6 ±1 %	
1750	75.2 ±1 %		42.9 ±1 %		3.6 ±1 %	
1800	72.0 ±1 %		41.7 ±1 %		3.6 ±1 %	
1900	68.0 ±1 %		39.5 ±1 %		3.6 ±1 %	
1950	66.3 ±1 %		38.5 ±1 %		3.6 ±1 %	
2000	64.5 ±1 %		37.5 ±1 %		3.6 ±1 %	
2100	61.0 ±1 %		35.7 ±1 %		3.6 ±1 %	
2300	55.5 ±1 %		32.6 ±1 %		3.6 ±1 %	
2450	51.5 ±1 %		30.4 ±1 %		3.6 ±1 %	
2600	48.5 ±1 %		28.8 ±1 %		3.6 ±1 %	
3000	41.5 ±1 %		25.0 ±1 %		3.6 ±1 %	
3500	37.0 ±1 %		26.4 ±1 %		3.6 ±1 %	
3700	34.7 ±1 %		26.4 ±1 %		3.6 ±1 %	

7 VALIDATION MEASUREMENT

The IEEE Std. 1528, FCC KDBs and CE/IEC 62209 standards state that the system validation measurements must be performed using a reference dipole meeting the fore mentioned return loss and mechanical dimension requirements. The validation measurement must be performed against a liquid filled flat phantom, with the phantom constructed as outlined in the fore mentioned standards. Per the standards, the dipole shall be positioned below the bottom of the phantom, with the dipole length centered and parallel to the longest dimension of the flat phantom, with the top surface of the dipole at the described distance from the bottom surface of the phantom.

7.1 HEAD LIQUID MEASUREMENT

Frequency MHz	Relative permittivity (ε <sub>r</sub> )		Conductivity (σ) S/m	
	required	measured	required	measured
300	45.3 ±5 %		0.87 ±5 %	
450	43.5 ±5 %		0.87 ±5 %	
750	41.9 ±5 %		0.89 ±5 %	
835	41.5 ±5 %	PASS	0.90 ±5 %	PASS
900	41.5 ±5 %		0.97 ±5 %	
1450	40.5 ±5 %		1.20 ±5 %	
1500	40.4 ±5 %		1.23 ±5 %	
1640	40.2 ±5 %		1.31 ±5 %	
1750	40.1 ±5 %		1.37 ±5 %	

Page: 7/11

*This document shall not be reproduced, except in full or in part, without the written approval of MVG. The information contained herein is to be used only for the purpose for which it is submitted and is not to be released in whole or part without written approval of MVG.*



SAR REFERENCE DIPOLE CALIBRATION REPORT

Ref: ACR.109.2.18.SATU.A

1800	40.0 ±5 %		1.40 ±5 %	
1900	40.0 ±5 %		1.40 ±5 %	
1950	40.0 ±5 %		1.40 ±5 %	
2000	40.0 ±5 %		1.40 ±5 %	
2100	39.8 ±5 %		1.49 ±5 %	
2300	39.5 ±5 %		1.67 ±5 %	
2450	39.2 ±5 %		1.80 ±5 %	
2600	39.0 ±5 %		1.96 ±5 %	
3000	38.5 ±5 %		2.40 ±5 %	
3500	37.9 ±5 %		2.91 ±5 %	

7.2 SAR MEASUREMENT RESULT WITH HEAD LIQUID

The IEEE Std. 1528 and CEI/IEC 62209 standards state that the system validation measurements should produce the SAR values shown below (for phantom thickness of 2 mm), within the uncertainty for the system validation. All SAR values are normalized to 1 W forward power. In bracket, the measured SAR is given with the used input power.

Software	OPENSAR V4
Phantom	SN 20/09 SAM71
Probe	SN 18/11 EPG122
Liquid	Head Liquid Values: eps' : 40.0 sigma : 0.90
Distance between dipole center and liquid	15.0 mm
Area scan resolution	dx=8mm/dy=8mm
Zoon Scan Resolution	dx=8mm/dy=8mm/dz=5mm
Frequency	835 MHz
Input power	20 dBm
Liquid Temperature	21 °C
Lab Temperature	21 °C
Lab Humidity	45 %

Frequency MHz	1 g SAR (W/kg/W)		10 g SAR (W/kg/W)	
	required	measured	required	measured
300	2.85		1.94	
450	4.58		3.06	
750	8.49		5.55	
835	9.56	9.55 (0.95)	6.22	6.10 (0.61)
900	10.9		6.99	
1450	29		16	
1500	30.5		16.8	
1640	34.2		18.4	
1750	36.4		19.3	
1800	38.4		20.1	





**SAR REFERENCE DIPOLE CALIBRATION REPORT**

Ref: ACR.109.2.18.SATU.A

1900	39.7		20.5	
1950	40.5		20.9	
2000	41.1		21.1	
2100	43.6		21.9	
2300	48.7		23.3	
2450	52.4		24	
2600	55.3		24.6	
3000	63.8		25.7	
3500	67.1		25	
3700	67.4		24.2	

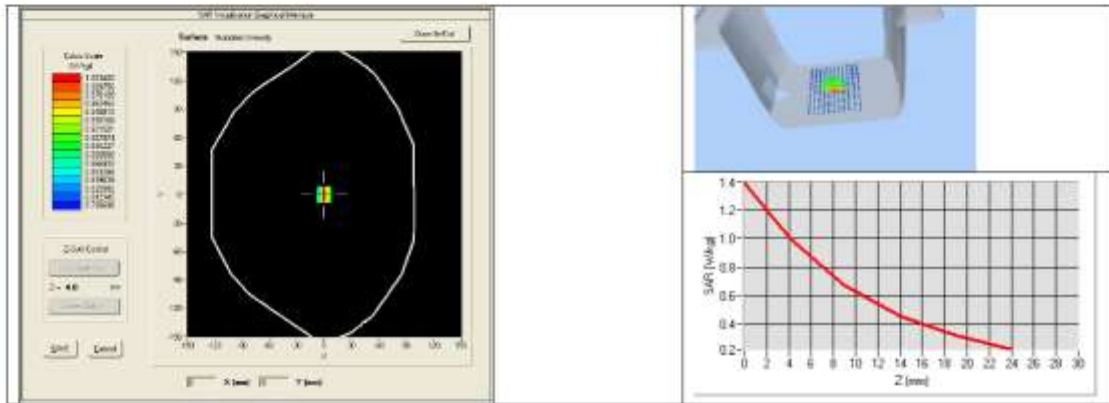

**7.3 BODY LIQUID MEASUREMENT**

Frequency MHz	Relative permittivity ( $\epsilon_r'$ )		Conductivity ( $\sigma$ ) S/m	
	required	measured	required	measured
150	61.9 ±5 %		0.80 ±5 %	
300	58.2 ±5 %		0.92 ±5 %	
450	56.7 ±5 %		0.94 ±5 %	
750	55.5 ±5 %		0.96 ±5 %	
835	55.2 ±5 %	PASS	0.97 ±5 %	PASS
900	55.0 ±5 %		1.05 ±5 %	
915	55.0 ±5 %		1.06 ±5 %	
1450	54.0 ±5 %		1.30 ±5 %	
1610	53.8 ±5 %		1.40 ±5 %	
1800	53.3 ±5 %		1.52 ±5 %	
1900	53.3 ±5 %		1.52 ±5 %	
2000	53.3 ±5 %		1.52 ±5 %	
2100	53.2 ±5 %		1.62 ±5 %	

Page: 9/11

*This document shall not be reproduced, except in full or in part, without the written approval of MVG. The information contained herein is to be used only for the purpose for which it is submitted and is not to be released in whole or part without written approval of MVG.*



**SAR REFERENCE DIPOLE CALIBRATION REPORT**

Ref: ACR.199.2.18.SATUA

2300	52.9 ±5 %		1.81 ±5 %
2450	52.7 ±5 %		1.95 ±5 %
2600	52.5 ±5 %		2.16 ±5 %
3000	52.0 ±5 %		2.73 ±5 %
3500	51.3 ±5 %		3.31 ±5 %
3700	51.0 ±5 %		3.55 ±5 %
5200	49.0 ±10 %		5.30 ±10 %
5300	48.9 ±10 %		5.42 ±10 %
5400	48.7 ±10 %		5.53 ±10 %
5500	48.6 ±10 %		5.65 ±10 %
5600	48.5 ±10 %		5.77 ±10 %
5800	48.2 ±10 %		6.00 ±10 %

**7.4 SAR MEASUREMENT RESULT WITH BODY LIQUID**

Software	OPENSAR V4
Phantom	SN 20/09 SAM71
Probe	SN 18/11 EPG122
Liquid	Body Liquid Values: eps' : 57.5 sigma : 0.96
Distance between dipole center and liquid	15.0 mm
Area scan resolution	dx=8mm/dy=8mm
Zoon Scan Resolution	dx=8mm/dy=8mm/dz=5mm
Frequency	835 MHz
Input power	20 dBm
Liquid Temperature	21 °C
Lab Temperature	21 °C
Lab Humidity	45 %

Frequency MHz	1 g SAR (W/kg/W)	10 g SAR (W/kg/W)
	measured	measured
835	9.83 (0.98)	6.45 (0.64)

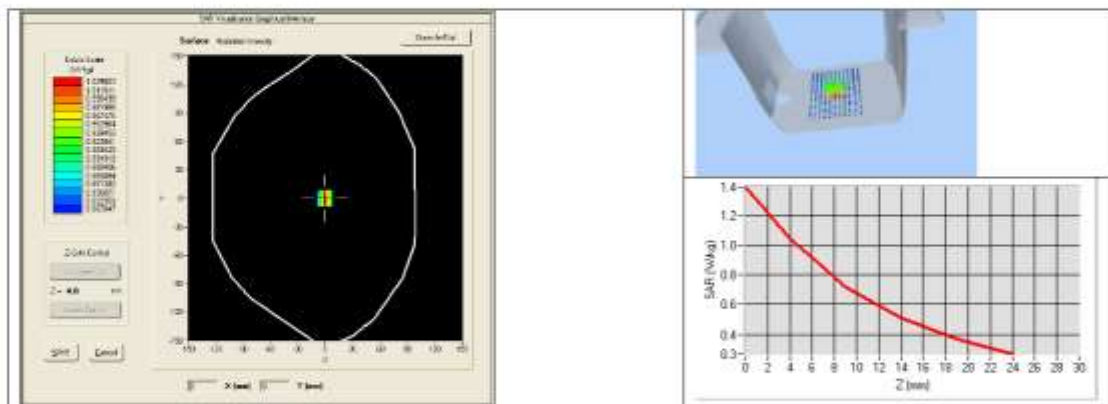



SAR REFERENCE DIPOLE CALIBRATION REPORT

Ref: ACR.109.2.18.SATU.A

8 LIST OF EQUIPMENT

Equipment Summary Sheet				
Equipment Description	Manufacturer / Model	Identification No.	Current Calibration Date	Next Calibration Date
SAM Phantom	MVG	SN-20/09-SAM71	Validated. No cal required.	Validated. No cal required.
COMOSAR Test Bench	Version 3	NA	Validated. No cal required.	Validated. No cal required.
Network Analyzer	Rhode & Schwarz ZVA	SN100132	02/2016	02/2019
Calipers	Carrera	CALIPER-01	01/2017	01/2020
Reference Probe	MVG	EPG122 SN 18/11	10/2017	10/2018
Multimeter	Keithley 2000	1188656	01/2017	01/2020
Signal Generator	Agilent E4438C	MY49070581	01/2017	01/2020
Amplifier	Aethercomm	SN 046	Characterized prior to test. No cal required.	Characterized prior to test. No cal required.
Power Meter	HP E4418A	US38261498	01/2017	01/2020
Power Sensor	HP ECP-E26A	US37181460	01/2017	01/2020
Directional Coupler	Narda 4216-20	01386	Characterized prior to test. No cal required.	Characterized prior to test. No cal required.
Temperature and Humidity Sensor	Control Company	150798832	11/2017	11/2020



## SAR Reference Dipole Calibration Report

Ref : ACR.109.4.18.SATU.A

### **SHENZHEN NTEK TESTING TECHNOLOGY CO., LTD.**

**BUILDING E, FENDA SCIENCE PARK, SANWEI  
COMMUNITY, XIXIANG STREET,  
BAO'AN DISTRICT, SHENZHEN GUANGDONG, CHINA**

#### **MVG COMOSAR REFERENCE DIPOLE**

**FREQUENCY: 1800 MHZ**

**SERIAL NO.: SN 03/15 DIP 1G800-349**

**Calibrated at MVG US**

**2105 Barrett Park Dr. - Kennesaw, GA 30144**



**Calibration Date: 04/19/2018**

#### *Summary:*

This document presents the method and results from an accredited SAR reference dipole calibration performed in MVG USA using the COMOSAR test bench. All calibration results are traceable to national metrology institutions.



SAR REFERENCE DIPOLE CALIBRATION REPORT

Ref: ACR.109.4.18.SATU.A

	<i>Name</i>	<i>Function</i>	<i>Date</i>	<i>Signature</i>
<i>Prepared by :</i>	Jérôme LUC	Product Manager	4/19/2018	<i>JL</i>
<i>Checked by :</i>	Jérôme LUC	Product Manager	4/19/2018	<i>JL</i>
<i>Approved by :</i>	Kim RUTKOWSKI	Quality Manager	4/19/2018	<i>Kim Rutkowski</i>

	<i>Customer Name</i>
<i>Distribution :</i>	SHENZHEN NTEK TESTING TECHNOLOGY CO., LTD.

<i>Issue</i>	<i>Date</i>	<i>Modifications</i>
A	4/19/2018	Initial release



SAR REFERENCE DIPOLE CALIBRATION REPORT

Ref: ACR.109.4.18.SATU.A

TABLE OF CONTENTS

1	Introduction.....	4
2	Device Under Test .....	4
3	Product Description .....	4
3.1	General Information .....	4
4	Measurement Method .....	5
4.1	Return Loss Requirements .....	5
4.2	Mechanical Requirements .....	5
5	Measurement Uncertainty .....	5
5.1	Return Loss .....	5
5.2	Dimension Measurement .....	5
5.3	Validation Measurement .....	5
6	Calibration Measurement Results .....	6
6.1	Return Loss and Impedance In Head Liquid .....	6
6.2	Return Loss and Impedance In Body Liquid .....	6
6.3	Mechanical Dimensions .....	6
7	Validation measurement .....	7
7.1	Head Liquid Measurement .....	7
7.2	SAR Measurement Result With Head Liquid .....	8
7.3	Body Liquid Measurement .....	9
7.4	SAR Measurement Result With Body Liquid .....	10
8	List of Equipment .....	11



SAR REFERENCE DIPOLE CALIBRATION REPORT

Ref: ACR.109.4.18.SATU.A

**1 INTRODUCTION**

This document contains a summary of the requirements set forth by the IEEE 1528, FCC KDBs and CEI/IEC 62209 standards for reference dipoles used for SAR measurement system validations and the measurements that were performed to verify that the product complies with the fore mentioned standards.

**2 DEVICE UNDER TEST**

Device Under Test	
Device Type	COMOSAR 1800 MHz REFERENCE DIPOLE
Manufacturer	MVG
Model	SID1800
Serial Number	SN 03/15 DIP 1G800-349
Product Condition (new / used)	Used

A yearly calibration interval is recommended.

**3 PRODUCT DESCRIPTION**

**3.1 GENERAL INFORMATION**

MVG's COMOSAR Validation Dipoles are built in accordance to the IEEE 1528, FCC KDBs and CEI/IEC 62209 standards. The product is designed for use with the COMOSAR test bench only.



**Figure 1 – MVG COMOSAR Validation Dipole**



**SAR REFERENCE DIPOLE CALIBRATION REPORT**

Ref: ACR.109.4.18.SATU.A

**4 MEASUREMENT METHOD**

The IEEE 1528, FCC KDBs and CEI/IEC 62209 standards provide requirements for reference dipoles used for system validation measurements. The following measurements were performed to verify that the product complies with the fore mentioned standards.

**4.1 RETURN LOSS REQUIREMENTS**

The dipole used for SAR system validation measurements and checks must have a return loss of -20 dB or better. The return loss measurement shall be performed against a liquid filled flat phantom, with the phantom constructed as outlined in the fore mentioned standards.

**4.2 MECHANICAL REQUIREMENTS**

The IEEE Std. 1528 and CEI/IEC 62209 standards specify the mechanical components and dimensions of the validation dipoles, with the dimensions frequency and phantom shell thickness dependent. The COMOSAR test bench employs a 2 mm phantom shell thickness therefore the dipoles sold for use with the COMOSAR test bench comply with the requirements set forth for a 2 mm phantom shell thickness.

**5 MEASUREMENT UNCERTAINTY**

All uncertainties listed below represent an expanded uncertainty expressed at approximately the 95% confidence level using a coverage factor of k=2, traceable to the Internationally Accepted Guides to Measurement Uncertainty.

**5.1 RETURN LOSS**

The following uncertainties apply to the return loss measurement:

Frequency band	Expanded Uncertainty on Return Loss
400-6000MHz	0.1 dB

**5.2 DIMENSION MEASUREMENT**

The following uncertainties apply to the dimension measurements:

Length (mm)	Expanded Uncertainty on Length
3 - 300	0.05 mm

**5.3 VALIDATION MEASUREMENT**

The guidelines outlined in the IEEE 1528, FCC KDBs, CENELEC EN50361 and CEI/IEC 62209 standards were followed to generate the measurement uncertainty for validation measurements.

Scan Volume	Expanded Uncertainty
1 g	20.3 %





**SAR REFERENCE DIPOLE CALIBRATION REPORT**

Ref: ACR.109.4.18.SATU.A

10 g	20.1 %
------	--------

**6 CALIBRATION MEASUREMENT RESULTS**

**6.1 RETURN LOSS AND IMPEDANCE IN HEAD LIQUID**

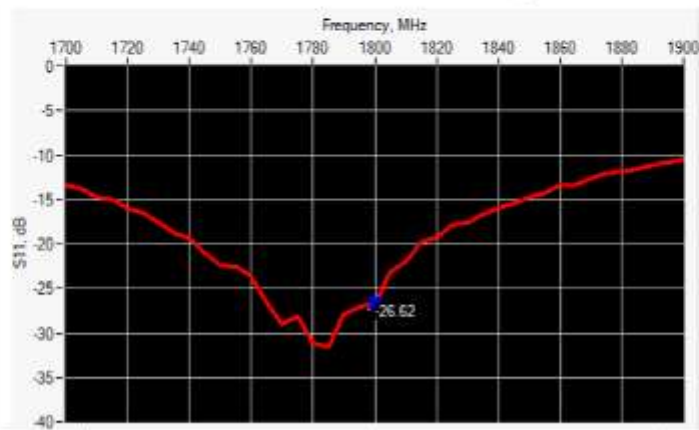

Frequency (MHz)	Return Loss (dB)	Requirement (dB)	Impedance
1800	-26.62	-20	47.3 Ω + 3.6 jΩ

**6.2 RETURN LOSS AND IMPEDANCE IN BODY LIQUID**

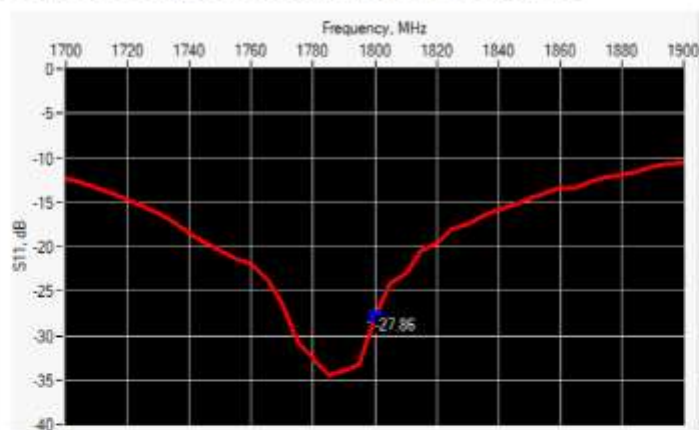

Frequency (MHz)	Return Loss (dB)	Requirement (dB)	Impedance
1800	-27.86	-20	46.2 Ω - 0.9 jΩ

**6.3 MECHANICAL DIMENSIONS**

Frequency MHz	L mm		h mm		d mm	
	required	measured	required	measured	required	measured
300	420.0 ±1 %		250.0 ±1 %		6.35 ±1 %	



**SAR REFERENCE DIPOLE CALIBRATION REPORT**

Ref: ACR.199.4.18.SATU.A

450	290.0 ±1 %		166.7 ±1 %		6.35 ±1 %	
750	176.0 ±1 %		100.0 ±1 %		6.35 ±1 %	
835	161.0 ±1 %		89.8 ±1 %		3.6 ±1 %	
900	149.0 ±1 %		83.3 ±1 %		3.6 ±1 %	
1450	89.1 ±1 %		51.7 ±1 %		3.6 ±1 %	
1500	80.5 ±1 %		50.0 ±1 %		3.6 ±1 %	
1640	79.0 ±1 %		45.7 ±1 %		3.6 ±1 %	
1750	75.2 ±1 %		42.9 ±1 %		3.6 ±1 %	
1800	72.0 ±1 %	PASS	41.7 ±1 %	PASS	3.6 ±1 %	PASS
1900	68.0 ±1 %		39.5 ±1 %		3.6 ±1 %	
1950	66.3 ±1 %		38.5 ±1 %		3.6 ±1 %	
2000	64.5 ±1 %		37.5 ±1 %		3.6 ±1 %	
2100	61.0 ±1 %		35.7 ±1 %		3.6 ±1 %	
2300	55.5 ±1 %		32.6 ±1 %		3.6 ±1 %	
2450	51.5 ±1 %		30.4 ±1 %		3.6 ±1 %	
2600	48.5 ±1 %		28.8 ±1 %		3.6 ±1 %	
3000	41.5 ±1 %		25.0 ±1 %		3.6 ±1 %	
3500	37.0 ±1 %		26.4 ±1 %		3.6 ±1 %	
3700	34.7 ±1 %		26.4 ±1 %		3.6 ±1 %	

**7 VALIDATION MEASUREMENT**

The IEEE Std. 1528, FCC KDBs and CEI/IEC 62209 standards state that the system validation measurements must be performed using a reference dipole meeting the fore mentioned return loss and mechanical dimension requirements. The validation measurement must be performed against a liquid filled flat phantom, with the phantom constructed as outlined in the fore mentioned standards. Per the standards, the dipole shall be positioned below the bottom of the phantom, with the dipole length centered and parallel to the longest dimension of the flat phantom, with the top surface of the dipole at the described distance from the bottom surface of the phantom.

**7.1 HEAD LIQUID MEASUREMENT**

Frequency MHz	Relative permittivity (ε <sub>r</sub> )		Conductivity (σ) S/m	
	required	measured	required	measured
300	45.3 ±5 %		0.87 ±5 %	
450	43.5 ±5 %		0.87 ±5 %	
750	41.9 ±5 %		0.89 ±5 %	
835	41.5 ±5 %		0.90 ±5 %	
900	41.5 ±5 %		0.97 ±5 %	
1450	40.5 ±5 %		1.20 ±5 %	
1500	40.4 ±5 %		1.23 ±5 %	
1640	40.2 ±5 %		1.31 ±5 %	
1750	40.1 ±5 %		1.37 ±5 %	

Page: 7/11

*This document shall not be reproduced, except in full or in part, without the written approval of MYG. The information contained herein is to be used only for the purpose for which it is submitted and is not to be released in whole or part without written approval of MYG.*



SAR REFERENCE DIPOLE CALIBRATION REPORT

Ref: ACR.109.4.18.SATU.A

1800	40.0 ±5 %	PASS	1.40 ±5 %	PASS
1900	40.0 ±5 %		1.40 ±5 %	
1950	40.0 ±5 %		1.40 ±5 %	
2000	40.0 ±5 %		1.40 ±5 %	
2100	39.8 ±5 %		1.49 ±5 %	
2300	39.5 ±5 %		1.67 ±5 %	
2450	39.2 ±5 %		1.80 ±5 %	
2600	39.0 ±5 %		1.96 ±5 %	
3000	38.5 ±5 %		2.40 ±5 %	
3500	37.9 ±5 %		2.91 ±5 %	

7.2 SAR MEASUREMENT RESULT WITH HEAD LIQUID

The IEEE Std. 1528 and CEI/IEC 62209 standards state that the system validation measurements should produce the SAR values shown below (for phantom thickness of 2 mm), within the uncertainty for the system validation. All SAR values are normalized to 1 W forward power. In bracket, the measured SAR is given with the used input power.

Software	OPENSAR V4
Phantom	SN 20/09 SAM71
Probe	SN 18/11 EPG122
Liquid	Head Liquid Values: eps' : 41.7 sigma : 1.46
Distance between dipole center and liquid	10.0 mm
Area scan resolution	dx=8mm/dy=8mm
Zoon Scan Resolution	dx=8mm/dy=8mm/dz=5mm
Frequency	1800 MHz
Input power	20 dBm
Liquid Temperature	21 °C
Lab Temperature	21 °C
Lab Humidity	45 %

Frequency MHz	1 g SAR (W/kg/W)		10 g SAR (W/kg/W)	
	required	measured	required	measured
300	2.85		1.94	
450	4.58		3.06	
750	8.49		5.55	
835	9.56		6.22	
900	10.9		6.99	
1450	29		16	
1500	30.5		16.8	
1640	34.2		18.4	
1750	36.4		19.3	
1800	38.4	38.11 (3.81)	20.1	20.05 (2.00)



**SAR REFERENCE DIPOLE CALIBRATION REPORT**

Ref: ACR.109.4.18.SATU.A

1900	39.7		20.5	
1950	40.5		20.9	
2000	41.1		21.1	
2100	43.6		21.9	
2300	48.7		23.3	
2450	52.4		24	
2600	55.3		24.6	
3000	63.8		25.7	
3500	67.1		25	
3700	67.4		24.2	

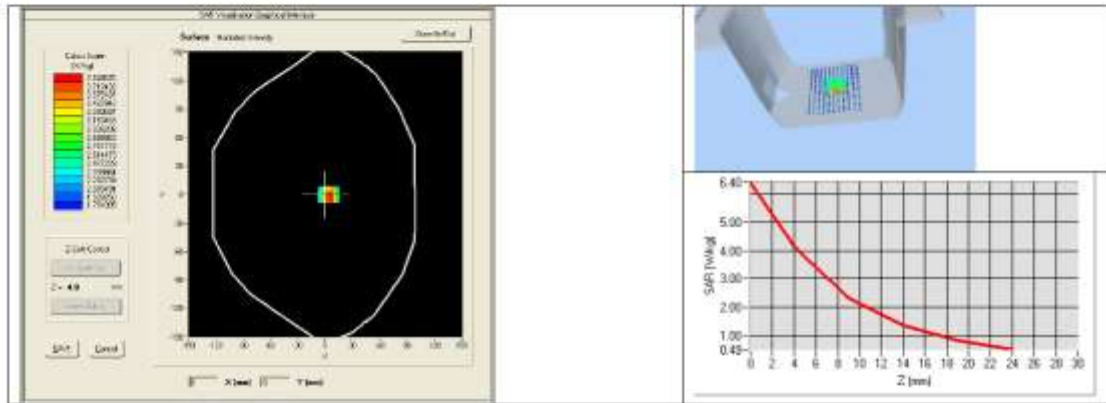

**7.3 BODY LIQUID MEASUREMENT**

Frequency MHz	Relative permittivity ( $\epsilon_r$ )		Conductivity ( $\sigma$ ) S/m	
	required	measured	required	measured
150	61.9 ± 5 %		0.80 ± 5 %	
300	58.2 ± 5 %		0.92 ± 5 %	
450	56.7 ± 5 %		0.94 ± 5 %	
750	55.5 ± 5 %		0.96 ± 5 %	
835	55.2 ± 5 %		0.97 ± 5 %	
900	55.0 ± 5 %		1.05 ± 5 %	
915	55.0 ± 5 %		1.06 ± 5 %	
1450	54.0 ± 5 %		1.30 ± 5 %	
1610	53.8 ± 5 %		1.40 ± 5 %	
1800	53.3 ± 5 %	PASS	1.52 ± 5 %	PASS
1900	53.3 ± 5 %		1.52 ± 5 %	
2000	53.3 ± 5 %		1.52 ± 5 %	
2100	53.2 ± 5 %		1.62 ± 5 %	

Page: 9/11

*This document shall not be reproduced, except in full or in part, without the written approval of MVG. The information contained herein is to be used only for the purpose for which it is submitted and is not to be released in whole or part without written approval of MVG.*



**SAR REFERENCE DIPOLE CALIBRATION REPORT**

Ref: ACR.109.4.18.SATU.A

2300	52.9 ±5 %		1.81 ±5 %
2450	52.7 ±5 %		1.95 ±5 %
2600	52.5 ±5 %		2.16 ±5 %
3000	52.0 ±5 %		2.73 ±5 %
3500	51.3 ±5 %		3.31 ±5 %
3700	51.0 ±5 %		3.55 ±5 %
5200	49.0 ±10 %		5.30 ±10 %
5300	48.9 ±10 %		5.42 ±10 %
5400	48.7 ±10 %		5.53 ±10 %
5500	48.6 ±10 %		5.65 ±10 %
5600	48.5 ±10 %		5.77 ±10 %
5800	48.2 ±10 %		6.00 ±10 %

**7.4 SAR MEASUREMENT RESULT WITH BODY LIQUID**

Software	OPENSAR V4
Phantom	SN 20/09 SAM71
Probe	SN 18/11 EPG122
Liquid	Body Liquid Values: eps' : 53.9 sigma : 1.46
Distance between dipole center and liquid	10.0 mm
Area scan resolution	dx=8mm/dy=8mm
Zoon Scan Resolution	dx=8mm/dy=8mm/dz=5mm
Frequency	1800 MHz
Input power	20 dBm
Liquid Temperature	21 °C
Lab Temperature	21 °C
Lab Humidity	45 %

Frequency MHz	1 g SAR (W/kg/W)	10 g SAR (W/kg/W)
	measured	measured
1800	38.13 (3.81)	20.65 (2.06)

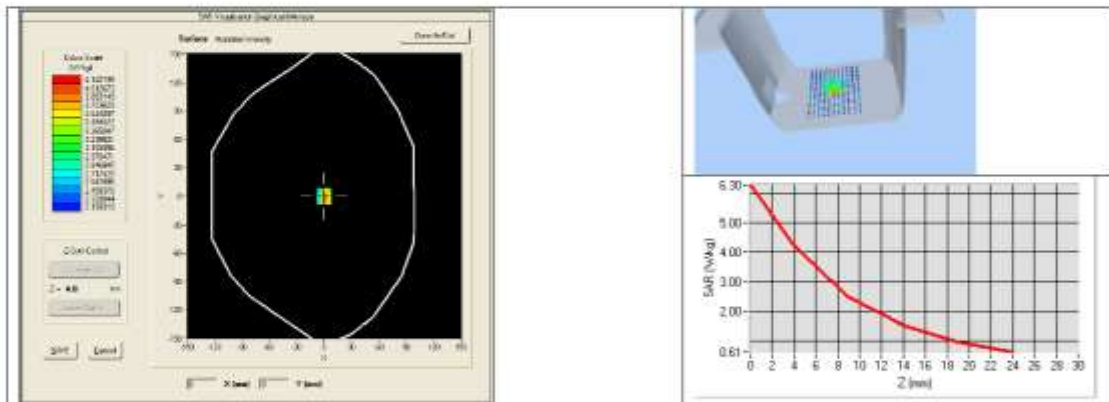



SAR REFERENCE DIPOLE CALIBRATION REPORT

Ref: ACR.109.4.18.SATU.A

8 LIST OF EQUIPMENT

Equipment Summary Sheet				
Equipment Description	Manufacturer / Model	Identification No.	Current Calibration Date	Next Calibration Date
SAM Phantom	MVG	SN-20/09-SAM71	Validated. No cal required.	Validated. No cal required.
COMOSAR Test Bench	Version 3	NA	Validated. No cal required.	Validated. No cal required.
Network Analyzer	Rhode & Schwarz ZVA	SN100132	02/2016	02/2019
Calipers	Carrera	CALIPER-01	01/2017	01/2020
Reference Probe	MVG	EPG122 SN 18/11	10/2017	10/2018
Multimeter	Keithley 2000	1188656	01/2017	01/2020
Signal Generator	Agilent E4438C	MY49070581	01/2017	01/2020
Amplifier	Aethercomm	SN 046	Characterized prior to test. No cal required.	Characterized prior to test. No cal required.
Power Meter	HP E4418A	US38261498	01/2017	01/2020
Power Sensor	HP ECP-E26A	US37181460	01/2017	01/2020
Directional Coupler	Narda 4216-20	01386	Characterized prior to test. No cal required.	Characterized prior to test. No cal required.
Temperature and Humidity Sensor	Control Company	150798832	11/2017	11/2020



## SAR Reference Dipole Calibration Report

Ref : ACR.109.5.18.SATU.A

**SHENZHEN NTEK TESTING TECHNOLOGY  
CO., LTD.**

**BUILDING E, FENDA SCIENCE PARK, SANWEI  
COMMUNITY, XIXIANG STREET,  
BAO'AN DISTRICT, SHENZHEN GUANGDONG, CHINA**

**MVG COMOSAR REFERENCE DIPOLE**

**FREQUENCY: 1900 MHZ**

**SERIAL NO.: SN 03/15 DIP 1G900-350**

**Calibrated at MVG US**

**2105 Barrett Park Dr. - Kennesaw, GA 30144**



**Calibration Date: 04/19/2018**

*Summary:*

This document presents the method and results from an accredited SAR reference dipole calibration performed in MVG USA using the COMOSAR test bench. All calibration results are traceable to national metrology institutions.



SAR REFERENCE DIPOLE CALIBRATION REPORT

Ref: ACR-109.5.18.SATUA

	<i>Name</i>	<i>Function</i>	<i>Date</i>	<i>Signature</i>
<i>Prepared by :</i>	Jérôme LUC	Product Manager	4/19/2018	<i>JL</i>
<i>Checked by :</i>	Jérôme LUC	Product Manager	4/19/2018	<i>JL</i>
<i>Approved by :</i>	Kim RUTKOWSKI	Quality Manager	4/19/2018	<i>Kim Rutkowski</i>

	<i>Customer Name</i>
<i>Distribution :</i>	SHENZHEN NTEK TESTING TECHNOLOGY CO., LTD.

<i>Issue</i>	<i>Date</i>	<i>Modifications</i>
A	4/19/2018	Initial release





SAR REFERENCE DIPOLE CALIBRATION REPORT

Ref. ACR-109.5.18.SATU.A

TABLE OF CONTENTS

1	Introduction.....	4
2	Device Under Test .....	4
3	Product Description .....	4
3.1	General Information .....	4
4	Measurement Method .....	5
4.1	Return Loss Requirements .....	5
4.2	Mechanical Requirements .....	5
5	Measurement Uncertainty.....	5
5.1	Return Loss .....	5
5.2	Dimension Measurement .....	5
5.3	Validation Measurement .....	5
6	Calibration Measurement Results.....	6
6.1	Return Loss and Impedance In Head Liquid .....	6
6.2	Return Loss and Impedance In Body Liquid .....	6
6.3	Mechanical Dimensions .....	6
7	Validation measurement .....	7
7.1	Head Liquid Measurement .....	7
7.2	SAR Measurement Result With Head Liquid .....	8
7.3	Body Liquid Measurement .....	9
7.4	SAR Measurement Result With Body Liquid .....	10
8	List of Equipment .....	11



SAR REFERENCE DIPOLE CALIBRATION REPORT

Ref: ACR.109.5.18.SATU.A

**1 INTRODUCTION**

This document contains a summary of the requirements set forth by the IEEE 1528, FCC KDBs and CEI/IEC 62209 standards for reference dipoles used for SAR measurement system validations and the measurements that were performed to verify that the product complies with the fore mentioned standards.

**2 DEVICE UNDER TEST**

Device Under Test	
Device Type	COMOSAR 1900 MHz REFERENCE DIPOLE
Manufacturer	MVG
Model	SID1900
Serial Number	SN 03/15 DIP 1G900-350
Product Condition (new / used)	Used

A yearly calibration interval is recommended.

**3 PRODUCT DESCRIPTION**

**3.1 GENERAL INFORMATION**

MVG’s COMOSAR Validation Dipoles are built in accordance to the IEEE 1528, FCC KDBs and CEI/IEC 62209 standards. The product is designed for use with the COMOSAR test bench only.



**Figure 1 – MVG COMOSAR Validation Dipole**



**SAR REFERENCE DIPOLE CALIBRATION REPORT**

Ref: ACR.109.5.18.SATU.A

**4 MEASUREMENT METHOD**

The IEEE 1528, FCC KDBs and CEI/IEC 62209 standards provide requirements for reference dipoles used for system validation measurements. The following measurements were performed to verify that the product complies with the fore mentioned standards.

**4.1 RETURN LOSS REQUIREMENTS**

The dipole used for SAR system validation measurements and checks must have a return loss of -20 dB or better. The return loss measurement shall be performed against a liquid filled flat phantom, with the phantom constructed as outlined in the fore mentioned standards.

**4.2 MECHANICAL REQUIREMENTS**

The IEEE Std. 1528 and CEI/IEC 62209 standards specify the mechanical components and dimensions of the validation dipoles, with the dimensions frequency and phantom shell thickness dependent. The COMOSAR test bench employs a 2 mm phantom shell thickness therefore the dipoles sold for use with the COMOSAR test bench comply with the requirements set forth for a 2 mm phantom shell thickness.

**5 MEASUREMENT UNCERTAINTY**

All uncertainties listed below represent an expanded uncertainty expressed at approximately the 95% confidence level using a coverage factor of k=2, traceable to the Internationally Accepted Guides to Measurement Uncertainty.

**5.1 RETURN LOSS**

The following uncertainties apply to the return loss measurement:

Frequency band	Expanded Uncertainty on Return Loss
400-6000MHz	0.1 dB

**5.2 DIMENSION MEASUREMENT**

The following uncertainties apply to the dimension measurements:

Length (mm)	Expanded Uncertainty on Length
3 - 300	0.05 mm

**5.3 VALIDATION MEASUREMENT**

The guidelines outlined in the IEEE 1528, FCC KDBs, CENELEC EN50361 and CEI/IEC 62209 standards were followed to generate the measurement uncertainty for validation measurements.

Scan Volume	Expanded Uncertainty
1 g	20.3 %



**SAR REFERENCE DIPOLE CALIBRATION REPORT**

Ref: ACR.109.5.18.SATU.A

10 g	20.1 %
------	--------

**6 CALIBRATION MEASUREMENT RESULTS**

**6.1 RETURN LOSS AND IMPEDANCE IN HEAD LIQUID**

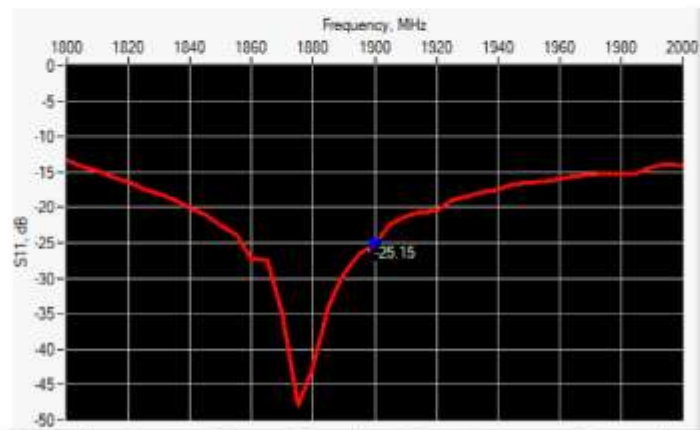

Frequency (MHz)	Return Loss (dB)	Requirement (dB)	Impedance
1900	-25.15	-20	52.6 Ω + 5.1 jΩ

**6.2 RETURN LOSS AND IMPEDANCE IN BODY LIQUID**

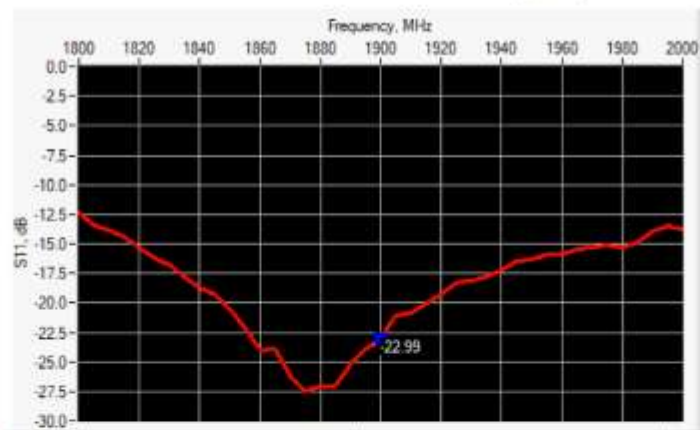

Frequency (MHz)	Return Loss (dB)	Requirement (dB)	Impedance
1900	-22.99	-20	47.6 Ω + 6.5 jΩ

**6.3 MECHANICAL DIMENSIONS**

Frequency MHz	L mm		h mm		d mm	
	required	measured	required	measured	required	measured
300	420.0 ±1 %		250.0 ±1 %		6.35 ±1 %	



**SAR REFERENCE DIPOLE CALIBRATION REPORT**

Ref: ACR.100.5.18.SATU.A

450	290.0 ±1 %		166.7 ±1 %		6.35 ±1 %	
750	176.0 ±1 %		100.0 ±1 %		6.35 ±1 %	
835	161.0 ±1 %		89.8 ±1 %		3.6 ±1 %	
900	149.0 ±1 %		83.3 ±1 %		3.6 ±1 %	
1450	89.1 ±1 %		51.7 ±1 %		3.6 ±1 %	
1500	80.5 ±1 %		50.0 ±1 %		3.6 ±1 %	
1640	79.0 ±1 %		45.7 ±1 %		3.6 ±1 %	
1750	75.2 ±1 %		42.9 ±1 %		3.6 ±1 %	
1800	72.0 ±1 %		41.7 ±1 %		3.6 ±1 %	
1900	68.0 ±1 %	PASS	39.5 ±1 %	PASS	3.6 ±1 %	PASS
1950	66.3 ±1 %		38.5 ±1 %		3.6 ±1 %	
2000	64.5 ±1 %		37.5 ±1 %		3.6 ±1 %	
2100	61.0 ±1 %		35.7 ±1 %		3.6 ±1 %	
2300	55.5 ±1 %		32.6 ±1 %		3.6 ±1 %	
2450	51.5 ±1 %		30.4 ±1 %		3.6 ±1 %	
2600	48.5 ±1 %		28.8 ±1 %		3.6 ±1 %	
3000	41.5 ±1 %		25.0 ±1 %		3.6 ±1 %	
3500	37.0 ±1 %		26.4 ±1 %		3.6 ±1 %	
3700	34.7 ±1 %		26.4 ±1 %		3.6 ±1 %	

**7 VALIDATION MEASUREMENT**

The IEEE Std. 1528, FCC KDBs and CE/IEC 62209 standards state that the system validation measurements must be performed using a reference dipole meeting the fore mentioned return loss and mechanical dimension requirements. The validation measurement must be performed against a liquid filled flat phantom, with the phantom constructed as outlined in the fore mentioned standards. Per the standards, the dipole shall be positioned below the bottom of the phantom, with the dipole length centered and parallel to the longest dimension of the flat phantom, with the top surface of the dipole at the described distance from the bottom surface of the phantom.

**7.1 HEAD LIQUID MEASUREMENT**

Frequency MHz	Relative permittivity ( $\epsilon_r'$ )		Conductivity ( $\sigma$ ) S/m	
	required	measured	required	measured
300	45.3 ±5 %		0.87 ±5 %	
450	43.5 ±5 %		0.87 ±5 %	
750	41.9 ±5 %		0.89 ±5 %	
835	41.5 ±5 %		0.90 ±5 %	
900	41.5 ±5 %		0.97 ±5 %	
1450	40.5 ±5 %		1.20 ±5 %	
1500	40.4 ±5 %		1.23 ±5 %	
1640	40.2 ±5 %		1.31 ±5 %	
1750	40.1 ±5 %		1.37 ±5 %	



SAR REFERENCE DIPOLE CALIBRATION REPORT

Ref: ACR-109.5.18.SATU.A

1800	40.0 ±5 %		1.40 ±5 %	
1900	40.0 ±5 %	PASS	1.40 ±5 %	PASS
1950	40.0 ±5 %		1.40 ±5 %	
2000	40.0 ±5 %		1.40 ±5 %	
2100	39.8 ±5 %		1.49 ±5 %	
2300	39.5 ±5 %		1.67 ±5 %	
2450	39.2 ±5 %		1.80 ±5 %	
2600	39.0 ±5 %		1.96 ±5 %	
3000	38.5 ±5 %		2.40 ±5 %	
3500	37.9 ±5 %		2.91 ±5 %	

7.2 SAR MEASUREMENT RESULT WITH HEAD LIQUID

The IEEE Std. 1528 and CEI/IEC 62209 standards state that the system validation measurements should produce the SAR values shown below (for phantom thickness of 2 mm), within the uncertainty for the system validation. All SAR values are normalized to 1 W forward power. In bracket, the measured SAR is given with the used input power.

Software	OPENSAR V4
Phantom	SN 20/09 SAM71
Probe	SN 18/11 EPG122
Liquid	Head Liquid Values: eps' : 38.5 sigma : 1.45
Distance between dipole center and liquid	10.0 mm
Area scan resolution	dx=8mm/dy=8mm
Zoon Scan Resolution	dx=8mm/dy=8mm/dz=5mm
Frequency	1900 MHz
Input power	20 dBm
Liquid Temperature	21 °C
Lab Temperature	21 °C
Lab Humidity	45 %

Frequency MHz	1 g SAR (W/kg/W)		10 g SAR (W/kg/W)	
	required	measured	required	measured
300	2.85		1.94	
450	4.58		3.06	
750	8.49		5.55	
835	9.56		6.22	
900	10.9		6.99	
1450	29		16	
1500	30.5		16.8	
1640	34.2		18.4	
1750	36.4		19.3	
1800	38.4		20.1	



**SAR REFERENCE DIPOLE CALIBRATION REPORT**

Ref: ACR.109.5.18.SATUA

1900	39.7	38.92 (3.89)	20.5	20.09 (2.01)
1950	40.5		20.9	
2000	41.1		21.1	
2100	43.6		21.9	
2300	48.7		23.3	
2450	52.4		24	
2600	55.3		24.6	
3000	63.8		25.7	
3500	67.1		25	
3700	67.4		24.2	

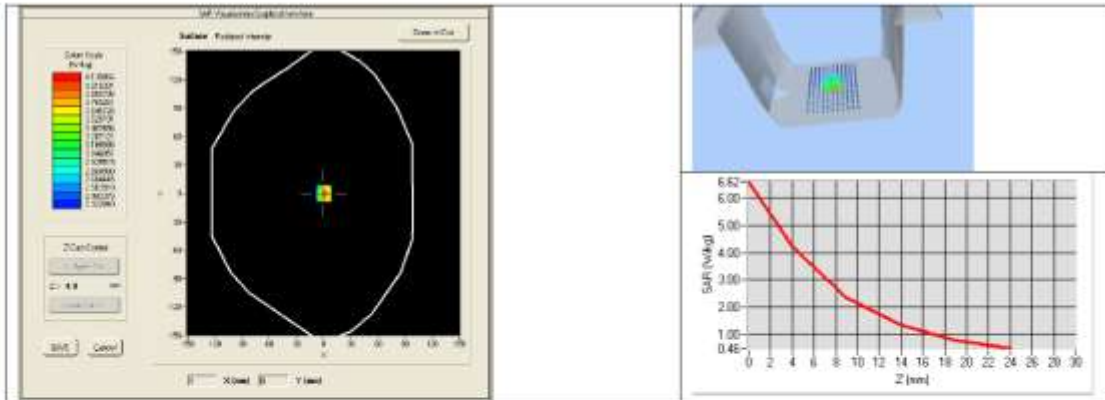

**7.3 BODY LIQUID MEASUREMENT**

Frequency MHz	Relative permittivity ( $\epsilon_r'$ )		Conductivity ( $\sigma$ ) S/m	
	required	measured	required	measured
150	61.9 ±5 %		0.80 ±5 %	
300	58.2 ±5 %		0.92 ±5 %	
450	56.7 ±5 %		0.94 ±5 %	
750	55.5 ±5 %		0.96 ±5 %	
835	55.2 ±5 %		0.97 ±5 %	
900	55.0 ±5 %		1.05 ±5 %	
915	55.0 ±5 %		1.06 ±5 %	
1450	54.0 ±5 %		1.30 ±5 %	
1610	53.8 ±5 %		1.40 ±5 %	
1800	53.3 ±5 %		1.52 ±5 %	
1900	53.3 ±5 %	PASS	1.52 ±5 %	PASS
2000	53.3 ±5 %		1.52 ±5 %	
2100	53.2 ±5 %		1.62 ±5 %	



**SAR REFERENCE DIPOLE CALIBRATION REPORT**

Ref: ACR.109.5.18.SATU.A

2300	52.9 ±5 %		1.81 ±5 %
2450	52.7 ±5 %		1.95 ±5 %
2600	52.5 ±5 %		2.16 ±5 %
3000	52.0 ±5 %		2.73 ±5 %
3500	51.3 ±5 %		3.31 ±5 %
3700	51.0 ±5 %		3.55 ±5 %
5200	49.0 ±10 %		5.30 ±10 %
5300	48.9 ±10 %		5.42 ±10 %
5400	48.7 ±10 %		5.53 ±10 %
5500	48.6 ±10 %		5.65 ±10 %
5600	48.5 ±10 %		5.77 ±10 %
5800	48.2 ±10 %		6.00 ±10 %

**7.4 SAR MEASUREMENT RESULT WITH BODY LIQUID**

Software	OPENSAR V4
Phantom	SN 20/09 SAM71
Probe	SN 18/11 EPG122
Liquid	Body Liquid Values: eps' : 53.3 sigma : 1.56
Distance between dipole center and liquid	10.0 mm
Area scan resolution	dx=8mm/dy=8mm
Zoon Scan Resolution	dx=8mm/dy=8mm/dz=5mm
Frequency	1900 MHz
Input power	20 dBm
Liquid Temperature	21 °C
Lab Temperature	21 °C
Lab Humidity	45 %

Frequency MHz	1 g SAR (W/kg/W)	10 g SAR (W/kg/W)
	measured	measured
1900	39.02 (3.90)	20.57 (2.06)

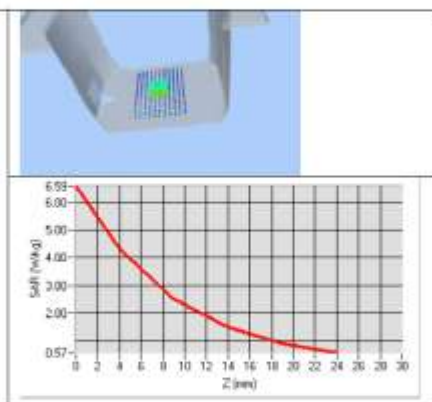
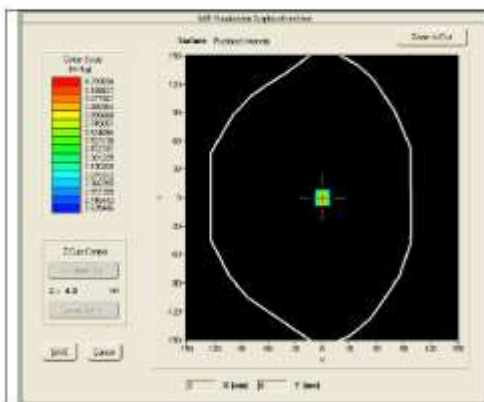





SAR REFERENCE DIPOLE CALIBRATION REPORT

Ref: ACR.109.5.18.SATU.A

8 LIST OF EQUIPMENT

Equipment Summary Sheet				
Equipment Description	Manufacturer / Model	Identification No.	Current Calibration Date	Next Calibration Date
SAM Phantom	MVG	SN-20/09-SAM71	Validated. No cal required.	Validated. No cal required.
COMOSAR Test Bench	Version 3	NA	Validated. No cal required.	Validated. No cal required.
Network Analyzer	Rhode & Schwarz ZVA	SN100132	02/2016	02/2019
Calipers	Carrera	CALIPER-01	01/2017	01/2020
Reference Probe	MVG	EPG122 SN 18/11	10/2017	10/2018
Multimeter	Keithley 2000	1188656	01/2017	01/2020
Signal Generator	Agilent E4438C	MY49070581	01/2017	01/2020
Amplifier	Aethercomm	SN 046	Characterized prior to test. No cal required.	Characterized prior to test. No cal required.
Power Meter	HP E4418A	US38261498	01/2017	01/2020
Power Sensor	HP ECP-E26A	US37181460	01/2017	01/2020
Directional Coupler	Narda 4216-20	01386	Characterized prior to test. No cal required.	Characterized prior to test. No cal required.
Temperature and Humidity Sensor	Control Company	150798832	11/2017	11/2020