

承 認 書 SPECIFICATION FOR APPROVAL

客戶名稱
CUSTOMER : _____

客戶料號
CUSTOMER'S P/N : _____

料號
PART NUMBER : KBAN3216G245H01

規格
DESCRIPTION : Chip Antenna 3216 L Ant 2.45G Type H01

版本
VERSION : V1.1

日期
ISSUE DATE : 2021/03/11

| |
|---------------------------|
| 客戶承認 CUSTOMER APPROVED |
| |

| 工 程 部 R&D CENTER | | |
|---------------------|----------------|--------------|
| 承 認 APPROVAL | 確 認 CHECKED | 製 作 DRAWN |
| Ziv | Alex | Jerry |



萬誠科技股份有限公司

112 台北市北投區立功街 151 號 1 樓

電話: (02) 2898-2220
傳真: (02) 2898-5055

OneWave Electronic Co., Ltd.

1F, No. 151, Li Gong Street, Beitou District,
Taipei City 112, Taiwan

TEL: +886 2 2898-2220
FAX: +886 2 2898-5055

3216 Chip antenna

For Bluetooth / WLAN Applications

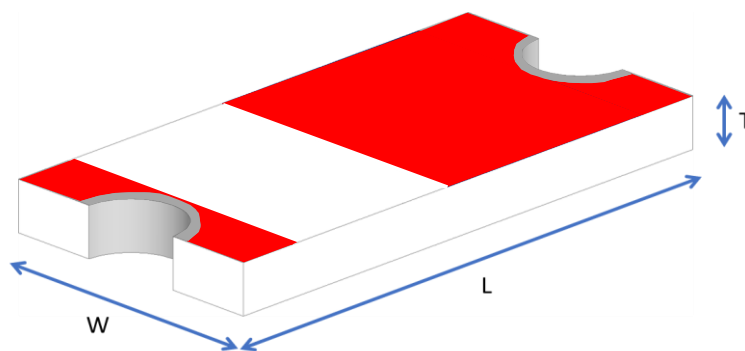

P/N: KBAN3216G245H01

| | Dimension (mm) |
|----------|-----------------|
| L | 3.23 ± 0.20 |
| W | 1.66 ± 0.20 |
| T | 0.45 ± 0.20 |

Part Number Information

KBAN **3216** **G** **245** **H** **01**
A **B** **C** **D** **E** **F**

| | | |
|----------|--------------------------|----------------------------------|
| A | Product Series | Antenna |
| B | Dimension L x W | 3.2 x 1.6mm (±0.2mm) |
| C | Material | High K material |
| D | Working Frequency | 2.4 ~ 2.5GHz |
| E | Feeding mode | PIFA & Single Feeding |
| F | Antenna type | Type = 01 |

1. Electrical Specification

| Specification | | |
|-------------------------------|--------------------|------|
| Part Number | KBAN3216G245H01 | |
| Central Frequency | 2450 | MHz |
| Bandwidth | 120 (Min.) | MHz |
| Return Loss | -6.5 (Max) | dB |
| Peak Gain | 1.73 | dBi |
| Impedance | 50 | Ohm |
| Operating Temperature | -40~+110 | °C |
| Maximum Power | 4 | W |
| Resistance to Soldering Heats | 10 (@ 260°C) | sec. |
| Polarization | Linear | |
| Azimuth Beamwidth | Omni-directional | |
| Termination | Cu / Sn (Leadless) | |

Remark : Bandwidth & Peak Gain was measured under evaluation board of next page

2. Recommended PCB Pattern
Evaluation Board Dimension

若未參照我司規格書上Layout建議做設計，
進而造成後續生產上的天線特性與品質差異問題，
我司將不負責處理。

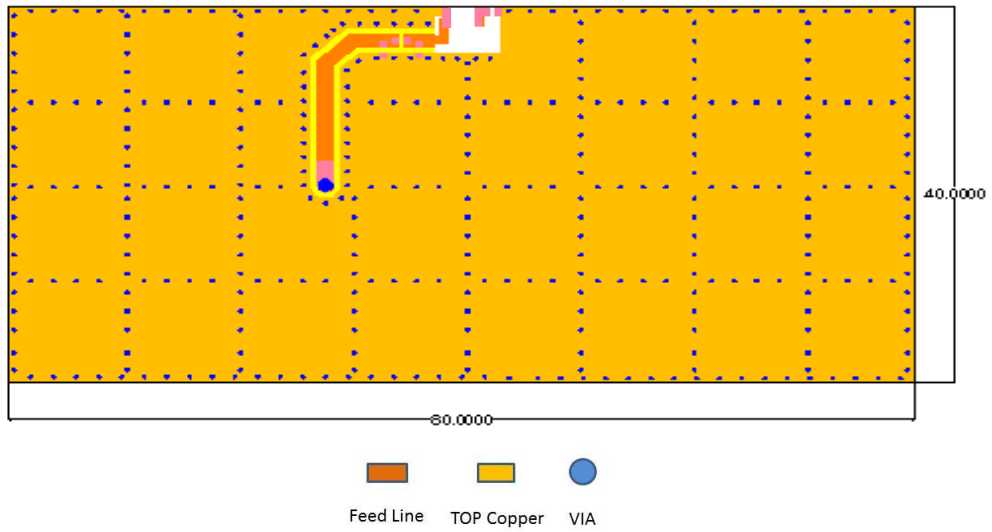

2nd Evaluation Board Dimension

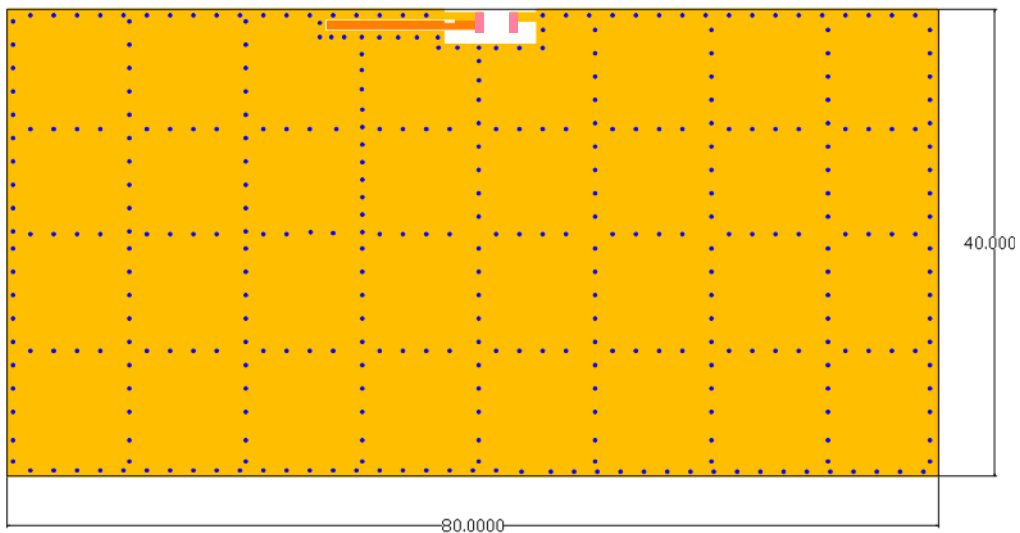

Suggested Matching Circuit

重要資訊：

匹配元件建議使用精準度高的電感±0.1~0.3nH、電容±0.1pF

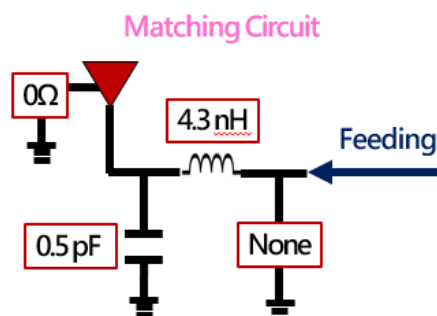

Layout Dimensions in Clearance area(Size=5.9*5.0mm)

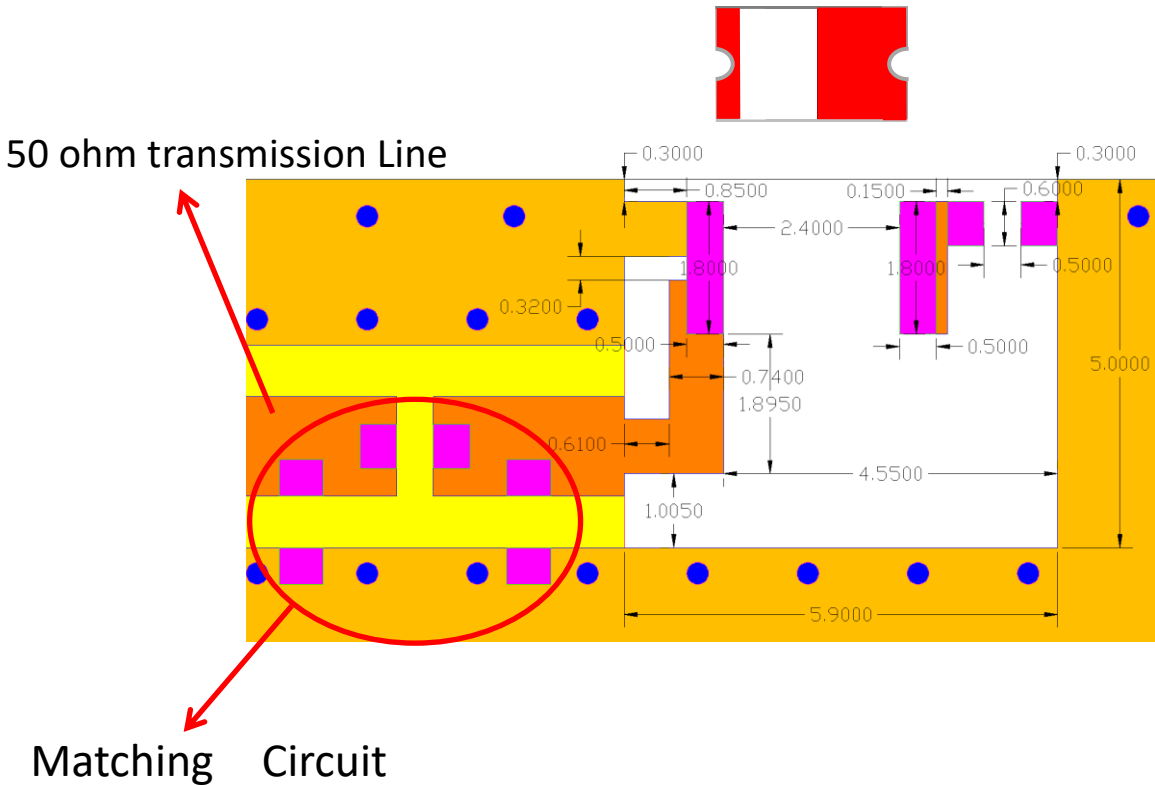

FootPrint (Unit : mm)

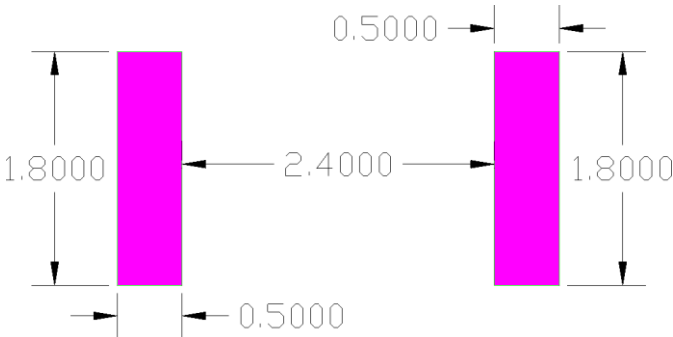

◆ **2nd Layout Dimensions in Clearance area(Size=8.0*3.0mm)**

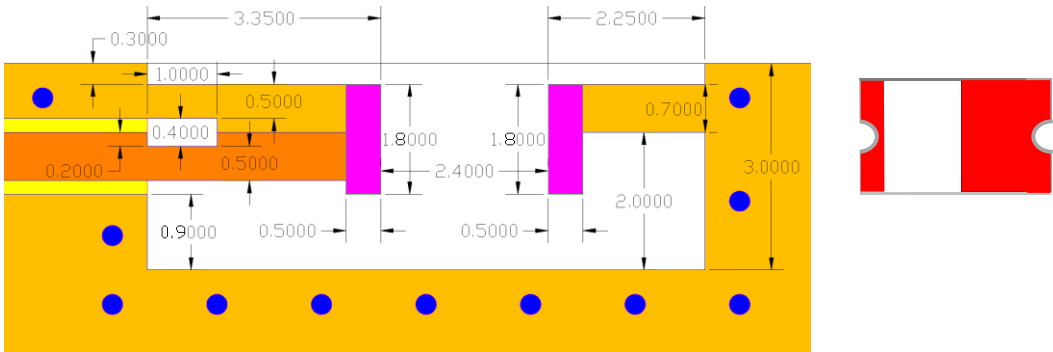

3. Measurement Results

Return Loss

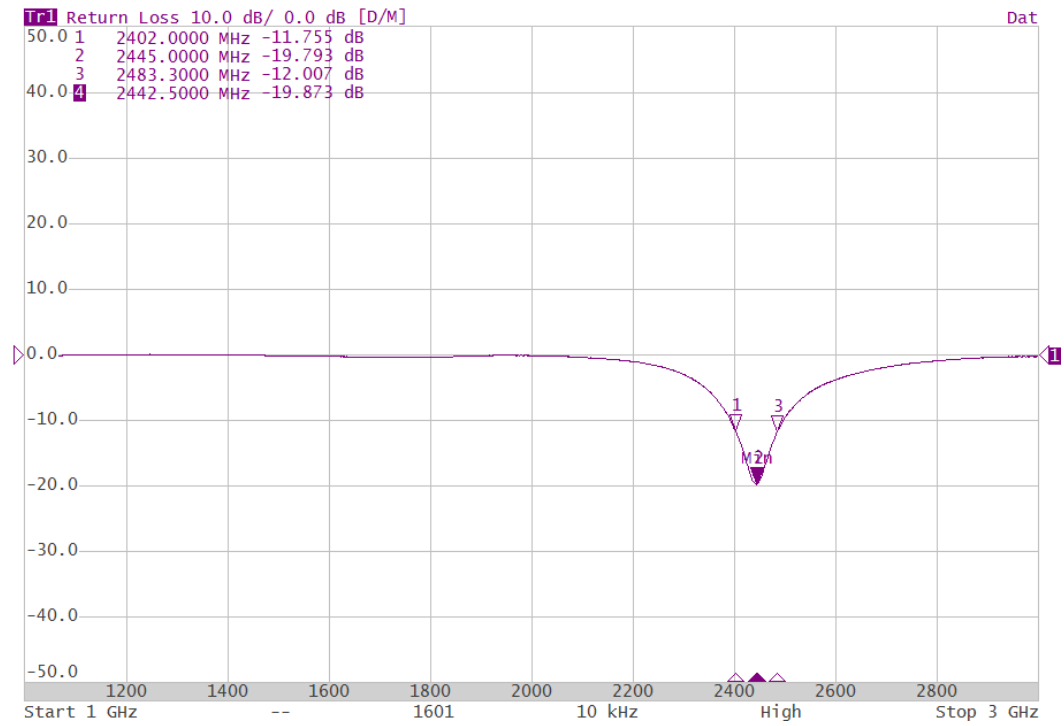

Radiation Pattern

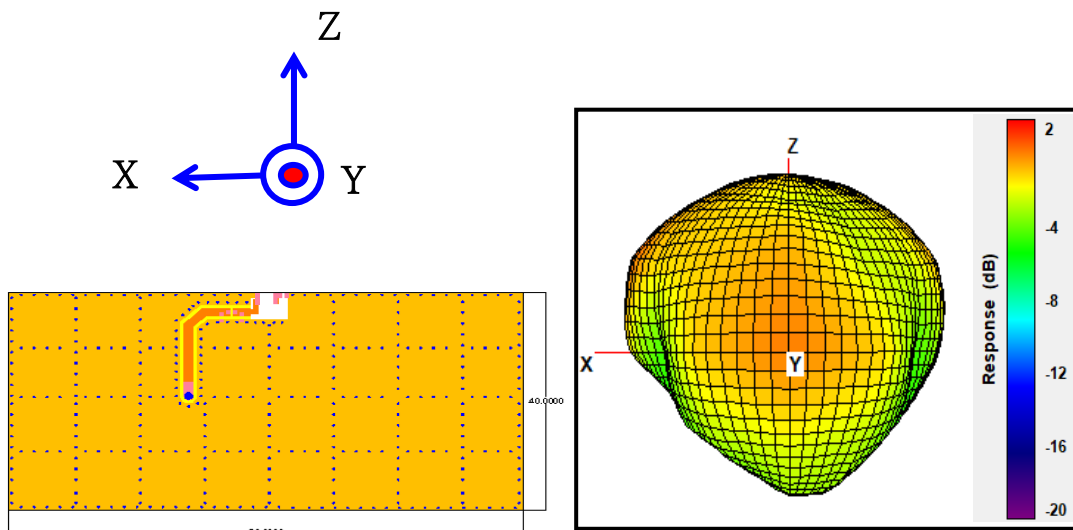

| | Efficiency | Peak Gain | Directivity |
|---------|------------|-----------|-------------|
| 2400MHz | 78.66 % | 1.64 dBi | 2.68 dBi |
| 2450MHz | 81.58 % | 1.73 dBi | 2.61 dBi |
| 2500MHz | 79.88 % | 1.68 dBi | 2.65 dBi |

Chamber Coordinate System

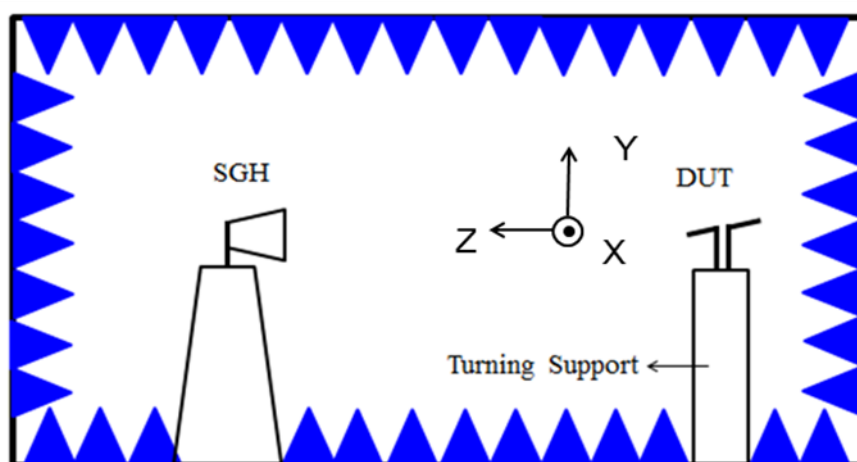

4. Reliability and Test Conditions

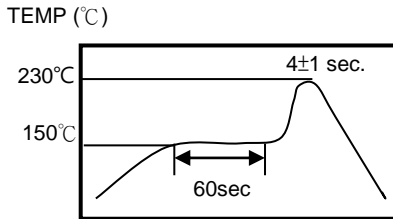
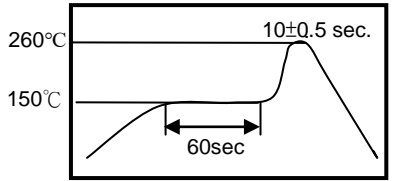
| ITEM | REQUIREMENTS | TEST CONDITION | | | | | | | | | | | | | | | |
|--------------------------------|--|---|-----------------|-----------|---|----------|------|---|------------------|-------------|---|---------|------|---|------------------|-------------|--|
| Solderability | 1. Wetting shall exceed 90% coverage 2. No visible mechanical damage  | Pre-heating temperature: 150°C/60sec. Solder temperature: 230±5°C Duration: 4±1sec. Solder: Sn-Ag3.0-Cu0.5 Flux for lead free: rosin | | | | | | | | | | | | | | | |
| Solder heat Resistance | 1. No visible mechanical damage 2. Central Freq. change :within ± 6%  | Pre-heating temperature: 150°C/60sec. Solder temperature: 260±5°C Duration: 10±0.5sec. Solder: Sn-Ag3.0-Cu0.5 Flux for lead free: rosin | | | | | | | | | | | | | | | |
| Component Adhesion (Push test) | 1. No visible mechanical damage | The device should be reflow soldered (230±5°C for 10sec.) to a tinned copper substrate. A dynamometer force gauge should be applied to the side of the component. The device must withstand ST-F 0.5 Kg without failure of the termination attached to component. | | | | | | | | | | | | | | | |
| Component Adhesion (Pull test) | 1. No visible mechanical damage | Insert 10cm wire into the remaining open eye bend, the ends of even wire lengths upward and wind together. Terminal shall not be remarkably damaged. | | | | | | | | | | | | | | | |
| Thermal shock | 1. No visible mechanical damage 2. Central Freq. change :within ±6% <table border="1" data-bbox="363 1281 788 1532"> <thead> <tr> <th>Phase</th> <th>Temperature(°C)</th> <th>Time(min)</th> </tr> </thead> <tbody> <tr> <td>1</td> <td>+110±5°C</td> <td>30±3</td> </tr> <tr> <td>2</td> <td>Room Temperature</td> <td>Within 3sec</td> </tr> <tr> <td>3</td> <td>-40±2°C</td> <td>30±3</td> </tr> <tr> <td>4</td> <td>Room Temperature</td> <td>Within 3sec</td> </tr> </tbody> </table> | Phase | Temperature(°C) | Time(min) | 1 | +110±5°C | 30±3 | 2 | Room Temperature | Within 3sec | 3 | -40±2°C | 30±3 | 4 | Room Temperature | Within 3sec | +110°C => 30±3min -40°C => 30±3min Test cycle: 10 cycles The chip shall be stabilized at normal condition for 2~3 hours before measuring. |
| Phase | Temperature(°C) | Time(min) | | | | | | | | | | | | | | | |
| 1 | +110±5°C | 30±3 | | | | | | | | | | | | | | | |
| 2 | Room Temperature | Within 3sec | | | | | | | | | | | | | | | |
| 3 | -40±2°C | 30±3 | | | | | | | | | | | | | | | |
| 4 | Room Temperature | Within 3sec | | | | | | | | | | | | | | | |
| Resistance to High Temperature | 1. No visible mechanical damage 2. Central Freq. change :within ±6% 3. No disconnection or short circuit. | Temperature: +110±5°C Duration: 1000±12hrs The chip shall be stabilized at normal condition for 2~3 hours before measuring. | | | | | | | | | | | | | | | |
| Resistance to Low Temperature | 1. No visible mechanical damage 2. Central Freq. change :within ±6% 3. No disconnection or short circuit. | Temperature: -40±5°C Duration: 1000±12hrs The chip shall be stabilized at normal condition for 2~3 hours before measuring. | | | | | | | | | | | | | | | |
| Humidity | 1. No visible mechanical damage 2. Central Freq. change :within ±6% 3. No disconnection or short circuit. | Temperature: 40±2°C Humidity: 90% to 95% RH Duration: 1000±12hrs The chip shall be stabilized at normal condition for 2~3 hours before measuring. | | | | | | | | | | | | | | | |

5.Soldering and Mounting

Mildly activated rosin fluxes are preferred. The minimum amount of solder can lead to damage from the stresses caused by the difference in coefficients of expansion between solder, chip and substrate. The terminations are suitable for all wave and re-flow soldering systems. If hand soldering cannot be avoided, the preferred technique is the utilization of hot air soldering tools.

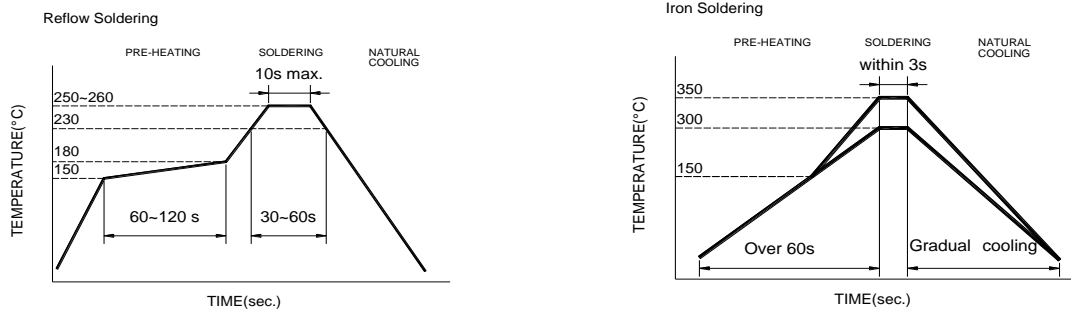

Recommended temperature profiles for re-flow soldering in Figure 1.

Products attachment with a soldering iron is discouraged due to the inherent process control limitations. In the event that a soldering iron must be employed the following precautions are recommended.

- Preheat circuit and products to 150°C
- Never contact the ceramic with the iron tip
- Use a 20 watt soldering iron with tip diameter of 1.0mm
- 280°C tip temperature (max)
- 1.0mm tip diameter (max)
- Limit soldering time to 3 sec.

6.Packaging Information

Tape Specification:

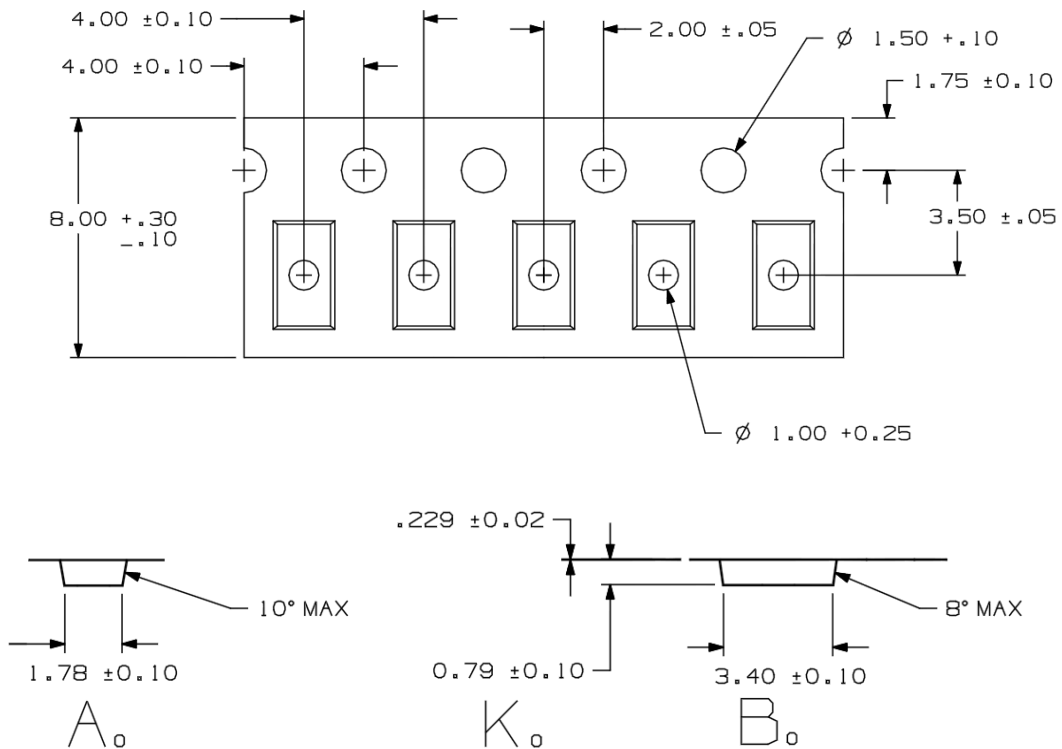

Reel Specification: (7", $\Phi 180$ mm)

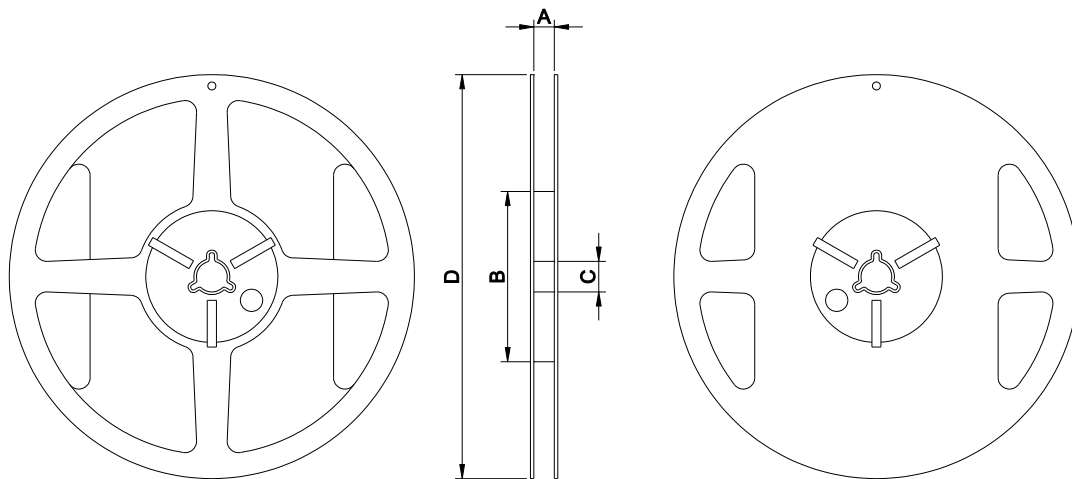

7" x 8 mm

| Tape Width(mm) | A(mm) | B(mm) | C(mm) | D(mm) | Chip/Reel(pcs) |
|----------------|---------------|------------|----------------|-------------|----------------|
| 8 | 9.0 ± 0.5 | 60 ± 2 | 13.5 ± 0.5 | 178 ± 2 | 3000 |

7.Storage and Transportation Information

Storage Conditions

To maintain the solderability of terminal electrodes:

1. Temperature and humidity conditions: -10~ 40°C and 30~70% RH.
2. Recommended products should be used within 6 months from the time of delivery.
3. The packaging material should be kept where no chlorine or sulfur exists in the air.

Transportation Conditions

1. Products should be handled with care to avoid damage or contamination from perspiration and skin oils.
2. The use of tweezers or vacuum pick up is strongly recommended for individual components.
3. Bulk handling should ensure that abrasion and mechanical shock are minimized.