

# TEST REPORT

FCC ID: 2AXYP-OHP-917

Product: Wireless Headphones

Model No.: OHP-917

Trade Mark: oraimo

Report No.: WSCT-ANAB-R&E241200081A-LE

Issued Date: 13 February 2025

Issued for:

**ORAIMO TECHNOLOGY LIMITED**  
**FLAT N 16/F BLOCK B UNIVERSAL INDUSTRIAL CENTRE 19-25**  
**SHAN MEI STREET FOTAN NT HONGKONG**

Issued By:

**World Standardization Certification & Testing Group(Shenzhen) Co.,Ltd.**  
**Building A-B,Baoli'an Industrial Park,No.58 and 60,Tangtou Avenue, Shiyan**  
**Street, Bao'an District, Shenzhen City, Guangdong Province, China**

**TEL: +86-755-26996192**

**FAX: +86-755-86376605**



*Note: This report shall not be reproduced except in full, without the written approval of World Standardization Certification & Testing Group (Shenzhen) Co., Ltd. This document may be altered or revised by World Standardization Certification & Testing Group (Shenzhen) Co., Ltd. personnel only, and shall be noted in the revision section of the document. The test results in the report only apply to the tested sample.*





## TABLE OF CONTENTS

<b>1. Test Certification</b> .....	<b>3</b>
<b>2. Test Result Summary</b> .....	<b>4</b>
<b>3. EUT Description</b> .....	<b>5</b>
<b>4. Genera Information</b> .....	<b>6</b>
4.1. TEST ENVIRONMENT AND MODE .....	6
4.2. DESCRIPTION OF SUPPORT UNITS .....	6
<b>5. Facilities and Accreditations</b> .....	<b>7</b>
5.1. FACILITIES .....	7
5.2. ACCREDITATIONS .....	7
5.3. MEASUREMENT UNCERTAINTY .....	8
5.4. MEASUREMENT INSTRUMENTS .....	9
<b>6. Test Results and Measurement Data</b> .....	<b>10</b>
6.1. ANTENNA REQUIREMENT .....	10
6.2. CONDUCTED EMISSION .....	11
6.3. CONDUCTED OUTPUT POWER .....	13
6.4. EMISSION BANDWIDTH.....	18
6.5. POWER SPECTRAL DENSITY .....	23
6.6. CONDUCTED BAND EDGE AND SPURIOUS EMISSION MEASUREMENT .....	28
6.7. RADIATED SPURIOUS EMISSION MEASUREMENT .....	39





# 1. Test Certification

**Product:** Wireless Headphones  
**Model No.:** OHP-917  
**Trade Mark:** oraimo  
**Applicant:** ORAIMO TECHNOLOGY LIMITED  
 FLAT N 16/F BLOCK B UNIVERSAL INDUSTRIAL CENTRE  
 19-25 SHAN MEI STREET FOTAN NT HONGKONG  
**Manufacturer:** ORAIMO TECHNOLOGY LIMITED  
 FLAT N 16/F BLOCK B UNIVERSAL INDUSTRIAL CENTRE  
 19-25 SHAN MEI STREET FOTAN NT HONGKONG  
**Date of Test:** 03 January 2025 to 13 February 2025  
**Applicable Standards:** FCC CFR Title 47 Part 15 Subpart C Section 15.247  
 KDB 558074 D01 DTS Meas Guidance v04

*The above equipment has been tested by World Standardization Certification & Testing Group(Shenzhen)Co., Ltd. and found compliance with the requirements set forth in the technical standards mentioned above. The results of testing in this report apply only to the product/system, which was tested. Other similar equipment will not necessarily produce the same results due to production tolerance and measurement uncertainties.*

**Tested By:** Wang Xiang  
 (Wang Xiang)

**Checked By:** Chen Xu  
 (Chen Xu)

**Approved By:** Li Huaibi  
 (Li Huaibi)

**Date:** 13 February 2025





Report No.: WSCT-ANAB-R&E241200081A-LE

## 2. Test Result Summary

Requirement	CFR 47 Section	Result
Antenna requirement	§15.203/§15.247 (c)	PASS
AC Power Line Conducted Emission	§15.207	NA
Conducted Peak Output Power	§15.247 (b)(3) §2.1046	PASS
6dB Emission Bandwidth	§15.247 (a)(2) §2.1049	PASS
Power Spectral Density	§15.247 (e)	PASS
Band Edge	1§5.247(d) §2.1051, §2.1057	PASS
Spurious Emission	§15.205/§15.209 §2.1053, §2.1057	PASS

**Note:**

1. PASS: Test item meets the requirement.
2. Fail: Test item does not meet the requirement.
3. N/A: Test case does not apply to the test object.
4. The test result judgment is decided by the limit of test standard.





### 3. EUT Description

<b>Product Name:</b>	Wireless Headphones
<b>Model :</b>	OHP-917
<b>Trade Mark:</b>	oraimo
<b>Operation Frequency:</b>	2402MHz~2480MHz
<b>Channel Separation:</b>	2MHz
<b>Number of Channel:</b>	40
<b>Modulation Technology:</b>	GFSK
<b>Antenna Type:</b>	PCB Antenna
<b>Antenna Gain:</b>	1.02dBi
<b>Operating Voltage</b>	Rechargeable Li-ion Battery: 703040 Nominal Voltage: 3.70V Rated Energy: 2.96Wh Rated Capacity: 800mAh Limited Charge Voltage: 4.20V
<b>Remark:</b>	N/A.

#### Operation Frequency each of channel

Channel	Frequency	Channel	Frequency	Channel	Frequency	Channel	Frequency
0	2402MHz	10	2422MHz	20	2442MHz	30	2462MHz
1	2404MHz	11	2424MHz	21	2444MHz	31	2464MHz
...	...	...	...	...	...	...	...
8	2418MHz	18	2438MHz	28	2458MHz	38	2478MHz
9	2420MHz	19	2440MHz	29	2460MHz	39	2480MHz

Remark: Channel 0, 19 & 39 have been tested.





## 4. Genera Information

### 4.1. Test environment and mode

Operating Environment:	
Temperature:	25.0 °C
Humidity:	56 % RH
Atmospheric Pressure:	1010 mbar
Test Mode:	
Engineering mode:	Keep the EUT in continuous transmitting by select channel and modulations(The value of duty cycle is 98.46%) with Fully-charged battery.
<p>The sample was placed (0.1m below 1GHz, 1.5m above 1GHz) above the ground plane of 3m chamber. Measurements in both horizontal and vertical polarities were performed. During the test, each emission was maximized by: having the EUT continuously working, investigated all operating modes, rotated about all 3 axis (X, Y &amp; Z) and considered typical configuration to obtain worst position, manipulating interconnecting cables, rotating the turntable, varying antenna height from 1m to 4m in both horizontal and vertical polarizations. The emissions worst-case are shown in Test Results of the following pages.</p>	

### 4.2. Description of Support Units

The EUT has been tested as an independent unit together with other necessary accessories or support units. The following support units or accessories were used to form a representative test configuration during the tests.

Equipment	Model No.	Serial No.	FCC ID	Trade Name
Adapter	XCU32	/	/	/

**Note:**

1. All the equipment/cables were placed in the worst-case configuration to maximize the emission during the test.
2. Grounding was established in accordance with the manufacturer's requirements and conditions for the intended use.
3. For conducted measurements (Output Power, 6dB Emission Bandwidth, Power Spectral Density, Spurious Emissions), the antenna of EUT is connected to the test equipment via temporary antenna connector, the antenna connector is soldered on the antenna port of EUT, and the temporary antenna connector is listed in the Test Instruments.





Report No.: WSCT-ANAB-R&E241200081A-LE

## 5. Facilities and Accreditations

### 5.1. Facilities

All measurement facilities used to collect the measurement data are located at **World Standardization Certification & Testing Group (Shenzhen) Co., Ltd. Building A-B, Baoli'an Industrial Park, No.58 and 60, Tangtou Avenue, Shiyan Street, Bao'an District, Shenzhen City, Guangdong Province, China**

The sites are constructed in conformance with the requirements of ANSI C63.4 and CISPR Publication 22. All receiving equipment conforms to CISPR Publication 16-1, "Radio Interference Measuring Apparatus and Measurement Methods."

### 5.2. ACCREDITATIONS

**ANAB - Certificate Number: AT-3951**

The EMC Laboratory has been accredited by the American Association for Laboratory Accreditation (ANAB). Certification Number: AT-3951





### 5.3.Measurement Uncertainty

The reported uncertainty of measurement  $y \pm U$ , where expended uncertainty  $U$  is based on a standard uncertainty multiplied by a coverage factor of  $k=2$ , providing a level of confidence of approximately 95 %.

No.	Item	MU
1	Power Spectral Density	$\pm 3.2\text{dB}$
2	Duty Cycle and Tx-Sequence and Tx-Gap	$\pm 1\%$
3	Medium Utilisation Factor	$\pm 1.3\%$
4	Occupied Channel Bandwidth	$\pm 2.4\%$
5	Transmitter Unwanted Emission in the out-of Band	$\pm 1.3\%$
6	Transmitter Unwanted Emissions in the Spurious Domain	$\pm 2.5\%$
7	Receiver Spurious Emissions	$\pm 2.5\%$
8	Conducted Emission Test	$\pm 3.2\text{dB}$
9	RF power, conducted	$\pm 0.16\text{dB}$
10	Spurious emissions, conducted	$\pm 0.21\text{dB}$
11	All emissions, radiated(<1GHz)	$\pm 4.7\text{dB}$
12	All emissions, radiated(>1GHz)	$\pm 4.7\text{dB}$
13	Temperature	$\pm 0.5^\circ\text{C}$
14	Humidity	$\pm 2.0\%$





Report No.: WSCT-ANAB-R&E241200081A-LE

### 5.4. MEASUREMENT INSTRUMENTS

NAME OF EQUIPMENT	MANUFACTURER	MODEL	SERIAL NUMBER	Calibration Date	Calibration Due.
Test software	--	EZ-EMC	CON-03A	-	-
Test software	--	MTS8310		-	
EMI Test Receiver	R&S	ESCI	100005	11/05/2024	11/04/2025
LISN	AFJ	LS16	16010222119	11/05/2024	11/04/2025
LISN(EUT)	Mestec	AN3016	04/10040	11/05/2024	11/04/2025
Universal Radio Communication Tester	R&S	CMU 200	1100.0008.02	11/05/2024	11/04/2025
Coaxial cable	Megalon	LMR400	N/A	11/05/2024	11/04/2025
GPIB cable	Megalon	GPIB	N/A	11/05/2024	11/04/2025
Spectrum Analyzer	R&S	FSU	100114	11/05/2024	11/04/2025
Pre Amplifier	H.P.	HP8447E	2945A02715	11/05/2024	11/04/2025
Pre-Amplifier	CDSI	PAP-1G18-38	--	11/05/2024	11/04/2025
Bi-log Antenna	SCHWARZBECK	VULB9168	01488	11/05/2024	11/04/2025
9*6*6 Anechoic	--	--	--	11/05/2024	11/04/2025
Horn Antenna	COMPLIANCE ENGINEERING	CE18000	--	11/05/2024	11/04/2025
Horn Antenna	SCHWARZBECK	BBHA9120D	9120D-631	11/05/2024	11/04/2025
Cable	TIME MICROWAVE	LMR-400	N-TYPE04	11/05/2024	11/04/2025
System-Controller	CCS	N/A	N/A	N.C.R	N.C.R
Turn Table	CCS	N/A	N/A	N.C.R	N.C.R
Antenna Tower	CCS	N/A	N/A	N.C.R	N.C.R
RF cable	Murata	MXHQ87WA3000	-	11/05/2024	11/04/2025
Loop Antenna	EMCO	6502	00042960	11/05/2024	11/04/2025
Horn Antenna	SCHWARZBECK	BBHA 9170	1123	11/05/2024	11/04/2025
Power meter	Anritsu	ML2487A	6K00003613	11/05/2024	11/04/2025
Power sensor	Anritsu	MX248XD	--	11/05/2024	11/04/2025
Spectrum Analyzer	Keysight	N9010B	MY60241089	11/05/2024	11/04/2025





## 6. Test Results and Measurement Data

### 6.1. Antenna requirement

<b>Standard requirement:</b>	FCC Part15 C Section 15.203 /247(c)
<p>15.203 requirement: An intentional radiator shall be designed to ensure that no antenna other than that furnished by the responsible party shall be used with the device. The use of a permanently attached antenna or of an antenna that uses a unique coupling to the intentional radiator, the manufacturer may design the unit so that a broken antenna can be replaced by the user, but the use of a standard antenna jack or electrical connector is prohibited.</p> <p>15.247(c) (1)(i) requirement: (i) Systems operating in the 2400-2483.5 MHz band that is used exclusively for fixed. Point-to-point operations may employ transmitting antennas with directional gain greater than 6dBi provided the maximum conducted output power of the intentional radiator is reduced by 1 dB for every 3 dB that the directional gain of the antenna exceeds 6dBi.</p>	
<b>E.U.T Antenna:</b>	
<p>The Bluetooth antenna is a PCB Antenna. it meets the standards, and the best case gain of the antenna is 1.02dBi.</p> <p>Please refer to the attachment "OHP-917 Internal Photo" for the antenna location</p>	



## 6.2. Conducted Emission

### 6.2.1. Test Specification

<b>Test Requirement:</b>	FCC Part15 C Section 15.207														
<b>Test Method:</b>	ANSI C63.10:2014														
<b>Frequency Range:</b>	150 kHz to 30 MHz														
<b>Receiver setup:</b>	RBW=9 kHz, VBW=30 kHz, Sweep time=auto														
<b>Limits:</b>	<table border="1"> <thead> <tr> <th rowspan="2">Frequency range (MHz)</th> <th colspan="2">Limit (dBuV)</th> </tr> <tr> <th>Quasi-peak</th> <th>Average</th> </tr> </thead> <tbody> <tr> <td>0.15-0.5</td> <td>66 to 56*</td> <td>56 to 46*</td> </tr> <tr> <td>0.5-5</td> <td>56</td> <td>46</td> </tr> <tr> <td>5-30</td> <td>60</td> <td>50</td> </tr> </tbody> </table>	Frequency range (MHz)	Limit (dBuV)		Quasi-peak	Average	0.15-0.5	66 to 56*	56 to 46*	0.5-5	56	46	5-30	60	50
	Frequency range (MHz)		Limit (dBuV)												
		Quasi-peak	Average												
	0.15-0.5	66 to 56*	56 to 46*												
0.5-5	56	46													
5-30	60	50													
<b>Test Setup:</b>	<p><b>Reference Plane</b></p> <p>40cm</p> <p>10cm</p> <p>E.U.T</p> <p>Adapter</p> <p>Test table/Insulation plane</p> <p>LISN</p> <p>Filter</p> <p>AC power</p> <p>EMI Receiver</p> <p><i>Remark</i> E.U.T: Equipment Under Test LISN: Line Impedance Stabilization Network Test table height=0.8m</p>														
<b>Test Mode:</b>	Charging + Transmitting Mode														
<b>Test Procedure:</b>	<ol style="list-style-type: none"> <li>1. The E.U.T is connected to an adapter through a line impedance stabilization network (L.I.S.N.). This provides a 50ohm/50uH coupling impedance for the measuring equipment.</li> <li>2. The peripheral devices are also connected to the main power through a LISN that provides a 50ohm/50uH coupling impedance with 50ohm termination. (Please refer to the block diagram of the test setup and photographs).</li> <li>3. Both sides of A.C. line are checked for maximum conducted interference. In order to find the maximum emission, the relative positions of equipment and all of the interface cables must be changed according to ANSI C63.10:2014 on conducted measurement.</li> </ol>														
<b>Test Result:</b>	N/A														



Report No.: WSCT-ANAB-R&E241200081A-LE

### 6.2.2. EUT OPERATING CONDITIONS

The EUT is working in the Normal link mode. All modes have been tested and normal link mode is worst.

Devices subject to Part 15 must be tested for all available U.S. voltages and frequencies (such as a nominal 120 VAC, 60 Hz and 240 VAC, 50 Hz) for which the device is capable of operation. So, The configuration 120 VAC, 60 Hz and 240 VAC, 50 Hz were tested respectively, but only the worst configuration (120 VAC, 60 Hz) shown here.

**Test data:**

Note: EUT is powered by batteries and cannot transmit normally while charging. This project does not require testing





Report No.: WSCT-ANAB-R&E241200081A-LE

### 6.3. Conducted Output Power

#### 6.3.1. Test Specification

<b>Test Requirement:</b>	FCC Part15 C Section 15.247 (b)(3)
<b>Test Method:</b>	KDB558074
<b>Limit:</b>	30dBm
<b>Test Setup:</b>	 <p style="text-align: center;">Spectrum Analyzer                      EUT</p>
<b>Test Mode:</b>	Refer to item 4.1
<b>Test Procedure:</b>	<ol style="list-style-type: none"> <li>1. The testing follows the Measurement Procedure of FCC KDB No. 558074 DTS D01 Meas. Guidance v04.</li> <li>2. Set spectrum analyzer as following: <ol style="list-style-type: none"> <li>a) Set the RBW <math>\geq</math> DTS bandwidth.</li> <li>b) Set VBW <math>\geq</math> 3 <math>\times</math> RBW.</li> <li>c) Set span <math>\geq</math> 3 <math>\times</math> RBW</li> <li>d) Sweep time = auto couple.</li> <li>e) Detector = peak.</li> <li>f) Trace mode = max hold.</li> <li>g) Allow trace to fully stabilize.</li> <li>h) Use peak marker function to determine the peak amplitude level.</li> </ol> </li> </ol>
<b>Test Result:</b>	PASS





Report No.: WSCT-ANAB-R&amp;E241200081A-LE

### 6.3.2. Test Data

BLE 1M			
Test channel	Maximum Conducted Output Power (dBm)	Limit (dBm)	Result
Lowest	5.1	30.00	PASS
Middle	5.67	30.00	PASS
Highest	5.74	30.00	PASS

BLE 2M			
Test channel	Maximum Conducted Output Power (dBm)	Limit (dBm)	Result
Lowest	5.19	30.00	PASS
Middle	5.65	30.00	PASS
Highest	5.73	30.00	PASS

Test plots as follows:



### Test Graphs

#### Power BLE 1M 2402MHz

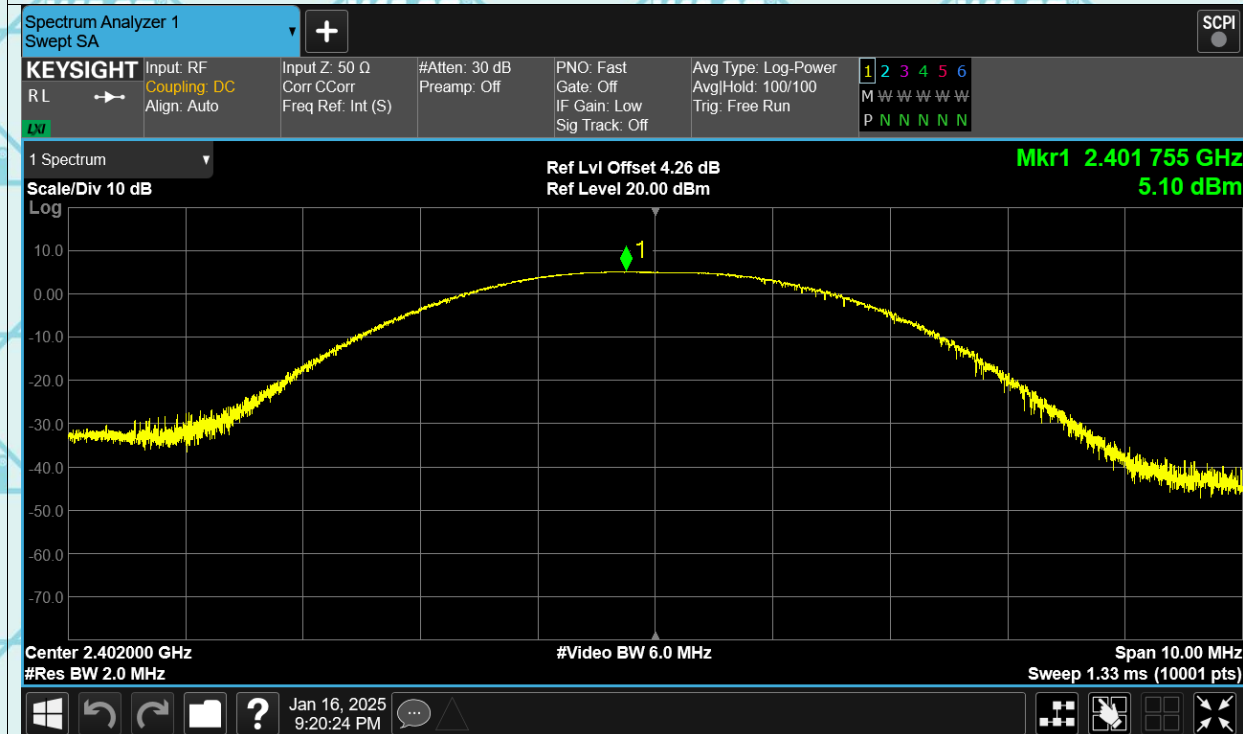

#### Power BLE 1M 2440MHz

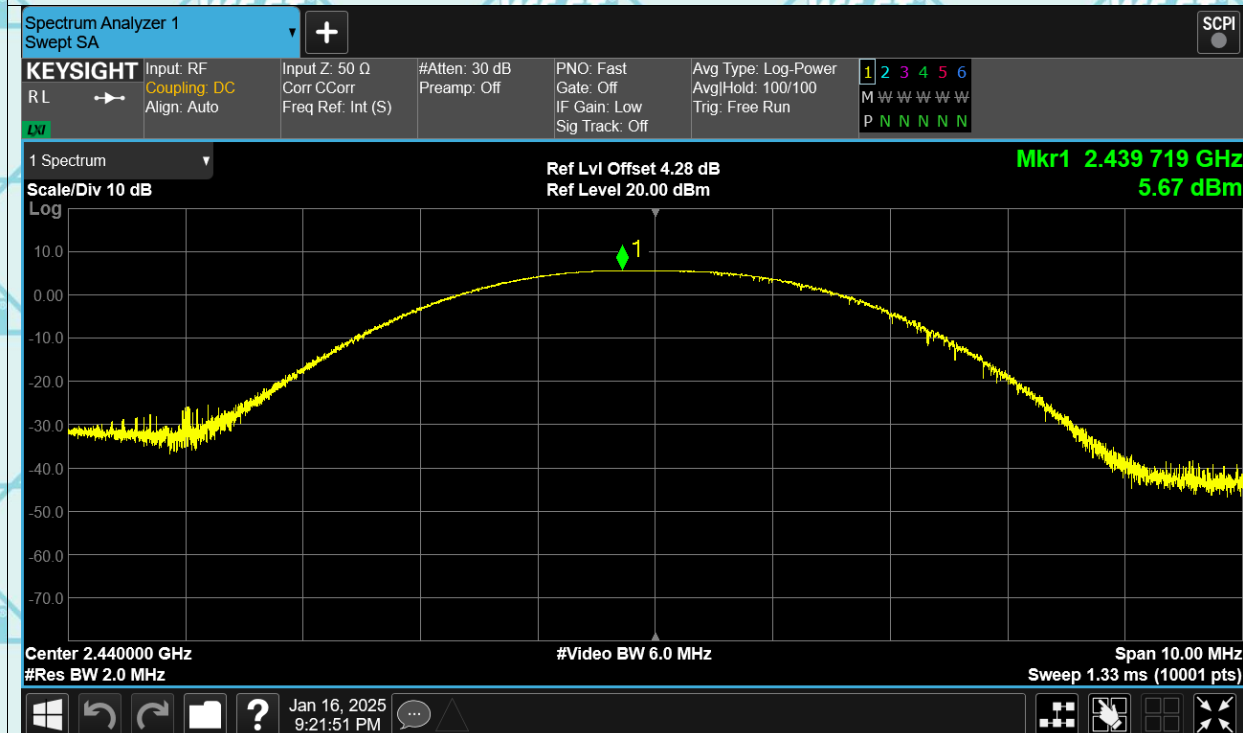



### Power BLE 1M 2480MHz



### Power BLE 2M 2402MHz

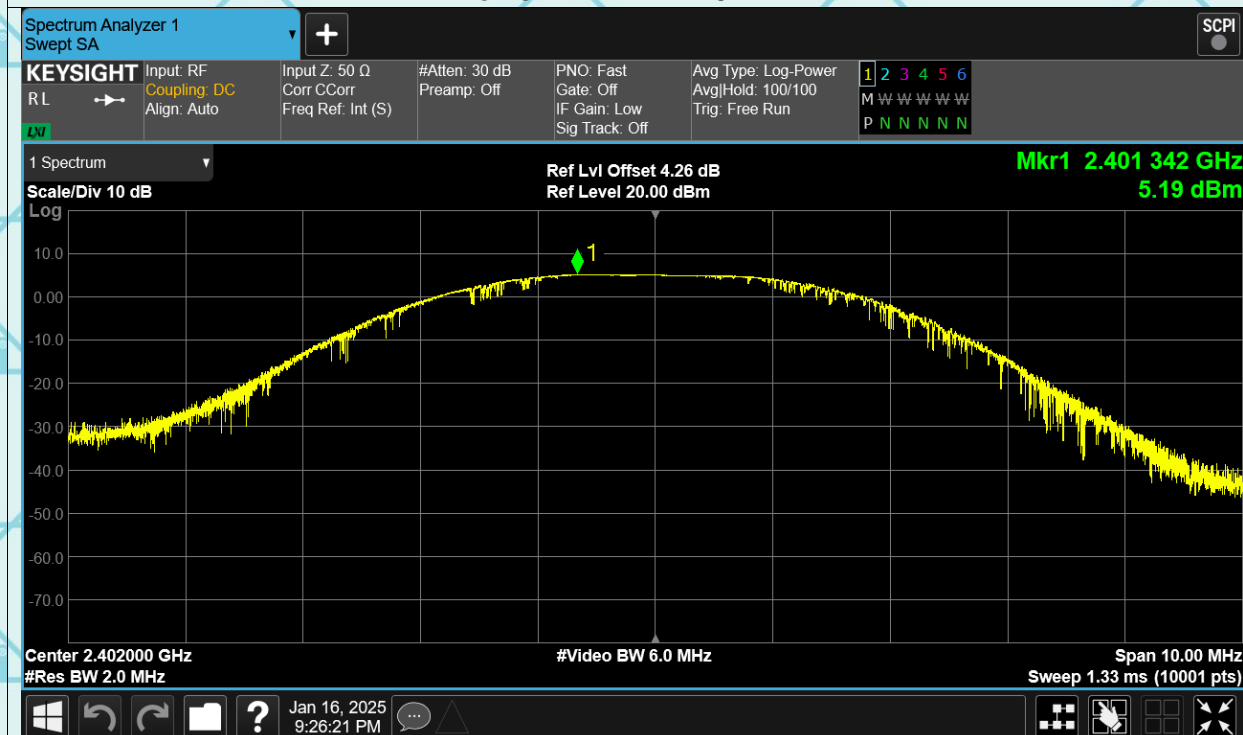



### Power BLE 2M 2440MHz

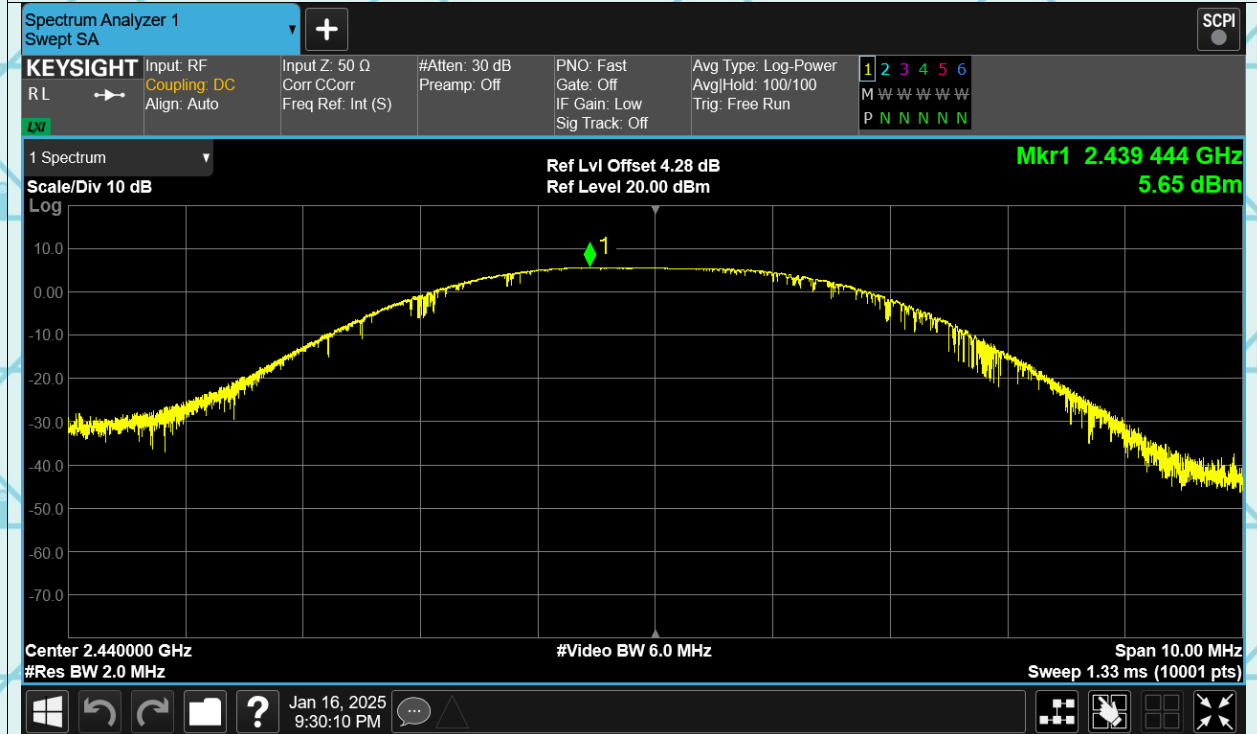

### Power BLE 2M 2480MHz

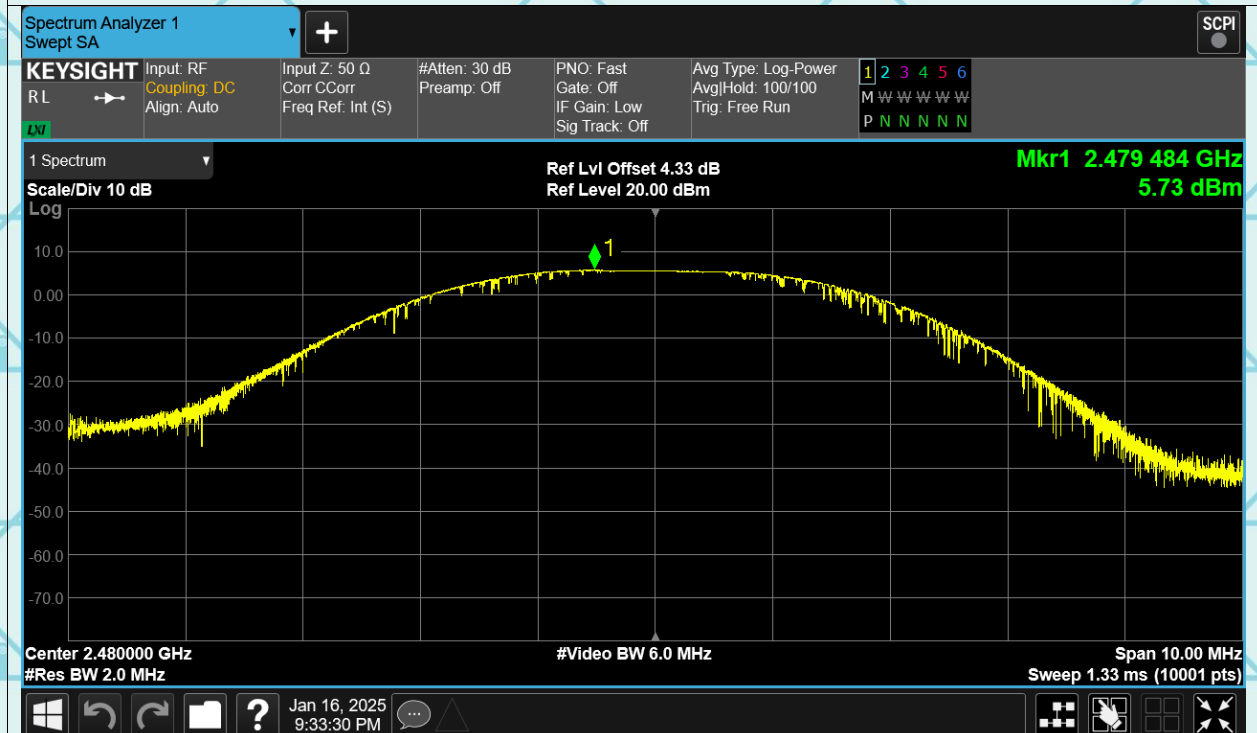



## 6.4. Emission Bandwidth

### 6.4.1. Test Specification

<b>Test Requirement:</b>	FCC Part15 C Section 15.247 (a)(2)
<b>Test Method:</b>	KDB558074
<b>Limit:</b>	>500kHz
<b>Test Setup:</b>	 <p style="text-align: center;">Spectrum Analyzer                      EUT</p>
<b>Test Mode:</b>	Refer to item 4.1
<b>Test Procedure:</b>	<ol style="list-style-type: none"> <li>1. The testing follows FCC KDB Publication No. 558074 DTS D01 Meas. Guidance v04.</li> <li>2. Set to the maximum power setting and enable the EUT transmit continuously.</li> <li>3. Make the measurement with the spectrum analyzer's resolution bandwidth (RBW) = 100 kHz. Set the Video bandwidth (VBW) = 300 kHz. In order to make an accurate measurement. The 6dB bandwidth must be greater than 500 kHz.</li> <li>4. Measure and record the results in the test report.</li> </ol>
<b>Test Result:</b>	PASS



Report No.: WSCT-ANAB-R&E241200081A-LE

### 6.4.2. Test data

#### BLE 1M

Test channel	6dB Emission Bandwidth (kHz)		
	BT LE mode	Limit	Result
Lowest	0.662	>500k	PASS
Middle	0.659	>500k	
Highest	0.639	>500k	

#### BLE 2M

Test channel	6dB Emission Bandwidth (kHz)		
	BT LE mode	Limit	Result
Lowest	1.006	>500k	PASS
Middle	0.977	>500k	
Highest	1.008	>500k	

Test plots as follows:



### Test Graphs

#### -6dB Bandwidth BLE 1M 2402MHz

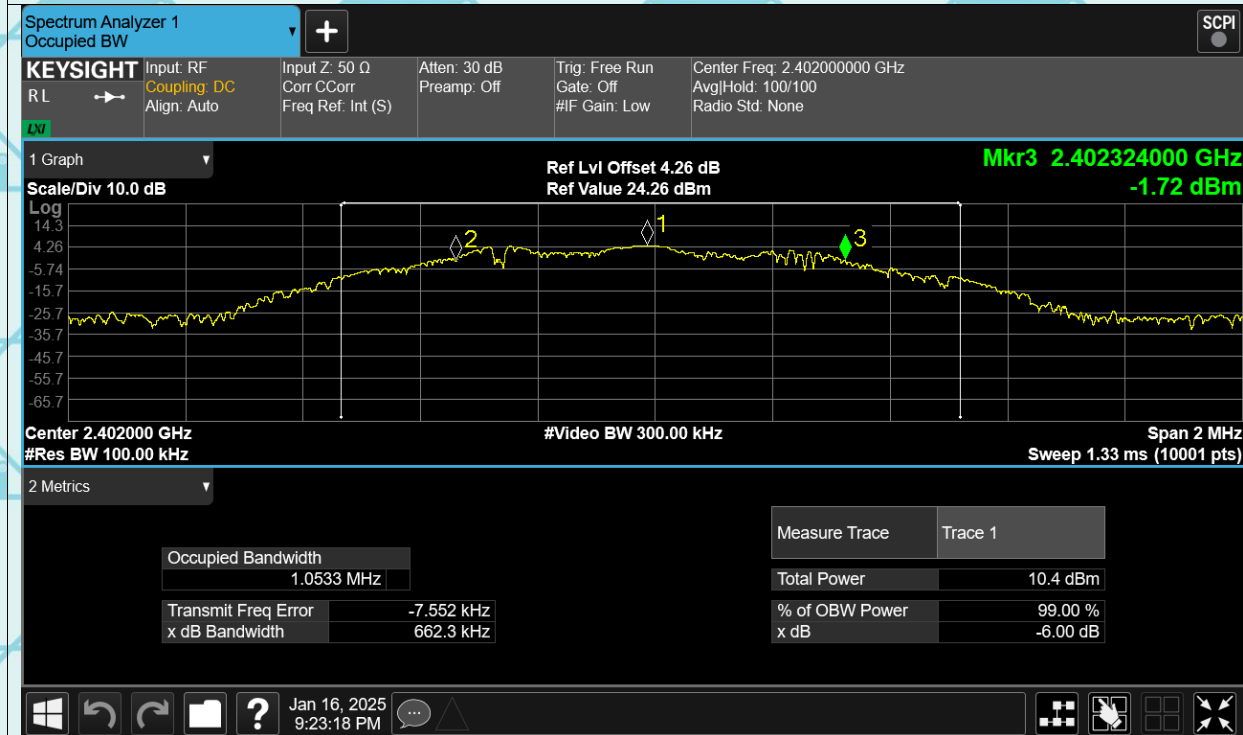

#### -6dB Bandwidth BLE 1M 2440MHz

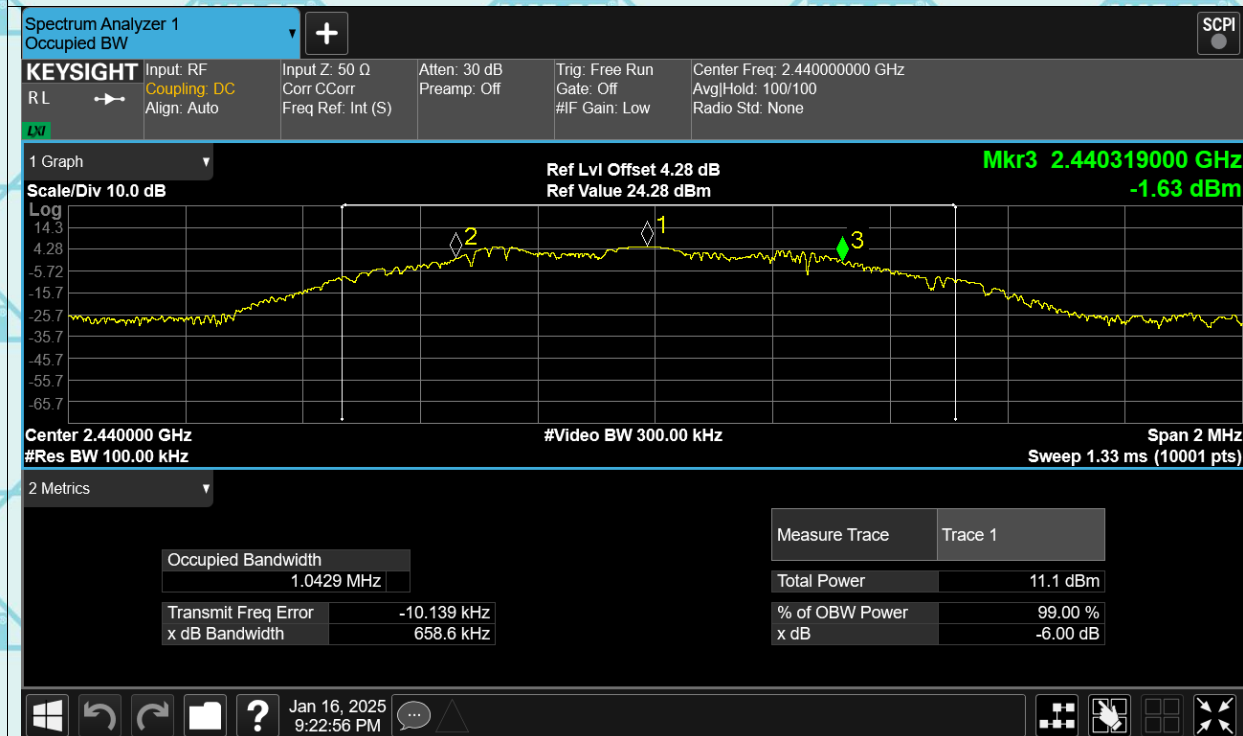



Report No.: WSCT-ANAB-R&E241200081A-LE

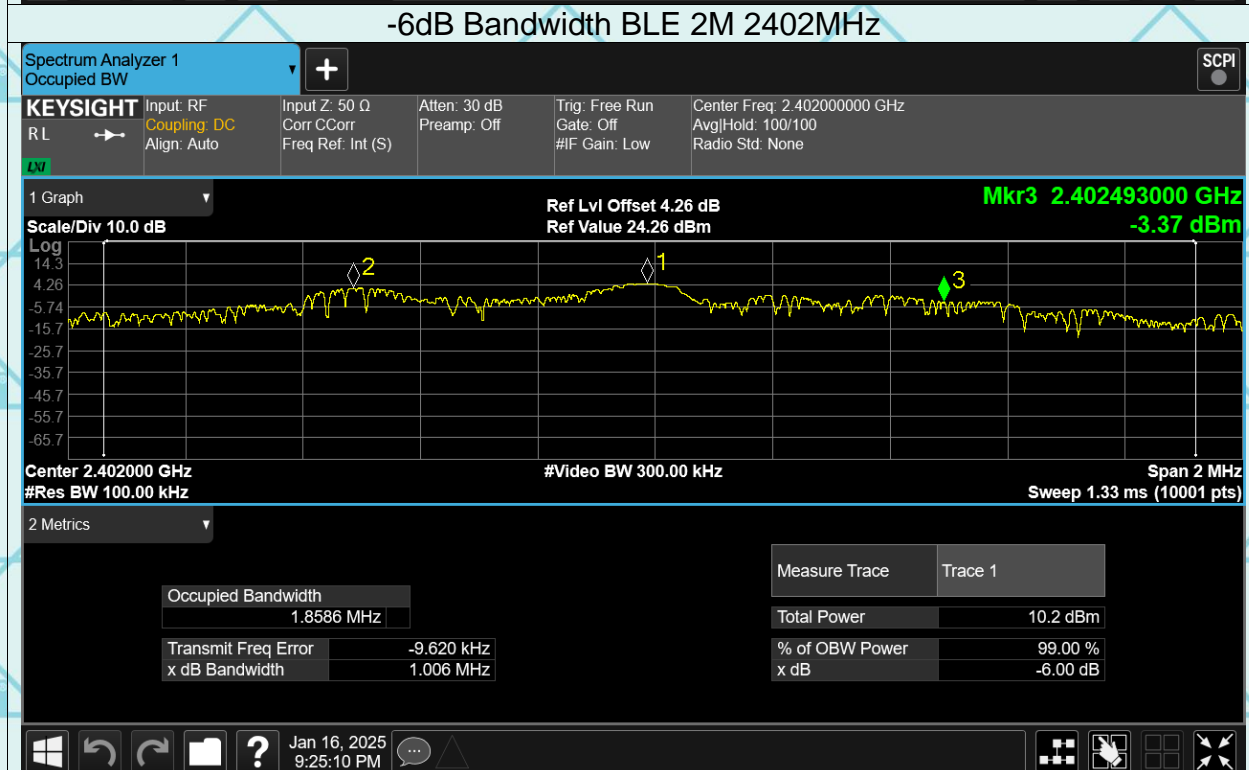



Report No.: WSCT-ANAB-R&E241200081A-LE

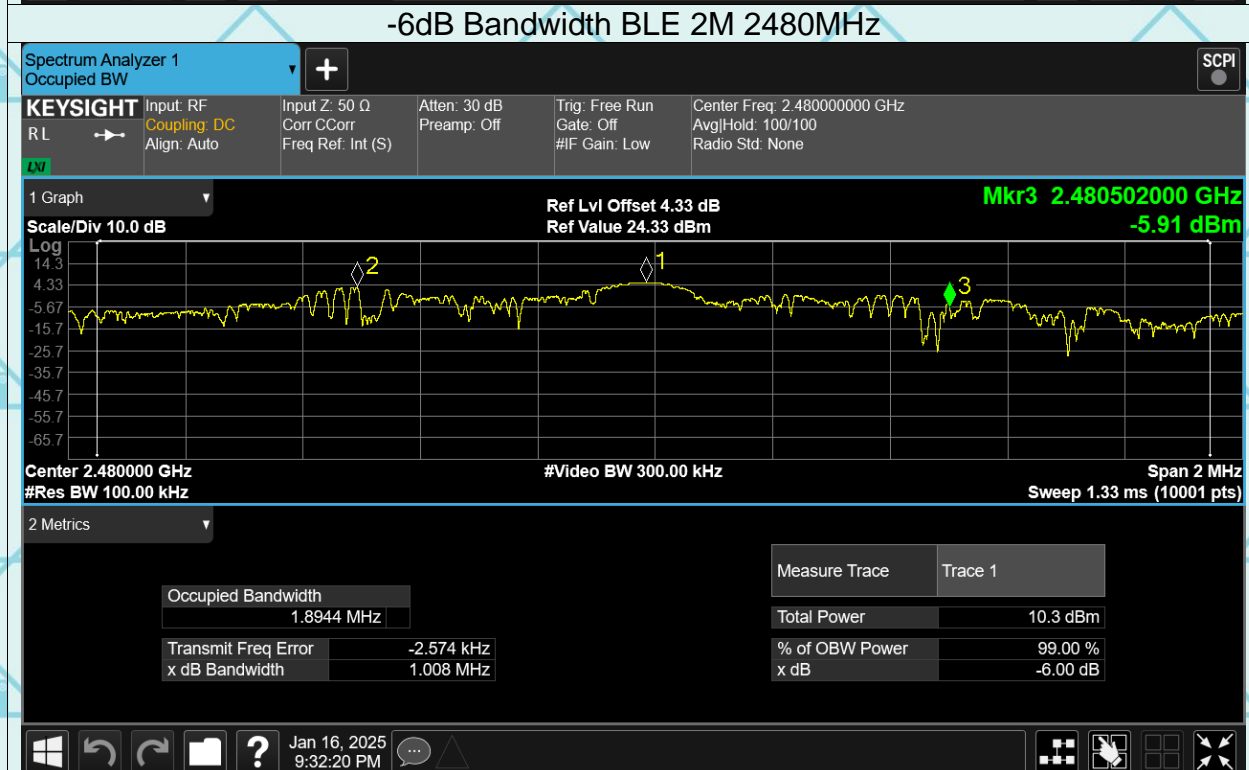
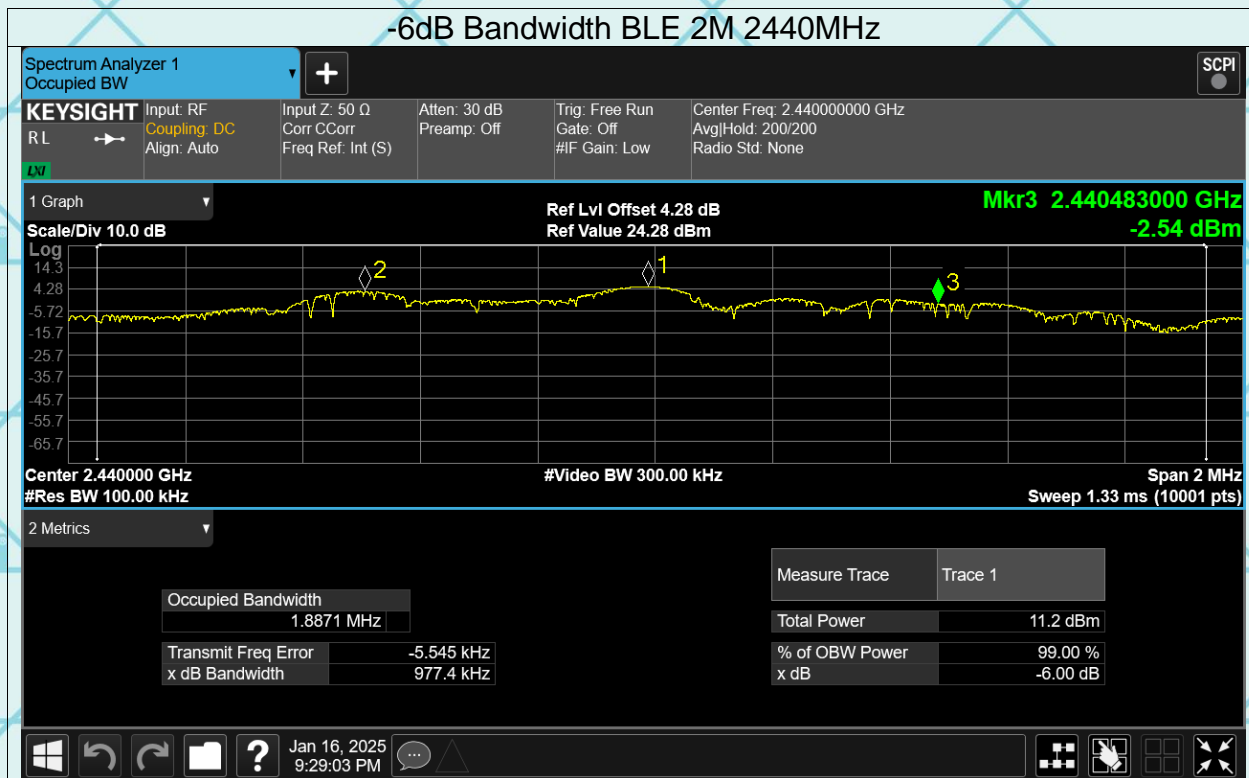



## 6.5. Power Spectral Density

### 6.5.1. Test Specification

<b>Test Requirement:</b>	FCC Part15 C Section 15.247 (e)
<b>Test Method:</b>	KDB558074
<b>Limit:</b>	The peak power spectral density shall not be greater than 8dBm in any 3kHz band at any time interval of continuous transmission.
<b>Test Setup:</b>	 <p style="text-align: center;">Spectrum Analyzer                      EUT</p>
<b>Test Mode:</b>	Refer to item 4.1
<b>Test Procedure:</b>	<ol style="list-style-type: none"> <li>1. The testing follows Measurement Procedure 10.2 Method PKPSD of FCC KDB Publication No.558074 D01 DTS Meas. Guidance v04</li> <li>2. The RF output of EUT was connected to the spectrum analyzer by RF cable and attenuator. The path loss was compensated to the results for each measurement.</li> <li>3. Set to the maximum power setting and enable the EUT transmit continuously.</li> <li>4. Make the measurement with the spectrum analyzer's resolution bandwidth (RBW): <math>3 \text{ kHz} \leq \text{RBW} \leq 100 \text{ kHz}</math>. Video bandwidth <math>\text{VBW} \geq 3 \times \text{RBW}</math>. In order to make an accurate measurement, set the span to 1.5 times DTS Channel Bandwidth. (6dB BW)</li> <li>5. Detector = peak, Sweep time = auto couple, Trace mode = max hold, Allow trace to fully stabilize. Use the peak marker function to determine the maximum power level.</li> <li>6. Measure and record the results in the test report.</li> </ol>
<b>Test Result:</b>	PASS



Report No.: WSCT-ANAB-R&E241200081A-LE

### 6.5.2. Test data

Test channel	Power Spectral Density (dBm/3kHz)		
	BLE 1M	Limit	Result
Lowest	-5.17	8 dBm/3kHz	PASS
Middle	-4.31	8 dBm/3kHz	
Highest	-4.24	8 dBm/3kHz	

Test channel	Power Spectral Density (dBm/3kHz)		
	BLE 2M	Limit	Result
Lowest	-5.21	8 dBm/3kHz	PASS
Middle	-4.83	8 dBm/3kHz	
Highest	-4.57	8 dBm/3kHz	

Test plots as follows:





### Test Graphs

#### PSD BLE 1M 2402MHz

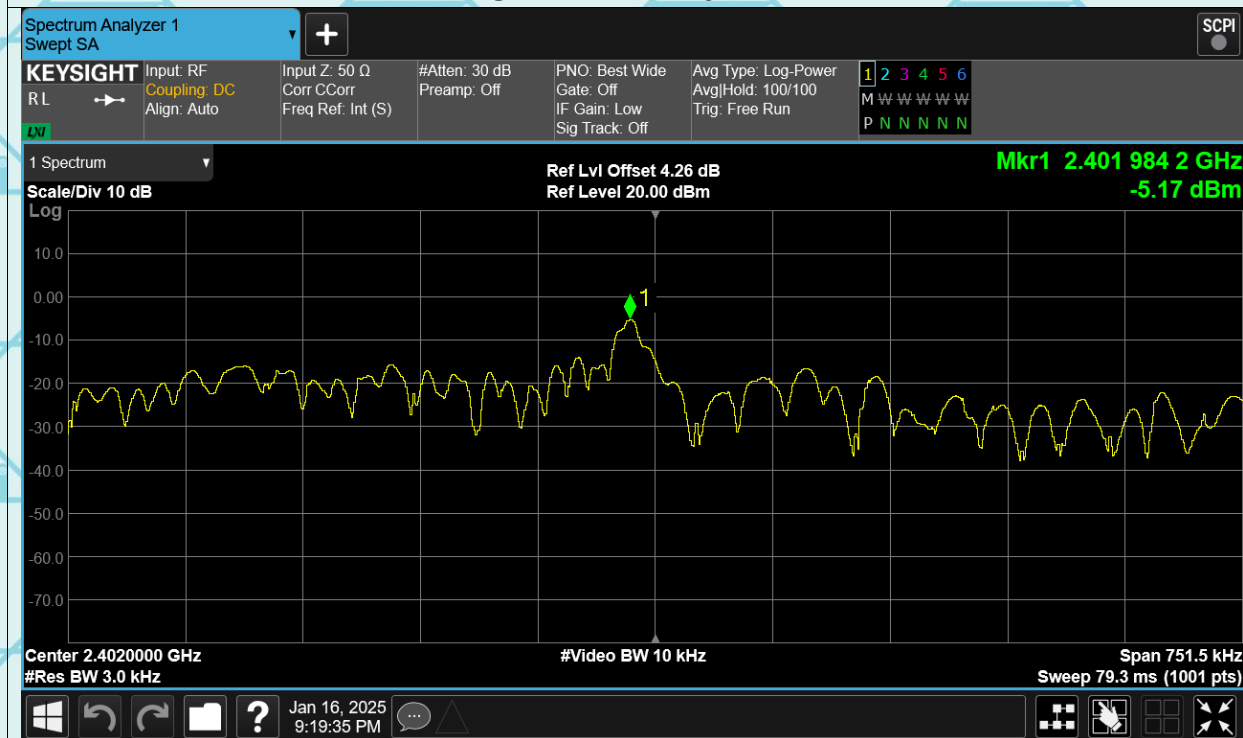

#### PSD BLE 1M 2440MHz

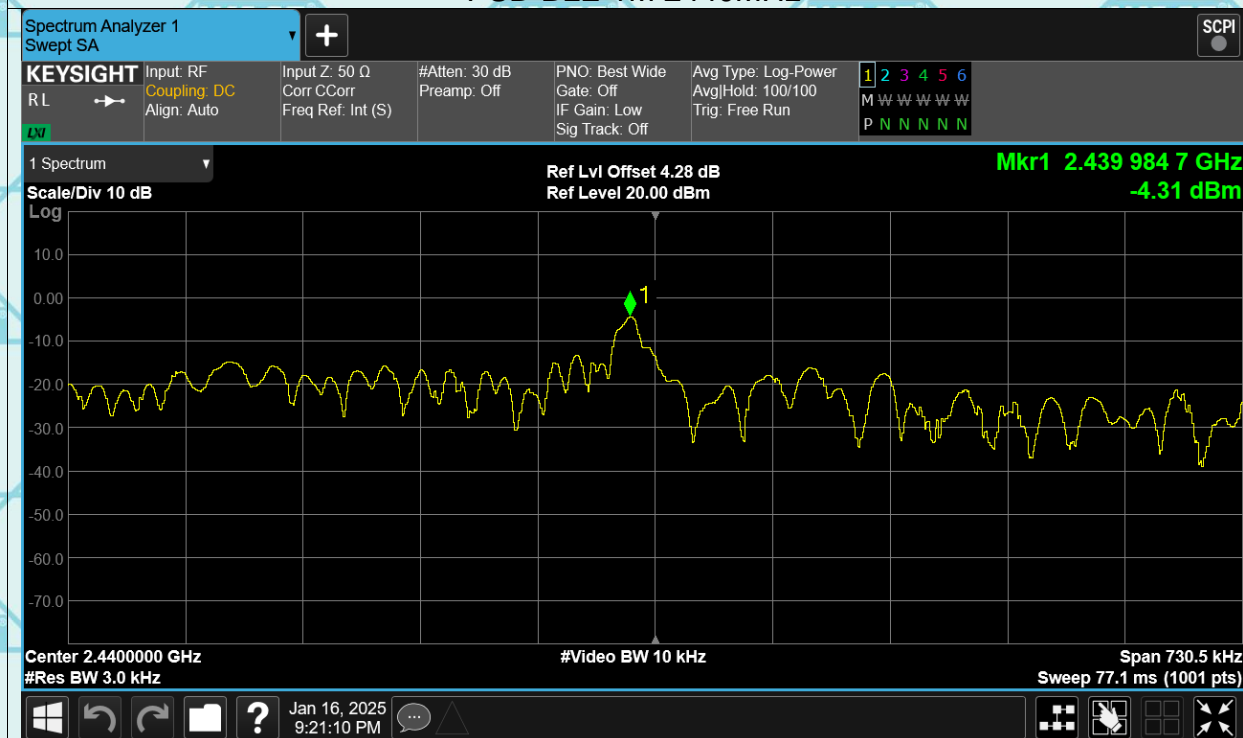



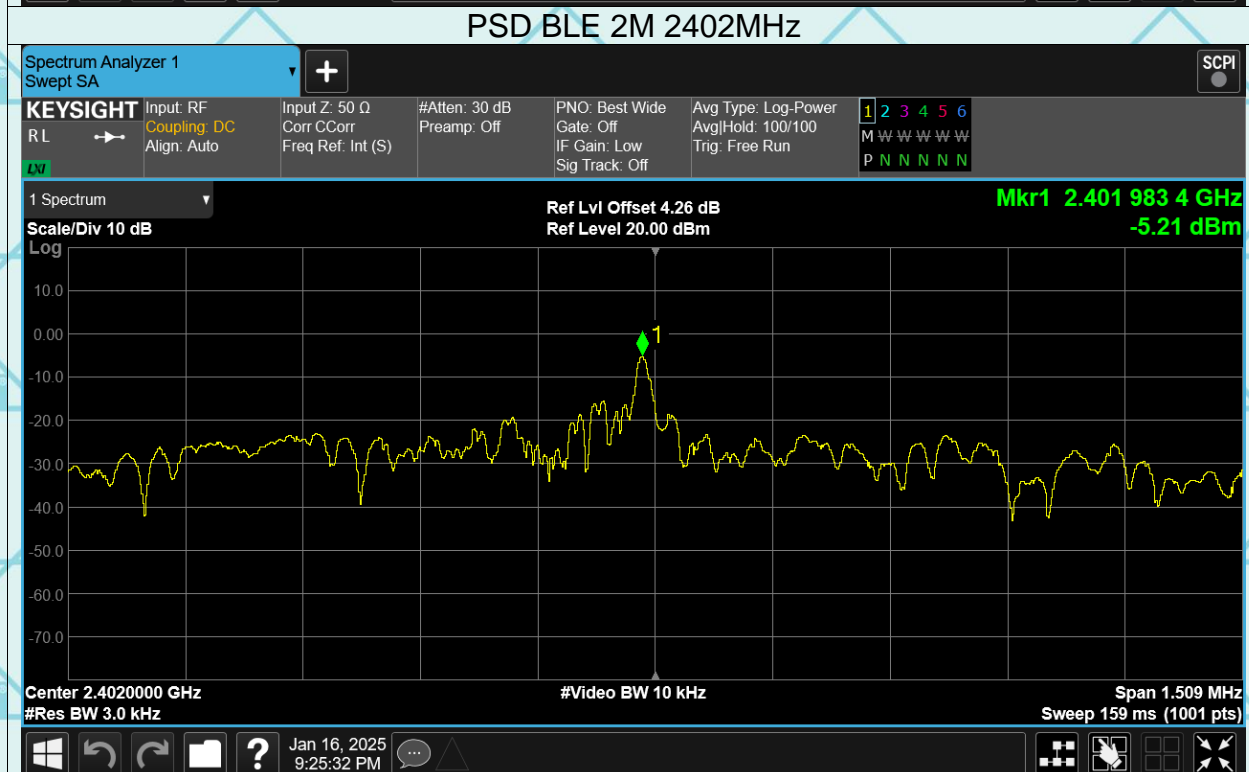
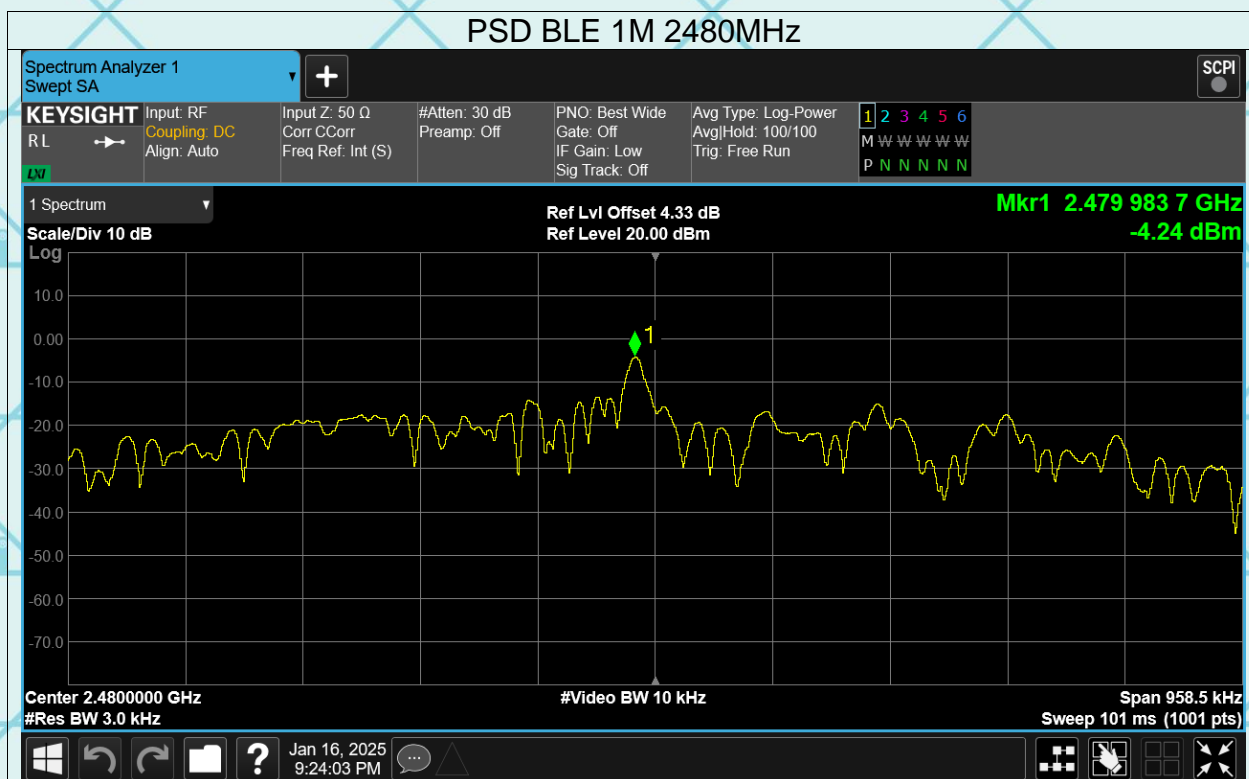



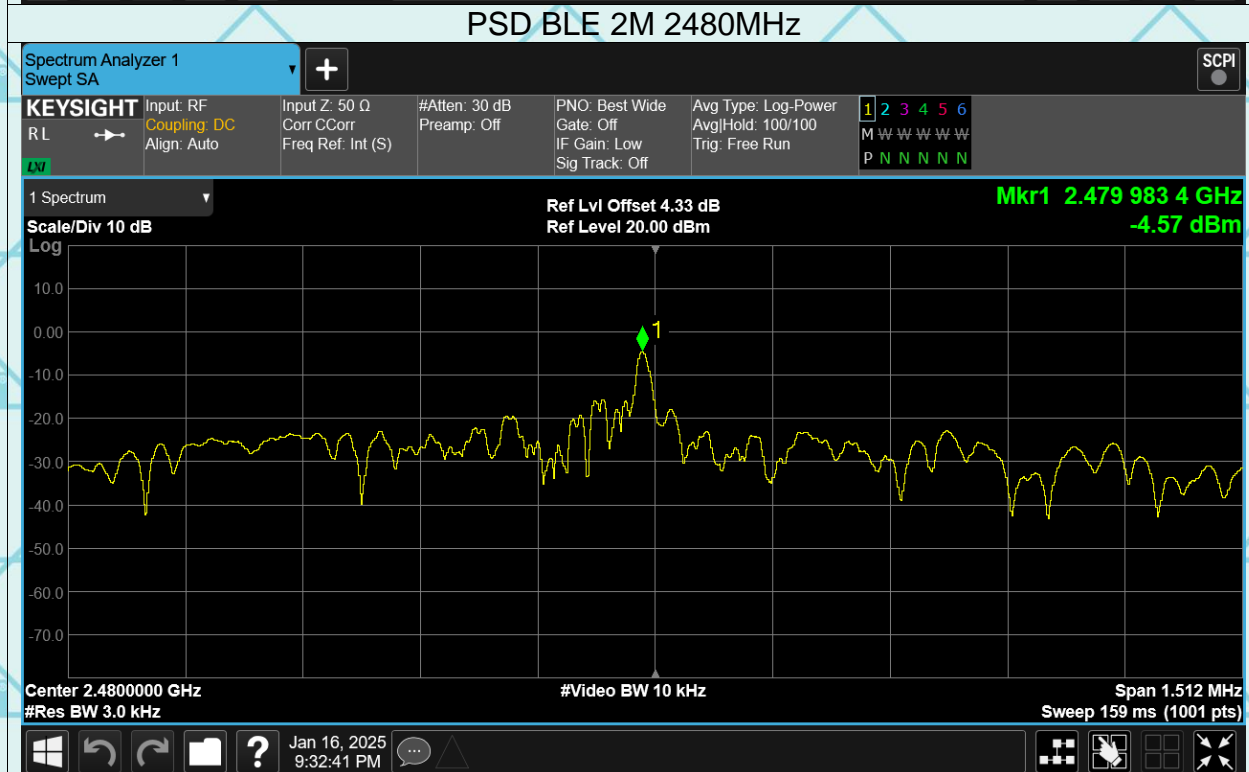
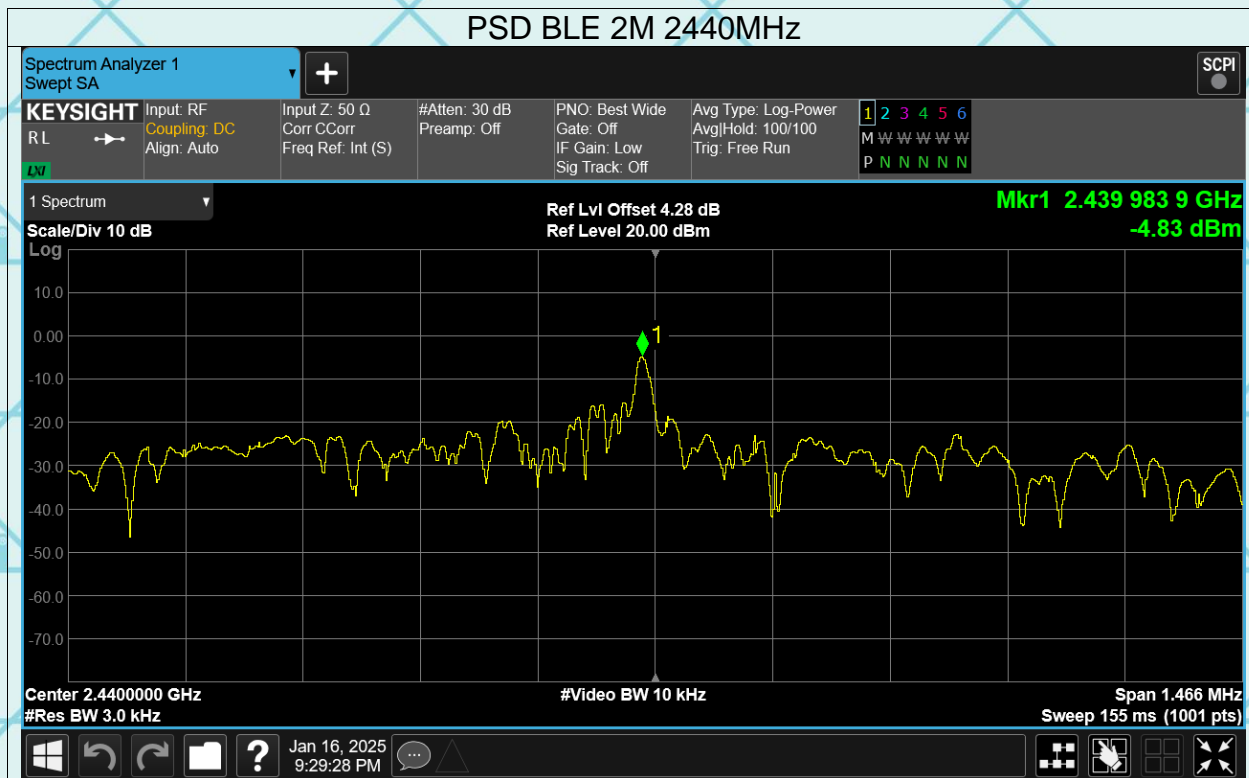



## 6.6. Conducted Band Edge and Spurious Emission Measurement

### 6.6.1. Test Specification

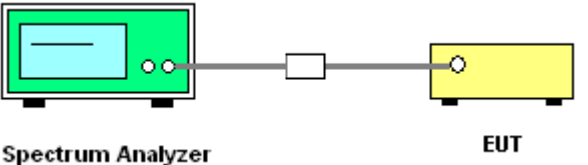
<b>Test Requirement:</b>	FCC Part15 C Section 15.247 (d)
<b>Test Method:</b>	KDB558074
<b>Limit:</b>	In any 100 kHz bandwidth outside of the authorized frequency band, the emissions which fall in the non-restricted bands shall be attenuated at least 20 dB / 30dB relative to the maximum PSD level in 100 kHz by RF conducted measurement and radiated emissions which fall in the restricted bands, as defined in Section 15.205(a), must also comply with the radiated emission limits specified in Section 15.209(a).
<b>Test Setup:</b>	 <p style="text-align: center;">Spectrum Analyzer                      EUT</p>
<b>Test Mode:</b>	Refer to item 4.1
<b>Test Procedure:</b>	<ol style="list-style-type: none"> <li>1. The RF output of EUT was connected to the spectrum analyzer by RF cable and attenuator. The path loss was compensated to the results for each measurement.</li> <li>2. Set to the maximum power setting and enable the EUT transmit continuously.</li> <li>3. Set RBW = 100 kHz, VBW=300 kHz, Peak Detector. Unwanted Emissions measured in any 100 kHz bandwidth outside of the authorized frequency band shall be attenuated by at least 20 dB relative to the maximum in-band peak PSD level in 100 kHz when maximum peak conducted output power procedure is used. If the transmitter complies with the conducted power limits based on the use of RMS averaging over a time interval, the attenuation required under this paragraph shall be 30 dB instead of 20 dB per 15.247(d).</li> <li>4. Measure and record the results in the test report.</li> <li>5. The RF fundamental frequency should be excluded against the limit line in the operating frequency band.</li> </ol>
<b>Test Result:</b>	PASS



Report No.: WSCT-ANAB-R&E241200081A-LE

### Test Data

### Band Edge

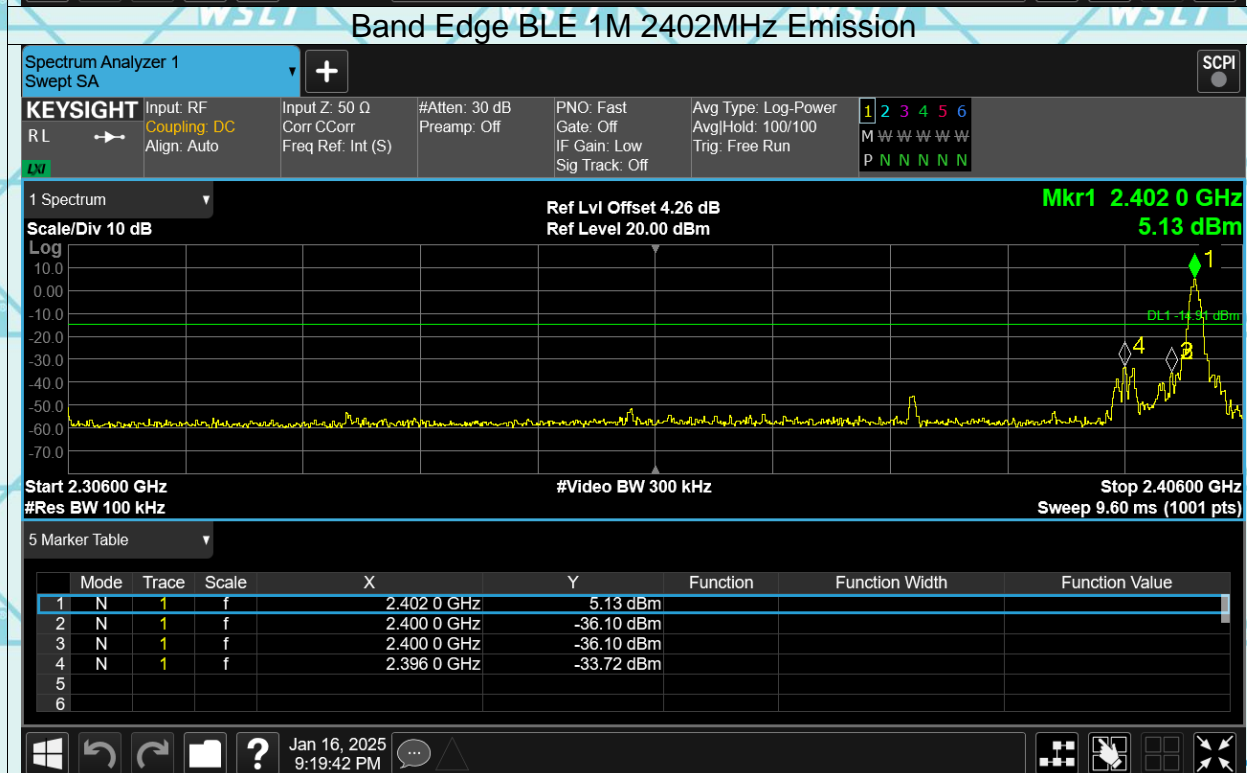
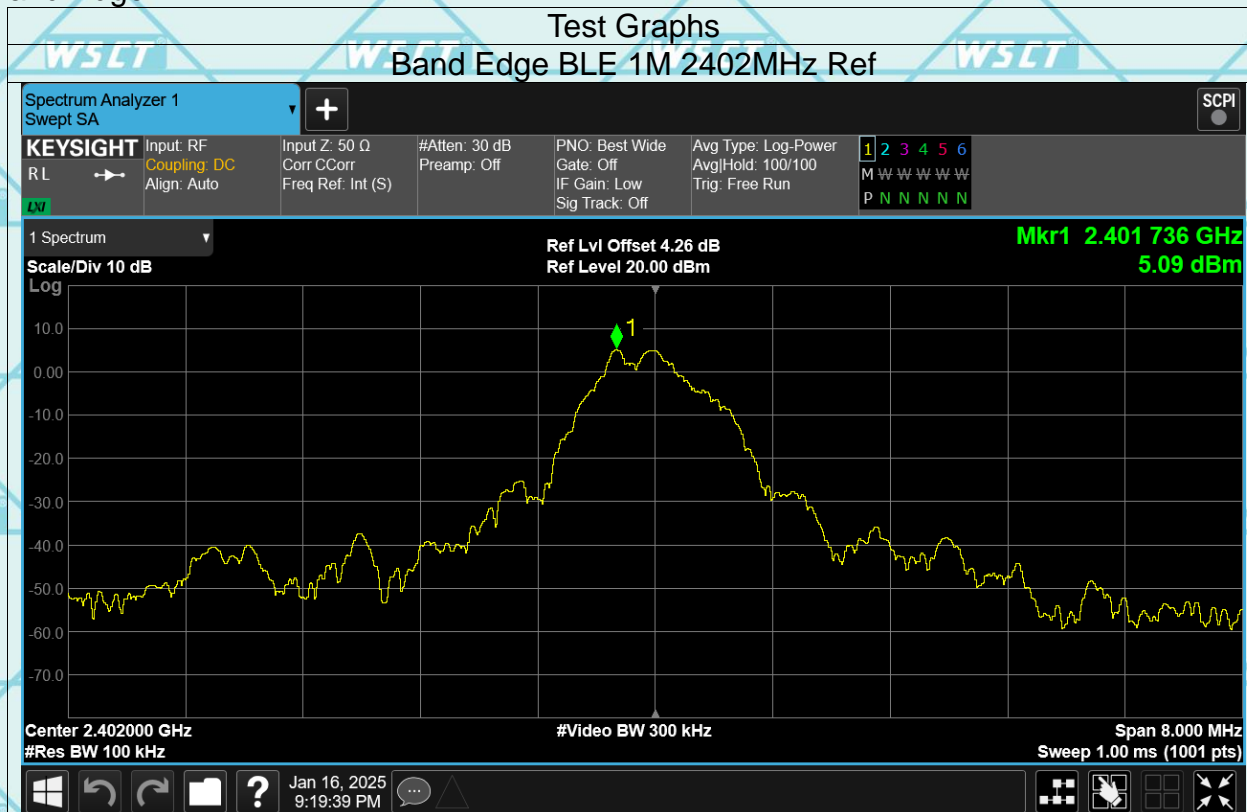



Report No.: WSCT-ANAB-R&E241200081A-LE

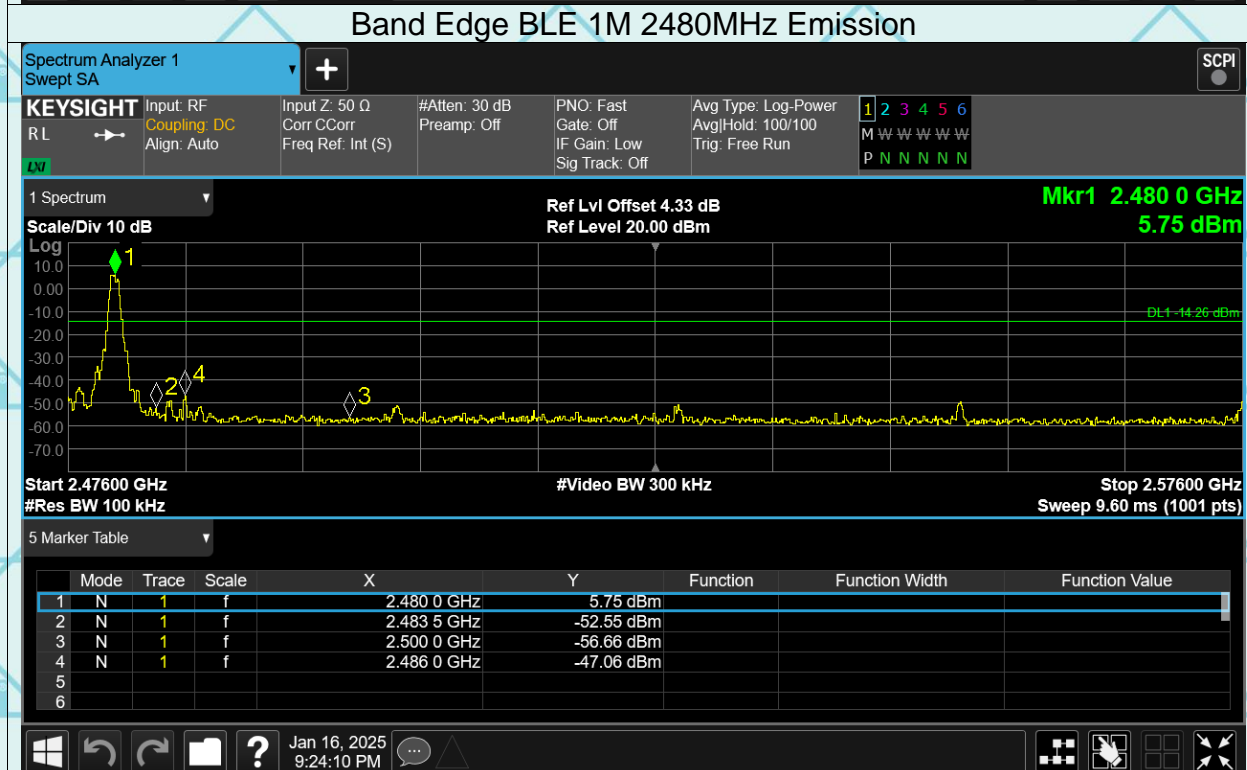
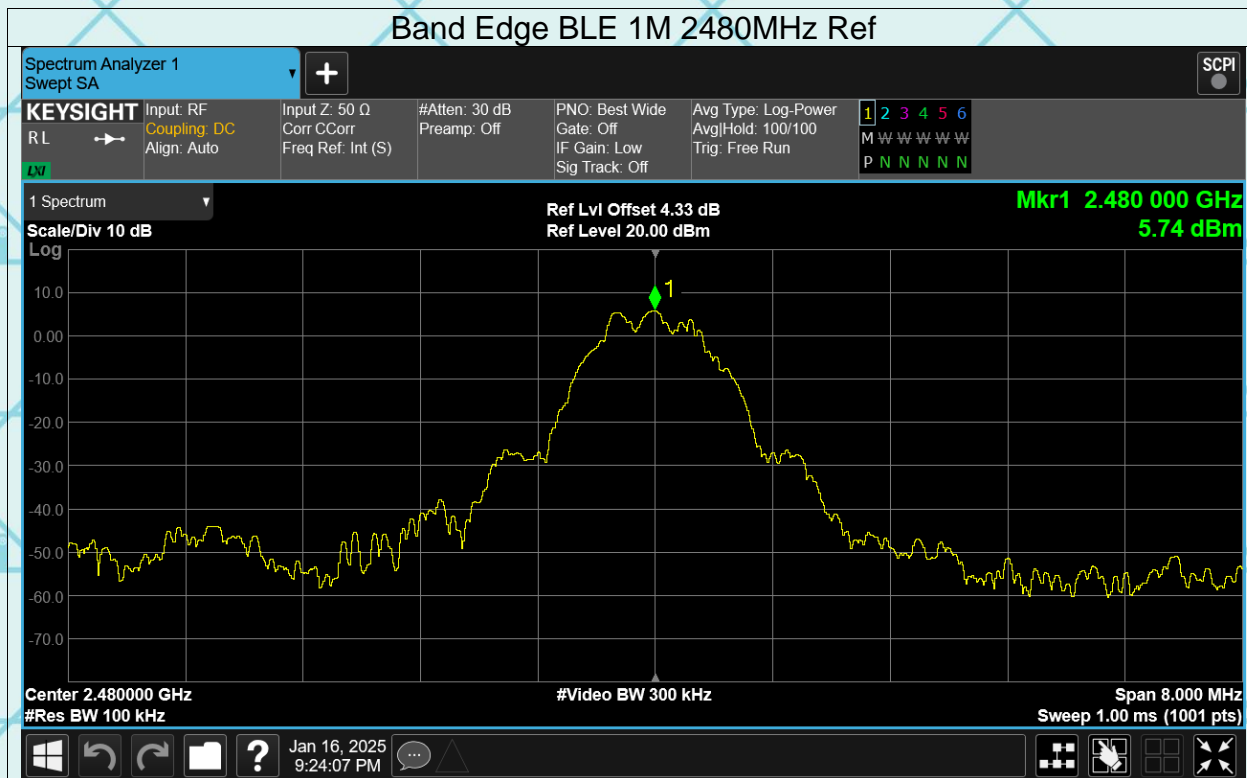



Report No.: WSCT-ANAB-R&E241200081A-LE

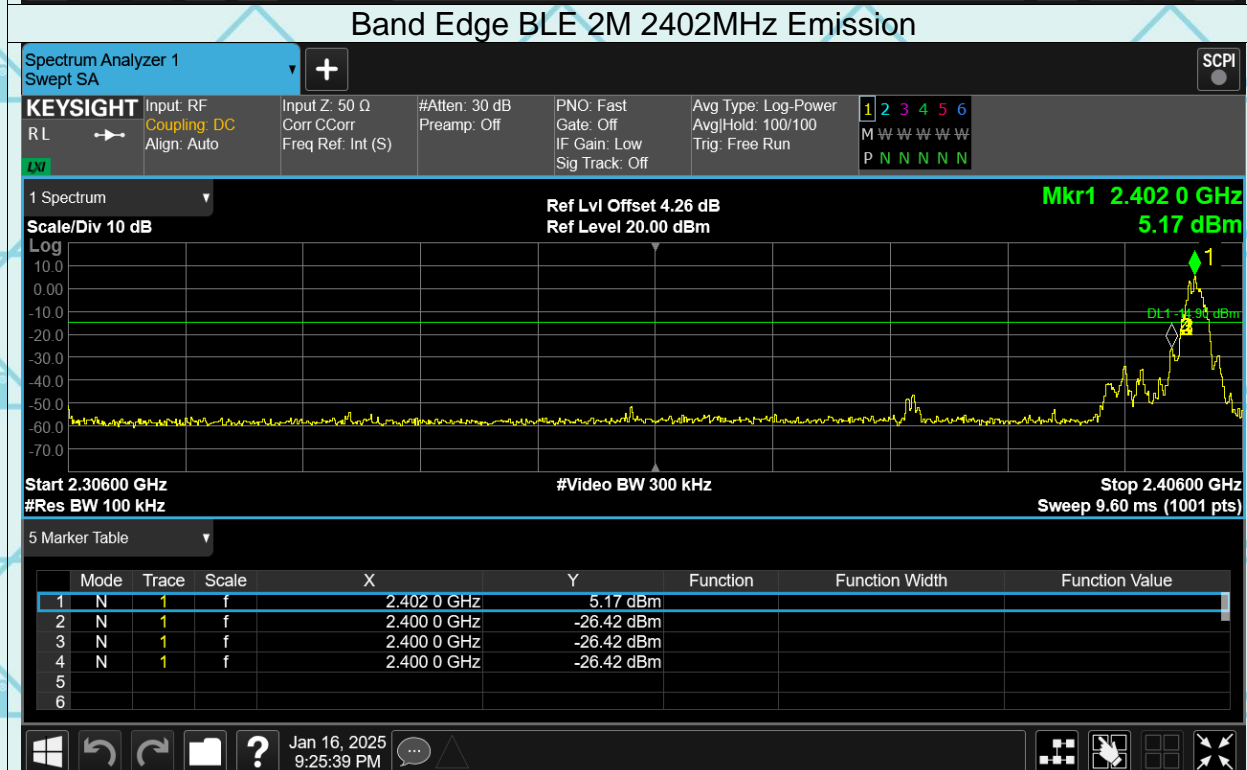
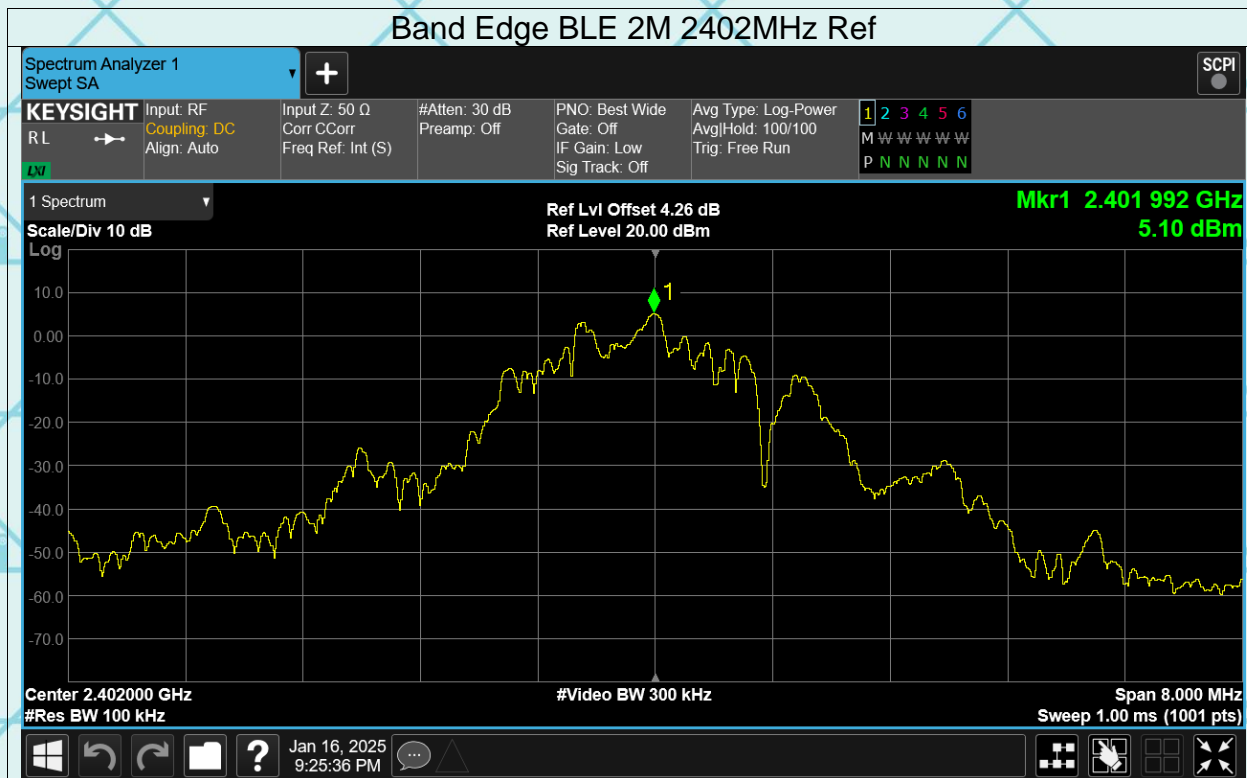



Report No.: WSCT-ANAB-R&E241200081A-LE

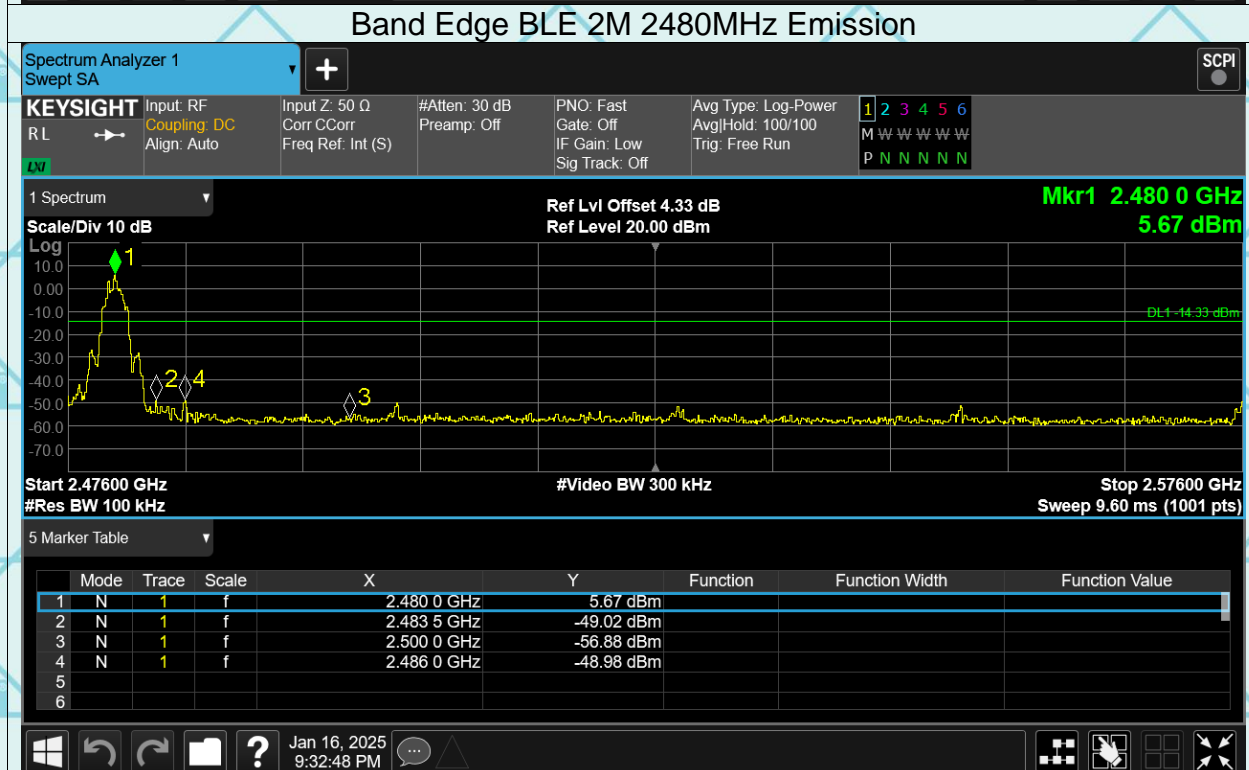
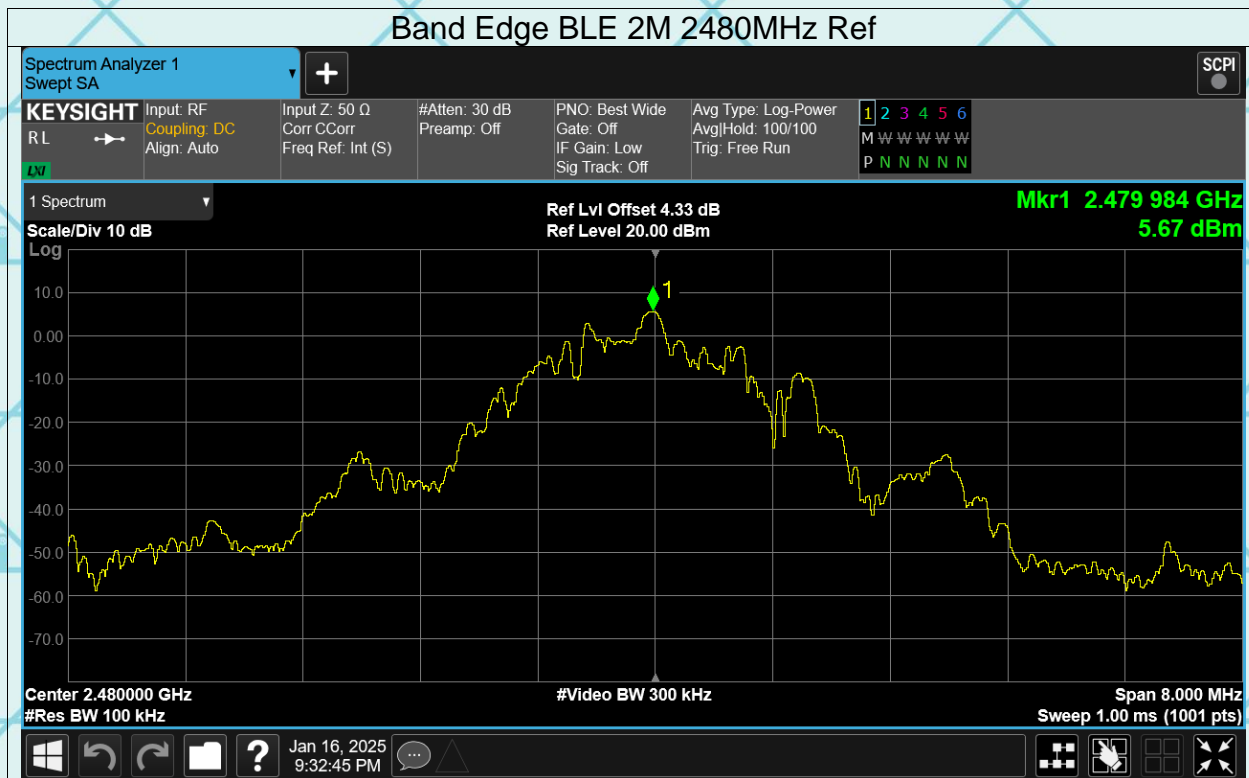

Report No.: WSCT-ANAB-R&E241200081A-LE  
Conducted RF Spurious Emission

### Test Graphs

#### Tx. Spurious BLE 1M 2402MHz Ref

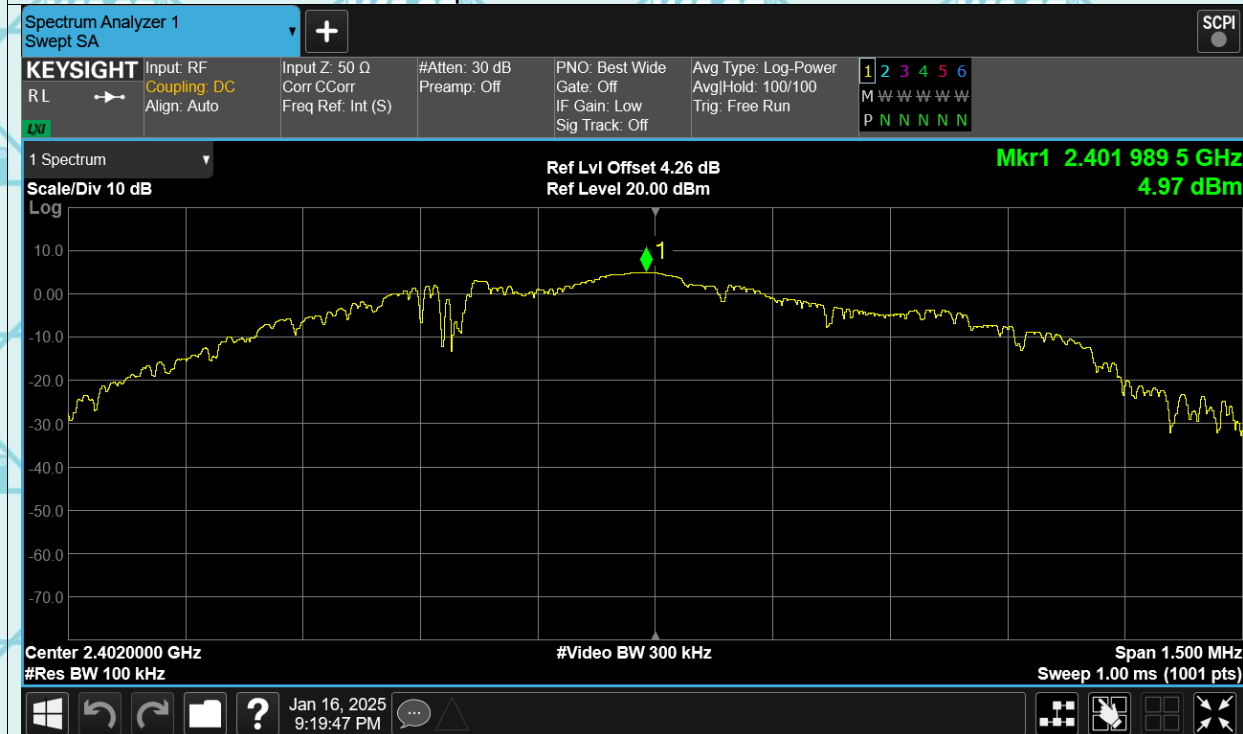

#### Tx. Spurious BLE 1M 2402MHz Emission

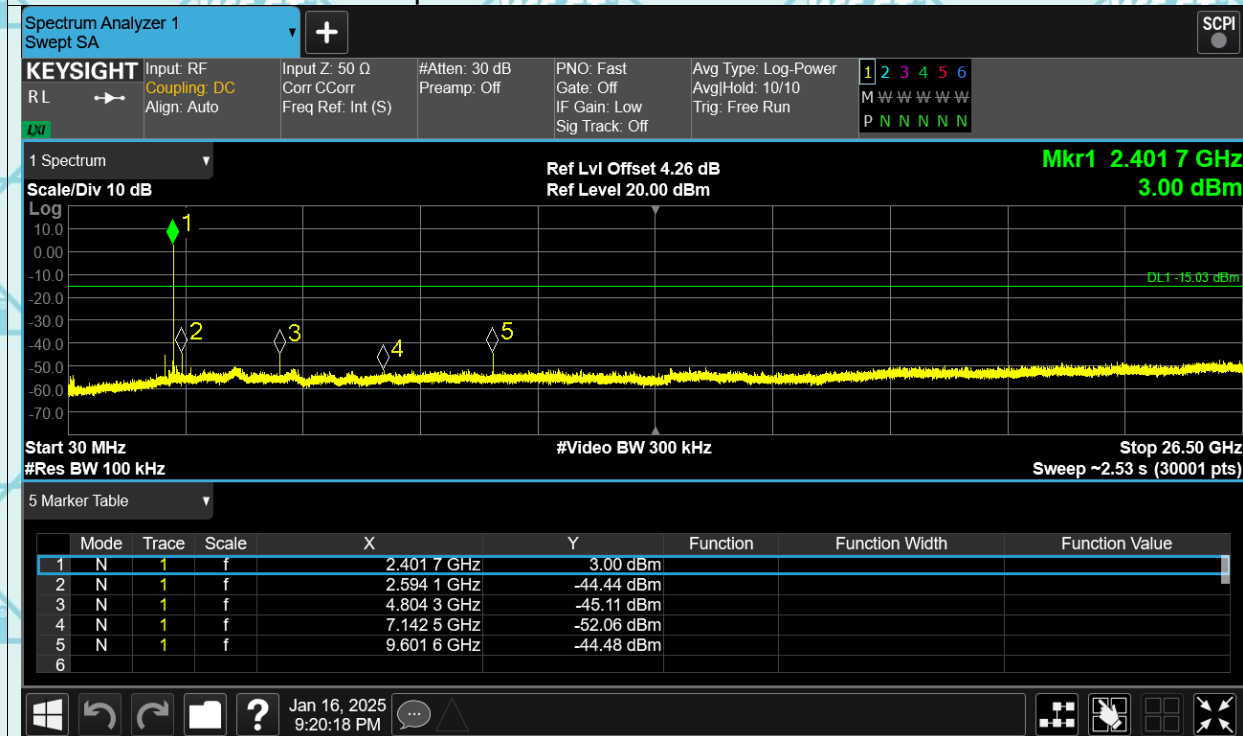



Report No.: WSCT-ANAB-R&E241200081A-LE

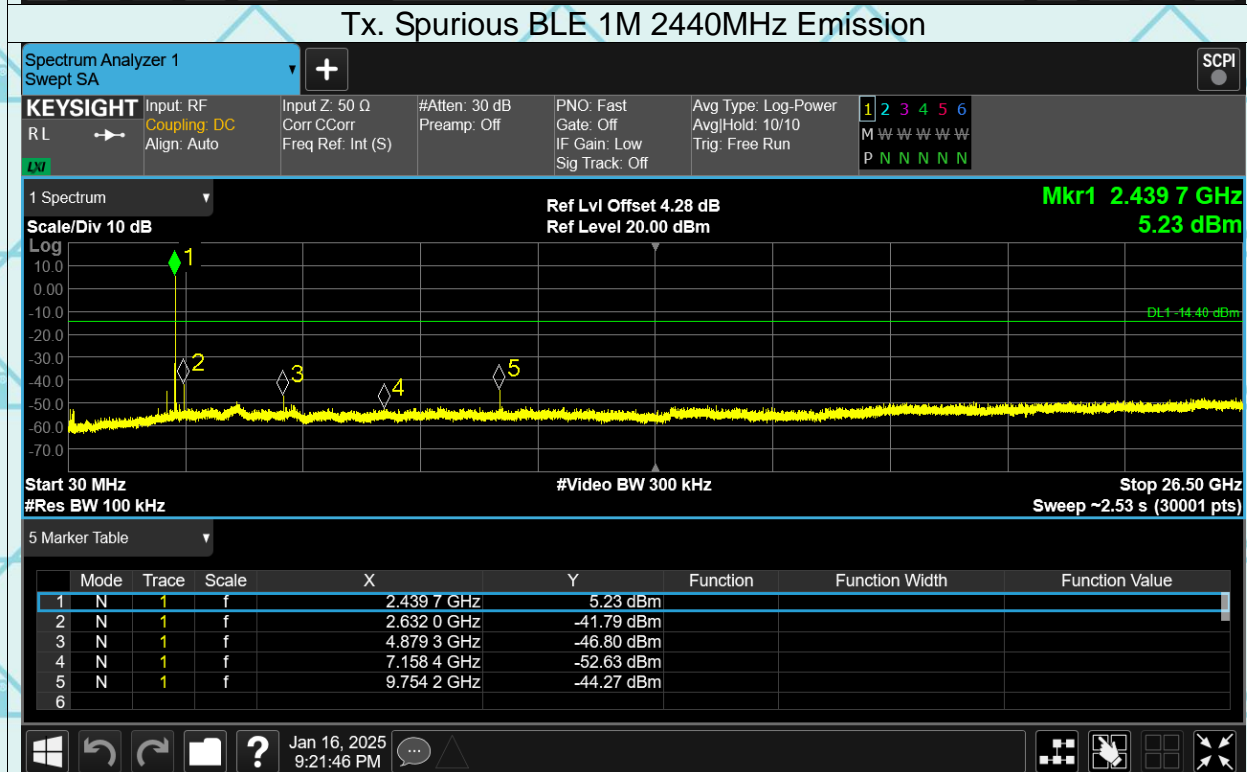
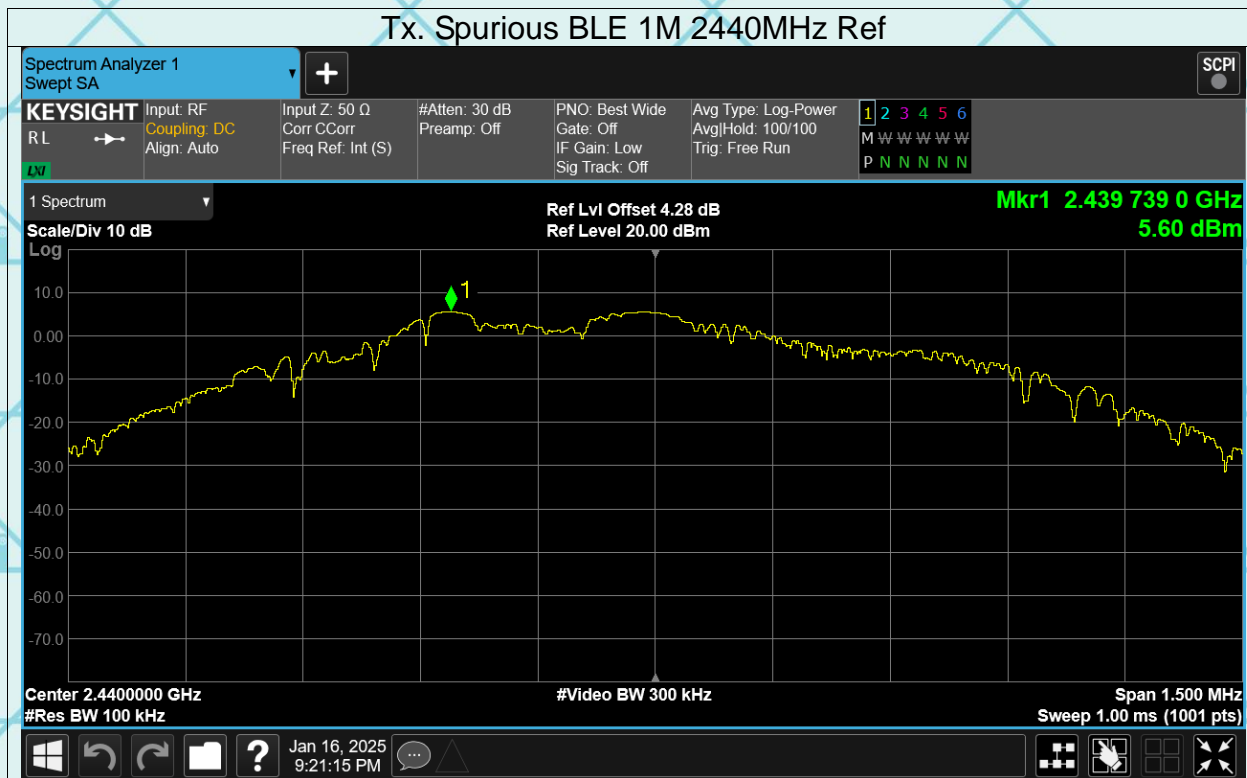

Report No.: WSCT-ANAB-R&E241200081A-LE

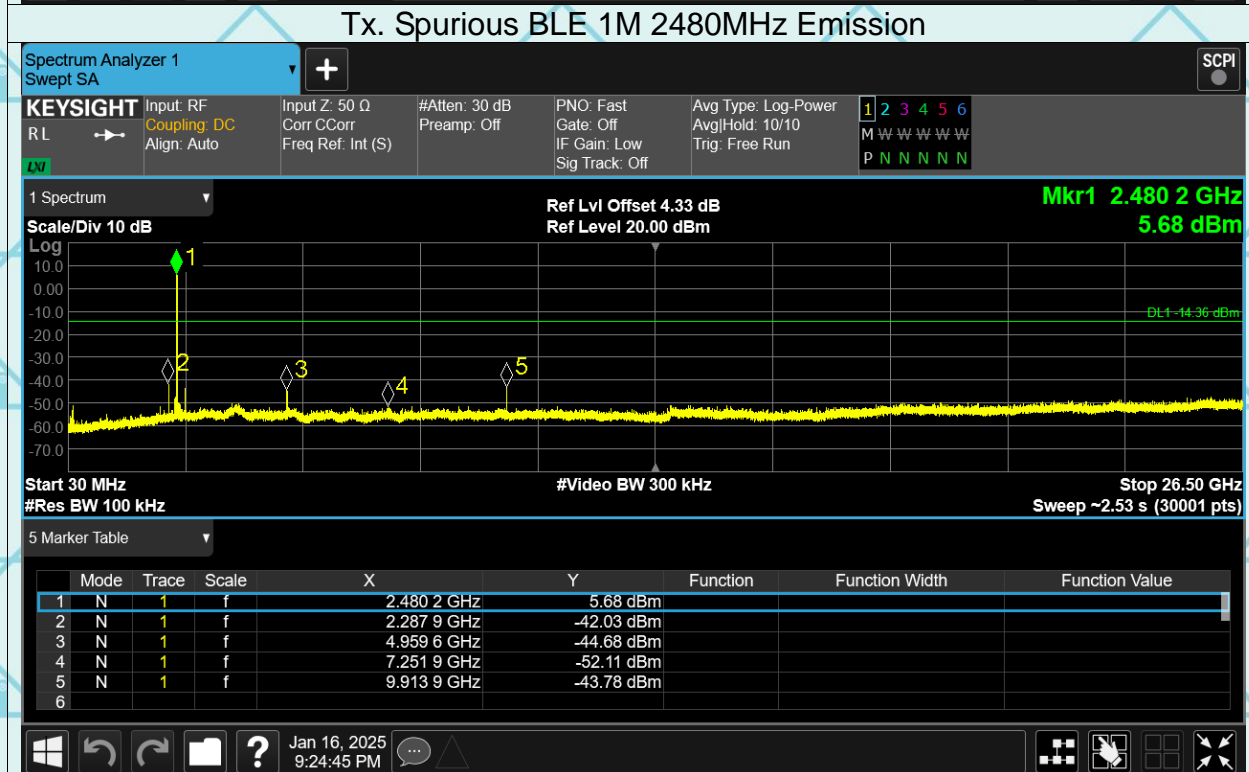
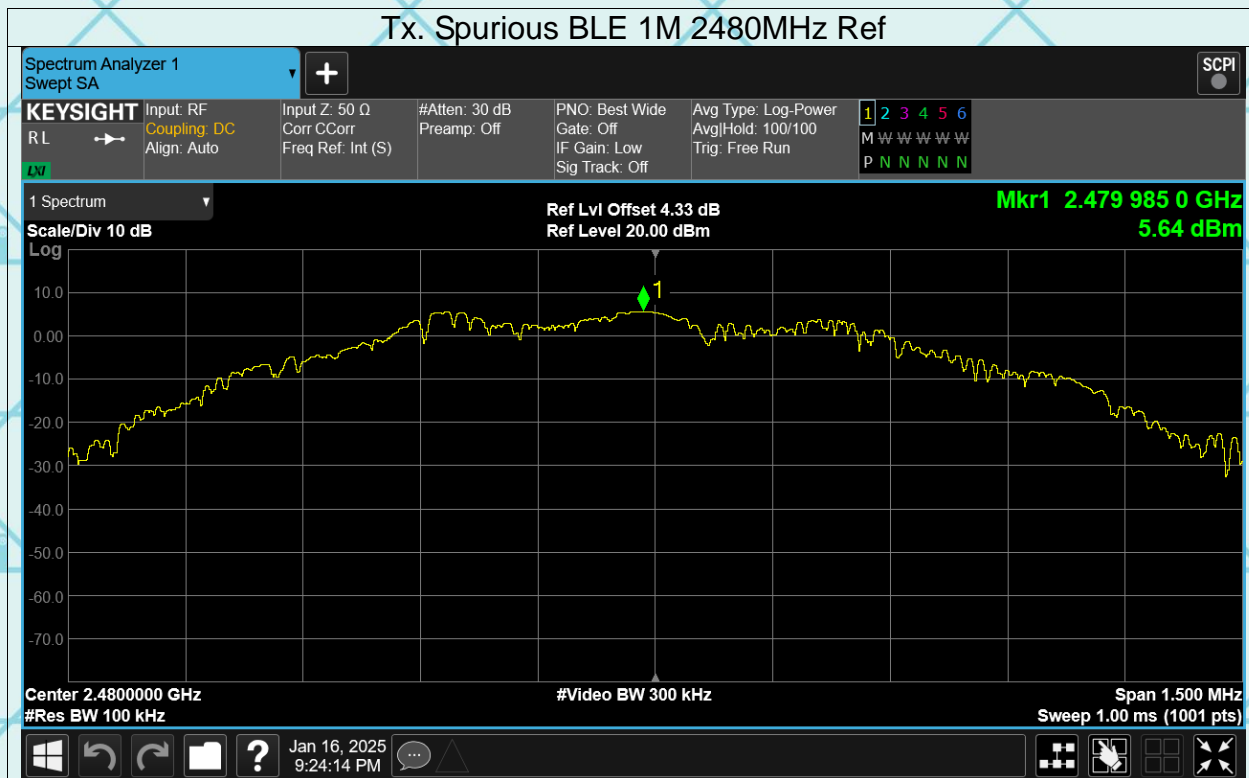



Report No.: WSCT-ANAB-R&E241200081A-LE

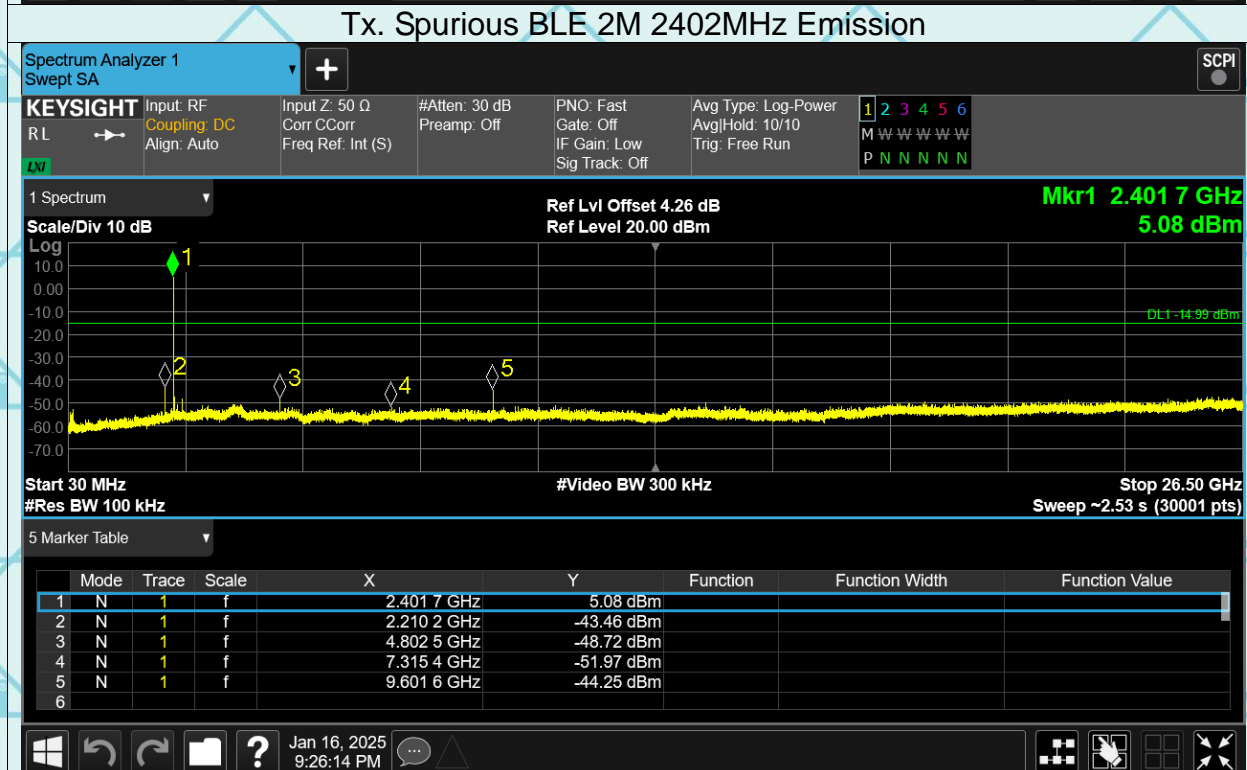
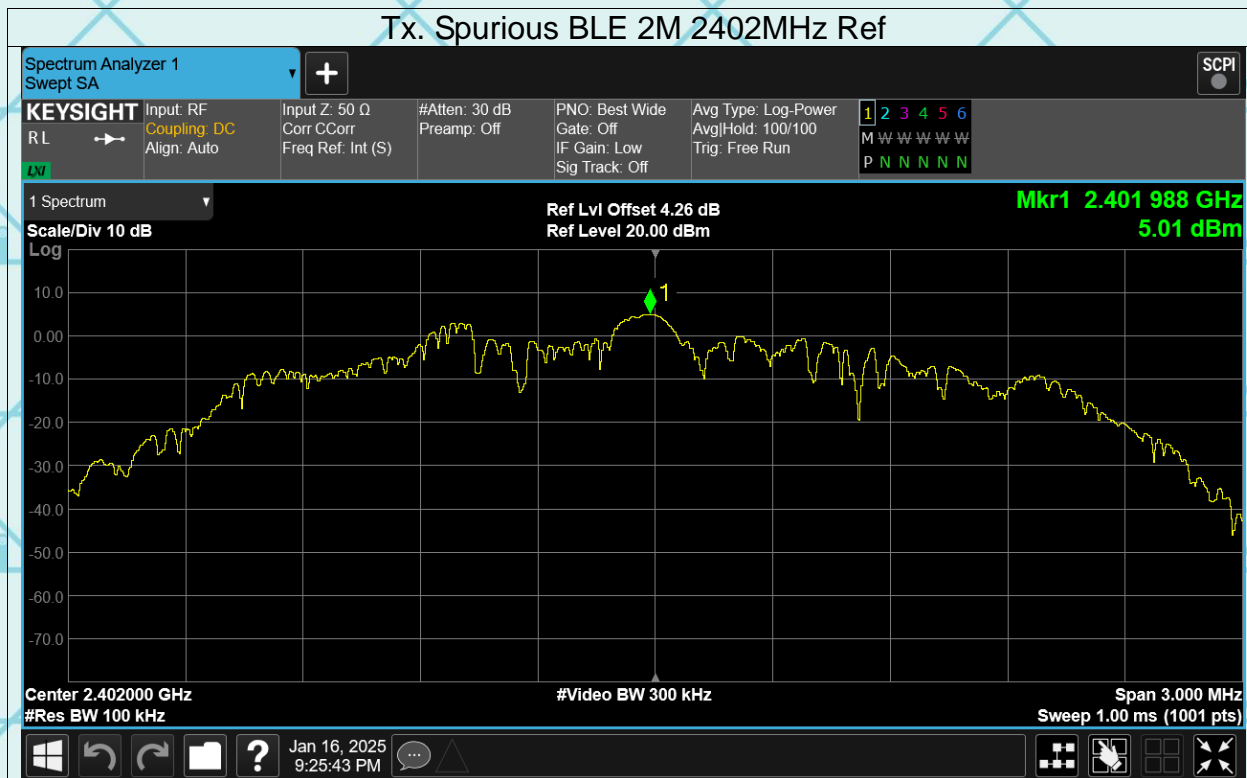

Report No.: WSCT-ANAB-R&E241200081A-LE

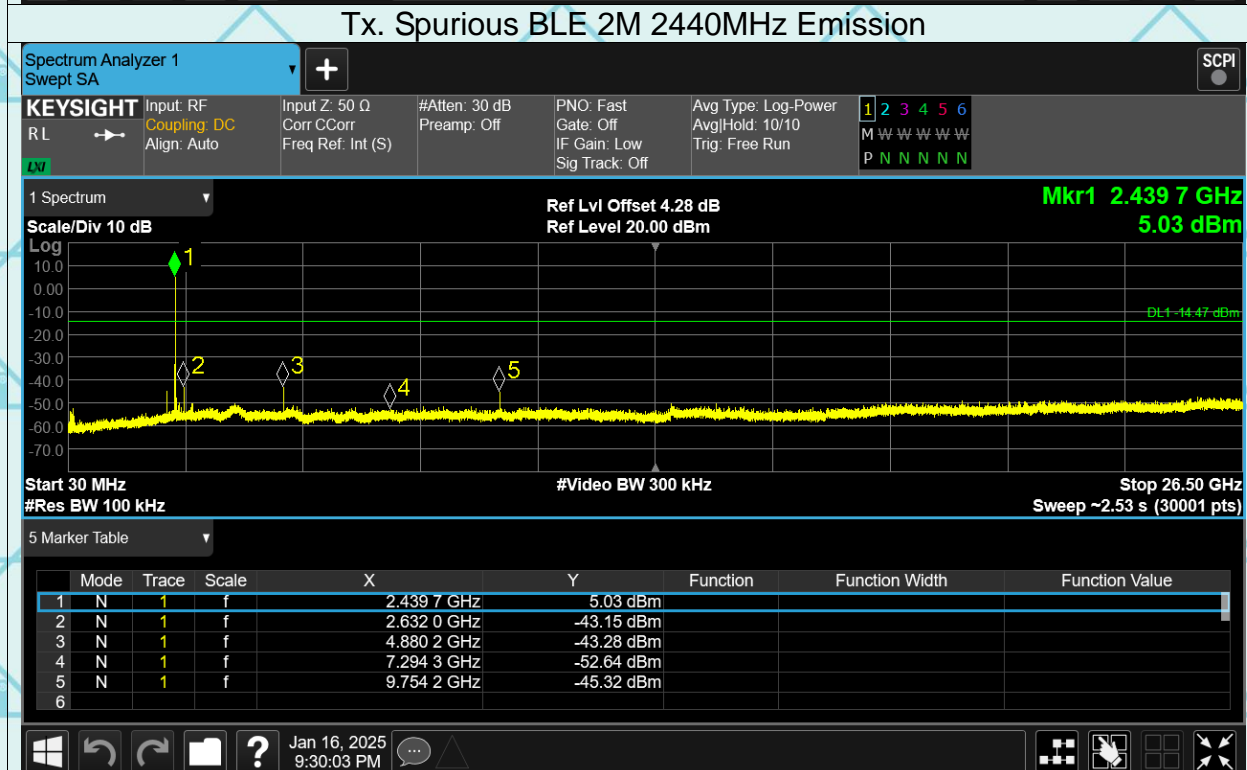
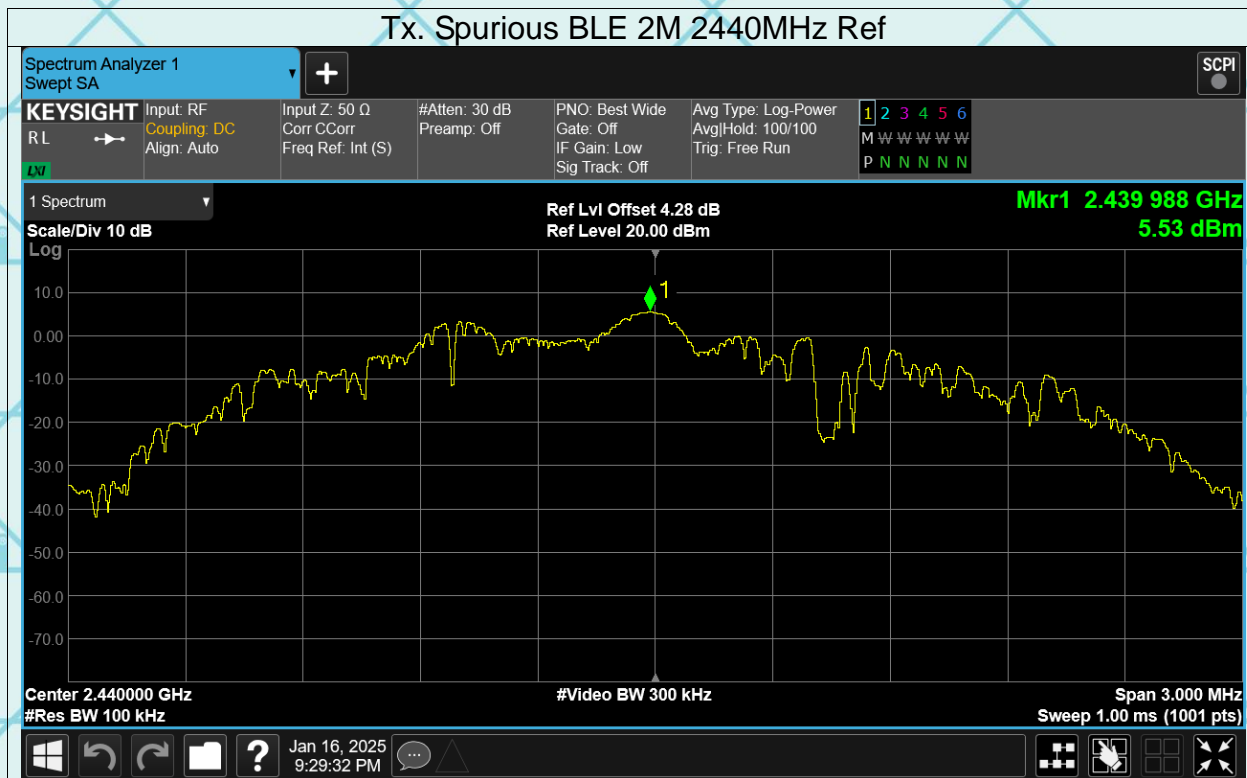



Report No.: WSCT-ANAB-R&E241200081A-LE

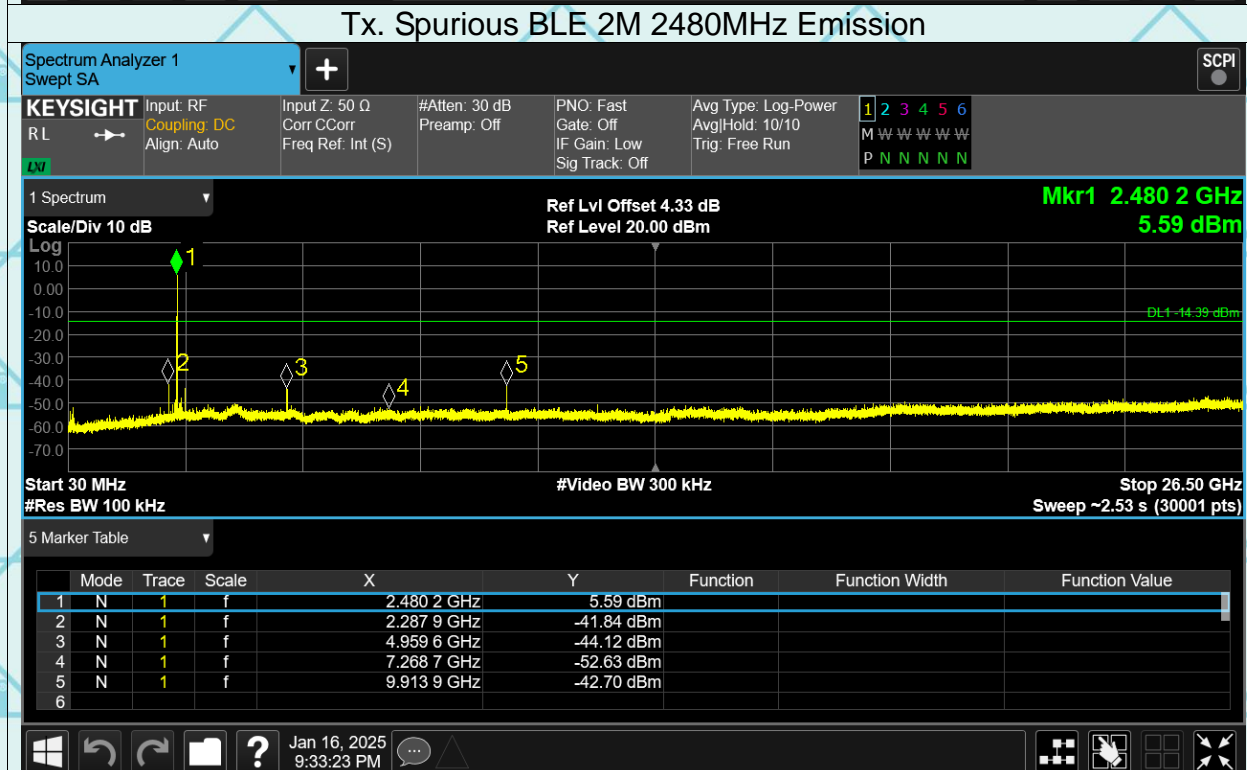
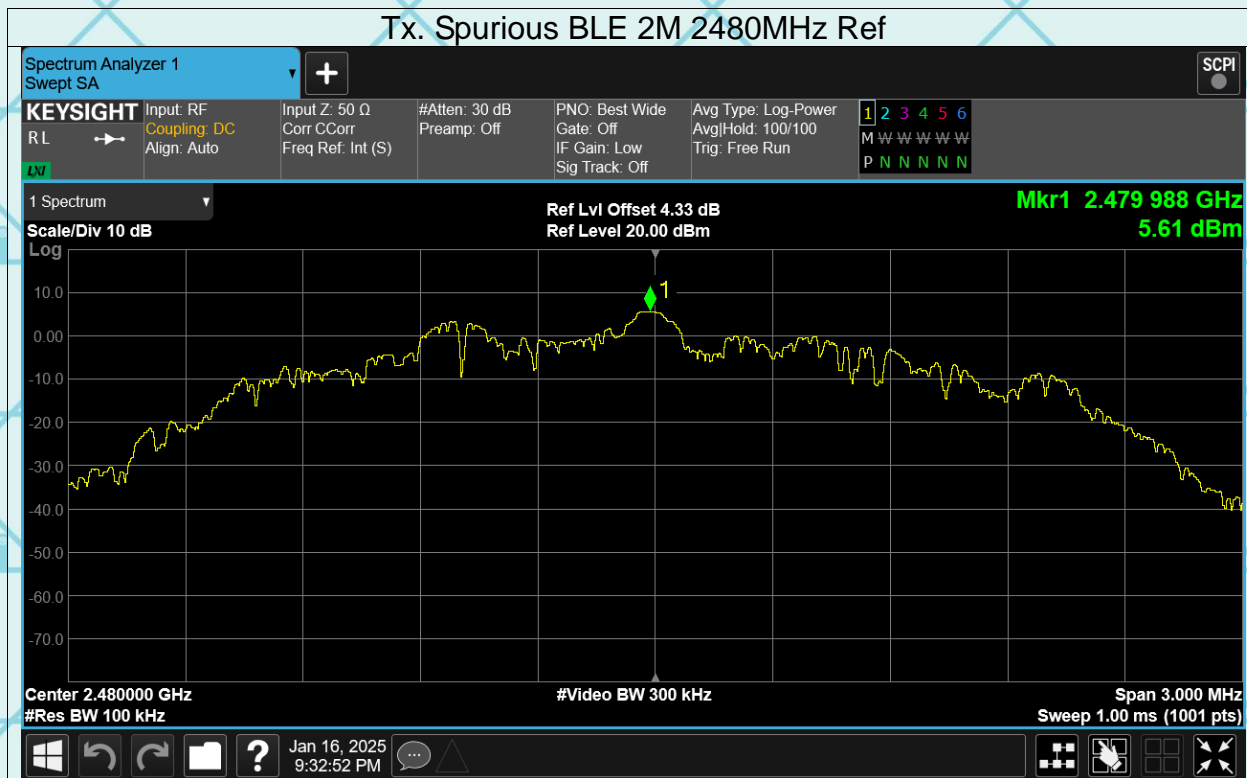

## 6.7. Radiated Spurious Emission Measurement

### 6.7.1. Test Specification

<b>Test Requirement:</b>	FCC Part15 C Section 15.209				
<b>Test Method:</b>	ANSI C63.10:2014				
<b>Frequency Range:</b>	9 kHz to 25 GHz				
<b>Measurement Distance:</b>	3 m				
<b>Antenna Polarization:</b>	Horizontal & Vertical				
<b>Operation mode:</b>	Refer to item 4.1				
<b>Receiver Setup:</b>	Frequency	Detector	RBW	VBW	Remark
	9kHz- 150kHz	Quasi-peak	200Hz	1kHz	Quasi-peak Value
	150kHz- 30MHz	Quasi-peak	9kHz	30kHz	Quasi-peak Value
	30MHz-1GHz	Quasi-peak	100KHz	300KHz	Quasi-peak Value
	Above 1GHz	Peak	1MHz	3MHz	Peak Value
		Peak	1MHz	10Hz	Average Value
<b>Limit:</b>	Frequency	Field Strength (microvolts/meter)	Measurement Distance (meters)		
	0.009-0.490	2400/F(KHz)	300		
	0.490-1.705	24000/F(KHz)	30		
	1.705-30	30	30		
	30-88	100	3		
	88-216	150	3		
	Above 960	500	3		
	Frequency	Field Strength (microvolts/meter)	Measurement Distance (meters)	Detector	
	Above 1GHz	500	3	Average	
		5000	3	Peak	
<b>Test setup:</b>	For radiated emissions below 30MHz				
	30MHz to 1GHz				



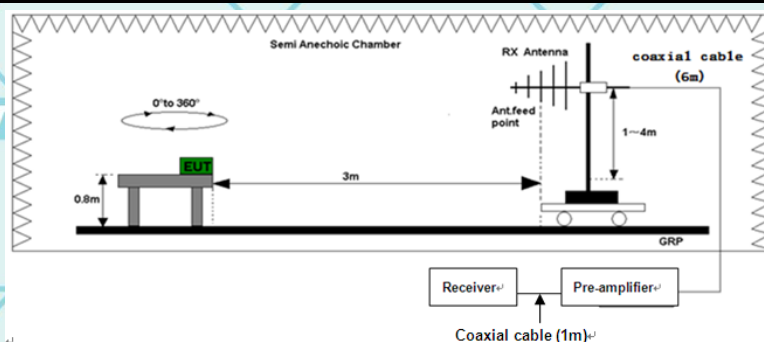

Above 1GHz

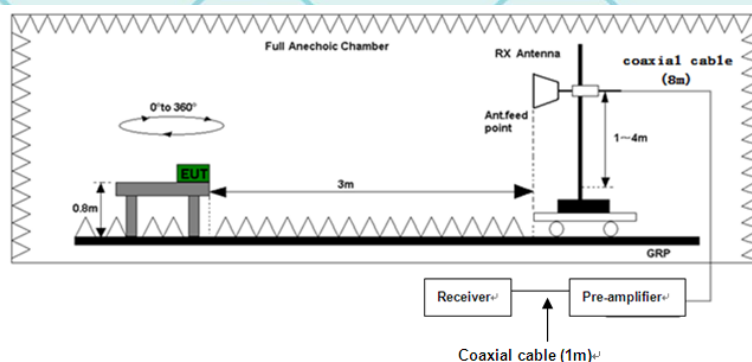

**Test Procedure:**

- For the radiated emission test below 1GHz:  
The EUT was placed on a turntable with 0.1 meter above ground. The EUT was set 3 meters from the interference receiving antenna, which was mounted on the top of a variable height antenna tower. The EUT was arranged to its worst case and then tune the antenna tower (from 1 m to 4 m) and turntable (from 0 degree to 360 degrees) to find the maximum reading. A pre-amp and a high PASS filter are used for the test in order to get better signal level.
- For the radiated emission test above 1GHz:  
Place the measurement antenna on a turntable with 1.5 meter above ground, which is away from each area of the EUT determined to be a source of emissions at the specified measurement distance, while keeping the measurement antenna aimed at the source of emissions at each frequency of significant emissions, with polarization oriented for maximum response. The measurement antenna may have to be higher or lower than the EUT, depending on the radiation pattern of the emission and staying aimed at the emission source for receiving the maximum signal. The final measurement antenna elevation shall be that which maximizes the emissions. The measurement antenna elevation for maximum emissions shall be restricted to a range of heights of from 1 m to 4 m above the ground or reference ground plane.



Report No.: WSCT-ANAB-R&E241200081A-LE

	<p>2. Corrected Reading: Antenna Factor + Cable Loss + Read Level - Preamp Factor = Level</p> <p>3. For measurement below 1GHz, If the emission level of the EUT measured by the peak detector is 3 dB lower than the applicable limit, the peak emission level will be reported. Otherwise, the emission measurement will be repeated using the quasi-peak detector and reported.</p> <p>4. Use the following spectrum analyzer settings:</p> <p>(1) Span shall wide enough to fully capture the emission being measured;</p> <p>(2) Set RBW=100 kHz for <math>f &lt; 1</math> GHz; <math>VBW \geq RBW</math>; Sweep = auto; Detector function = peak; Trace = max hold;</p> <p>(3) Set RBW = 1 MHz, <math>VBW = 3</math> MHz for <math>f \leq 1</math> GHz for peak measurement.</p> <p>For average measurement: <math>VBW = 10</math> Hz, when duty cycle is no less than 98 percent. <math>VBW \geq 1/T</math>, when duty cycle is less than 98 percent where T is the minimum transmission duration over which the transmitter is on and is transmitting at its maximum power control level for the tested mode of operation.</p>
<p><b>Test mode:</b></p>	<p>Refer to section 4.1 for details</p>
<p><b>Test results:</b></p>	<p>PASS</p>

Note: Freq. = Emission frequency in MHz  
 Reading level (dB $\mu$ V) = Receiver reading  
 Corr. Factor (dB) = Attenuation factor + Cable loss  
 Level (dB $\mu$ V) = Reading level (dB $\mu$ V) + Corr. Factor (dB)  
 Limit (dB $\mu$ V) = Limit stated in standard  
 Margin (dB) = Level (dB $\mu$ V) – Limits (dB $\mu$ V)





Report No.: WSCT-ANAB-R&E241200081A-LE

### 6.7.2. Test Data(Worst case)

Please refer to following diagram for individual  
Below 1GHz

The worst mode is BLE Low Channel  
Horizontal:

80.0 dBuV/m

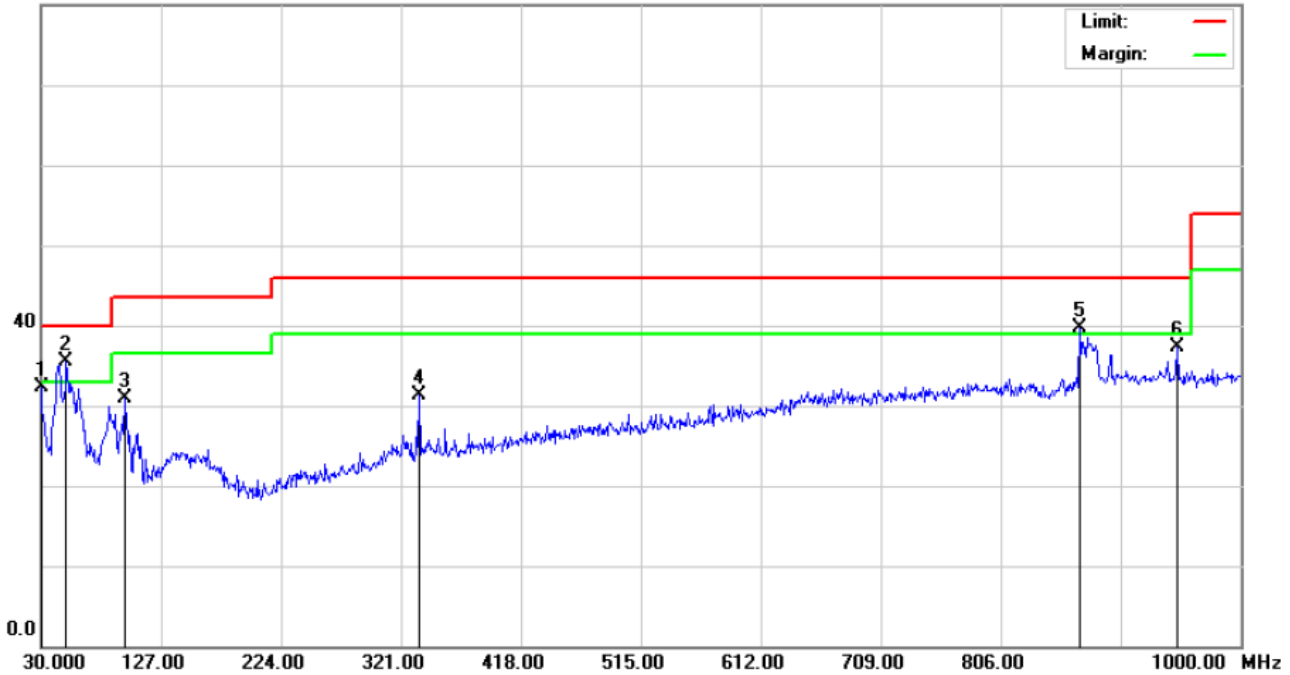

No.	Mk.	Freq. MHz	Reading Level dBuV	Correct Factor dB	Measure- ment dBuV/m	Limit dBuV/m	Over dB	Detector
1		30.0000	34.93	-2.60	32.33	40.00	-7.67	QP
2	*	50.3700	37.73	-2.14	35.59	40.00	-4.41	QP
3		97.9000	36.54	-5.68	30.86	43.50	-12.64	QP
4		335.5500	33.01	-1.68	31.33	46.00	-14.67	QP
5	!	870.0200	32.51	7.14	39.65	46.00	-6.35	QP
6		948.5900	29.25	8.10	37.35	46.00	-8.65	QP



Report No.: WSCT-ANAB-R&E241200081A-LE  
Vertical:

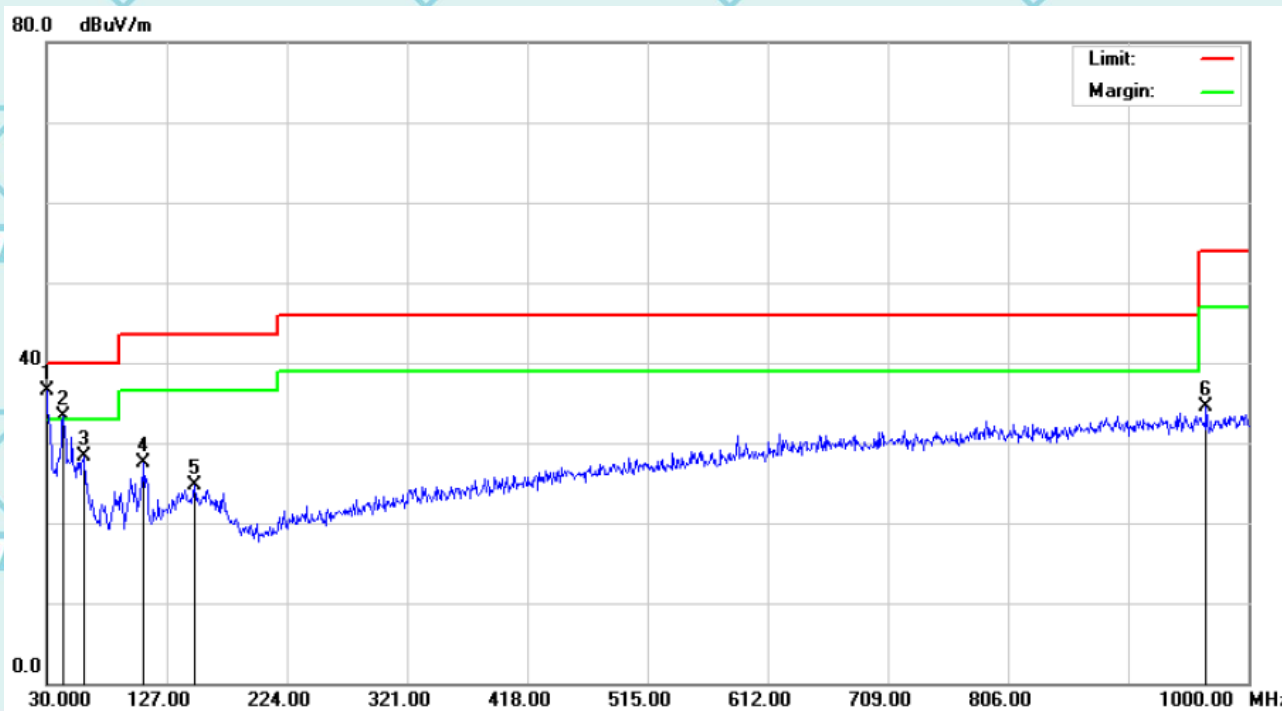

No.	Mk.	Freq. MHz	Reading Level dBuV	Correct Factor dB	Measure- ment dBuV/m	Limit dBuV/m	Over dB	Detector
1	*	30.0000	39.07	-2.60	36.47	40.00	-3.53	QP
2	!	43.5800	35.09	-1.88	33.21	40.00	-6.79	QP
3		60.0700	31.08	-2.82	28.26	40.00	-11.74	QP
4		108.5700	32.21	-4.74	27.47	43.50	-16.03	QP
5		149.3100	26.37	-1.72	24.65	43.50	-18.85	QP
6		966.0500	26.28	8.23	34.51	54.00	-19.49	QP

Note1:

Freq. = Emission frequency in MHz

Reading level (dBuV) = Receiver reading

Corr. Factor (dB) = Antenna factor + Cable loss - Amplifier factor.

Measurement (dBuV) = Reading level (dBuV) + Corr. Factor (dB)

Limit (dBuV) = Limit stated in standard

Margin (dB) = Measurement (dBuV) – Limits (dBuV)





Report No.: WSCT-ANAB-R&E241200081A-LE

**Above 1GHz**

Note 1: The marked spikes near 2400 MHz with circle should be ignored because they are Fundamental signal.

Note 2: The spurious above 18G is noise only, do not show on the report.

Low channel: 2402MHz

Horizontal:

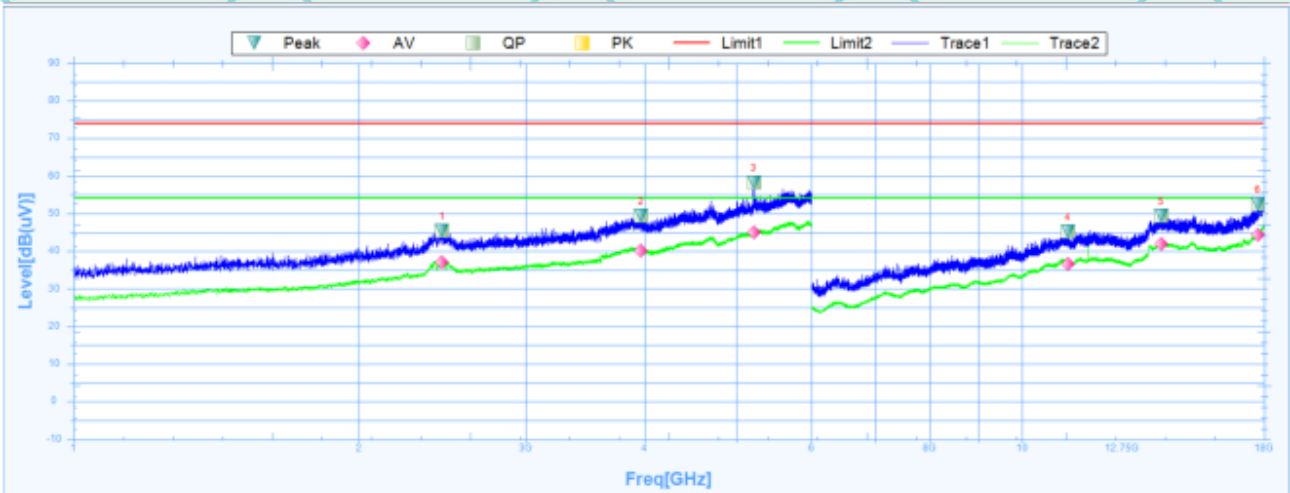

**Susputed Data List**

NO.	Freq. [MHz]	Reading [dB(uV)]	Factor [dB]	Level [dB(uV)]	Limit [dB]	Margin [dB]	Deg [°]	Polarity	Trace	Verdict
1	2447.5000	45.46	7.73	37.73	74	-28.54	190.6	Horizontal	PK	Pass
1	2447.5000	37.14	7.73	29.41	54	-16.86	190.6	Horizontal	AV	Pass
2	3968.7500	49.4	11.92	37.48	74	-24.6	257.5	Horizontal	PK	Pass
2	3968.7500	40.16	11.92	28.24	54	-13.84	257.5	Horizontal	AV	Pass
3	5216.2500	58.33	18.51	39.82	74	-15.67	153.4	Horizontal	PK	Pass
3	5216.2500	45	18.51	26.49	54	-9	153.4	Horizontal	AV	Pass
4	11179.5000	45.14	39.34	5.8	74	-28.86	275.8	Horizontal	PK	Pass
4	11179.5000	36.59	39.34	-2.75	54	-17.41	275.8	Horizontal	AV	Pass
5	14023.5000	49.36	41.47	7.89	74	-24.64	127.5	Horizontal	PK	Pass
5	14023.5000	41.95	41.47	0.48	54	-12.05	127.5	Horizontal	AV	Pass
6	17731.5000	52.44	44.7	7.74	74	-21.56	-0.1	Horizontal	PK	Pass
6	17731.5000	44.4	44.7	-0.3	54	-9.6	-0.1	Horizontal	AV	Pass



Report No.: WSCT-ANAB-R&E241200081A-LE

Vertical :

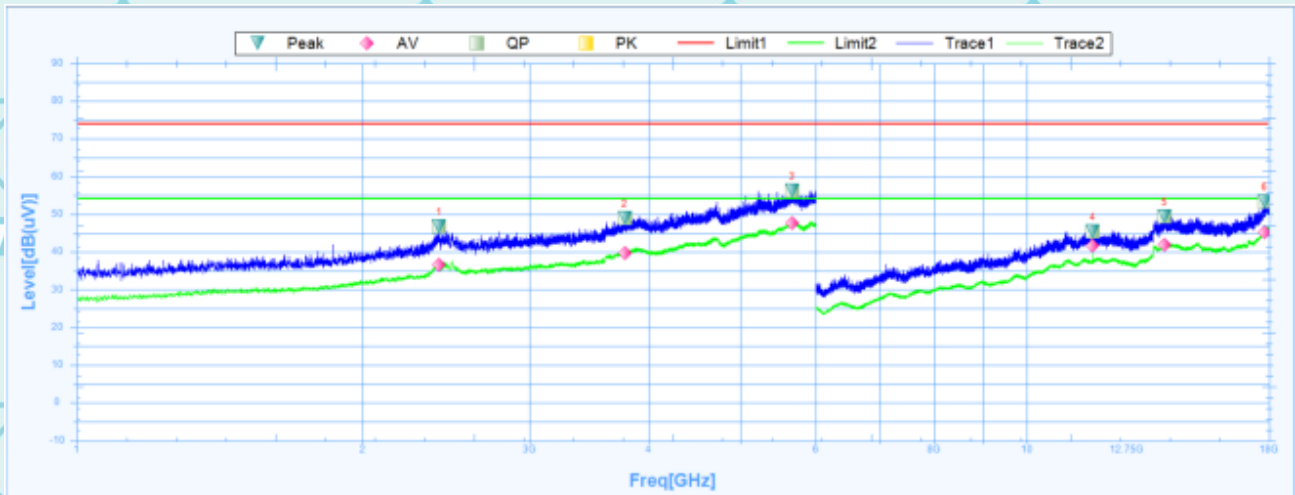

Suspected Data List										
NO.	Freq. [MHz]	Reading [dB(uV)]	Factor [dB]	Level [dB(uV)]	Limit [dB]	Margin [dB]	Deg [°]	Polarity	Trace	Verdict
1	2406.8750	46.7	7.59	39.11	74	-27.3	87.8	Vertical	PK	Pass
1	2406.8750	36.63	7.59	29.04	54	-17.37	87.8	Vertical	AV	Pass
2	3775.6250	48.97	10.85	38.12	74	-25.03	0.5	Vertical	PK	Pass
2	3775.6250	39.77	10.85	28.92	54	-14.23	0.5	Vertical	AV	Pass
3	5668.7500	56.25	21.13	35.12	74	-17.75	0.5	Vertical	PK	Pass
3	5668.7500	47.69	21.13	26.56	54	-6.31	0.5	Vertical	AV	Pass
4	11745.0000	45.4	38.83	6.57	74	-28.6	204.1	Vertical	PK	Pass
4	11745.0000	41.63	38.83	2.8	54	-12.37	204.1	Vertical	AV	Pass
5	13978.5000	49.44	41.44	8	74	-24.56	0.2	Vertical	PK	Pass
5	13978.5000	41.93	41.44	0.49	54	-12.07	0.2	Vertical	AV	Pass
6	17811.0000	53.34	45.23	8.11	74	-20.66	71.4	Vertical	PK	Pass
6	17811.0000	45.25	45.23	0.02	54	-8.75	71.4	Vertical	AV	Pass





Report No.: WSCT-ANAB-R&E241200081A-LE  
Middle channel: 2440MHz  
Horizontal:

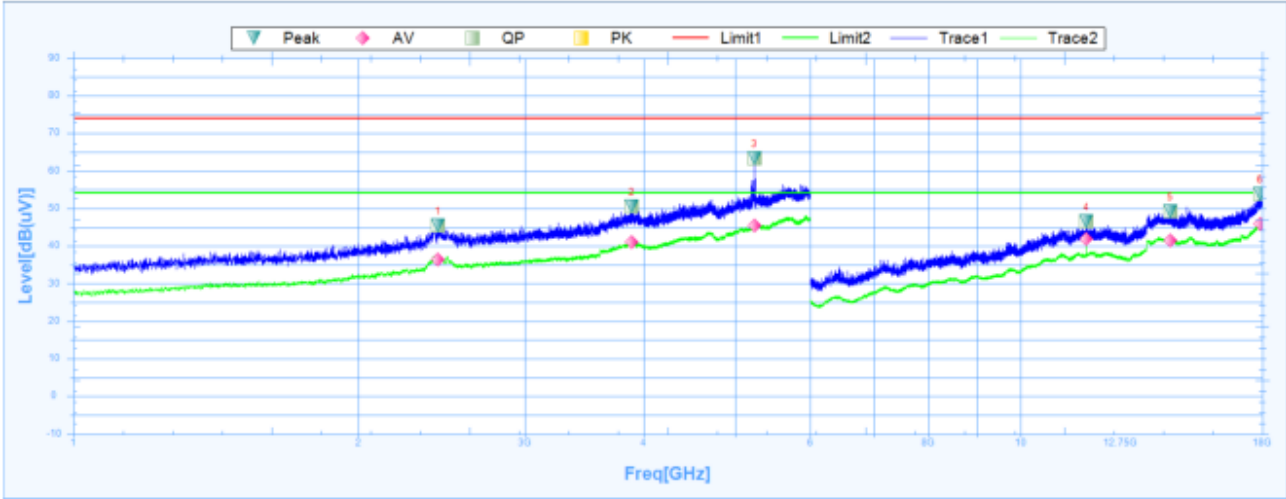

**Susputed Data List**

NO.	Freq. [MHz]	Reading [dB(uV)]	Factor [dB]	Level [dB(uV)]	Limit [dB]	Margin [dB]	Deg [°]	Polarity	Trace	Verdict
1	2426.8750	45.54	7.66	37.88	74	-28.46	48.3	Horizontal	PK	Pass
1	2426.8750	36.48	7.66	28.82	54	-17.52	48.3	Horizontal	AV	Pass
2	3889.3750	50.57	11.64	38.93	74	-23.43	60.2	Horizontal	PK	Pass
2	3889.3750	41.04	11.64	29.4	54	-12.96	60.2	Horizontal	AV	Pass
3	5239.3750	63.33	18.94	44.39	74	-10.67	65	Horizontal	PK	Pass
3	5239.3750	45.52	18.94	26.58	54	-8.48	65	Horizontal	AV	Pass
4	11745.0000	46.51	38.83	7.68	74	-27.49	192.2	Horizontal	PK	Pass
4	11745.0000	41.86	38.83	3.03	54	-12.14	192.2	Horizontal	AV	Pass
5	14401.5000	49.25	40.98	8.27	74	-24.75	230.5	Horizontal	PK	Pass
5	14401.5000	41.45	40.98	0.47	54	-12.55	230.5	Horizontal	AV	Pass
6	17908.5000	53.89	45.89	8	74	-20.11	103.8	Horizontal	PK	Pass
6	17908.5000	45.93	45.89	0.04	54	-8.07	103.8	Horizontal	AV	Pass



Report No.: WSCT-ANAB-R&E241200081A-LE  
Vertical:

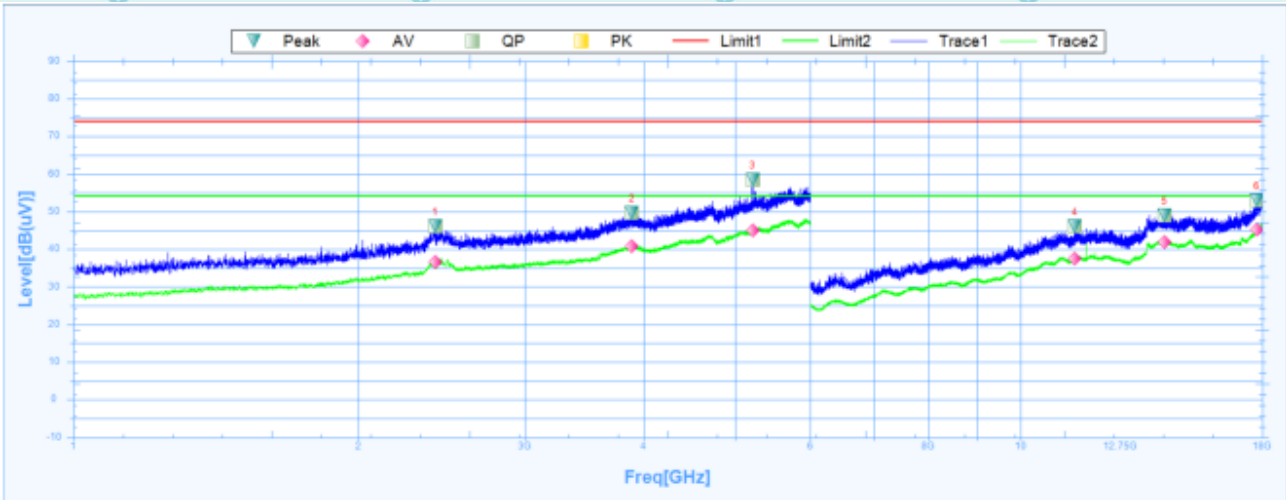

Suspected Data List										
NO.	Freq. [MHz]	Reading [dB(uV)]	Factor [dB]	Level [dB(uV)]	Limit [dB]	Margin [dB]	Deg [°]	Polarity	Trace	Verdict
1	2410.0000	46.15	7.6	38.55	74	-27.85	264.7	Vertical	PK	Pass
1	2410.0000	36.66	7.6	29.06	54	-17.34	264.7	Vertical	AV	Pass
2	3890.0000	49.7	11.65	38.05	74	-24.3	341.2	Vertical	PK	Pass
2	3890.0000	40.76	11.65	29.11	54	-13.24	341.2	Vertical	AV	Pass
3	5215.0000	58.41	18.49	39.92	74	-15.59	118.9	Vertical	PK	Pass
3	5215.0000	45.03	18.49	26.54	54	-8.97	118.9	Vertical	AV	Pass
4	11416.5000	46.15	39.13	7.02	74	-27.85	356.6	Vertical	PK	Pass
4	11416.5000	37.52	39.13	-1.61	54	-16.48	356.6	Vertical	AV	Pass
5	14197.5000	49.08	41.24	7.84	74	-24.92	-0.1	Vertical	PK	Pass
5	14197.5000	41.85	41.24	0.61	54	-12.15	-0.1	Vertical	AV	Pass
6	17767.5000	52.87	44.94	7.93	74	-21.13	359.6	Vertical	PK	Pass
6	17767.5000	45.13	44.94	0.19	54	-8.87	359.6	Vertical	AV	Pass





Report No.: WSCT-ANAB-R&E241200081A-LE  
High channel: 2480MHz  
Horizontal:

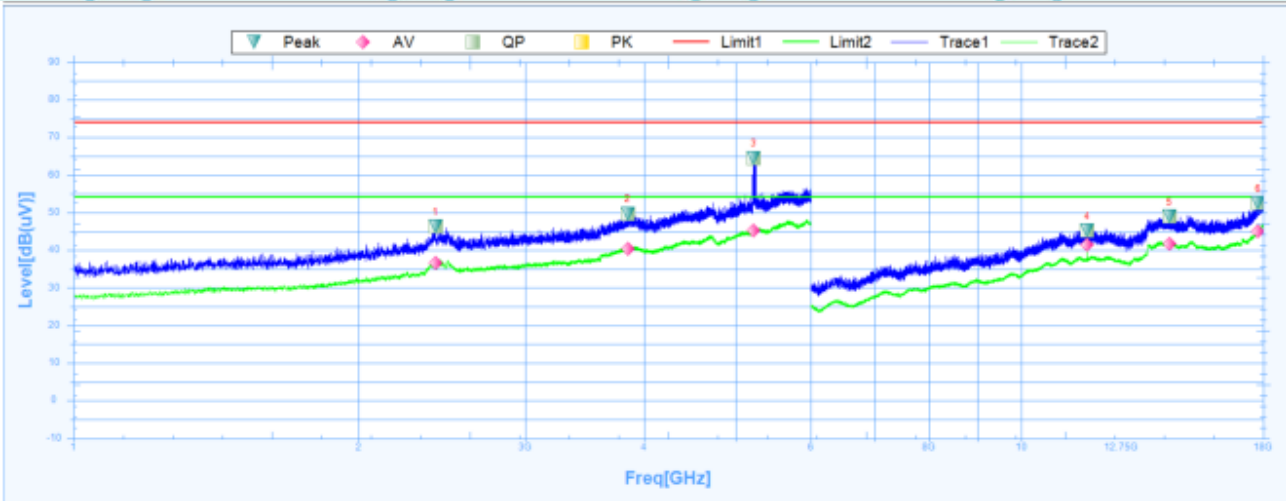

Suspected Data List										
NO.	Freq. [MHz]	Reading [dB(uV)]	Factor [dB]	Level [dB(uV)]	Limit [dB]	Margin [dB]	Deg [°]	Polarity	Trace	Verdict
1	2409.3750	46.42	7.6	38.82	74	-27.58	0.5	Horizontal	PK	Pass
1	2409.3750	36.71	7.6	29.11	54	-17.29	0.5	Horizontal	AV	Pass
2	3845.6250	49.76	11.28	38.48	74	-24.24	166.7	Horizontal	PK	Pass
2	3845.6250	40.39	11.28	29.11	54	-13.61	166.7	Horizontal	AV	Pass
3	5223.7500	64.56	18.65	45.91	74	-9.44	0.5	Horizontal	PK	Pass
3	5223.7500	45.2	18.65	26.55	54	-8.8	0.5	Horizontal	AV	Pass
4	11745.0000	45.24	38.83	6.41	74	-28.76	18.8	Horizontal	PK	Pass
4	11745.0000	41.4	38.83	2.57	54	-12.6	18.8	Horizontal	AV	Pass
5	14337.0000	49.03	41.06	7.97	74	-24.97	-0.1	Horizontal	PK	Pass
5	14337.0000	41.64	41.06	0.58	54	-12.36	-0.1	Horizontal	AV	Pass
6	17791.5000	52.6	45.1	7.5	74	-21.4	348.6	Horizontal	PK	Pass
6	17791.5000	44.96	45.1	-0.14	54	-9.04	348.6	Horizontal	AV	Pass



Report No.: WSCT-ANAB-R&E241200081A-LE

Vertical:

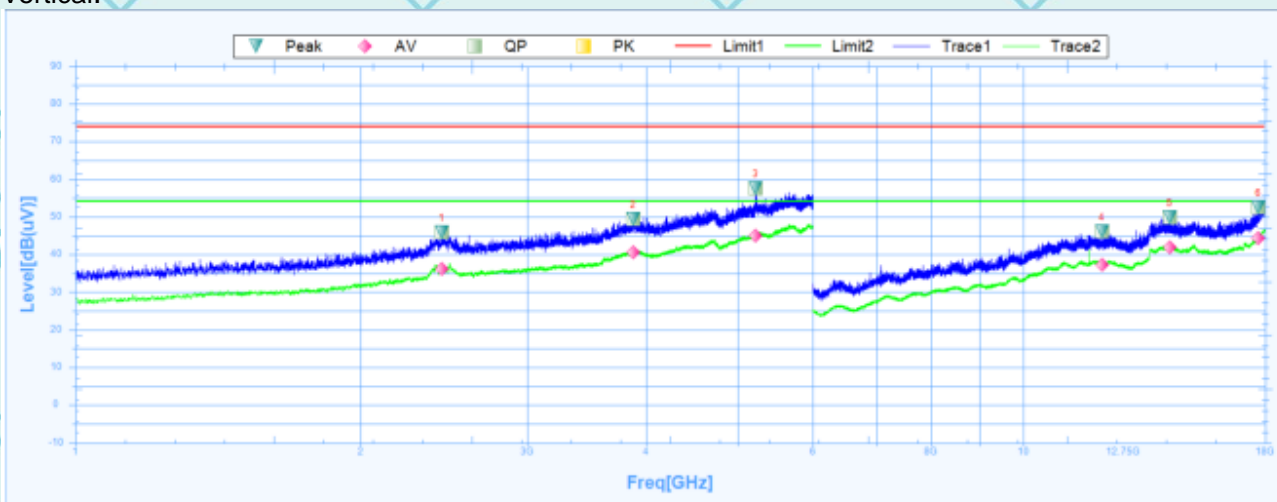

Suspected Data List										
NO.	Freq. [MHz]	Reading [dB(uV)]	Factor [dB]	Level [dB(uV)]	Limit [dB]	Margin [dB]	Deg [°]	Polarity	Trace	Verdict
1	2434.3750	45.88	7.69	38.19	74	-28.12	352.9	Vertical	PK	Pass
1	2434.3750	36.27	7.69	28.58	54	-17.73	352.9	Vertical	AV	Pass
2	3878.7500	49.46	11.56	37.9	74	-24.54	173.8	Vertical	PK	Pass
2	3878.7500	40.6	11.56	29.04	54	-13.4	173.8	Vertical	AV	Pass
3	5221.8750	57.7	18.62	39.08	74	-16.3	336.4	Vertical	PK	Pass
3	5221.8750	45.02	18.62	26.4	54	-8.98	336.4	Vertical	AV	Pass
4	12108.0000	46.06	38.63	7.43	74	-27.94	159.8	Vertical	PK	Pass
4	12108.0000	37.19	38.63	-1.44	54	-16.81	159.8	Vertical	AV	Pass
5	14274.0000	49.8	41.14	8.66	74	-24.2	37.9	Vertical	PK	Pass
5	14274.0000	41.83	41.14	0.69	54	-12.17	37.9	Vertical	AV	Pass
6	17710.5000	52.5	44.56	7.94	74	-21.5	140.7	Vertical	PK	Pass
6	17710.5000	44.45	44.56	-0.11	54	-9.55	140.7	Vertical	AV	Pass

**Note:**

1. All emissions not reported were more than 20dB below the specified limit or in the noise floor.
2. Emission Level= Reading Level+Probe Factor +Cable Loss.
3. Data of measurement within this frequency range shown "--" in the table above means the reading of emissions are attenuated more than 20dB below the permissible limits or the field strength is too small to be measured.





Report No.: WSCT-ANAB-R&E241200081A-LE

### 6.7.3. Restricted Bands Requirements

Test result for GFSK Mode (the worst case)

Frequency	Reading	Correct Factor	Emission Level	Limit	Margin	Polar	Detector
(MHz)	(dBuV/m)	dB/m	(dBuV/m)	(dBuV/m)	(dB)	H/V	
Low Channel							
2390	66.30	-8.76	57.54	74	-16.46	H	PK
2390	47.36	-8.76	38.60	54	-15.40	H	AV
2390	66.40	-8.73	57.67	74	-16.33	V	PK
2390	49.99	-8.73	41.26	54	-12.74	V	AV
High Channel							
2483.5	67.36	-8.76	58.60	74	-15.40	H	PK
2483.5	48.47	-8.76	39.71	54	-14.29	H	AV
2483.5	68.30	-8.17	60.13	74	-13.87	V	PK
2483.5	49.18	-8.17	41.01	54	-12.99	V	AV

Note: Freq. = Emission frequency in MHz  
 Reading level (dBuV) = Receiver reading  
 Corr. Factor (dB) = Attenuation factor + Cable loss  
 Level (dBuV) = Reading level (dBuV) + Corr. Factor (dB)  
 Limit (dBuV) = Limit stated in standard  
 Margin (dB) = Level (dBuV) – Limits (dBuV)

**\*\*\*\*\*END OF REPORT\*\*\*\*\***

