

Date: 29. JAN. 2024 16:38:36

Mid Frequency and With the ALC threshold level

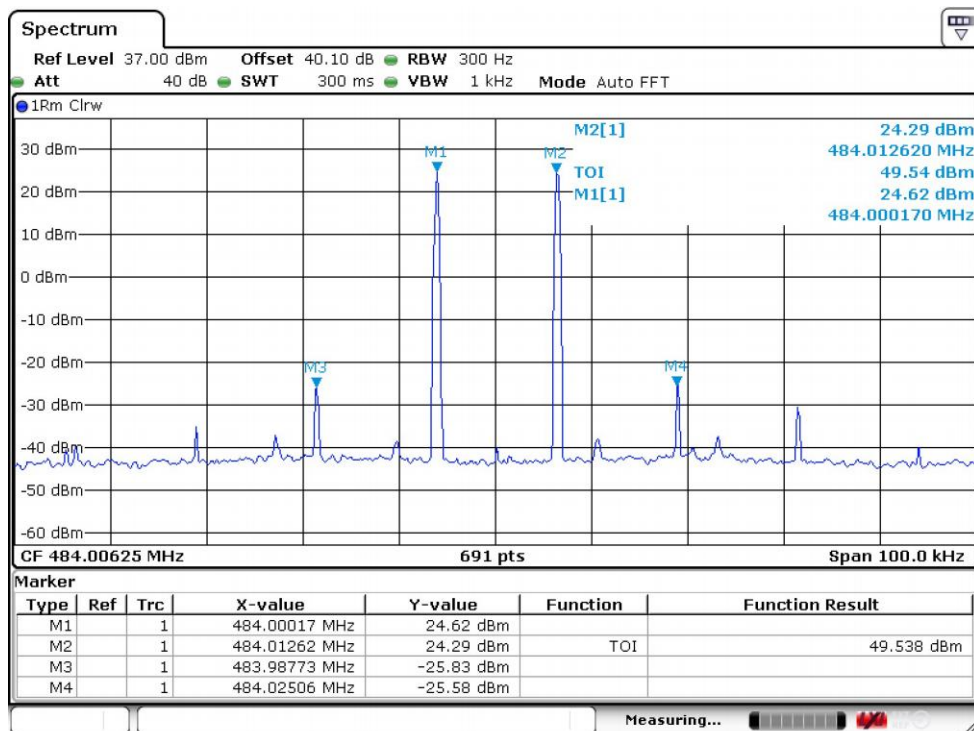

Date: 29. JAN. 2024 16:38:43

Mid Frequency and With the input signal amplitude set 3 dB above the ALC threshold

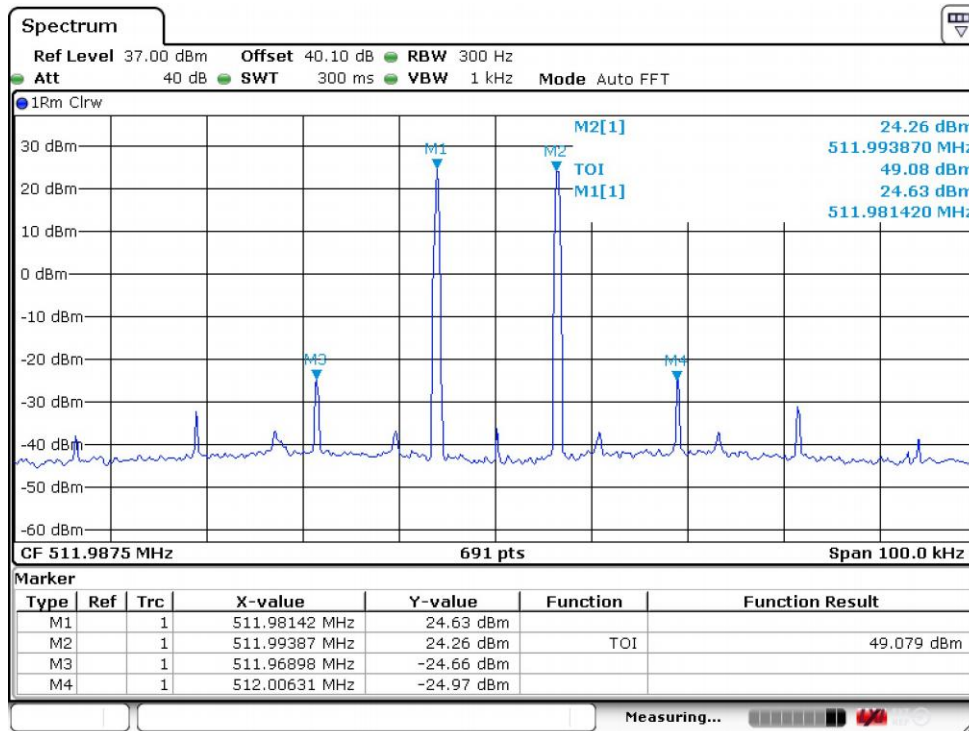

Date: 29. JAN. 2024 16:37:04

High Frequency and With the ALC threshold level

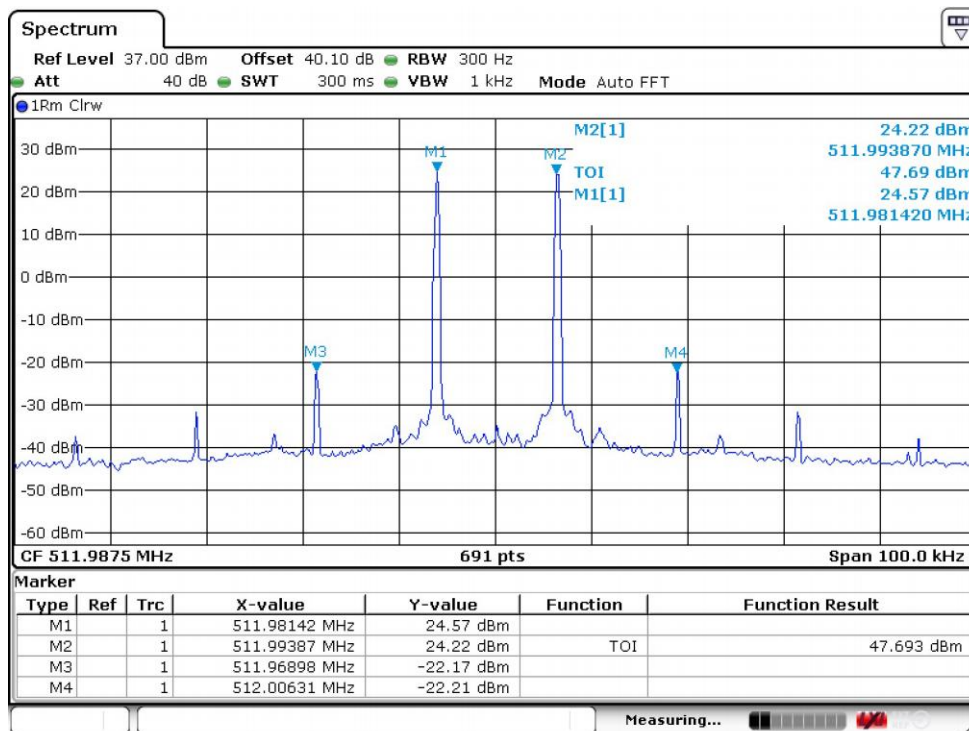

Date: 29. JAN. 2024 16:37:23

High Frequency and With the input signal amplitude set 3 dB above the ALC threshold

10.8.5.2.3. Channel Bandwidth: 25kHz

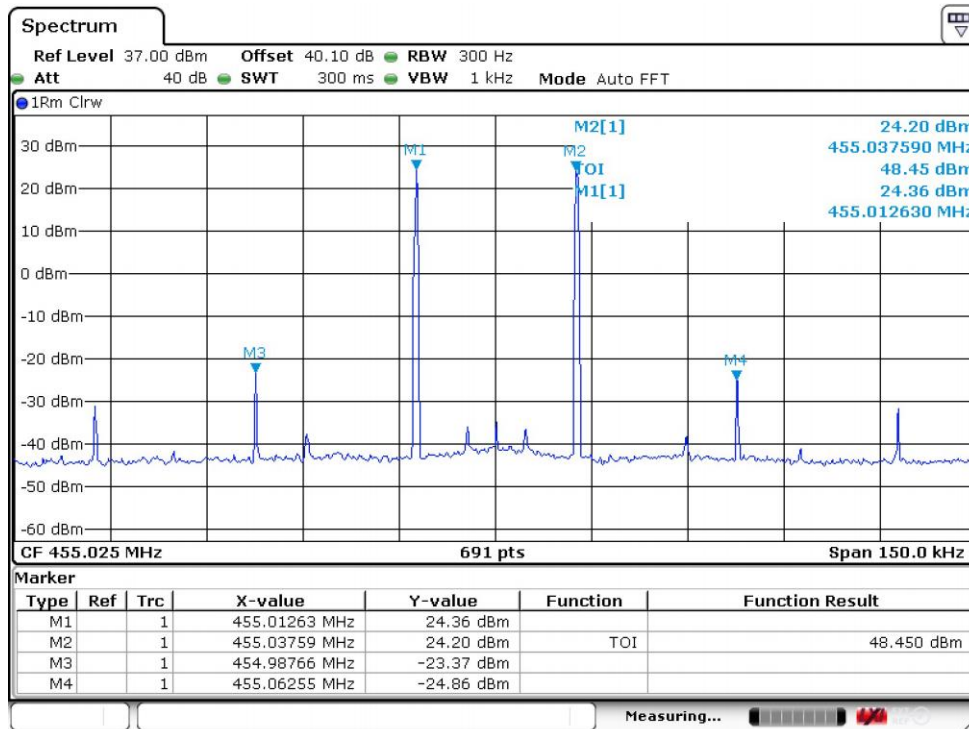

Date: 29.JAN.2024 16:42:53

Low Frequency and With the ALC threshold level

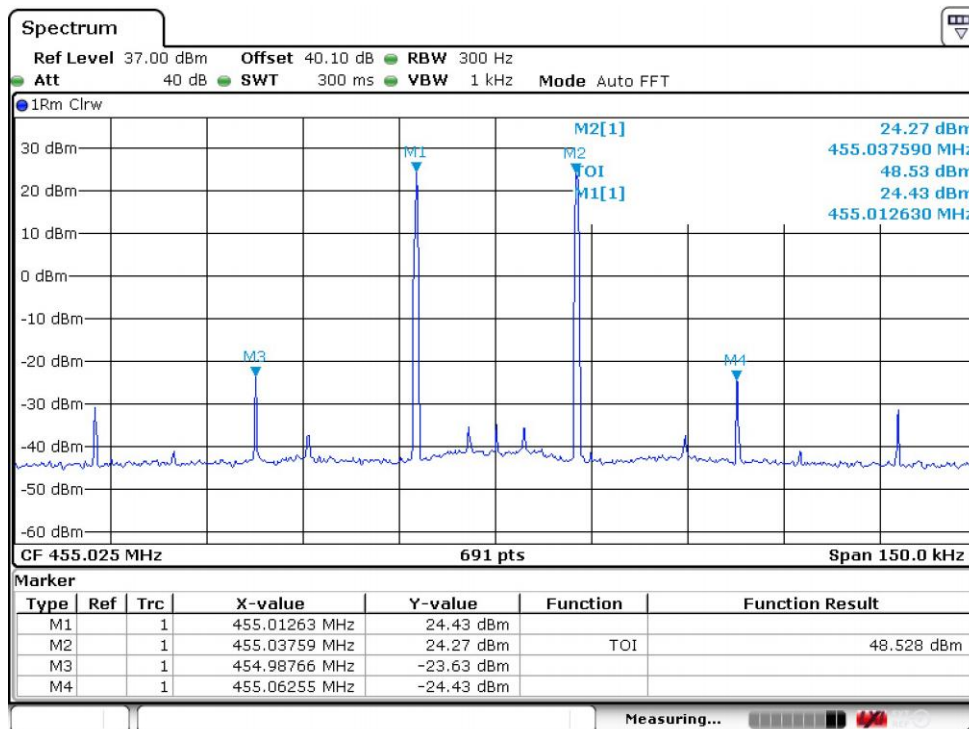

Date: 29.JAN.2024 16:43:00

Low Frequency and With the input signal amplitude set 3 dB above the ALC threshold

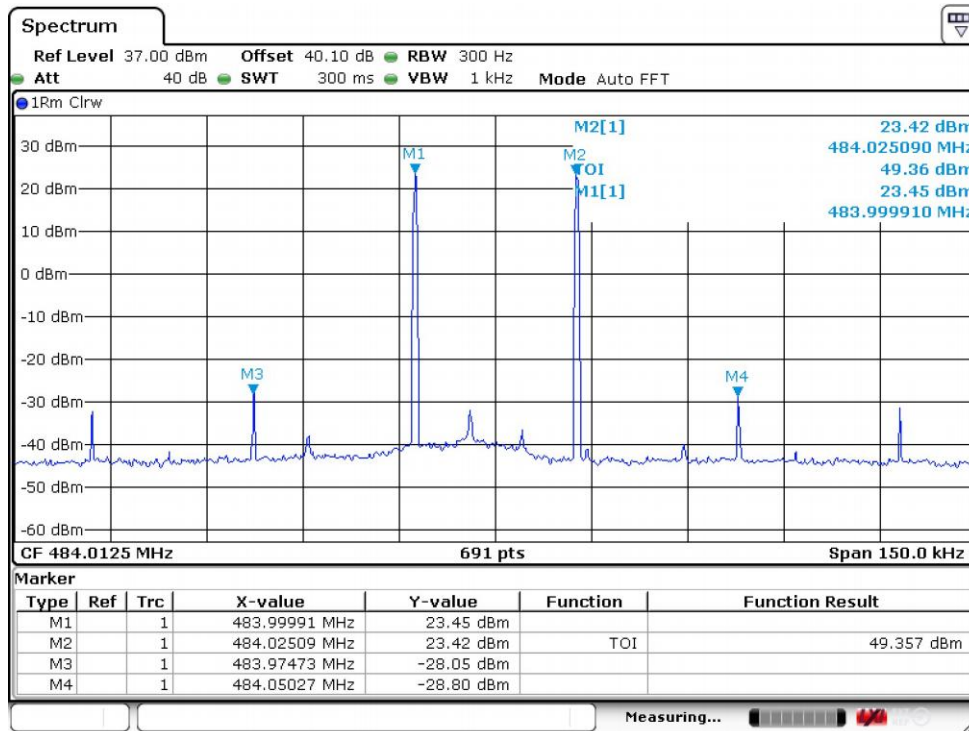

Date: 29. JAN. 2024 16:47:49

Mid Frequency and With the ALC threshold level

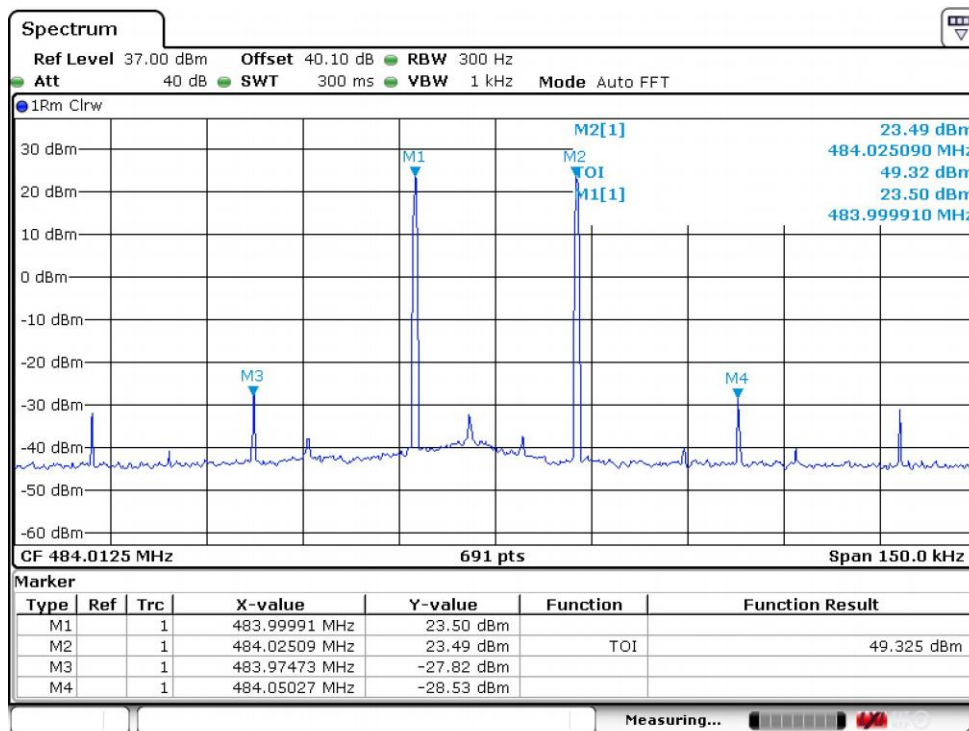

Date: 29. JAN. 2024 16:48:10

Mid Frequency and With the input signal amplitude set 3 dB above the ALC threshold

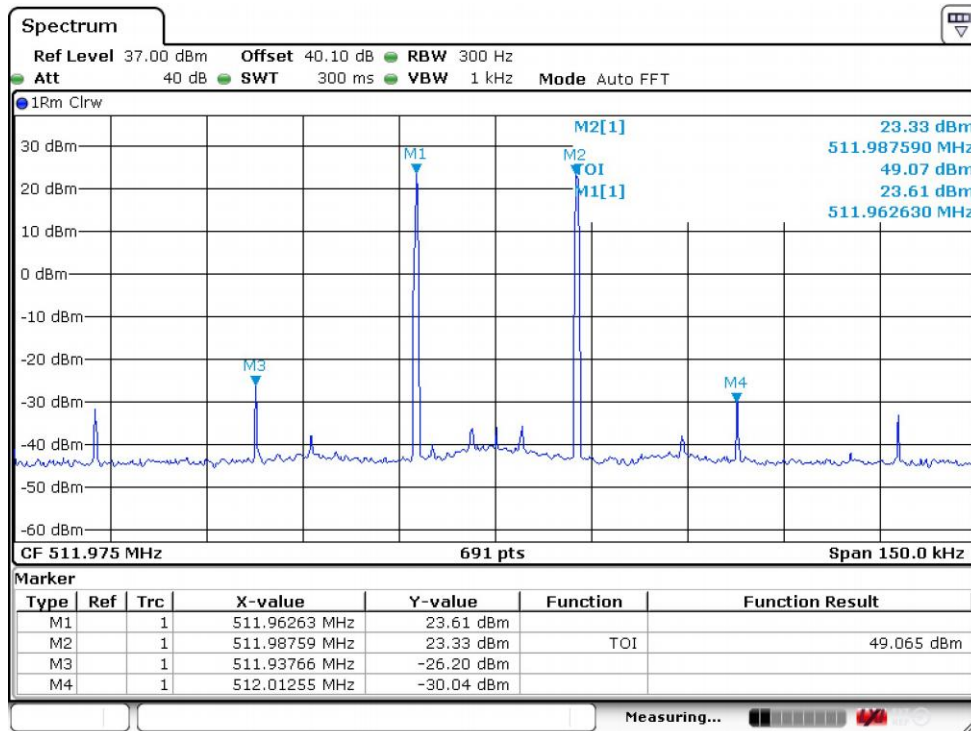

Date: 29. JAN. 2024 16:49:51

High Frequency and With the ALC threshold level

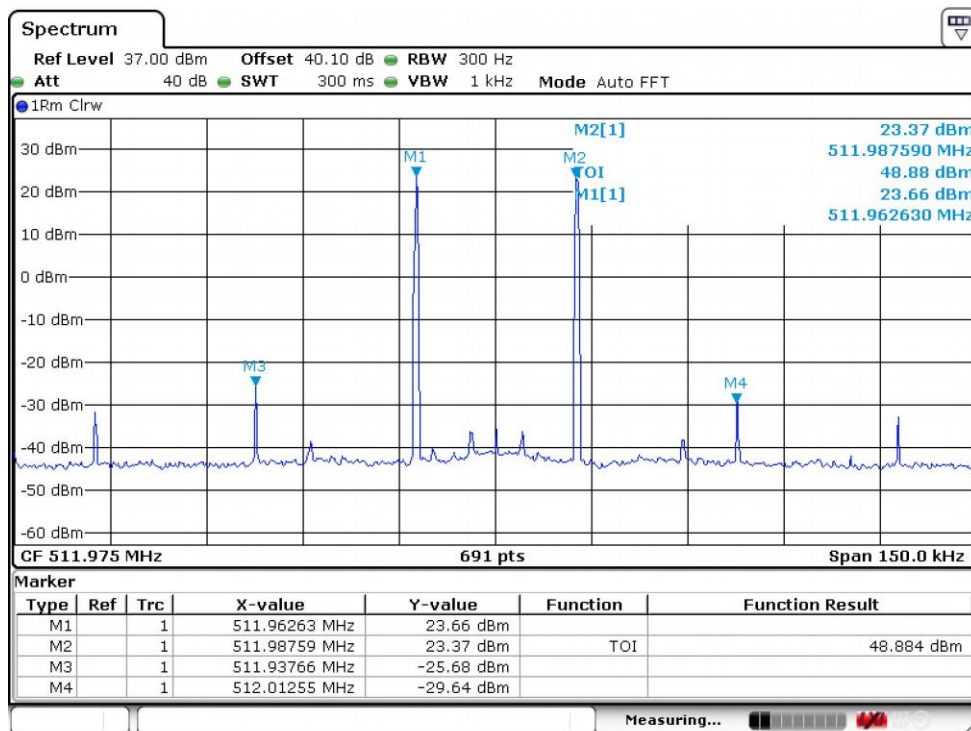

Date: 29. JAN. 2024 16:49:58

High Frequency and With the input signal amplitude set 3 dB above the ALC threshold

### 10.9. Conducted spurious emissions

Test requirement: KDB 935210 D05 clause 4.7.3  
FCC PART 2.1051  
FCC PART 90.219 (c)(3)

Test Method: KDB 935210 D05/4.7.3

#### 10.9.1. Limit

The EUT shall comply with sections 4.7.3 of KDB 935210 D05.

Refer to the applicable rule part(s) for specified limits on unwanted (out-of-band/out-of-block and spurious) emissions (e.g., Section 90.210).

Spurious emissions shall be measured using a single test signal sequentially tuned to the low, middle, and high channels or frequencies within each authorized frequency band of operation.

Intermodulation products shall be measured using two CW signals with all available channel spacings (e.g., 12.5 kHz and 6.25 kHz) with the center between these channels being equal to the center frequency  $f_0$  as determined from 4.3.

NOTE—Intermodulation-product spurious emission measurements are not required for single-channel boosters that cannot accommodate two simultaneous signals within the passband.

For a multi-channel enhancer, any intermodulation product level must be attenuated, relative to P, by at least:  $43 + 10 \cdot \log_{10} P$  is less stringent than 70dB, that limit was used.

Spurious emissions shall be measured using a single test signal sequentially tuned to the low, middle, and high channels or frequencies within each authorized frequency band of operation.

Out-of-band/out-of-block emissions (including intermodulation products) shall be measured under each of the following two stimulus conditions:

- a) two adjacent test signals sequentially tuned to the lower and upper frequency band/block edges;
- b) a single test signal, sequentially tuned to the lowest and highest frequencies or channels within the frequency band/block under examination.

NOTE—Single-channel boosters that cannot accommodate two simultaneous signals within the passband may be excluded from the test stipulated in step a).

————— The following blanks —————

10.9.2. Test configuration

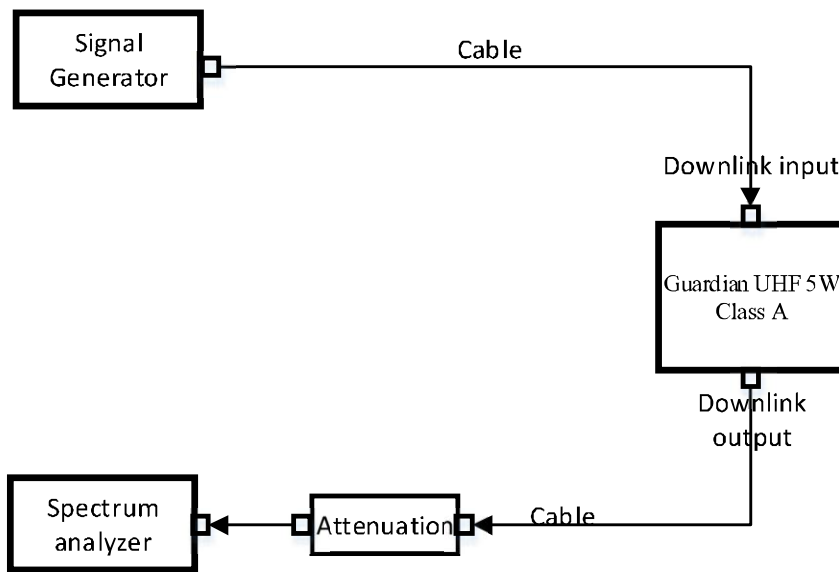

Figure 10.6-1 Downlink connection diagram

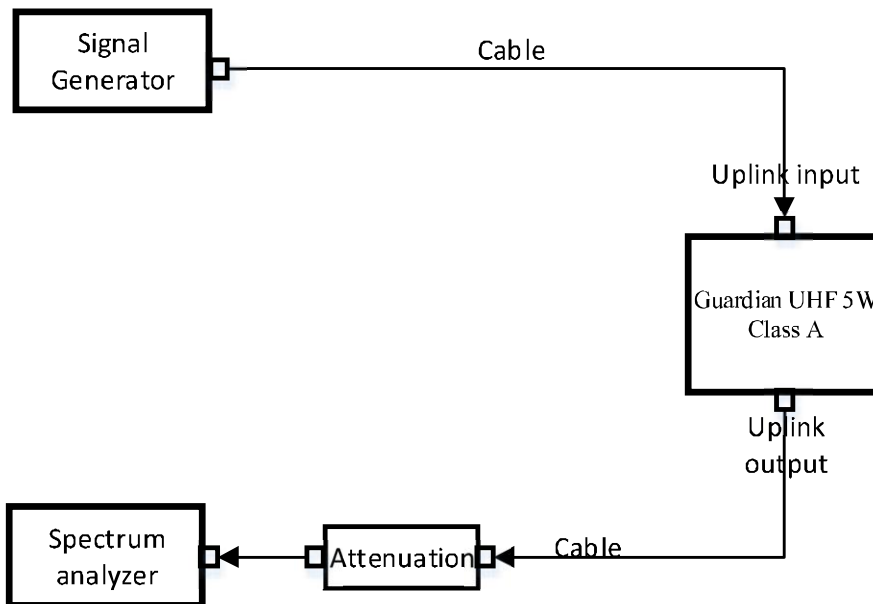

Figure 10.6-2 Uplink connection diagram

———— The following blanks ————

## 10.9.3. Test procedures

- a) Connect a signal generator to the input of the EUT.
- b) Configure the signal generator to produce a CW signal.
- c) Set the frequency of the CW signal to the center channel of the EUT passband.
- d) Set the output power level so that the resultant signal is just below the AGC threshold (see 4.2).
- e) Connect a spectrum analyzer to the output of the EUT, using appropriate attenuation as necessary.
- f) Set the RBW = 100 kHz. (i.e., for 30 MHz to 1 GHz PLMRS and/or PSRS booster devices)
- g) Set the VBW =  $3 \times$  RBW.
- h) Set the Sweep time = auto-couple.
- i) Set the detector to PEAK.
- j) Set the spectrum analyzer start frequency to 30 MHz (or the lowest radio frequency signal generated in the EUT, without going below 9 kHz if the EUT has additional internal clock frequencies), and the stop frequency to  $10 \times$  the highest allowable frequency of the EUT passband.
- k) Select MAX HOLD, and use the marker peak function to find the highest emission(s) outside the passband. (This could be either at a frequency lesser or greater than the passband frequencies.)
- l) Capture a plot for inclusion in the test report.

Any frequency outside the authorized bandwidth was attenuated by at least  $43+10*\log(P)$ dB. This corresponds to an absolute level of  $-13\text{dBm} (P_{\text{dBm}}-(43+10*\log(P_w)))$ .

NOTE: Select the widest carrier 12.5kHz as the test reference.

———— The following blanks ————



## 10.9.4. Test results

Test Date (yy-mm-dd): 2024-01-30

Normal condition: Temp: 22.5°C, Humid: 29%, Atmospheric Pressure:101kpa

Supply Voltage: DC +24V

Frequency range		Max. Spurious Limit(dBm)	RBW (kHz)	Max. Spurious mark Level (dBm)	Margin 1* (dB)	Result
(1) Downlink transmit mode						
Low frequency 450.0125MHz	9kHz~1GHz	-13.0	100	-45.2	32.2	PASS
	1GHz~6GHz	-13.0	100	-42.8	29.8	PASS
Middle frequency 479.0MHz	9kHz~1GHz	-13.0	100	-38.3	25.3	PASS
	1GHz~6GHz	-13.0	100	-43.9	30.9	PASS
High frequency 508.9875MHz	9kHz~1GHz	-13.0	100	-43.6	30.6	PASS
	1GHz~6GHz	-13.0	100	-42.9	29.9	PASS
(2) Uplink transmit mode						
Low frequency 455.0125MHz	9kHz~1GHz	-13.0	100	-43.1	30.1	PASS
	1GHz~6GHz	-13.0	100	-47.2	34.2	PASS
Middle frequency 484.0MHz	9kHz~1GHz	-13.0	100	-43.9	30.9	PASS
	1GHz~6GHz	-13.0	100	-47.3	34.3	PASS
High frequency 511.9875MHz	9kHz~1GHz	-13.0	100	-42.1	29.1	PASS
	1GHz~6GHz	-13.0	100	-47.3	34.3	PASS
NOTE 1: 1*-Margin= specification limit -Maximum mark level.						
NOTE 2: The signal to input the EUT is a CW signal.						

———— The following blanks ————

10.9.5. Test screenshot

10.9.5.1. Downlink transmit mode

10.9.5.1.1. Low Frequency 450.0125MHz

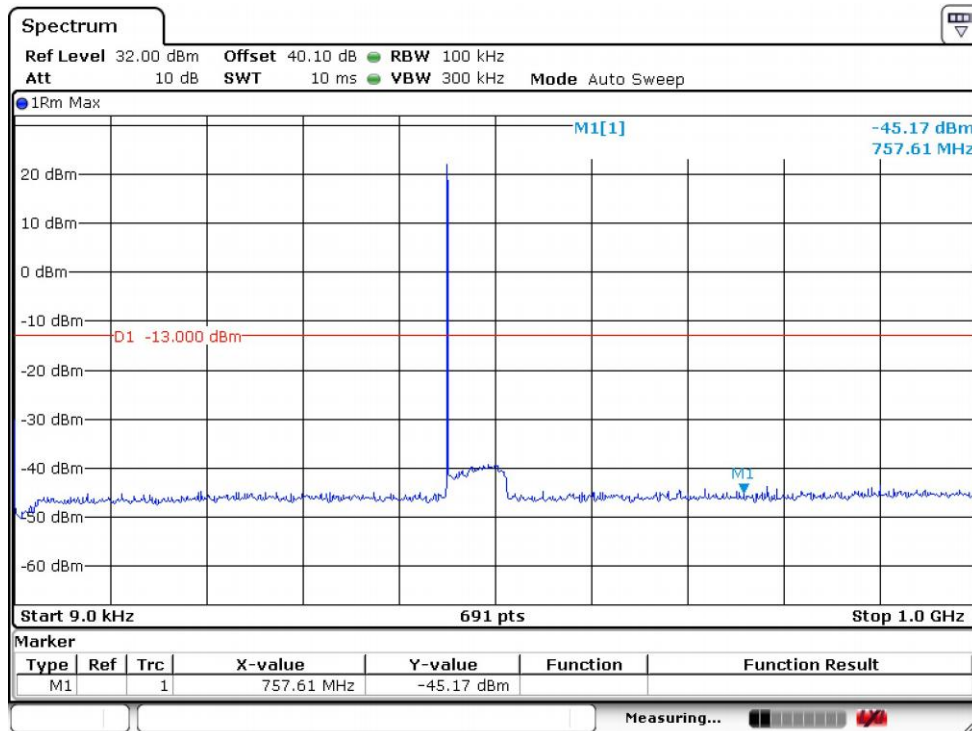

Date: 30.JAN.2024 09:03:38

9kHz~1GHz

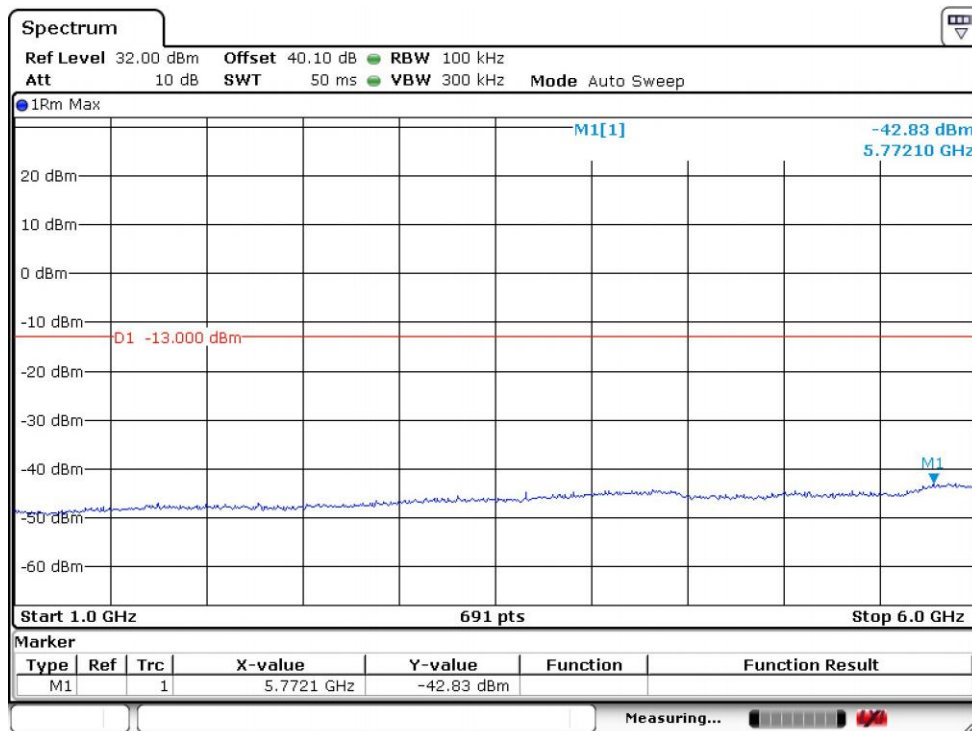

Date: 30.JAN.2024 09:06:29

1GHz~6GHz

10.9.5.1.2. Mid Frequency 479.0MHz

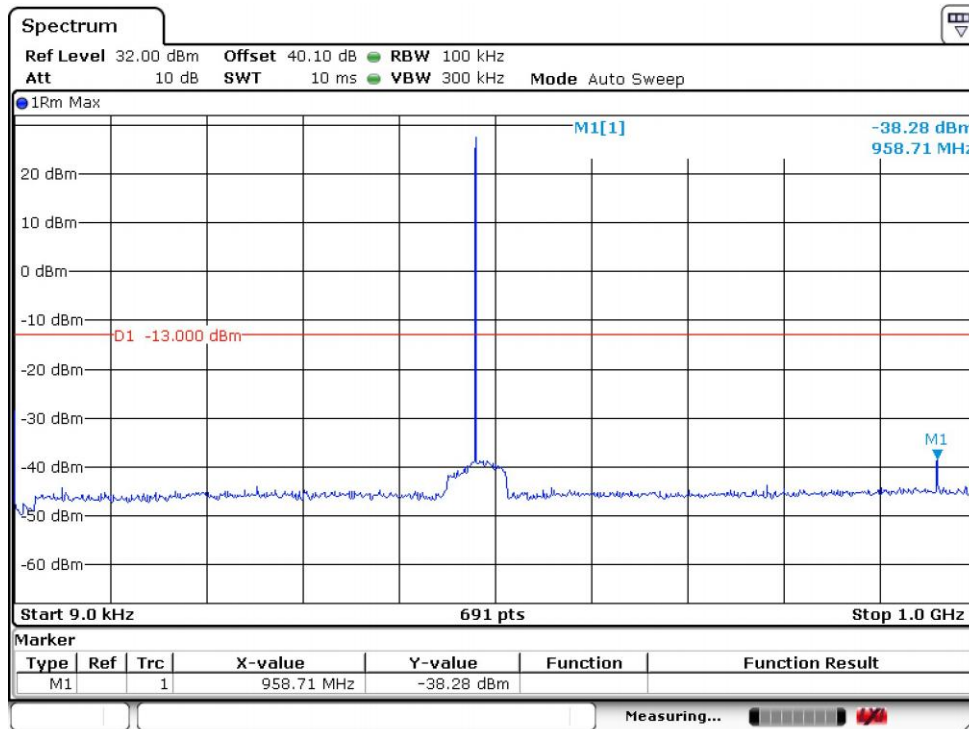

Date: 30.JAN.2024 09:04:24

9kHz~1GHz

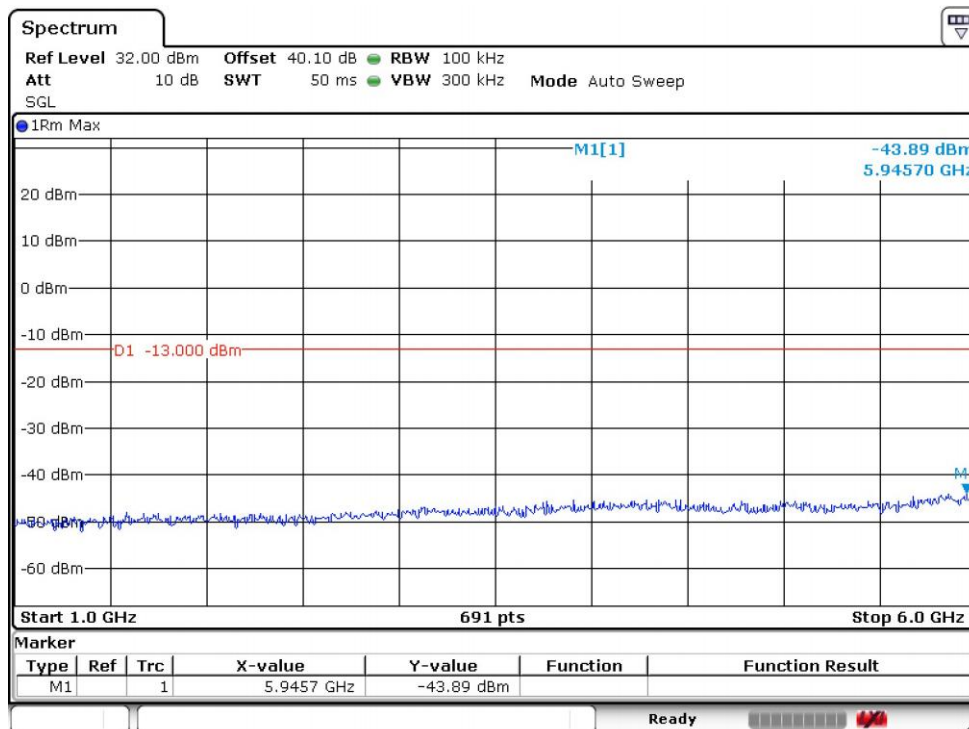

Date: 30.JAN.2024 09:05:58

1GHz~6GHz

10.9.5.1.3. High Frequency 508.9875MHz

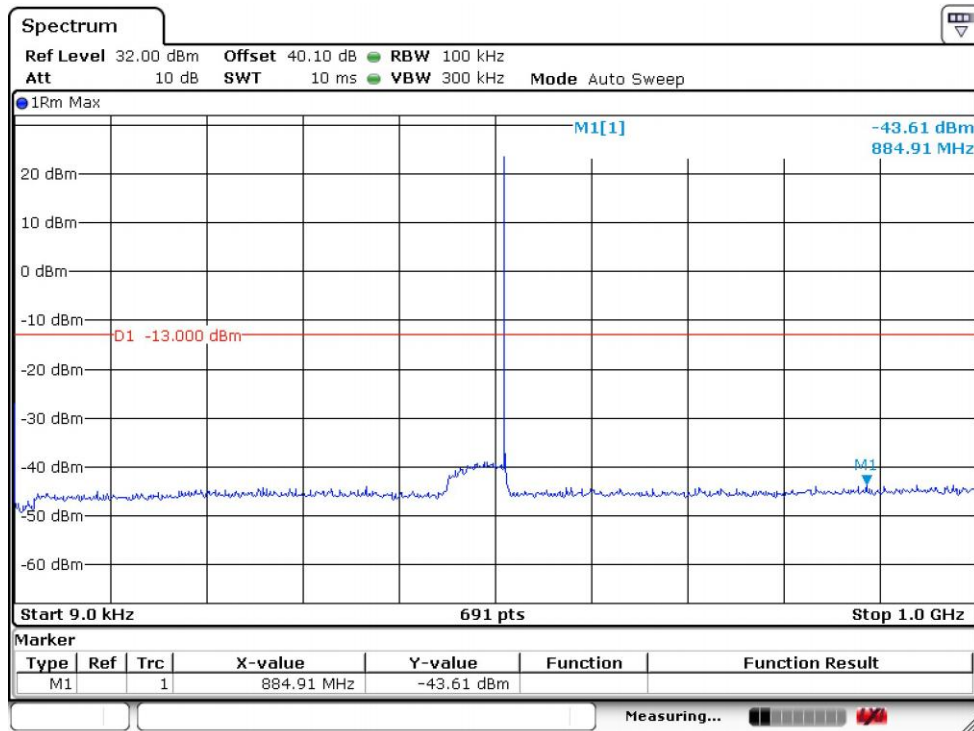

Date: 30.JAN.2024 09:05:03

9kHz~1GHz

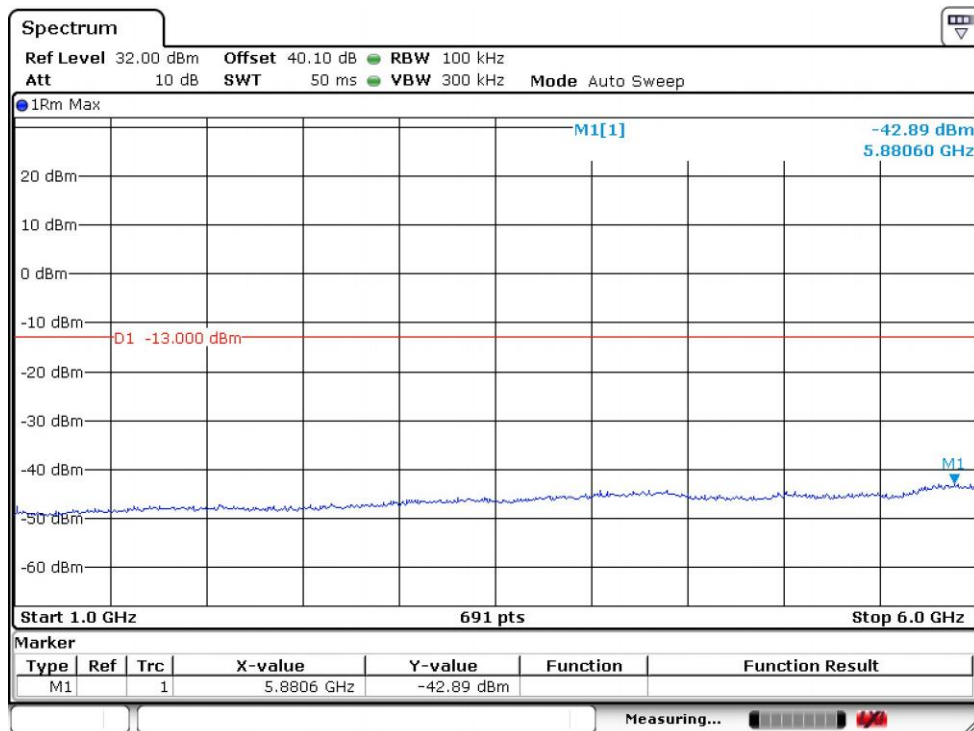

Date: 30.JAN.2024 09:05:19

1GHz~6GHz

10.9.5.2. Uplink transmit mode

10.9.5.2.1. Low Frequency 455.0125MHz

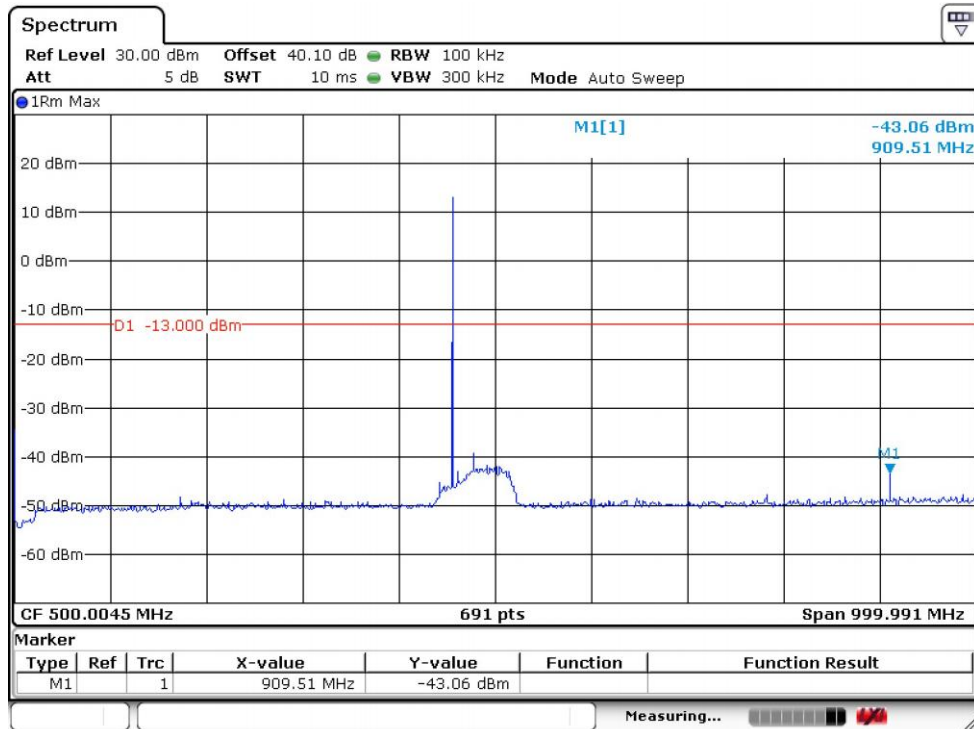

Date: 30 JAN 2024 08:47:28

9kHz~1GHz

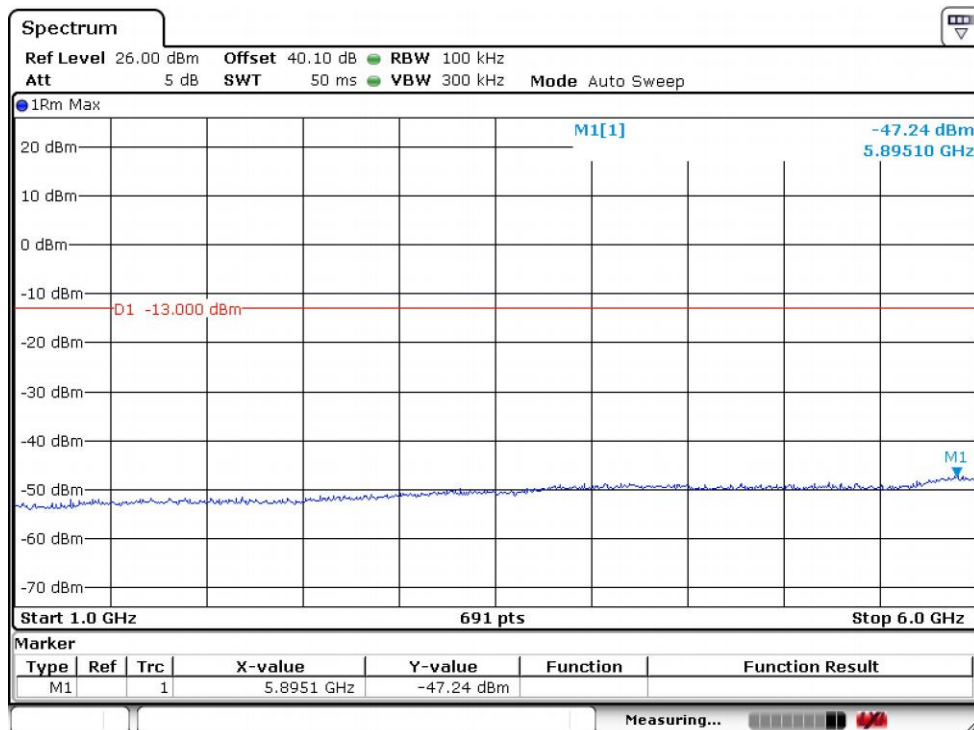

Date: 30 JAN 2024 08:50:04

1GHz~6GHz

10.9.5.2.2. Mid Frequency 484.0MHz

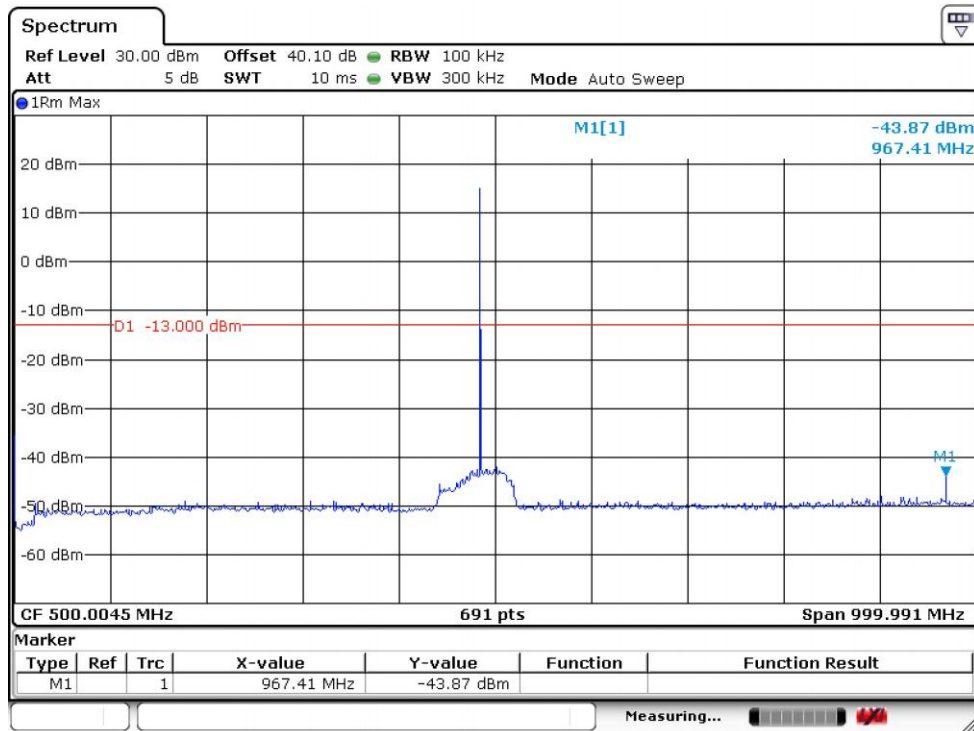

Date: 30.JAN.2024 08:48:21

9kHz~1GHz

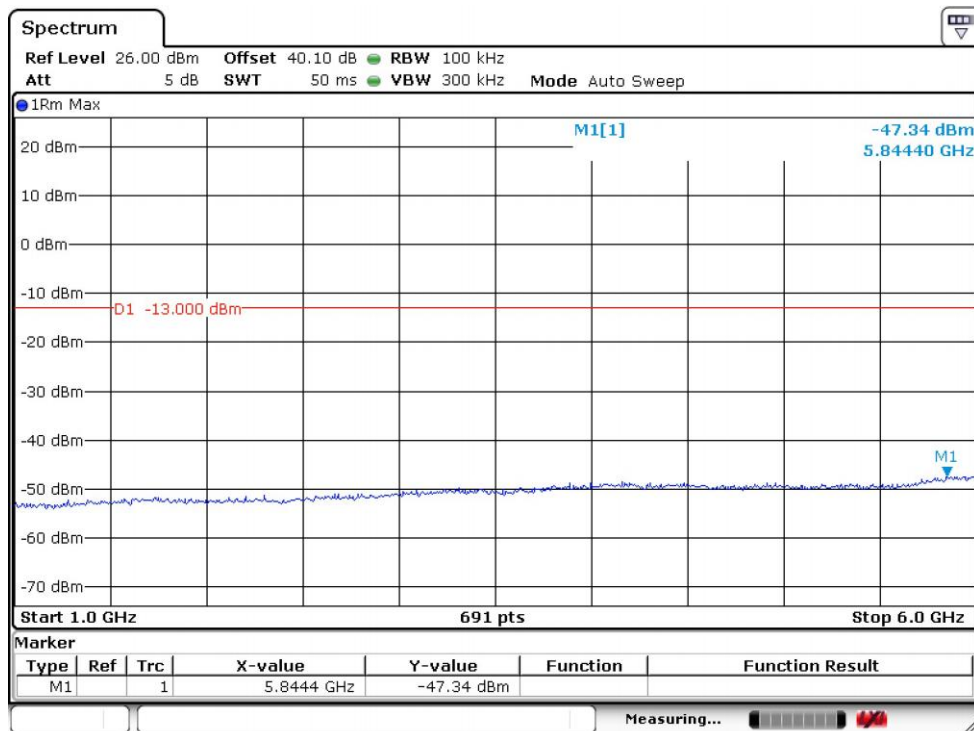

Date: 30.JAN.2024 08:49:44

1GHz~6GHz

10.9.5.2.3. High Frequency 511.9875MHz

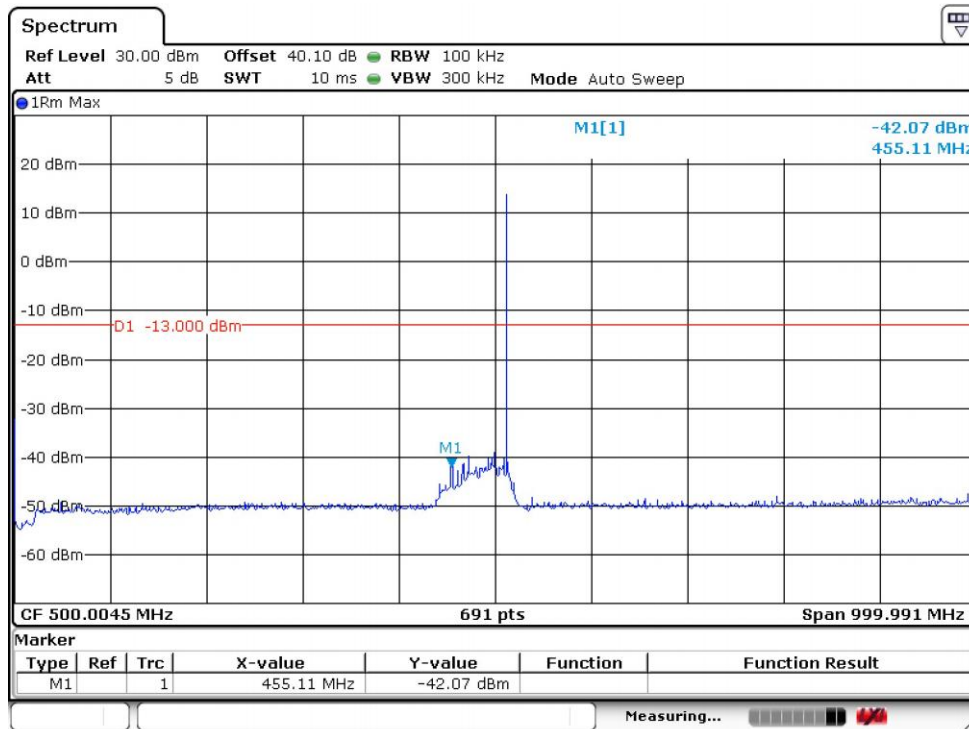

Date: 30.JAN.2024 08:48:55

9kHz~1GHz

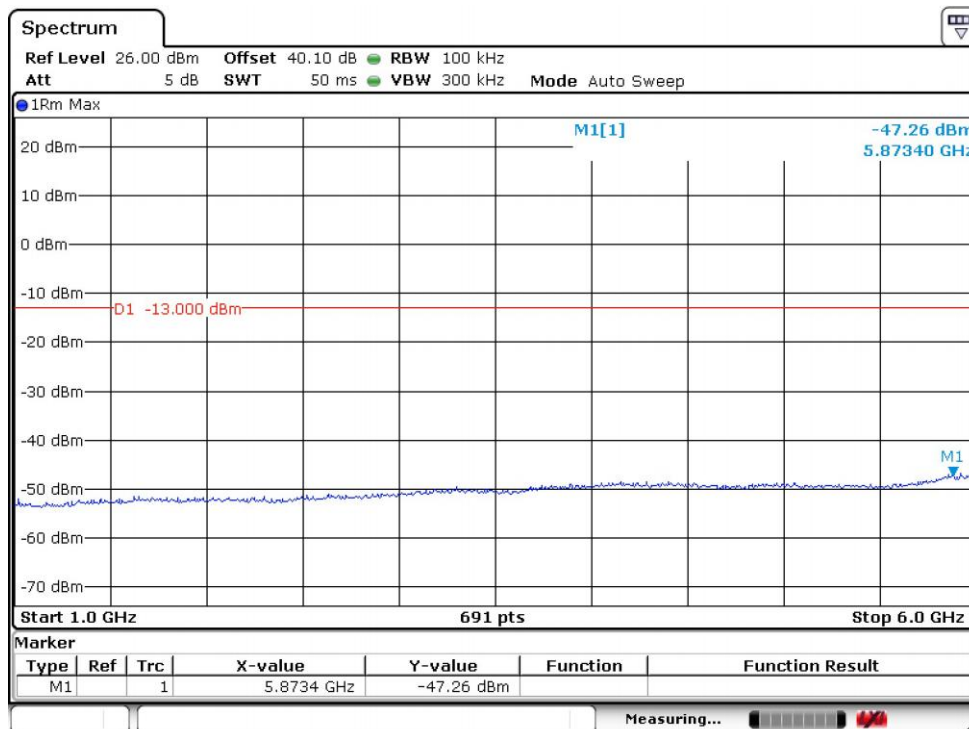

Date: 30.JAN.2024 08:49:18

1GHz~6GHz

———— The following blanks ————

10.10. Frequency stability

Test requirement: KDB 935210 D05 clause 4.8  
 FCC PART 2 1055(a)(2)  
 FCC PART 90.213  
 FCC PART 90.219 (e)(4)(i)  
 Test Method: KDB 935210 D05/4.8  
 FCC PART 2 1055(b)

10.10.1. Limit

The EUT shall comply with sections 4.8 of KDB 935210 D05.

Section 90.219(e)(4)(i) requires that a signal being retransmitted by an amplifier, repeater, or industrial booster meets the frequency stability requirements of Section 90.213. However, this requirement presumes that the EUT processes an input signal in ways that can influence the output signal frequency/frequencies; however, most signal boosters do not incorporate an oscillator). If the amplifier, booster, or repeater does not alter the input signal in any way, then a frequency stability test may not be required.

When performing frequency stability measurements on these types of devices, the instability associated with the EUT must be isolated from any frequency instability associated with the measurement instrumentation. One method for realizing such isolation is to connect the reference clock input of the signal generator to the reference output of the frequency counter, to confirm that any frequency instability is associated with the EUT, and is not due to differences between the reference oscillators internal to the measurement instrumentation.

Unless noted elsewhere, transmitters used in the services governed by this part must have a minimum frequency stability as specified in the following table 10.10-1.

Table 10.10-1 Frequency stability limits

frequency range(MHz)	Minimum Frequency Stability(ppm)
450~512	±0.5

NOTE: ppm means parts per million.

NOTE 1: RF channels to be tested for single-carrier: Middle frequency

NOTE 2: Modulation type is CW.

———— The following blanks ————