



Bright Flip User Manual

R3Di
FR150



Table of Contents

Getting Started	6
Introduction	6
Set Up Your Phone.....	7
Parts and Functions	7
Battery Use.....	8
Insert the Battery.....	9
Remove the Battery.....	10
Charge the Battery.....	11
SIM Card	11
SD Card	12
Insert an SD Card.....	13
Remove an SD Card	14
Turn Your Phone On and Off.....	14
Complete the Setup Screens.....	15
Basic Operations	16
Basics	17
Home Screen and Applications (Apps) List	17
Phone Settings Menu	17
Capture Screenshots	17
Applications.....	18
Launch Applications.....	18
Apps List	18
Phone Number	19
Airplane Mode.....	20
Enter Text.....	20
Lock and Unlock Your Screen	21
Update Your Phone	22
Update Your Phone Software.....	22
Your Phone's Home Screen.....	23
Home Screen Basics.....	23
Status Bar	24
Change the Home Screen Wallpaper.....	24
Phone Calls and Voicemail.....	25
Place and Answer Calls	25
Call Using the Phone Dialer	26
International call	27
Call Emergency Numbers	27
Answer Phone Calls	29
In-Call Screen Layout and Operations.....	29

Place a Call from Contacts	30
Call from Call Log	31
Voicemail	31
Optional Calling Services	33
Call Waiting.....	33
Conference Calling.....	33
Call Forwarding	33
Call Settings.....	34
Contacts.....	35
Add a Contact.....	36
View Contacts.....	37
Contacts Screen Layout.....	38
Edit a Contact	38
Delete a Contact.....	39
Share a Contact	40
Import Contacts	40
Back Up Contacts.....	41
Messaging	42
Text and Multimedia Messaging.....	42
Send a Text Message	42
Send a Multimedia Message (MMS).....	42
Save and Resume a Draft Message.....	43
New Messages Notification	44
Manage Message Conversations	44
Text and MMS Options.....	45
SOS Message.....	46
E-Mail	47
Set Up an Email Account	47
Add Another Email Account.....	48
Create and Send Email.....	48
Open Email Messages.....	49
Delete an Email Account.....	49
Manage Your Email Inbox	50
Internet.....	50
Data Connection Status and Indicators.....	50
Browser	51
Use the Browser	51
Browser Options	52
Connectivity	52
Wi-Fi	53
Turn Wi-Fi On and Connect to a Wireless Network.....	53
Wi-Fi Settings.....	54
Disconnect Wi-Fi.....	54
Bluetooth.....	55

Bluetooth Information	55
Enable the Bluetooth Feature.....	55
Pair Bluetooth Devices	56
Connect to a Paired Bluetooth Device.....	57
Send Information Using Bluetooth.....	58
Receive Information via Bluetooth.....	58
Apps and Entertainment	59
Camera and Video	59
Camera Overview.....	59
Take Pictures and Record Videos.....	60
Take a Picture.....	60
Record Videos	60
View Pictures and Videos Using Gallery.....	61
Edit Pictures	62
Share Pictures and Videos	64
Camera Settings.....	64
Switch between Camera and Video Mode	64
Set Camera Functions.....	64
Productivity	65
Calendar.....	65
Add an Event to the Calendar	65
View Calendar Events	66
Sync Calendars	67
Calculator.....	67
Clock	68
Set Alarms	68
Additional Clock Features.....	68
Entertainment and Activities.....	69
Play Music.....	69
Music Screen LayoutEnglish screen shot	70
Settings	71
Connections Settings.....	71
Basic Settings	71
Wi-Fi Settings Menu.....	72
Bluetooth Settings.....	73
Cellular & Data.....	75
Personalization Settings.....	75
Sound Settings	75
Display Settings.....	76
.....	77
Search Settings	77
Notices Settings	78
Date & Time Settings	78
Language Settings	79

Input Methods Settings.....	80
Privacy & Security Settings.....	81
Screen Lock Settings	81
App Permission Settings.....	82
Do Not Track Settings.....	83
Browsing Privacy Settings	83
Storage Settings.....	84
USB Storage Settings.....	84
Media Storage Settings	84
Device Settings.....	85
Device Information Settings	85
Downloads Settings.....	86
Battery Settings	87
Accessibility Settings	87
Developer	88
Getting Help	88
For Assistance	89
Troubleshooting.....	89
Specifications	89

Getting Started

The topics in this section will introduce you to your phone, help you get set up with service, provide an overview of the phone screen, and get you started with basic phone operations.

Introduction

Thank you for purchasing your new phone. The following topics describe the basics of using this guide and your new phone.

Before Using Your Phone

Read the QuickStart Guide that was packaged with your phone thoroughly for proper usage. Accessible services may be limited by subscription contract conditions.

Descriptions in the User Guide

Note that most descriptions in this guide are based on your phone's setup at the time of purchase. Unless otherwise noted, instructions begin from the phone's home screen, which is displayed by pressing the **End/power key** . Some operation descriptions may be simplified.

Screenshots and Key Labels

Screenshots and other illustrations in this user guide may appear differently on your phone. Key labels in the user guide are simplified for description purposes and differ from your phone's display.

Other Notations

In the user guide, the phone may be referred to either as "phone," "device," or "handset." A microSDTM or microSDHCTM card is referred to as an "SD card" or a "memory card."

Set Up Your Phone

The following topics give you all the information you need to set up your phone and wireless service the first time.

Parts and Functions

These topics illustrate your phone's primary parts and key functions.

Note: Your phone's screens and apps layouts are subject to change. This user guide uses sample images.



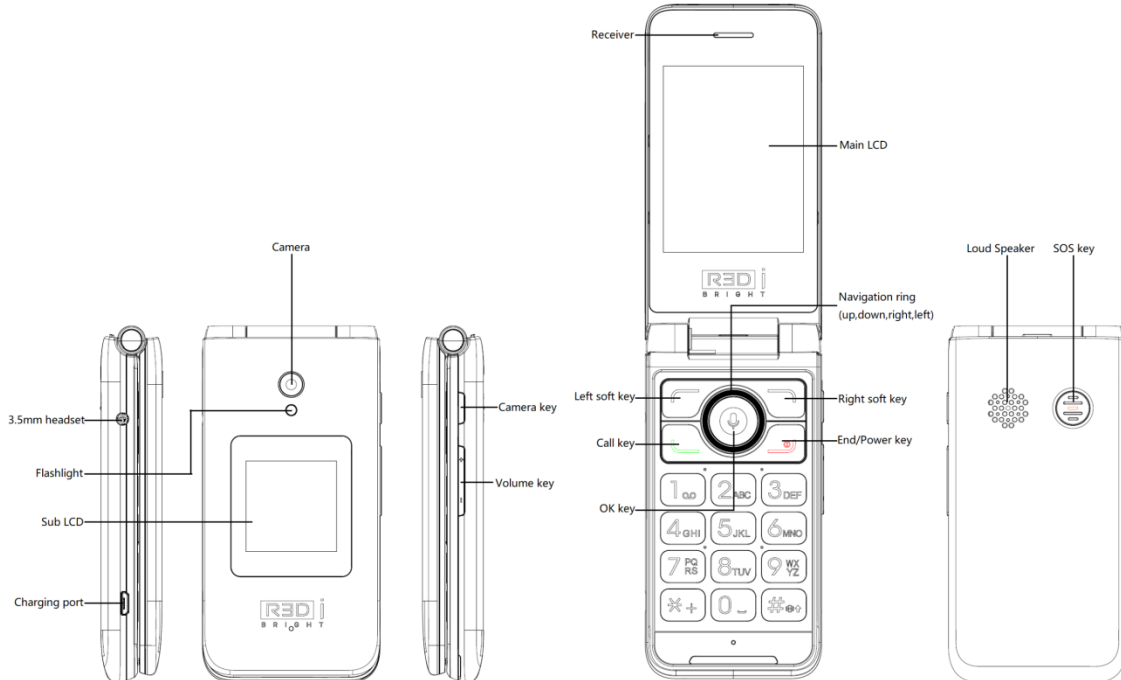

Phone Layout

The following illustration outlines your phone's primary external features and keys.



Part	Description
Camera	Takes pictures and records videos.
Receiver	Lets you hear the caller and automated prompts.

Main Screen	Displays all the information needed to operate your phone, such as the call status, the Contacts list, and the date and time.
--------------------	---

Part	Description
External Screen	Display the date, time and the notification of incoming calls or messages.
 Center Soft Key	Selects or confirms an option (press the middle of the key).
 Navigation Key	Navigate Up, Down, Left, or Right through menus.
 Call Key	Launches call log from idle screen.
 End/Power Key	Returns you to the apps list or turns the phone on or off. Returns you to the previous screen, or closes a dialog box, options menu.
Charging Port	Allows you to connect the phone charger.
Volume Keys	Allows you to adjust the ringtone or media volume or adjust the voice volume during a call.
3.5 mm Headset Jack	Allows you to plug in either a stereo headset or an optional headset for convenient, hands-free conversations.

CAUTION! Inserting an accessory into the incorrect jack may damage the phone.

Battery Use

The following topics explain how to insert and remove your phone's battery.

Battery Cautions

Storage: Avoid storing or leaving battery with no charge remaining. Saved information and settings may become lost or changed, or battery may become unusable. Charge once every six months before storing or leaving unused for a long period.

Bulges: Depending on use, bulges may appear near end of battery life. This does not affect safety.

Replacing Battery: The battery is a consumable item. It needs to be replaced if operating time shortens noticeably. Purchase a new battery.

Cleaning: Clean soiled terminals between battery and phone with a clean, dry cotton swab. Soiled terminals can result in a poor connection and prevent charging, etc.

Insert the Battery

Follow these instructions to insert your phone's battery safely and properly.

1. Remove the battery cover by gently lifting in the directions shown below.

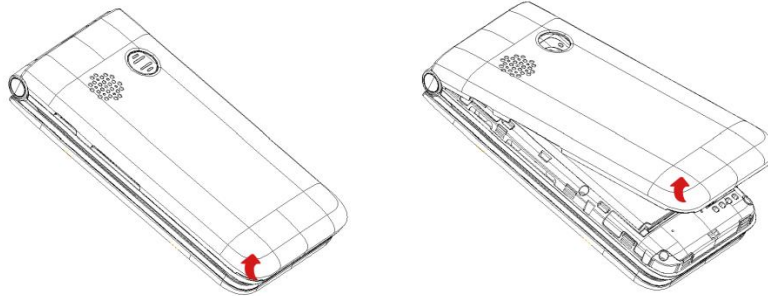

2. Insert the battery by gently lifting upward as shown below.

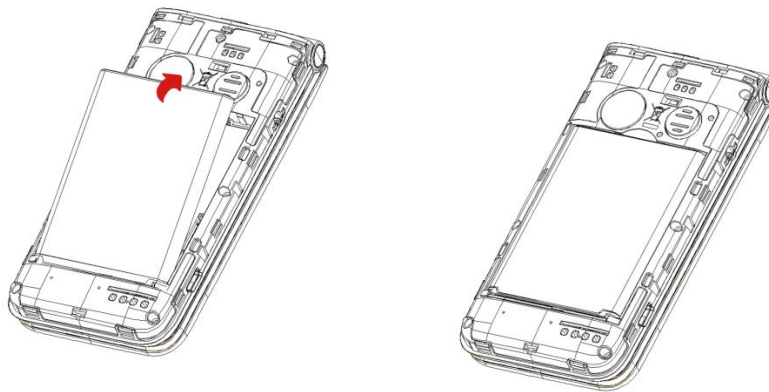

3. Attach the battery cover.

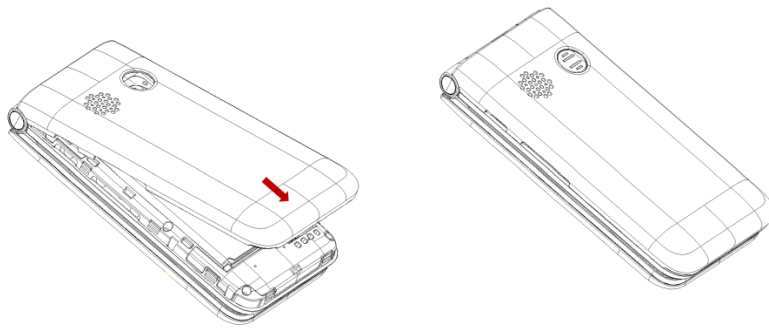

Make sure all the tabs are secure and there are no gaps around the cover.

Remove the Battery

Follow these instructions to remove your phone's battery. Always power the phone off before removing the battery.

1. Remove the battery cover by gently lifting in the directions shown below.

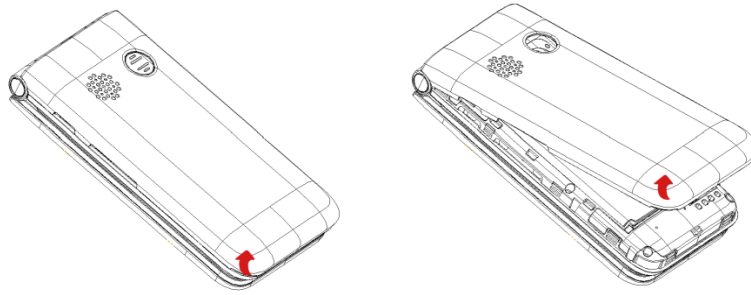

2. Remove the battery by gently lifting upward as shown.

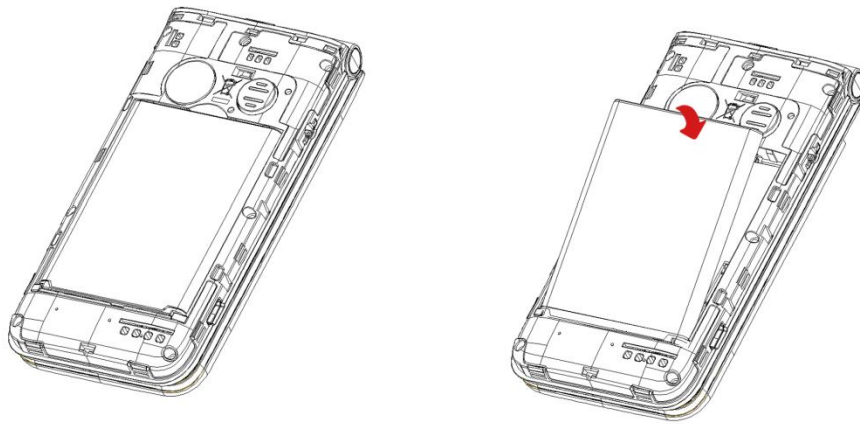

Charge the Battery

Follow these instructions to charge your phone's battery using either the included AC adapter or via a USB connection on your computer.

Charge Using the AC Adapter

1. Plug the charger into the charging port of your phone.
2. Plug the AC adapter into an electrical outlet.
- 3.

After charging, unplug the AC adapter from the outlet and remove the charger from the phone.

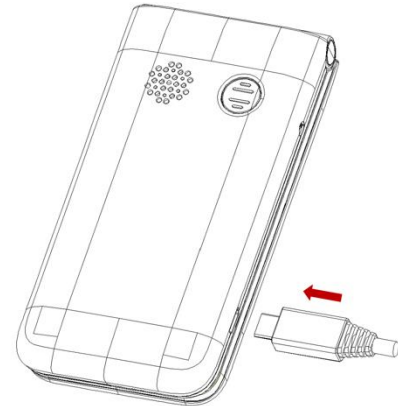

Charge Using a PC Connection

Before using a PC connection to charge your phone, ensure that the computer is turned on. Depending on the type of connection, your phone's battery may not charge.

1. Insert the small end of the USB cord into the charging port of your phone.
2. Insert the large end of the USB cord into an external USB port on your computer.
3. After charging, remove the USB cable from both the phone and the computer.

SIM Card

The SIM card is an IC card containing phone number and other customer information. Your phone's SIM card is preinstalled and should only be accessed if directed by a customer service representative.

Handling a SIM Card

Keep the following in mind when handling a SIM card.

- You are responsible for any damage caused by inserting the SIM card in another IC card reader, etc. Asiatelco Technologies, Inc. is not responsible in such an event.
- Always keep the IC chip clean.
- Wipe clean with a dry, soft cloth.
- Avoid applying labels. May damage SIM card.
- See instructions included with SIM card for handling.
- The SIM card is the property of your Carrier.
- The SIM card is replaceable (at cost) in case of loss/damage.

- Return the SIM card to your Carrier when canceling subscription.
- Returned SIM cards are recycled for environmental purposes.
- Note that SIM card specifications and performance may change without notice.
- It is recommended that you keep a separate copy of information that is stored on SIM card. Asiateco is not responsible for damages from stored information that is lost.
- Always follow emergency procedures to suspend service if your SIM card or phone (SIM card inserted) is lost or stolen. For details, contact Customer Service.
- Always power off the phone before inserting/removing the SIM card.

Insert SIM Card

Follow these instructions to insert a SIM card. Remember to power off your phone before inserting a SIM card.

Note: [If Your phone's SIM card is preinstalled. These instructions are for reference only.](#)

1. Remove the battery cover and battery. (See [Remove the Battery](#).)
2. Gently insert the SIM card with the gold IC chip facing downward. (See the Quick Start Guide for additional instructions).

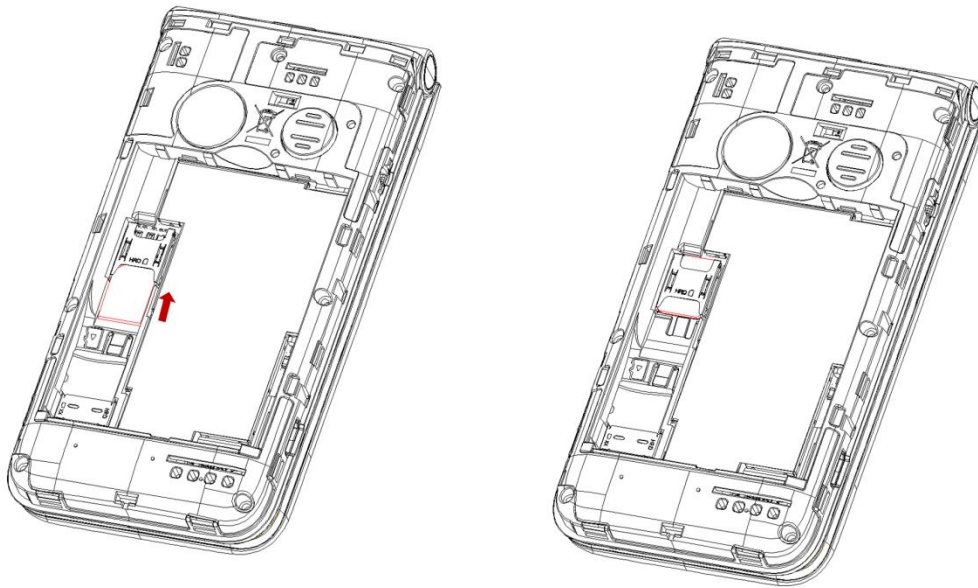

3. Insert the battery and replace the battery cover. (See [Insert the Battery](#).)
4. Make sure all the tabs are secure and there are no gaps around the cover.

SD Card

Your phone supports the use of an optional SD card (not included) to expand its storage capacity. Some cards may not operate properly with your phone.

SD Card Cautions

Data: Information stored on an SD card can become lost or changed accidentally or as a result of damage. It is recommended that you keep a separate copy of important data. Asiatelco is not responsible for damages from data that is lost or changed.

Reading/Writing Data: Never power off or remove the battery while reading or writing data.

Battery Level: A low battery may prevent reading/writing to an SD card.

Handling SD Card: Use/store SD cards away from the reach of infants and small children, it may cause choking if swallowed.

Insert an SD Card

Follow these steps to insert an optional SD card (not included).

Important: Make sure to power your phone off before inserting or removing an SD card.

1. Remove the battery cover and battery. (See Remove the Battery.)
2. Gently insert the SD card with terminals facing down all the way without bending the card.

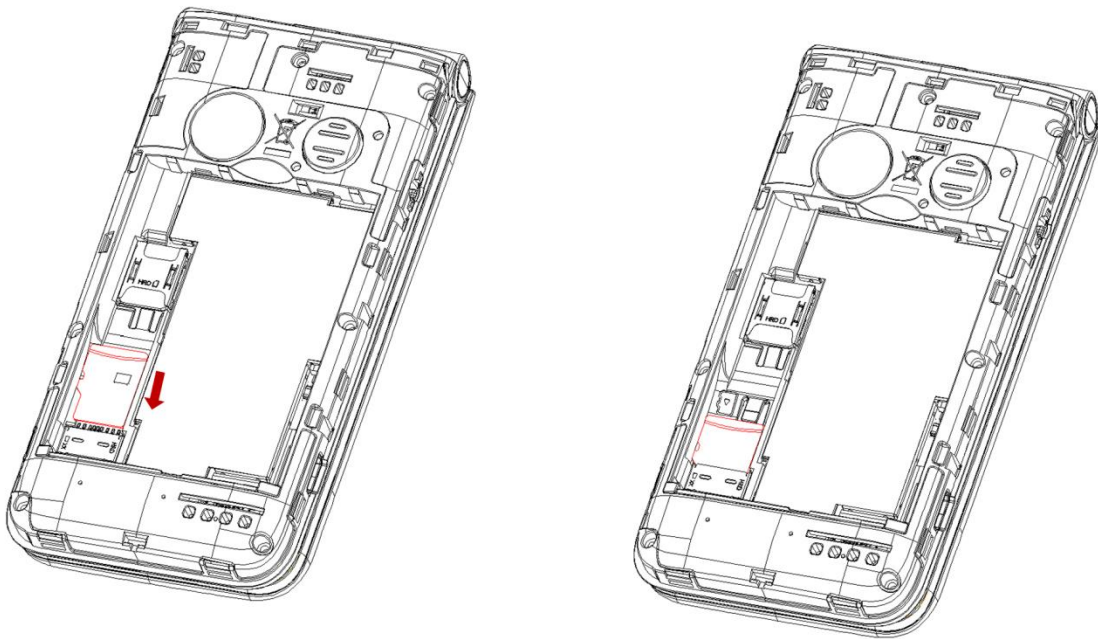

Important: Insert only SD cards needs either SD or image on card.

3. Insert the battery and replace the battery cover. (See [Insert the Battery.](#))
4. Make sure all the tabs are secure and there are no gaps around the cover.

Remove an SD Card

Follow these instructions to remove an SD card.

Important: Always power off before inserting or removing an SD card.

1. Remove the battery cover and battery. (See [Remove the Battery.](#))
2. Push down on the plastic spring and remove SD card.

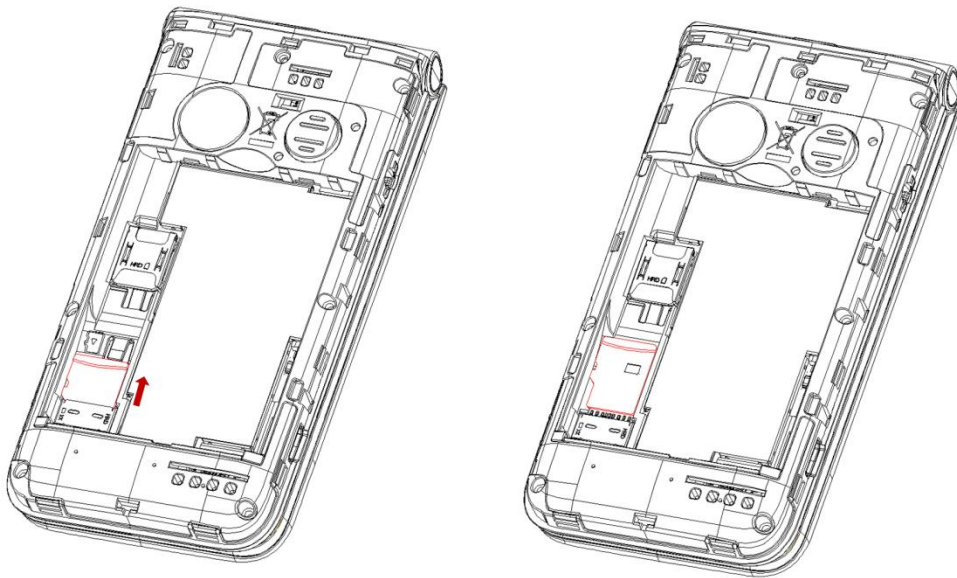

4. Insert the battery. Align the battery with the battery outline in the phone.
5. Attach the battery cover. Make sure all components are secure and there are no gaps around the cover.

Turn Your Phone On and Off

The instructions below explain how to turn your phone on and off.

Turn Your Phone On

Press and hold the **End/power key**  .



Your phone will power on. Depending on the settings, you may see the lock screen.



1. See [Lock and Unlock Your Screen and Screen Lock Settings](#) for information about using the screen lock.
2. The first time you turn the phone on, you will see the startup screens. See [Complete the Setup Screens](#) for details.
3. If your phone is not yet activated, see [Activate Your Phone](#) for more information. Turn Your Phone Off
4. Press and hold the **End/power key**  . Your phone will power off.

Note: Your screen remains blank while your phone is off (unless the battery is charging).

Complete the Setup Screens

The setup screens help you set up certain features and preferences on your phone. Once your phone has been turned on, you will see a Welcome message. You can then complete the setup process.

Note: You may be able to complete the setup screens before your phone has been activated on your account.

1. From the Welcome screen, select a language and press the **Right softkey**  to get started.
2. To skip any section, press the **Right softkey**  to skip.

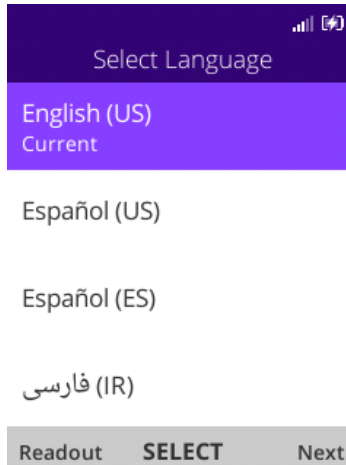

3. Follow the on-screen instructions to complete each section. For each topic, you will have the option to skip it and continue to the next screen.

Select a network—If prompted, follow the prompts to sign into an available Wi-Fi network. For secured Wi-Fi networks, you will need to enter a password. See Wi-Fi for more details.

Setup KaiOS Account—Use the **Navigation** key to select **Create Account** and set up a new KaiOS Account or **Login Account**. Complete the steps to sign in to your current KaiOS Account. Press the **Right soft key**  to skip. The following options may apply depending on your selection:

- **Create Account** – Follow the instructions to sign up for a new KaiOS Account.
- **Login Account** – Enter your KaiOS Account login address and password and sign in to your current KaiOS Account.

About KaiOS—Read any applicable Terms and Conditions of the KaiOS system for using your phone, press the **Right soft key**  to agree to the terms of service and privacy policy. Your setup is now complete.

Your phone is now set up for use. If you skipped any part of the setup, you can access additional options from the Apps screen or through Settings.

Basic Operations



The following topics outline basic features and operations of your phone.

Basics

The following topics offer an overview of your phone's basic operations.

Home Screen and Applications (Apps) List

Most of your phone's operations originate from the home screen or the apps list.

1. Press the **End/power key**  until display the home screen.
2. From any app screen press the **End/power key**  to display the apps list.

For information about using the home screen, see [Home Screen Basics](#).

Phone Settings Menu

You can customize your phone's settings and options through the Settings menu.

From the apps list screen, select **Settings** .

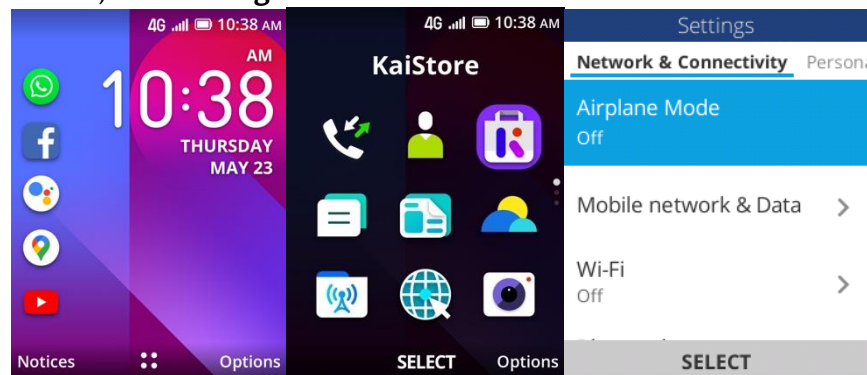

For more information, see [Basic Settings](#).

Capture Screenshots

You can take screenshots with your phone's shortcut key combination

- Press and hold the **Camera** key and **Volume down** key at the same time to capture a screenshot of the current screen.
- The current screenshot will be captured and stored in the Screenshots album in the phone's Gallery application. From the apps list screen, select **Gallery** .

Applications

The following topics describe how to access the applications (apps) list and launch apps on your phone.

Launch Applications

All installed apps can be accessed and launched from the apps list.

1. From home, press the **Center soft key**  .

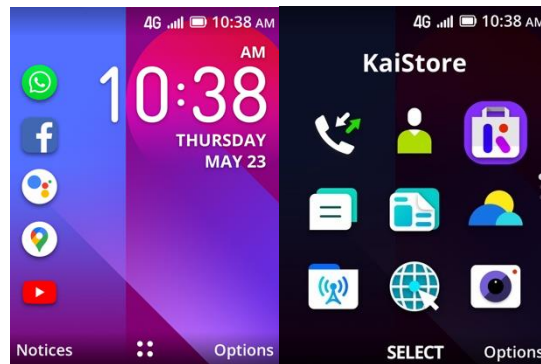











The apps list opens.

2. Use the **Navigation** key to select an application and then press  to launch the corresponding application. The application opens.

Apps List

The apps list expands to include all apps installed on your phone. The following table outlines the primary apps that have been preinstalled on your phone.

App	Function/Service
 Calculator	Perform basic mathematical calculations.
 Calendar	Create and manage events, meetings, and appointments, organize your time and reminds you of important events.
 Call Log	Review the call you are missed, dialed and received
 Camera	Take and share pictures and videos.

 Camera/Video	
 Clock	Set alarms, use a stopwatch, set a timer.
 Contacts	Manage your contacts from a variety of sources.
 FM Radio	Lets you listen to the radio.
 Browser	A browser you can use to surf on the Internet.
 Gallery	Manage your photos and videos.

Phone Number

Follow the instructions below to display your phone’s wireless phone number.

1. From the app list, select **Settings**  > **Device** > **Device Information**.
2. Select **Phone Number**.

You will see the number listed under **Phone Number**.

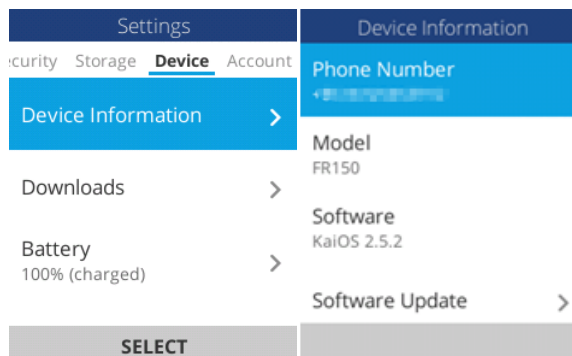



Airplane Mode

Airplane mode turns off all functions that emit or receive signals, while leaving your phone on so you can use apps that don't require a signal or data.

To turn on airplane mode:

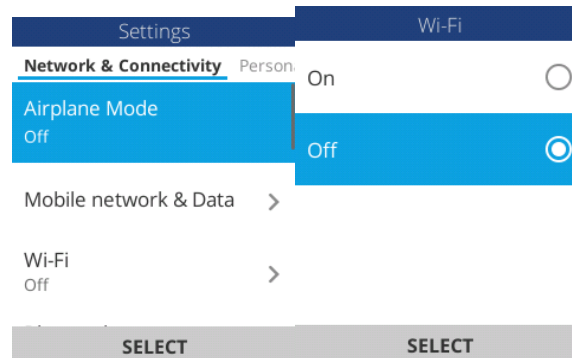
1. From the app list, select **Settings**  > **Network & Connectivity**.
2. Select **Airplane Mode**.
3. Select **On** to enable airplane mode.



Your phone is now in airplane mode. You will see the airplane mode icon  in the status bar. To turn off airplane mode:

1. From the app list, select **Settings**  > **Network & Connectivity**.
2. Select **Airplane mode**.
3. Select **Off** to disable airplane mode.

Your phone's wireless connection features are now restored.



Enter Text

You can enter text using your phone's Nuance T9 keyboard.

Text Input

There are different ways to enter text to create contacts, write emails or send messages. You may choose from the different methods by pressing the key  and alternate between:

1. Abc (sentence case), abc (lower case), or ABC (caps lock case): with this mode you must press each key multiple times to create each letter. For example, an 'S' is created by pressing the '7' key four times. An 'e' is created by pressing '3' twice, and so on.

2. 123: this mode generates only numbers. You may type '1' by pressing the '1' key just once, '2' by pressing '2' and so on. Switch back to ABC, Abc or abc mode to continue writing words.
3. Symbols: This function provides punctuation and special characters. Symbols may be accessed by pressing the key  as well. Find the right symbol by pressing right/left of the Navigation Key. When the cursor highlights a symbol you want to add, press the **Center Soft Key**  to select it.
4. If you want to delete the already typed letters or symbols, press the **End/power key**  to delete them one by one or long press to delete all at once.

Lock and Unlock Your Screen

Your phone allows you to quickly turn the screen on/off when you unfold/fold the phone, or you can set up screen lock to prevent others from using your phone without your permission.

Turn the Screen Off When Not in Use

1. To quickly turn the screen off, simply fold (close) the phone.
2. To save battery power, the phone automatically turns off the screen after a certain period of time when you leave it idle. You will still be able to receive messages and calls while the phone's screen is off.

Note: For information on how to adjust the time before the screen turns off, see [Display Settings](#).

Turn the Screen Lock On or Off

1. From the app list, select **Settings**  > **Privacy & Security** > **Screen Lock**.
2. Select **On** to enable screen lock.
3. You will be prompted to enter the passcode. See [Screen Lock Settings](#).

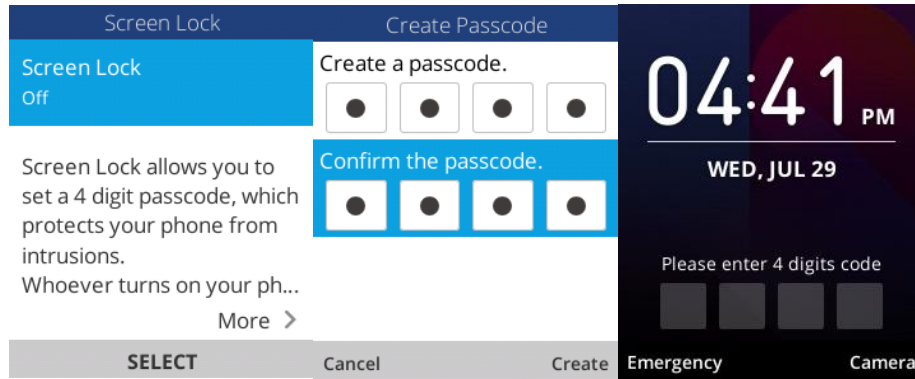

Update Your Phone

From time to time, updates may become available for your phone. You can apply updates through the **Settings**  > **Device** > **Device Information** > **Softwareupdate** menu.

Software Update Cautions
During update: The phone cannot be used until the software update is complete. It may take time to update your phone's software.

Signal during update: Update your phone where signal reception is good, and do not change location during the update process. Make sure the battery is adequately charged before beginning an update. A weak signal or low battery during an update may cause the update to fail. An update failure may disable the phone. Should the phone be plugged into power source and charging while an update is being performed?

Other functions during update: Other phone functions cannot be used during a software update.

Update Your Phone Software

You can update your phone's software using the System Updates option.

1. From the app list, select **Settings**  > **Device** > **Device Information** > **Softwareupdate**.

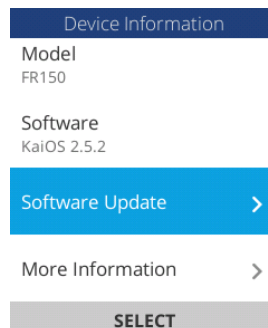

2. Select **Software update**.

You may be required to power your phone off and back on to complete the software upgrade.

Confirm Your Current Phone Software

1. From the app list, select **Settings**  > **Device** > **Device Information**.

2. Locate the **Software version** read-only field.

Your Phone's Home Screen



The following topics describe how to use your phone's home screen and understand the status bar.

Home Screen Basics

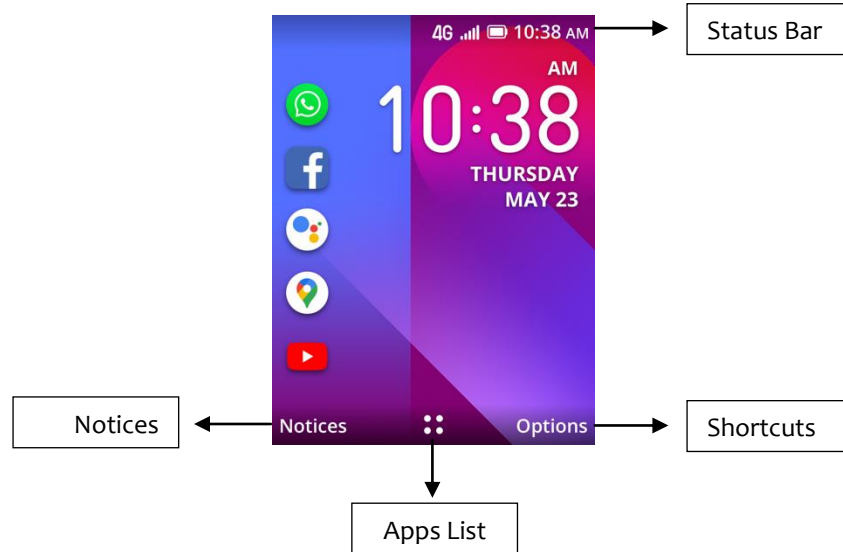
The home screen is the starting point for your phone's applications, functions, and menus.



Item	Description
Status Bar/Status Area	<p>The status bar displays icons to notify you of your phone's status (on the right side) and notifications (on the left side).</p> <p>The status area of the status bar (on the right) displays phone and service status information such as signal strength, battery status, Wi-Fi and data connectivity, ringer status, and time.</p>























Notices	Press the Left soft key  to view numerical notifications (missed call, new mail, new message, etc.).
Apps list	Press the Center soft key  to enter the apps list.
shortcuts	Press the Right soft key  to enter shortcuts.

Tip: Press the End/power key  to return to the main home screen.

Status Bar

The status bar at the top of the home screen provides phone and service status information on the right side and notification alerts on the left.

Notification Icons

4G	Connected to 4G mobile network		Vibrate mode
H	Connected to 3G mobile network		Battery indicator, battery is full
E	Connected to GPRS mobile network		Battery is charging
R	Roaming		Aeroplane mode
	SIM Mobile network signal strength		Connected to a Wi-Fi network
.	SIM Mobile network signal weak		VoWiFi enabled
	New email message		VoLTE enabled
	New text message		Bluetooth on
	Upcoming event		USB connected
	Alarm is set		Missed call
	Data is syncing		Speakerphone mode
	Problem with sign-in or sync		Handset mode
	Notification reminder		Headphones are connected
	Downloading data		Phone microphone is muted

Change the Home Screen Wallpaper

Select and assign your phone's background wallpaper.

1. From the apps list, select **Settings**  > **Personalization** > **Display** > **Wallpaper**.

2. Select **Wallpaper** and use the **Navigation** key to select from **Gallery**, **Wallpaper**, or **Camera**.
3. Select a wallpaper and then press the **Right softkey**  to set the wallpaper.

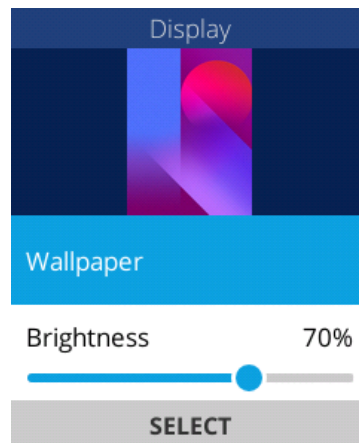

Making Connections

The topics in this section will cover your phone's ability to help you make connections, from phone calls and maintaining contacts, to text messages, email, Internet, and international services.

Phone Calls and Voicemail

The following topics outline the use of your device's phone app to place and receive calls, use voicemail, and more.

Place and Answer Calls

The following topics describe how to directly dial calls, how to answer incoming calls, and how to use the in-call screen options.

Adjust In-Call Volume

Adjusting Call Volume: Press the **Volume** key up or down during the call.

Troubleshooting

Problem: Difficulty during call.

Answer 1: It may not be possible to make a call properly in a noisy location.

Answer 2: When calling using Speaker, check the call volume. Raising the call volume may make calling difficult.

Problem: Sound pops momentarily during a call.

Answer: Are you changing location while calling? Sound pops when signal is weak and the phone switches to a different area.

Emergency Call Cautions

Emergency calls are restricted in Airplane mode. Press a small round button on the back of the phone and the phone vibrates to automatically dial 911 for an emergency call.



Call Using the Phone Dialer

Calling is by using the phone's dialer screen.

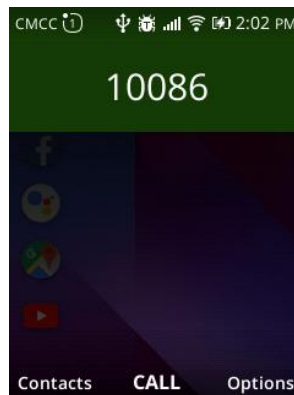
1. Press the number keys on the keypad to enter the phone number.



As you enter digits, Smart Dial searches for contacts that match. If you see the number you want to dial, use the **Navigation** key to select the number and place the call immediately without entering the rest of the phone number.

2. Select  key or select  to call the number. The phone dials the number. The call begins when the other party answers.

3. To end the call, press the **End/power key** . The call ends.

4. From the apps list, select **Call Log**  to View your call log.

Troubleshooting

Problem: Call does not connect.

Answer 1: Was the number dialed using the area code? If not, try dialing using the full 10-digit number including the area code.

Answer 2: Are you in an area with poor wireless coverage? Try calling again from another area.

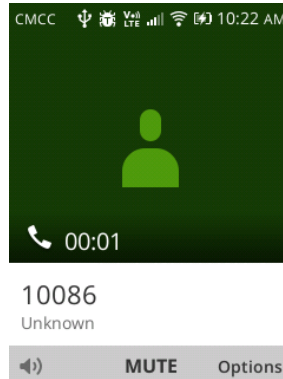

International call

To dial an international call, press twice ***+** to enter “+” in dial screen, enter the international country prefix followed by the full phone number, then press the **Call Key**

Call Emergency Numbers

You can place calls to 9-1-1 even if the phone’s screen is locked or your account is restricted. There are three ways to place an emergency numbers.

1. To call the 9-1-1 emergency number when the phone’s screen is locked with a screen lock:
 1. On the lock screen, select **Emergency** into dial pad.

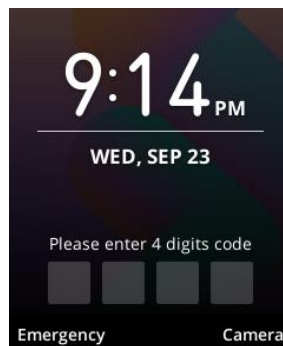

2. Dial 9-1-1 on the key pad

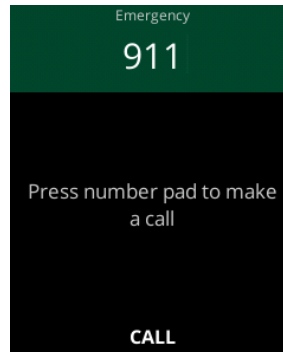

3. As long as you are in an area covered by wireless service, the emergency call is placed.
2. To call the 9-1-1 emergency number normally or when your account is restricted:
 1. Unlock the screen. For more information, see Lock and Unlock Your Screen.
 2. Press the number keys on the keypad, Press **9-1-1**.
 3. As long as you are in an area covered by wireless service, the emergency call is placed.
3. Call the 9-1-1 emergency number via the **SOS key**. Whenever your phone is locked or unlocked, closed or opened. You are able to press and hold the **SOS key** for a few seconds, 9-1-1 is dialed automatically.
 - i. Press and hold the **SOS key** until the vibration stops, meanwhile the prompt coming out will say, "Please open the flip phone". You have to flip the phone if the phone prompts you to do so.
 - ii. 9-1-1 is dialed automatically without any other action.
 - iii. As long as you are in an area covered by wireless service, the emergency call is placed.

Enhanced 9-1-1 (E 9-1-1) Information

This phone features an embedded Global Positioning System (GPS) chip necessary for utilizing E9-1-1 emergency location services where available.

When you place an emergency 9-1-1 call, the GPS feature of your phone seeks information to calculate your approximate location. Depending on several variables, including availability and access to satellite signals, it may take 30 seconds or more to determine and report your approximate location.

Important: Always report your location to the 9-1-1 operator when placing an emergency call. Some designated emergency call takers, known as Public Safety Answering Points (PSAPs), may not be equipped to receive GPS location information from your phone.

Answer Phone Calls

The following information lets you know how to answer incoming calls, mute the ringer on incoming calls, reject incoming calls, and more.

When you receive a phone call from a contact, the sub screen appears and displays the caller name. When you receive a phone call from someone who is not stored in Contacts, the phone number appears on the Incoming call screen.

Note: If your phone is turned off, all calls automatically go to voicemail.

Answer an Incoming Call

1. When a call arrives, press the **Call Key**  or **Left soft key** . The call begins.
2. To end the call, press the **End/power key** . The call ends.

Mute the Ringing Sound

To mute the ringer without rejecting the call, you can press the **Volume** key down.

Reject an Incoming Call

When a call arrives, press the **Right soft key**  or the **End/power key**  to reject it.

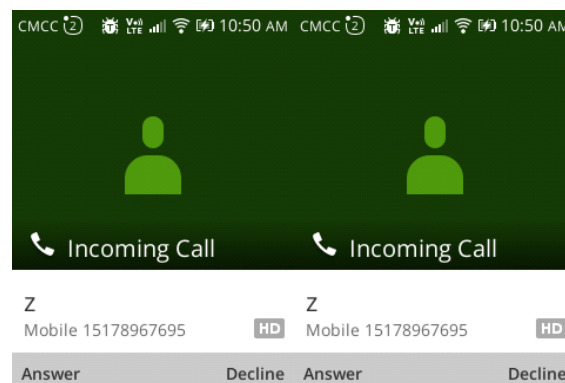

The ringtone or vibration will stop and the call will be sent directly to voicemail (if voicemail is activated).



In-Call Screen Layout and Operations

While you're on a call, you will see a number of onscreen options.

- **Speaker:** Route the phone's audio through the speaker (On) or through the earpiece (Off).
 - Press the **Left soft key**  to activate **Speaker** to route the phone's audio through the speaker. (You can adjust the speaker volume using the **Volume** key.)

- Press the **Left soft key**  again to deactivate **Speaker** to use the phone's earpiece.

Warning: Because of higher volume levels, do not place the phone near your ear during speakerphone use.

- **Mute:** Mute the microphone during an active call.
 - Press the **Center soft key**  to mute the microphone.
 - Press the **Center soft key**  again to open the microphone.
- **Options:** Press the **Right soft key**  to display the **Options** details as below.

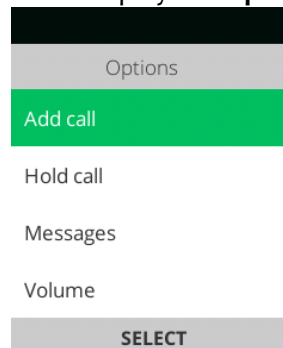



- **End call:** Press the **End/power key** to end the current call.

Place a Call from Contacts

You can place phone calls directly from entries in your Contacts list.

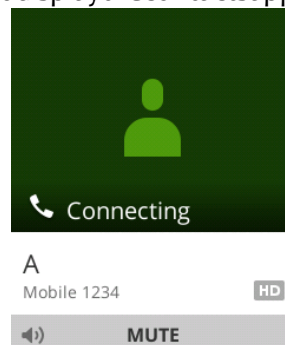
1. From the app list, select **Contacts**  to display the contacts app.



2. Select **Contact** to display the Contacts list. The contacts list appears.
3. Use the **Navigation** key to select a contact.
4. Press the **Center soft key**  to call the number.
5. To end the call, press the **End/power key** . The call ends.

Call from Call Log

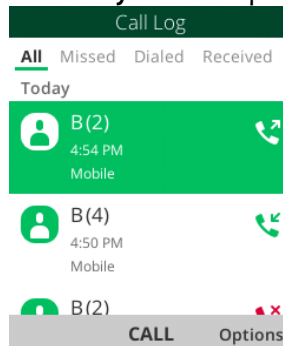

The call log list lets you quickly place calls to recent received, dialed, or missed.

1. From the apps list, select  or press the **Callkey**  to display the call log list.

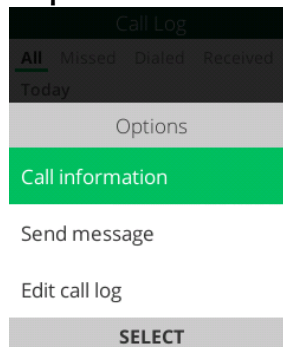

2. Press the **Right softkey**  to display the **Options** details.



3. Press the **Center softkey**  or the **Callkey**  to place a call. The phone dials the number. The call begins when the other party answers.

4. To end the call, press the **End/powerkey** . The call ends.

Voicemail

Follow the instructions below to set up voicemail on your phone. You should set up your voicemail and personal greeting as soon possible once your phone is activated. Always use a passcode to protect against unauthorized access. Your phone automatically transfers all unanswered calls to your voicemail, even if your phone is in use or turned off.

1. From the apps list, select **Contacts** .
2. Select a contact and press **options**
3. Select **Settings**

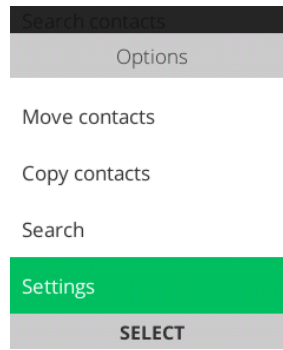

4. Select **Set Speed Dial Contacts**

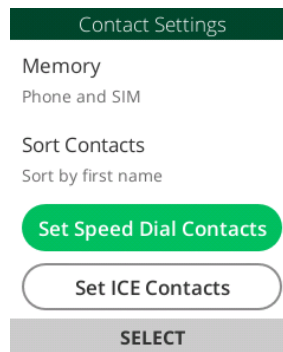

5. Select **Voicemail** and **edit**

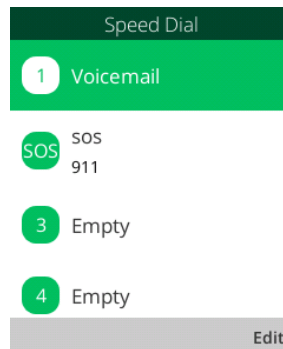

6. All settings are finished. Return to home screen and hold **1^{oo}** to start the voicemail.

Important: Voicemail Passcode – It is strongly recommended that you create a passcode when setting up your voicemail to protect against unauthorized access. Without a passcode, anyone who has access to your phone is able to access your voicemail messages.

Optional Calling Services

The following topics outline additional voice-related services available with your phone, including call services and more.

Call Waiting

When you're on a call, your phone's screen informs you that another call is coming in and displays the caller's phone number (if it is available).

To respond to an incoming call while you're on a call:

Use the **Navigation key** to select to answer the call or to ignore the incoming call. (Answering the call puts the first caller on hold and answers the second call.)

Conference Calling

With conference calling, also known as 3-way calling, you can talk to two people at the same time. When using this feature, the normal airtime rates will be charged for each of the two calls.

1. On the Phone screen, enter a number and press the **Call key** (or place a call from Log or Contacts).
2. Once you have established the connection, dial the second number. This puts the first caller on hold and dials the second number.
3. When you're reconnected to the second party, press **Merge Call**. Your conference call is now in session.

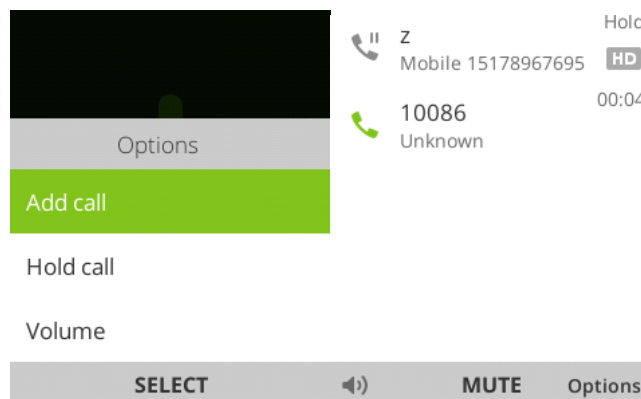

Note: If one of the people you called hangs up during your call, you and the remaining caller stay connected. If you initiated the call and are the first to hang up, all callers are disconnected.

Call Forwarding

Call Forwarding lets you forward all your incoming calls to another phone number – even when your phone is turned off. You can continue to make calls from your phone when you have activated Call Forwarding.

Note: You are charged a higher rate for calls you have forwarded.

To activate Call Forwarding:

1. From the app list, select **Settings**  > **Network & Connectivity** > **Calling** > **Call Forwarding**.

The call forwarding menu appears.

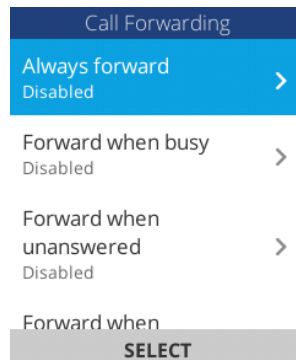

2. Configure your options. Your call settings options are set.

Call Settings

Your phone's Call Settings menu lets you configure a number of other settings for the phone application.

Use the Call Settings Menu

1. From the app list, select **Settings**  > **Network & Connectivity** > **Calling**. The call settings menu appears.

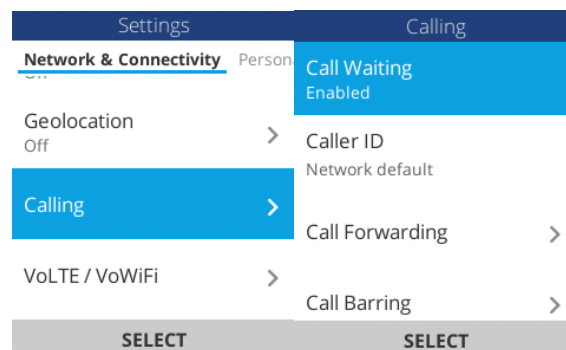

2. Configure your options.

Select a menu item to display its options.

Select your options and follow the prompts to set them.

3. Your call settings options are set.

Important—Some of the calling settings may need the support of your carrier.

TTY Mode

A TTY (teletypewriter, also known as a TDD or Text Telephone) is a telecommunications device that allows people who are deaf, hard of hearing, or who have speech or language disabilities, to communicate by telephone.

Your phone is compatible with select TTY devices. Please check with the manufacturer of your TTY device to ensure that it supports digital wireless transmission. Your phone and TTY device will connect using a special cable that plugs into your phone's headset jack. If this cable was not provided with your TTY device, contact your TTY device manufacturer to purchase the connector cable.

To turn TTY Mode on or off:

1. From the app list, select **Settings**  > **Device** > **Accessibility** > **TTY**.
2. Select **Full**, **HCO**, or **VCO** to turn TTY mode on. –or– Select **Off** to turn TTY mode off. Your phone's TTY mode is set.

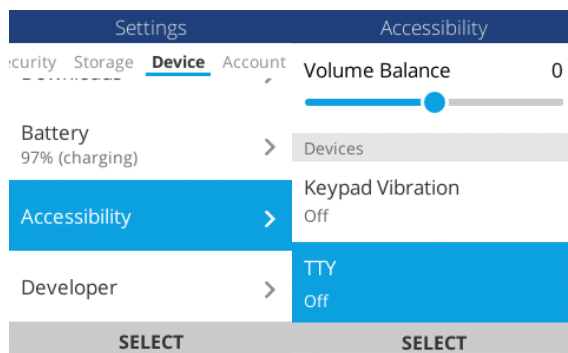

Note: When enabled, TTY mode may impair the audio quality of non-TTY devices connected to the headset jack.

Warning: 9-1-1 Emergency Calling

It is recommended that TTY users make emergency calls by other means, including Telecommunications Relay Services (TRS), analog cellular, and landline communications. Wireless TTY calls to 9-1-1 may be corrupted when received by public safety answering points (PSAPs), rendering some communications unintelligible. The problem encountered appears related to TTY equipment or software used by PSAPs. This matter has been brought to the attention of the FCC, and the wireless industry and the PSAP community are currently working to resolve this.

Contacts

The Contacts application lets you store and manage contacts from a variety of sources, including contacts you enter and save directly in your phone.

Contacts Cautions

Information saved in Contacts may be lost or changed if the battery is removed for a long period or left uncharged. Accident or malfunction may also cause loss or change to information. It is recommended that you keep a separate copy of contacts and other important information. Sprint is not responsible for any damages from lost or changed contacts.

Add a Contact

You can add contacts from your phone's Phone application. Enter details such as name, phone numbers, email addresses, mailing addresses, and more.

1. From the apps list, select **Contacts** .

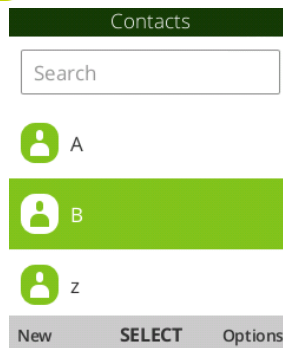

You will see the Contacts list.

2. Press the **Left softkey**  to add a contact.

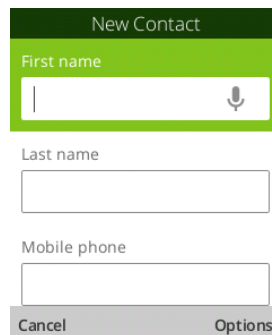

The New Contact screen appears.

3. Use the keyboard to enter as much information as you want.

- FirstName
- LastName
- MobilePhone

- PersonalEmail

4. When you have finished adding information, press the **Right softkey** and select **Save**. The contact is added.

Save a Phone Number

You can save a phone number to Contacts directly from the phone keypad.

1. Enter a phone number and select **options** ----> **Create New Contact**.
2. To add the number to an existing contact, select **Add to Existing Contact**. To add a new contact, select **Create new contact**.
 1. For an existing contact, choose the contact name and press  to select **Add** menu to **Add phone**, enter the number you want to add.
 2. For a new contact, select Phone memory or SIM memory, then enter the name and any additional information.
3. Choose **Save**. The contact is added.

View Contacts

1. View a contact's details by displaying a contact entry.

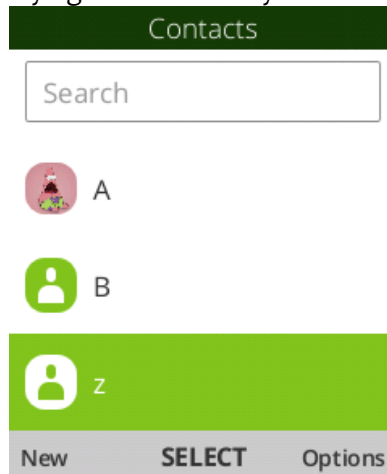

2. You will see the Contacts list
3. Select a contact to view its details.
4. The contact's detailed listing appears.

Contacts Screen Layout

The following illustration show's your Contacts app layout and describes the various features.

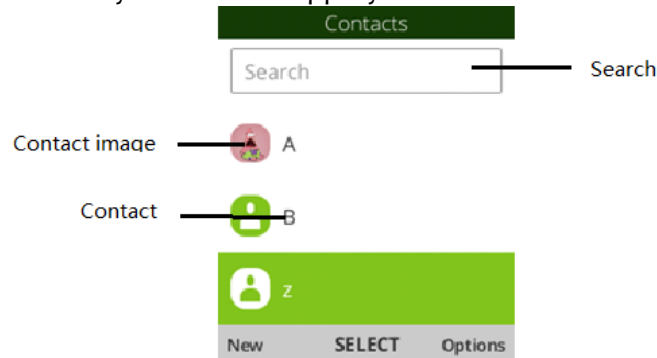

Item	Description
All contacts tab	Show all contacts.
Speed Dial tab	Show speed dial contacts.
Contact	Select to show contact's details.
Contact image	Show thumbnail of contact entry.
Search	Search contacts.

Edit a Contact

Once you've added a contact, you can add or edit any of the information in the entry, assign a caller ID picture, customize with a unique ringtone, and more.

1. From the app list, select **Contacts** . You will see the Contacts list.
2. Select a contact to view its details.

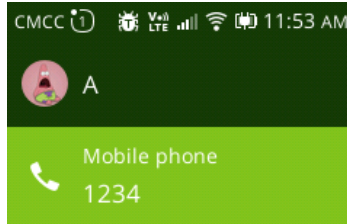

The contact's detailed listing appears.

3. Press the **Right softkey** and then select **Edit Contact**.
4. Add or edit the information, and then press **Save**. Your changes are saved to the contact entry.

Delete a Contact

You can delete a contact from the contacts details page.

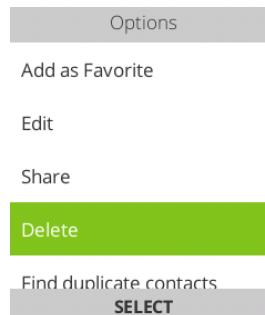

1. From the app list, select **Contacts**. You will see the Contacts list.
2. Select a contact to view its details. The contact's detailed listing appears.
3. Press the **Right softkey** and then select **Delete**.
4. Select **Delete**.



The contact is deleted.

Share a Contact

You can quickly share contacts using Bluetooth, Gmail, or text messaging.

1. From the app list, select **Contacts** . You will see the Contacts list.
2. Select a contact to display it, and then press the **Right softkey**  and select **Share**.
3. In the **Share With** menu, select a method:
 - **E-Mail** to send the information as an Email attachment. Address the message, add a subject and a message, and then select **Send**. See [Create and Send Email](#) for details.
 - **Messages** to send the information in a text message. Select a contact or enter a wireless phone number, enter any additional information, and then select **Send**. For more information on text messaging, see [Send a Multimedia Message \(MMS\)](#).
 - **Bluetooth** to send the information via Bluetooth. See [Bluetooth](#) for information on pairing and sending via Bluetooth.
4. Complete the required steps as prompted for the selected method. The selected contact will be shared.



Import Contacts

Your phone offers a couple of options for importing contacts from installed SD memory cards or external devices via USB.

Before Importing Contacts from an SD Card

You will need to have installed an SD card with previously backed up contacts information into your phone before you can import contacts. See [SD Card](#) for SD card information.

Import Contacts from an SD Card or USB Storage

1. From the app list, select **Contacts** . You will see the Contacts list.
2. Press the **Right softkey**  and then select **Settings > Import Contacts/Export Contacts**.

You will see the Import Contacts/Export Contacts menu.

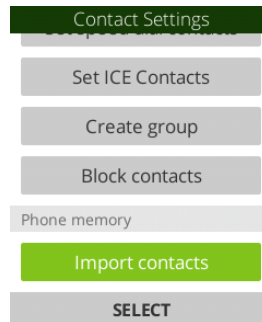

3. Select **Import Contacts** or **Export Contacts**.

4. Follow the onscreen instructions to complete the import.

The contacts are imported and stored in the selected account.

Back Up Contacts

If you are saving contacts to an account that does not automatically back them up via the Cloud, you can manually back them up to an optional installed SD card for re-import if needed.

Before Backing Up Contacts to an SD Card

You will need to have installed an SD card with previously backed up contacts information onto your phone before you can back up your contacts. See [SD Card](#) for SD card information.

Back Up Contacts to Your SD Card

1. From the app list, select **Contacts**. You will see the Contacts list.

2. Press the **Right softkey**  **Settings** and select **Import Contacts/Export Contacts**. You will see the Import Contacts/Export Contacts menu.

3. Select **Export Contacts**.

4. Select **Memory card** to confirm the export.

5. Follow the onscreen instructions and select contacts to complete the export.

The contacts are exported and saved to the installed SD card.

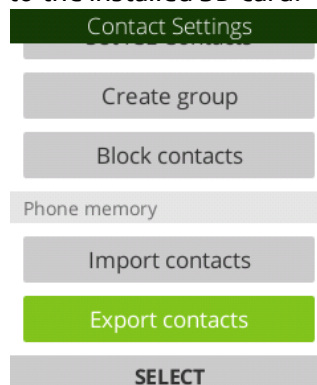

Messaging

With wireless service and your phone's messaging capabilities, you have the opportunity to share information through many different channels and accounts, including personal and corporate email, and text and multimedia messaging.

Text and Multimedia Messaging

With text messaging (SMS), you can send and receive instant text messages between your wireless phone and another messaging-ready phone. Multimedia messages, or MMS, can contain text, pictures, music, audio or video files, and contact cards. See your service plan for applicable charges for messaging.



Send a Text Message

Quickly compose and send text messages on your phone.

1. From the app list, select **Messages** .

–or–

Select  from any screen except during call.

2. On the Messages screen, press the **Left soft key** . The Compose screen opens.
 - Fill in one or more recipients. You can now compose messages. Enter phone numbers directly in the **To** field. As you enter information, any matching phone numbers from your contacts list are displayed. Select a match to enter that number or address directly.
 - Press the **Right soft key**  to add the contacts to whom you want to send the message.
3. Select the “Message” box and then start composing your message.
4. When done, press the **Left soft key**  to **send** the text message.

Note: Once you go over the 160-character limit, a new message is created but automatically joined into one when received.



Send a Multimedia Message (MMS)

When you need to add a little more to a text message, you can send a multimedia message (MMS) with text and pictures, music, audio or video files, contact cards.

1. From the app list, select **Messages** .

–or– Select  from any screen.

2. On the Messages screen, press the **Left soft key**  to compose messages.

3. Fill in one or more recipients. You can:
 - Enter phone numbers directly in the **To** field. As you enter information, any matching phone numbers from your contacts list are displayed. Select a match to enter that number or address directly.
 - Press the **Right soft key**  to add the contact to whom you want to send the message.
4. Select the “Message” box and then start composing your message.
5. Press the **Right soft key**  and select **Add Attachment**.

Note: To add a subject line, press the **Right soft key**  and select **Add Subject**.

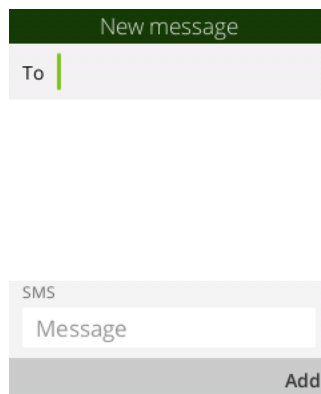



6. In the Attach window, select from the following file attachments:
 - **Video.** Select a video and attach it.
 - **Music.** Select a track from your phone or memory card.
 - **Gallery.** Select a photo from Gallery.
 - **Contacts.** Select a contact from your phone.
 - **Camera.** Select **Camera** to take a photo or a video.
7. Press the **Left soft key**  to send the MMS message.

Save and Resume a Draft Message

While composing a text or multimedia message, press the **Right soft key**  Options and select “Save as draft”.

To resume composing the message:

1. From the app list, select **Messages** .
2. On the Messages screen, select the message to resume editing it.
3. When you finished editing the message, press the **Left soft key** .

New Messages Notification

Depending on your notification settings, the phone will play a ringtone and/or vibrate when you receive a new text or multimedia message.

A notice icon also appears in the notifications area of the status bar to notify you of a new text or multimedia message. When you unfold the phone, a pop-up will display to notify you the new message waiting for you to check it.



Manage Message Conversations

Text and multimedia messages that are sent to and received from a contact (or a number) are grouped into conversations or message threads in the Messages screen. Text or MMS conversations let you see exchanged messages (similar to a chat program) with a contact on the screen.

Read a Text Message

On the Messages screen, press the text message or conversation to open and read it. press **End/power key**  return to the Messaging screen from a conversation.

Note:



1. To view the details of a particular message; in the conversation, press the **Right soft key**  to open the options menu, and then choose **View message report**.
2. If a message contains a link to a Web page, select the message, then press the **Center soft key** , choose the link to open it in the Web browser.
3. If a message contains a phone number, press the **Center soft key**  and then press the phone number to dial the number or add it to your contacts.

View a Multimedia Message (MMS)

1. From the app list, select **Messages** .
2. On the Messages screen, select a multimedia message or conversation to open it.
3. Select the attachment to open it.

Note: If you are concerned about the size of your data downloads, check the multimedia message size before you download it.

Reply to a Message

1. From the app list, select **Messages** .
2. On the Messages screen, select a conversation to open it.
3. Select the Message box at the bottom of the screen, enter your reply message, and then press the **Left soft key**  to send.

Note: To reply to a text message with a multimedia message, open the text message, press the **Right soft key**  and then select **Add Subject** or **Add Attachment**. The text message is automatically converted into a multimedia message.



Delete Conversations

1. From the app list, select **Messages** .
2. On the Messages screen, press the **Right soft key**  and select **Delete Thread** to delete the conversation.
3. To delete more than one conversation, select **Delete** and then press the **Right soft key** to delete the intended messages.

Tip: You can also delete a conversation while you're viewing it. While viewing a conversation, press the **Right soft key** and then select **Delete** to confirm.

Text and MMS Options

The messages settings menu lets you control options for your text and MMS messages including message limits, size settings, and notifications.

1. From the app list, select **Messages** .
2. On the Messages screen, press the **Right soft key**  and select **Settings**. You can set the following:
 - **AutoRetrieveMessages:** Select this option to automatically retrieve all your multimedia messages completely. When selected, the multimedia message header plus the message body and attachments will automatically download to your phone. If you turn off, only the multimedia message header will be retrieved and shown in your Messaging screen.
 - **WAPPush:** Press to enter WAP push options.
 - **Emergency alerts:** Press to enter Emergency alert options.

SOS Message

SOS message is a message you should have pre-edited in the phone. When you call emergency numbers, SOS message will be sent to the SOS contacts automatically

1. Edit SOS message, select Settings  > Personalization > SOS Message.

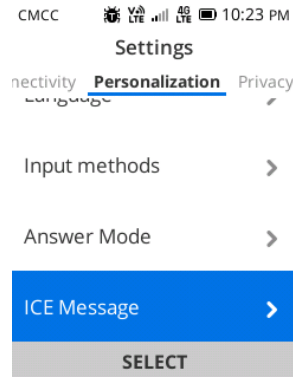

2. Set the SOS contacts, you can set 5 five contacts as the SOS contacts at most.

- a. From the apps list, select Contacts .
- b. Select a contact and select **options**

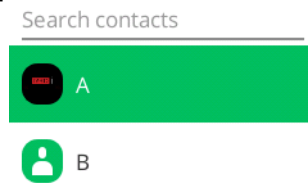

- c. Select **Settings**

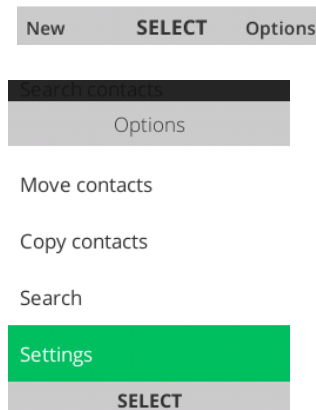

- d. Select **Set SOS Contacts**

e. Add SOScontacts

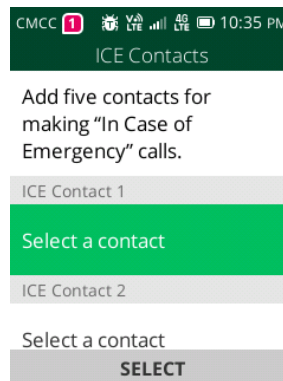
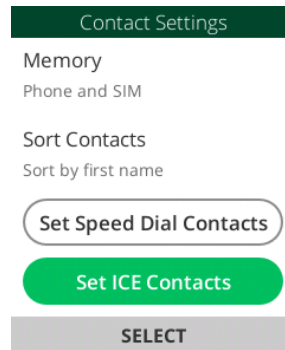

E-Mail

Use the E-Mail application to send and receive email from your webmail or other accounts, using POP3 or IMAP, or access your Exchange ActiveSync account for your corporate email needs.

Set Up an Email Account



Your phone supports several types of email accounts and allows you to have multiple email accounts set up at one time.

Before setting up an email account, make sure you have the username (user ID), password, server name, etc., so you can get set up successfully.

1. From the app list, select **E-Mail** . If no email account has been previously setup, a popup window where you can add an account appears.
2. Follow the onscreen instructions to set up your email account. The email account is set up and you will begin receiving email.

Add Another Email Account

If you have multiple email accounts that you wish to view on your phone, you can add several types of personal email accounts, such as POP3 and IMAP accounts on your phone.

1. From the apps list, select **E-Mail** .
2. Press the **Right soft key**  and select **Settings**. Then press the **Left soft key**  account.
3. Follow the onscreen instructions to complete the account setup.

The email account is added and you will begin receiving email for the account.



Create and Send Email

Compose and send email using any account you have set up on your phone. Increase your productivity by attaching files such as pictures, videos, or documents to your email messages.

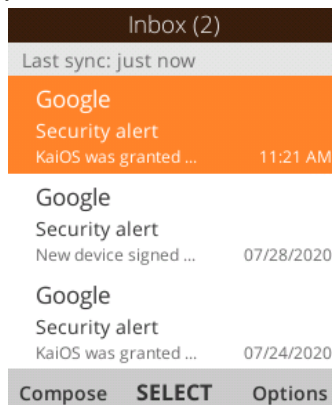
1. From the apps list, select **E-Mail** .





The email inbox opens.

2. From the inbox, press the **Left soft key**  to compose. The email composition window opens.
3. Enter the message recipient(s), subject, and message, and then press the **Left soft key**  to send.

The email message is sent.

Email Composition Options

- **Add Cc/Bcc:** In the mail subject or composition box, press the **Right soft key**  to add recipients.
- **Add Attachment:** In the mail composition box, press the **Right soft key**  > **Add Attachment**. Locate and then choose the picture or video you want to attach.
- **Save to Local Draft (Send Later):** While composing your message, press the **End/power key**  and a pop-up window will display to save as a draft.

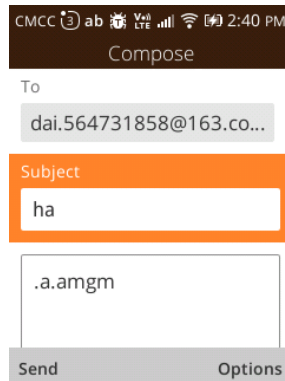

Note: To view your draft email messages, in the inbox, press the **Right soft key** \rightarrow **View Folders > Local Drafts**.

Note: To view your sent messages, in the inbox, press the **Right soft key** \rightarrow **Outbox**.

Open Email Messages

You can also open and read email messages directly from the email inbox. Reading and replying to email on your phone is as simple as on your computer.

1. From the apps list, select **E-Mail** . The email inbox opens.
2. Press the message you want to view. The email message opens.
3. Press the **Left soft key** \leftarrow to reply to an email directly. Press the **Right soft key** \rightarrow to open email options to reply to the message.

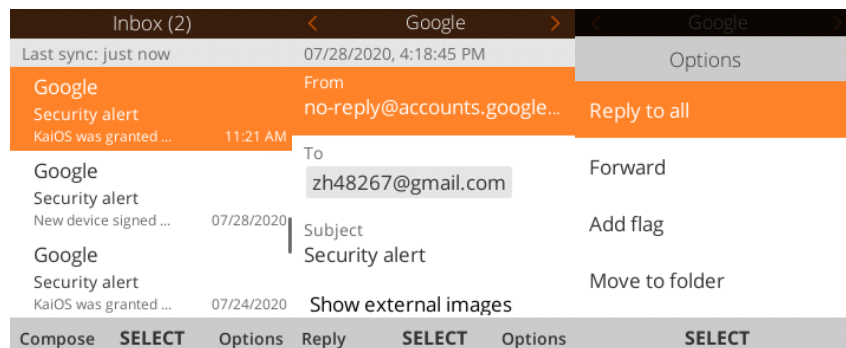

Delete an Email Account

You can delete an email account from your phone if you no longer wish to receive messages for the account on your phone.



1. From the apps list, select **E-Mail** . The email inbox opens.
2. Press the **Right soft key** \rightarrow **Settings**.
3. Select the account(s) to delete, and then press the **Left soft key** \leftarrow to confirm.

The account is deleted from your phone

Manage Your Email Inbox

Your email inbox provides management options for viewing, sorting, and deleting your email messages.

View Your Email Inbox

1. From the app list, select **E-Mail** . The email inbox opens.
2. Press the **Right soft key**  > **View Folders** > **Inbox** to see all your email inboxes at once.

Refresh an Email Account



Whatever your automatic synchronization settings are, you can also synchronize your sent and received email messages manually at any time.

While viewing the account you want to synchronize, press the **Right soft key**  > **Synchronize**.

Delete an Email Message

Choose the message you want to delete, press the **Right soft key**  > **Delete**.

Delete Multiple Email Messages

1. On the email account inbox, press the **Right soft key**  > **Edit** > **Select Multiple**.
2. Select the messages you want to delete.
3. Press the **Right soft key**  > **Delete**, and then press the **Right soft key**  to confirm.



Internet

The following topics describe how to connect to and use the Internet on your phone.

Data Connection Status and Indicators

Your phone displays the current status of your data connection through indicators at the top of the screen. The following symbols are used:

Icon	Status
	Network (full signal): The fullness of the triangle icon indicates the strength of the signal. A

	fuller icon means a better signal.
	4G LTE data service: Your phone is connected to a 4G LTE network.
	Wi-Fi connection: Your phone is connected to a Wi-Fi network for data.

Browser

Your phone's Web browser gives you full access to both mobile and traditional websites on the go, using 2G, 3G, 4G, or Wi-Fi data connections.

SSL/TLS

SSL (Secure Sockets Layer) and TLS (Transport Layer Security) are protocols for encrypting sent/received data. While in a screen connected by SSL/TLS, data is encrypted to safely send/receive private information, credit card numbers, corporate secrets, etc., and provide protection against online threats (eavesdropping, falsification, impersonation, etc.).

SSL/TLS Cautions

When opening a secured page, users must decide as their responsibility whether or not to open the page with use of SSL/TLS. Sprint and the applicable Certification Authorities make no guarantees whatsoever to users regarding security of SSL/TLS.

Use the Browser

Your phone supports the Web browser for surfing on the Internet. 1. From the apps list, select **Browser** .



Browser opens.

2. Press the **Left softkey**  to enter search words or a Web address (URL). The search results appear or a Web page opens.

3. Use the **Navigation key** to locate the place you want to visit, and then press  to confirm.

Browser Options

Customize your experience with the Internet through the browser options menu.

1. From the apps list, select **Browser** .

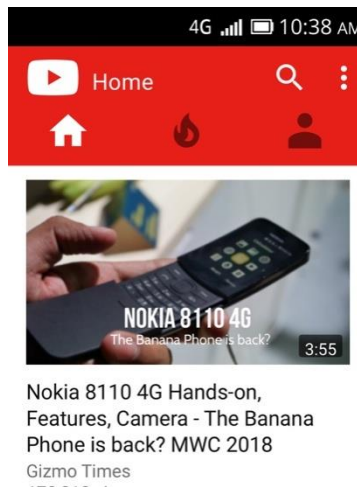

2. Press the **Right softkey**  to open browser options.

Your browser options are displayed.

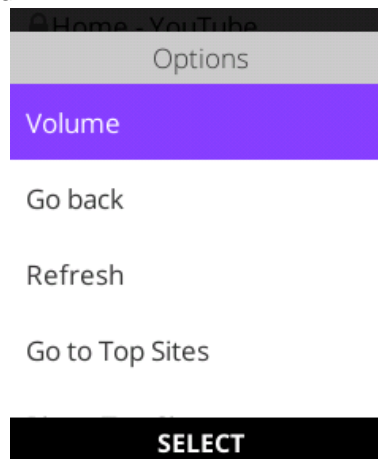

Connectivity





The following topics address your phone's connectivity options, including Wi-Fi and Bluetooth.

Wi-Fi

Wi-Fi provides wireless Internet access over distances of up to 300 feet. To use your phone's Wi-Fi, you need access to a wireless access point or "hotspot." The availability and range of the Wi-Fi signal depends on a number of factors, including infrastructure and other objects through which the signal passes.

Turn Wi-Fi On and Connect to a Wireless Network

Use the wireless and networks setting menu to enable your phone's Wi-Fi and connect to an available Wi-Fi network.

1. From the app list, select **Settings**  > **Network & Connectivity** > **Wi-Fi**. The Wi-Fi settings menu appears.
2. Select the **On** icon to turn Wi-Fi on . Wi-Fi is enabled. You will see the names and security settings of in-range Wi-Fi networks. To disable Wi-Fi, select the **Off** icon .
3. Choose **Available Networks**, select a Wi-Fi network to connect, enter the password (if it's not an open network), and then press the **Right soft key**  to connect.

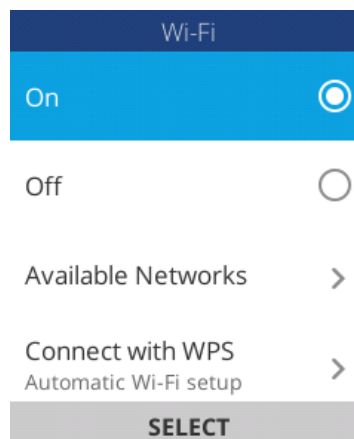

Your phone is connected to the Wi-Fi network. You will see () in the status bar. The password, for a household wireless LAN router, is sometimes found on a sticker on the router (WEP, WPA, KEY, etc.). Contact the router manufacturer for information. For password for a public wireless LAN, check with user's service provider.



Entering a password is not required if an access point is not security protected.

Note: The next time your phone connects to a previously accessed secured wireless network, you will not be prompted to enter the password again, unless you reset your phone to its factory default settings or you instruct the phone to forget the network.

Note: Wi-Fi networks are self-discoverable, which means no additional steps are required for your phone to connect to a Wi-Fi network. It may be necessary to provide a user name and password for certain closed wireless networks.

Wi-Fi Settings

Use the Wi-Fi settings menu to manually set your Wi-Fi connection options.

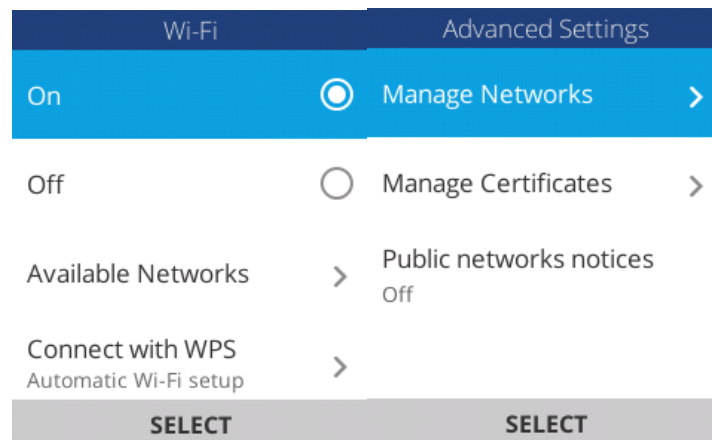

1. From the app list, select **Settings**  > **Network & Connectivity** > **Wi-Fi**. The Wi-Fi settings menu appears.
2. Select the **On** icon to turn Wi-Fi on . Wi-Fi is enabled. You will see the names and security settings of in-range Wi-Fi networks. To disable Wi-Fi, select the **Off** icon .
3. Select **Advanced Settings**.



The advanced Wi-Fi settings menu appears.

Disconnect Wi-Fi

You may wish to disconnect from a connected Wi-Fi network without turning Wi-Fi off.

1. From the app list, select **Settings**  > **Network & Connectivity** > **Wi-Fi**. The Wi-Fi settings menu appears.
2. Select **Available Networks** and choose the name of the connected access point and then press the **Right soft key**  to forget. Wi-Fi is disconnected.

Note: After disconnecting from an access point, you may need to re-enter the password to reconnect.

Bluetooth

Bluetooth® is a short-range communications technology that allows you to connect wirelessly to a number of Bluetooth devices, such as headsets and hands-free car kits, Bluetooth-enabled handhelds, computers, printers, and wireless phones. The Bluetooth communication range is usually approximately 30 feet and can vary by device.

Bluetooth Hints

Problem: Can't use Bluetooth?

Answer: Is your phone in airplane mode? Bluetooth is unavailable in airplane mode.

Bluetooth Function Cautions: Information may not appear correctly on connected devices depending on the transferred data.

Bluetooth Information

Bluetooth is a technology that enables wireless connection with PCs and Bluetooth devices with hands-free features, etc.

Enable the Bluetooth Feature

- Use the settings menu to enable or disable your phone's Bluetooth capabilities.
- Wireless connection to all Bluetooth functions is not guaranteed for the phone.
- The phone may not connect properly depending on the other device.
- Noise may be experienced with wireless calls and hands-free calls depending on the conditions.

To enable Bluetooth:

1. From the app list, select **Settings**  **> Network & Connectivity > Bluetooth**.

Function	Description
Audio output	Listen to music, etc., wirelessly.
Hands-free calls	Call hands-free, using Bluetooth-capable hands-free devices and headsets.
Data exchange	Exchange data with Bluetooth devices.

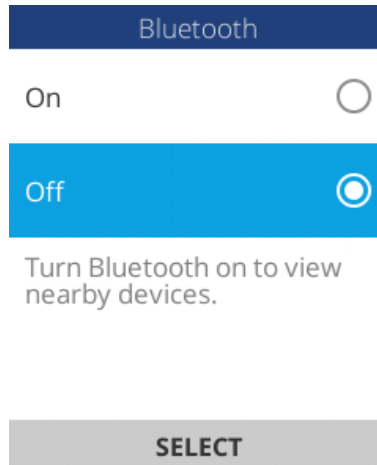

The Bluetooth settings open.

2. Select the **On** icon to turn Bluetooth on . Bluetooth is enabled. To disable Bluetooth, select the **Off** icon .

Note: Turn off Bluetooth when not in use to conserve battery power, or in places where using a wireless phone is prohibited, such as aboard an aircraft and in hospitals.

Pair Bluetooth Devices

Search for and pair nearby Bluetooth devices. Registered Bluetooth® devices can be connected simply.

Enable the Bluetooth function on the Bluetooth devices being paired beforehand. To pair Bluetooth devices:

1. From the app list, select **Settings**  > **Network & Connectivity** > **Bluetooth**.

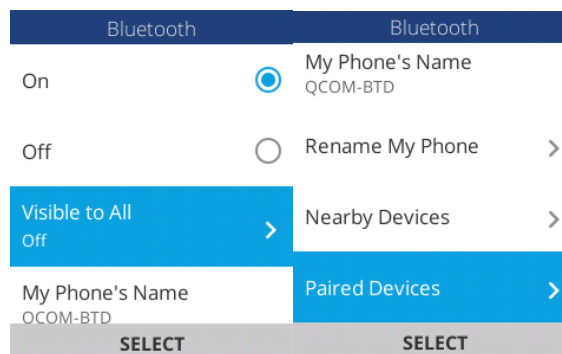

The Bluetooth settings open.

Nearby devices appear in the “Devices in the Area” list.

If a target device is not detected, press the **Right softkey**  to rescan.

2. Select a device from the “Devices in the Area” list, and follow the on-screen instructions to pair with the device. The Bluetooth device is paired to your phone.

Methods to accept a Bluetooth connection differ depending on the devices used.

Paired Device

1. From the Bluetooth settings menu, select **Paired Devices** to connected.
2. Press the **Right softkey**  to forget. The device is unpaired from your phone. To make another connection with the device, you will need to pair again.

Connect to a Paired Bluetooth Device

You can listen to music over a Bluetooth stereo headset, or have hands-free conversations using a compatible Bluetooth headset or car kit. It’s the same procedure to set up stereo audio and hands-free devices.

1. From the app list, select **Settings**  > **Network & Connectivity** > **Bluetooth**.

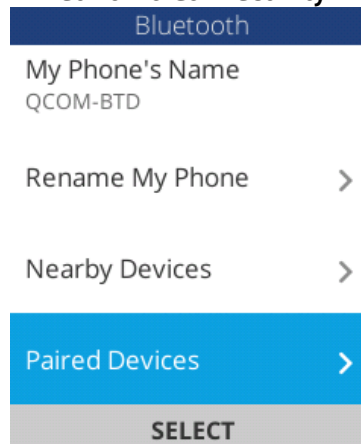

The Bluetooth settings open.

Paired Bluetooth devices appear in the “Paired Devices” list.

2. Select a device from the “Paired Devices” list. Your phone connects to the paired device.

The pairing and connection status is displayed below the device’s name in the Paired devices section. When the device is connected to your phone, the Bluetooth paired icon is displayed in the status bar. Depending on the type of device you have connected, you can then start using the headset or car kit to listen to music or make and receive phone calls. Please make sure to follow any federal, state or local laws when using devices (including Bluetooth-enabled devices) while driving.

Note: Due to different specifications and features of other Bluetooth-compatible devices, display and operations may be different, and functions such as transfer or exchange may not be possible with all Bluetooth-compatible devices.

Send Information Using Bluetooth

You can use Bluetooth to transfer information between your phone and another Bluetooth-enabled device such as a phone or notebook computer.



Types of Data You Can Send via Bluetooth

You can send the following types of information, depending on the device you are sending to:

- Images and videos
- Contacts
- Audio files

In the instructions below, Contacts data is being used as an example.



Sending Contacts Data via Bluetooth

1. From the app list, select **Contacts** . You will see the Contacts list.
2. Select a contact to send.
3. Press the **Right softkey**  > **Share** > **Bluetooth**.
4. Select a paired device to receive the data. The contact information is sent.

If you see a message to confirm, follow the onscreen instructions.

Receive Information via Bluetooth

Your phone is capable of receiving a wide variety of file types with Bluetooth, including pictures, music tracks, and documents such as PDFs.

1. When another device attempts to send a file to your phone via Bluetooth, you will see a request to accept the file.
2. Press the **Left softkey**  on homescreen to review this notice and press the **Right softkey**  to accept the file. The file is sent to your phone.

When your phone receives a file, you will see a notification. When you open a received file, what happens next depends on the file type:

- Media files and documents are usually opened directly in a compatible application. For example, if you open a music track, it starts playing in the Music application.
- For a vCard contact file, if there are multiple vCard files on your storage card, you can choose to import one, several, or all of those contacts to your contacts list.

Apps and Entertainment



The topics in this section will explore the features that make your phone so much more than a phone, from the camera and productivity apps to music, entertainment, and more.

Camera and Video

You can use the camera or video camera to take and share pictures and videos. Your phone comes with a 1200 pixel camera that lets you capture sharp pictures and videos.

Camera Overview

The camera's viewfinder screen lets you view your subject and access camera controls and options.

- **Options:** Press the **Right soft key**  to open settings options.
- **Preview:** Press the **Left soft key**  to view picture you took.
- **Video record:** Select to start/pause video record.

Learn More About Your Phone's Camera

For an overview of your phone's camera and its features, you can access more information through the phone's settings menu.

From the app list, select **Camera** .



The camera viewfinder appears.

Take Pictures and Record Videos

The following topics teach you how to take pictures and record videos with your phone's camera.

Capturing Pictures/Videos

File Format for Pictures: The file format for pictures is JPEG. **File Format for Videos:** The file format for videos is 3GPP.



Camera Cautions

- **If Lens Becomes Dirty:** Fingerprints/smudges on the lens prevent capturing of clear still images/videos. Wipe lens with a soft cloth beforehand.
- **Avoid Exposure to Direct Sunlight:** Be careful not to expose the lens to direct sunlight for long periods. It may discolor the color filter and affect color of images.

Take a Picture

You can take high-resolution pictures using your phone's camera



Note: If you have an SD card installed, pictures and videos are stored to the SD card. If no card is installed, pictures and videos are saved to your phone's memory.

1. From the apps list, select **Camera** . The camera viewfinder appears.
2. Press  to take the picture. The shutter clicks and the picture is captured and saved to your phone or SD card.

Record Videos

You can record high-quality videos with your phone's video camera .

Note: If you have an SD card installed, pictures and videos are stored to the SD card. If no card is installed, pictures and videos are saved to your phone's memory.

1. From the apps list, select **Camera** . The camera viewfinder appears.
2. Aim the camera at your subject and then press **Navigation Right** key to switch to **Video** , and press  to start recording.

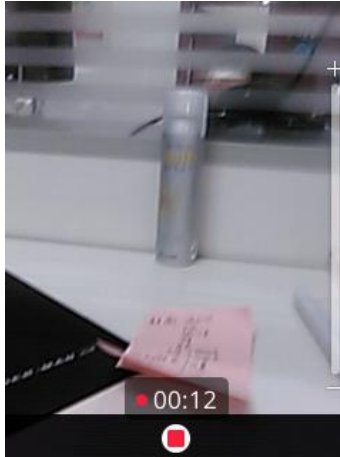

Video recording begins.

3. Press  again to stop recording. The camera stops recording and the video is captured and saved to your phone or SD card.

View Pictures and Videos Using Gallery

Using the Gallery application, you can view pictures that you've taken with your phone's camera, downloaded, or copied onto your storage card or phone memory.

For pictures that are on your storage card or phone memory, you can do basic editing such as rotating and cropping. You can also easily assign a picture as your contact picture or wallpaper and share pictures with your friends.

View Pictures and Videos

You can access and view all your stored pictures from your phone's Gallery.

1. From the apps list, select **Gallery** .

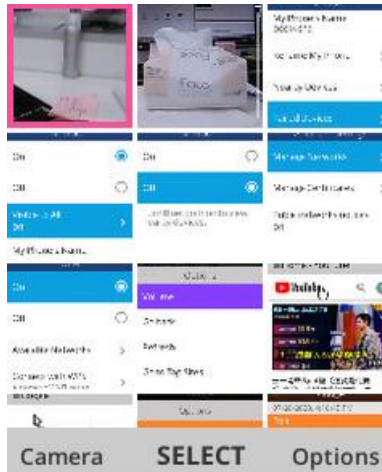

The list of pictures opens.

2. Select an image to view the picture. The picture opens.

Press the **Left softkey**  to zoom in or zoom out.

Press the **Right softkey**  to open options menu and choose what to do with the picture.

Pictures and Videos: Review Screen

After capturing a picture or video, from the camera screen, press the **Left soft key**  to see the item in the review screen. From there, you can access options such as view, share, set as wallpaper or delete the picture.

Edit Pictures

Whether you're browsing pictures in filmstrip or grid view in the Gallery application, you can choose a picture to open a selection menu and choose to delete the picture, rotate or crop it, and more.



Rotate a Picture



1. From the app list, select **Gallery**. The list of pictures opens.
2. Select the picture you want to rotate.
3. Press the **Right softkey**  and then select **Rotate**. The picture is rotated.

Edit a Picture

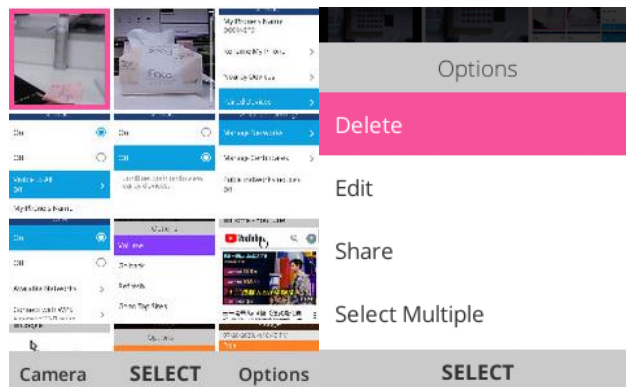
1. From the app list, select **Gallery** .





The list of pictures opens.

2. Select the picture you want to edit.
3. Press the **Right softkey**  and then select **Edit**. An edit screen appears on the picture.
 - Exposure
 - Rotate
 - Crop
 - Filters
 - Auto-correction
4. Press the **Right softkey**  to save the changes to the picture. The modified picture is saved in the album as a copy. The original picture remains unedited.

Share Pictures and Videos

The Gallery application lets you send pictures using email, Bluetooth or multimedia messages.

1. From the app list, select **Gallery** . The list of pictures opens.
2. Select the pictures you want to share. To select multiple items, press the **Right soft key**  **Select Multiple** to turn on multiple select. Select all the items you want to include.
3. Press the **Right soft key**  **Share** and then on the Share via menu, select **E-mail** or **Bluetooth**. Follow onscreen prompts to complete and send the message.

Note: If you selected **E-mail** and you have multiple email accounts, the default email account will be used.

For more information, see [Create and Send Email](#), [Send a Multimedia Message \(MMS\)](#), and [Bluetooth](#).

Camera Settings

You can adjust your camera's settings by pressing the **Right soft key**  on the camera screen.

Switch between Camera and Video Mode



You can switch between camera and video mode freely.

1. From the app list, select **Camera** . The camera viewfinder appears.
2. Press **Navigation Right key** to switch to **Video**. The video screen opens.



Set Camera Functions

You can configure your camera's settings to fit any situation and event.

1. From the app list, select **Camera** . The camera viewfinder appears.
2. Press the **Right soft key**  to open options menu. The camera settings menu opens.
3. Select your desired settings. The settings are applied.

Settable items differ depending on the camera type in use.

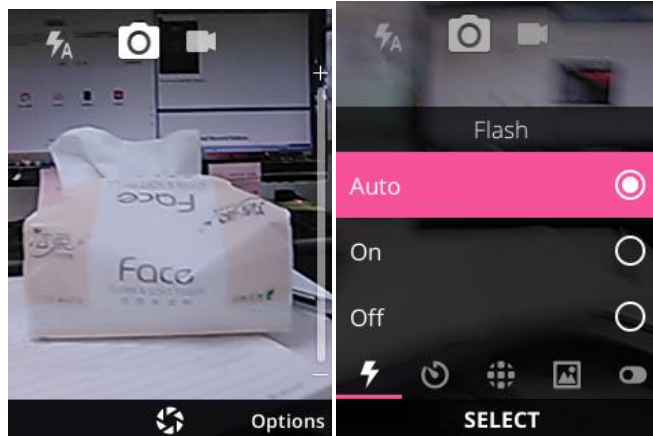



Productivity

Use your phone to stay ahead of the game with calendar, alarm, calculator and more productivity apps.

Calendar

Use Calendar to create and manage events, meetings, and appointments. Your Calendar helps organize your time and reminds you of important events. Depending on your synchronization settings, your phone's Calendar stays in sync with your Calendar on the Web, Exchange ActiveSync calendar, and Outlook calendar.

Calendar Operations

- **View Today's Calendar:** From the Calendar, press the **Right soft key**  > Today.
- **Change Calendar View:** From the Calendar, press the **Right soft key**  and choose **Weekly View** or **Day View** to change the current view.
- **View Particular Day/Month/Year:** From the Calendar, press the **Right soft key**  > Go and press **Navigation** key to choose particular day, month or year.

Add an Event to the Calendar

Add events to your calendar directly from the Calendar application.

1. From the app list, select **Calendar**. The Calendar app opens.
2. Press the **Left softkey** to add new event.

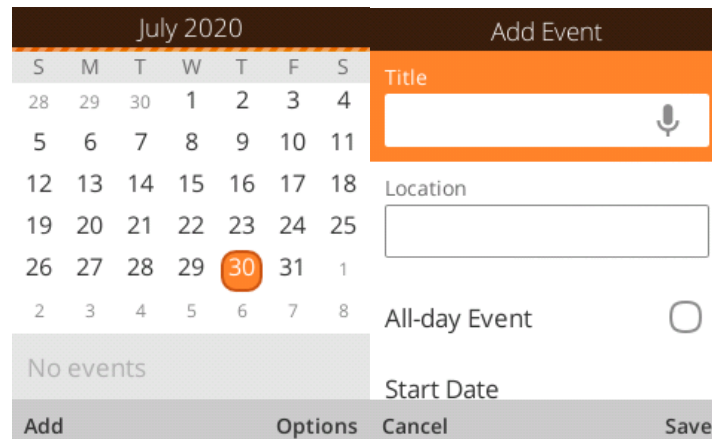

The add event window opens.

3. Enter an event title, start date/time, end date/time, etc., and then press the **Right softkey** to save the event is added to your calendar.

View Calendar Events

You can display the Calendar in daily, weekly or monthly view.

1. From the app list, select **Calendar** . The Calendar app opens.
2. Select a date and then press to display events.

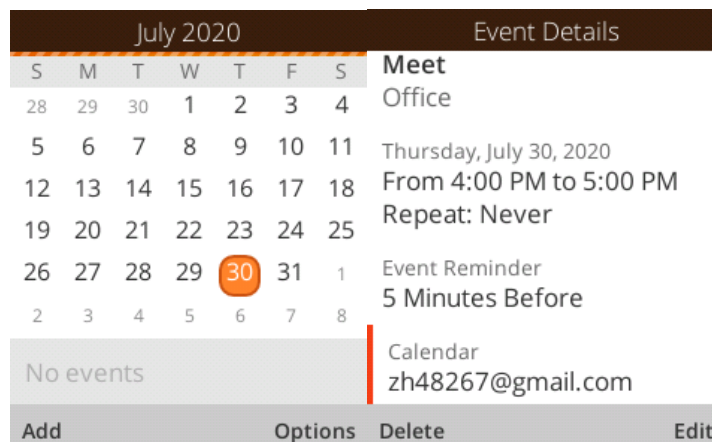

The event details appear.

- In event details, press the **Right softkey** to edit the event. In event details, press the **Left softkey** to delete the event.

Sync Calendars

You can select which calendars you'd like to sync on your phone, along with what types of information you want to sync.

1. From the app list, select **Calendar** . The Calendar app opens.
2. Press the **Right softkey**  **Synccalendar**.

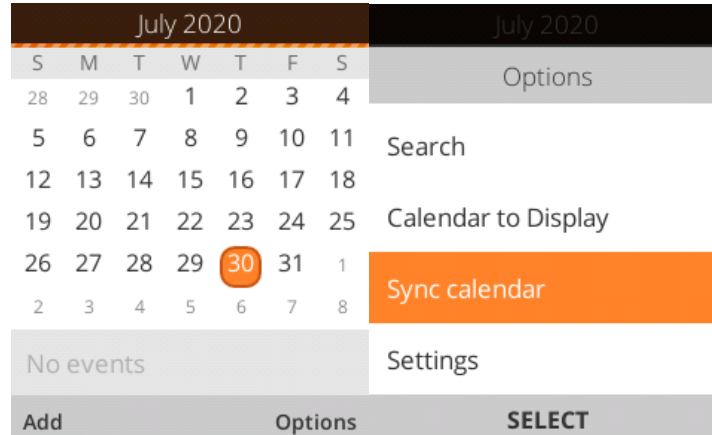

The sync settings have been updated.

Calculator

Your phone's convenient built-in calculator lets you perform basic mathematical equations.

1. From the app list, select **Calculator** . The calculator app launches.
2. Press keys for calculations. Calculation results appear.

0

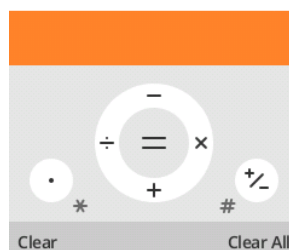

Clock



Your phone has a clock app that lets you set alarms, use a stopwatch, and set a timer.

Check the Time

You can check the clock any time on your phone. The current time displays in the center of the home screen.

Set Alarms

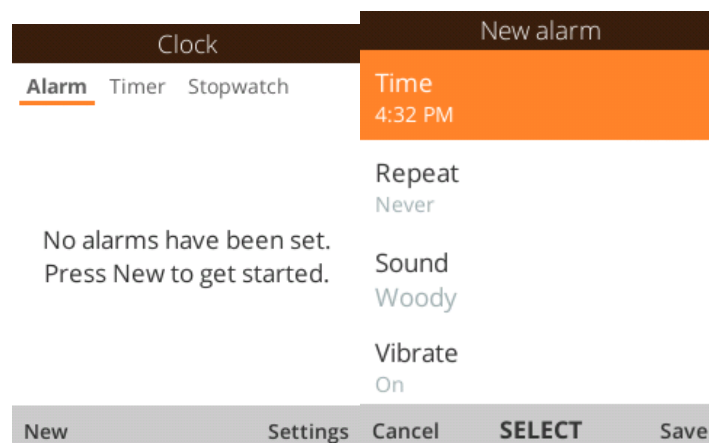

Set multiple alarms using your phone's Clock app.

1. From the app list, select **Clock** . The Clock app appears.
2. Press the **Left soft key**  to create a new alarm. The alarm adding screen appears.
3. Set the alarm options, including time, repeat pattern, alarm tone, and volume, and then press the **Right soft key** to confirm. The alarm is set.



Phone at Alarm Time

At the set alarm time, the phone sounds the alarm and/or vibrates.

Stopping an alarm: When the alarm sounds, press the **Left soft key**  to snooze it or the **Right soft key**  to stop.



Additional Clock Features

Your phone's clock app provides additional useful features including stopwatch and timer functions. These features are available from the clock app display.

From the app list, select **Clock** . The Clock app appears.

Timer



The stopwatch lets you time events down to the hundredth of a second.

1. From the clock app, press the **Navigation** key to enter **Timer** screen.
2. Set the time and press  to begin timing.
3. Press  to stop timing.

Stopwatch

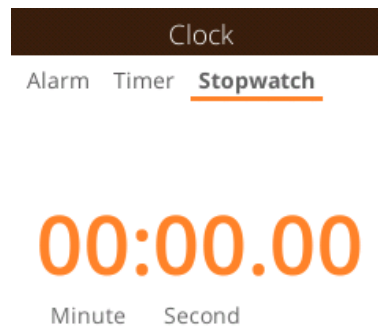
The timer provides a countdown timer for up to 99 hours, 59 minutes, and 59 seconds.



1. From the clock app, press the **Navigation** key to enter **Stopwatch** screen.
2. Press  to begin timing.
3. Press the **Right softkey**  to record lap.
4. Press  to stop or resume timing.

Additional options include **Lap** to keep track of laps, **Restart** to continue timing, and **Reset** to reset the stopwatch to zero.

Entertainment and Activities

The following topics provide an overview of your phone's music.

Play Music

Use the Music app to listen to all your music on your phone. Compatible music file formats include: mp3, wma, wav, mod, etc.

1. From the apps list, select **Music** . The Music app opens.
2. Use the **Navigation** key to select a library category such as Artist or Albums.
3. Choose an item from the category window and then Select a song. The song begins playing.

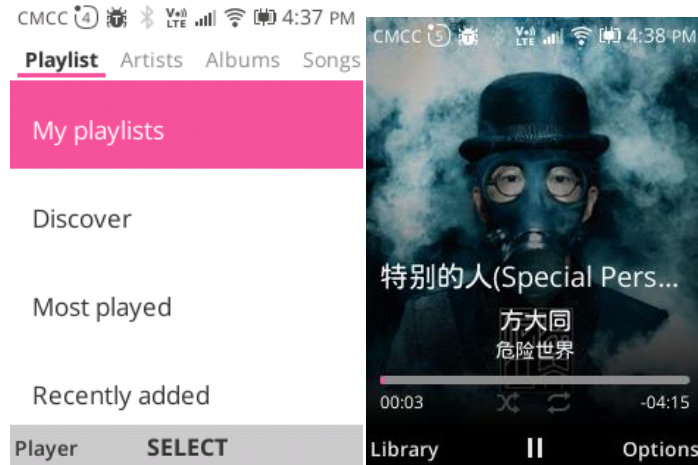

Music Screen Layout English screen shot

The following picture outlines the main features of the Music app player screen.

Feature	Description
Shuffle All	Select to shuffle all songs.
Repeat All	Select to repeat all songs
Share	Select to share a song via E-Mail, Messages or Bluetooth.
Set as ringtone	Select to set as ringtone of the phone.



Settings

The topics in this section will cover your phone's settings menus and options. For an overview of the settings menu, see [Basic Settings](#).

Connections Settings

The following topics introduce your phone's basic settings menus and cover your phone's Connections settings options.

Basic Settings

From the app screen, select **Settings**  to access your phone's settings menu. The table below outlines the top-level settings categories.

Category	Description
Airplane Mode	Enable and set airplane mode options.
Mobile network& Data	Set your phone's Mobile network settings.
Geolocation	Select your phone's location access options.
Wi-Fi	Enable and set Wi-Fi options.
Bluetooth	Enable Bluetooth connections.
Calling	Set caller ID, call forwarding options, etc.
Messaging Settings	Set messaging ringer, messaging vibrate, etc.
Internet Sharing	Enable Wi-Fi hotspot options.
Wireless Emergency Alerts	Set Emergency alert options.
Sound	Set ringtone, operation tones, etc.
Display	Set wallpaper, brightness, etc.
Search	Set search engine and enable search suggestions.
Notices	Enable notices on lock screen options.
Date & Time	Set date and time of the phone.
Language	Set your phone's language.
Input Methods	Select and configure speech input settings.
Answer Mode	Select device answer mode.
SOS Message	Edit the SOS Message by yourself and it can be sent when you dial 911.
Screen Lock	Set your phone's lock screen options.
SIM Security	Set your SIM Card security.
App Permissions	Check and manage the apps in your phone.
Do Not Track	Set Do Not Track mode options.
Browsing Privacy	Set browsing privacy options.
USB Storage	Enable USB storage.
About KaiOS	An introduction to KaiOS

Category	Description
End user storage	Check application storage status.
Device Information	Access important phone information and view legal and safety information.
Downloads	Check downloads on your phone.
Battery	Monitor your phone's battery usage.
Accessibility	Set accessibility options such as invert colors, hearing aid compatibility, and more.
Developer	Set developer options.
System Updates	Check and update your phone with the latest version.
KaiOS Account	Set your KaiOS account.
Anti-Theft	Set your device anti-theft information. For more information, visit https://services.kaiostech.com/antitheft
Operator Services	Check your operator services.

Access Settings

1. From the app list, select **Settings** . The settings menu opens.
2. Select categories and then select your settings options. Settings are made and applied.

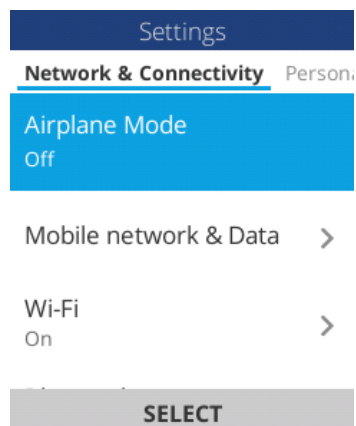

Wi-Fi Settings Menu

The Wi-Fi settings menu lets you turn Wi-Fi on or off, set up and connect to available Wi-Fi networks, and configure advanced Wi-Fi options.



For more information about Wi-Fi settings, see [Wi-Fi](#).

1. From the app list, select **Settings** > **Network & Connectivity** > **Wi-Fi**. The Wi-Fi settings menu appears.

2. Select the **On** icon  to turn Wi-Fi on. Wi-Fi is enabled. You will see the names and security settings of in-range Wi-Fi networks. To disable Wi-Fi, select the **Off** icon .
3. Select a Wi-Fi network, enter the password, and press the **Right softkey**  to connect. Your phone is connected to the selected Wi-Fi network.
4. Configure your Wi-Fi settings.

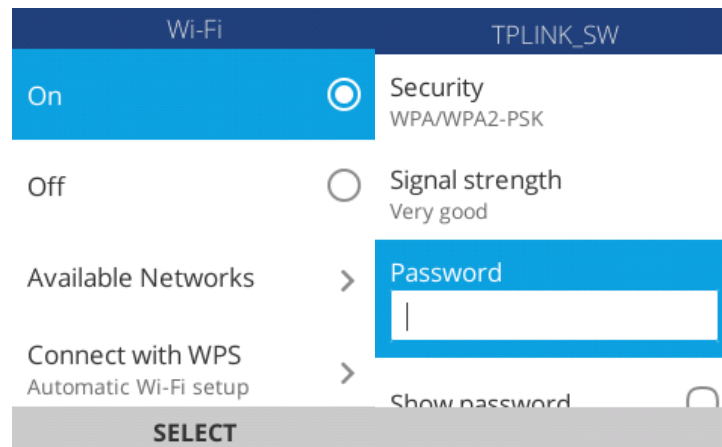

Your Wi-Fi settings changes are saved.

The password, for a household wireless LAN router, is sometimes found on a sticker on the router (WEP, WPA, KEY, etc.). Contact the router manufacturer for information. For password for a public wireless LAN, check with user's service provider.

Entering a password is not required if an access point is not security protected.

Bluetooth Settings

Your phone's Bluetooth[®] capabilities let you use wireless headsets, send and receive pictures and files, and more. For details on your phone's Bluetooth usage, see [Bluetooth](#).

- From the apps list, select **Settings**  > **Network & Connectivity** > **Bluetooth**.

The Bluetooth settings open.

Bluetooth Settings Operations

- **Enable Bluetooth:** Select the **On** icon  to turn Bluetooth on.
- When enabled, confirmation appears on your phone to be discoverable by other devices. Follow the onscreen instructions.

To disable Bluetooth, select the **Off** icon .

- **Visible to All:** Select **On** or **Off** icon to enable this function.

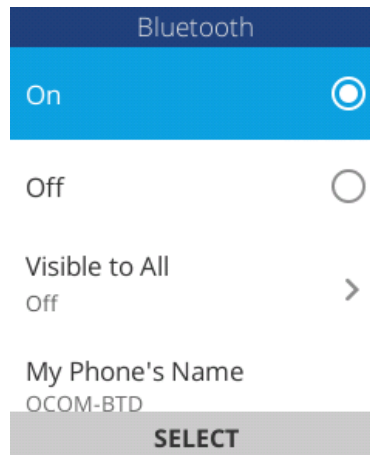

When enabled, your phone can be discovered by other devices. This setting is available when Bluetooth is enabled.

- **My Phone's Name:** Check your phone's current name.
- **Rename My Phone:** You can set the phone's name as it appears to other device.
Notice: Emojis cannot be used in a device name.
This setting is available when Bluetooth is enabled.
- **Nearby Devices:** Check available devices for connecting.

If the target device does not appear, press the **Right softkey**  to search again.

This setting is available when Bluetooth is enabled.

- **Paired Devices:** Make sure the other devices are set to be discovered. From Bluetooth settings, select the device name in "Devices in the Area" and follow the onscreen instructions.

Depending on the device, you may be required to enter or accept a passkey.

If the target device does not appear, press the **Right softkey**  to search again.
This setting is available when Bluetooth is enabled.

Cellular & Data

The mobile network & data menu lets you view your SIM card's carrier, enable data connection, enable VoLTE, and more.

From the apps list, select **Settings >Network & Connectivity >Mobile network& Data**. The Cellular & Data window opens.

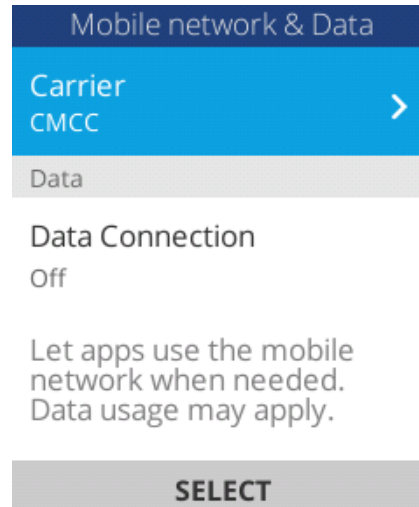

Mobile network& Data Operations

Carrier: Check your SIM card's carrier.

Data Connection: Select the **On** icon  to enable data connection. To disable data connection, select the **Off** icon .

APN Settings: Set APN settings options.

Personalization Settings

The following topics outline the device settings options available on your phone, including sounds, display, notices, and more.

Sound Settings

The sound settings menu lets you control your phone's audio, from ringtones and alerts to tap tones and notifications.

Sound Settings Overview

The sound settings menu allows you to configure the following options:

Sound Setting	Description
Volume	Set volume for ringtones, alarms, and media.
Tones	Set your phone's default ringtone, alerts tone and manage tones options.
Other Sounds	Set sounds for dial pad, camera and sending message.

Access Sound Settings

1. From the app list, select **Settings**  > **Personalization** > **Sound**. The sound window opens.
2. Set your sound options. Your sound settings are saved and applied.

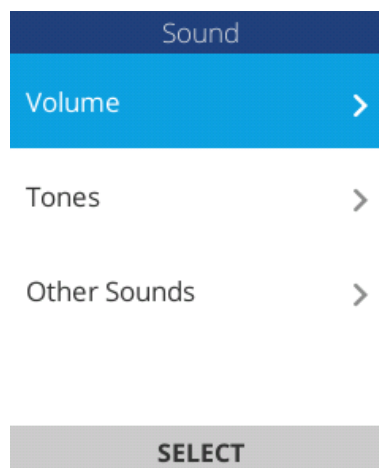

Display Settings

Use the phone's display settings menu to adjust items such as wallpaper, brightness, and screen timeout.

Display Settings Overview

The display settings menu allows you to configure the following options:

Display Setting	Description
Wallpaper	Set a wallpaper.
Brightness	Set the display brightness.
Screen Timeout	Set screen timeout duration. Note: Longer durations discharge the battery more quickly.

Access Display Settings

1. From the app list, select **Settings**  > **Personalization** > **Display**. The display window opens.
2. Set your display options. Your display settings are saved and applied.

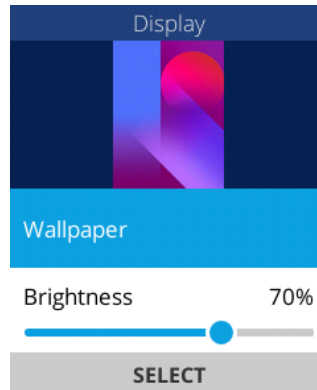

Search Settings

The search settings menu lets you manage search engine and enable search suggestions.

Search Settings Overview

The search settings menu allows you to configure the following options:

Search Setting	Description
Search Engine	Set your phone's search engine.
Search Suggestions	Set to enable search suggestions.

Access Search Settings

1. From the app list, select **Settings**  > **Personalization** > **Search**.

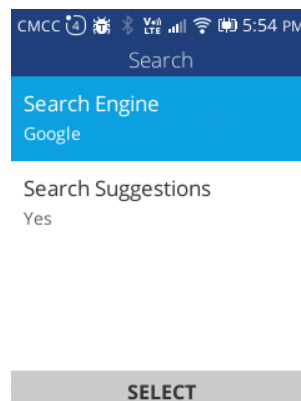

The search window opens.

2. Set your search options. Your search settings are saved and applied.

Notices Settings

The notices settings menu lets you enable notices show on lock screen or after reboot.

Notices Settings Overview

The notices settings menu allows you to configure the following options:

Access Notices Settings

1. From the app list, select **Settings**  > **Personalization** > **Notices**.

Notices Setting	Description
Show on lock screen	Set to enable notices shown on lock screen.
App Notices	Set the notifications that display for individual apps

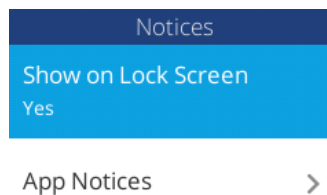

2. Set your notices options. Your notices settings are saved and applied.

Date & Time Settings

Use the date and time settings menu to set date and time manually, as well as select time format options.

Date & Time Overview

The following date and time options may be configured:

Date & Time Option	Description
Date	Set the date manually.
Time	Set the time manually.
Region	Set the time region.
Time Zone	Set the time zone.
Time format	Select 12-hour or 24-hour format.

Access Date & Time Options

1. From the app list, select **Settings**  > **Personalization** > **Date & Time**.

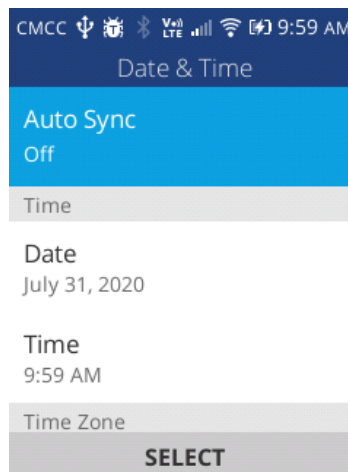

The date & time window opens.

2. Set available date and time options. Your date and time settings are applied and saved.

Language Settings

Your phone's language settings let you select a language for the phone's menus and keyboards.

Language Settings Overview

You can set the following options in the Language settings menu:

Language Setting	Description
Language	Set the language for your display and menus.
Sample Format	Check language sample format.

Access Language Setting Options

1. From the app list, select **Settings** > **Personalization** > **Language**.

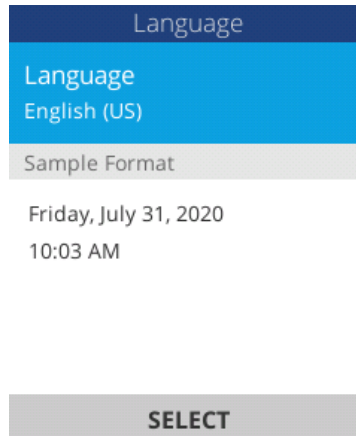

The Language settings menu opens.

2. Setoptions. The language settings are applied and saved.

Input Methods Settings

Your phone's input settings let you select and configure keyboard settings, and set your phone's input languages.

Input Methods Settings Overview

You can set the following options in input methods settings menu:

Input Methods Setting	Description
Use Predictive	Set T9 input methods.
Next Word Suggestion	Automatic prediction gives hints
Input languages	Set the input language.

Access Input Languages Setting Options

1. From the appslis,select**Settings**  **Personalization**>**InputMethods**.

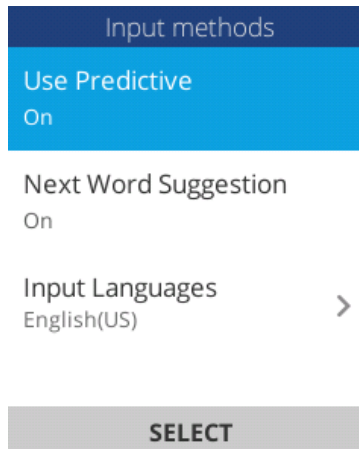

The input settings menu opens.

2. Setoptions. The input settings are applied and saved.

Privacy & Security Settings



The following topics cover your phone's privacy & security settings, including screen lock settings, app permissions, Do Not Track, and browsing privacy.

Screen Lock Settings

You can increase the security of your phone by creating a screen lock. When enabled, you have to enter the correct password to unlock the phone's control buttons and screen.

Important: To protect your phone and data from unauthorized access, it is recommended that you use the Password protection. It is also recommended you frequently change your password to ensure the safety of your phone and personal data.

Access Screen Lock Options

1. Fromtheappslist,select**Settings**  > **Privacy&Security** > **ScreenLock**. The screen lock settings menu opens.
2. Selectthe**On** icon  toenabledataconnection.Todisabledataconnection,selectthe**Off** icon.
3. Enterandre-enteryourpasscode,andpressthe**Rightsoftkey**  tosavethesetting. The screen lock are applied and saved.

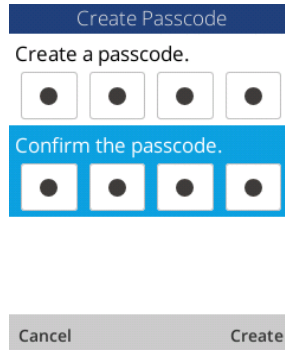

App Permission Settings

Set installed applications' permissions.

App Permissions Settings Overview

Items that can be checked in the App permissions settings menu are the following.

App Permissions Setting	Description
Camera	Set the camera's geolocation permission.
System	Set the system's geolocation permission.

Access App Permissions Settings

1. From the app list, select **Settings > Privacy & Security > App Permissions**.
2. Set options. The app permissions settings are applied and saved.

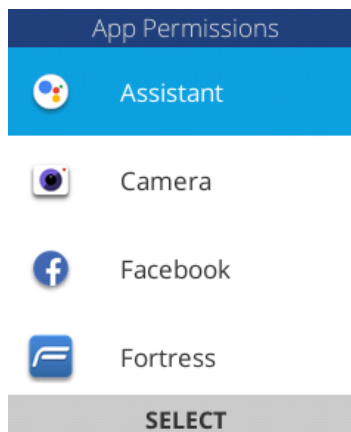

Do Not Track Settings

Set your preference for Do Not Track.

Access Do Not Track Settings

1. From the app list, select **Settings**  > **Privacy & Security** > **Do Not Track**.
2. Select options. The do not track settings are applied and saved.

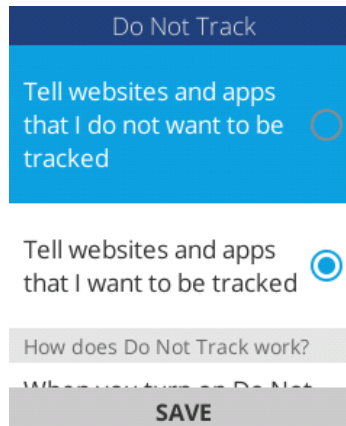

Browsing Privacy Settings

Set your browsing privacy settings.

Access Browsing Privacy Settings

1. From the app list, select **Settings** > **Privacy & Security** > **Browsing Privacy**.
2. Select options. The browsing privacy settings are applied and saved.

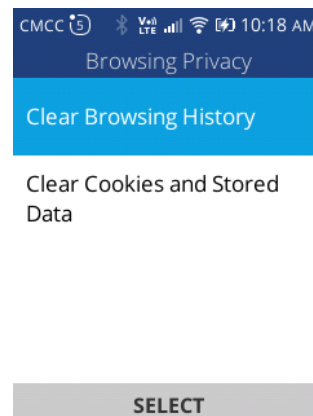



Storage Settings

The storage settings menu lets you manage internal storage on your phone and provides menu choices for an optional SD card (not included).

USB Storage Settings

The following topics address your phone's connectivity options, including USB file transfer, Wi-Fi, Bluetooth, and more.

1. From the apps list, select **Settings**  > **Storage** > **USB Storage**. The USB storage settings menu opens.
2. Select the **Enable** icon  to enable USB storage. To disable, select the **Disable** icon .

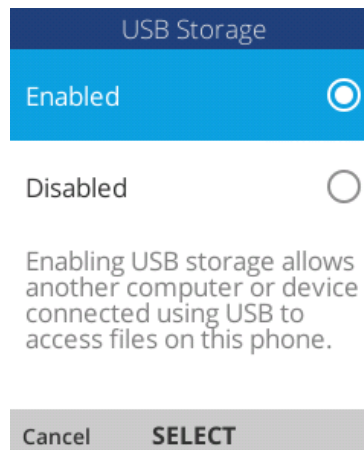

Media Storage Settings

View the total space/free space of media files in your phone memory and in an optional installed SD card.

- From the apps list, select **Settings**  > **Storage** > **Media Storage**.

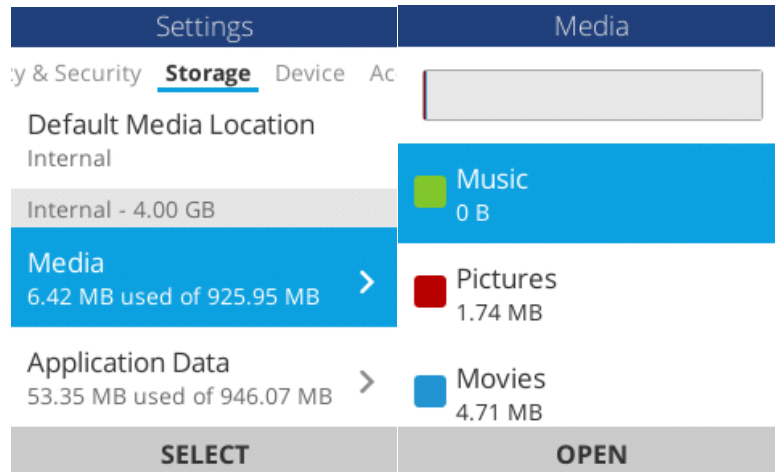

External Media:

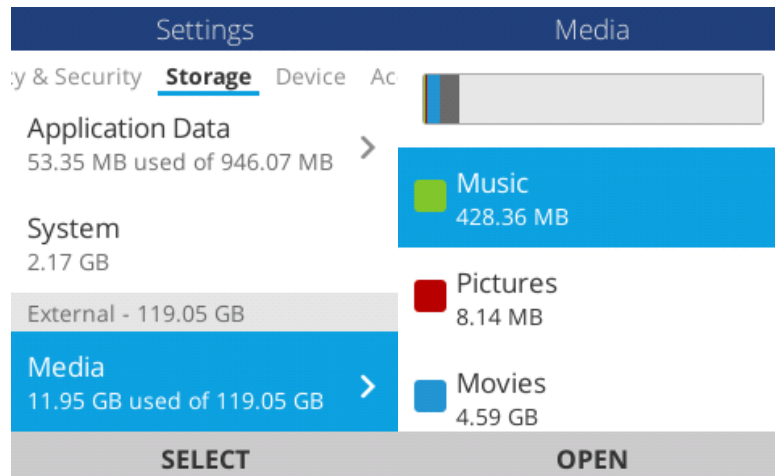

The media storage window opens.

Device Settings

The following topics including device information, downloads, battery, accessibility, etc.

Device Information Settings

The device information menu lets you access important phone information, and view legal and safety information.

Device Information Overview

The following device information items may be reviewed or set:

Device Information Item	Description
Phone Number	Check your phone number.
Model	Check the phone's model.
Software	Check the phone's software version.
Software update	Check for software updates
More Information	Check more information about your phone: OS Version,HardwareRevision, MAC Address,IMEI, Build Number,ICCID,IP Address,PlatformVersion, Build Address,BluetoothAddress
Legal information	Check Health & Safety information, open source notices, etc.
Reset Phone	Reset all settings and delete all data on phone.

Tip: Before performing a factory data reset on your phone, you may want to unmount an installed SD memory card to avoid losing any data you may have stored on it.

Access Device Information Options

1. From the apps list, select **Settings**  > **Device** > **Device Information**. The device information window opens.
2. Select or view available options. Your phone information is displayed.

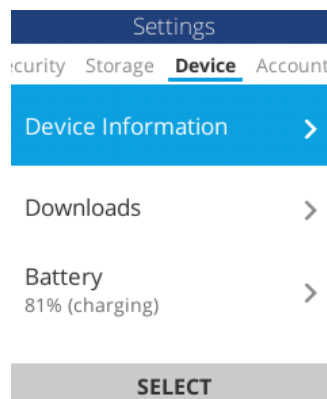

Downloads Settings

You can check your downloaded files in Downloads.

Access Device Information Options

- From the apps list, select **Settings**  > **Device** > **Downloads**. The downloads window opens.



No downloads

Battery Settings

Monitor your phone's battery usage through this settings menu. Check the battery consumption and percentage.

1. From the app list, select **Settings**  > **Device** > **Battery**. The Battery window opens.
2. Select items to view details. Check your battery condition and access additional options.

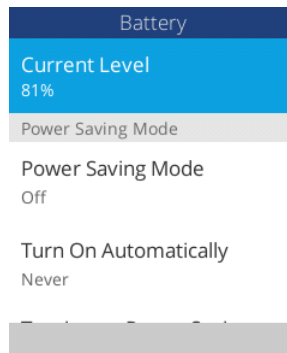

Accessibility Settings

The accessibility menu lets you enable and manage accessibility-related applications.

Accessibility Settings Overview

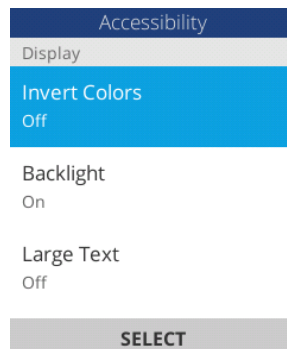

The following accessibility options may be configured:

Accessibility Option	Description
Invert Colors	Set color inversion (may affect performance).
Backlight	Set to enable backlight.
Large text	Set to enlarge the screen text.
Captions	Set to enable captions settings.
Readout	Set to enable readout mode.
Mono Audio	Set to enable mono audio.
Volume Balance	Set volume balance.
Keypad Vibration	Set to enable keypad vibration.
TTY	Select to enable TTY mode.
Hearing Aid Compatibility (HAC) *	Set to enable hearing aid compatibility.

* After the Hac mode is turned on, the phone automatically corrects the audio file, and the call sound will be louder and clearer

Access Accessibility Options

1. From the app list, select **Settings**  > **Device** > **Accessibility**. The accessibility settings menu opens.
2. Set available accessibility options. Your accessibility settings are applied and saved.

Developer

1. From the app list, select  **Settings** > **Device** > **Developer**. For Developer use only.

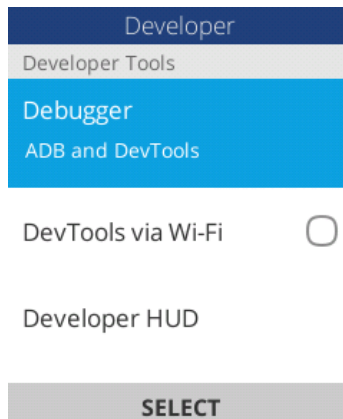

Getting Help

The topics in this section will cover troubleshooting tips, phone specifications, and how to manage your wireless service.

For Assistance

The following topics address areas of support for your phone, including troubleshooting, specifications, and account information.

Troubleshooting

Check the questions and answers below for troubleshooting solutions for common phone issues.

Check Here First

Problem: Phone freezes/operation is unstable

Answer: Turn the phone on again. If you are unable to turn the phone off, remove and replace the Battery, and then turn the phone on again. Data that was being edited is erased after your phone is powered on again.

Problem: Cannot use phone, mail, or Internet.

Answer 1: Check whether you are where signal is weak or out of service area.

Answer 2: Power the phone on again.

Answer 3: Is the phone in Airplane mode? To check that Airplane mode is canceled:

- From the app list, select **Settings**  > **Network & Connectivity** > **Airplane Mode**.

Answer 4: Is data communication disabled? To check that data communication is enabled:

- From the app list, select **Settings**  > **Network & Connectivity** > **Mobile network & Data** > **Data Connection**.

Problem: Battery level goes down quickly.

Answer: Are you where signal is weak or have been out of service area for a long period? Calling where signal is weak or being out of service area uses a lot of Battery.

Problem: Cannot unlock screen.

Answer: Power the phone on again. If you are unable to turn the phone off, remove and replace the Battery, and then power the phone on again. Data that was being edited is erased after the phone is powered on again.

Specifications

The following tables list your phone's specifications.

ITEM SPECIFICATIONS	
Operating System	KaiOS V2.5.4

Processor	Qualcomm MSM8909 Dual cores
Memory	512MB RAM 4GB ROM (Expandable via microSD card to 32GB)
Cellular Network	<p>RAW SKU Bands:</p> <ul style="list-style-type: none"> • LTE Bands: 2,4,5,7,12,13,25,26,41,66,71 • 3G Bands: 2,4,5 • GSM Bands: 850,900,1800,1900 • CDMA Bands: BCo,BC1,BC10 • LTE Cat 4 (DL 150 Mbps / UL 50 Mbps) • HSPA Cat 24 (DL 42 Mbps / UL 11 Mbps) • GSM/GPRS/EDGE • VoLTE,
Display	External:1.54' TFT, 240*240, Main LCD:2.8' TFT, 240*320, QVGA
Camera	2M camera only
Connectivity	Audio jack: 3.5mm; Bluetooth: 4.1 WIFI: 802.11b/g/n (2.4G) USB: micro-USB 2.0 SIM type: Nano SIM Expandable memory: microSD GPS: GLONASS, GPS, aGPS
Battery	Li-ion battery 1600mAh
Dimensions	111x55.6x19.1 mm
Weight	135g

© 2020 Asiatelco Technologies, Inc. All right reserved.

For additional information, visit support@atel-usa.com or visit www.atel-usa.com.

Safety and Precautions

This product meets applicable national SAR limits of 1.6 W/kg. The specific maximum SAR values can be found in the Radio waves section.

When carrying the product or using it while worn on your body, either use an approved accessory such as a holster or otherwise maintain a distance of 15 mm from the body to ensure compliance with RF exposure requirements. Note that the product may be transmitting even if you are not making a phone call.

Radio waves

THIS PHONE MEETS THE GOVERNMENT'S REQUIREMENTS FOR EXPOSURE TO RADIO WAVES. Your phone is a radio transmitter and receiver. It is designed and manufactured not to exceed the emission limits for exposure to radio-frequency (RF) energy. These limits are part of comprehensive guidelines and establish permitted levels of RF energy for the general population. The guidelines are based on standards that were developed by independent scientific organizations through periodic and thorough evaluation of scientific studies. These guidelines include a substantial safety margin designed to ensure the safety of all persons, regardless of age and health.

The exposure standard for phones employs a unit of measurement known as the Specific Absorption Rate, or SAR. The SAR limit set by public authorities such as the Federal Communications Commission of the US Government (FCC), or by Innovation, Science and Economic Development Canada (ISED), is 1.6 W/kg averaged over 1 gram of body tissue. Tests for SAR are conducted using standard operating positions with the phone transmitting at its highest certified power level in all tested frequency bands.

This device is complied with SAR for general population /uncontrolled exposure limits in ANSI/IEEE C95.1-1992 and had been tested in accordance with the measurement methods and procedures specified in IEEE1528.

The FCC has granted an Equipment Authorization for this model phone with all reported SAR levels evaluated as in compliance with the FCC RF exposure guidelines. SAR information on this model phone is on file with the FCC and can be found under the Display Grant section of www.fcc.gov/oet/ea/fccid after searching on FCC ID : 2AXKS-FR150

Although the SAR is determined at the highest certified power level, the actual SAR level of the phone while operating can be well below the maximum value. This is because the phone is designed to operate at multiple power levels so as to use only the power required to reach the network. In general, the closer you are to a wireless base station antenna, the lower the power output of the phone. Before a phone model is available for sale to the public, compliance with national regulations and standards must be shown.

The highest SAR value for this model phone when tested is 0.86W/Kg for use at the ear and 1.39W/Kg for use close to the body.

While there may be differences between the SAR levels of various phones and at various positions, they all meet the government requirement for RF exposure.

For body-worn operation, the phone meets FCC RF exposure guidelines provided that it is used with a non-metallic accessory with the handset at least 15 mm from the body. Use of other accessories may not ensure compliance with FCC RF exposure guidelines.

Additional information on SAR can be found on the Cellular Telecommunications & Internet Association (CTIA) Web site: <http://www.ctia.org/>

The World Health Organization (WHO) considers that present scientific information does not indicate the need for any special precautions for use of phones. If individuals are concerned, they may choose to limit their own or their children's RF exposure by limiting the length of calls, or using "hands-free" devices to keep phones away from the head and body. Additional WHO information about electromagnetic fields and public health is available on the following website: <http://www.who.int/peh-emf>.

Note: This equipment has been tested and found to comply with the limits for a Class B digital device pursuant to part 15 of the FCC Rules. These limits are designed to provide reasonable protection against harmful interference in a residential installation. This equipment generates, uses and can radiate radio frequency energy and, if not installed and used in accordance with the instructions, may cause harmful interference to radio communications. However, there is no guarantee that interference to radio or television reception, which can be determined by turning the equipment off and on, the user is encouraged to try to correct the interference by one or more of the following measures:

- Reorient or relocate the receiving antenna.
- Increase the separation between the equipment and receiver.
- Connect the equipment into an outlet on a circuit different from that to which the receiver is connected.
- Consult the dealer or an experienced radio/ TV technician for help.

Changes or modifications not expressly approved by the party responsible for compliance could void the user's authority to operate the equipment. For the receiver devices associated with the operation of a licensed radio service (e.g. FM broadcast), they bear the following statement: This phone complies with Part 15 of the FCC Rules.

Operation is subject to the following two conditions:

- This device may not cause harmful interference.
- This device must accept any interference received, including interference that may cause undesired operation.

Your phone is equipped with a built-in antenna. For optimal operation, you should avoid touching it or degrading it.

HEARING AID COMPATIBILITY HAC FOR WIRELESS TELECOMMUNICATIONS DEVICES

THIS PHONE HAS A HAC RATING OF M4/T3

WHAT IS HEARING AID COMPATIBILITY?

The Federal Communications Commission has implemented rules and a rating system designed to enable people who wear hearing aids to more effectively use these wireless telecommunications devices. The standard for compatibility of digital wireless phones with hearing aids is set forth in American National Standard Institute (ANSI) standard C63.19. There are two sets of ANSI standards with ratings from one to four (four being the best rating): an "M" rating for reduced interference making it easier to hear conversations on the phone when using the hearing aid microphone, and a

“T” rating that enables the phone to be used with hearing aids operating in the tele-coil mode thus reducing unwanted background noise.

HOW WILL I KNOW WHICH WIRELESS PHONES ARE HEARING AID COMPATIBLE?

The Hearing Aid Compatibility rating is displayed on the wireless phone box.

A phone is considered Hearing Aid Compatible for acoustic coupling (microphone mode) if it has an “M3” or “M4” rating. A digital wireless phone is considered Hearing Aid Compatible for inductive coupling (tele-coil mode) if it has a “T3” or “T4” rating.

HOW WILL I KNOW IF MY HEARING AID WILL WORK WITH A PARTICULAR DIGITAL WIRELESS PHONE?

You’ll want to try a number of wireless phones so that you can decide which works the best with your hearing aids. You may also want to talk with your hearing aid professional about the extent to which your hearing aids are immune to interference, if they have wireless phone shielding, and whether your hearing aid has a HAC ratio

This phone has been tested and rated for use with hearing aids for some of the wireless technologies that it uses. However, there may be some newer wireless technologies used in this phone that have not been tested yet for use with hearing aids. It is important to try the different features of this phone thoroughly and in different locations, using your hearing aid or cochlear implant, to determine if you hear any interfering noise. Consult your service provider or the manufacturer of this phone for information on hearing aid compatibility. If you have questions about return or exchange policies, consult your service provider or phone retailer.