

FCC RF Test Report

(U-NII)

Report No.: JYTSZ-R12-2401287

Applicant: Shenzhen DOOGEE Hengtong Technology CO., LTD

Address of Applicant: B, 2/F, Building A4, Silicon Valley Power Digital Industrial Park, No. 22, Dafu Industrial Zone, Guanlan Aobei Community, Guanlan Street, Longhua New District, Shenzhen, Guangdong China

Equipment Under Test (EUT)

Product Name: Smart Phone

Model No.: S119, S119 Pro, S119 Plus, S119 Max, S119 Play, S119 Power, S119 Power Pro, S119 Turbo, S119 Ultra

Trade Mark: DOOGEE

FCC ID: 2AX4YS119

Applicable Standards: FCC CFR Title 47 Part 15E (§15.407)

Date of Sample Receipt: 23 Oct., 2024

Date of Test: 24 Oct., to 18 Nov., 2024

Date of Report Issued: 19 Nov., 2024

Test Result: PASS

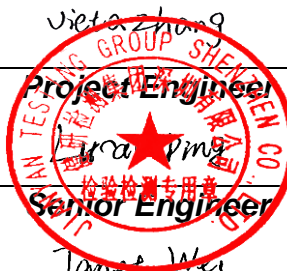
Tested by:	 _____	Date:	19 Nov., 2024 _____
Reviewed by:	_____	Date:	19 Nov., 2024 _____
Approved by:	James Wei _____	Date:	19 Nov., 2024 _____

Manager

This equipment has been shown to be capable of compliance with the applicable technical standards as indicated in the measurement report and was tested in accordance with the measurement procedures specified in above the application standard version. Test results reported herein relate only to the item(s) tested.

This document cannot be reproduced except in full, without prior written approval of the Company. Any unauthorized alteration, forgery or falsification of the content or appearance of this document is unlawful and offenders may be prosecuted to the fullest extent of the law. Unless otherwise stated the results shown in this test report refer only to the sample(s) tested and such sample(s) are retained for 90 days only.

1 Version

Version No.	Date	Description
00	19 Nov., 2024	Original

2 Contents

Page

Cover Page	1
1 Version	2
2 Contents	3
3 General Information	4
3.1 Client Information	4
3.2 General Description of E.U.T.	4
3.3 Test Mode and Environment	5
3.4 Description of Test Auxiliary Equipment	5
3.5 Measurement Uncertainty	5
3.6 Additions to, Deviations, or Exclusions from the Method	5
3.7 Laboratory Facility	6
3.8 Laboratory Location	6
3.9 Test Instruments List	6
4 Measurement Setup and Procedure	8
4.1 Test Channel	8
4.2 Test Setup	8
4.3 Test Procedure	10
5 Test Results	11
5.1 Summary	11
5.1.1 Clause and Data Summary	11
5.1.2 Test Limit	12
5.2 Antenna requirement	14
5.3 AC Power Line Conducted Emission	15
5.4 Unwanted Emissions	17

3 General Information

3.1 Client Information

Applicant:	Shenzhen DOOGEE Hengtong Technology CO., LTD
Address:	B, 2/F, Building A4, Silicon Valley Power Digital Industrial Park, No. 22, Dafu Industrial Zone, Guanlan Aobei Community, Guanlan Street, Longhua New District, Shenzhen, Guangdong China
Manufacturer:	Shenzhen DOOGEE Hengtong Technology CO., LTD
Address:	B, 2/F, Building A4, Silicon Valley Power Digital Industrial Park, No. 22, Dafu Industrial Zone, Guanlan Aobei Community, Guanlan Street, Longhua New District, Shenzhen, Guangdong China
Factory:	Shenzhen DOOGEE Hengtong Technology CO., LTD
Address:	B, 2/F, Building A4, Silicon Valley Power Digital Industrial Park, No. 22, Dafu Industrial Zone, Guanlan Aobei Community, Guanlan Street, Longhua New District, Shenzhen, Guangdong China

3.2 General Description of E.U.T.

Product Name:	Smart Phone
Model No.:	S119, S119 Pro, S119 Plus, S119 Max, S119 Play, S119 Power, S119 Power Pro, S119 Turbo, S119 Ultra
Operation Frequency:	Band 1: 5150 MHz - 5250 MHz Band 4: 5725 MHz - 5850 MHz
Channel Numbers:	Band 1: 4 , Band 4: 5 (802.11a, n-HT20, ac-VHT20) Band 1, 4: 2 (802.11n-HT40, ac-VHT40) Band 1, 4: 1 (802.11ac-VHT80)
Modulation Technology: (IEEE 802.11a/802.11n)	OFDM-BPSK, QPSK, 16QAM, 64QAM
Modulation Technology: (IEEE 802.11ac)	OFDM-BPSK, QPSK, 16QAM, 64QAM, 256QAM
Antenna Type:	Internal Antenna
Antenna Gain:	2.45 dBi (declare by applicant)
Antenna Transmit Mode:	SISO (1TX, 1RX)
Power Supply:	Rechargeable Li-ion Battery DC3.87V, 10200mAh
AC Adapter:	Model: TP303C-US Input: AC100-240V, 50/60Hz, 0.7A Max Output USB-C: DC 5.0V, 3.0A 15.0W; 9.0V, 3.0A 27.0W; 12.0V, 2.5A 30.0W; 15.0V, 2.0A 30.0W; 20.0V, 1.5A 30.0W PPS: DC 5.0V-11.0V, 3.0A 33.0W
Remark:	Model No.: S119, S119 Pro, S119 Plus, S119 Max, S119 Play, S119 Power, S119 Power Pro, S119 Turbo, S119 Ultra were identical inside, the electrical circuit design, layout, components used and internal wiring, with only difference being model name.
Test Sample Condition:	The test samples were provided in good working order with no visible defects.

3.3 Test Mode and Environment

Test Mode:	
Transmitting mode:	Keep the EUT in continuous transmitting with modulation
Per-scan all kind of data rate, the follow list were the worst case:	
Mode	Data rate
802.11a	6.0 Mbps
802.11n-HT20	6.5 Mbps
802.11n-HT40	13.5 Mbps
802.11ac-VHT20	6.5 Mbps
802.11ac-VHT40	13.5 Mbps
802.11ac-VHT80	29.3 Mbps
<i>Remark: For AC power line conducted emission and radiated spurious emission (below 1GHz), pre-scan 802.11a, n, ac modulation mode, found 802.11a modulation mode was worse case mode. The report only reflects the test data of worst mode.</i>	
Operating Environment:	
Temperature:	15°C ~ 35°C
Humidity:	20 % ~ 75 % RH
Atmospheric Pressure:	1008 mbar
Voltage:	Nominal: 3.87 Vdc, Extreme: Low 3.00 Vdc, High 4.45 Vdc
Test Engineer:	Logan Li (Conducted measurement) Real Chen (Radiated measurement)

3.4 Description of Test Auxiliary Equipment

The EUT has been tested as an independent unit.

3.5 Measurement Uncertainty

Parameter	Expanded Uncertainty (Confidence of 95%(U = 2Uc(y)))
Conducted Emission for LISN (9kHz ~ 150kHz)	3.57 dB
Conducted Emission for LISN (150kHz ~ 30MHz)	3.14 dB
Radiated Emission (30MHz ~ 200MHz) (3m SAC)	4.6 dB
Radiated Emission (200MHz ~ 1000MHz) (3m SAC)	5.8 dB
Radiated Emission (1GHz ~ 6GHz) (3m FAR)	4.95 dB
Radiated Emission (6GHz ~ 18GHz) (3m FAR)	5.23 dB
Radiated Emission (18GHz ~ 40GHz) (3m FAR)	5.32 dB
<i>Note: All the measurement uncertainty value were shown with a coverage k=2 to indicate 95% level of confidence. The measurement data show herein meets or exceeds the CISPR measurement uncertainty values specified in CISPR 16-4-2 and can be compared directly to specified limit to determine compliance.</i>	

3.6 Additions to, Deviations, or Exclusions from the Method

No

3.7 Laboratory Facility

The test facility is recognized, certified, or accredited by the following organizations:

- **FCC - Designation No.: CN1211**

JianYan Testing Group Shenzhen Co., Ltd. has been accredited as a testing laboratory by FCC(Federal Communications Commission). The test firm Registration No. is 727551.

- **ISED – CAB identifier.: CN0021**

The 3m Semi-anechoic chamber and 10m Semi-anechoic chamber of JianYan Testing Group Shenzhen Co., Ltd. has been Registered by Certification and Engineering Bureau of Industry Canada for radio equipment testing with Registration No.: 10106A-1.

- **CNAS - Registration No.: CNAS L15527**

JianYan Testing Group Shenzhen Co., Ltd. is accredited to ISO/IEC 17025:2017 General Requirements for the Competence of Testing and Calibration laboratories for the competence of testing. The Registration No. is CNAS L15527.

- **A2LA - Registration No.: 4346.01**

This laboratory is accredited in accordance with the recognized International Standard ISO/IEC 17025:2017 General requirements for the competence of testing and calibration laboratories. The test scope can be found as below link: <https://portal.a2la.org/scopepdf/4346-01.pdf>

3.8 Laboratory Location

JianYan Testing Group Shenzhen Co., Ltd.

Address: No.101, Building 8, Innovation Wisdom Port, No.155 Hongtian Road, Huangpu Community, Xinqiao Street, Bao'an District, Shenzhen, Guangdong, People's Republic of China.

Tel: +86-755-23118282, Fax: +86-755-23116366

Email: info-JYTee@lets.com, Website: <http://jyt.lets.com>

3.9 Test Instruments List

Radiated Emission(3m SAC):					
Test Equipment	Manufacturer	Model No.	Manage No.	Cal. Date (mm-dd-yy)	Cal. Due date (mm-dd-yy)
3m SAC	ETS	9m*6m*6m	WXJ001-1	04-14-2021	04-13-2026
Loop Antenna	Schwarzbeck	FMZB 1519 B	WXJ002-4	01-05-2024	01-04-2025
BiConiLog Antenna	Schwarzbeck	VULB9163	WXJ002	01-09-2024	01-08-2025
Horn Antenna	Schwarzbeck	BBHA9120D	WXJ002-2	01-05-2024	01-04-2025
Horn Antenna	Schwarzbeck	BBHA9170	WXJ002-5	12-28-2023	12-27-2024
Pre-amplifier (30MHz ~ 1GHz)	Schwarzbeck	BBV9743B	WXJ001-2	12-27-2023	12-26-2024
Pre-amplifier (1GHz ~ 18GHz)	SKET	LNPA_0118G-50	WXJ001-3	12-27-2023	12-26-2024
Pre-amplifier (18GHz ~ 40GHz)	RF System	TRLA-180400G45B	WXJ002-7	12-28-2023	12-27-2024
EMI Test Receiver	Rohde & Schwarz	ESRP7	WXJ003-1	12-27-2023	12-26-2024
Spectrum Analyzer	Rohde & Schwarz	FSP 30	WXJ004	12-27-2023	12-26-2024
Spectrum Analyzer	KEYSIGHT	N9010B	WXJ004-2	09-09-2024	09-08-2025
Coaxial Cable (30MHz ~ 1GHz)	JYTSZ	JYT3M-1G-NN-8M	WXG001-4	01-17-2024	01-16-2025
Coaxial Cable (1GHz ~ 18GHz)	JYTSZ	JYT3M-18G-NN-8M	WXG001-5	01-17-2024	01-16-2025
Coaxial Cable (18GHz ~ 40GHz)	JYTSZ	JYT3M-40G-SS-8M	WXG001-7	01-17-2024	01-16-2025
Band Reject Filter Group	Tonscend	JS0806-F	WXJ089	N/A	
Test Software	Tonscend	TS+	Version: 3.0.0.1		

Radiated Emission(3m FAR):					
Test Equipment	Manufacturer	Model No.	Manage No.	Cal. Date (mm-dd-yy)	Cal. Due date (mm-dd-yy)
3m FAR	YUNYI	9m*6m*6m	WXJ097	06-15-2023	06-14-2028
BiConiLog Antenna	Schwarzbeck	VULB9163	WXJ097-2	07-01-2024	06-30-2025
Biconical Antenna	Schwarzbeck	VUBA9117	WXJ002-1	07-01-2024	06-30-2027
Horn Antenna	Schwarzbeck	BBHA9120D	WXJ097-3	06-16-2024	06-15-2025
Horn Antenna	Schwarzbeck	BBHA9120D	WXJ002-3	12-28-2023	12-27-2024
Horn Antenna	Schwarzbeck	BBHA9170	WXJ002-5	12-28-2023	12-27-2024
Horn Antenna	Schwarzbeck	BBHA9170	WXJ002-6	12-28-2023	12-27-2024
Pre-amplifier (30MHz ~ 1GHz)	YUNYI	PAM-310N	WXJ097-5	04-24-2024	04-23-2025
Pre-amplifier (1GHz ~ 18GHz)	YUNYI	PAM-118N	WXJ097-6	04-24-2024	04-23-2025
Pre-amplifier (18GHz ~ 40GHz)	RF System	TRLA-180400G45B	WXJ002-7	12-28-2023	12-27-2024
EMI Test Receiver	Rohde & Schwarz	ESCI3	WXJ003	12-27-2023	12-26-2024
Spectrum Analyzer	Rohde & Schwarz	FSP 30	WXJ004	12-27-2023	12-26-2024
Spectrum Analyzer	KEYSIGHT	N9020B	WXJ081-1	06-11-2024	06-10-2025
Coaxial Cable (30MHz ~ 1GHz)	JYTSZ	JYT3M-1G-NN-13M	WXG097-1	07-30-2024	07-29-2025
Coaxial Cable (1GHz ~ 18GHz)	JYTSZ	JYT3M-18G-NN-8M	WXG097-2	07-30-2024	07-29-2025
Coaxial Cable (18GHz ~ 40GHz)	JYTSZ	JYT3M-40G-SS-8M	WXG097-3	07-30-2024	07-29-2025
High Band Reject Filter Group	Tonscend	JS0806-F	WXJ089	N/A	
Low Band Reject Filter Group	Tonscend	JS0806-F	WXJ097-4	N/A	
Test Software	Tonscend	TS+	Version: 5.0.0		

Conducted Emission:					
Test Equipment	Manufacturer	Model No.	Manage No.	Cal. Date (mm-dd-yy)	Cal. Due date (mm-dd-yy)
EMI Test Receiver	Rohde & Schwarz	ESR3	WXJ003-2	06-11-2024	06-10-2025
LISN	Schwarzbeck	NSLK 8127	QCJ001-13	12-27-2023	12-26-2024
LISN	Rohde & Schwarz	ESH3-Z5	WXJ005-1	12-27-2023	12-26-2024
LISN Coaxial Cable (9kHz ~ 30MHz)	JYTSZ	JYTCE-1G-NN-2M	WXG003-1	01-17-2024	01-16-2025
Test Software	AUDIX	E3	Version: 6.110919b		

Conducted Method:					
Test Equipment	Manufacturer	Model No.	Manage No.	Cal. Date (mm-dd-yy)	Cal. Due date (mm-dd-yy)
Spectrum Analyzer	Keysight	N9010B	WXJ004-3	09-10-2024	09-09-2025
Temperature Humidity Chamber	ZHONG ZHI	CZ-A-80D	WXJ032-3	01-09-2023	01-08-2025
Power Detector Box	MWRFTTEST	MW100-PSB	WXJ007-4	09-10-2024	09-09-2025
RF Control Unit	MWRFTTEST	MW100-RFCB	WXG006	N/A	
RF Switch	TOP PRECISION	RSU0301	WXG003	N/A	
DC Power Supply	Keysight	E3642A	WXJ025-2	N/A	
Test Software	MWRFTTEST	MTS 8310	Version: 2.0.0.0		

4 Measurement Setup and Procedure

4.1 Test Channel

According to ANSI C63.10-2013 chapter 5.6.1 Table 4 requirement, select lowest channel, middle channel, and highest channel in the frequency range in which device operates for testing. The detailed frequency points are as follows:

Operation frequency: 5150 MHz – 5250 MHz						
Modulation mode	Lowest channel		Middle channel		Highest channel	
	Channel No.	Frequency (MHz)	Channel No.	Frequency (MHz)	Channel No.	Frequency (MHz)
802.11a, n-HT20, ac-VHT20	36	5180	40	5200	48	5240
802.11n-HT40, ac-VHT40	38	5190	/	/	46	5230
802.11ac-VHT80	/	/	42	5210	/	/

Operation frequency: 5725 MHz – 5850 MHz						
Modulation mode	Lowest channel		Middle channel		Highest channel	
	Channel No.	Frequency (MHz)	Channel No.	Frequency (MHz)	Channel No.	Frequency (MHz)
802.11a, n-HT20, ac-VHT20	149	5745	157	5785	165	5825
802.11n-HT40, ac-VHT40	151	5755	/	/	159	5795
802.11ac-VHT80	/	/	155	5775	/	/

4.2 Test Setup

1) Conducted emission measurement:

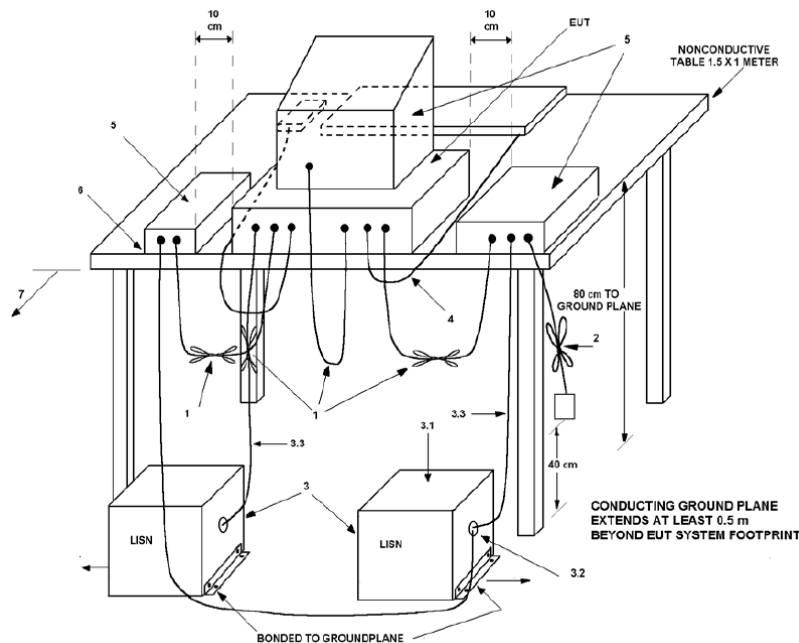

Note: The detailed descriptions please refer to Figure 8 of ANSI C63.4:2014.

2) Radiated emission measurement:

Below 1GHz (3m SAC)

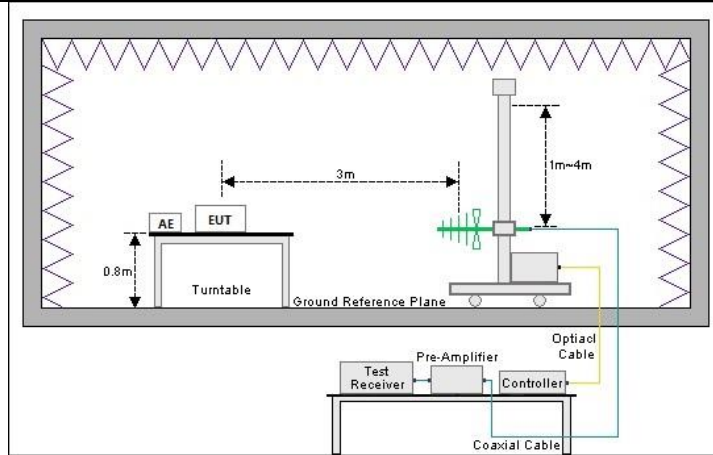

Above 1GHz (3m FAR)

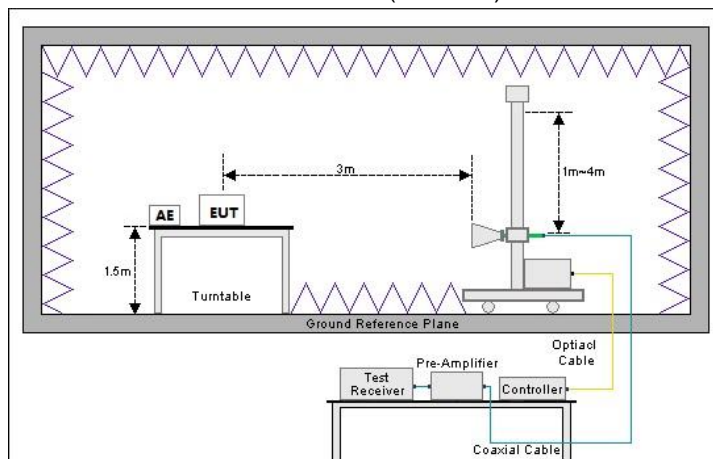

3) Conducted test method

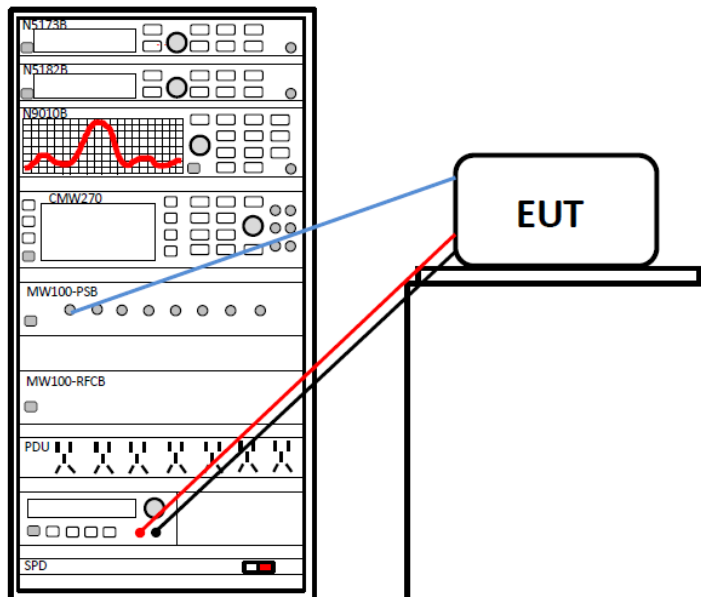

4.3 Test Procedure

Test method	Test step
Conducted emission	<ol style="list-style-type: none"> The E.U.T and simulators are connected to the main power through a line impedance stabilization network (L.I.S.N.). This provides a 50ohm/50uH coupling impedance for the measuring equipment. The peripheral devices are also connected to the main power through a LISN that provides a 50ohm/50uH coupling impedance with 50ohm termination. (Please refer to the block diagram of the test setup and photographs). Both sides of A.C. line are checked for maximum conducted interference. In order to find the maximum emission, the relative positions of equipment and all of the interface cables must be changed according to ANSI C63.10 on conducted measurement.
Radiated emission	<p>For below 1GHz:</p> <ol style="list-style-type: none"> The EUT was placed on the tabletop of a rotating table 0.8 m the ground at a 3 m semi anechoic chamber. The measurement distance from the EUT to the receiving antenna is 3 m. EUT works in each mode of operation that needs to be tested , and having the EUT continuously working, respectively on 3 axis (X, Y & Z) and considered typical configuration to obtain worst position. The highest signal levels relative to the limit shall be determined by rotating the EUT from 0° to 360° and with varying the measurement antenna height between 1 m and 4 m in vertical and horizontal polarizations. Open the test software to control the test antenna and test turntable. Perform the test, save the test results, and export the test data. <p>For above 1GHz:</p> <ol style="list-style-type: none"> The EUT was placed on the tabletop of a rotating table 1.5 m the ground at a 3 m fully anechoic room. The measurement distance from the EUT to the receiving antenna is 3 m. EUT works in each mode of operation that needs to be tested , and having the EUT continuously working, respectively on 3 axis (X, Y & Z) and considered typical configuration to obtain worst position. The highest signal levels relative to the limit shall be determined by rotating the EUT from 0° to 360° and with varying the measurement antenna height between 1 m and 4 m in vertical and horizontal polarizations. Open the test software to control the test antenna and test turntable. Perform the test, save the test results, and export the test data.
Conducted test method	<ol style="list-style-type: none"> The Wi-Fi antenna port of EUT was connected to the test port of the test system through an RF cable. The EUT is keeping in continuous transmission mode and tested in all modulation modes. Open the test software, prepare a test plan, and control the system through the software. After the test is completed, the test report is exported through the test software.

5 Test Results

5.1 Summary

5.1.1 Clause and Data Summary

Test items	Standard clause	Test data	Result
Antenna Requirement	15.203	See Section 5.2	Pass
AC Power Line Conducted Emission	15.207 15.407 (b)(9)	See Section 5.3	Pass
Duty Cycle	ANSI C63.10-2013	Appendix – 5.2G Wi-Fi Appendix – 5.8G Wi-Fi	Pass
Conducted Peak Output Power Power Spectral Density	15.407 (a)(1)(iv)-(B1), (a)(3)(i)-(B4)	Appendix – 5.2G Wi-Fi Appendix – 5.8G Wi-Fi	Pass
26dB Emission Bandwidth 99% Occupied Bandwidth	15.407 (a)(12)	Appendix – 5.2G Wi-Fi Appendix – 5.8G Wi-Fi	Pass
6dB Emission Bandwidth	15.407 (e)	Appendix – 5.2G Wi-Fi Appendix – 5.8G Wi-Fi	Pass
Unwanted Emissions	15.205 15.209 15.407 (b)(1) -(B1), (4) -(B4), (9), (10)	See Section 5.4	Pass
Frequency Stability	15.407 (g)	Appendix – 5.2G Wi-Fi Appendix – 5.8G Wi-Fi	Pass
Dynamic frequency selection	15.407 (h)(2)	N/A	N/A
Remark: 1. Pass: The EUT complies with the essential requirements in the standard. 2. N/A: Not Applicable. 3. The cable insertion loss used by “RF Output Power” and other conduction measurement items is 1.0dB (provided by the customer).			
Test Method:	ANSI C63.10-2013 KDB 789033 D02 General U-NII Test Procedures New Rules v02r01		

5.1.2 Test Limit

Test items	Limit															
AC Power Line Conducted Emission	<table border="1"> <thead> <tr> <th data-bbox="603 277 900 344">Frequency (MHz)</th> <th colspan="2" data-bbox="900 277 1437 315">Limit (dBμV)</th> </tr> <tr> <td></td> <th data-bbox="900 315 1171 344">Quasi-Peak</th> <th data-bbox="1171 315 1437 344">Average</th> </tr> </thead> <tbody> <tr> <td data-bbox="603 344 900 374">0.15 – 0.5</td> <td data-bbox="900 344 1171 374">66 to 56 <small>Note 1</small></td> <td data-bbox="1171 344 1437 374">56 to 46 <small>Note 1</small></td> </tr> <tr> <td data-bbox="603 374 900 403">0.5 – 5</td> <td data-bbox="900 374 1171 403">56</td> <td data-bbox="1171 374 1437 403">46</td> </tr> <tr> <td data-bbox="603 403 900 432">5 – 30</td> <td data-bbox="900 403 1171 432">60</td> <td data-bbox="1171 403 1437 432">50</td> </tr> </tbody> </table> <p data-bbox="612 439 1310 463">Note 1: The limit level in dBμV decreases linearly with the logarithm of frequency.</p> <p data-bbox="612 465 1166 490">Note 2: The more stringent limit applies at transition frequencies.</p>	Frequency (MHz)	Limit (dB μ V)			Quasi-Peak	Average	0.15 – 0.5	66 to 56 <small>Note 1</small>	56 to 46 <small>Note 1</small>	0.5 – 5	56	46	5 – 30	60	50
Frequency (MHz)	Limit (dB μ V)															
	Quasi-Peak	Average														
0.15 – 0.5	66 to 56 <small>Note 1</small>	56 to 46 <small>Note 1</small>														
0.5 – 5	56	46														
5 – 30	60	50														
Conducted Peak Output Power Power Spectral Density	<p data-bbox="577 517 932 542">For the 5.15-5.25 GHz band:</p> <p data-bbox="577 555 1474 804">For client devices in the 5.15-5.25 GHz band, the maximum conducted output power over the frequency band of operation shall not exceed 250 mW provided the maximum antenna gain does not exceed 6 dBi. In addition, the maximum power spectral density shall not exceed 11 dBm in any 1 megahertz band. If transmitting antennas of directional gain greater than 6 dBi are used, both the maximum conducted output power and the maximum power spectral density shall be reduced by the amount in dB that the directional gain of the antenna exceeds 6 dBi.</p> <p data-bbox="577 853 963 878">For the band 5.725-5.895 GHz:</p> <p data-bbox="577 891 1474 1391">For the band 5.725-5.850 GHz, the maximum conducted output power over the frequency band of operation shall not exceed 1 W. In addition, the maximum power spectral density shall not exceed 30 dBm in any 500-kHz band. If transmitting antennas of directional gain greater than 6 dBi are used, both the maximum conducted output power and the maximum power spectral density shall be reduced by the amount in dB that the directional gain of the antenna exceeds 6 dBi. However, Fixed point-to-point U-NII devices operating in this band may employ transmitting antennas with directional gain greater than 6 dBi without any corresponding reduction in transmitter conducted power. Fixed, point-to-point operations exclude the use of point-to-multipoint systems, omnidirectional applications, and multiple collocated transmitters transmitting the same information. The operator of the U-NII device, or if the equipment is professionally installed, the installer, is responsible for ensuring that systems employing high gain directional antennas are used exclusively for fixed, point-to-point operations.</p>															
26dB Emission Bandwidth 99% Occupied Bandwidth	N/A															
6dB Emission Bandwidth	Within the 5.725-5.850 GHz and 5.850-5.895 GHz bands, the minimum 6 dB bandwidth of U-NII devices shall be at least 500 kHz.															

<p>Unwanted Emissions</p>	<p>(1) For transmitters operating in the 5.15-5.25 GHz band: All emissions outside of the 5.15-5.35 GHz band shall not exceed an e.i.r.p. of 27 dBm/MHz.</p> <p>(2) For transmitters operating solely in the 5.725-5.850 GHz band: All emissions shall be limited to a level of 27 dBm/MHz at 75 MHz or more above or below the band edge increasing linearly to 10 dBm/MHz at 25 MHz above or below the band edge, and from 25 MHz above or below the band edge increasing linearly to a level of 15.6 dBm/MHz at 5 MHz above or below the band edge, and from 5 MHz above or below the band edge increasing linearly to a level of 27 dBm/MHz at the band edge.</p> <p>(3) Unwanted emissions below 1 GHz must comply with the general field strength limits set forth in § 15.209. The provisions of § 15.205 apply to intentional radiators operating under this section:</p> <table border="1" data-bbox="582 741 1457 943"> <thead> <tr> <th rowspan="2">Frequency (MHz)</th> <th colspan="2">Limit (dBµV/m)</th> <th rowspan="2">Detector</th> </tr> <tr> <th>@ 3m</th> <th>@ 10m</th> </tr> </thead> <tbody> <tr> <td>30 – 88</td> <td>40.0</td> <td>30.0</td> <td>Quasi-peak</td> </tr> <tr> <td>88 – 216</td> <td>43.5</td> <td>33.5</td> <td>Quasi-peak</td> </tr> <tr> <td>216 – 960</td> <td>46.0</td> <td>36.0</td> <td>Quasi-peak</td> </tr> <tr> <td>960 – 1000</td> <td>54.0</td> <td>44.0</td> <td>Quasi-peak</td> </tr> </tbody> </table> <p>Note: The more stringent limit applies at transition frequencies.</p> <table border="1" data-bbox="582 969 1457 1077"> <thead> <tr> <th rowspan="2">Frequency</th> <th colspan="2">Limit (dBµV/m) @ 3m</th> </tr> <tr> <th>Average</th> <th>Peake</th> </tr> </thead> <tbody> <tr> <td>Above 1 GHz</td> <td>54.0</td> <td>74.0</td> </tr> </tbody> </table> <p>Note: The measurement bandwidth shall be 1 MHz or greater.</p>	Frequency (MHz)	Limit (dBµV/m)		Detector	@ 3m	@ 10m	30 – 88	40.0	30.0	Quasi-peak	88 – 216	43.5	33.5	Quasi-peak	216 – 960	46.0	36.0	Quasi-peak	960 – 1000	54.0	44.0	Quasi-peak	Frequency	Limit (dBµV/m) @ 3m		Average	Peake	Above 1 GHz	54.0	74.0
Frequency (MHz)	Limit (dBµV/m)		Detector																												
	@ 3m	@ 10m																													
30 – 88	40.0	30.0	Quasi-peak																												
88 – 216	43.5	33.5	Quasi-peak																												
216 – 960	46.0	36.0	Quasi-peak																												
960 – 1000	54.0	44.0	Quasi-peak																												
Frequency	Limit (dBµV/m) @ 3m																														
	Average	Peake																													
Above 1 GHz	54.0	74.0																													
<p>Frequency Stability</p>	<p>Manufacturers of U-NII devices are responsible for ensuring frequency stability such that an emission is maintained within the band of operation under all conditions of normal operation as specified in the users manual.</p>																														

5.2 Antenna requirement

Standard requirement:	FCC Part 15 C Section 15.203
<p>15.203 requirement: An intentional radiator shall be designed to ensure that no antenna other than that furnished by the responsible party shall be used with the device. The use of a permanently attached antenna or of an antenna that uses a unique coupling to the intentional radiator, the manufacturer may design the unit so that a broken antenna can be replaced by the user, but the use of a standard antenna jack or electrical connector is prohibited.</p>	
E.U.T Antenna:	
<p>The Wi-Fi antenna is an internal antenna which cannot replace by end-user, the best case gain of the antenna is 2.45 dBi. See product internal photos for details.</p>	

5.3 AC Power Line Conducted Emission

Product name:	Smart Phone	Product model:	S119
Test by:	Kiran Zeng	Test mode:	5G Wi-Fi mode
Test frequency:	150 kHz ~ 30 MHz	Phase:	Line
Test voltage:	AC 120 V/60 Hz		

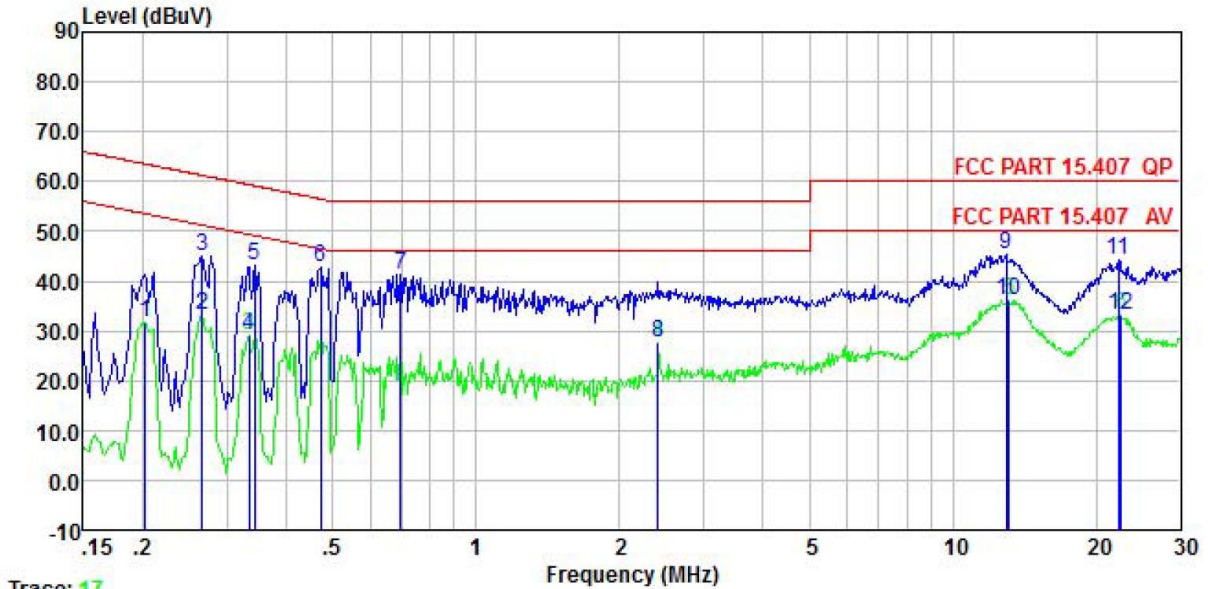

Trace: 17

	Read Freq	Read Level	LISN Factor	Aux Factor	Aux2 Factor	Cable Loss	Level	Limit Line	Over Limit	Remark
	MHz	dBuV	dB	dB	dB	dB	dBuV	dBuV	dB	
1	0.202	21.65	0.20	0.00	9.88	0.04	31.77	53.54	-21.77	Average
2	0.266	23.07	0.20	0.00	9.88	0.02	33.17	51.25	-18.08	Average
3	0.266	34.85	0.20	0.00	9.88	0.02	44.95	61.25	-16.30	QP
4	0.334	18.87	0.20	0.00	9.88	0.02	28.97	49.35	-20.38	Average
5	0.343	33.20	0.20	0.00	9.88	0.02	43.30	59.13	-15.83	QP
6	0.471	32.52	0.20	0.00	9.88	0.03	42.63	56.49	-13.86	QP
7	0.694	31.20	0.20	0.00	9.88	0.03	41.31	56.00	-14.69	QP
8	2.409	17.59	0.20	0.00	9.88	0.15	27.82	46.00	-18.18	Average
9	12.920	34.89	0.26	0.00	9.92	0.11	45.18	60.00	-14.82	QP
10	13.127	25.69	0.27	0.00	9.92	0.11	35.99	50.00	-14.01	Average
11	22.298	33.54	0.40	0.00	9.98	0.16	44.08	60.00	-15.92	QP
12	22.535	22.55	0.40	0.00	9.98	0.16	33.09	50.00	-16.91	Average

Remark:

1. Level = Read level + LISN Factor + Cable Loss.

Product name:	Smart Phone	Product model:	S119
Test by:	Kiran Zeng	Test mode:	5G Wi-Fi mode
Test frequency:	150 kHz ~ 30 MHz	Phase:	Neutral
Test voltage:	AC 120 V/60 Hz		

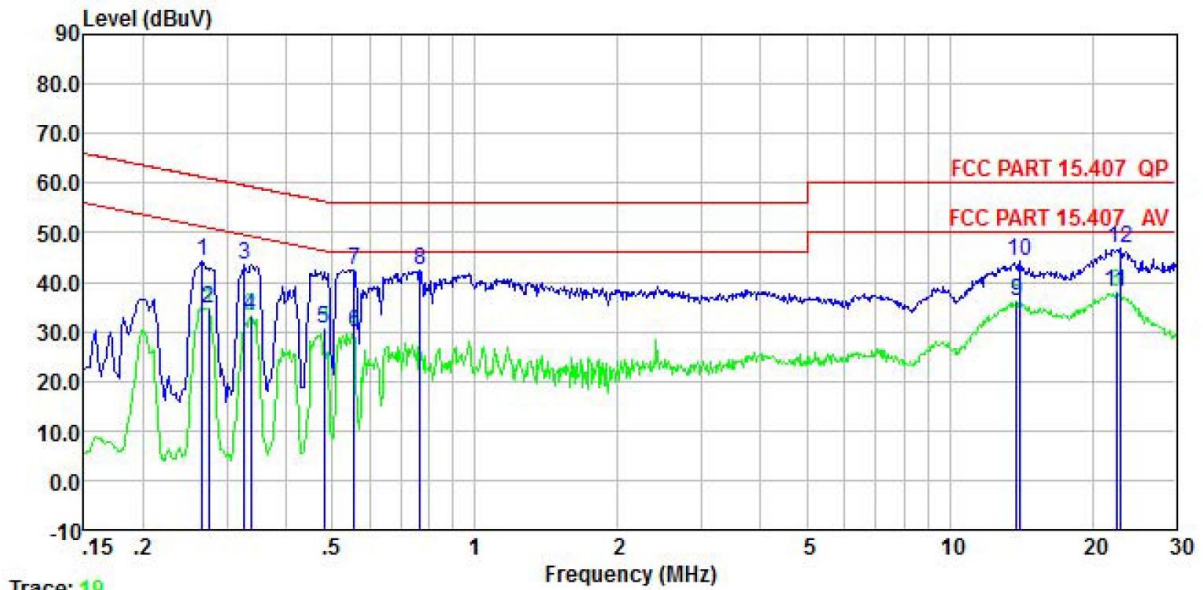

	Read Freq	Read Level	LISN Factor	Aux Factor	Aux2 Factor	Cable Loss	Level	Limit Line	Over Limit	Remark
	MHz	dBuV	dB	dB	dB	dB	dBuV	dBuV	dB	
1	0.266	34.04	0.20	0.00	9.88	0.02	44.14	61.25	-17.11	QP
2	0.274	24.68	0.20	0.00	9.88	0.02	34.78	50.98	-16.20	Average
3	0.327	33.37	0.20	0.00	9.88	0.02	43.47	59.53	-16.06	QP
4	0.337	23.05	0.20	0.00	9.88	0.02	33.15	49.27	-16.12	Average
5	0.481	20.49	0.20	0.00	9.88	0.03	30.60	46.32	-15.72	Average
6	0.555	19.63	0.20	0.00	9.88	0.02	29.73	46.00	-16.27	Average
7	0.555	32.31	0.20	0.00	9.88	0.02	42.41	56.00	-13.59	QP
8	0.767	32.27	0.20	0.00	9.88	0.03	42.38	56.00	-13.62	QP
9	13.841	25.73	0.40	0.00	9.93	0.12	36.18	50.00	-13.82	Average
10	14.063	33.82	0.40	0.00	9.93	0.12	44.27	60.00	-15.73	QP
11	22.416	27.29	0.40	0.00	9.98	0.16	37.83	50.00	-12.17	Average
12	22.896	36.16	0.40	0.00	9.99	0.16	46.71	60.00	-13.29	QP

Remark:

1. Level = Read level + LISN Factor + Cable Loss.

5.4 Unwanted Emissions

Below 1GHz:

Product Name:	Smart Phone	Product Model:	S119
Test By:	Alan Chen	Test mode:	5G Wi-Fi mode
Test Frequency:	30 MHz ~ 1 GHz	Polarization:	Vertical
Test Voltage:	DC 3.87V		

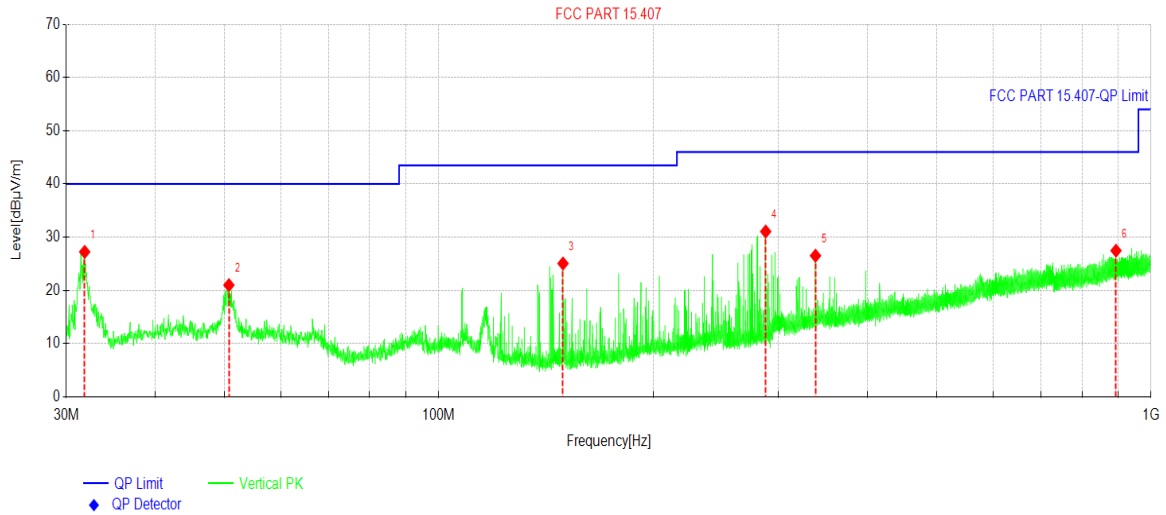

Suspected Data List

NO.	Freq. [MHz]	Reading [dBµV/m]	Factor [dB]	Level [dBµV/m]	Limit [dBµV/m]	Margin [dB]	Trace	Polarity
1	31.8431	43.17	-15.93	27.24	40.00	12.76	PK	Vertical
2	50.7590	33.71	-12.71	21.00	40.00	19.00	PK	Vertical
3	149.4615	43.29	-18.23	25.06	43.50	18.44	PK	Vertical
4	287.7904	44.31	-13.25	31.06	46.00	14.94	PK	Vertical
5	338.0874	38.34	-11.82	26.52	46.00	19.48	PK	Vertical
6	893.0522	30.21	-2.74	27.47	46.00	18.53	PK	Vertical

Remark:

1. Level = Reading + Factor(Antenna Factor + Cable Loss – Preamplifier Factor).

Product Name:	Smart Phone	Product Model:	S119
Test By:	Alan Chen	Test mode:	5G Wi-Fi mode
Test Frequency:	30 MHz ~ 1 GHz	Polarization:	Horizontal
Test Voltage:	DC 3.87V		

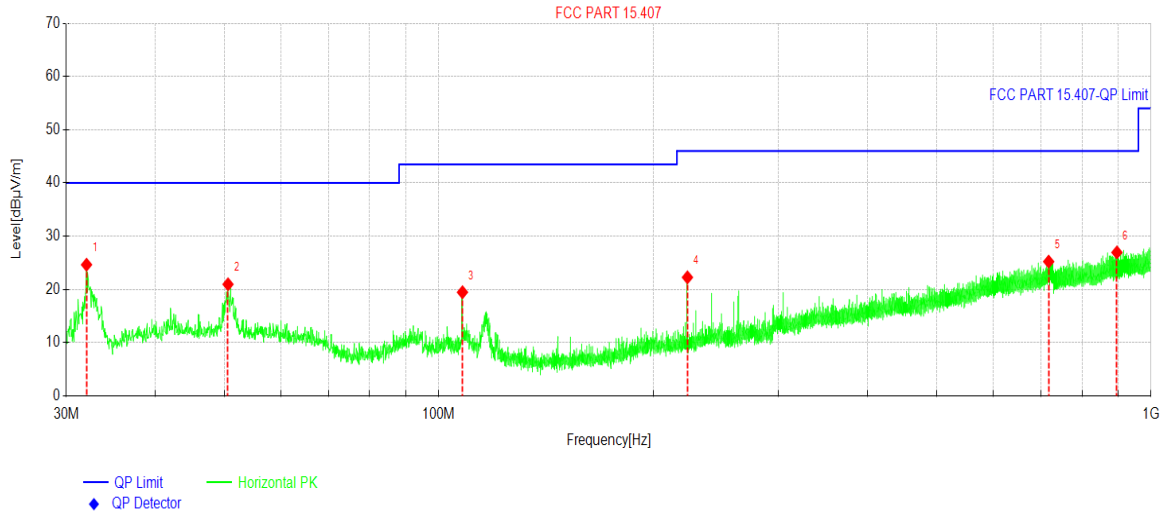

Suspected Data List								
NO.	Freq. [MHz]	Reading [dBµV/m]	Factor [dB]	Level [dBµV/m]	Limit [dBµV/m]	Margin [dB]	Trace	Polarity
1	32.0371	40.58	-15.94	24.64	40.00	15.36	PK	Horizontal
2	50.6135	33.67	-12.71	20.96	40.00	19.04	PK	Horizontal
3	107.9919	34.09	-14.62	19.47	43.50	24.03	PK	Horizontal
4	223.4762	37.23	-14.97	22.26	46.00	23.74	PK	Horizontal
5	718.4434	30.28	-5.06	25.22	46.00	20.78	PK	Horizontal
6	895.7198	29.64	-2.69	26.95	46.00	19.05	PK	Horizontal

Remark:

1. Level = Reading + Factor(Antenna Factor + Cable Loss – Preamplifier Factor).

Above 1GHz

Band 1: 5150 MHz - 5250 MHz, 802.11a						
Test channel: Lowest channel						
Detector: Peak Value						
Frequency (MHz)	Read Level (dBμV)	Factor (dB)	Level (dBμV/m)	Limit (dBμV/m)	Margin (dB)	Polarization
5150.00	68.05	-6.26	61.79	74.00	12.21	Vertical
10360.00	47.31	1.27	48.58	68.20	19.62	Vertical
5150.00	74.07	-6.26	67.81	74.00	6.19	Horizontal
10360.00	47.14	1.27	48.41	68.20	19.79	Horizontal
Detector: Average Value						
Frequency (MHz)	Read Level (dBμV)	Factor (dB)	Level (dBμV/m)	Limit (dBμV/m)	Margin (dB)	Polarization
5150.00	52.36	-6.26	46.10	54.00	7.90	Vertical
5150.00	56.90	-6.26	50.64	54.00	3.36	Horizontal
Test channel: Middle channel						
Detector: Peak Value						
Frequency (MHz)	Read Level (dBμV)	Factor (dB)	Level (dBμV/m)	Limit (dBμV/m)	Margin (dB)	Polarization
10400.00	46.41	2.39	48.80	68.20	19.40	Vertical
10400.00	47.13	2.39	49.52	68.20	18.68	Horizontal
Test channel: Highest channel						
Detector: Peak Value						
Frequency (MHz)	Read Level (dBμV)	Factor (dB)	Level (dBμV/m)	Limit (dBμV/m)	Margin (dB)	Polarization
5350.00	59.75	-6.32	53.43	74.00	20.57	Vertical
10480.00	46.98	2.80	49.78	68.20	18.42	Vertical
5350.00	60.10	-6.32	53.78	74.00	20.22	Horizontal
10480.00	45.93	2.80	48.73	68.20	19.47	Horizontal
Detector: Average Value						
Frequency (MHz)	Read Level (dBμV)	Factor (dB)	Level (dBμV/m)	Limit (dBμV/m)	Margin (dB)	Polarization
5350.00	48.96	-6.32	42.64	54.00	11.36	Vertical
5350.00	49.14	-6.32	42.82	54.00	11.18	Horizontal
Remark:						
1. Level = Reading + Factor.						
2. Test Frequency up to 40GHz, and the emission levels of other frequencies are lower than the limit 20dB, not show in test report.						

Band 1: 5150 MHz - 5250 MHz, 802.11n-HT20						
Test channel: Lowest channel						
Detector: Peak Value						
Frequency (MHz)	Read Level (dBμV)	Factor (dB)	Level (dBμV/m)	Limit (dBμV/m)	Margin (dB)	Polarization
5150.00	68.38	-6.26	62.12	74.00	11.88	Vertical
10360.00	47.32	1.27	48.59	68.20	19.61	Vertical
5150.00	72.86	-6.26	66.60	74.00	7.40	Horizontal
10360.00	47.13	1.27	48.40	68.20	19.80	Horizontal
Detector: Average Value						
Frequency (MHz)	Read Level (dBμV)	Factor (dB)	Level (dBμV/m)	Limit (dBμV/m)	Margin (dB)	Polarization
5150.00	53.02	-6.26	46.76	54.00	7.24	Vertical
5150.00	58.34	-6.26	52.08	54.00	1.92	Horizontal
Test channel: Middle channel						
Detector: Peak Value						
Frequency (MHz)	Read Level (dBμV)	Factor (dB)	Level (dBμV/m)	Limit (dBμV/m)	Margin (dB)	Polarization
10400.00	46.90	2.39	49.29	68.20	18.91	Vertical
10400.00	46.60	2.39	48.99	68.20	19.21	Horizontal
Test channel: Highest channel						
Detector: Peak Value						
Frequency (MHz)	Read Level (dBμV)	Factor (dB)	Level (dBμV/m)	Limit (dBμV/m)	Margin (dB)	Polarization
5350.00	59.83	-6.32	53.51	74.00	20.49	Vertical
10480.00	46.73	2.80	49.53	68.20	18.67	Vertical
5350.00	59.95	-6.32	53.63	74.00	20.37	Horizontal
10480.00	46.44	2.80	49.24	68.20	18.96	Horizontal
Detector: Average Value						
Frequency (MHz)	Read Level (dBμV)	Factor (dB)	Level (dBμV/m)	Limit (dBμV/m)	Margin (dB)	Polarization
5350.00	48.91	-6.32	42.59	54.00	11.41	Vertical
5350.00	49.20	-6.32	42.88	54.00	11.12	Horizontal
Remark:						
1. Level = Reading + Factor.						
2. Test Frequency up to 40GHz, and the emission levels of other frequencies are lower than the limit 20dB, not show in test report.						

Band 1: 5150 MHz - 5250 MHz, 802.11n-HT40						
Test channel: Lowest channel						
Detector: Peak Value						
Frequency (MHz)	Read Level (dBμV)	Factor (dB)	Level (dBμV/m)	Limit (dBμV/m)	Margin (dB)	Polarization
5150.00	65.58	-6.26	59.32	74.00	14.68	Vertical
10380.00	46.51	1.84	48.35	68.20	19.85	Vertical
5150.00	68.39	-6.26	62.13	74.00	11.87	Horizontal
10380.00	46.15	1.84	47.99	68.20	20.21	Horizontal
Detector: Average Value						
Frequency (MHz)	Read Level (dBμV)	Factor (dB)	Level (dBμV/m)	Limit (dBμV/m)	Margin (dB)	Polarization
5150.00	52.18	-6.26	45.92	54.00	8.08	Vertical
5150.00	57.05	-6.26	50.79	54.00	3.21	Horizontal
Test channel: Highest channel						
Detector: Peak Value						
Frequency (MHz)	Read Level (dBμV)	Factor (dB)	Level (dBμV/m)	Limit (dBμV/m)	Margin (dB)	Polarization
5350.00	48.68	-6.32	42.36	74.00	31.64	Vertical
10460.00	46.69	1.65	48.34	68.20	19.86	Vertical
5350.00	60.01	-6.32	53.69	74.00	20.31	Horizontal
10460.00	46.55	1.65	48.20	68.20	20.00	Horizontal
Detector: Average Value						
Frequency (MHz)	Read Level (dBμV)	Factor (dB)	Level (dBμV/m)	Limit (dBμV/m)	Margin (dB)	Polarization
5350.00	48.58	-6.32	42.26	54.00	11.74	Vertical
5350.00	48.68	-6.32	42.36	54.00	11.64	Horizontal
Remark:						
1. Level = Reading + Factor.						
2. Test Frequency up to 40GHz, and the emission levels of other frequencies are lower than the limit 20dB, not show in test report.						

Band 1: 5150 MHz - 5250 MHz, 802.11ac-VHT20						
Test channel: Lowest channel						
Detector: Peak Value						
Frequency (MHz)	Read Level (dBμV)	Factor (dB)	Level (dBμV/m)	Limit (dBμV/m)	Margin (dB)	Polarization
5150.00	67.98	-6.26	61.72	74.00	12.28	Vertical
10360.00	47.25	1.27	48.52	68.20	19.68	Vertical
5150.00	72.66	-6.26	66.40	74.00	7.60	Horizontal
10360.00	47.08	1.27	48.35	68.20	19.85	Horizontal
Detector: Average Value						
Frequency (MHz)	Read Level (dBμV)	Factor (dB)	Level (dBμV/m)	Limit (dBμV/m)	Margin (dB)	Polarization
5150.00	52.68	-6.26	46.42	54.00	7.58	Vertical
5150.00	58.15	-6.26	51.89	54.00	2.11	Horizontal
Test channel: Middle channel						
Detector: Peak Value						
Frequency (MHz)	Read Level (dBμV)	Factor (dB)	Level (dBμV/m)	Limit (dBμV/m)	Margin (dB)	Polarization
10400.00	46.95	2.39	49.34	68.20	18.86	Vertical
10400.00	46.62	2.39	49.01	68.20	19.19	Horizontal
Test channel: Highest channel						
Detector: Peak Value						
Frequency (MHz)	Read Level (dBμV)	Factor (dB)	Level (dBμV/m)	Limit (dBμV/m)	Margin (dB)	Polarization
5350.00	59.45	-6.32	53.13	74.00	20.87	Vertical
10480.00	46.61	2.80	49.41	68.20	18.79	Vertical
5350.00	59.66	-6.32	53.34	74.00	20.66	Horizontal
10480.00	46.56	2.80	49.36	68.20	18.84	Horizontal
Detector: Average Value						
Frequency (MHz)	Read Level (dBμV)	Factor (dB)	Level (dBμV/m)	Limit (dBμV/m)	Margin (dB)	Polarization
5350.00	48.64	-6.32	42.32	54.00	11.68	Vertical
5350.00	49.14	-6.32	42.82	54.00	11.18	Horizontal
Remark:						
1. Level = Reading + Factor.						
2. Test Frequency up to 40GHz, and the emission levels of other frequencies are lower than the limit 20dB, not show in test report.						

Band 1: 5150 MHz - 5250 MHz, 802.11ac-VHT40						
Test channel: Lowest channel						
Detector: Peak Value						
Frequency (MHz)	Read Level (dBμV)	Factor (dB)	Level (dBμV/m)	Limit (dBμV/m)	Margin (dB)	Polarization
5150.00	64.78	-6.26	58.52	74.00	15.48	Vertical
10380.00	46.44	1.84	48.28	68.20	19.92	Vertical
5150.00	67.57	-6.26	61.31	74.00	12.69	Horizontal
10380.00	46.04	1.84	47.88	68.20	20.32	Horizontal
Detector: Average Value						
Frequency (MHz)	Read Level (dBμV)	Factor (dB)	Level (dBμV/m)	Limit (dBμV/m)	Margin (dB)	Polarization
5150.00	52.13	-6.26	45.87	54.00	8.13	Vertical
5150.00	57.04	-6.26	50.78	54.00	3.22	Horizontal
Test channel: Highest channel						
Detector: Peak Value						
Frequency (MHz)	Read Level (dBμV)	Factor (dB)	Level (dBμV/m)	Limit (dBμV/m)	Margin (dB)	Polarization
5350.00	48.68	-6.32	42.36	74.00	31.64	Vertical
10460.00	46.69	1.65	48.34	68.20	19.86	Vertical
5350.00	60.01	-6.32	53.69	74.00	20.31	Horizontal
10460.00	46.55	1.65	48.20	68.20	20.00	Horizontal
Detector: Average Value						
Frequency (MHz)	Read Level (dBμV)	Factor (dB)	Level (dBμV/m)	Limit (dBμV/m)	Margin (dB)	Polarization
5350.00	48.64	-6.32	42.32	54.00	11.68	Vertical
5350.00	48.65	-6.32	42.33	54.00	11.67	Horizontal
Remark:						
1. Level = Reading + Factor.						
2. Test Frequency up to 40GHz, and the emission levels of other frequencies are lower than the limit 20dB, not show in test report.						

Band 1: 5150 MHz - 5250 MHz, 802.11ac-VHT80						
Test channel: Middle channel						
Detector: Peak Value						
Frequency (MHz)	Read Level (dBμV)	Factor (dB)	Level (dBμV/m)	Limit (dBμV/m)	Margin (dB)	Polarization
5150.00	62.05	-6.26	55.79	74.00	18.21	Vertical
5350.00	60.85	-6.32	54.53	74.00	19.47	Vertical
10420.00	48.68	1.85	50.53	68.20	17.67	Vertical
5150.00	67.69	-6.26	61.43	74.00	12.57	Horizontal
5350.00	60.32	-6.32	54.00	74.00	20.00	Horizontal
10420.00	48.68	1.85	50.53	68.20	17.67	Horizontal
Detector: Average Value						
Frequency (MHz)	Read Level (dBμV)	Factor (dB)	Level (dBμV/m)	Limit (dBμV/m)	Margin (dB)	Polarization
5150.00	51.32	-6.26	45.06	54.00	8.94	Vertical
5350.00	48.72	-6.32	42.40	54.00	11.60	Vertical
5150.00	55.63	-6.26	49.37	54.00	4.63	Horizontal
5350.00	48.78	-6.32	42.46	54.00	11.54	Horizontal
Remark:						
1. Level = Reading + Factor.						
2. Test Frequency up to 40GHz, and the emission levels of other frequencies are lower than the limit 20dB, not show in test report.						

Band 4: 5725 MHz - 5825 MHz, 802.11a						
Test channel: Lowest channel						
Detector: Peak Value						
Frequency (MHz)	Read Level (dBμV)	Factor (dB)	Level (dBμV/m)	Limit (dBμV/m)	Margin (dB)	Polarization
5650.00	61.29	-6.53	54.76	68.20	13.44	Vertical
5700.00	61.24	-6.49	54.75	105.20	50.45	Vertical
5720.00	73.67	-6.26	67.41	110.80	43.39	Vertical
5725.00	80.98	-6.20	74.78	122.20	47.42	Vertical
11490.00	51.08	2.44	53.52	74.00	20.48	Vertical
5650.00	60.75	-6.53	54.22	68.20	13.98	Horizontal
5700.00	61.47	-6.49	54.98	105.20	50.22	Horizontal
5720.00	77.86	-6.26	71.60	110.80	39.20	Horizontal
5725.00	86.23	-6.20	80.03	122.20	42.17	Horizontal
11490.00	48.65	2.44	51.09	74.00	22.91	Horizontal
Detector: Average Value						
Frequency (MHz)	Read Level (dBμV)	Factor (dB)	Level (dBμV/m)	Limit (dBμV/m)	Margin (dB)	Polarization
11490.00	41.72	2.44	44.16	54.00	9.84	Vertical
11490.00	40.22	2.44	42.66	54.00	11.34	Horizontal
Test channel: Middle channel						
Detector: Peak Value						
Frequency (MHz)	Read Level (dBμV)	Factor (dB)	Level (dBμV/m)	Limit (dBμV/m)	Margin (dB)	Polarization
11570.00	50.64	3.02	53.66	74.00	20.34	Vertical
11570.00	48.65	3.02	51.67	74.00	22.33	Horizontal
Detector: Average Value						
Frequency (MHz)	Read Level (dBμV)	Factor (dB)	Level (dBμV/m)	Limit (dBμV/m)	Margin (dB)	Polarization
11570.00	40.64	3.02	43.66	54.00	10.34	Vertical
11570.00	48.68	3.02	51.70	54.00	2.30	Horizontal
Remark:						
1. Level = Reading + Factor.						
2. Test Frequency up to 40GHz, and the emission levels of other frequencies are lower than the limit 20dB, not show in test report.						

Test channel: Highest channel						
Detector: Peak Value						
Frequency (MHz)	Read Level (dB μ V)	Factor (dB)	Level (dB μ V/m)	Limit (dB μ V/m)	Margin (dB)	Polarization
5850.00	72.46	-5.49	66.97	122.20	55.23	Vertical
5855.00	62.70	-5.51	57.19	110.80	53.61	Vertical
5875.00	59.68	-5.60	54.08	105.20	51.12	Vertical
5925.00	59.54	-5.61	53.93	68.20	14.27	Vertical
11650.00	50.54	2.24	52.78	74.00	21.22	Vertical
5850.00	76.06	-5.49	70.57	122.20	51.63	Horizontal
5855.00	73.70	-5.51	68.19	110.80	42.61	Horizontal
5875.00	59.03	-5.60	53.43	105.20	51.77	Horizontal
5925.00	60.22	-5.61	54.61	68.20	13.59	Horizontal
11650.00	47.87	2.24	50.11	74.00	23.89	Horizontal
Detector: Average Value						
Frequency (MHz)	Read Level (dB μ V)	Factor (dB)	Level (dB μ V/m)	Limit (dB μ V/m)	Margin (dB)	Polarization
11650.00	48.54	2.24	50.78	54.00	3.22	Vertical
11650.00	48.32	2.24	50.56	54.00	3.44	Horizontal
Remark:						
1. Level = Reading + Factor.						
2. Test Frequency up to 40GHz, and the emission levels of other frequencies are lower than the limit 20dB, not show in test report.						

Band 4: 5725 MHz - 5825 MHz, 802.11n-HT20						
Test channel: Lowest channel						
Detector: Peak Value						
Frequency (MHz)	Read Level (dBμV)	Factor (dB)	Level (dBμV/m)	Limit (dBμV/m)	Margin (dB)	Polarization
5650.00	61.23	-6.53	54.70	68.20	13.50	Vertical
5700.00	61.28	-6.49	54.79	105.20	50.41	Vertical
5720.00	73.78	-6.26	67.52	110.80	43.28	Vertical
5725.00	81.48	-6.20	75.28	122.20	46.92	Vertical
11490.00	51.04	2.44	53.48	74.00	20.52	Vertical
5650.00	60.87	-6.53	54.34	68.20	13.86	Horizontal
5700.00	63.20	-6.49	56.71	105.20	48.49	Horizontal
5720.00	79.15	-6.26	72.89	110.80	37.91	Horizontal
5725.00	86.24	-6.20	80.04	122.20	42.16	Horizontal
11490.00	40.23	2.44	42.67	74.00	31.33	Horizontal
Detector: Average Value						
Frequency (MHz)	Read Level (dBμV)	Factor (dB)	Level (dBμV/m)	Limit (dBμV/m)	Margin (dB)	Polarization
11490.00	41.75	2.44	44.19	54.00	9.81	Vertical
11490.00	39.34	2.44	41.78	54.00	12.22	Horizontal
Test channel: Middle channel						
Detector: Peak Value						
Frequency (MHz)	Read Level (dBμV)	Factor (dB)	Level (dBμV/m)	Limit (dBμV/m)	Margin (dB)	Polarization
11570.00	50.48	3.02	53.50	74.00	20.50	Vertical
11570.00	48.40	3.02	51.42	74.00	22.58	Horizontal
Detector: Average Value						
Frequency (MHz)	Read Level (dBμV)	Factor (dB)	Level (dBμV/m)	Limit (dBμV/m)	Margin (dB)	Polarization
11570.00	40.85	3.02	43.87	54.00	10.13	Vertical
11570.00	40.23	3.02	43.25	54.00	10.75	Horizontal
Remark:						
1. Level = Reading + Factor.						
2. Test Frequency up to 40GHz, and the emission levels of other frequencies are lower than the limit 20dB, not show in test report.						

Test channel: Highest channel						
Detector: Peak Value						
Frequency (MHz)	Read Level (dB μ V)	Factor (dB)	Level (dB μ V/m)	Limit (dB μ V/m)	Margin (dB)	Polarization
5850.00	71.38	-5.49	65.89	122.20	56.31	Vertical
5855.00	68.08	-5.51	62.57	110.80	48.23	Vertical
5875.00	59.66	-5.60	54.06	105.20	51.14	Vertical
5925.00	59.94	-5.61	54.33	68.20	13.87	Vertical
11650.00	50.33	2.24	52.57	74.00	21.43	Vertical
5850.00	71.38	-5.49	65.89	122.20	56.31	Horizontal
5855.00	68.08	-5.51	62.57	110.80	48.23	Horizontal
5875.00	59.66	-5.60	54.06	105.20	51.14	Horizontal
5925.00	59.94	-5.61	54.33	68.20	13.87	Horizontal
11650.00	48.26	2.24	50.50	74.00	23.50	Horizontal
Detector: Average Value						
Frequency (MHz)	Read Level (dB μ V)	Factor (dB)	Level (dB μ V/m)	Limit (dB μ V/m)	Margin (dB)	Polarization
11650.00	41.74	2.24	43.98	54.00	10.02	Vertical
11650.00	40.24	2.24	42.48	54.00	11.52	Horizontal
Remark:						
1. Level = Reading + Factor.						
2. Test Frequency up to 40GHz, and the emission levels of other frequencies are lower than the limit 20dB, not show in test report.						

Band 4: 5725 MHz - 5825 MHz, 802.11n-HT40						
Test channel: Lowest channel						
Detector: Peak Value						
Frequency (MHz)	Read Level (dBμV)	Factor (dB)	Level (dBμV/m)	Limit (dBμV/m)	Margin (dB)	Polarization
5650.00	60.19	-6.53	53.66	68.20	14.54	Vertical
5700.00	71.42	-6.49	64.93	105.20	40.27	Vertical
5720.00	82.94	-6.26	76.68	110.80	34.12	Vertical
5725.00	86.79	-6.20	80.59	122.20	41.61	Vertical
11510.00	51.07	2.63	53.70	74.00	20.30	Vertical
5650.00	60.20	-6.53	53.67	68.20	14.53	Horizontal
5700.00	75.49	-6.49	69.00	105.20	36.20	Horizontal
5720.00	87.51	-6.26	81.25	110.80	29.55	Horizontal
5725.00	90.20	-6.20	84.00	122.20	38.20	Horizontal
11510.00	48.64	2.63	51.27	74.00	22.73	Horizontal
Detector: Average Value						
Frequency (MHz)	Read Level (dBμV)	Factor (dB)	Level (dBμV/m)	Limit (dBμV/m)	Margin (dB)	Polarization
11510.00	41.71	2.63	44.34	54.00	9.66	Vertical
11510.00	40.22	2.63	42.85	54.00	11.15	Horizontal
Test channel: Highest channel						
Detector: Peak Value						
Frequency (MHz)	Read Level (dBμV)	Factor (dB)	Level (dBμV/m)	Limit (dBμV/m)	Margin (dB)	Polarization
5850.00	70.56	-5.49	65.07	122.20	57.13	Vertical
5855.00	64.80	-5.51	59.29	110.80	51.51	Vertical
5875.00	58.60	-5.60	53.00	105.20	52.20	Vertical
5925.00	58.64	-5.61	53.03	68.20	15.17	Vertical
11590.00	41.72	3.10	44.82	74.00	29.18	Vertical
5850.00	72.98	-5.49	67.49	122.20	54.71	Horizontal
5855.00	70.22	-5.51	64.71	110.80	46.09	Horizontal
5875.00	62.13	-5.60	56.53	105.20	48.67	Horizontal
5925.00	59.36	-5.61	53.75	68.20	14.45	Horizontal
11590.00	47.69	3.10	50.79	74.00	23.21	Horizontal
Detector: Average Value						
Frequency (MHz)	Read Level (dBμV)	Factor (dB)	Level (dBμV/m)	Limit (dBμV/m)	Margin (dB)	Polarization
11590.00	41.73	3.10	44.83	54.00	9.17	Vertical
11590.00	40.21	3.10	43.31	54.00	10.69	Horizontal
Remark:						
1. Level = Reading + Factor.						
2. Test Frequency up to 40GHz, and the emission levels of other frequencies are lower than the limit 20dB, not show in test report.						

Band 4: 5725 MHz - 5825 MHz, 8802.11ac-VHT20						
Test channel: Lowest channel						
Detector: Peak Value						
Frequency (MHz)	Read Level (dB μ V)	Factor (dB)	Level (dB μ V/m)	Limit (dB μ V/m)	Margin (dB)	Polarization
5650.00	61.18	-6.53	54.65	68.20	13.55	Vertical
5700.00	61.08	-6.49	54.59	105.20	50.61	Vertical
5720.00	73.54	-6.26	67.28	110.80	43.52	Vertical
5725.00	81.19	-6.20	74.99	122.20	47.21	Vertical
11490.00	50.77	2.44	53.21	74.00	20.79	Vertical
5650.00	60.81	-6.53	54.28	68.20	13.92	Horizontal
5700.00	62.98	-6.49	56.49	105.20	48.71	Horizontal
5720.00	79.14	-6.26	72.88	110.80	37.92	Horizontal
5725.00	86.24	-6.20	80.04	122.20	42.16	Horizontal
11490.00	40.20	2.44	42.64	74.00	31.36	Horizontal
Detector: Average Value						
Frequency (MHz)	Read Level (dB μ V)	Factor (dB)	Level (dB μ V/m)	Limit (dB μ V/m)	Margin (dB)	Polarization
11490.00	41.67	2.44	44.11	54.00	9.89	Vertical
11490.00	39.14	2.44	41.58	54.00	12.42	Horizontal
Test channel: Middle channel						
Detector: Peak Value						
Frequency (MHz)	Read Level (dB μ V)	Factor (dB)	Level (dB μ V/m)	Limit (dB μ V/m)	Margin (dB)	Polarization
11570.00	50.41	3.02	53.43	74.00	20.57	Vertical
11570.00	48.39	3.02	51.41	74.00	22.59	Horizontal
Detector: Average Value						
Frequency (MHz)	Read Level (dB μ V)	Factor (dB)	Level (dB μ V/m)	Limit (dB μ V/m)	Margin (dB)	Polarization
11570.00	41.73	3.02	44.75	54.00	9.25	Vertical
11570.00	39.23	3.02	42.25	54.00	11.75	Horizontal
Remark:						
1. Level = Reading + Factor.						
2. Test Frequency up to 40GHz, and the emission levels of other frequencies are lower than the limit 20dB, not show in test report.						

Test channel: Highest channel						
Detector: Peak Value						
Frequency (MHz)	Read Level (dBμV)	Factor (dB)	Level (dBμV/m)	Limit (dBμV/m)	Margin (dB)	Polarization
5850.00	71.14	-5.49	65.65	122.20	56.55	Vertical
5855.00	68.07	-5.51	62.56	110.80	48.24	Vertical
5875.00	59.63	-5.60	54.03	105.20	51.17	Vertical
5925.00	59.89	-5.61	54.28	68.20	13.92	Vertical
11650.00	50.15	2.24	52.39	74.00	21.61	Vertical
5850.00	71.10	-5.49	65.61	122.20	56.59	Horizontal
5855.00	67.98	-5.51	62.47	110.80	48.33	Horizontal
5875.00	59.61	-5.60	54.01	105.20	51.19	Horizontal
5925.00	59.84	-5.61	54.23	68.20	13.97	Horizontal
11650.00	48.08	2.24	50.32	74.00	23.68	Horizontal
Detector: Average Value						
Frequency (MHz)	Read Level (dBμV)	Factor (dB)	Level (dBμV/m)	Limit (dBμV/m)	Margin (dB)	Polarization
11650.00	41.67	2.24	43.91	54.00	10.09	Vertical
11650.00	39.21	2.24	41.45	54.00	12.55	Horizontal
Remark:						
1. Level = Reading + Factor.						
2. Test Frequency up to 40GHz, and the emission levels of other frequencies are lower than the limit 20dB, not show in test report.						

Band 4: 5725 MHz - 5825 MHz, 802.11ac-VHT40						
Test channel: Lowest channel						
Detector: Peak Value						
Frequency (MHz)	Read Level (dBμV)	Factor (dB)	Level (dBμV/m)	Limit (dBμV/m)	Margin (dB)	Polarization
5650.00	60.16	-6.53	53.17	68.20	15.03	Vertical
5700.00	71.47	-6.49	64.74	105.20	40.46	Vertical
5720.00	82.94	-6.26	76.62	110.80	34.18	Vertical
5725.00	86.73	-6.20	80.12	122.20	42.08	Vertical
11510.00	51.02	2.63	52.98	74.00	21.02	Vertical
5650.00	60.21	-6.53	53.35	68.20	14.85	Horizontal
5700.00	75.44	-6.49	68.84	105.20	36.36	Horizontal
5720.00	87.53	-6.26	81.24	110.80	29.56	Horizontal
5725.00	90.50	-6.20	83.94	122.20	38.26	Horizontal
11510.00	48.65	2.63	51.07	74.00	22.93	Horizontal
Detector: Average Value						
Frequency (MHz)	Read Level (dBμV)	Factor (dB)	Level (dBμV/m)	Limit (dBμV/m)	Margin (dB)	Polarization
11510.00	41.72	2.63	44.05	54.00	9.95	Vertical
11510.00	40.34	2.63	42.27	54.00	11.73	Horizontal
Test channel: Highest channel						
Detector: Peak Value						
Frequency (MHz)	Read Level (dBμV)	Factor (dB)	Level (dBμV/m)	Limit (dBμV/m)	Margin (dB)	Polarization
5850.00	70.65	-5.49	64.95	122.20	57.25	Vertical
5855.00	64.76	-5.51	59.06	110.80	51.74	Vertical
5875.00	58.77	-5.60	52.75	105.20	52.45	Vertical
5925.00	58.68	-5.61	52.72	68.20	15.48	Vertical
11590.00	41.74	3.10	53.67	74.00	20.33	Vertical
5850.00	72.96	-5.49	67.31	122.20	54.89	Horizontal
5855.00	70.24	-5.51	64.47	110.80	46.33	Horizontal
5875.00	62.16	-5.60	56.49	105.20	48.71	Horizontal
5925.00	59.37	-5.61	53.25	68.20	14.95	Horizontal
11590.00	47.65	3.10	50.90	74.00	23.10	Horizontal
Detector: Average Value						
Frequency (MHz)	Read Level (dBμV)	Factor (dB)	Level (dBμV/m)	Limit (dBμV/m)	Margin (dB)	Polarization
11590.00	41.75	3.10	43.94	54.00	10.06	Vertical
11590.00	40.27	3.10	42.49	54.00	11.51	Horizontal
Remark:						
1. Level = Reading + Factor.						
2. Test Frequency up to 40GHz, and the emission levels of other frequencies are lower than the limit 20dB, not show in test report.						

Band 4: 5725 MHz - 5825 MHz, 802.11ac-VHT80						
Test channel: Lowest channel						
Detector: Peak Value						
Frequency (MHz)	Read Level (dBμV)	Factor (dB)	Level (dBμV/m)	Limit (dBμV/m)	Margin (dB)	Polarization
5650.00	62.49	-6.53	55.96	68.20	12.24	Vertical
5700.00	76.3	-6.49	69.81	105.20	35.39	Vertical
5720.00	80.48	-6.26	74.22	110.80	36.58	Vertical
5725.00	81.87	-6.20	75.67	122.20	46.53	Vertical
5850.00	75.56	-5.49	70.07	122.20	52.13	Vertical
5855.00	74.1	-5.51	68.59	110.80	42.21	Vertical
5875.00	67.26	-5.60	61.66	105.20	43.54	Vertical
5925.00	59.86	-5.61	54.25	68.20	13.95	Vertical
11550.00	51.07	2.95	54.02	74.00	19.98	Vertical
5650.00	65.19	-6.53	58.66	68.20	9.54	Horizontal
5700.00	80.69	-6.49	74.20	105.20	31.00	Horizontal
5720.00	83.99	-6.26	77.73	110.80	33.07	Horizontal
5725.00	87.69	-6.20	81.49	122.20	40.71	Horizontal
5850.00	79.95	-5.49	74.46	122.20	47.74	Horizontal
5855.00	75.94	-5.51	70.43	110.80	40.37	Horizontal
5875.00	71.15	-5.60	65.55	105.20	39.65	Horizontal
5925.00	61.22	-5.61	55.61	68.20	12.59	Horizontal
11550.00	48.68	2.95	51.63	74.00	22.37	Horizontal
Detector: Average Value						
Frequency (MHz)	Read Level (dBμV)	Factor (dB)	Level (dBμV/m)	Limit (dBμV/m)	Margin (dB)	Polarization
11550.00	40.34	2.95	43.29	54.00	10.71	Vertical
11550.00	40.32	2.95	43.27	54.00	10.73	Horizontal
Remark:						
1. <i>Level = Reading + Factor.</i>						
2. <i>Test Frequency up to 40GHz, and the emission levels of other frequencies are lower than the limit 20dB, not show in test report.</i>						

-----End of report-----