



# FCC REPORT

Report Reference No..... : **CHEW20070045** Report Verification: 

Project No..... : **SHT2006119501EW**

FCC ID..... : **2AWTR-03202921**

Applicant's name..... : **Philips Goldway(Shenzhen) Industrial Inc.**

Address..... : No.2 Keji North 3rd Road, Nanshan District, 518057, Shenzhen, China

Manufacturer..... : Philips Goldway(Shenzhen) Industrial Inc.

Address..... : No.2 Keji North 3rd Road, Nanshan District, 518057, Shenzhen, China

Test item description ..... : **Wireless Communication Module**

Trade Mark ..... : PHILIPS

Model/Type reference..... : 989803202921

Listed Model(s) ..... : -

Standard ..... : **FCC CFR Title 47 Part 2  
FCC CFR Title 47 Part 22  
FCC CFR Title 47 Part 24**

Date of receipt of test sample..... : Jun. 28, 2020

Date of testing..... : Jun. 29, 2020- Jul. 08, 2020

Date of issue..... : Jul. 09, 2020

Result..... : **Pass**

Compiled by  
( position+printedname+signature).... : File administrators Silvia Li 

Supervised by  
(position+printedname+signature)..... : Project Engineer Chengxiao 

Approved by  
(position+printedname+signature)..... : Manager Hans Hu 

Testing Laboratory Name ..... : **Shenzhen Huatongwei International Inspection Co., Ltd.**

Address..... : 1/F, Bldg 3, Hongfa Hi-tech Industrial Park, Genyu Road, Tianliao, Gongming, Shenzhen, China

**Shenzhen Huatongwei International Inspection Co., Ltd. All rights reserved.**

This publication may be reproduced in whole or in part for non-commercial purposes as long as the Shenzhen Huatongwei International Inspection Co., Ltd. is acknowledged as copyright owner and source of the material. Shenzhen Huatongwei International Inspection Co., Ltd. takes no responsibility for and will not assume liability for damages resulting from the reader's interpretation of the reproduced material due to its placement and context.

*The test report merely correspond to the test sample.*

## Contents

<b>1.</b>	<b><u>TEST STANDARDS AND REPORT VERSION</u></b>	<b>3</b>
1.1.	Applicable Standards	3
1.2.	Report version information	3
<b>2.</b>	<b><u>TEST DESCRIPTION</u></b>	<b>4</b>
<b>3.</b>	<b><u>SUMMARY</u></b>	<b>5</b>
3.1.	Client Information	5
3.2.	Product Description	5
3.3.	Operation state	6
3.4.	EUT configuration	6
3.5.	Modifications	6
<b>4.</b>	<b><u>TEST ENVIRONMENT</u></b>	<b>7</b>
4.1.	Address of the test laboratory	7
4.2.	Test Facility	7
4.3.	Equipments Used during the Test	8
4.4.	Environmental conditions	9
4.5.	Statement of the measurement uncertainty	9
<b>5.</b>	<b><u>TEST CONDITIONS AND RESULTS</u></b>	<b>10</b>
5.1.	Conducted Output Power	10
5.2.	Peak-Average Ratio	11
5.3.	99% Occupied Bandwidth & 26 dB Bandwidth	12
5.4.	Modulation characteristics	13
5.5.	Band Edge	14
5.6.	Conducted Spurious Emissions	15
5.7.	Frequency stability VS Temperature measurement	16
5.8.	Frequency stability VS Voltage measurement	17
5.9.	ERP and EIRP	18
5.10.	Radiated Spurious Emission	21
<b>6.</b>	<b><u>APPENDIX REPORT</u></b>	<b>25</b>

# 1. TEST STANDARDS AND REPORT VERSION

## 1.1. Applicable Standards

The tests were performed according to following standards:

[FCC Rules Part 2](#): FREQUENCY ALLOCATIONS AND RADIO TREATY MATTERS; GENERAL RULES AND REGULATIONS

[FCC Rules Part 22](#): PUBLIC MOBILE SERVICES

[FCC Rules Part 24](#): PERSONAL COMMUNICATIONS SERVICES

[TIA/EIA 603 E March 2016](#): Land Mobile FM or PM Communications Equipment Measurement and Performance Standards.

[ANSI C63.26: 2015](#): American National Standard for Compliance Testing of Transmitters Used in Licensed Radio Services

[KDB 971168 D01 Power Meas License Digital Systems v03](#): MEASUREMENT GUIDANCE FOR CERTIFICATION OF LICENSED DIGITAL TRANSMITTERS

## 1.2. Report version information

Revision No.	Date of issue	Description
N/A	2020-07-09	Original

## 2. Test Description

Test Item	Section in CFR 47	Result	Test Engineer
Conducted Output Power	Part 2.1046 Part 22.913(a) Part 24.232(c)	Pass	Jiongsheng . Feng
Peak-to-Average Ratio	Part 24.232	Pass	Jiongsheng . Feng
99% Occupied Bandwidth & 26 dB Bandwidth	Part 2.1049 Part 22.917(b) Part 24.238(b)	Pass	Jiongsheng . Feng
Modulation characteristics	Part 2.1047	Pass	Jiongsheng . Feng
Band Edge	Part 2.1051 Part 22.917 Part 24.238	Pass	Jiongsheng . Feng
Conducted Spurious Emissions	Part 2.1051 Part 22.917 Part 24.238	Pass	Jiongsheng . Feng
Frequency stability vs temperature	Part 2.1055(a)(1)(b) Part 22.355 Part 24.235	Pass	Jiongsheng . Feng
Frequency stability vs voltage	Part 2.1055(d)(1)(2) Part 22.355 Part 24.235	Pass	Jiongsheng . Feng
ERP and EIRP	Part 22.913(a) Part 24.232(b)	Pass	pan.xie
Radiated Spurious Emissions	Part 2.1053 Part 22.917 Part 24.238	Pass	pan.xie

Note: The measurement uncertainty is not included in the test result.

### 3. SUMMARY

#### 3.1. Client Information

Applicant:	Philips Goldway(Shenzhen) Industrial Inc.
Address:	No.2 Keji North 3rd Road, Nanshan District, 518057, Shenzhen, China
Manufacturer:	Philips Goldway(Shenzhen) Industrial Inc.
Address:	No.2 Keji North 3rd Road, Nanshan District, 518057, Shenzhen, China

#### 3.2. Product Description

Name of EUT:	Wireless Communication Module
Trade Mark:	PHILIPS
Model No.:	989803202921
Listed Model(s):	-
Power supply:	9-18V-+5% DC, Max 1.5A, normal Voltage DC12V
Adapter information:	-
Hardware version:	1930
Software version:	23.60, A01.01
<b>3G:</b>	
Operation Band:	FDD Band II, FDD Band V
Power Class:	Class 3
Modulation Type:	QPSK
Transmit frequency:	FDD Band II: 1852.40MHz~1907.60MHz FDD Band V: 826.40MHz~846.60MHz
Receive frequency:	FDD Band II: 1932.40MHz~1987.60MHz FDD Band V: 871.40MHz~891.60MHz
Antenna type:	TBC Antenna
Antenna gain:	Band II: 3.23dBi Band V: 3.19dBi

### 3.3. Operation state

#### ➤ Test frequency list

FDD Band II		FDD Band V	
Channel	Frequency (MHz)	Channel	Frequency (MHz)
9262	1852.40	4132	826.40
9400	1880.00	4183	836.60
9538	1907.60	4233	846.60

#### ➤ Test mode

Antenna port conducted and radiated test items were performed according to KDB 971168 D01 Power Meas. License Digital Systems v03 and ANSI C63.26-2015 with maximum output power.

Radiated measurements were performed with rotating EUT in different three orthogonal test planes to find the maximum emission.

Radiated emissions were investigated as following frequency range:

30 MHz to 10th harmonic for FDD Band II, Band V.

All modes and data rates and positions were investigated.

Test modes are chosen to be reported as the worst case configuration below:

Test modes		
Band	Radiated	Conducted
WCDMA Band V	■ RMC 12.2Kbps Link	■ RMC 12.2Kbps Link
WCDMA Band II	■ RMC 12.2Kbps Link	■ RMC 12.2Kbps Link

### 3.4. EUT configuration

The following peripheral devices and interface cables were connected during the measurement:

- - supplied by the manufacturer
- - supplied by the lab

○ /	Manufacturer:	/
	Model No.:	/
○ /	Manufacturer:	/
	Model No.:	/

### 3.5. Modifications

No modifications were implemented to meet testing criteria.

## **4. TEST ENVIRONMENT**

### **4.1. Address of the test laboratory**

Laboratory: Shenzhen Huatongwei International Inspection Co., Ltd.

Address: 1/F, Bldg 3, Hongfa Hi-tech Industrial Park, Genyu Road, Tianliao, Gongming, Shenzhen, China.

### **4.2. Test Facility**

#### **CNAS-Lab Code: L1225**

Shenzhen Huatongwei International Inspection Co., Ltd. has been assessed and proved to be in compliance with CNAS-CL01 Accreditation Criteria for Testing and Calibration Laboratories (identical to ISO/IEC17025: 2005 General Requirements) for the Competence of Testing and Calibration Laboratories.

#### **A2LA-Lab Cert. No.: 3902.01**

Shenzhen Huatongwei International Inspection Co., Ltd. EMC Laboratory has been accredited by A2LA for technical competence in the field of electrical testing, and proved to be in compliance with ISO/IEC 17025: 2005 General Requirements for the Competence of Testing and Calibration Laboratories and any additional program requirements in the identified field of testing.

#### **FCC-Registration No.: 762235**

Shenzhen Huatongwei International Inspection Co., Ltd. EMC Laboratory has been registered and fully described in a report filed with the FCC (Federal Communications Commission). The acceptance letter from the FCC is maintained in our files.

#### **IC-Registration No.:5377A**

Two 3m Alternate Test Site of Shenzhen Huatongwei International Inspection Co., Ltd. has been registered by Certification and Engineering Bureau of Industry Canada for the performance of radiated measurements with Registration No.: 5377A.

#### **ACA**

Shenzhen Huatongwei International Inspection Co., Ltd. EMC Laboratory can also perform testing for the Australian C-Tick mark as a result of our A2LA accreditation.

### 4.3. Equipments Used during the Test

Used	Test Equipment	Manufacturer	Equipment No.	Model No.	Serial No.	Last Cal. Date (YY-MM-DD)	Next Cal. Date (YY-MM-DD)
●	Signal and spectrum Analyzer	R&S	HTWE0242	FSV40	100048	2019/10/26	2020/10/25
●	Spectrum Analyzer	Agilent	HTWE0286	N9020A	MY50510187	2019/10/26	2020/10/25
●	Radio communication tester	R&S	HTWE0287	CMW500	137688-Lv	2019/10/26	2020/10/25
●	Test software	Tonscend	N/A	JS1120	N/A	N/A	N/A

#### ● Radiated Spurious Emission

Used	Test Equipment	Manufacturer	Equipment No.	Model No.	Serial No.	Last Cal. Date (YY-MM-DD)	Next Cal. Date (YY-MM-DD)
●	Semi-Anechoic Chamber	Albatross projects	HTWE0122	SAC-3m-01	N/A	2018/09/27	2021/09/26
●	Spectrum Analyzer	R&S	HTWE0098	FSP40	100597	2019/10/26	2020/10/25
●	Loop Antenna	R&S	HTWE0170	HFH2-Z2	100020	2018/04/02	2021/04/01
●	Broadband Horn Antenna	SCHWARZBECK	HTWE0103	BBHA9170	BBHA9170472	2018/10/11	2021/10/11
●	Ultra-Broadband Antenna	SCHWARZBECK	HTWE0123	VULB9163	538	2018/04/04	2021/04/03
●	Horn Antenna	SCHWARZBECK	HTWE0126	9120D	1011	2020/04/01	2023/03/31
●	Pre-amplifier	CD	HTWE0071	PAP-0102	12004	2019/11/14	2020/11/13
●	Broadband Preamplifier	SCHWARZBECK	HTWE0201	BBV 9718	9718-248	2020/05/23	2021/05/22
●	RF Connection Cable	HUBER+SUHNER	HTWE0120-01	6m 18GHz S Serisa	N/A	2020/05/18	2021/05/17
●	RF Connection Cable	HUBER+SUHNER	HTWE0120-02	6m 3GHz RG Serisa	N/A	2020/05/18	2021/05/17
●	RF Connection Cable	HUBER+SUHNER	HTWE0120-03	6m 3GHz RG Serisa	N/A	2020/05/18	2021/05/17
●	RF Connection Cable	HUBER+SUHNER	HTWE0120-04	6m 3GHz RG Serisa	N/A	2020/05/18	2021/05/17
●	RF Connection Cable	HUBER+SUHNER	HTWE0121-01	6m 18GHz S Serisa	N/A	2020/05/23	2021/05/22
●	EMI Test Software	Audix	N/A	E3	N/A	N/A	N/A

#### ● Auxiliary Equipment

Used	Test Equipment	Manufacturer	Equipment No.	Model No.	Serial No.	Last Cal. Date (YY-MM-DD)	Next Cal. Date (YY-MM-DD)
●	Climate chamber	ESPEC	HTWE0254	GPL-2	N/A	2019/10/23	2020/10/22
●	DC Power Supply	Gwinstek	HTWE0274	SPS-2415	GER835793	N/A	N/A



#### 4.4. Environmental conditions

During the measurement the environmental conditions were within the listed ranges:

Voltage	VN=Nominal Voltage	DC 12V
	VL=Lower Voltage	DC 10.8V
	VH=Higher Voltage	DC 13.2V
Temperature	TN=Normal Temperature	25 °C
	Extreme Temperature	From -0° to + 45° centigrade
Humidity	30~60 %	
Air Pressure	950-1050 hPa	

#### 4.5. Statement of the measurement uncertainty

The data and results referenced in this document are true and accurate. The reader is cautioned that there may be errors within the calibration limits of the equipment and facilities. The measurement uncertainty was calculated for all measurements listed in this test report acc. to TR-100028-01 "Electromagnetic compatibility and Radio spectrum Matters (ERM); Uncertainties in the measurement of mobile radio equipment characteristics; Part 1" and TR-100028-02 "Electromagnetic compatibility and Radio spectrum Matters (ERM); Uncertainties in the measurement of mobile radio equipment characteristics; Part 2" and is documented in the Shenzhen Huatongwei International Inspection Co., Ltd quality system acc. to DIN EN ISO/IEC 17025. Furthermore, component and process variability of devices similar to that tested may result in additional deviation. The manufacturer has the sole responsibility of continued compliance of the device.

Hereafter the best measurement capability for Shenzhen Huatongwei laboratory is reported:

Test Items	Measurement Uncertainty	Notes
Transmitter power conducted	0.51 dB	(1)
Transmitter power Radiated	2.66dB for <1GHz 3.44dB for >1GHz	(1)
Conducted spurious emissions 9kHz~40GHz	0.51 dB	(1)
Radiated spurious emissions	2.66dB for <1GHz 3.44dB for >1GHz	(1)
Occupied Bandwidth	15Hz for <1GHz 70Hz for >1GHz	(1)
Frequency error	15Hz for <1GHz 70Hz for >1GHz	(1)

(1) This uncertainty represents an expanded uncertainty expressed at approximately the 95% confidence level using a coverage factor of  $k=1.96$ .

## 5. TEST CONDITIONS AND RESULTS

### 5.1. Conducted Output Power

**LIMIT**

N/A

**TEST CONFIGURATION****TEST PROCEDURE**

1. The EUT output port was connected to communication tester.
2. Set EUT at maximum power through communication tester.
3. Select lowest, middle, and highest channels for each band and different modulation.
4. Measure the maximum burst average power.

**TEST MODE:**

Please refer to the clause 3.3

**TEST RESULTS** **Passed**       **Not Applicable**

Refer to appendix A on the section 8 appendix report

## 5.2. Peak-Average Ratio

### LIMIT

13dB

### TEST CONFIGURATION



### TEST PROCEDURE

1. The EUT was connected to the spectrum analyzer and communication tester via a power splitter
2. Set EUT in maximum power output.
3. Center Frequency = Carrier frequency, RBW > Emission bandwidth of signal
4. The signal analyzer was set to collect one million samples to generate the CCDF curve
5. The measurement interval was set depending on the type of signal analyzed.
  - i. For continuous signals (>98% duty cycle), the measurement interval was set to 1ms.
  - ii. For burst transmissions, the spectrum analyzer is set to use an internal "RF Burst" trigger that is synced with an incoming pulse and the measurement interval is set to less than the duration of the "on time" of one burst to ensure that energy is only captured during a time in which the transmitter is operating at maximum power
6. Record the maximum PAPR level associated with a probability of 0.1%.

### TEST MODE:

Please refer to the clause 3.3

### TEST RESULTS

Passed       Not Applicable

Refer to appendix B on the section 8 appendix report

### 5.3. 99% Occupied Bandwidth & 26 dB Bandwidth

**LIMIT**

N/A

**TEST CONFIGURATION****TEST PROCEDURE**

1. The EUT was connected to the spectrum analyzer and communication tester via a power splitter
2. Set EUT in maximum power output.
3. Spectrum analyzer setting as follow:  
Center Frequency= Carrier frequency, RBW=1% to 5% of anticipated OBW, VBW= 3 \* RBW,  
Detector=Peak,  
Trace maximum hold.
4. Record the value of 99% Occupied bandwidth and -26dB bandwidth.

**TEST MODE:**

Please refer to the clause 3.3

**TEST RESULTS** **Passed**       **Not Applicable**

Refer to appendix C on the section 8 appendix report

## 5.4. Modulation characteristics

### LIMIT

Modulation limiting is the ability of a transmitter circuit to limit the transmitter from producing deviations in excess of a rated system deviation

### TEST CONFIGURATION

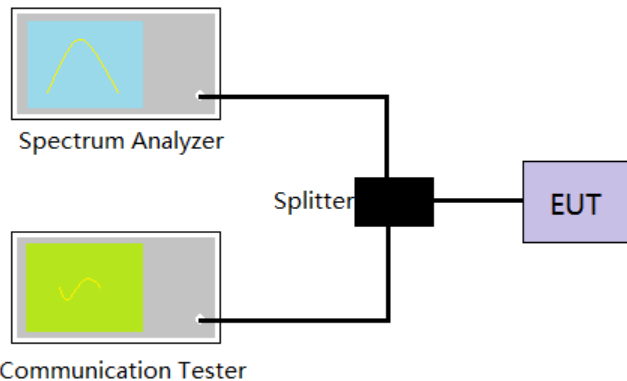

### TEST PROCEDURE

- Connect the equipment as illustrated in Figure 1.
- Adjust the transmitter per the manufacturer's procedure for full rated system deviation.
- Set the test receiver to measure peak positive deviation. Set the audio bandwidth for  $\leq 0.25$  Hz to  $\geq 15\ 000$  Hz. Turn the de-emphasis function off.
- Apply a 1000 Hz modulating signal to the transmitter from the audio frequency generator, and adjust the level to obtain 60% of full rated system deviation. This is the 0 dB reference level.
- Increase the level from the audio generator by 20 dB in 5 dB increments recording the deviation as measured from the test receiver in each step. Verify that the audio level used to make the OBW measurement is included in the sweep.
- Repeat for step e) at 300 Hz, 2500 Hz and 3000 Hz at a minimum using the 0 dB reference level obtained in step d).
- Set the test receiver to measure peak negative deviation and repeat step d) through step f).
- The values recorded in step f) and step g) are the modulation limiting.
- Plot the data set as a percentage of deviation relative to the 0 dB reference point versus input voltage.

### TEST MODE:

Please refer to the clause 3.3

### TEST RESULTS

Passed       Not Applicable

Refer to appendix G on the section 8 appendix report

## 5.5. Band Edge

### LIMIT

Part 24.238 and Part 22.917 specify that the power of any emission outside of the authorized operating frequency ranges must be attenuated below the transmitting power (P) by a factor of at least  $43 + 10 \log(P)$  dB.

The specification that emissions shall be attenuated below the transmitter power (P) by at least  $43 + 10 \log(P)$  dB, translates in the relevant power range (1 to 0.001 W) to -13 dBm. At 1 W the specified minimum attenuation becomes 43 dB and relative to a 30 dBm (1 W) carrier becomes a limit of -13 dBm. At 0.001 W (0 dBm) the minimum attenuation is 13 dB, which again yields a limit of -13 dBm. In this way a translation of the specification from relative to absolute terms is carried out.

### TEST CONFIGURATION



### TEST PROCEDURE

1. The EUT was connected to the spectrum analyzer and communication tester via a power splitter
2. Set EUT in maximum power output.
3. The band edges of low and high channels were measured.
4. Spectrum analyzer setting as follow:  
RBW=100KHz, VBW = 300KHz, Sweep time= Auto
5. Record the test plot.

### TEST MODE:

Please refer to the clause 3.3

### TEST RESULTS

Passed       Not Applicable

Refer to appendix D on the section 8 appendix report

## 5.6. Conducted Spurious Emissions

### LIMIT

Part 24.238 and Part 22.917 specify that the power of any emission outside of the authorized operating frequency ranges must be attenuated below the transmitting power (P) by a factor of at least  $43 + 10 \log(P)$  dB.

The specification that emissions shall be attenuated below the transmitter power (P) by at least  $43 + 10 \log(P)$  dB, translates in the relevant power range (1 to 0.001 W) to -13 dBm. At 1 W the specified minimum attenuation becomes 43 dB and relative to a 30 dBm (1 W) carrier becomes a limit of -13 dBm. At 0.001 W (0 dBm) the minimum attenuation is 13 dB, which again yields a limit of -13 dBm. In this way a translation of the specification from relative to absolute terms is carried out.

### TEST CONFIGURATION

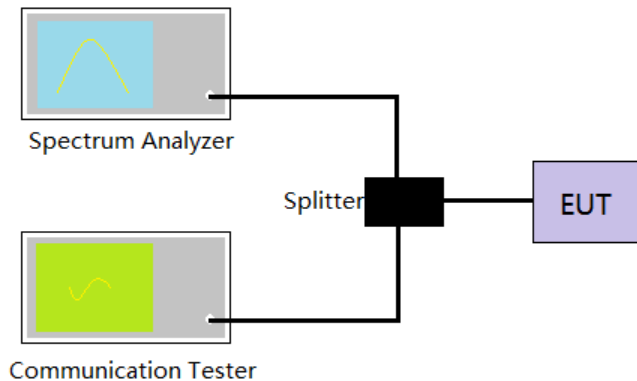

### TEST PROCEDURE

1. The EUT was connected to the spectrum analyzer and communication tester via a power splitter
2. Set EUT in maximum power output.
3. Spectrum analyzer setting as follow:  
Below 1GHz, RBW=100KHz, VBW = 300KHz, Detector=Peak, Sweep time= Auto  
Above 1GHz, RBW=1MHz, VBW=3MHz, Detector=Peak, Sweep time= Auto  
Scan frequency range up to 10<sup>th</sup> harmonic.
4. Record the test plot.

### TEST MODE:

Please refer to the clause 3.3

### TEST RESULTS

Passed       Not Applicable

Refer to appendix E on the section 8 appendix report

## 5.7. Frequency stability VS Temperature measurement

### LIMIT

2.5ppm

### TEST CONFIGURATION



### TEST PROCEDURE

1. The equipment under test was connected to an external DC power supply and input rated voltage.
2. The EUT output port was connected to communication tester.
3. The EUT was placed inside the temperature chamber.
4. Turn EUT off and set the chamber temperature to  $-30^{\circ}\text{C}$ . After the temperature stabilized for approximately 30 minutes recorded the frequency.
5. Repeat step 4 measure with  $10^{\circ}\text{C}$  increased per stage until the highest temperature of  $+50^{\circ}\text{C}$  reached.

### TEST MODE:

Please refer to the clause 3.3

### TEST RESULTS

Passed       Not Applicable

Refer to appendix F on the section 8 appendix report



## 5.8. Frequency stability VS Voltage measurement

### LIMIT

2.5ppm

### TEST CONFIGURATION

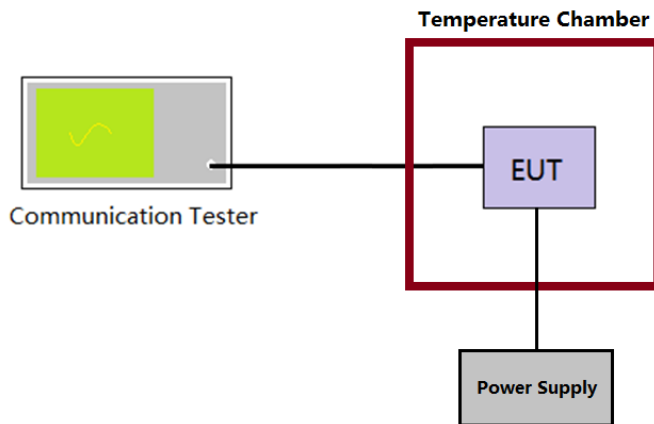

### TEST PROCEDURE

1. The equipment under test was connected to an external DC power supply and input rated voltage.
2. The EUT output port was connected to communication tester.
3. The EUT was placed inside the temperature chamber at 25°C
4. The power supply voltage to the EUT was varied  $\pm 15\%$  of the nominal value measured at the input to the EUT
5. Record the maximum frequency change.

### TEST MODE:

Please refer to the clause 3.3

### TEST RESULTS

Passed       Not Applicable

Refer to appendix F on the section 8 appendix report

## 5.9. ERP and EIRP

### LIMIT

WCDMA Band V: 7W (38.45dBm) ERP

WCDMA Band II: 2W (33dBm) EIRP

### TEST CONFIGURATION

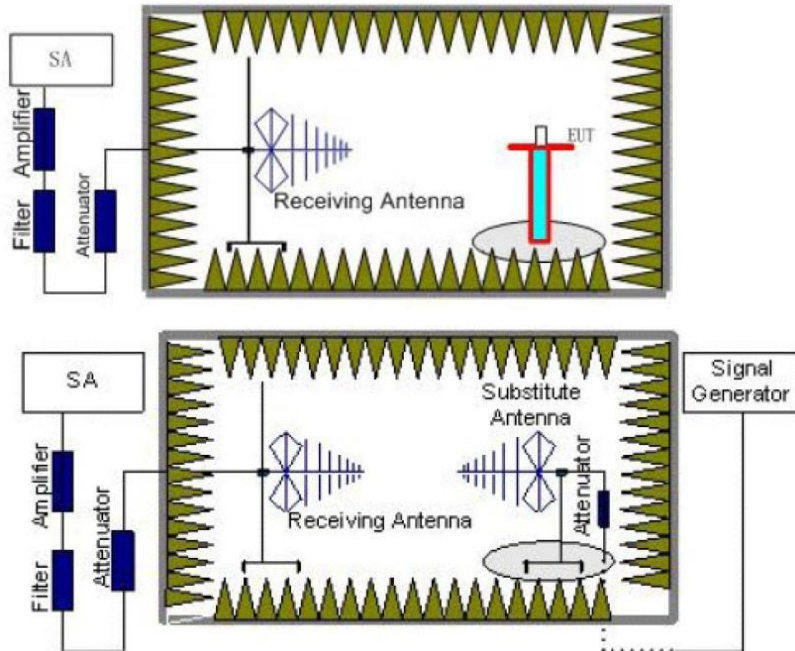

### TEST PROCEDURE

1. Place the EUT in the center of the turntable.
  - a) For radiated emissions measurements performed at frequencies less than or equal to 1 GHz, the EUT shall be placed on a RF-transparent table at a nominal height of 80 cm above the reference ground plane
  - b) For radiated measurements performed at frequencies above 1 GHz, the EUT shall be placed on an RF transparent table at a nominal height of 1.5 m above the ground plane.
2. Unless the EUT uses an integral antenna, the EUT shall be terminated with a non-radiating transmitter load. In cases where the EUT uses an adjustable antenna, the antenna shall be adjusted through typical positions and lengths to maximize emissions levels.
3. The EUT shall be tested while operating on the frequency per manufacturer specification. Set the transmitter to operate in continuous transmit mode.
4. Receiver or Spectrum set as follow:  
Below 1GHz, RBW=100kHz, VBW=300kHz, Detector=Peak, Sweep time=Auto  
Above 1GHz, RBW=1MHz, VBW=3MHz, Detector=Peck, Sweep time=Auto
5. Each emission under consideration shall be evaluated:
  - a) Raise and lower the measurement antenna from 1 m to 4 m, as necessary to enable detection of the maximum emission amplitude relative to measurement antenna height.
  - b) Rotate the EUT through 360° to determine the maximum emission level relative to the axial position.
  - c) Return the turntable to the azimuth where the highest emission amplitude level was observed.
  - d) Vary the measurement antenna height again through 1 m to 4 m again to find the height associated with the maximum emission amplitude.
  - e) Record the measured emission amplitude level and frequency
6. Repeat step 5 for each emission frequency with the measurement antenna oriented in both the horizontal and vertical polarizations to determine the orientation that gives the maximum emissions amplitude.
7. Set-up the substitution measurement with the reference point of the substitution antenna located as near as possible to where the center of the EUT radiating element was located during the initial EUT measurement.
8. Maintain the previous measurement instrument settings and test set-up, with the exception that the EUT is removed and replaced by the substitution antenna.
9. Connect a signal generator to the substitution antenna; locate the signal generator so as to minimize any

- potential influences on the measurement results. Set the signal generator to the frequency where emissions are detected, and set an output power level such that the radiated signal can be detected by the measurement instrument, with sufficient dynamic range relative to the noise floor.
10. For each emission that was detected and measured in the initial test
    - a) Vary the measurement antenna height between 1 m to 4 m to maximize the received (measured) signal amplitude.
    - b) Adjust the signal generator output power level until the amplitude detected by the measurement instrument equals the amplitude level of the emission previously measured directly in step 5 and step 6.
    - c) Record the output power level of the signal generator when equivalence is achieved in step b).
  11. Repeat step 8 through step 10 with the measurement antenna oriented in the opposite polarization.
  12. Calculate the emission power in dBm referenced to a half-wave dipole using the following equation:  
$$P_e = P_s(\text{dBm}) - \text{cable loss (dB)} + \text{antenna gain (dBd)}$$
where  
 $P_e$  = equivalent emission power in dBm  
 $P_s$  = source (signal generator) power in dBm  
*NOTE—dBd refers to the measured antenna gain in decibels relative to a half-wave dipole.*
  13. Correct the antenna gain of the substitution antenna if necessary to reference the emission power to a half-wave dipole. When using measurement antennas with the gain specified in dBi, the equivalent dipole-referenced gain can be determined from:  
$$\text{gain (dBd)} = \text{gain (dBi)} - 2.15 \text{ dB.}$$
If necessary, the antenna gain can be calculated from calibrated antenna factor information
  14. Provide the complete measurement results as a part of the test report.

**TEST MODE:**

Please refer to the clause 3.3

**TEST RESULTS**

**Passed**       **Not Applicable**

Mode	Channel	Antenna Pol.	EIRP	Limit (dBm)	Result
WCDMA Band II	9262	V	14.35	<33.00	Pass
		H	23.40		
	9400	V	14.29		
		H	22.66		
	9538	V	14.21		
		H	24.38		

Mode	Channel	Antenna Pol.	ERP	Limit (dBm)	Result
WCDMA Band V	4132	V	12.83	<38.45	Pass
		H	21.85		
	4183	V	14.11		
		H	21.90		
	4233	V	13.89		
		H	21.05		

## 5.10. Radiated Spurious Emission

### LIMIT

-13dBm

### TEST CONFIGURATION

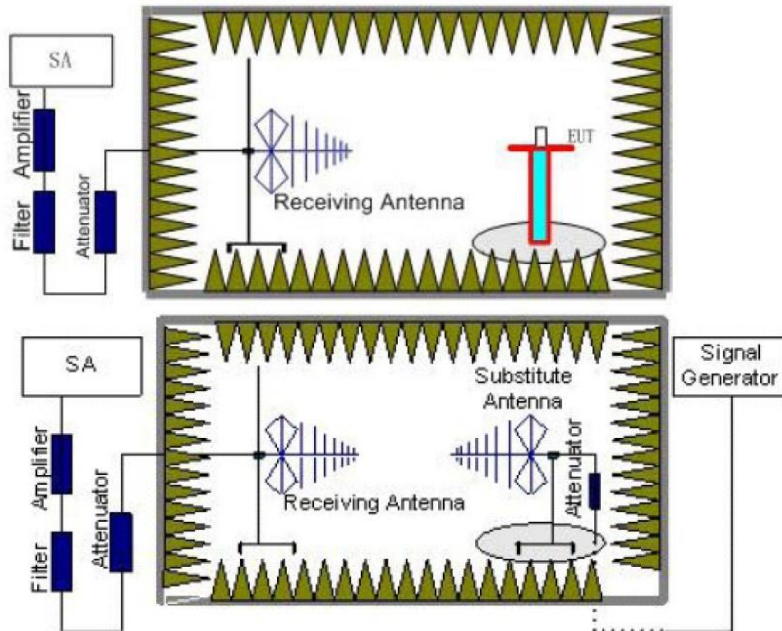

### TEST PROCEDURE

1. Place the EUT in the center of the turntable.
  - a) For radiated emissions measurements performed at frequencies less than or equal to 1 GHz, the EUT shall be placed on a RF-transparent table at a nominal height of 80 cm above the reference ground plane
  - b) For radiated measurements performed at frequencies above 1 GHz, the EUT shall be placed on an RF transparent table at a nominal height of 1.5 m above the ground plane.
2. Unless the EUT uses an integral antenna, the EUT shall be terminated with a non-radiating transmitter load. In cases where the EUT uses an adjustable antenna, the antenna shall be adjusted through typical positions and lengths to maximize emissions levels.
3. The EUT shall be tested while operating on the frequency per manufacturer specification. Set the transmitter to operate in continuous transmit mode.
4. Receiver or Spectrum set as follow:  
Below 1GHz, RBW=100kHz, VBW=300kHz, Detector=Peak, Sweep time=Auto  
Above 1GHz, RBW=1MHz, VBW=3MHz, Detector=Peck, Sweep time=Auto
5. Each emission under consideration shall be evaluated:
  - a) Raise and lower the measurement antenna from 1 m to 4 m, as necessary to enable detection of the maximum emission amplitude relative to measurement antenna height.
  - b) Rotate the EUT through 360° to determine the maximum emission level relative to the axial position.
  - c) Return the turntable to the azimuth where the highest emission amplitude level was observed.
  - d) Vary the measurement antenna height again through 1 m to 4 m again to find the height associated with the maximum emission amplitude.
  - e) Record the measured emission amplitude level and frequency
6. Repeat step 5 for each emission frequency with the measurement antenna oriented in both the horizontal and vertical polarizations to determine the orientation that gives the maximum emissions amplitude.
7. Set-up the substitution measurement with the reference point of the substitution antenna located as near as possible to where the center of the EUT radiating element was located during the initial EUT measurement.
8. Maintain the previous measurement instrument settings and test set-up, with the exception that the EUT is removed and replaced by the substitution antenna.
9. Connect a signal generator to the substitution antenna; locate the signal generator so as to minimize any

- potential influences on the measurement results. Set the signal generator to the frequency where emissions are detected, and set an output power level such that the radiated signal can be detected by the measurement instrument, with sufficient dynamic range relative to the noise floor.
10. For each emission that was detected and measured in the initial test
    - a) Vary the measurement antenna height between 1 m to 4 m to maximize the received (measured) signal amplitude.
    - b) Adjust the signal generator output power level until the amplitude detected by the measurement instrument equals the amplitude level of the emission previously measured directly in step 5 and step 6.
    - c) Record the output power level of the signal generator when equivalence is achieved in step b).
  11. Repeat step 8 through step 10 with the measurement antenna oriented in the opposite polarization.
  12. Calculate the emission power in dBm referenced to a half-wave dipole using the following equation:  
$$P_e = P_s(\text{dBm}) - \text{cable loss (dB)} + \text{antenna gain (dBd)}$$
where  
 $P_e$  = equivalent emission power in dBm  
 $P_s$  = source (signal generator) power in dBm  
*NOTE—dBd refers to the measured antenna gain in decibels relative to a half-wave dipole.*
  13. Correct the antenna gain of the substitution antenna if necessary to reference the emission power to a half-wave dipole. When using measurement antennas with the gain specified in dBi, the equivalent dipole-referenced gain can be determined from:  
$$\text{gain (dBd)} = \text{gain (dBi)} - 2.15 \text{ dB.}$$
If necessary, the antenna gain can be calculated from calibrated antenna factor information
  14. Provide the complete measurement results as a part of the test report.

**TEST MODE:**

Please refer to the clause 3.3

**TEST RESULTS**

**Passed**       **Not Applicable**

Note: Worst case at WCDMA Band II/ WCDMA Band V

Channel: 9262					Polarization: Horizontal				
Mark	Frequency MHz	Reading dBm	Antenna dB	Cable dB	Preamp dB	Level dBm	Limit dBm	Over limit	Remark
1	89.55	-70.68	20.25	6.92	30.67	-74.18	-13.00	-61.18	Peak
2	400.56	-74.50	26.20	8.32	30.11	-70.09	-13.00	-57.09	Peak
3	1333.54	-69.15	37.02	12.78	29.29	-48.64	-13.00	-35.64	Peak
4	2322.48	-69.03	40.25	12.95	29.09	-44.92	-13.00	-31.92	Peak
5	4981.67	-75.67	44.30	11.56	35.21	-55.02	-13.00	-42.02	Peak
6	8039.36	-75.57	47.99	14.28	33.31	-46.61	-13.00	-33.61	Peak

Channel: 9262					Polarization: Vertical				
Mark	Frequency MHz	Reading dBm	Antenna dB	Cable dB	Preamp dB	Level dBm	Limit dBm	Over limit	Remark
1	39.75	-58.12	21.87	6.55	30.85	-60.55	-13.00	-47.55	Peak
2	88.30	-73.19	27.63	6.91	30.68	-69.33	-13.00	-56.33	Peak
3	1375.20	-69.85	37.65	12.56	29.17	-48.81	-13.00	-35.81	Peak
4	2575.14	-70.09	39.17	14.35	27.11	-43.68	-13.00	-30.68	Peak
5	4481.22	-74.66	43.21	10.66	36.25	-57.04	-13.00	-44.04	Peak
6	7923.61	-75.85	47.97	14.53	33.33	-46.68	-13.00	-33.68	Peak

Channel: 9400					Polarization: Horizontal				
Mark	Frequency MHz	Reading dBm	Antenna dB	Cable dB	Preamp dB	Level dBm	Limit dBm	Over limit	Remark
1	39.75	-70.45	28.59	6.55	30.85	-66.16	-13.00	-53.16	Peak
2	89.55	-69.31	20.25	6.92	30.67	-72.81	-13.00	-59.81	Peak
3	1378.22	-68.97	37.12	12.54	29.16	-48.47	-13.00	-35.47	Peak
4	2600.73	-71.45	38.76	14.50	26.87	-45.06	-13.00	-32.06	Peak
5	4931.35	-75.23	44.12	11.52	35.20	-54.79	-13.00	-41.79	Peak
6	7935.11	-75.91	48.05	14.49	33.32	-46.69	-13.00	-33.69	Peak

Channel: 9400					Polarization: Vertical				
Mark	Frequency MHz	Reading dBm	Antenna dB	Cable dB	Preamp dB	Level dBm	Limit dBm	Over limit	Remark
1	39.47	-58.68	21.84	6.55	30.85	-61.14	-13.00	-48.14	Peak
2	155.00	-69.64	21.11	7.30	30.32	-71.55	-13.00	-58.55	Peak
3	1332.08	-68.93	37.46	12.79	29.29	-47.97	-13.00	-34.97	Peak
4	2717.57	-72.01	40.06	14.32	26.05	-43.68	-13.00	-30.68	Peak
5	4673.71	-75.47	43.55	11.05	35.89	-56.76	-13.00	-43.76	Peak
6	7608.30	-76.59	48.26	14.68	33.19	-46.84	-13.00	-33.84	Peak

Channel: 9538					Polarization: Horizontal				
Mark	Frequency MHz	Reading dBm	Antenna dB	Cable dB	Preamp dB	Level dBm	Limit dBm	Over limit	Remark
1	88.93	-70.76	20.12	6.91	30.67	-74.40	-13.00	-61.40	Peak
2	800.80	-76.56	29.96	9.56	29.57	-66.61	-13.00	-53.61	Peak
3	1326.23	-69.40	37.01	12.82	29.31	-48.88	-13.00	-35.88	Peak
4	2753.63	-72.00	40.28	14.23	25.85	-43.34	-13.00	-30.34	Peak
5	4888.62	-76.73	43.97	11.50	35.19	-56.45	-13.00	-43.45	Peak
6	8770.25	-75.30	48.62	15.64	34.83	-45.87	-13.00	-32.87	Peak

Channel: 9538					Polarization: Vertical				
Mark	Frequency MHz	Reading dBm	Antenna dB	Cable dB	Preamp dB	Level dBm	Limit dBm	Over limit	Remark
1	40.17	-57.77	21.87	6.56	30.86	-60.20	-13.00	-47.20	Peak
2	88.30	-72.94	27.63	6.91	30.68	-69.08	-13.00	-56.08	Peak
3	1318.97	-69.18	37.40	12.86	29.33	-48.25	-13.00	-35.25	Peak
4	2203.18	-69.81	41.69	12.60	29.64	-45.16	-13.00	-32.16	Peak
5	3814.91	-70.60	41.98	9.86	37.00	-55.76	-13.00	-42.76	Peak
6	7305.54	-74.38	48.61	13.66	34.11	-46.22	-13.00	-33.22	Peak

Remark:

1. The emission behaviour belongs to narrowband spurious emission.
2. The emission levels of not record in the report are very lower than the limit and not show in test report.



Channel: 4132					Polarization: Horizontal				
Mark	Frequency MHz	Reading dBm	Antenna dB	Cable dB	Preamp dB	Level dBm	Limit dBm	Over limit	Remark
1	39.47	-71.34	28.59	6.55	30.85	-67.05	-13.00	-54.05	Peak
2	400.56	-76.07	26.20	8.32	30.11	-71.66	-13.00	-58.66	Peak
3	1411.94	-69.05	37.08	12.35	29.10	-48.72	-13.00	-35.72	Peak
4	2796.31	-71.52	40.69	14.13	25.62	-42.32	-13.00	-29.32	Peak
5	4996.14	-75.73	44.35	11.57	35.24	-55.05	-13.00	-42.05	Peak
6	8027.71	-75.07	48.03	14.28	33.31	-46.07	-13.00	-33.07	Peak

Channel: 4132					Polarization: Vertical				
Mark	Frequency MHz	Reading dBm	Antenna dB	Cable dB	Preamp dB	Level dBm	Limit dBm	Over limit	Remark
1	39.61	-57.83	21.85	6.55	30.85	-60.28	-13.00	-47.28	Peak
2	89.55	-74.17	28.12	6.92	30.67	-69.80	-13.00	-56.80	Peak
3	1393.45	-69.30	37.73	12.46	29.12	-48.23	-13.00	-35.23	Peak
4	2203.18	-69.11	41.69	12.60	29.64	-44.46	-13.00	-31.46	Peak
5	4700.90	-75.59	43.57	11.12	35.74	-56.64	-13.00	-43.64	Peak
6	7674.79	-76.37	48.37	14.71	33.16	-46.45	-13.00	-33.45	Peak

Channel: 4182					Polarization: Horizontal				
Mark	Frequency MHz	Reading dBm	Antenna dB	Cable dB	Preamp dB	Level dBm	Limit dBm	Over limit	Remark
1	39.61	-71.48	28.59	6.55	30.85	-67.19	-13.00	-54.19	Peak
2	90.19	-71.44	20.30	6.92	30.67	-74.89	-13.00	-61.89	Peak
3	1375.20	-68.72	37.11	12.56	29.17	-48.22	-13.00	-35.22	Peak
4	2374.08	-70.23	39.96	13.11	28.56	-45.72	-13.00	-32.72	Peak
5	3599.90	-75.19	42.39	10.10	36.93	-59.63	-13.00	-46.63	Peak
6	7889.21	-74.80	47.99	14.57	33.32	-45.56	-13.00	-32.56	Peak

Channel: 4182					Polarization: Vertical				
Mark	Frequency MHz	Reading dBm	Antenna dB	Cable dB	Preamp dB	Level dBm	Limit dBm	Over limit	Remark
1	39.61	-57.88	21.85	6.55	30.85	-60.33	-13.00	-47.33	Peak
2	89.55	-74.87	28.12	6.92	30.67	-70.50	-13.00	-57.50	Peak
3	1372.18	-67.93	37.64	12.58	29.18	-46.89	-13.00	-33.89	Peak
4	2759.69	-72.58	40.38	14.22	25.82	-43.80	-13.00	-30.80	Peak
5	4996.14	-74.65	44.49	11.57	35.24	-53.83	-13.00	-40.83	Peak
6	7630.40	-76.12	48.30	14.69	33.18	-46.31	-13.00	-33.31	Peak

Channel: 4233					Polarization: Horizontal				
Mark	Frequency MHz	Reading dBm	Antenna dB	Cable dB	Preamp dB	Level dBm	Limit dBm	Over limit	Remark
1	39.61	-70.57	28.59	6.55	30.85	-66.28	-13.00	-53.28	Peak
2	88.30	-71.48	19.98	6.91	30.68	-75.27	-13.00	-62.27	Peak
3	1375.20	-69.00	37.11	12.56	29.17	-48.50	-13.00	-35.50	Peak
4	2646.85	-72.02	39.23	14.43	26.53	-44.89	-13.00	-31.89	Peak
5	4714.55	-75.63	43.57	11.18	35.67	-56.55	-13.00	-43.55	Peak
6	8051.03	-74.37	47.94	14.28	33.32	-45.47	-13.00	-32.47	Peak

Channel: 4233					Polarization: Vertical				
Mark	Frequency MHz	Reading dBm	Antenna dB	Cable dB	Preamp dB	Level dBm	Limit dBm	Over limit	Remark
1	40.17	-58.09	21.87	6.56	30.86	-60.52	-13.00	-47.52	Peak
2	155.54	-70.25	21.16	7.30	30.33	-72.12	-13.00	-59.12	Peak
3	1370.67	-68.97	37.63	12.58	29.18	-47.94	-13.00	-34.94	Peak
4	2561.04	-71.24	39.18	14.26	27.24	-45.04	-13.00	-32.04	Peak
5	6814.28	-76.31	47.41	13.63	34.24	-49.51	-13.00	-36.51	Peak
6	10744.57	-75.00	52.55	16.60	36.88	-42.73	-13.00	-29.73	Peak

## Remark:

1. The emission behaviour belongs to narrowband spurious emission.
2. The emission levels of not record in the report are very lower than the limit and not show in test report.



## 6. APPENDIX REPORT

# APPENDIX REPORT

Project No.	SHT2006119501EW	Radio Specification	WCDMA
Test sample No.	YPHT20061195004	Model No.	989803202921
Start test date	2020/6/29	Finish date	2020/7/6
Temperature	25°C	Humidity	50%
Test Engineer	Jess He	Auditor	<i>William.wang</i>

Appendix clause	Test item	Result
A	Conducted Output Power	PASS
B	Peak-to-Average Ratio	PASS
C	26 dB Bandwidth and Occupied Bandwidth	PASS
D	Band edge	PASS
E	Conducted Spurious Emission	PASS
F	Frequency Stability	PASS
G	Modulation characteristics	PASS

## 8.1 Appendix A: Conducted Output Power

### Test Result

Band	Channel	Power(dBm)	Limit(dBm)	Verdict
Band II	9262	23.55	33	PASS
Band II	9400	23.07	33	PASS
Band II	9538	22.91	33	PASS
Band V	4132	23.11	38.5	PASS
Band V	4182	23.14	38.5	PASS
Band V	4233	23.17	38.5	PASS

Band	Channel	SubTest	Power(dBm)	Limit(dBm)	Verdict
Band II	9262	HSDPA_Sub1	23.32	33	PASS
Band II	9262	HSDPA_Sub2	22.62	33	PASS
Band II	9262	HSDPA_Sub3	22.42	33	PASS
Band II	9262	HSDPA_Sub4	22.18	33	PASS
Band II	9400	HSDPA_Sub1	22.95	33	PASS
Band II	9400	HSDPA_Sub2	22.23	33	PASS
Band II	9400	HSDPA_Sub3	22.02	33	PASS
Band II	9400	HSDPA_Sub4	21.78	33	PASS
Band II	9538	HSDPA_Sub1	22.62	33	PASS
Band II	9538	HSDPA_Sub2	21.93	33	PASS
Band II	9538	HSDPA_Sub3	21.68	33	PASS
Band II	9538	HSDPA_Sub4	21.43	33	PASS
Band V	4132	HSDPA_Sub1	23.19	38.5	PASS
Band V	4132	HSDPA_Sub2	22.47	38.5	PASS
Band V	4132	HSDPA_Sub3	22.19	38.5	PASS
Band V	4132	HSDPA_Sub4	21.94	38.5	PASS
Band V	4182	HSDPA_Sub1	23.21	38.5	PASS
Band V	4182	HSDPA_Sub2	22.47	38.5	PASS
Band V	4182	HSDPA_Sub3	22.24	38.5	PASS
Band V	4182	HSDPA_Sub4	21.99	38.5	PASS
Band V	4233	HSDPA_Sub1	23.29	38.5	PASS
Band V	4233	HSDPA_Sub2	22.51	38.5	PASS
Band V	4233	HSDPA_Sub3	22.27	38.5	PASS
Band V	4233	HSDPA_Sub4	22.00	38.5	PASS

Band	Channel	SubTest	Power(dBm)	Limit(dBm)	Verdict
Band II	9262	HSUPA_Sub1	22.65	33	PASS
Band II	9262	HSUPA_Sub2	21.08	33	PASS
Band II	9262	HSUPA_Sub3	21.60	33	PASS
Band II	9262	HSUPA_Sub4	20.72	33	PASS
Band II	9262	HSUPA_Sub5	22.86	33	PASS
Band II	9400	HSUPA_Sub1	22.13	33	PASS
Band II	9400	HSUPA_Sub2	20.62	33	PASS
Band II	9400	HSUPA_Sub3	21.14	33	PASS
Band II	9400	HSUPA_Sub4	20.29	33	PASS
Band II	9400	HSUPA_Sub5	22.39	33	PASS
Band II	9538	HSUPA_Sub1	22.00	33	PASS
Band II	9538	HSUPA_Sub2	20.56	33	PASS
Band II	9538	HSUPA_Sub3	21.03	33	PASS
Band II	9538	HSUPA_Sub4	20.19	33	PASS
Band II	9538	HSUPA_Sub5	22.31	33	PASS
Band V	4132	HSUPA_Sub1	22.34	38.5	PASS
Band V	4132	HSUPA_Sub2	20.76	38.5	PASS
Band V	4132	HSUPA_Sub3	21.34	38.5	PASS
Band V	4132	HSUPA_Sub4	20.54	38.5	PASS
Band V	4132	HSUPA_Sub5	22.63	38.5	PASS
Band V	4182	HSUPA_Sub1	22.51	38.5	PASS
Band V	4182	HSUPA_Sub2	20.93	38.5	PASS
Band V	4182	HSUPA_Sub3	21.42	38.5	PASS
Band V	4182	HSUPA_Sub4	20.57	38.5	PASS
Band V	4182	HSUPA_Sub5	22.82	38.5	PASS
Band V	4233	HSUPA_Sub1	22.60	38.5	PASS
Band V	4233	HSUPA_Sub2	21.03	38.5	PASS
Band V	4233	HSUPA_Sub3	21.46	38.5	PASS
Band V	4233	HSUPA_Sub4	20.68	38.5	PASS
Band V	4233	HSUPA_Sub5	22.93	38.5	PASS

## 8.2 Appendix B: Peak-to-Average Ratio

### Test Result

Band	Channel	Peak-to-Average Ratio(dB)	Limit(dB)	Verdict
Band II	9262	2.94	13	PASS
Band II	9400	2.94	13	PASS
Band II	9538	2.85	13	PASS
Band V	4132	2.85	13	PASS
Band V	4182	2.82	13	PASS
Band V	4233	2.86	13	PASS

Test Graphs

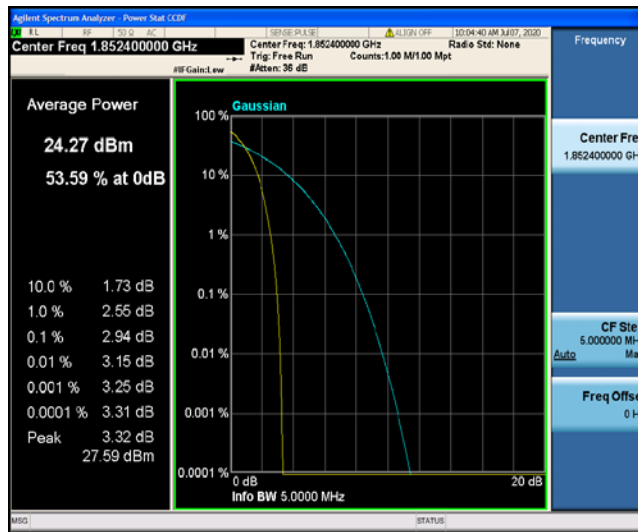

Band II\_9262



Band II\_9400



Band II\_9538

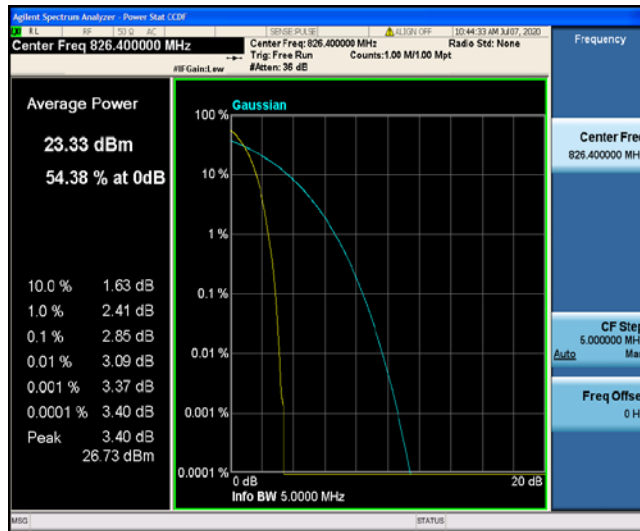

Band V\_4132

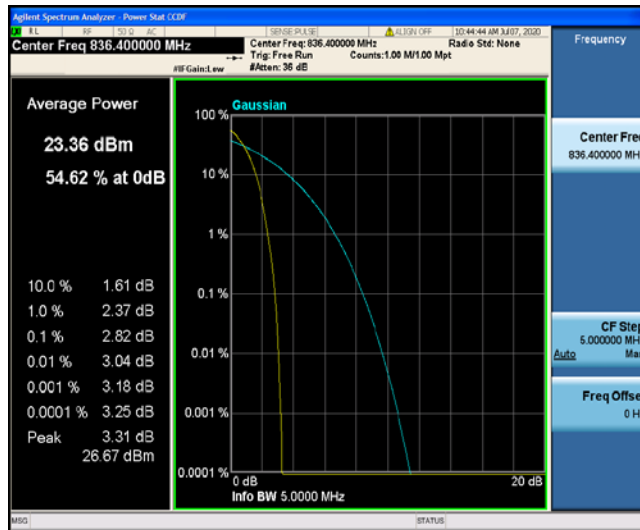

Band V\_4182

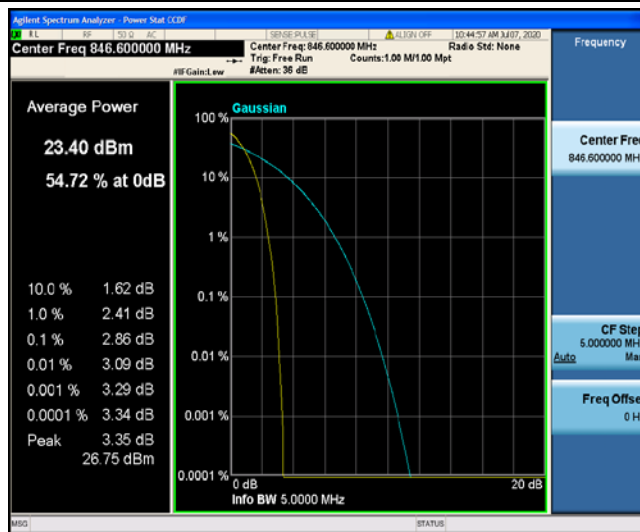

Band V\_4233

### 8.3 Appendix C: 26dB Bandwidth and Occupied Bandwidth

#### Test Result

Band	Channel	Occupied Bandwidth (kHz)	26dB Bandwidth (kHz)	Limit(kHz)	Verdict
Band II	9262	4064.4	4616	---	PASS
Band II	9400	4072.2	4618	---	PASS
Band II	9538	4056.5	4625	---	PASS
Band V	4132	4093.7	4656	---	PASS
Band V	4182	4090.7	4654	---	PASS
Band V	4233	4065.2	4669	---	PASS



Test Graphs

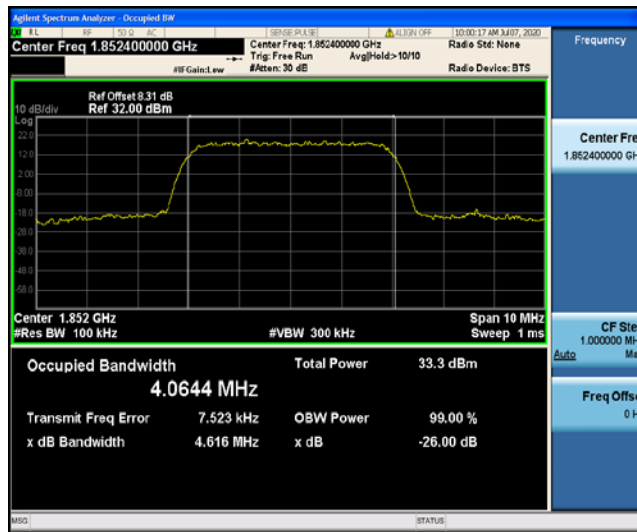

Band II\_9262

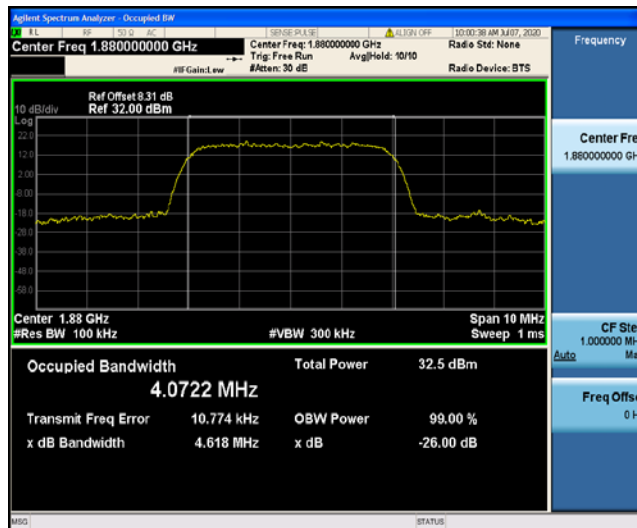

Band II\_9400



Band II\_9538

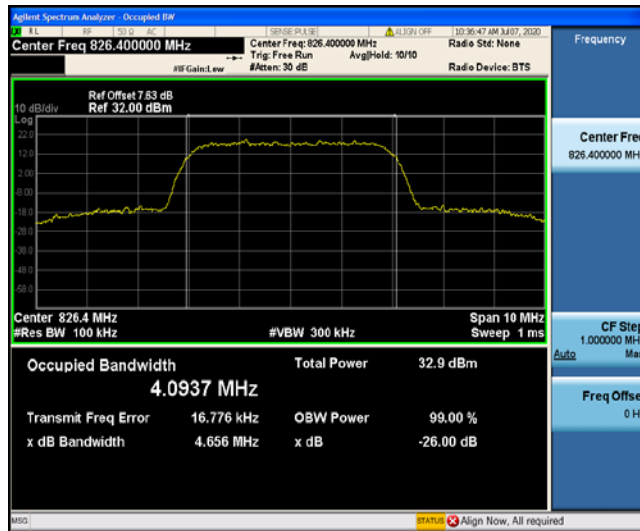

Band V\_4132



Band V\_4182

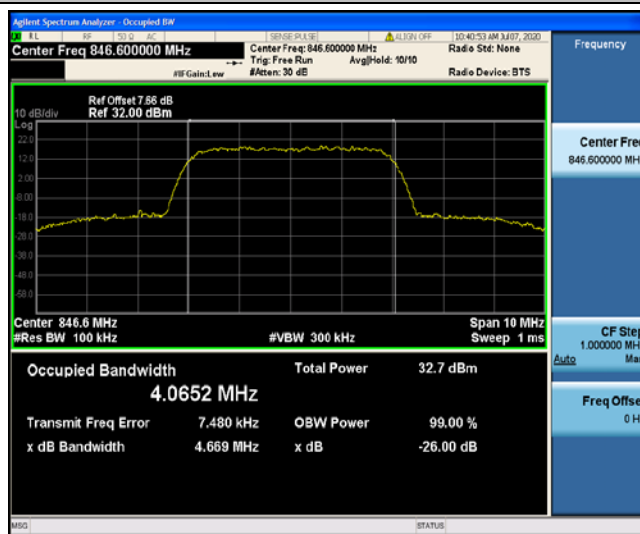

Band V\_4233

#### 8.4 Appendix D: Band Edge

##### Test Result

Band	Channel	Value(dBm)	Limit(dBm)	Verdict
Band II	9262	-24.23	-13	PASS
Band II	9538	-24.42	-13	PASS
Band V	4132	-21.91	-13	PASS
Band V	4233	-21.22	-13	PASS

Test Graphs

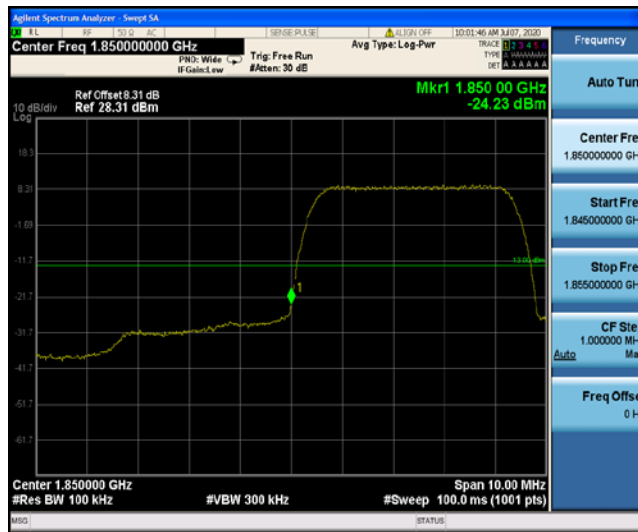

Band II\_9262



Band II\_9538



Band V\_4132



Band V\_4233

## 8.5 Appendix E: Conducted Spurious Emission

### Test Result

Band	Channel	Frequency Rang(Mhz)	Value(dBm)	Limit(dBm)	Verdict
Band II	9262	30~1000	-46.38	-13	PASS
Band II	9262	1000~20000	-26.09	-13	PASS
Band II	9400	30~1000	-47.50	-13	PASS
Band II	9400	1000~20000	-26.37	-13	PASS
Band II	9538	30~1000	-46.90	-13	PASS
Band II	9538	1000~20000	-25.95	-13	PASS
Band V	4132	30~1000	-46.94	-13	PASS
Band V	4132	1000~10000	-32.33	-13	PASS
Band V	4182	30~1000	-47.35	-13	PASS
Band V	4182	1000~10000	-32.33	-13	PASS
Band V	4233	30~1000	-46.41	-13	PASS
Band V	4233	1000~10000	-32.68	-13	PASS

Test Graphs

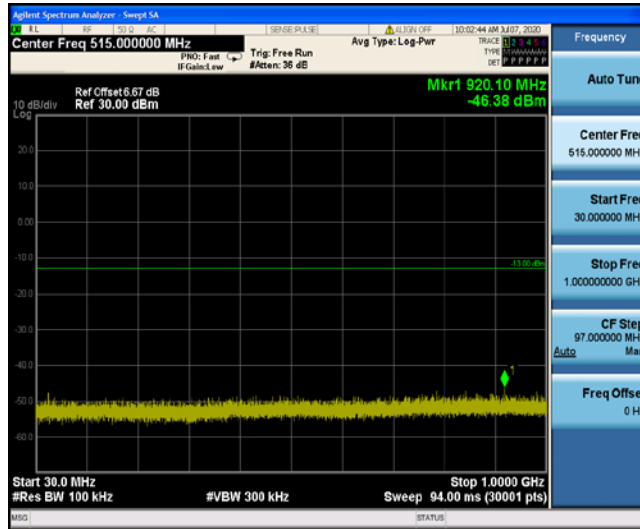

Band II\_9262



Band II\_9262

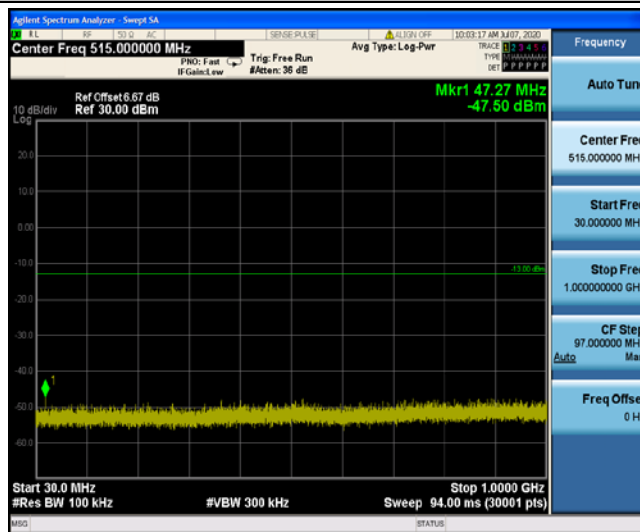

Band II\_9400

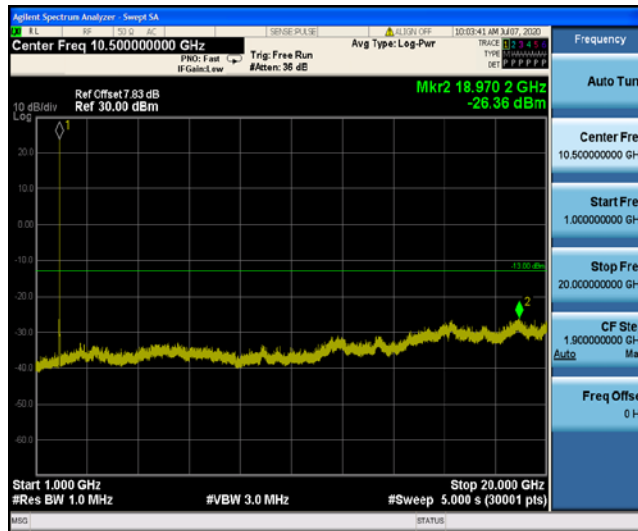

Band II\_9400

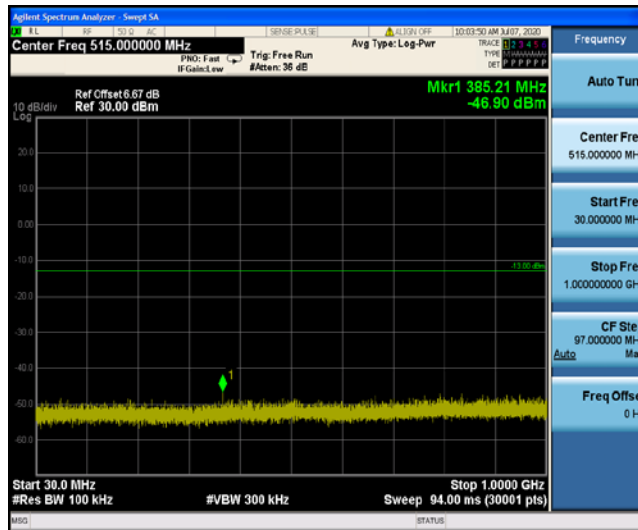

Band II\_9538

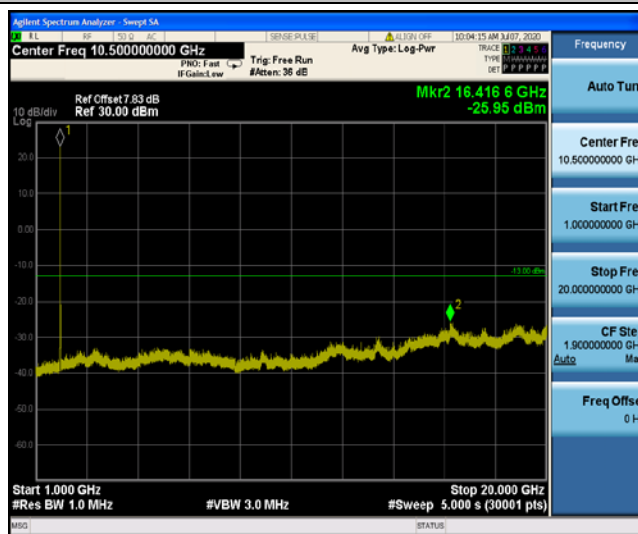

Band II\_9538



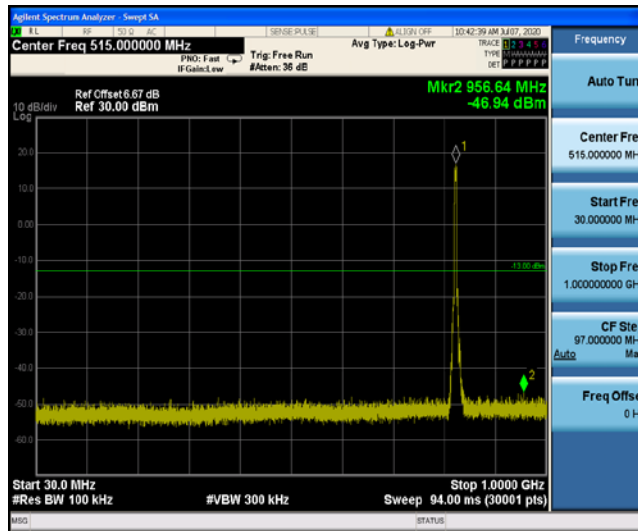

Band V\_4132

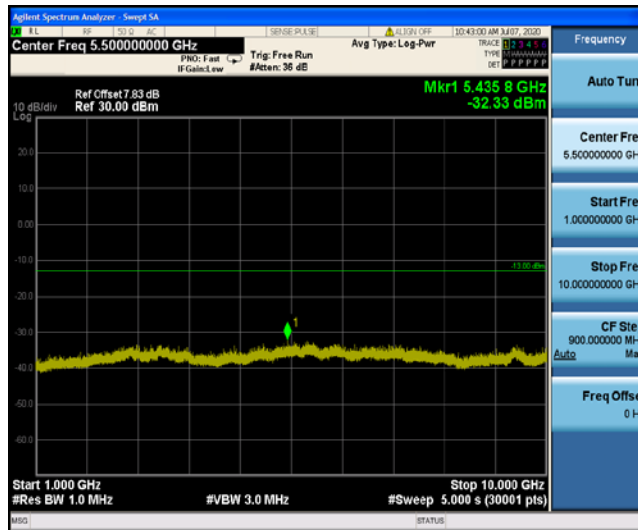

Band V\_4132

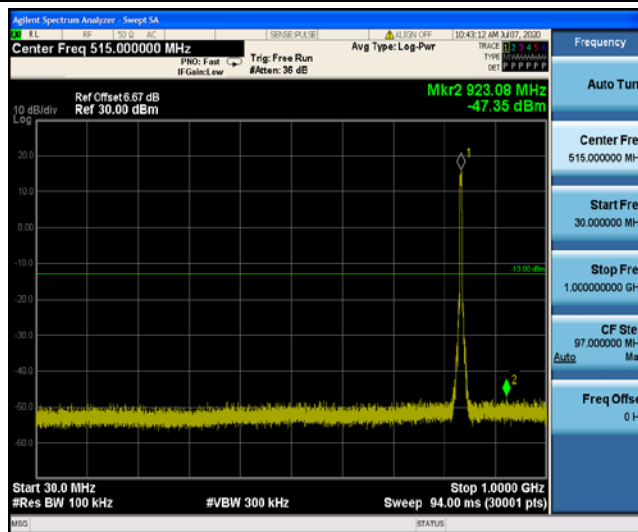

Band V\_4182

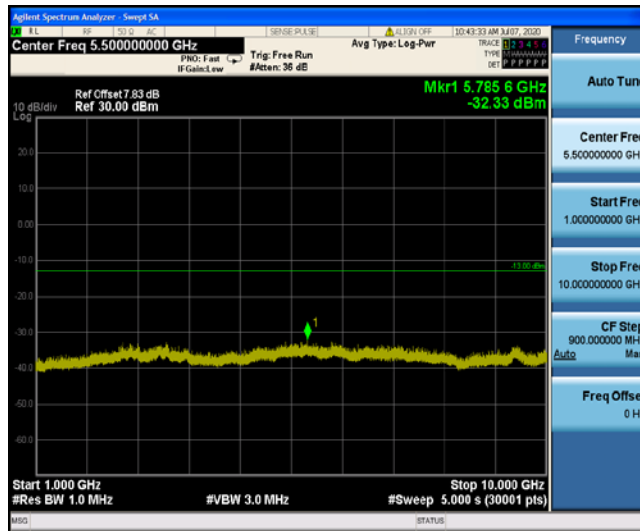

Band V\_4182

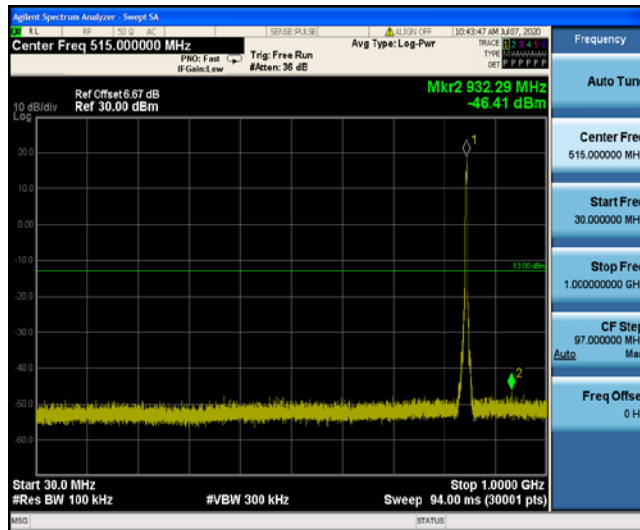

Band V\_4233



Band V\_4233

**8.6 Appendix F: Frequency Stability**

## Test Result

Voltage							
Band	Channel	Voltage (Vdc)	Temperature (°C)	Deviation (Hz)	Deviation (ppm)	Limit (ppm)	Verdict
Band II	9262	VL	TN	-0.15	-0.000081	2.5	PASS
Band II	9262	VN	TN	-11.69	-0.006309	2.5	PASS
Band II	9262	VH	TN	-20.68	-0.011163	2.5	PASS
Band II	9400	VL	TN	38.52	0.020491	2.5	PASS
Band II	9400	VN	TN	9.43	0.005014	2.5	PASS
Band II	9400	VH	TN	7.47	0.003972	2.5	PASS
Band II	9538	VL	TN	-46.19	-0.024214	2.5	PASS
Band II	9538	VN	TN	-26.19	-0.013731	2.5	PASS
Band II	9538	VH	TN	-34.41	-0.018039	2.5	PASS
Band V	4132	VL	TN	-22.05	-0.026684	2.5	PASS
Band V	4132	VN	TN	-7.28	-0.008811	2.5	PASS
Band V	4132	VH	TN	-0.85	-0.001030	2.5	PASS
Band V	4182	VL	TN	-17.13	-0.020481	2.5	PASS
Band V	4182	VN	TN	0.82	0.000975	2.5	PASS
Band V	4182	VH	TN	-11.34	-0.013563	2.5	PASS
Band V	4233	VL	TN	-21.11	-0.024932	2.5	PASS
Band V	4233	VN	TN	-15.63	-0.018460	2.5	PASS
Band V	4233	VH	TN	-9.36	-0.011051	2.5	PASS

Temperature							
Band	Channel	Voltage (Vdc)	Temperature (°C)	Deviation (Hz)	Deviation (ppm)	Limit (ppm)	Verdict
Band II	9262	VN	-30	-29.23	-0.015781	2.5	PASS
Band II	9262	VN	-20	-35.85	-0.019353	2.5	PASS
Band II	9262	VN	-10	-48.34	-0.026094	2.5	PASS
Band II	9262	VN	0	-12.84	-0.006931	2.5	PASS
Band II	9262	VN	10	-22.62	-0.012213	2.5	PASS
Band II	9262	VN	20	-28.16	-0.015202	2.5	PASS
Band II	9262	VN	30	-33.49	-0.018078	2.5	PASS
Band II	9262	VN	40	-40.34	-0.021777	2.5	PASS
Band II	9262	VN	50	-42.67	-0.023032	2.5	PASS
Band II	9400	VN	-30	10.44	0.005551	2.5	PASS
Band II	9400	VN	-20	13.97	0.007430	2.5	PASS
Band II	9400	VN	-10	16.72	0.008895	2.5	PASS
Band II	9400	VN	0	18.19	0.009675	2.5	PASS
Band II	9400	VN	10	17.64	0.009382	2.5	PASS
Band II	9400	VN	20	26.85	0.014282	2.5	PASS
Band II	9400	VN	30	24.99	0.013293	2.5	PASS
Band II	9400	VN	40	26.21	0.013940	2.5	PASS
Band II	9400	VN	50	24.06	0.012799	2.5	PASS
Band II	9538	VN	-30	-43.91	-0.023018	2.5	PASS
Band II	9538	VN	-20	-12.06	-0.006322	2.5	PASS
Band II	9538	VN	-10	-23.50	-0.012317	2.5	PASS
Band II	9538	VN	0	-31.96	-0.016757	2.5	PASS
Band II	9538	VN	10	-31.64	-0.016588	2.5	PASS
Band II	9538	VN	20	-37.89	-0.019865	2.5	PASS
Band II	9538	VN	30	-39.41	-0.020660	2.5	PASS
Band II	9538	VN	40	-44.46	-0.023307	2.5	PASS
Band II	9538	VN	50	-49.70	-0.026055	2.5	PASS
Band V	4132	VN	-30	-20.38	-0.024658	2.5	PASS
Band V	4132	VN	-20	-15.74	-0.019041	2.5	PASS
Band V	4132	VN	-10	-23.67	-0.028640	2.5	PASS
Band V	4132	VN	0	-23.20	-0.028068	2.5	PASS
Band V	4132	VN	10	-11.41	-0.013805	2.5	PASS
Band V	4132	VN	20	-16.63	-0.020123	2.5	PASS
Band V	4132	VN	30	-16.19	-0.019595	2.5	PASS
Band V	4132	VN	40	-14.58	-0.017648	2.5	PASS
Band V	4132	VN	50	-26.24	-0.031747	2.5	PASS
Band V	4182	VN	-30	-1.44	-0.001719	2.5	PASS
Band V	4182	VN	-20	-19.19	-0.022944	2.5	PASS
Band V	4182	VN	-10	-9.83	-0.011750	2.5	PASS
Band V	4182	VN	0	-27.94	-0.033403	2.5	PASS
Band V	4182	VN	10	-14.85	-0.017753	2.5	PASS
Band V	4182	VN	20	-3.31	-0.003959	2.5	PASS
Band V	4182	VN	30	-19.83	-0.023705	2.5	PASS
Band V	4182	VN	40	-6.91	-0.008261	2.5	PASS
Band V	4182	VN	50	-17.93	-0.021439	2.5	PASS
Band V	4233	VN	-30	-25.23	-0.029807	2.5	PASS

Band V	4233	VN	-20	-15.26	-0.018021	2.5	PASS
Band V	4233	VN	-10	-1.10	-0.001301	2.5	PASS
Band V	4233	VN	0	-17.03	-0.020116	2.5	PASS
Band V	4233	VN	10	-1.87	-0.002214	2.5	PASS
Band V	4233	VN	20	-15.95	-0.018840	2.5	PASS
Band V	4233	VN	30	-26.54	-0.031344	2.5	PASS
Band V	4233	VN	40	-5.99	-0.007071	2.5	PASS
Band V	4233	VN	50	-15.94	-0.018823	2.5	PASS

## 8.7 Appendix G: Modulation characteristics

### Test Result

**BAND II-PE**

**BAND V-PE**



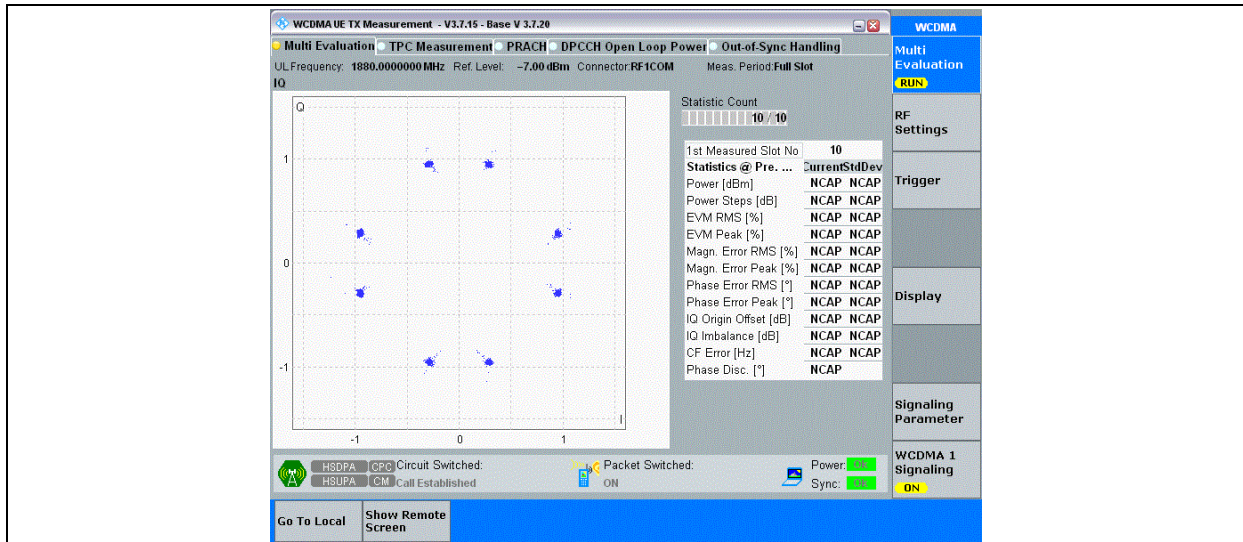

BAND II-IQ

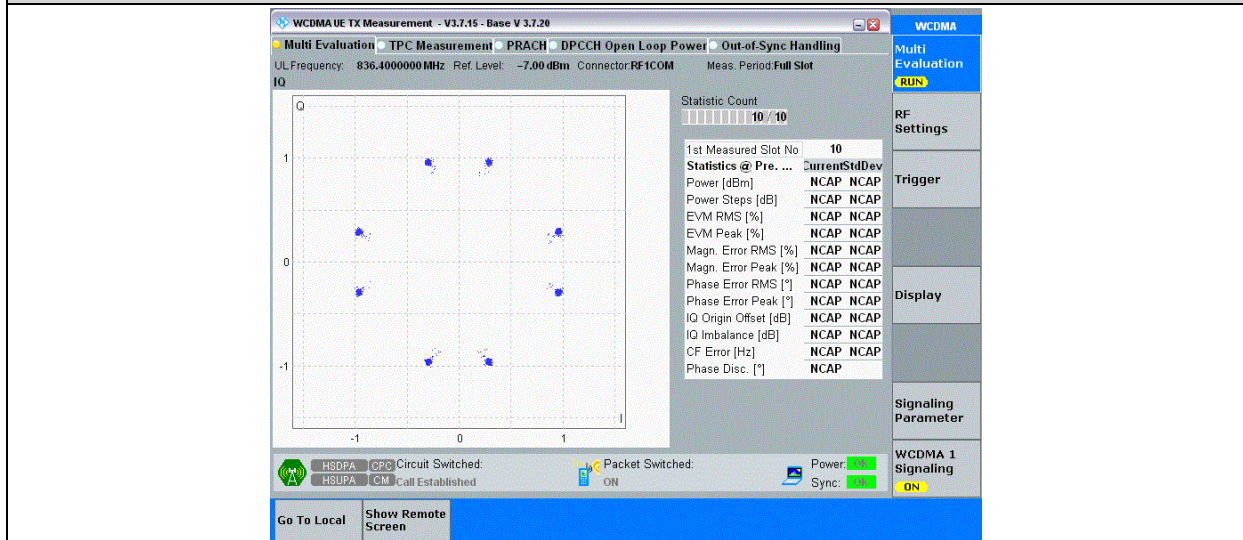

BAND V-IQ

-----End of the Report -----