



## SAR Reference Dipole Calibration Report

Ref : ACR.109.7.18.SATU.A

**SHENZHEN NTEK TESTING TECHNOLOGY  
CO., LTD.**

**BUILDING E, FENDA SCIENCE PARK, SANWEI  
COMMUNITY, XIXIANG STREET,  
BAO'AN DISTRICT, SHENZHEN GUANGDONG, CHINA  
MVG COMOSAR REFERENCE DIPOLE**

**FREQUENCY: 2450 MHZ**

**SERIAL NO.: SN 03/15 DIP 2G450-352**

**Calibrated at MVG US**

**2105 Barrett Park Dr. - Kennesaw, GA 30144**



**Calibration Date: 04/19/2018**

*Summary:*

This document presents the method and results from an accredited SAR reference dipole calibration performed in MVG USA using the COMOSAR test bench. All calibration results are traceable to national metrology institutions.



SAR REFERENCE DIPOLE CALIBRATION REPORT

Ref: ACR.109.7.18.SATU.A

|                      | <i>Name</i>   | <i>Function</i> | <i>Date</i> | <i>Signature</i>     |
|----------------------|---------------|-----------------|-------------|----------------------|
| <i>Prepared by :</i> | Jérôme LUC    | Product Manager | 4/19/2018   | <i>JL</i>            |
| <i>Checked by :</i>  | Jérôme LUC    | Product Manager | 4/19/2018   | <i>JL</i>            |
| <i>Approved by :</i> | Kim RUTKOWSKI | Quality Manager | 4/19/2018   | <i>Kim Rutkowski</i> |

|                       | <i>Customer Name</i>                                |
|-----------------------|---|
| <i>Distribution :</i> | SHENZHEN NTEK<br>TESTING<br>TECHNOLOGY<br>CO., LTD. |

| <i>Issue</i> | <i>Date</i> | <i>Modifications</i> |
|--------------|-------------|----------------------|
| A            | 4/19/2018   | Initial release      |
|              |             |                      |
|              |             |                      |



SAR REFERENCE DIPOLE CALIBRATION REPORT

Ref: ACR.109.7.18.SATU.A

TABLE OF CONTENTS

1 Introduction..... 4

2 Device Under Test ..... 4

3 Product Description ..... 4

    3.1 General Information ..... 4

4 Measurement Method ..... 5

    4.1 Return Loss Requirements ..... 5

    4.2 Mechanical Requirements ..... 5

5 Measurement Uncertainty ..... 5

    5.1 Return Loss ..... 5

    5.2 Dimension Measurement ..... 5

    5.3 Validation Measurement ..... 5

6 Calibration Measurement Results ..... 6

    6.1 Return Loss and Impedance In Head Liquid ..... 6

    6.2 Return Loss and Impedance In Body Liquid ..... 6

    6.3 Mechanical Dimensions ..... 6

7 Validation measurement ..... 7

    7.1 Head Liquid Measurement ..... 7

    7.2 SAR Measurement Result With Head Liquid ..... 8

    7.3 Body Liquid Measurement ..... 9

    7.4 SAR Measurement Result With Body Liquid ..... 10

8 List of Equipment ..... 11



SAR REFERENCE DIPOLE CALIBRATION REPORT

Ref: ACR.109.7.18.SATU.A

**1 INTRODUCTION**

This document contains a summary of the requirements set forth by the IEEE 1528, FCC KDBs and CEI/IEC 62209 standards for reference dipoles used for SAR measurement system validations and the measurements that were performed to verify that the product complies with the fore mentioned standards.

**2 DEVICE UNDER TEST**

| Device Under Test              |                                   |
|--------------------------------|-----------------------------------|
| Device Type                    | COMOSAR 2450 MHz REFERENCE DIPOLE |
| Manufacturer                   | MVG                               |
| Model                          | SID2450                           |
| Serial Number                  | SN 03/15 DIP 2G450-352            |
| Product Condition (new / used) | Used                              |

A yearly calibration interval is recommended.

**3 PRODUCT DESCRIPTION**

**3.1 GENERAL INFORMATION**

MVG’s COMOSAR Validation Dipoles are built in accordance to the IEEE 1528, FCC KDBs and CEI/IEC 62209 standards. The product is designed for use with the COMOSAR test bench only.



**Figure 1 – MVG COMOSAR Validation Dipole**



**SAR REFERENCE DIPOLE CALIBRATION REPORT**

Ref: ACR.109.7.18.SATU.A

**4 MEASUREMENT METHOD**

The IEEE 1528, FCC KDBs and CEI/IEC 62209 standards provide requirements for reference dipoles used for system validation measurements. The following measurements were performed to verify that the product complies with the fore mentioned standards.

**4.1 RETURN LOSS REQUIREMENTS**

The dipole used for SAR system validation measurements and checks must have a return loss of -20 dB or better. The return loss measurement shall be performed against a liquid filled flat phantom, with the phantom constructed as outlined in the fore mentioned standards.

**4.2 MECHANICAL REQUIREMENTS**

The IEEE Std. 1528 and CEI/IEC 62209 standards specify the mechanical components and dimensions of the validation dipoles, with the dimensions frequency and phantom shell thickness dependent. The COMOSAR test bench employs a 2 mm phantom shell thickness therefore the dipoles sold for use with the COMOSAR test bench comply with the requirements set forth for a 2 mm phantom shell thickness.

**5 MEASUREMENT UNCERTAINTY**

All uncertainties listed below represent an expanded uncertainty expressed at approximately the 95% confidence level using a coverage factor of k=2, traceable to the Internationally Accepted Guides to Measurement Uncertainty.

**5.1 RETURN LOSS**

The following uncertainties apply to the return loss measurement:

| Frequency band | Expanded Uncertainty on Return Loss |
|----------------|-------------------------------------|
| 400-6000MHz    | 0.1 dB                              |

**5.2 DIMENSION MEASUREMENT**

The following uncertainties apply to the dimension measurements:

| Length (mm) | Expanded Uncertainty on Length |
|-------------|--------------------------------|
| 3 - 300     | 0.05 mm                        |

**5.3 VALIDATION MEASUREMENT**

The guidelines outlined in the IEEE 1528, FCC KDBs, CENELEC EN50361 and CEI/IEC 62209 standards were followed to generate the measurement uncertainty for validation measurements.

| Scan Volume | Expanded Uncertainty |
|-------------|----------------------|
| 1 g         | 20.3 %               |



SAR REFERENCE DIPOLE CALIBRATION REPORT

Ref: ACR.109.7.18.SATU.A

|      |        |
|------|--------|
| 10 g | 20.1 % |
|------|--------|

6 CALIBRATION MEASUREMENT RESULTS

6.1 RETURN LOSS AND IMPEDANCE IN HEAD LIQUID

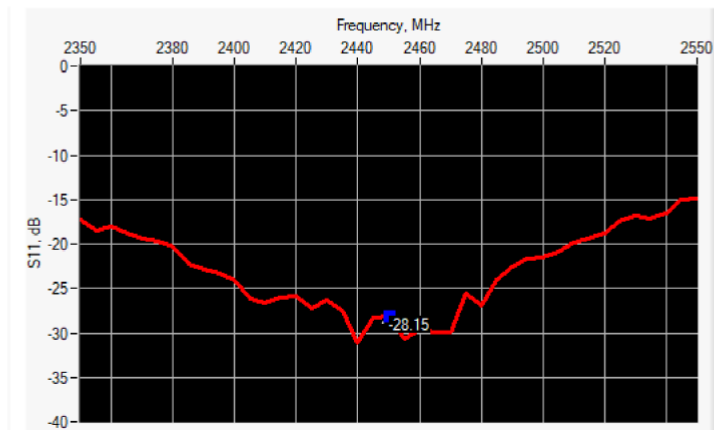

| Frequency (MHz) | Return Loss (dB) | Requirement (dB) | Impedance       |
|-----------------|------------------|------------------|-----------------|
| 2450            | -28.15           | -20              | 53.9 Ω + 0.3 jΩ |

6.2 RETURN LOSS AND IMPEDANCE IN BODY LIQUID

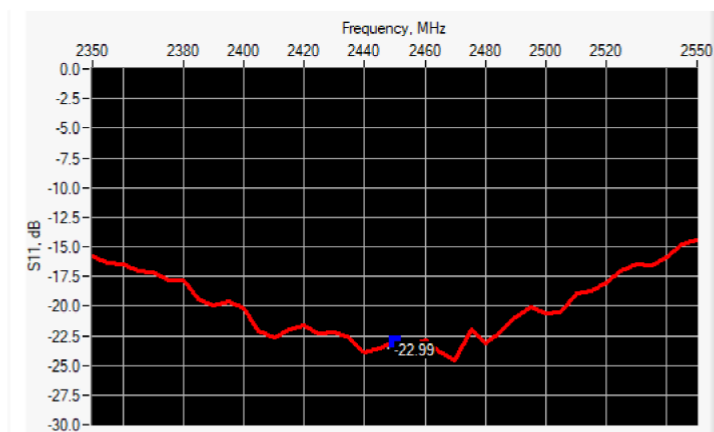

| Frequency (MHz) | Return Loss (dB) | Requirement (dB) | Impedance       |
|-----------------|------------------|------------------|-----------------|
| 2450            | -22.99           | -20              | 57.6 Ω - 0.8 jΩ |

6.3 MECHANICAL DIMENSIONS

| Frequency MHz | L mm       |          | h mm       |          | d mm      |          |
|---------------|------------|----------|------------|----------|-----------|----------|
|               | required   | measured | required   | measured | required  | measured |
| 300           | 420.0 ±1 % |          | 250.0 ±1 % |          | 6.35 ±1 % |          |



**SAR REFERENCE DIPOLE CALIBRATION REPORT**

Ref: ACR.109.7.18.SATU.A

|      |             |      |             |      |            |      |
|------|-------------|------|-------------|------|------------|------|
| 450  | 290.0 ±1 %. |      | 166.7 ±1 %. |      | 6.35 ±1 %. |      |
| 750  | 176.0 ±1 %. |      | 100.0 ±1 %. |      | 6.35 ±1 %. |      |
| 835  | 161.0 ±1 %. |      | 89.8 ±1 %.  |      | 3.6 ±1 %.  |      |
| 900  | 149.0 ±1 %. |      | 83.3 ±1 %.  |      | 3.6 ±1 %.  |      |
| 1450 | 89.1 ±1 %.  |      | 51.7 ±1 %.  |      | 3.6 ±1 %.  |      |
| 1500 | 80.5 ±1 %.  |      | 50.0 ±1 %.  |      | 3.6 ±1 %.  |      |
| 1640 | 79.0 ±1 %.  |      | 45.7 ±1 %.  |      | 3.6 ±1 %.  |      |
| 1750 | 75.2 ±1 %.  |      | 42.9 ±1 %.  |      | 3.6 ±1 %.  |      |
| 1800 | 72.0 ±1 %.  |      | 41.7 ±1 %.  |      | 3.6 ±1 %.  |      |
| 1900 | 68.0 ±1 %.  |      | 39.5 ±1 %.  |      | 3.6 ±1 %.  |      |
| 1950 | 66.3 ±1 %.  |      | 38.5 ±1 %.  |      | 3.6 ±1 %.  |      |
| 2000 | 64.5 ±1 %.  |      | 37.5 ±1 %.  |      | 3.6 ±1 %.  |      |
| 2100 | 61.0 ±1 %.  |      | 35.7 ±1 %.  |      | 3.6 ±1 %.  |      |
| 2300 | 55.5 ±1 %.  |      | 32.6 ±1 %.  |      | 3.6 ±1 %.  |      |
| 2450 | 51.5 ±1 %.  | PASS | 30.4 ±1 %.  | PASS | 3.6 ±1 %.  | PASS |
| 2600 | 48.5 ±1 %.  |      | 28.8 ±1 %.  |      | 3.6 ±1 %.  |      |
| 3000 | 41.5 ±1 %.  |      | 25.0 ±1 %.  |      | 3.6 ±1 %.  |      |
| 3500 | 37.0 ±1 %.  |      | 26.4 ±1 %.  |      | 3.6 ±1 %.  |      |
| 3700 | 34.7 ±1 %.  |      | 26.4 ±1 %.  |      | 3.6 ±1 %.  |      |

**7 VALIDATION MEASUREMENT**

The IEEE Std. 1528, FCC KDBs and CEI/IEC 62209 standards state that the system validation measurements must be performed using a reference dipole meeting the fore mentioned return loss and mechanical dimension requirements. The validation measurement must be performed against a liquid filled flat phantom, with the phantom constructed as outlined in the fore mentioned standards. Per the standards, the dipole shall be positioned below the bottom of the phantom, with the dipole length centered and parallel to the longest dimension of the flat phantom, with the top surface of the dipole at the described distance from the bottom surface of the phantom.

**7.1 HEAD LIQUID MEASUREMENT**

| Frequency<br>MHz | Relative permittivity ( $\epsilon_r'$ ) |          | Conductivity ( $\sigma$ ) S/m |          |
|------------------|---|----------|-------------------------------|----------|
|                  | required                                | measured | required                      | measured |
| 300              | 45.3 ±5 %                               |          | 0.87 ±5 %                     |          |
| 450              | 43.5 ±5 %                               |          | 0.87 ±5 %                     |          |
| 750              | 41.9 ±5 %                               |          | 0.89 ±5 %                     |          |
| 835              | 41.5 ±5 %                               |          | 0.90 ±5 %                     |          |
| 900              | 41.5 ±5 %                               |          | 0.97 ±5 %                     |          |
| 1450             | 40.5 ±5 %                               |          | 1.20 ±5 %                     |          |
| 1500             | 40.4 ±5 %                               |          | 1.23 ±5 %                     |          |
| 1640             | 40.2 ±5 %                               |          | 1.31 ±5 %                     |          |
| 1750             | 40.1 ±5 %                               |          | 1.37 ±5 %                     |          |





SAR REFERENCE DIPOLE CALIBRATION REPORT

Ref: ACR.109.7.18.SATU.A

|      |           |      |           |      |
|------|-----------|------|-----------|------|
| 1800 | 40.0 ±5 % |      | 1.40 ±5 % |      |
| 1900 | 40.0 ±5 % |      | 1.40 ±5 % |      |
| 1950 | 40.0 ±5 % |      | 1.40 ±5 % |      |
| 2000 | 40.0 ±5 % |      | 1.40 ±5 % |      |
| 2100 | 39.8 ±5 % |      | 1.49 ±5 % |      |
| 2300 | 39.5 ±5 % |      | 1.67 ±5 % |      |
| 2450 | 39.2 ±5 % | PASS | 1.80 ±5 % | PASS |
| 2600 | 39.0 ±5 % |      | 1.96 ±5 % |      |
| 3000 | 38.5 ±5 % |      | 2.40 ±5 % |      |
| 3500 | 37.9 ±5 % |      | 2.91 ±5 % |      |

7.2 SAR MEASUREMENT RESULT WITH HEAD LIQUID

The IEEE Std. 1528 and CEI/IEC 62209 standards state that the system validation measurements should produce the SAR values shown below (for phantom thickness of 2 mm), within the uncertainty for the system validation. All SAR values are normalized to 1 W forward power. In bracket, the measured SAR is given with the used input power.

|   |  |
|---|--|
| Software                                  | OPENSAR V4   |
| Phantom                                   | SN 20/09 SAM71   |
| Probe                                     | SN 18/11 EPG122  |
| Liquid                                    | Head Liquid Values: $\epsilon_p' : 37.5$ $\sigma : 1.80$ |
| Distance between dipole center and liquid | 10.0 mm  |
| Area scan resolution                      | $dx=8mm/dy=8mm$  |
| Zoon Scan Resolution                      | $dx=5mm/dy=5mm/dz=5mm$                                   |
| Frequency                                 | 2450 MHz   |
| Input power                               | 20 dBm   |
| Liquid Temperature                        | 21 °C  |
| Lab Temperature                           | 21 °C  |
| Lab Humidity                              | 45 %   |

| Frequency MHz | 1 g SAR (W/kg/W) |          | 10 g SAR (W/kg/W) |          |
|---------------|------------------|----------|-------------------|----------|
|               | required         | measured | required          | measured |
| 300           | 2.85             |          | 1.94              |          |
| 450           | 4.58             |          | 3.06              |          |
| 750           | 8.49             |          | 5.55              |          |
| 835           | 9.56             |          | 6.22              |          |
| 900           | 10.9             |          | 6.99              |          |
| 1450          | 29               |          | 16                |          |
| 1500          | 30.5             |          | 16.8              |          |
| 1640          | 34.2             |          | 18.4              |          |
| 1750          | 36.4             |          | 19.3              |          |
| 1800          | 38.4             |          | 20.1              |          |





**SAR REFERENCE DIPOLE CALIBRATION REPORT**

Ref: ACR.109.7.18.SATU.A

|      |      |              |      |              |
|------|------|--------------|------|--------------|
| 1900 | 39.7 |              | 20.5 |              |
| 1950 | 40.5 |              | 20.9 |              |
| 2000 | 41.1 |              | 21.1 |              |
| 2100 | 43.6 |              | 21.9 |              |
| 2300 | 48.7 |              | 23.3 |              |
| 2450 | 52.4 | 53.76 (5.38) | 24   | 24.12 (2.41) |
| 2600 | 55.3 |              | 24.6 |              |
| 3000 | 63.8 |              | 25.7 |              |
| 3500 | 67.1 |              | 25   |              |
| 3700 | 67.4 |              | 24.2 |              |

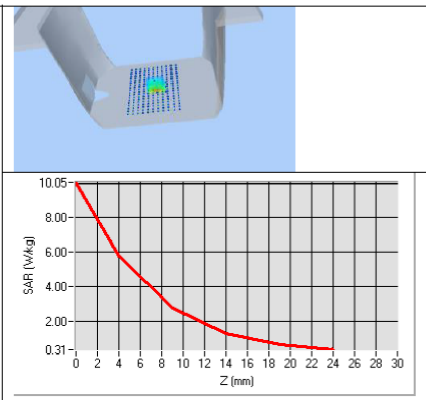
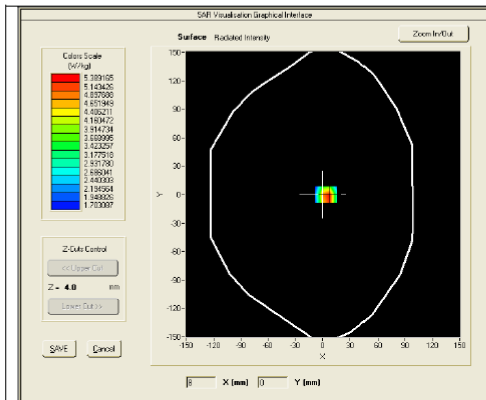

**7.3 BODY LIQUID MEASUREMENT**

| Frequency MHz | Relative permittivity ( $\epsilon_r'$ ) |          | Conductivity ( $\sigma$ ) S/m |          |
|---------------|---|----------|-------------------------------|----------|
|               | required                                | measured | required                      | measured |
| 150           | 61.9 ±5 %                               |          | 0.80 ±5 %                     |          |
| 300           | 58.2 ±5 %                               |          | 0.92 ±5 %                     |          |
| 450           | 56.7 ±5 %                               |          | 0.94 ±5 %                     |          |
| 750           | 55.5 ±5 %                               |          | 0.96 ±5 %                     |          |
| 835           | 55.2 ±5 %                               |          | 0.97 ±5 %                     |          |
| 900           | 55.0 ±5 %                               |          | 1.05 ±5 %                     |          |
| 915           | 55.0 ±5 %                               |          | 1.06 ±5 %                     |          |
| 1450          | 54.0 ±5 %                               |          | 1.30 ±5 %                     |          |
| 1610          | 53.8 ±5 %                               |          | 1.40 ±5 %                     |          |
| 1800          | 53.3 ±5 %                               |          | 1.52 ±5 %                     |          |
| 1900          | 53.3 ±5 %                               |          | 1.52 ±5 %                     |          |
| 2000          | 53.3 ±5 %                               |          | 1.52 ±5 %                     |          |
| 2100          | 53.2 ±5 %                               |          | 1.62 ±5 %                     |          |



**SAR REFERENCE DIPOLE CALIBRATION REPORT**

Ref: ACR.109.7.18.SATU.A

|      |            |      |            |      |
|------|------------|------|------------|------|
| 2300 | 52.9 ±5 %  |      | 1.81 ±5 %  |      |
| 2450 | 52.7 ±5 %  | PASS | 1.95 ±5 %  | PASS |
| 2600 | 52.5 ±5 %  |      | 2.16 ±5 %  |      |
| 3000 | 52.0 ±5 %  |      | 2.73 ±5 %  |      |
| 3500 | 51.3 ±5 %  |      | 3.31 ±5 %  |      |
| 3700 | 51.0 ±5 %  |      | 3.55 ±5 %  |      |
| 5200 | 49.0 ±10 % |      | 5.30 ±10 % |      |
| 5300 | 48.9 ±10 % |      | 5.42 ±10 % |      |
| 5400 | 48.7 ±10 % |      | 5.53 ±10 % |      |
| 5500 | 48.6 ±10 % |      | 5.65 ±10 % |      |
| 5600 | 48.5 ±10 % |      | 5.77 ±10 % |      |
| 5800 | 48.2 ±10 % |      | 6.00 ±10 % |      |

**7.4 SAR MEASUREMENT RESULT WITH BODY LIQUID**

|   |  |
|---|--|
| Software                                  | OPENSAR V4                                   |
| Phantom                                   | SN 20/09 SAM71                               |
| Probe                                     | SN 18/11 EPG122                              |
| Liquid                                    | Body Liquid Values: eps' : 53.2 sigma : 1.89 |
| Distance between dipole center and liquid | 10.0 mm                                      |
| Area scan resolution                      | dx=8mm/dy=8mm                                |
| Zoon Scan Resolution                      | dx=5mm/dy=5mm/dz=5mm                         |
| Frequency                                 | 2450 MHz                                     |
| Input power                               | 20 dBm                                       |
| Liquid Temperature                        | 21 °C  |
| Lab Temperature                           | 21 °C  |
| Lab Humidity                              | 45 %   |

| Frequency MHz | 1 g SAR (W/kg/W) | 10 g SAR (W/kg/W) |
|---------------|------------------|-------------------|
|               | measured         | measured          |
| 2450          | 52.90 (5.29)     | 24.09 (2.41)      |

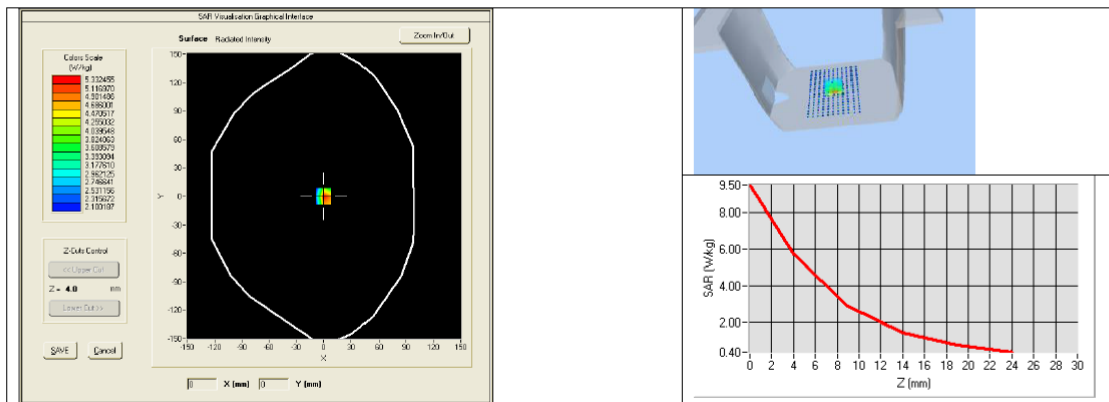



SAR REFERENCE DIPOLE CALIBRATION REPORT

Ref: ACR.109.7.18.SATU.A

**8 LIST OF EQUIPMENT**

| Equipment Summary Sheet         |                      |                    |   |   |
|---------------------------------|----------------------|--------------------|---|---|
| Equipment Description           | Manufacturer / Model | Identification No. | Current Calibration Date                      | Next Calibration Date                         |
| SAM Phantom                     | MVG                  | SN-20/09-SAM71     | Validated. No cal required.                   | Validated. No cal required.                   |
| COMOSAR Test Bench              | Version 3            | NA                 | Validated. No cal required.                   | Validated. No cal required.                   |
| Network Analyzer                | Rhode & Schwarz ZVA  | SN100132           | 02/2016                                       | 02/2019                                       |
| Calipers                        | Carrera              | CALIPER-01         | 01/2017                                       | 01/2020                                       |
| Reference Probe                 | MVG                  | EPG122 SN 18/11    | 10/2017                                       | 10/2018                                       |
| Multimeter                      | Keithley 2000        | 1188656            | 01/2017                                       | 01/2020                                       |
| Signal Generator                | Agilent E4438C       | MY49070581         | 01/2017                                       | 01/2020                                       |
| Amplifier                       | Aethercomm           | SN 046             | Characterized prior to test. No cal required. | Characterized prior to test. No cal required. |
| Power Meter                     | HP E4418A            | US38261498         | 01/2017                                       | 01/2020                                       |
| Power Sensor                    | HP ECP-E26A          | US37181460         | 01/2017                                       | 01/2020                                       |
| Directional Coupler             | Narda 4216-20        | 01386              | Characterized prior to test. No cal required. | Characterized prior to test. No cal required. |
| Temperature and Humidity Sensor | Control Company      | 150798832          | 11/2017                                       | 11/2020                                       |



## SAR Reference Dipole Calibration Report

Ref : ACR.109.8.18.SATU.A

**SHENZHEN NTEK TESTING TECHNOLOGY  
CO., LTD.**

**BUILDING E, FENDA SCIENCE PARK, SANWEI  
COMMUNITY, XIXIANG STREET,  
BAO'AN DISTRICT, SHENZHEN GUANGDONG, CHINA  
MVG COMOSAR REFERENCE DIPOLE**

**FREQUENCY: 2600 MHZ**

**SERIAL NO.: SN 03/15 DIP 2G600-356**

**Calibrated at MVG US**

**2105 Barrett Park Dr. - Kennesaw, GA 30144**



**Calibration Date: 04/19/2018**

*Summary:*

This document presents the method and results from an accredited SAR reference dipole calibration performed in MVG USA using the COMOSAR test bench. All calibration results are traceable to national metrology institutions.



SAR REFERENCE DIPOLE CALIBRATION REPORT

Ref: ACR.109.8.18.SATU.A

|                      | <i>Name</i>   | <i>Function</i> | <i>Date</i> | <i>Signature</i>     |
|----------------------|---------------|-----------------|-------------|----------------------|
| <i>Prepared by :</i> | Jérôme LUC    | Product Manager | 4/19/2018   | <i>JS</i>            |
| <i>Checked by :</i>  | Jérôme LUC    | Product Manager | 4/19/2018   | <i>JS</i>            |
| <i>Approved by :</i> | Kim RUTKOWSKI | Quality Manager | 4/19/2018   | <i>Kim Rutkowski</i> |

|                       | <i>Customer Name</i>                                |
|-----------------------|---|
| <i>Distribution :</i> | SHENZHEN NTEK<br>TESTING<br>TECHNOLOGY<br>CO., LTD. |

| <i>Issue</i> | <i>Date</i> | <i>Modifications</i> |
|--------------|-------------|----------------------|
| A            | 4/19/2018   | Initial release      |
|              |             |                      |
|              |             |                      |



SAR REFERENCE DIPOLE CALIBRATION REPORT

Ref: ACR.109.8.18.SATU.A

TABLE OF CONTENTS

1 Introduction ..... 4

2 Device Under Test ..... 4

3 Product Description ..... 4

    3.1 General Information ..... 4

4 Measurement Method ..... 5

    4.1 Return Loss Requirements ..... 5

    4.2 Mechanical Requirements ..... 5

5 Measurement Uncertainty ..... 5

    5.1 Return Loss ..... 5

    5.2 Dimension Measurement ..... 5

    5.3 Validation Measurement ..... 5

6 Calibration Measurement Results ..... 6

    6.1 Return Loss and Impedance In Head Liquid ..... 6

    6.2 Return Loss and Impedance In Body Liquid ..... 6

    6.3 Mechanical Dimensions ..... 6

7 Validation measurement ..... 7

    7.1 Head Liquid Measurement ..... 7

    7.2 SAR Measurement Result With Head Liquid ..... 8

    7.3 Body Liquid Measurement ..... 9

    7.4 SAR Measurement Result With Body Liquid ..... 10

8 List of Equipment ..... 11



SAR REFERENCE DIPOLE CALIBRATION REPORT

Ref: ACR.109.8.18.SATU.A

**1 INTRODUCTION**

This document contains a summary of the requirements set forth by the IEEE 1528, FCC KDBs and CEI/IEC 62209 standards for reference dipoles used for SAR measurement system validations and the measurements that were performed to verify that the product complies with the fore mentioned standards.

**2 DEVICE UNDER TEST**

| Device Under Test              |                                   |
|--------------------------------|-----------------------------------|
| Device Type                    | COMOSAR 2600 MHz REFERENCE DIPOLE |
| Manufacturer                   | MVG                               |
| Model                          | SID2600                           |
| Serial Number                  | SN 03/15 DIP 2G600-356            |
| Product Condition (new / used) | Used                              |

A yearly calibration interval is recommended.

**3 PRODUCT DESCRIPTION**

**3.1 GENERAL INFORMATION**

MVG’s COMOSAR Validation Dipoles are built in accordance to the IEEE 1528, FCC KDBs and CEI/IEC 62209 standards. The product is designed for use with the COMOSAR test bench only.



**Figure 1 – MVG COMOSAR Validation Dipole**





**SAR REFERENCE DIPOLE CALIBRATION REPORT**

Ref: ACR.109.8.18.SATU.A

**4 MEASUREMENT METHOD**

The IEEE 1528, FCC KDBs and CEI/IEC 62209 standards provide requirements for reference dipoles used for system validation measurements. The following measurements were performed to verify that the product complies with the fore mentioned standards.

**4.1 RETURN LOSS REQUIREMENTS**

The dipole used for SAR system validation measurements and checks must have a return loss of -20 dB or better. The return loss measurement shall be performed against a liquid filled flat phantom, with the phantom constructed as outlined in the fore mentioned standards.

**4.2 MECHANICAL REQUIREMENTS**

The IEEE Std. 1528 and CEI/IEC 62209 standards specify the mechanical components and dimensions of the validation dipoles, with the dimensions frequency and phantom shell thickness dependent. The COMOSAR test bench employs a 2 mm phantom shell thickness therefore the dipoles sold for use with the COMOSAR test bench comply with the requirements set forth for a 2 mm phantom shell thickness.

**5 MEASUREMENT UNCERTAINTY**

All uncertainties listed below represent an expanded uncertainty expressed at approximately the 95% confidence level using a coverage factor of k=2, traceable to the Internationally Accepted Guides to Measurement Uncertainty.

**5.1 RETURN LOSS**

The following uncertainties apply to the return loss measurement:

| Frequency band | Expanded Uncertainty on Return Loss |
|----------------|-------------------------------------|
| 400-6000MHz    | 0.1 dB                              |

**5.2 DIMENSION MEASUREMENT**

The following uncertainties apply to the dimension measurements:

| Length (mm) | Expanded Uncertainty on Length |
|-------------|--------------------------------|
| 3 - 300     | 0.05 mm                        |

**5.3 VALIDATION MEASUREMENT**

The guidelines outlined in the IEEE 1528, FCC KDBs, CENELEC EN50361 and CEI/IEC 62209 standards were followed to generate the measurement uncertainty for validation measurements.

| Scan Volume | Expanded Uncertainty |
|-------------|----------------------|
| 1 g         | 20.3 %               |



SAR REFERENCE DIPOLE CALIBRATION REPORT

Ref: ACR.109.8.18.SATU.A

|      |        |
|------|--------|
| 10 g | 20.1 % |
|------|--------|

6 CALIBRATION MEASUREMENT RESULTS

6.1 RETURN LOSS AND IMPEDANCE IN HEAD LIQUID

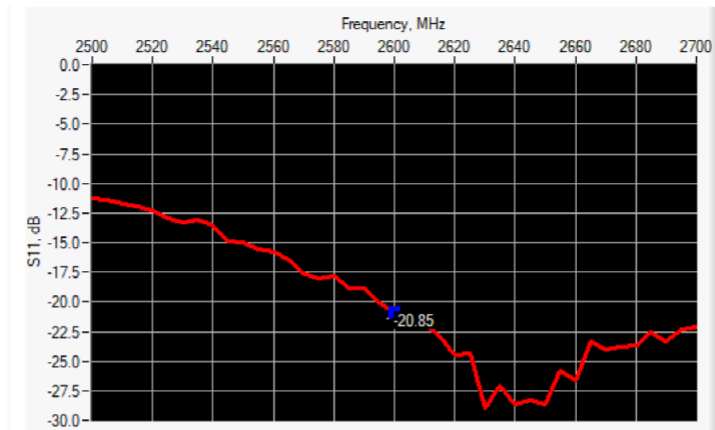

| Frequency (MHz) | Return Loss (dB) | Requirement (dB) | Impedance       |
|-----------------|------------------|------------------|-----------------|
| 2600            | -20.85           | -20              | 54.9 Ω - 8.3 jΩ |

6.2 RETURN LOSS AND IMPEDANCE IN BODY LIQUID

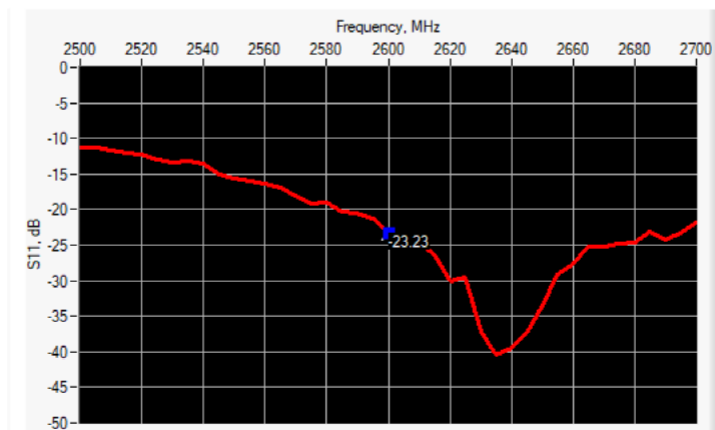

| Frequency (MHz) | Return Loss (dB) | Requirement (dB) | Impedance       |
|-----------------|------------------|------------------|-----------------|
| 2600            | -23.23           | -20              | 50.6 Ω - 7.0 jΩ |

6.3 MECHANICAL DIMENSIONS

| Frequency MHz | L mm       |          | h mm       |          | d mm      |          |
|---------------|------------|----------|------------|----------|-----------|----------|
|               | required   | measured | required   | measured | required  | measured |
| 300           | 420.0 ±1 % |          | 250.0 ±1 % |          | 6.35 ±1 % |          |



**SAR REFERENCE DIPOLE CALIBRATION REPORT**

Ref: ACR.109.8.18.SATU.A

|      |             |      |             |      |            |      |
|------|-------------|------|-------------|------|------------|------|
| 450  | 290.0 ±1 %. |      | 166.7 ±1 %. |      | 6.35 ±1 %. |      |
| 750  | 176.0 ±1 %. |      | 100.0 ±1 %. |      | 6.35 ±1 %. |      |
| 835  | 161.0 ±1 %. |      | 89.8 ±1 %.  |      | 3.6 ±1 %.  |      |
| 900  | 149.0 ±1 %. |      | 83.3 ±1 %.  |      | 3.6 ±1 %.  |      |
| 1450 | 89.1 ±1 %.  |      | 51.7 ±1 %.  |      | 3.6 ±1 %.  |      |
| 1500 | 80.5 ±1 %.  |      | 50.0 ±1 %.  |      | 3.6 ±1 %.  |      |
| 1640 | 79.0 ±1 %.  |      | 45.7 ±1 %.  |      | 3.6 ±1 %.  |      |
| 1750 | 75.2 ±1 %.  |      | 42.9 ±1 %.  |      | 3.6 ±1 %.  |      |
| 1800 | 72.0 ±1 %.  |      | 41.7 ±1 %.  |      | 3.6 ±1 %.  |      |
| 1900 | 68.0 ±1 %.  |      | 39.5 ±1 %.  |      | 3.6 ±1 %.  |      |
| 1950 | 66.3 ±1 %.  |      | 38.5 ±1 %.  |      | 3.6 ±1 %.  |      |
| 2000 | 64.5 ±1 %.  |      | 37.5 ±1 %.  |      | 3.6 ±1 %.  |      |
| 2100 | 61.0 ±1 %.  |      | 35.7 ±1 %.  |      | 3.6 ±1 %.  |      |
| 2300 | 55.5 ±1 %.  |      | 32.6 ±1 %.  |      | 3.6 ±1 %.  |      |
| 2450 | 51.5 ±1 %.  |      | 30.4 ±1 %.  |      | 3.6 ±1 %.  |      |
| 2600 | 48.5 ±1 %.  | PASS | 28.8 ±1 %.  | PASS | 3.6 ±1 %.  | PASS |
| 3000 | 41.5 ±1 %.  |      | 25.0 ±1 %.  |      | 3.6 ±1 %.  |      |
| 3500 | 37.0 ±1 %.  |      | 26.4 ±1 %.  |      | 3.6 ±1 %.  |      |
| 3700 | 34.7 ±1 %.  |      | 26.4 ±1 %.  |      | 3.6 ±1 %.  |      |

**7 VALIDATION MEASUREMENT**

The IEEE Std. 1528, FCC KDBs and CEI/IEC 62209 standards state that the system validation measurements must be performed using a reference dipole meeting the fore mentioned return loss and mechanical dimension requirements. The validation measurement must be performed against a liquid filled flat phantom, with the phantom constructed as outlined in the fore mentioned standards. Per the standards, the dipole shall be positioned below the bottom of the phantom, with the dipole length centered and parallel to the longest dimension of the flat phantom, with the top surface of the dipole at the described distance from the bottom surface of the phantom.

**7.1 HEAD LIQUID MEASUREMENT**

| Frequency<br>MHz | Relative permittivity (ε <sub>r</sub> ) |          | Conductivity (σ) S/m |          |
|------------------|---|----------|----------------------|----------|
|                  | required                                | measured | required             | measured |
| 300              | 45.3 ±5 %                               |          | 0.87 ±5 %            |          |
| 450              | 43.5 ±5 %                               |          | 0.87 ±5 %            |          |
| 750              | 41.9 ±5 %                               |          | 0.89 ±5 %            |          |
| 835              | 41.5 ±5 %                               |          | 0.90 ±5 %            |          |
| 900              | 41.5 ±5 %                               |          | 0.97 ±5 %            |          |
| 1450             | 40.5 ±5 %                               |          | 1.20 ±5 %            |          |
| 1500             | 40.4 ±5 %                               |          | 1.23 ±5 %            |          |
| 1640             | 40.2 ±5 %                               |          | 1.31 ±5 %            |          |
| 1750             | 40.1 ±5 %                               |          | 1.37 ±5 %            |          |

Page: 7/11

*This document shall not be reproduced, except in full or in part, without the written approval of MVG. The information contained herein is to be used only for the purpose for which it is submitted and is not to be released in whole or part without written approval of MVG.*



SAR REFERENCE DIPOLE CALIBRATION REPORT

Ref: ACR.109.8.18.SATU.A

|      |           |      |           |      |
|------|-----------|------|-----------|------|
| 1800 | 40.0 ±5 % |      | 1.40 ±5 % |      |
| 1900 | 40.0 ±5 % |      | 1.40 ±5 % |      |
| 1950 | 40.0 ±5 % |      | 1.40 ±5 % |      |
| 2000 | 40.0 ±5 % |      | 1.40 ±5 % |      |
| 2100 | 39.8 ±5 % |      | 1.49 ±5 % |      |
| 2300 | 39.5 ±5 % |      | 1.67 ±5 % |      |
| 2450 | 39.2 ±5 % |      | 1.80 ±5 % |      |
| 2600 | 39.0 ±5 % | PASS | 1.96 ±5 % | PASS |
| 3000 | 38.5 ±5 % |      | 2.40 ±5 % |      |
| 3500 | 37.9 ±5 % |      | 2.91 ±5 % |      |

7.2 SAR MEASUREMENT RESULT WITH HEAD LIQUID

The IEEE Std. 1528 and CEI/IEC 62209 standards state that the system validation measurements should produce the SAR values shown below (for phantom thickness of 2 mm), within the uncertainty for the system validation. All SAR values are normalized to 1 W forward power. In bracket, the measured SAR is given with the used input power.

|   |  |
|---|--|
| Software                                  | OPENSAR V4                                   |
| Phantom                                   | SN 20/09 SAM71                               |
| Probe                                     | SN 18/11 EPG122                              |
| Liquid                                    | Head Liquid Values: eps' : 39.8 sigma : 1.99 |
| Distance between dipole center and liquid | 10.0 mm                                      |
| Area scan resolution                      | dx=8mm/dy=8mm                                |
| Zoon Scan Resolution                      | dx=5mm/dy=5mm/dz=5mm                         |
| Frequency                                 | 2600 MHz                                     |
| Input power                               | 20 dBm                                       |
| Liquid Temperature                        | 21 °C  |
| Lab Temperature                           | 21 °C  |
| Lab Humidity                              | 45 %   |

| Frequency<br>MHz | 1 g SAR (W/kg/W) |          | 10 g SAR (W/kg/W) |          |
|------------------|------------------|----------|-------------------|----------|
|                  | required         | measured | required          | measured |
| 300              | 2.85             |          | 1.94              |          |
| 450              | 4.58             |          | 3.06              |          |
| 750              | 8.49             |          | 5.55              |          |
| 835              | 9.56             |          | 6.22              |          |
| 900              | 10.9             |          | 6.99              |          |
| 1450             | 29               |          | 16                |          |
| 1500             | 30.5             |          | 16.8              |          |
| 1640             | 34.2             |          | 18.4              |          |
| 1750             | 36.4             |          | 19.3              |          |
| 1800             | 38.4             |          | 20.1              |          |



**SAR REFERENCE DIPOLE CALIBRATION REPORT**

Ref: ACR.109.8.18.SATU.A

|      |      |              |      |              |
|------|------|--------------|------|--------------|
| 1900 | 39.7 |              | 20.5 |              |
| 1950 | 40.5 |              | 20.9 |              |
| 2000 | 41.1 |              | 21.1 |              |
| 2100 | 43.6 |              | 21.9 |              |
| 2300 | 48.7 |              | 23.3 |              |
| 2450 | 52.4 |              | 24   |              |
| 2600 | 55.3 | 55.60 (5.56) | 24.6 | 24.60 (2.46) |
| 3000 | 63.8 |              | 25.7 |              |
| 3500 | 67.1 |              | 25   |              |
| 3700 | 67.4 |              | 24.2 |              |

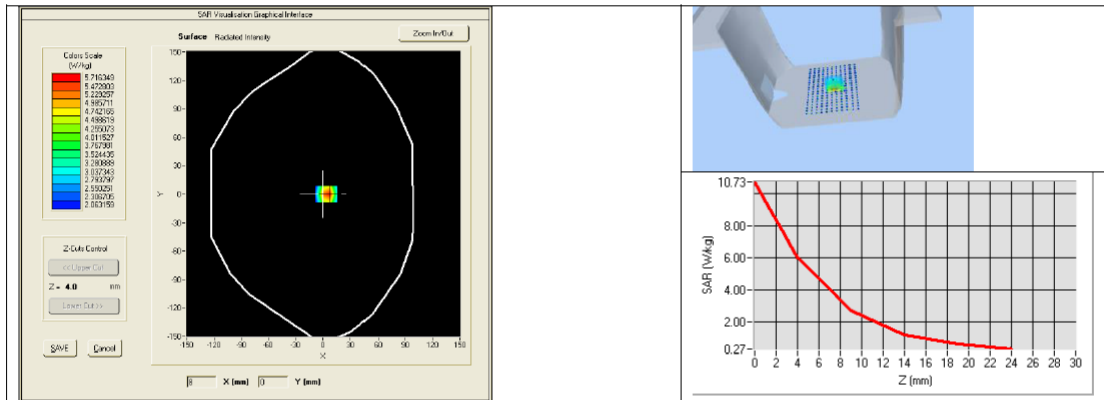

**7.3 BODY LIQUID MEASUREMENT**

| Frequency MHz | Relative permittivity ( $\epsilon_r'$ ) |          | Conductivity ( $\sigma$ ) S/m |          |
|---------------|---|----------|-------------------------------|----------|
|               | required                                | measured | required                      | measured |
| 150           | 61.9 ± 5 %                              |          | 0.80 ± 5 %                    |          |
| 300           | 58.2 ± 5 %                              |          | 0.92 ± 5 %                    |          |
| 450           | 56.7 ± 5 %                              |          | 0.94 ± 5 %                    |          |
| 750           | 55.5 ± 5 %                              |          | 0.96 ± 5 %                    |          |
| 835           | 55.2 ± 5 %                              |          | 0.97 ± 5 %                    |          |
| 900           | 55.0 ± 5 %                              |          | 1.05 ± 5 %                    |          |
| 915           | 55.0 ± 5 %                              |          | 1.06 ± 5 %                    |          |
| 1450          | 54.0 ± 5 %                              |          | 1.30 ± 5 %                    |          |
| 1610          | 53.8 ± 5 %                              |          | 1.40 ± 5 %                    |          |
| 1800          | 53.3 ± 5 %                              |          | 1.52 ± 5 %                    |          |
| 1900          | 53.3 ± 5 %                              |          | 1.52 ± 5 %                    |          |
| 2000          | 53.3 ± 5 %                              |          | 1.52 ± 5 %                    |          |
| 2100          | 53.2 ± 5 %                              |          | 1.62 ± 5 %                    |          |



**SAR REFERENCE DIPOLE CALIBRATION REPORT**

Ref: ACR.109.8.18.SATU.A

|      |            |      |            |      |
|------|------------|------|------------|------|
| 2300 | 52.9 ±5 %  |      | 1.81 ±5 %  |      |
| 2450 | 52.7 ±5 %  |      | 1.95 ±5 %  |      |
| 2600 | 52.5 ±5 %  | PASS | 2.16 ±5 %  | PASS |
| 3000 | 52.0 ±5 %  |      | 2.73 ±5 %  |      |
| 3500 | 51.3 ±5 %  |      | 3.31 ±5 %  |      |
| 3700 | 51.0 ±5 %  |      | 3.55 ±5 %  |      |
| 5200 | 49.0 ±10 % |      | 5.30 ±10 % |      |
| 5300 | 48.9 ±10 % |      | 5.42 ±10 % |      |
| 5400 | 48.7 ±10 % |      | 5.53 ±10 % |      |
| 5500 | 48.6 ±10 % |      | 5.65 ±10 % |      |
| 5600 | 48.5 ±10 % |      | 5.77 ±10 % |      |
| 5800 | 48.2 ±10 % |      | 6.00 ±10 % |      |

**7.4 SAR MEASUREMENT RESULT WITH BODY LIQUID**

|   |  |
|---|--|
| Software                                  | OPENSAR V4                                   |
| Phantom                                   | SN 20/09 SAM71                               |
| Probe                                     | SN 18/11 EPG122                              |
| Liquid                                    | Body Liquid Values: eps' : 52.5 sigma : 2.23 |
| Distance between dipole center and liquid | 10.0 mm                                      |
| Area scan resolution                      | dx=8mm/dy=8mm                                |
| Zoon Scan Resolution                      | dx=5mm/dy=5mm/dz=5mm                         |
| Frequency                                 | 2600 MHz                                     |
| Input power                               | 20 dBm                                       |
| Liquid Temperature                        | 21 °C  |
| Lab Temperature                           | 21 °C  |
| Lab Humidity                              | 45 %   |

| Frequency MHz | 1 g SAR (W/kg/W) | 10 g SAR (W/kg/W) |
|---------------|------------------|-------------------|
|               | measured         | measured          |
| 2600          | 52.49 (5.25)     | 23.74 (2.37)      |

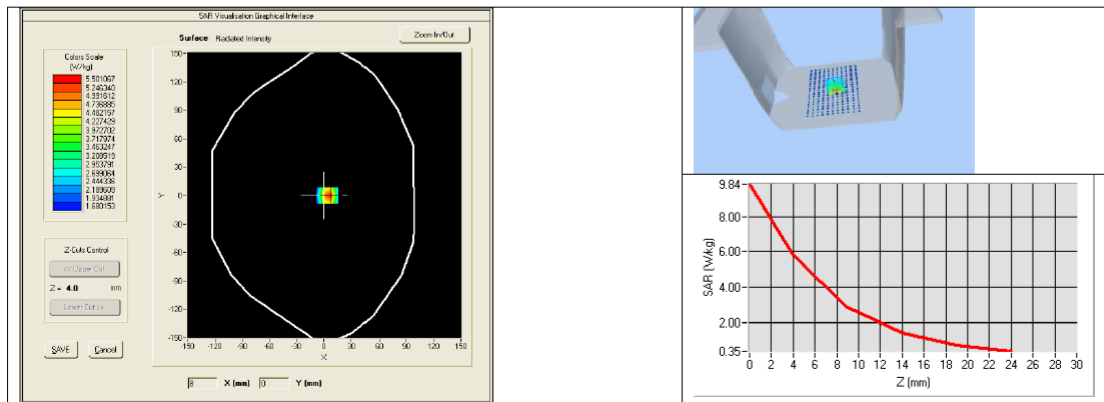



SAR REFERENCE DIPOLE CALIBRATION REPORT

Ref: ACR.109.8.18.SATU.A

**8 LIST OF EQUIPMENT**

| Equipment Summary Sheet         |                      |                    |   |   |
|---------------------------------|----------------------|--------------------|---|---|
| Equipment Description           | Manufacturer / Model | Identification No. | Current Calibration Date                      | Next Calibration Date                         |
| SAM Phantom                     | MVG                  | SN-20/09-SAM71     | Validated. No cal required.                   | Validated. No cal required.                   |
| COMOSAR Test Bench              | Version 3            | NA                 | Validated. No cal required.                   | Validated. No cal required.                   |
| Network Analyzer                | Rhode & Schwarz ZVA  | SN100132           | 02/2016                                       | 02/2019                                       |
| Calipers                        | Carrera              | CALIPER-01         | 01/2017                                       | 01/2020                                       |
| Reference Probe                 | MVG                  | EPG122 SN 18/11    | 10/2017                                       | 10/2018                                       |
| Multimeter                      | Keithley 2000        | 1188656            | 01/2017                                       | 01/2020                                       |
| Signal Generator                | Agilent E4438C       | MY49070581         | 01/2017                                       | 01/2020                                       |
| Amplifier                       | Aethercomm           | SN 046             | Characterized prior to test. No cal required. | Characterized prior to test. No cal required. |
| Power Meter                     | HP E4418A            | US38261498         | 01/2017                                       | 01/2020                                       |
| Power Sensor                    | HP ECP-E26A          | US37181460         | 01/2017                                       | 01/2020                                       |
| Directional Coupler             | Narda 4216-20        | 01386              | Characterized prior to test. No cal required. | Characterized prior to test. No cal required. |
| Temperature and Humidity Sensor | Control Company      | 150798832          | 11/2017                                       | 11/2020                                       |





## SAR Reference Waveguide Calibration Report

Ref: ACR.109.9.18.SATU.A

**SHENZHEN NTEK TESTING TECHNOLOGY  
CO., LTD.**

**BUILDING E, FENDA SCIENCE PARK, SANWEI  
COMMUNITY, XIXIANG STREET, BAO'AN  
DISTRICT, SHENZHEN GUANGDONG, CHINA MVG  
COMOSAR REFERENCE WAVEGUIDE**

**FREQUENCY: 5000-6000 MHZ**

**SERIAL NO.: SN 13/14 WGA 33**

**Calibrated at MVG US**

**2105 Barrett Park Dr. - Kennesaw, GA 30144**



**Calibration Date: 04/19/2018**

*Summary:*

This document presents the method and results from an accredited SAR reference waveguide calibration performed in MVG USA using the COMOSAR test bench. All calibration results are traceable to national metrology institutions.



SAR REFERENCE WAVEGUIDE CALIBRATION REPORT

Ref: ACR.109.9.18.SATU.A

|                      | <i>Name</i>   | <i>Function</i> | <i>Date</i> | <i>Signature</i>     |
|----------------------|---------------|-----------------|-------------|----------------------|
| <i>Prepared by :</i> | Jérôme LUC    | Product Manager | 4/19/2018   | <i>JL</i>            |
| <i>Checked by :</i>  | Jérôme LUC    | Product Manager | 4/19/2018   | <i>JL</i>            |
| <i>Approved by :</i> | Kim RUTKOWSKI | Quality Manager | 4/19/2018   | <i>Kim Rutkowski</i> |

|                       | <i>Customer Name</i>                                |
|-----------------------|---|
| <i>Distribution :</i> | SHENZHEN NTEK<br>TESTING<br>TECHNOLOGY<br>CO., LTD. |

| <i>Issue</i> | <i>Date</i> | <i>Modifications</i> |
|--------------|-------------|----------------------|
| A            | 4/19/2018   | Initial release      |
|              |             |                      |
|              |             |                      |



SAR REFERENCE WAVEGUIDE CALIBRATION REPORT

Ref: ACR.109.9.18.SATU.A

TABLE OF CONTENTS

1 Introduction..... 4

2 Device Under Test ..... 4

3 Product Description ..... 4

    3.1 General Information ..... 4

4 Measurement Method ..... 4

    4.1 Return Loss Requirements ..... 4

    4.2 Mechanical Requirements ..... 4

5 Measurement Uncertainty ..... 5

    5.1 Return Loss ..... 5

    5.2 Dimension Measurement ..... 5

    5.3 Validation Measurement ..... 5

6 Calibration Measurement Results ..... 5

    6.1 Return Loss ..... 5

    6.2 Mechanical Dimensions ..... 6

7 Validation measurement ..... 7

    7.1 Head Liquid Measurement ..... 7

    7.2 Measurement Result ..... 7

    7.3 Body Measurement Result ..... 10

8 List of Equipment ..... 13



**SAR REFERENCE WAVEGUIDE CALIBRATION REPORT**

Ref. ACR.109.9.18.SATU.A

**1 INTRODUCTION**

This document contains a summary of the requirements set forth by the IEEE 1528 and CEI/IEC 62209 standards for reference waveguides used for SAR measurement system validations and the measurements that were performed to verify that the product complies with the fore mentioned standards.

**2 DEVICE UNDER TEST**

| Device Under Test              |   |
|--------------------------------|---|
| Device Type                    | COMOSAR 5000-6000 MHz REFERENCE WAVEGUIDE |
| Manufacturer                   | MVG                                       |
| Model                          | SWG5500                                   |
| Serial Number                  | SN 13/14 WGA 33                           |
| Product Condition (new / used) | Used                                      |

A yearly calibration interval is recommended.

**3 PRODUCT DESCRIPTION**

**3.1 GENERAL INFORMATION**

MVG’s COMOSAR Validation Waveguides are built in accordance to the IEEE 1528 and CEI/IEC 62209 standards.

**4 MEASUREMENT METHOD**

The IEEE 1528 and CEI/IEC 62209 standards provide requirements for reference waveguides used for system validation measurements. The following measurements were performed to verify that the product complies with the fore mentioned standards.

**4.1 RETURN LOSS REQUIREMENTS**

The waveguide used for SAR system validation measurements and checks must have a return loss of -8 dB or better. The return loss measurement shall be performed with matching layer placed in the open end of the waveguide, with the waveguide and matching layer in direct contact with the phantom shell as outlined in the fore mentioned standards.

**4.2 MECHANICAL REQUIREMENTS**

The IEEE 1528 and CEI/IEC 62209 standards specify the mechanical dimensions of the validation waveguide, the specified dimensions are as shown in Section 6.2. Figure 1 shows how the dimensions relate to the physical construction of the waveguide.



**SAR REFERENCE WAVEGUIDE CALIBRATION REPORT**

Ref: ACR.109.9.18.SATU.A

**5 MEASUREMENT UNCERTAINTY**

All uncertainties listed below represent an expanded uncertainty expressed at approximately the 95% confidence level using a coverage factor of k=2, traceable to the Internationally Accepted Guides to Measurement Uncertainty.

**5.1 RETURN LOSS**

The following uncertainties apply to the return loss measurement:

| Frequency band | Expanded Uncertainty on Return Loss |
|----------------|-------------------------------------|
| 400-6000MHz    | 0.1 dB                              |

**5.2 DIMENSION MEASUREMENT**

The following uncertainties apply to the dimension measurements:

| Length (mm) | Expanded Uncertainty on Length |
|-------------|--------------------------------|
| 3 - 300     | 0.05 mm                        |

**5.3 VALIDATION MEASUREMENT**

The guidelines outlined in the IEEE 1528 and CEI/IEC 62209 standards were followed to generate the measurement uncertainty for validation measurements.

| Scan Volume | Expanded Uncertainty |
|-------------|----------------------|
| 1 g         | 20.3 %               |
| 10 g        | 20.1 %               |

**6 CALIBRATION MEASUREMENT RESULTS**

**6.1 RETURN LOSS IN HEAD LIQUID**

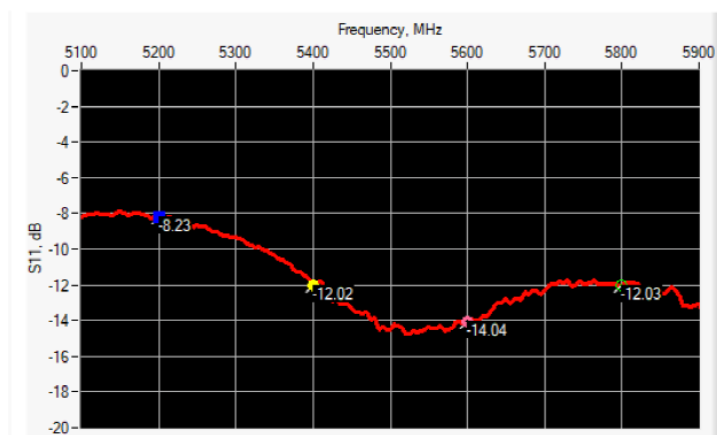



SAR REFERENCE WAVEGUIDE CALIBRATION REPORT

Ref: ACR.109.9.18.SATU.A

| Frequency (MHz) | Return Loss (dB) | Requirement (dB) | Impedance          |
|-----------------|------------------|------------------|--------------------|
| 5200            | -8.23            | -8               | 26.31 Ω + 19.19 jΩ |
| 5400            | -12.02           | -8               | 83.38 Ω - 2.98 jΩ  |
| 5600            | -14.04           | -8               | 33.47 Ω - 0.96 jΩ  |
| 5800            | -12.03           | -8               | 59.85 Ω + 26.64 jΩ |

6.2 RETURN LOSS IN BODY LIQUID

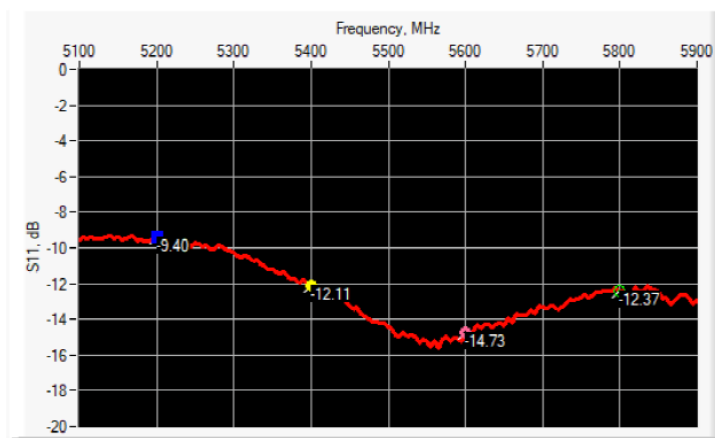

| Frequency (MHz) | Return Loss (dB) | Requirement (dB) | Impedance          |
|-----------------|------------------|------------------|--------------------|
| 5200            | -9.40            | -8               | 97.78 Ω + 15.77 jΩ |
| 5400            | -12.11           | -8               | 32.53 Ω - 11.03 jΩ |
| 5600            | -14.73           | -8               | 67.48 Ω + 13.08 jΩ |
| 5800            | -12.37           | -8               | 36.66 Ω - 16.68 jΩ |

6.3 MECHANICAL DIMENSIONS

| Frequency (MHz) | L (mm)       |          | W (mm)       |          | L <sub>f</sub> (mm) |          | W <sub>f</sub> (mm) |          | T (mm)      |          |
|-----------------|--------------|----------|--------------|----------|---------------------|----------|---------------------|----------|-------------|----------|
|                 | Requirement  | Measured | Requirement  | Measured | Requirement         | Measured | Requirement         | Measured | Requirement | Measured |
| 5200            | 40.39 ± 0.13 | PASS     | 20.19 ± 0.13 | PASS     | 81.03 ± 0.13        | PASS     | 61.98 ± 0.13        | PASS     | 5.3*        | PASS     |
| 5800            | 40.39 ± 0.13 | PASS     | 20.19 ± 0.13 | PASS     | 81.03 ± 0.13        | PASS     | 61.98 ± 0.13        | PASS     | 4.3*        | PASS     |

\* The tolerance for the matching layer is included in the return loss measurement.



SAR REFERENCE WAVEGUIDE CALIBRATION REPORT

Ref: ACR.109.9.18.SATU.A

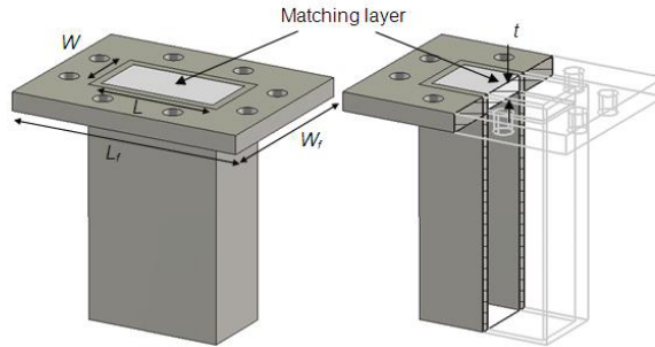

Figure 1: Validation Waveguide Dimensions

7 VALIDATION MEASUREMENT

The IEEE Std. 1528 and CEI/IEC 62209 standards state that the system validation measurements must be performed using a reference waveguide meeting the fore mentioned return loss and mechanical dimension requirements. The validation measurement must be performed with the matching layer placed in the open end of the waveguide, with the waveguide and matching layer in direct contact with the phantom shell.

7.1 HEAD LIQUID MEASUREMENT

| Frequency MHz | Relative permittivity ( $\epsilon_r'$ ) |          | Conductivity ( $\sigma$ ) S/m |          |
|---------------|---|----------|-------------------------------|----------|
|               | required                                | measured | required                      | measured |
| 5000          | 36.2 ±10 %                              |          | 4.45 ±10 %                    |          |
| 5100          | 36.1 ±10 %                              |          | 4.56 ±10 %                    |          |
| 5200          | 36.0 ±10 %                              | PASS     | 4.66 ±10 %                    | PASS     |
| 5300          | 35.9 ±10 %                              |          | 4.76 ±10 %                    |          |
| 5400          | 35.8 ±10 %                              | PASS     | 4.86 ±10 %                    | PASS     |
| 5500          | 35.6 ±10 %                              |          | 4.97 ±10 %                    |          |
| 5600          | 35.5 ±10 %                              | PASS     | 5.07 ±10 %                    | PASS     |
| 5700          | 35.4 ±10 %                              |          | 5.17 ±10 %                    |          |
| 5800          | 35.3 ±10 %                              | PASS     | 5.27 ±10 %                    | PASS     |
| 5900          | 35.2 ±10 %                              |          | 5.38 ±10 %                    |          |
| 6000          | 35.1 ±10 %                              |          | 5.48 ±10 %                    |          |

7.2 SAR MEASUREMENT RESULT WITH HEAD LIQUID

At those frequencies, the target SAR value can not be generic. Hereunder is the target SAR value defined by MVG, within the uncertainty for the system validation. All SAR values are normalized to 1 W net power. In bracket, the measured SAR is given with the used input power.





**SAR REFERENCE WAVEGUIDE CALIBRATION REPORT**

Ref: ACR.109.9.18.SATU.A

|  |  |
|--|--|
| Software                                     | OPENSAR V4   |
| Phantom                                      | SN 20/09 SAM71   |
| Probe  | SN 18/11 EPG122  |
| Liquid                                       | Head Liquid Values 5200 MHz: eps' :35.64 sigma : 4.67<br>Head Liquid Values 5400 MHz: eps' :36.44 sigma : 4.87<br>Head Liquid Values 5600 MHz: eps' :36.66 sigma : 5.17<br>Head Liquid Values 5800 MHz: eps' :35.31 sigma : 5.31 |
| Distance between dipole waveguide and liquid | 0 mm   |
| Area scan resolution                         | dx=8mm/dy=8mm  |
| Zoon Scan Resolution                         | dx=4mm/dy=4m/dz=2mm  |
| Frequency                                    | 5200 MHz<br>5400 MHz<br>5600 MHz<br>5800 MHz   |
| Input power                                  | 20 dBm   |
| Liquid Temperature                           | 21 °C  |
| Lab Temperature                              | 21 °C  |
| Lab Humidity                                 | 45 %   |

| Frequency (MHz) | 1 g SAR (W/kg) |                | 10 g SAR (W/kg) |              |
|-----------------|----------------|----------------|-----------------|--------------|
|                 | required       | measured       | required        | measured     |
| 5200            | 159.00         | 160.94 (16.09) | 56.90           | 55.97 (5.60) |
| 5400            | 166.40         | 170.60 (17.06) | 58.43           | 58.93 (5.89) |
| 5600            | 173.80         | 175.02 (17.50) | 59.97           | 59.90 (5.99) |
| 5800            | 181.20         | 184.13 (18.41) | 61.50           | 62.74 (6.27) |

**SAR MEASUREMENT PLOTS @ 5200 MHz**

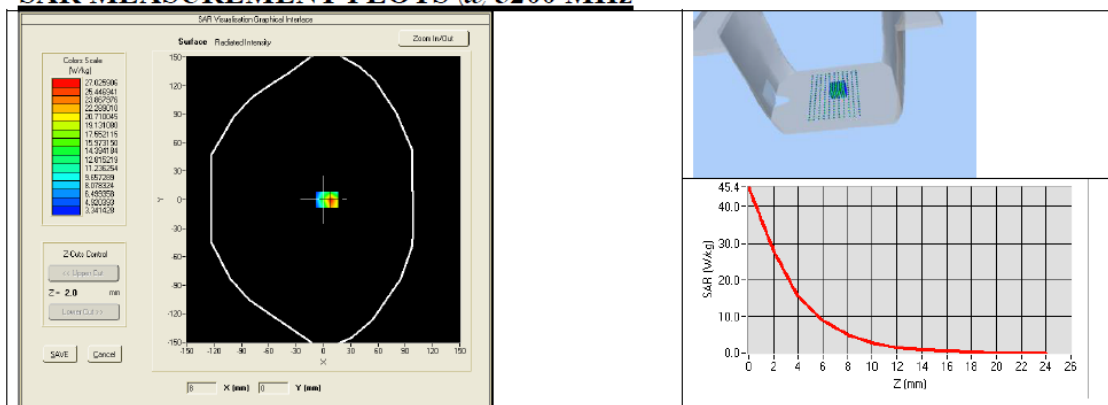



**SAR REFERENCE WAVEGUIDE CALIBRATION REPORT**

Ref: ACR.109.9.18.SATU.A

**SAR MEASUREMENT PLOTS @ 5400 MHz**

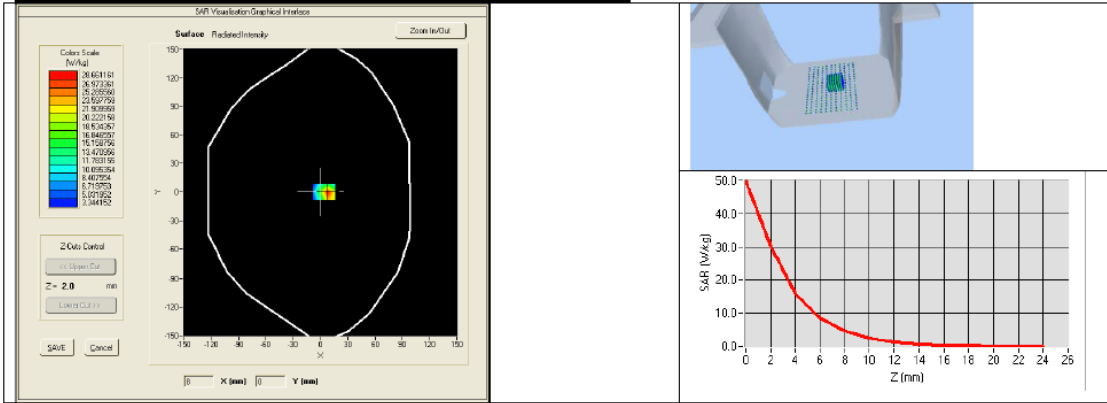

**SAR MEASUREMENT PLOTS @ 5600 MHz**

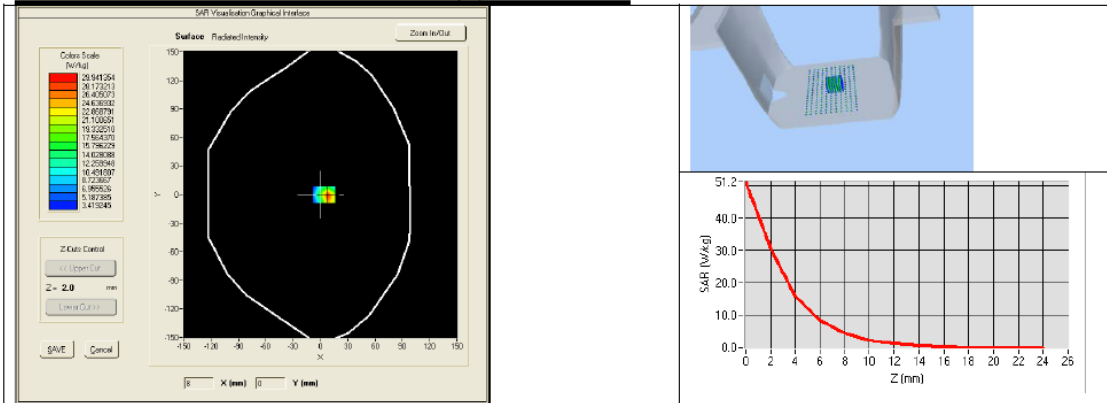

**SAR MEASUREMENT PLOTS @ 5800 MHz**

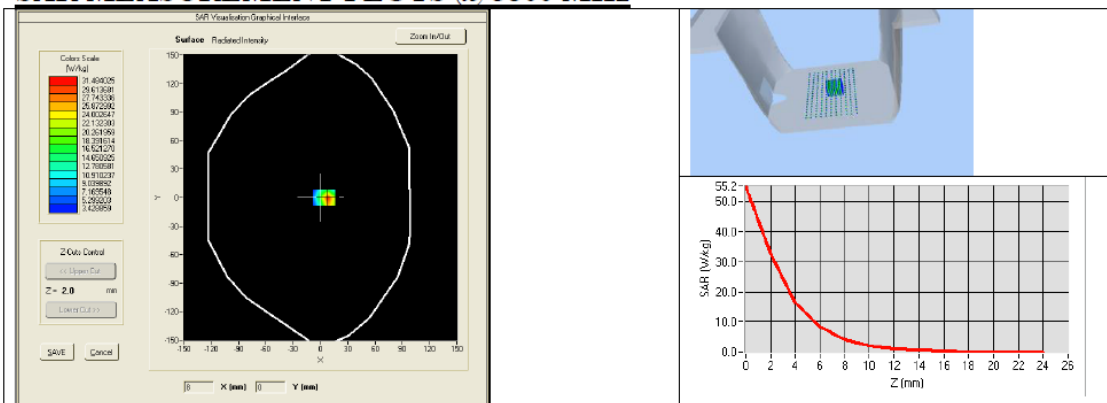



SAR REFERENCE WAVEGUIDE CALIBRATION REPORT

Ref: ACR.109.9.18.SATU.A

7.3 BODY LIQUID MEASUREMENT

| Frequency MHz | Relative permittivity ( $\epsilon_r'$ ) |          | Conductivity ( $\sigma$ ) S/m |          |
|---------------|---|----------|-------------------------------|----------|
|               | required                                | measured | required                      | measured |
| 5200          | 49.0 $\pm$ 10 %                         | PASS     | 5.30 $\pm$ 10 %               | PASS     |
| 5300          | 48.9 $\pm$ 10 %                         |          | 5.42 $\pm$ 10 %               |          |
| 5400          | 48.7 $\pm$ 10 %                         | PASS     | 5.53 $\pm$ 10 %               | PASS     |
| 5500          | 48.6 $\pm$ 10 %                         |          | 5.65 $\pm$ 10 %               |          |
| 5600          | 48.5 $\pm$ 10 %                         | PASS     | 5.77 $\pm$ 10 %               | PASS     |
| 5800          | 48.2 $\pm$ 10 %                         | PASS     | 6.00 $\pm$ 10 %               | PASS     |

7.4 SAR MEASUREMENT RESULT WITH BODY LIQUID

|  |  |
|--|--|
| Software                                     | OPENSAR V4   |
| Phantom                                      | SN 20/09 SAM71   |
| Probe  | SN 18/11 EPG122  |
| Liquid                                       | Body Liquid Values 5200 MHz: $\epsilon_r'$ :48.64 sigma : 5.51<br>Body Liquid Values 5400 MHz: $\epsilon_r'$ :46.52 sigma : 5.77<br>Body Liquid Values 5600 MHz: $\epsilon_r'$ :46.79 sigma : 5.77<br>Body Liquid Values 5800 MHz: $\epsilon_r'$ :47.04 sigma : 6.10 |
| Distance between dipole waveguide and liquid | 0 mm   |
| Area scan resolution                         | dx=8mm/dy=8mm  |
| Zoon Scan Resolution                         | dx=4mm/dy=4m/dz=2mm  |
| Frequency                                    | 5200 MHz<br>5400 MHz<br>5600 MHz<br>5800 MHz   |
| Input power                                  | 20 dBm   |
| Liquid Temperature                           | 21 °C  |
| Lab Temperature                              | 21 °C  |
| Lab Humidity                                 | 45 %   |

| Frequency (MHz) | 1 g SAR (W/kg)<br>measured | 10 g SAR (W/kg)<br>measured |
|-----------------|----------------------------|-----------------------------|
| 5200            | 156.85 (15.68)             | 55.20 (5.52)                |
| 5400            | 163.97 (16.40)             | 57.26 (5.73)                |
| 5600            | 166.58 (16.66)             | 57.87 (5.79)                |
| 5800            | 169.30 (16.93)             | 58.49 (5.85)                |



**SAR REFERENCE WAVEGUIDE CALIBRATION REPORT**

Ref: ACR.109.9.18.SATU.A

**BODY SAR MEASUREMENT PLOTS @ 5200 MHz**

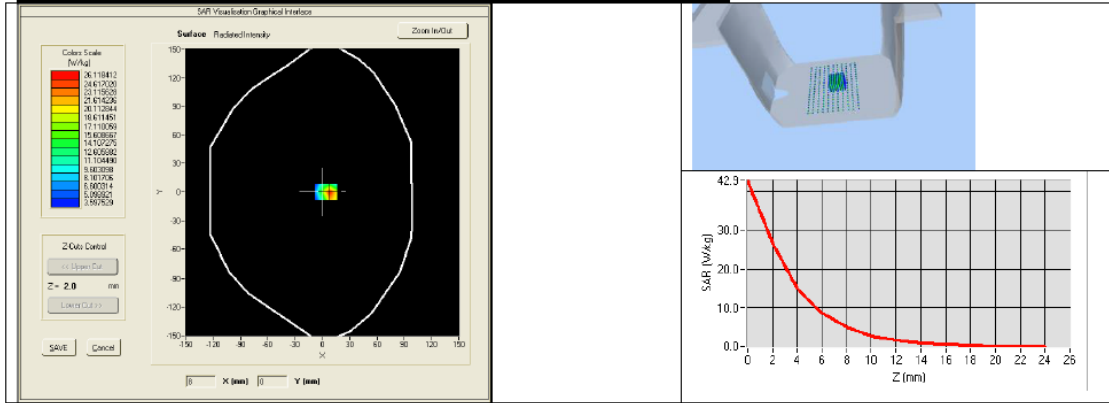

**BODY SAR MEASUREMENT PLOTS @ 5400 MHz**

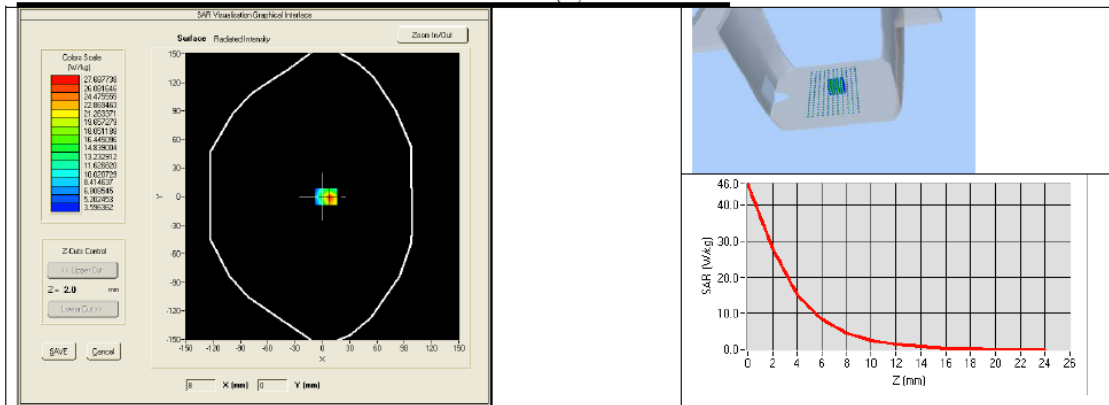

**BODY SAR MEASUREMENT PLOTS @ 5600 MHz**

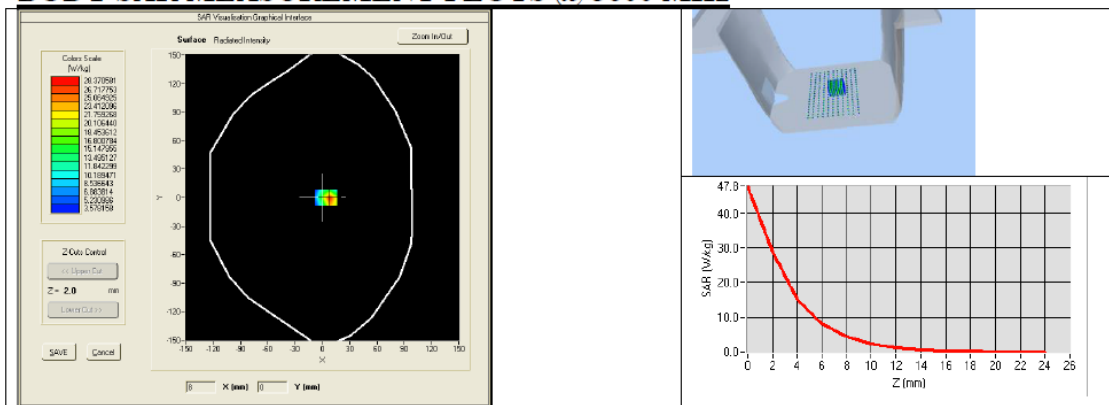



SAR REFERENCE WAVEGUIDE CALIBRATION REPORT

Ref: ACR.109.9.18.SATU.A

**BODY SAR MEASUREMENT PLOTS @ 5800 MHz**

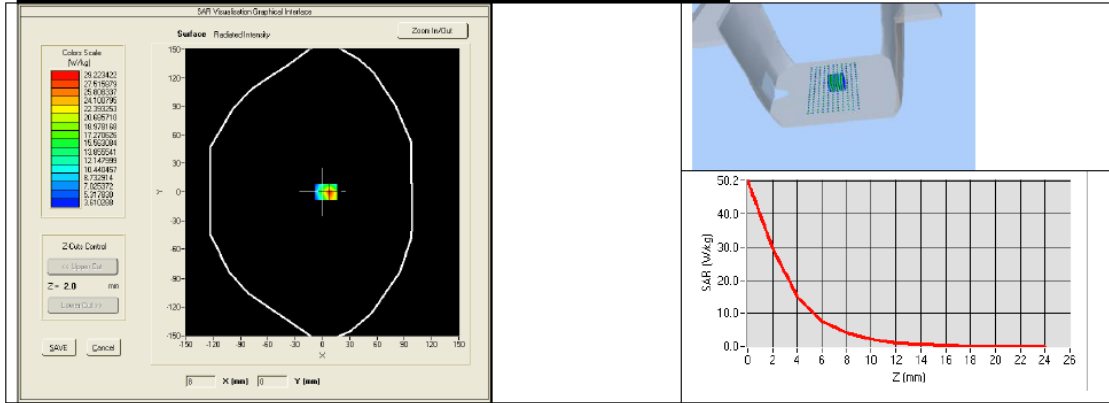



SAR REFERENCE WAVEGUIDE CALIBRATION REPORT

Ref: ACR.109.9.18.SATU.A

8 LIST OF EQUIPMENT

| Equipment Summary Sheet         |                      |                    |   |   |
|---------------------------------|----------------------|--------------------|---|---|
| Equipment Description           | Manufacturer / Model | Identification No. | Current Calibration Date                      | Next Calibration Date                         |
| Flat Phantom                    | MVG                  | SN-20/09-SAM71     | Validated. No cal required.                   | Validated. No cal required.                   |
| COMOSAR Test Bench              | Version 3            | NA                 | Validated. No cal required.                   | Validated. No cal required.                   |
| Network Analyzer                | Rhode & Schwarz ZVA  | SN100132           | 02/2016                                       | 02/2019                                       |
| Calipers                        | Carrera              | CALIPER-01         | 01/2017                                       | 01/2020                                       |
| Reference Probe                 | MVG                  | EPG122 SN 18/11    | 10/2017                                       | 10/2018                                       |
| Multimeter                      | Keithley 2000        | 1188656            | 01/2017                                       | 01/2020                                       |
| Signal Generator                | Agilent E4438C       | MY49070581         | 01/2017                                       | 01/2020                                       |
| Amplifier                       | Aethercomm           | SN 046             | Characterized prior to test. No cal required. | Characterized prior to test. No cal required. |
| Power Meter                     | HP E4418A            | US38261498         | 01/2017                                       | 01/2020                                       |
| Power Sensor                    | HP ECP-E26A          | US37181460         | 01/2017                                       | 01/2020                                       |
| Directional Coupler             | Narda 4216-20        | 01386              | Characterized prior to test. No cal required. | Characterized prior to test. No cal required. |
| Temperature and Humidity Sensor | Control Company      | 150798832          | 11/2017                                       | 11/2020                                       |