



CFR 47 FCC PART 15 SUBPART C

CERTIFICATION TEST REPORT

For

Digital Video Baby Monitor

MODEL NUMBER: SCD843/37, SCD8ab/**

FCC ID: 2AW4TSCD843

REPORT NUMBER: 4789480255.3-8

ISSUE DATE: Aug 04, 2020

Prepared for

**PHILIPS Electronics Hong Kong Limited
G/F, Building 5E, No. 5, Science Park East Avenue, Hong Kong Science Park,
ShaTin, New Territories, Hong Kong**

Prepared by

UL Verification Services (Guangzhou) Co., Ltd, Song Shan Lake Branch

Building 10, Innovation Technology Park, No. 1, Li Bin Road, Song Shan Lake Hi-Tech Development Zone Dongguan, 523808, People's Republic of China

Tel: +86 769 22038881

Fax: +86 769 33244054

Website: www.ul.com



Revision History

<u>Rev.</u>	<u>Issue Date</u>	<u>Revisions</u>	<u>Revised By</u>
V0	08/04/2020	Initial Issue	



Summary of Test Results			
Clause	Test Items	FCC Rules	Test Results
1	20dB Bandwidth and 99% Occupied Bandwidth	FCC 15.247 (a) (1)	Pass
2	Conducted Output Power	FCC 15.247 (b) (1)	Pass
3	Carrier Hopping Channel Separation	FCC 15.247 (a) (1)	Pass
4	Number of Hopping Frequency	15.247 (a) (1) III	Pass
5	Time of Occupancy (Dwell Time)	15.247 (a) (1) III	Pass
6	Conducted Bandedge	FCC 15.247 (d)	Pass
7	Radiated Bandedge and Spurious	FCC 15.247 (d) FCC 15.209 FCC 15.205	Pass
8	Conducted Emission Test for AC Power Port	FCC 15.207	Pass
9	Antenna Requirement	FCC 15.203	Pass

Note:
1. This test report is only published to and used by the applicant, and it is not for evidence purpose in China.
2. The measurement result for the sample received is <Pass> according to < CFR 47 FCC PART 15 SUBPART C > when <Accuracy Method> decision rule is applied.

TABLE OF CONTENTS

1. ATTESTATION OF TEST RESULTS	6
2. TEST METHODOLOGY	7
3. FACILITIES AND ACCREDITATION	7
4. CALIBRATION AND UNCERTAINTY	8
4.1. <i>MEASURING INSTRUMENT CALIBRATION</i>	<i>8</i>
4.2. <i>MEASUREMENT UNCERTAINTY.....</i>	<i>8</i>
5. EQUIPMENT UNDER TEST.....	9
5.1. <i>DESCRIPTION OF EUT</i>	<i>9</i>
5.2. <i>MAXIMUM PEAK OUTPUT POWER.....</i>	<i>10</i>
5.3. <i>CHANNEL LIST.....</i>	<i>10</i>
5.4. <i>TEST CHANNEL CONFIGURATION.....</i>	<i>10</i>
5.5. <i>WORST-CASE CONFIGURATIONS.....</i>	<i>10</i>
5.6. <i>THE WORSE CASE POWER SETTING PARAMETER.....</i>	<i>11</i>
5.7. <i>DESCRIPTION OF AVAILABLE ANTENNAS</i>	<i>11</i>
5.8. <i>DESCRIPTION OF TEST SETUP.....</i>	<i>12</i>
6. MEASURING INSTRUMENT AND SOFTWARE USED	13
7. ANTENNA PORT TEST RESULTS.....	15
7.1. <i>ON TIME AND DUTY CYCLE.....</i>	<i>15</i>
7.2. <i>20 dB BANDWIDTH AND 99% OCCUPIED BANDWIDTH</i>	<i>16</i>
7.3. <i>CONDUCTED OUTPUT POWER.....</i>	<i>18</i>
7.4. <i>CARRIER FREQUENCY SEPARATION.....</i>	<i>19</i>
7.5. <i>NUMBER OF HOPPING FREQUENCIES</i>	<i>21</i>
7.6. <i>TIME OF OCCUPANCY (DWELL TIME).....</i>	<i>23</i>
7.7. <i>CONDUCTED BANDEDGE AND SPURIOUS EMISSION.....</i>	<i>25</i>
8. RADIATED TEST RESULTS.....	27
8.1. <i>RESTRICTED BANDEDGE.....</i>	<i>32</i>
8.1.1. <i>Baby Unit.....</i>	<i>32</i>
8.2. <i>SPURIOUS EMISSIONS (1GHz ~ 3GHz).....</i>	<i>40</i>
8.2.1. <i>Baby Unit.....</i>	<i>40</i>
8.3. <i>SPURIOUS EMISSIONS (3GHz ~ 18GHz).....</i>	<i>46</i>
8.3.1. <i>Baby Unit.....</i>	<i>46</i>
8.4. <i>SPURIOUS EMISSIONS (18GHz ~ 26GHz).....</i>	<i>52</i>
8.4.1. <i>Baby Unit.....</i>	<i>52</i>



8.5. SPURIOUS EMISSIONS (30MHz ~ 1 GHz).....54
8.5.1. Baby Unit.....54
8.6. SPURIOUS EMISSIONS BELOW 30MHz56
8.6.1. Baby Unit.....56
9. AC POWER LINE CONDUCTED EMISSIONS59
9.1. Baby Unit.....60
10. ANTENNA REQUIREMENTS62
APPENDIX A: DUTY CYCLE63
APPENDIX B: 20DB BANDWIDTH.....65
APPENDIX C: OCCUPIED CHANNEL BANDWIDTH.....68
APPENDIX D: PEAK CONDUCTED OUTPUT POWER.....71
APPENDIX E: CARRIER FREQUENCY SEPARATION72
APPENDIX F: NUMBER OF HOPPING FREQUENCIES73
APPENDIX G: TIME OF OCCUPANCY (DWELL TIME).....74
APPENDIX H: BAND EDGE MEASUREMENTS76
APPENDIX I: CONDUCTED SPURIOUS EMISSION78



1. ATTESTATION OF TEST RESULTS

Applicant Information

Company Name: PHILIPS Electronics Hong Kong Limited
 Address: G/F, Building 5E, No. 5, Science Park East Avenue,
 Hong Kong Science Park, ShaTin, New Territories, Hong Kong

Manufacturer Information

Company Name: PHILIPS Electronics Hong Kong Limited
 Address: G/F, Building 5E, No. 5, Science Park East Avenue,
 Hong Kong Science Park, ShaTin, New Territories, Hong Kong

Factory Information

Company Name: Sky Light Electronic (ShenZhen) Limited
 Address: No. 8 Building 1F-5F & 9 Building 1F-2F, AnTuoShan High-tech
 Industrial Park, XinSha Road, ShaJing, Bao'An, Shenzhen.

EUT Information

EUT Name: Digital Video Baby Monitor
 Model: SCD843/37
 Serial Model: SCD8ab/**
 Model difference: Please refer to clause 5.1. Description of EUT
 Brand: PHILIPS/AVENT
 Sample Received Date: July 23, 2020
 Sample Status: Normal
 Sample ID: 3059230
 Date of Tested: July 23, 2020 ~ Aug 03, 2020

APPLICABLE STANDARDS	
STANDARD	TEST RESULTS
CFR 47 FCC PART 15 SUBPART C	PASS

Prepared By:

Checked By:

Mick Zhang
 Project Engineer
 Approved By:

Shawn Wen
 Laboratory Leader

Stephen Guo

Laboratory Manager



2. TEST METHODOLOGY

The tests documented in this report were performed in accordance with KDB 558074 D01 15.247 Meas Guidance v05r02, 414788 D01 Radiated Test Site v01r01, CFR 47 FCC Part 2, CFR 47 FCC Part 15, ANSI C63.10-2013.

3. FACILITIES AND ACCREDITATION

Accreditation Certificate	<p>A2LA (Certificate No.: 4102.01) UL Verification Services (Guangzhou) Co., Ltd. Song Shan Lake Branch. has been assessed and proved to be in compliance with A2LA.</p> <p>FCC (FCC Designation No.: CN1187) UL Verification Services (Guangzhou) Co., Ltd. Song Shan Lake Branch. Has been recognized to perform compliance testing on equipment subject to the Commission's Declaration of Conformity (DoC) and Certification rules</p> <p>ISED (Company No.: 21320) UL Verification Services (Guangzhou) Co., Ltd. Song Shan Lake Branch. has been registered and fully described in a report filed with ISED. The Company Number is 21320.</p> <p>VCCI (Registration No.: G-20019, R-20004, C-20012 and T-20011) UL Verification Services (Guangzhou) Co., Ltd. Song Shan Lake Branch. has been assessed and proved to be in compliance with VCCI, the Membership No. is 3793. Facility Name: Chamber D, the VCCI registration No. is G-20019 and R-20004 Shielding Room B , the VCCI registration No. is C-20012 and T-20011</p>
---------------------------	--

Note 1: All tests measurement facilities use to collect the measurement data are located at Building 10, Innovation Technology Park, Song Shan Lake Hi tech Development Zone, Dongguan, 523808, China

Note 2: The test anechoic chamber in UL Verification Services (Guangzhou) Co., Ltd. Song Shan Lake Branch had been calibrated and compared to the open field sites and the test anechoic chamber is shown to be equivalent to or worst case from the open field site.

Note 3: For below 30MHz, lab had performed measurements at test anechoic chamber and comparing to measurements obtained on an open field site. And these measurements below 30MHz had been correlated to measurements performed on an OFS.



4. CALIBRATION AND UNCERTAINTY

4.1. MEASURING INSTRUMENT CALIBRATION

The measuring equipment utilized to perform the tests documented in this report has been calibrated in accordance with the manufacturer's recommendations and is traceable to recognized national standards.

4.2. MEASUREMENT UNCERTAINTY

Where relevant, the following measurement uncertainty levels have been estimated for tests performed on the apparatus:

Test Item	Uncertainty
Conduction emission	3.62dB
Radiated Emission (Included Fundamental Emission) (9kHz ~ 30MHz)	2.2dB
Radiated Emission (Included Fundamental Emission) (30MHz ~ 1GHz)	4.00dB
Radiated Emission (Included Fundamental Emission) (1GHz to 26GHz)	5.78dB (1GHz ~ 18GHz)
	5.23dB (18GHz ~ 26GHz)
Note: This uncertainty represents an expanded uncertainty expressed at approximately the 95% confidence level using a coverage factor of k=2.	



5. EQUIPMENT UNDER TEST

5.1. DESCRIPTION OF EUT

EUT Name	Digital Video Baby Monitor
EUT Description	EUT has two parts, Parent Unit and Baby Unit
Model	SCD843/37
Series Model	SCD8ab/**
Model Difference	<p>Digital Video Baby Monitor, with following model number consist of the various stroke versions which are similar in electrical, mechanical and physical construction.</p> <p>SCD8ab/** is a combination of two sets devices of VPH01 BU & VPH02 PU, VPH 03 BU & VPH 04 PU.</p> <p>The difference between VPH01 BU & VPH03 BU is that VPH03 BU has an extra plastic button and temperature sensor function. All the differences are not affect the RF circuits.</p> <p>The difference between VPH02 PU & VPH 04 PU is that VPH04 PU has an extra vibration feature and 3.5" LCD, VPH02 PU has a 2.7 "LCD. All the differences are not affect the RF circuits.</p> <p>"a" can be 3 or 4 consist the colour screen size. - "3" mean this set device include the 2.7 " LCD PU device, "4" mean this set device include the 3.5" LCD PU device</p> <p>"b" can be 1 or 3 or 5 consist the product feature (night light, temperarue monitor, vibration feature)</p> <p>"1" mean the device have basic function night light;</p> <p>"3" mean the device have night light, temperature monitor, vibration functions.</p> <p>"5" mean the device have night light, temperature monitor, vibration functions with a Smart ECO Mode. (The Smart ECO mode is a power management by firmware and maintain the PU std-by time longer a bit. No affect the EMC test and RF characteristics.)</p> <p>SCD831/**with VPH01 BU + VPH02 PU devices (with night light function)</p> <p>SCD833/**with VPH03 BU + VPH02 PU devices (with night light, temperature monitor function)</p> <p>SCD835/**with VPH03 BU + VPH02 PU devices (with night light, temperature monitor function)</p> <p>SCD841/**with VPH01 BU + VPH04 PU devices (with night light, vibration feature)</p> <p>SCD843/**with VPH03 BU + VPH04 PU devices (with night light, temperature monitor, vibration feature)</p> <p>SCD845/**with VPH03 BU + VPH04 PU devices (with night light, temperature monitor, vibration feature)</p> <p>***" denoting the various accessories or different style packaging used.</p> <p>Stroke version/** representative to the different country selling destination.</p>
Technology	2.4G wireless
Transmit Frequency Range	2406 MHz ~ 2463 MHz
Modulation	GFSK



Rated input	Input: DC 5V/1A via AC DC Adapter
Adapter	ASSA105A-050100 and PSAC05E-050L6

Note :

1. All models are under consideration at FCC Part15, Subpart B. And only the worst model SCD843/37 recorded in this report.
2. This report only for Baby Unit.

5.2. MAXIMUM PEAK OUTPUT POWER

Bluetooth Mode	Frequency (MHz)	Channel Number	Maximum Peak Output Power (dBm)
Baby Unit	2406-2463	1-20[20]	18.36

5.3. CHANNEL LIST

Channel	Frequency (MHz)	Channel	Frequency (MHz)	Channel	Frequency (MHz)	Channel	Frequency (MHz)
1	2406	6	2421	11	2436	16	2451
2	2409	7	2424	12	2439	17	2454
3	2412	8	2427	13	2442	18	2457
4	2415	9	2430	14	2445	19	2460
5	2418	10	2433	15	2448	20	2463

5.4. TEST CHANNEL CONFIGURATION

Test Mode	Test Channel	Frequency
Baby Unit	CH 1(Low Channel), CH 11(MID Channel), CH 20(High Channel)	2406MHz, 2436MHz, 2463MHz
Baby Unit	CH 1(Low Channel) to CH 20(High Channel)	2406MHz ~ 2463MHz

5.5. WORST-CASE CONFIGURATIONS

Bluetooth Mode	Modulation Technology	Modulation Type
Baby Unit	FHSS	GFSK

5.6. THE WORSE CASE POWER SETTING PARAMETER

The Worst Case Power Setting Parameter under 2406 ~ 2463MHz Band				
Test Software		/		
Test Mode	Transmit Antenna Number	Test Software Setting Value		
		CH 1	CH 11	CH 20
Baby Unit	1	Default	Default	Default

5.7. DESCRIPTION OF AVAILABLE ANTENNAS

Antenna	Frequency (MHz)	Antenna Type	MAX Antenna Gain (dBi)
Baby Unit	2406-2463	brass antenna	2.21

Test Mode	Transmit and Receive Mode	Description
Baby Unit	<input checked="" type="checkbox"/> 1TX, 1RX	Antenna 1 can be used as transmitting/receiving antenna.

Note: The value of the antenna gain was declared by customer.

5.8. DESCRIPTION OF TEST SETUP

SUPPORT EQUIPMENT

Item	Equipment	Brand Name	Model Name	P/N
/	/	/	/	/

I/O CABLES

Cable No	Port	Connector Type	Cable Type	Cable Length(m)	Remarks
/	/	/	/	/	/

ACCESSORY

Item	Accessory	Brand Name	Model Name	Description
1	SWITCHING ADAPTER	/	ASSA105A-050100	Input: AC 100 ~ 240V, 50/60Hz, 0.35A Output: DC 5V, 1A
2	SWITCHING ADAPTER	/	PSAC05A-050L6	Input: 100-240V~ 50/60Hz, 0.2A Output: 5Vdc 1A

TEST SETUP

The EUT have the engineer mode inside.

SETUP DIAGRAM FOR TESTS

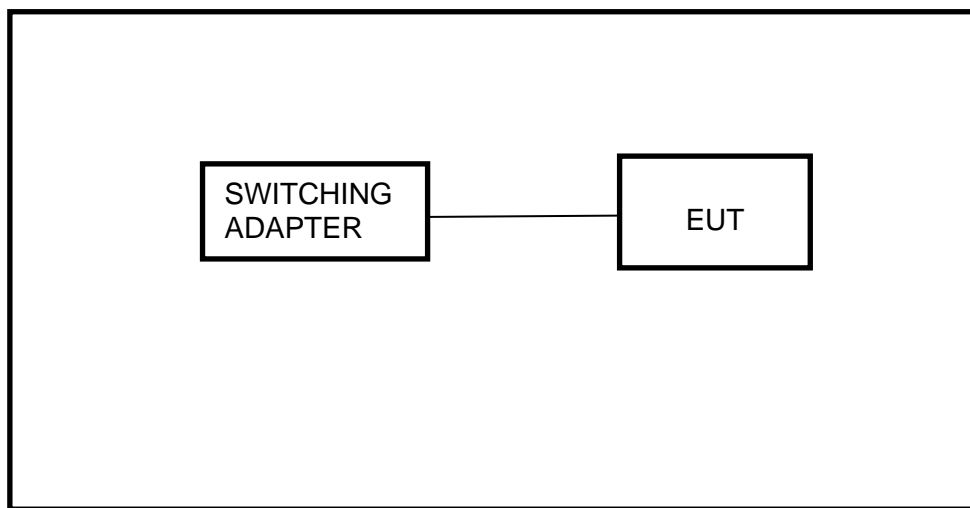

**6. MEASURING INSTRUMENT AND SOFTWARE USED**

Conducted Emissions						
Instrument						
Used	Equipment	Manufacturer	Model No.	Serial No.	Last Cal.	Next Cal.
<input checked="" type="checkbox"/>	EMI Test Receiver	R&S	ESR3	101961	Dec.05,2019	Dec.05,2020
<input checked="" type="checkbox"/>	Two-Line V- Network	R&S	ENV216	101983	Dec.05,2019	Dec.05,2020
Software						
Used	Description	Manufacturer	Name	Version		
<input checked="" type="checkbox"/>	Test Software for Conducted disturbance	Farad	EZ-EMC	Ver. UL-3A1		
Radiated Emissions						
Instrument						
Used	Equipment	Manufacturer	Model No.	Serial No.	Last Cal.	Next Cal.
<input checked="" type="checkbox"/>	MXE EMI Receiver	KESIGHT	N9038A	MY56400036	Dec.06,2019	Dec.06,2020
<input checked="" type="checkbox"/>	Hybrid Log Periodic Antenna	TDK	HLP-3003C	130960	Sep.17, 2018	Sep.17, 2021
<input checked="" type="checkbox"/>	Preamplifier	HP	8447D	2944A09099	Dec.05,2019	Dec.05,2020
<input checked="" type="checkbox"/>	EMI Measurement Receiver	R&S	ESR26	101377	Dec.05,2019	Dec.05,2020
<input checked="" type="checkbox"/>	Horn Antenna	TDK	HRN-0118	130939	Sep.17, 2018	Sep.17, 2021
<input checked="" type="checkbox"/>	High Gain Horn Antenna	Schwarzbeck	BBHA-9170	691	Aug.11, 2018	Aug.11, 2021
<input checked="" type="checkbox"/>	Preamplifier	TDK	PA-02-0118	TRS-305- 00066	Dec.05,2019	Dec.05,2020
<input checked="" type="checkbox"/>	Preamplifier	TDK	PA-02-2	TRS-307- 00003	Dec.05,2019	Dec.05,2020
<input checked="" type="checkbox"/>	Loop antenna	Schwarzbeck	1519B	00008	Jan.07, 2019	Jan.07, 2022
<input checked="" type="checkbox"/>	Preamplifier	TDK	PA-02-001- 3000	TRS-302- 00050	Dec.5, 2019	Dec.5, 2020
<input checked="" type="checkbox"/>	Band Reject Filter	Wainwright	WRCJV8- 2350-2400- 2483.5- 2533.5- 40SS	4	Dec.05,2019	Dec.05,2020
<input checked="" type="checkbox"/>	High Pass Filter	Wi	WHKX10- 2700-3000- 18000-40SS	23	Dec.05,2019	Dec.05,2020
Software						
Used	Description	Manufacturer	Name	Version		
<input checked="" type="checkbox"/>	Test Software for Radiated disturbance	Farad	EZ-EMC	Ver. UL-3A1		



Other instruments						
Used	Equipment	Manufacturer	Model No.	Serial No.	Last Cal.	Next Cal.
<input checked="" type="checkbox"/>	Spectrum Analyzer	Keysight	N9030A	MY55410512	Dec.06,2019	Dec.06,2020
<input checked="" type="checkbox"/>	Spectrum Analyzer	Keysight	N9020A	MY49100060	Dec.06,2019	Dec.06,2020
<input checked="" type="checkbox"/>	Power Meter	Keysight	N1911A	MY55416024	Dec.06,2019	Dec.06,2020
<input checked="" type="checkbox"/>	Power Sensor	Keysight	U2021XA	MY5100022	Dec.06,2019	Dec.06,2020

7. ANTENNA PORT TEST RESULTS

7.1. ON TIME AND DUTY CYCLE

LIMITS

None; for reporting purposes only.

PROCEDURE

Refer to ANSI C63.10-2013 Zero – Span Spectrum Analyzer method.

TEST SETUP

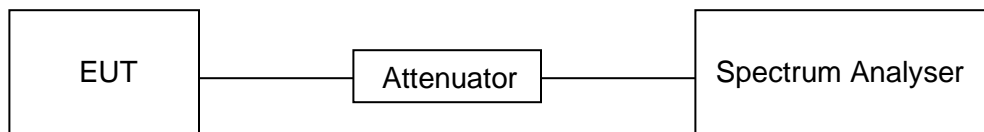

TEST ENVIRONMENT

Temperature	25.2°C	Relative Humidity	57%
Atmosphere Pressure	101kPa	Test Voltage	DC 5.0V

RESULTS

Please refer to appendix A.

7.2. 20 dB BANDWIDTH AND 99% OCCUPIED BANDWIDTH

LIMITS

CFR 47FCC Part15 (15.247) Subpart C			
Section	Test Item	Limit	Frequency Range (MHz)
CFR 47 FCC 15.247 (a) (1)	20 dB Bandwidth	None; for reporting purposes only.	2400-2483.5
ISED RSS-Gen Clause 6.7	99% Occupied Bandwidth	None; for reporting purposes only.	2400-2483.5

TEST PROCEDURE

Refer to ANSI C63.10-2013 clause 6.9.2.

Connect the EUT to the spectrum analyser and use the following settings:

Center Frequency	The center frequency of the channel under test
Detector	Peak
RBW	For 20dB Bandwidth: 1% to 5% of the 20dB bandwidth For 99% Occupied Bandwidth: 1% to 5% of the occupied bandwidth
VBW	For 20dB Bandwidth: approximately 3×RBW For 99% Occupied Bandwidth: $\geq 3 \times \text{RBW}$
Span	For 20dB Bandwidth: 2 to 5 times the occupied bandwidth For 99% Occupied Bandwidth: 1.5 to 5 times the occupied bandwidth
Trace	Max hold
Sweep	Auto couple

a) Use the occupied bandwidth function of the instrument, allow the trace to stabilize and report the measured 99% occupied bandwidth and 20dB Bandwidth.

TEST SETUP

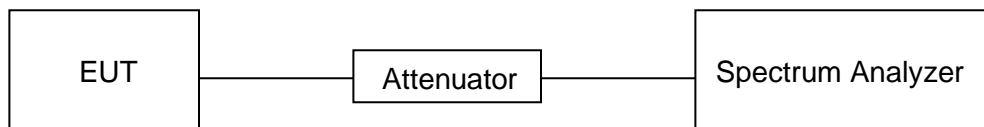



TEST ENVIRONMENT

Temperature	25.2°C	Relative Humidity	57%
Atmosphere Pressure	101kPa	Test Voltage	DC 5.0V

RESULTS

Please refer to appendix B and C.

7.3. CONDUCTED OUTPUT POWER

LIMITS

CFR 47 FCC Part15 (15.247), Subpart C			
Section	Test Item	Limit	Frequency Range (MHz)
CFR 47 FCC 15.247 (b) (1)	Peak Conducted Output Power	Hopping channel carrier frequencies separated by a minimum of 25 kHz or the 20dB bandwidth of the hopping channel: 1 watt or 30dBm; Hopping channel carrier frequencies that are separated by 25 kHz or two-thirds of the 20dB bandwidth of the hopping channel: 125 mW or 21dBm	2400-2483.5

TEST PROCEDURE

Connect the EUT to a low loss RF cable from the antenna port to the power sensor (video bandwidth is greater than the occupied bandwidth).
Measure peak emission level, the indicated level is the peak output power, after any corrections for external attenuators and cables.

TEST SETUP

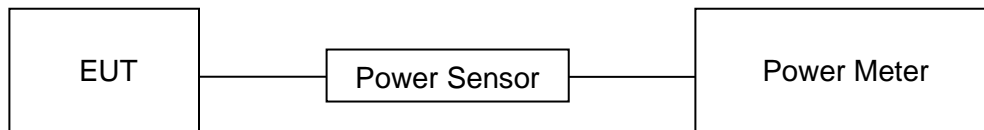

TEST ENVIRONMENT

Temperature	25.2°C	Relative Humidity	57%
Atmosphere Pressure	101kPa	Test Voltage	DC 5.0V

RESULTS

Please refer to appendix D.

7.4. CARRIER FREQUENCY SEPARATION

LIMITS

CFR 47 FCC Part15 (15.247), Subpart C			
Section	Test Item	Limit	Frequency Range (MHz)
CFR 47 FCC 15.247 (a) (1)	Carrier Frequency Separation	Frequency hopping systems shall have hopping channel carrier frequencies separated by a minimum of 25 kHz or the 20dB bandwidth of the hopping channel, whichever is greater. Alternatively, frequency hopping systems operating in the 2400-2483.5 MHz band may have hopping channel carrier frequencies that are separated by 25 kHz or two-thirds of the 20dB bandwidth of the hopping channel.	2400-2483.5

TEST PROCEDURE

Refer to ANSI C63.10-2013 clause 7.8.2.

Connect the EUT to the spectrum analyzer and use the following settings:

Center Frequency	The center frequency of the channel under test
Span	wide enough to capture the peaks of two adjacent channels
Detector	Peak
RBW	Start with the RBW set to approximately 30% of the channel spacing; adjust as necessary to best identify the center of each individual channel.
VBW	≥RBW
Trace	Max hold
Sweep time	Auto couple

Allow the trace to stabilize and use the marker-delta function to determine the separation between the peaks of the adjacent channels.

Compliance of an EUT with the appropriate regulatory limit shall be determined.

TEST SETUP

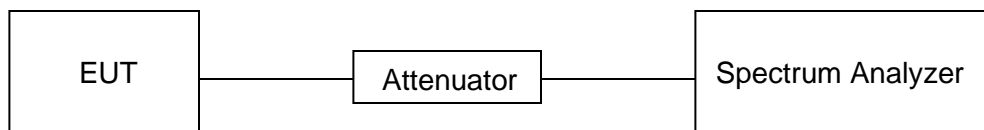



TEST ENVIRONMENT

Temperature	25.2°C	Relative Humidity	57%
Atmosphere Pressure	101kPa	Test Voltage	DC 5.0V

RESULTS

Please refer to Appendix E.

7.5. NUMBER OF HOPPING FREQUENCIES

LIMITS

CFR 47 FCC Part15 (15.247), Subpart C		
Section	Test Item	Limit
CFR 47 15.247 (a) (1) III	Number of Hopping Frequency	at least 15 hopping channels

TEST PROCEDURE

Refer to ANSI C63.10-2013 clause 7.8.3.

Connect the EUT to the spectrum Analyzer and use the following settings:

Detector	Peak
RBW	To identify clearly the individual channels, set the RBW to less than 30% of the channel spacing or the 20dB bandwidth, whichever is smaller.
VBW	\geq RBW
Span	The frequency band of operation. Depending on the number of channels the device supports, it may be necessary to divide the frequency range of operation across multiple spans, to allow the individual channels to be clearly seen.
Trace	Max hold
Sweep time	Auto couple

Set EUT to transmit maximum output power and switch on frequency hopping function. then set enough count time (larger than 5000 times) to get all the hopping frequency channel displayed on the screen of spectrum analyzer, count the quantity of peaks to get the number of hopping channels.

TEST SETUP

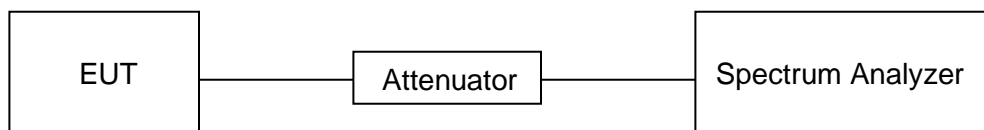



TEST ENVIRONMENT

Temperature	25.2°C	Relative Humidity	57%
Atmosphere Pressure	101kPa	Test Voltage	DC 5.0V

RESULTS

Please refer to appendix F.

7.6. TIME OF OCCUPANCY (DWELL TIME)

LIMITS

CFR 47 FCC Part15 (15.247), Subpart C		
Section	Test Item	Limit
CFR 47 15.247 (a) (1) III	Time of Occupancy (Dwell Time)	The average time of occupancy on any channel shall not be greater than 0.4 seconds within a period of 0.4 seconds, multiplied by the number of hopping channels employed.

TEST PROCEDURE

Refer to ANSI C63.10-2013 clause 7.8.4.

Connect the EUT to the spectrum Analyzer and use the following settings:

Center Frequency	The center frequency of the channel under test
Detector	Peak
RBW	1 MHz
VBW	≥RBW
Span	Zero span, centered on a hopping channel
Trace	Max hold
Sweep time	As necessary to capture the entire dwell time per hopping channel; where possible use a video trigger and trigger delay so that the transmitted signal starts a little to the right of the start of the plot. The trigger level might need slight adjustment to prevent triggering when the system hops on an adjacent channel

Use the marker-delta function to determine the transmit time per hop (Burst Width). If this value varies with different modes of operation (data rate, modulation format, number of hopping channels, etc.), then repeat this test for each variation in transmit time.

TEST SETUP

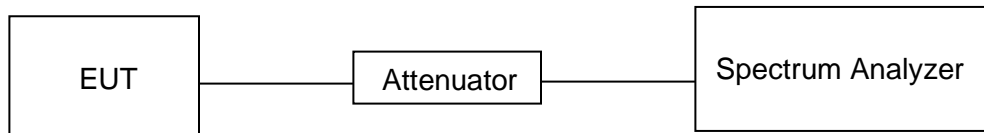



TEST ENVIRONMENT

Temperature	25.2°C	Relative Humidity	57%
Atmosphere Pressure	101kPa	Test Voltage	DC 5.0V

RESULTS

Please refer to appendix G.

7.7. CONDUCTED BANDEdge AND SPURIOUS EMISSION

LIMITS

CFR 47 FCC Part15 (15.247), Subpart C		
Section	Test Item	Limit
CFR 47 FCC §15.247 (d)	Conducted Spurious Emission	at least 20 dB below that in the 100 kHz bandwidth within the band that contains the highest level of the desired power

TEST PROCEDURE

Refer to ANSI C63.10-2013 clause 7.8.6 and 7.8.8.

Connect the EUT to the spectrum analyser and use the following settings for reference level measurement:

Center Frequency	The center frequency of the channel under test
Detector	Peak
RBW	100kHz
VBW	$\geq 3 \times \text{RBW}$
Span	1.5 x DTS bandwidth
Trace	Max hold
Sweep time	Auto couple.

Allow trace to fully stabilize and use the peak marker function to determine the maximum PSD level.

Change the settings for emission level measurement:

Span	Set the center frequency and span to encompass frequency range to be measured
Detector	Peak
RBW	100kHz
VBW	$\geq 3 \times \text{RBW}$
measurement points	$\geq \text{span}/\text{RBW}$
Trace	Max hold
Sweep time	Auto couple.

Allow trace to fully stabilize and use the peak marker function to determine the maximum PSD level. Ensure that the amplitude of all unwanted emissions outside of the authorized frequency band (excluding restricted frequency bands) is attenuated by at least the minimum requirements.

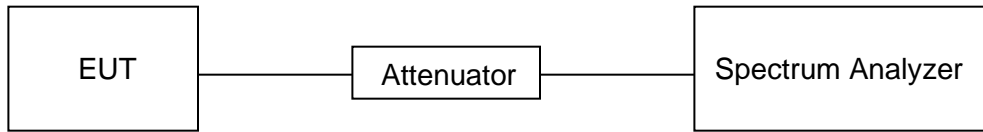
TEST SETUP**TEST ENVIRONMENT**

Temperature	25.2°C	Relative Humidity	57%
Atmosphere Pressure	101kPa	Test Voltage	DC 5.0V

RESULTS

Please refer to appendix H & I.



8. RADIATED TEST RESULTS

LIMITS

Please refer to CFR 47 FCC §15.205 and §15.209.

Radiation Disturbance Test Limit for FCC (Class B) (9kHz-1GHz)

Emissions radiated outside of the specified frequency bands above 30MHz			
Frequency Range (MHz)	Field Strength Limit (uV/m) at 3 m	Field Strength Limit (dBuV/m) at 3 m	
		Quasi-Peak	
30 - 88	100	40	
88 - 216	150	43.5	
216 - 960	200	46	
Above 960	500	54	
Above 1000	500	Peak	Average
		74	54

FCC Emissions radiated outside of the specified frequency bands below 30MHz		
Frequency (MHz)	Field strength (microvolts/meter)	Measurement distance (meters)
0.009-0.490	2400/F(kHz)	300
0.490-1.705	24000/F(kHz)	30
1.705-30.0	30	30

FCC Restricted bands of operation refer to FCC §15.205 (a):

MHz	MHz	MHz	GHz
0.090-0.110	16.42-16.423	399.9-410	4.5-5.15
¹ 0.495-0.505	16.69475-16.69525	608-614	5.35-5.46
2.1735-2.1905	16.80425-16.80475	960-1240	7.25-7.75
4.125-4.128	25.5-25.67	1300-1427	8.025-8.5
4.17725-4.17775	37.5-38.25	1435-1626.5	9.0-9.2
4.20725-4.20775	73-74.6	1645.5-1646.5	9.3-9.5
6.215-6.218	74.8-75.2	1660-1710	10.6-12.7
6.26775-6.26825	108-121.94	1718.8-1722.2	13.25-13.4
6.31175-6.31225	123-138	2200-2300	14.47-14.5
8.291-8.294	149.9-150.05	2310-2390	15.35-16.2
8.362-8.366	156.52475-156.52525	2483.5-2500	17.7-21.4
8.37625-8.38675	156.7-156.9	2690-2900	22.01-23.12
8.41425-8.41475	162.0125-167.17	3260-3267	23.6-24.0
12.29-12.293	167.72-173.2	3332-3339	31.2-31.8
12.51975-12.52025	240-285	3345.8-3358	36.43-36.5
12.57675-12.57725	322-335.4	3600-4400	(²)
13.36-13.41			

Note: ¹Until February 1, 1999, this restricted band shall be 0.490-0.510 MHz.

²Above 38.6c

TEST SETUP AND PROCEDURE

Below 30MHz

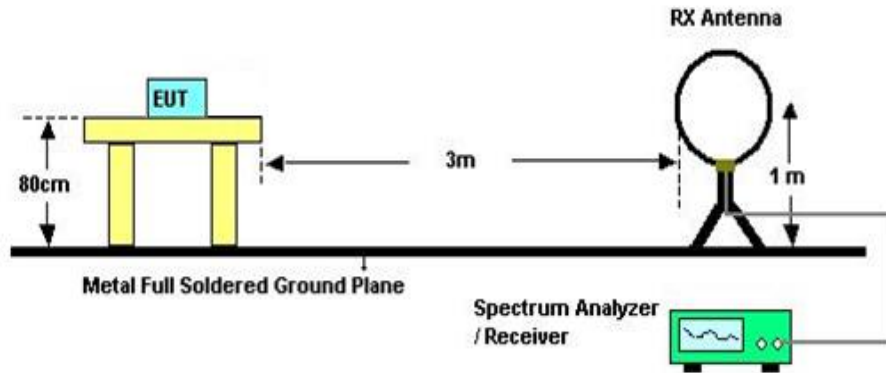

The setting of the spectrum analyser

RBW	200Hz (From 9kHz to 0.15MHz)/ 9kHz (From 0.15MHz to 30MHz)
VBW	200Hz (From 9kHz to 0.15MHz)/ 9kHz (From 0.15MHz to 30MHz)
Sweep	Auto
Trace	Max hold

1. The testing follows the guidelines in ANSI C63.10-2013 clause 6.4.
2. The EUT was arranged to its worst case and then turntable (from 0 degree to 360 degrees) to find the maximum reading. A pre-amp and a high pass filter are used for the test in order to get better signal level. Both Horizontal, Face-on and Face-off polarizations of the antenna are set to make the measurement.
3. The EUT was placed on a turntable with 80cm above ground.
4. The EUT was set 3 meters from the interference receiving antenna, which was mounted on the top of a variable height antenna tower.
5. The radiated emission limits are based on measurements employing a CISPR quasi-peak detector except for the frequency bands 9-90 kHz, 110-490 kHz and above 1000 MHz. Radiated emission limits in these three bands are based on measurements employing an average detector.
6. For measurement below 1GHz, the initial step in collecting conducted emission data is a spectrum analyzer peak detector mode pre-scanning the measurement frequency range. Significant peaks are then marked and then Quasi Peak and average detector mode re-measured. If the emission level of the EUT measured by the peak detector is 3 dB lower than the applicable limit, the peak emission level will be reported. Otherwise, the emission measurement will be repeated using the quasi-peak and average detector and reported.
7. Although these tests were performed other than open field site, adequate comparison measurements were confirmed against 30m open field site. Therefore sufficient tests were made to demonstrate that the alternative site produces results that correlate with the ones of tests made in an open field site based on KDB 414788.

Below 1G and above 30MHz

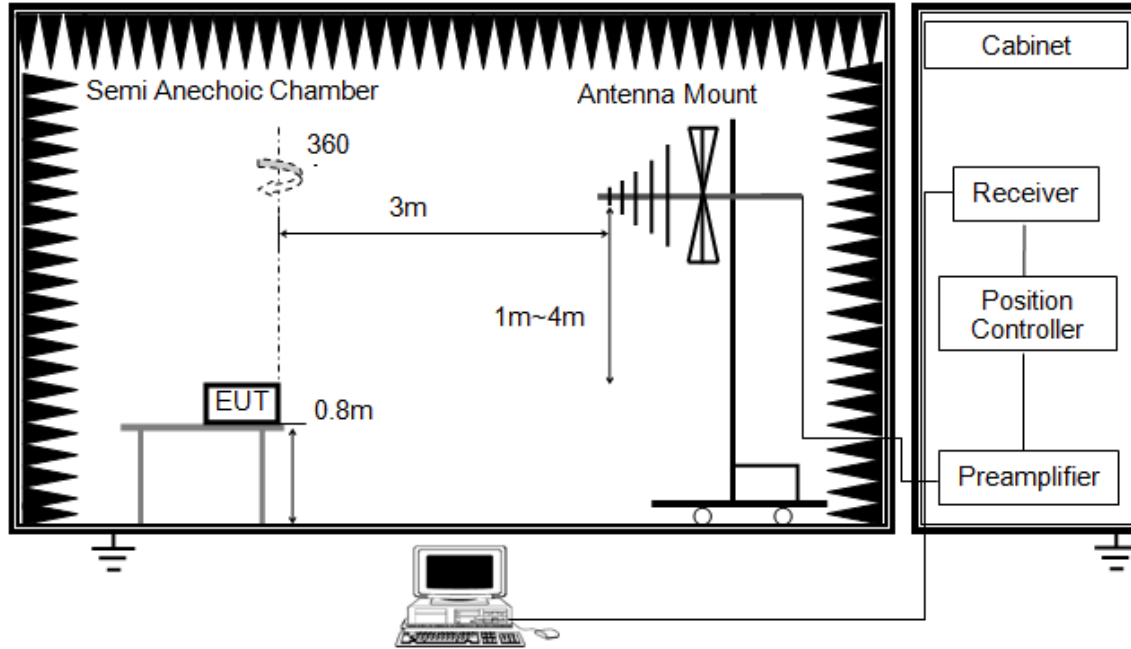

The setting of the spectrum analyser

RBW	120kHz
VBW	300kHz
Sweep	Auto
Detector	Peak/QP
Trace	Max hold

1. The testing follows the guidelines in ANSI C63.10-2013 clause 6.5.
2. The EUT was arranged to its worst case and then tune the antenna tower (from 1 m to 4 m) and turntable (from 0 degree to 360 degrees) to find the maximum reading. A pre-amp and a high pass filter are used for the test in order to get better signal level. Both horizontal and vertical polarizations of the antenna are set to make the measurement.
3. The EUT was placed on a turntable with 80cm above ground.
4. The EUT was set 3 meters from the interference receiving antenna, which was mounted on the top of a variable height antenna tower.
5. For measurement below 1GHz, the initial step in collecting conducted emission data is a spectrum analyzer peak detector mode pre-scanning the measurement frequency range. Significant peaks are then marked and then Quasi Peak detector mode re-measured. If the emission level of the EUT measured by the peak detector is 3 dB lower than the applicable limit, the peak emission level will be reported. Otherwise, the emission measurement will be repeated using the quasi-peak detector and reported.

Above 1G

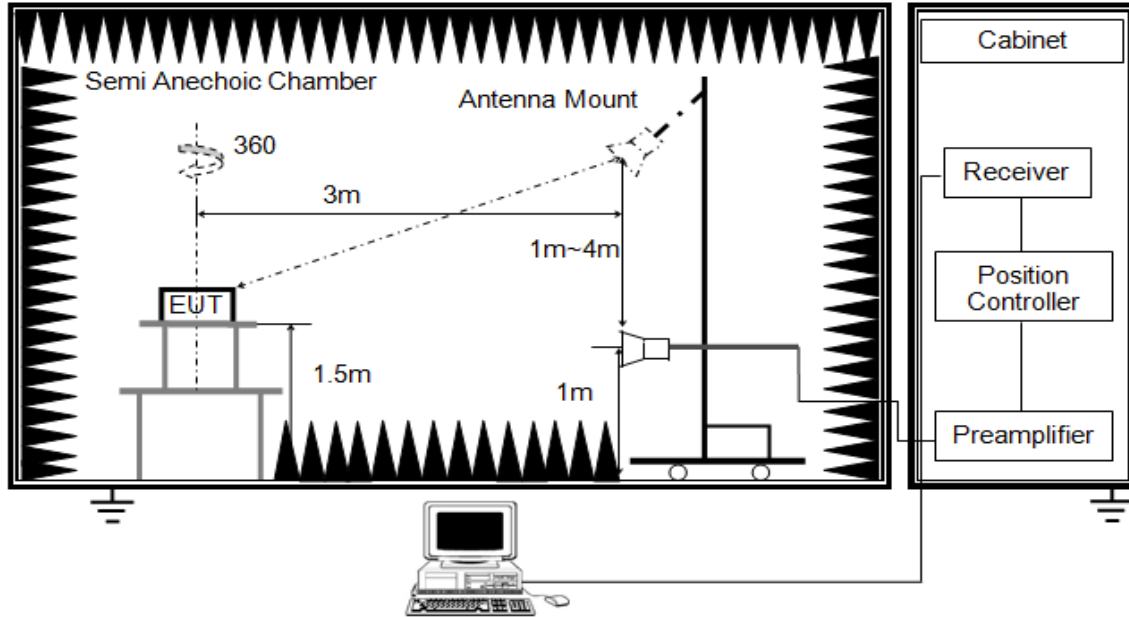

The setting of the spectrum analyser

RBW	1MHz
VBW	PEAK: 3MHz AVG: see note 6
Sweep	Auto
Detector	Peak
Trace	Max hold

1. The testing follows the guidelines in ANSI C63.10-2013 clause 6.6.
2. The EUT was arranged to its worst case and then tune the antenna tower (1.5 m) and turntable (from 0 degree to 360 degrees) to find the maximum reading. A pre-amp and a high pass filter are used for the test in order to get better signal level. Both horizontal and vertical polarizations of the antenna are set to make the measurement.
3. The EUT was placed on a turntable with 1.5m above ground.
4. The EUT was set 3 meters from the interference receiving antenna, which was mounted on the top of a variable height antenna tower.
5. For measurement above 1GHz, the emission measurement will be measured by the peak detector. This peak level, once corrected, must comply with the limit specified in Section 15.209.
6. For measurements above 1 GHz the resolution bandwidth is set to 1 MHz, then the video bandwidth is set to 3 MHz for peak measurements and 1 MHz resolution bandwidth with 1/T video bandwidth with peak detector for average measurements. For the Duty Cycle please refer to clause 7.1.ON TIME AND DUTY CYCLE.

X axis, Y axis, Z axis positions:

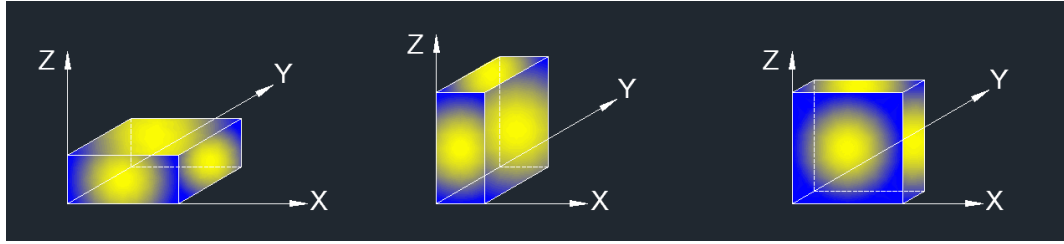

Note 1: For all radiated test, EUT in each of three orthogonal axis emissions had been tested, but only the worst case (X axis) data recorded in the report.

Note 2: The EUT was fully exercised with external accessories during the test. In the case of multiple accessory external ports, an external accessory shall be connected to one of each type of port.

TEST ENVIRONMENT

Temperature	25.2°C	Relative Humidity	57%
Atmosphere Pressure	101kPa	Test Voltage	DC 5.0V

8.1. RESTRICTED BANDEDGE

8.1.1. Baby Unit

RESTRICTED BANDEDGE (LOW CHANNEL, HORIZONTAL)

PEAK

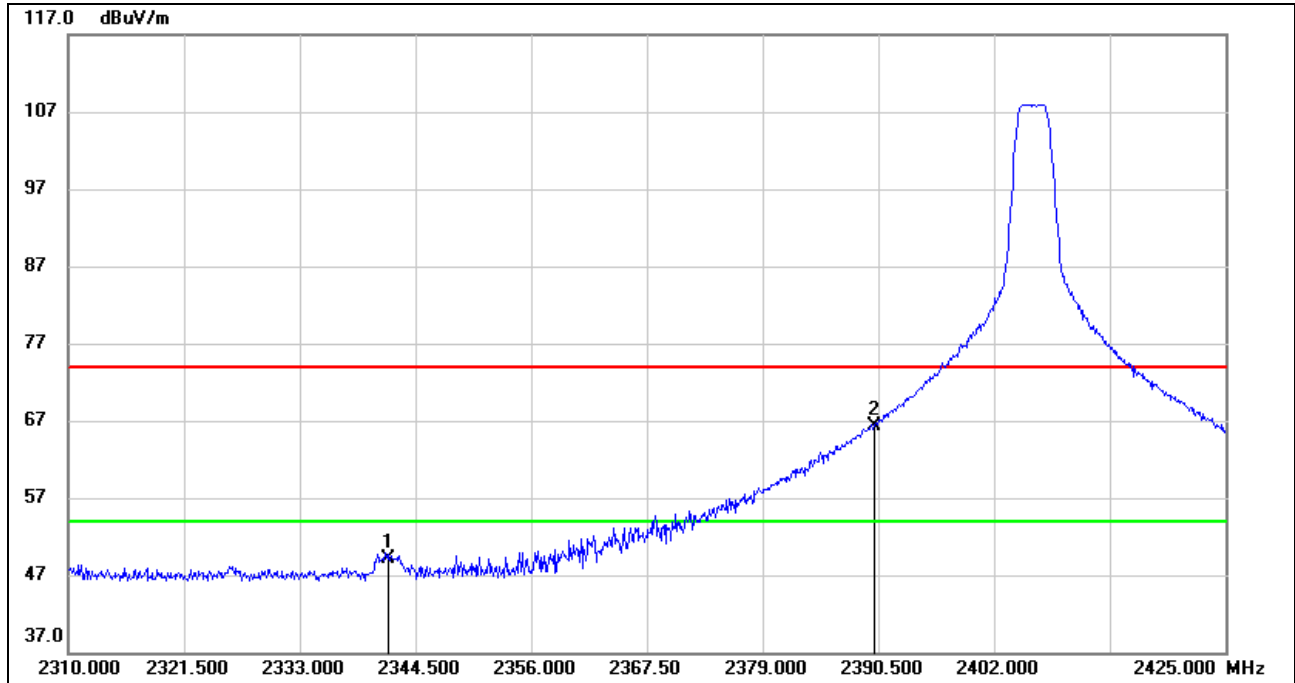

No.	Frequency (MHz)	Reading (dBuV)	Correct (dB/m)	Result (dBuV/m)	Limit (dBuV/m)	Margin (dB)	Remark
1	2341.855	16.29	32.79	49.08	74.00	-24.92	peak
2	2390.000	33.42	32.94	66.36	74.00	-7.64	peak

- Note: 1. Measurement = Reading Level + Correct Factor.
 2. If Peak Result complies with AV limit, AV Result is deemed to comply with AV limit.
 3. Peak: Peak detector.
 4. Only the worst data was recorded, if it complies with the limit, the other emissions deemed to comply with the limit.



RESTRICTED BANDEDGE (LOW CHANNEL, HORIZONTAL)

AVG

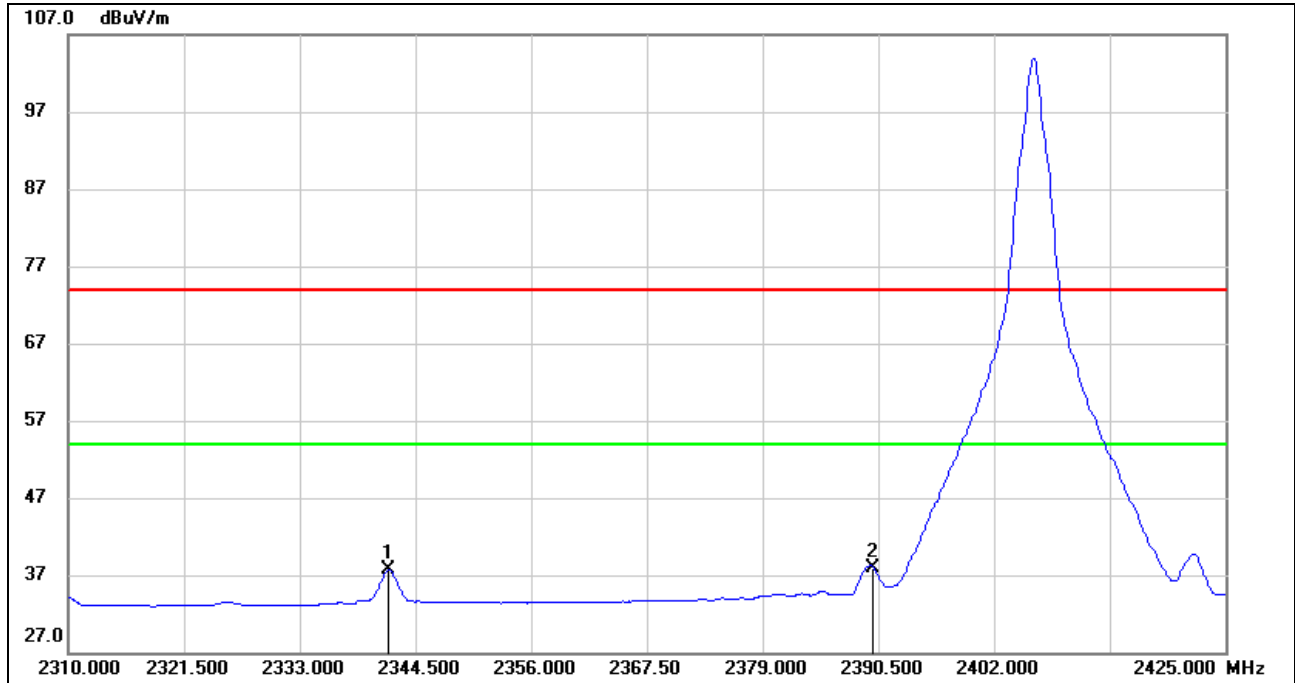

No.	Frequency (MHz)	Reading (dBuV)	Correct (dB/m)	Result (dBuV/m)	Limit (dBuV/m)	Margin (dB)	Remark
1	2341.855	4.88	32.79	37.67	54.00	-16.33	AVG
2	2390.000	5.04	32.94	37.98	54.00	-16.02	AVG

- Note:
1. Measurement = Reading Level + Correct Factor.
 2. If Peak Result complies with AV limit, AV Result is deemed to comply with AV limit.
 3. Peak: Peak detector.
 4. AVG: $VBW=1/Ton$, where: Ton is the transmitting duration.
 5. For the transmitting duration, please refer to clause 7.1.
 6. Only the worst data was recorded, if it complies with the limit, the other emissions deemed to comply with the limit.



RESTRICTED BANDEDGE (LOW CHANNEL, VERTICAL)
PEAK

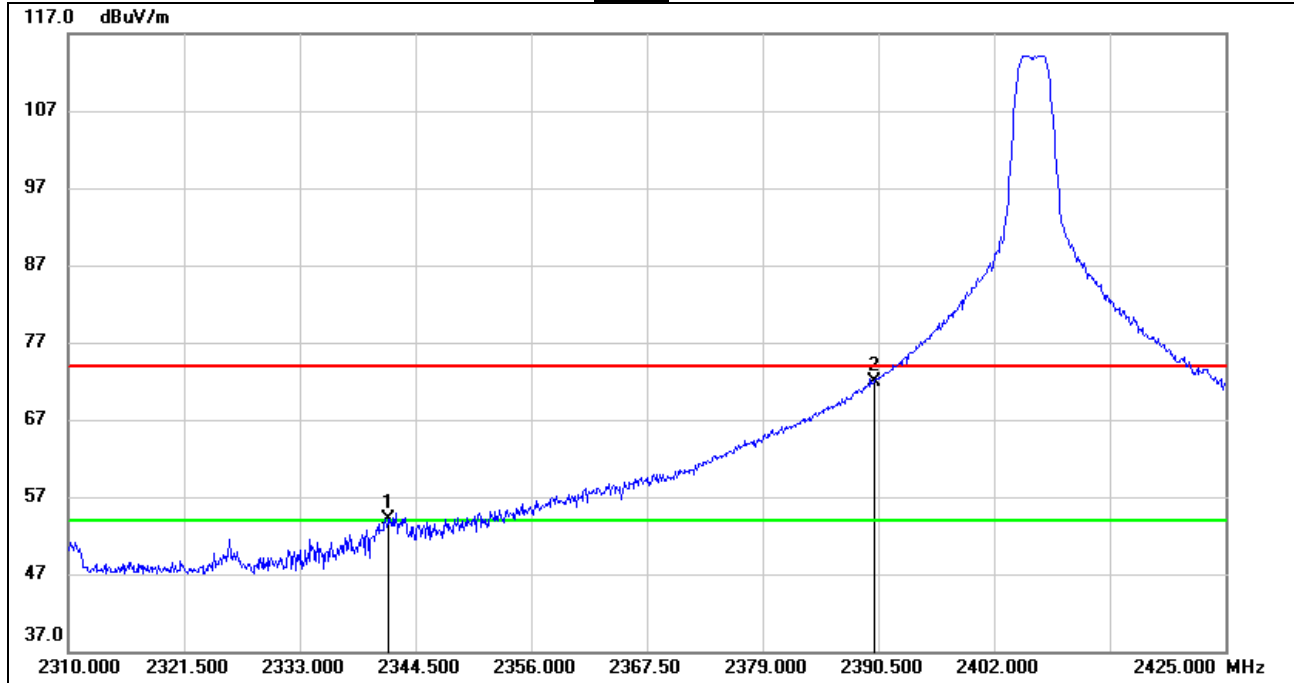

No.	Frequency (MHz)	Reading (dBuV)	Correct (dB/m)	Result (dBuV/m)	Limit (dBuV/m)	Margin (dB)	Remark
1	2341.855	21.23	32.79	54.02	74.00	-19.98	peak
2	2390.000	39.01	32.94	71.95	74.00	-2.05	peak

- Note:
1. Measurement = Reading Level + Correct Factor.
 2. If Peak Result complies with AV limit, AV Result is deemed to comply with AV limit.
 3. Peak: Peak detector.
 4. Only the worst data was recorded, if it complies with the limit, the other emissions deemed to comply with the limit.



RESTRICTED BANDEDGE (LOW CHANNEL, VERTICAL)
AVG

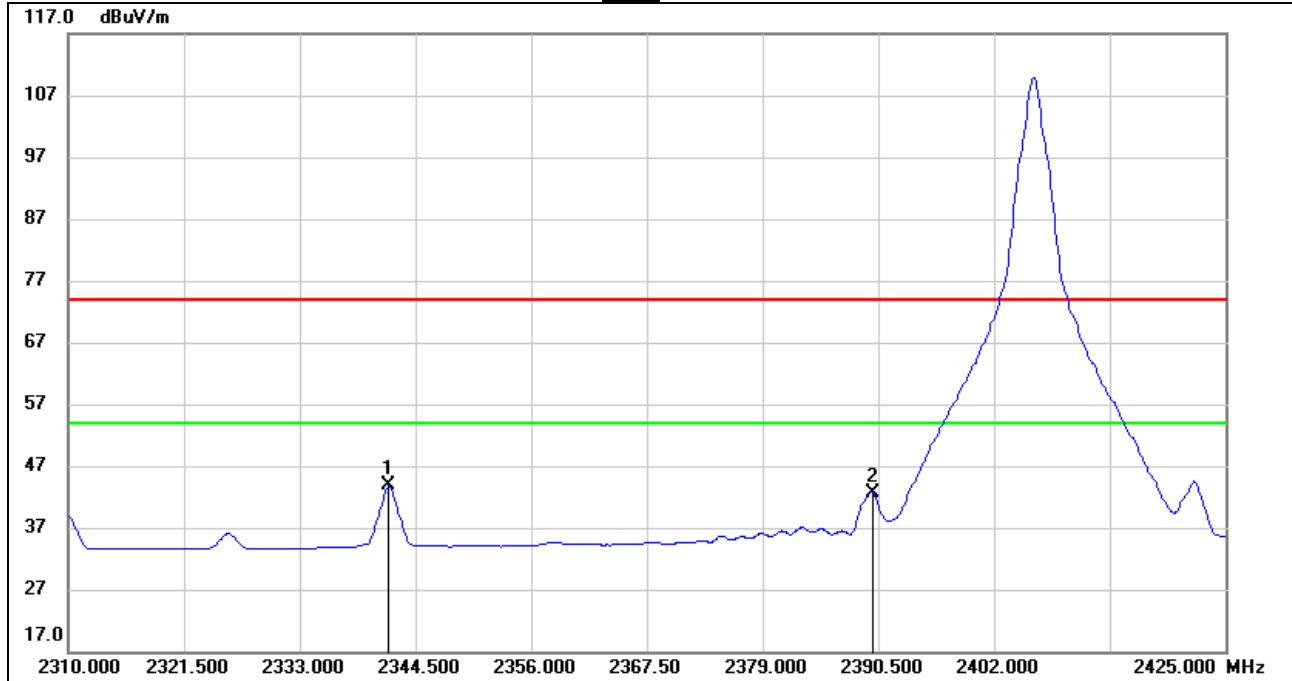

No.	Frequency (MHz)	Reading (dBuV)	Correct (dB/m)	Result (dBuV/m)	Limit (dBuV/m)	Margin (dB)	Remark
1	2341.855	11.03	32.79	43.82	54.00	-10.18	AVG
2	2390.000	9.59	32.94	42.53	54.00	-11.47	AVG

- Note:
1. Measurement = Reading Level + Correct Factor.
 2. If Peak Result complies with AV limit, AV Result is deemed to comply with AV limit.
 3. Peak: Peak detector.
 4. AVG: $VBW=1/Ton$, where: Ton is the transmitting duration.
 5. For the transmitting duration, please refer to clause 7.1.
 6. Only the worst data was recorded, if it complies with the limit, the other emissions deemed to comply with the limit.

RESTRICTED BANDEDGE (HIGH CHANNEL, HORIZONTAL)

PEAK

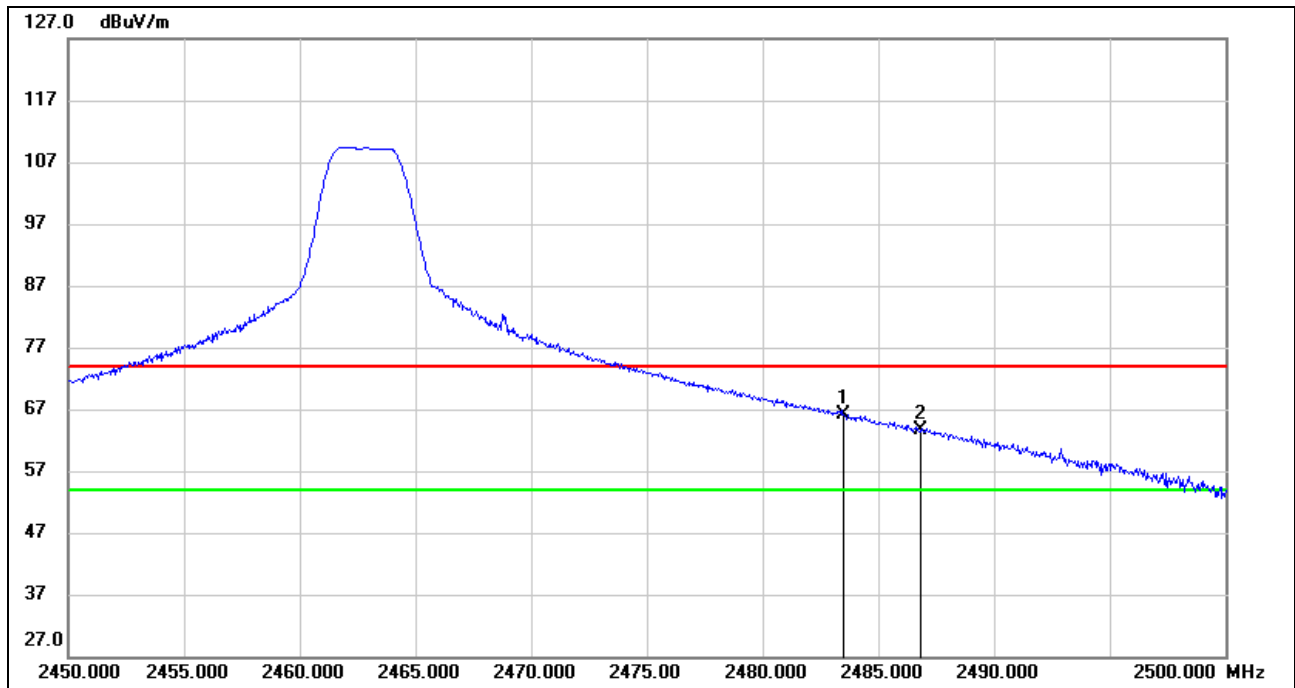

No.	Frequency (MHz)	Reading (dBuV)	Correct (dB/m)	Result (dBuV/m)	Limit (dBuV/m)	Margin (dB)	Remark
1	2483.500	32.48	33.58	66.06	74.00	-7.94	peak
2	2486.850	29.97	33.61	63.58	74.00	-10.42	peak

Note: 1. Measurement = Reading Level + Correct Factor.
 2. If Peak Result complies with AV limit, AV Result is deemed to comply with AV limit.
 3. Peak: Peak detector.
 4. Only the worst data was recorded, if it complies with the limit, the other emissions deemed to comply with the limit.

RESTRICTED BANDEDGE (HIGH CHANNEL, HORIZONTAL)

AVG

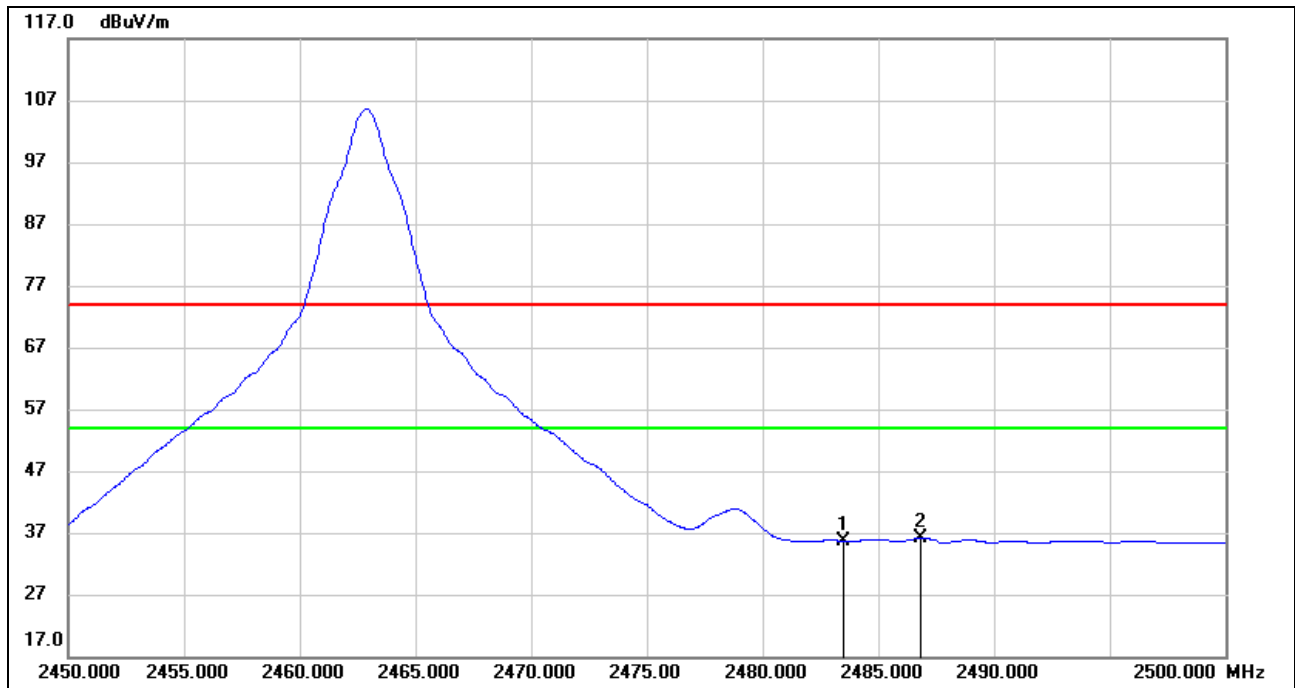

No.	Frequency (MHz)	Reading (dBuV)	Correct (dB/m)	Result (dBuV/m)	Limit (dBuV/m)	Margin (dB)	Remark
1	2483.500	2.05	33.58	35.63	54.00	-18.37	AVG
2	2486.850	2.41	33.61	36.02	54.00	-17.98	AVG

- Note:
1. Measurement = Reading Level + Correct Factor.
 2. If Peak Result complies with AV limit, AV Result is deemed to comply with AV limit.
 3. Peak: Peak detector.
 4. AVG: $VBW=1/Ton$, where: Ton is the transmitting duration.
 5. For the transmitting duration, please refer to clause 7.1.
 6. Only the worst data was recorded, if it complies with the limit, the other emissions deemed to comply with the limit.

RESTRICTED BANDEDGE (HIGH CHANNEL, VERTICAL)

PEAK

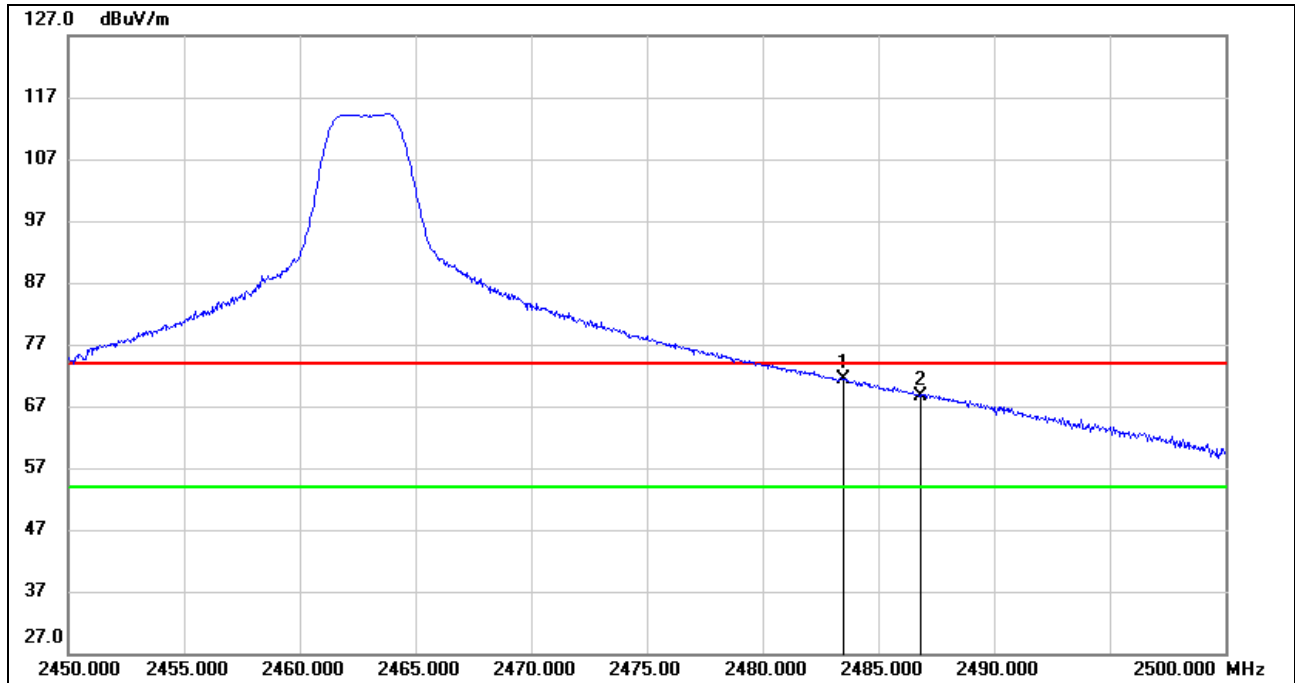

No.	Frequency (MHz)	Reading (dBuV)	Correct (dB/m)	Result (dBuV/m)	Limit (dBuV/m)	Margin (dB)	Remark
1	2483.500	37.72	33.58	71.30	74.00	-2.70	peak
2	2486.850	35.05	33.61	68.66	74.00	-5.34	peak

- Note: 1. Measurement = Reading Level + Correct Factor.
 2. If Peak Result complies with AV limit, AV Result is deemed to comply with AV limit.
 3. Peak: Peak detector.
 4. Only the worst data was recorded, if it complies with the limit, the other emissions deemed to comply with the limit.

RESTRICTED BANDEDGE (HIGH CHANNEL, VERTICAL)

AVG

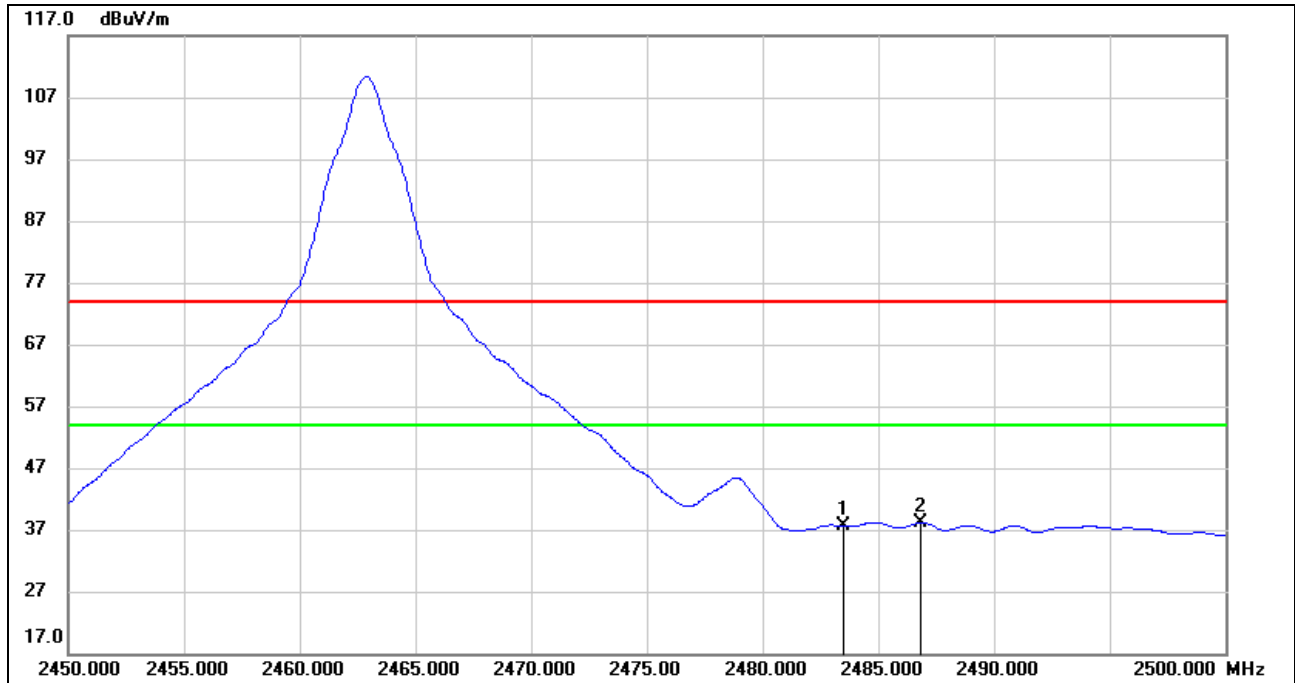

No.	Frequency (MHz)	Reading (dBuV)	Correct (dB/m)	Result (dBuV/m)	Limit (dBuV/m)	Margin (dB)	Remark
1	2483.500	3.98	33.58	37.56	54.00	-16.44	AVG
2	2486.850	4.62	33.61	38.23	54.00	-15.77	AVG

- Note:
1. Measurement = Reading Level + Correct Factor.
 2. If Peak Result complies with AV limit, AV Result is deemed to comply with AV limit.
 3. Peak: Peak detector.
 4. AVG: $VBW=1/Ton$, where: Ton is the transmitting duration.
 5. For the transmitting duration, please refer to clause 7.1.
 6. Only the worst data was recorded, if it complies with the limit, the other emissions deemed to comply with the limit.

8.2. SPURIOUS EMISSIONS (1GHz ~ 3GHz)

8.2.1. Baby Unit

HARMONICS AND SPURIOUS EMISSIONS (LOW CHANNEL, HORIZONTAL)

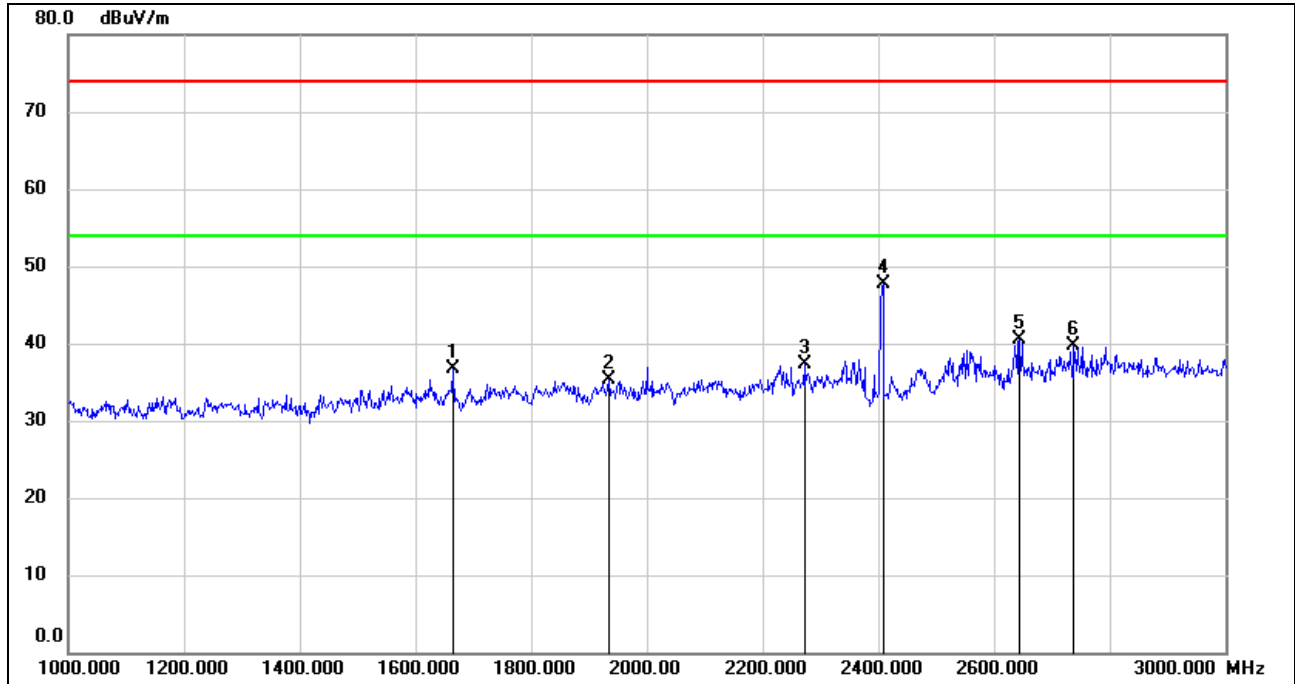

No.	Frequency (MHz)	Reading (dBuV)	Correct (dB/m)	Result (dBuV/m)	Limit (dBuV/m)	Margin (dB)	Remark
1	1664.000	47.74	-11.09	36.65	74.00	-37.35	peak
2	1934.000	45.12	-9.91	35.21	74.00	-38.79	peak
3	2272.000	45.56	-8.33	37.23	74.00	-36.77	peak
4	2408.000	55.52	-7.80	47.72	74.00	-26.28	peak
5	2644.000	48.03	-7.45	40.58	74.00	-33.42	peak
6	2738.000	46.35	-6.72	39.63	74.00	-34.37	peak

Note: 1. Measurement = Reading Level + Correct Factor.

2. If Peak Result complies with AV limit, AV Result is deemed to comply with AV limit.

3. Peak: Peak detector.

4. Filter losses were only considered in the spurious frequency bands and the authorized band was not corrected for Band Reject Filter losses.

5. Proper operation of the transmitter prior to adding the filter to the measurement chain.

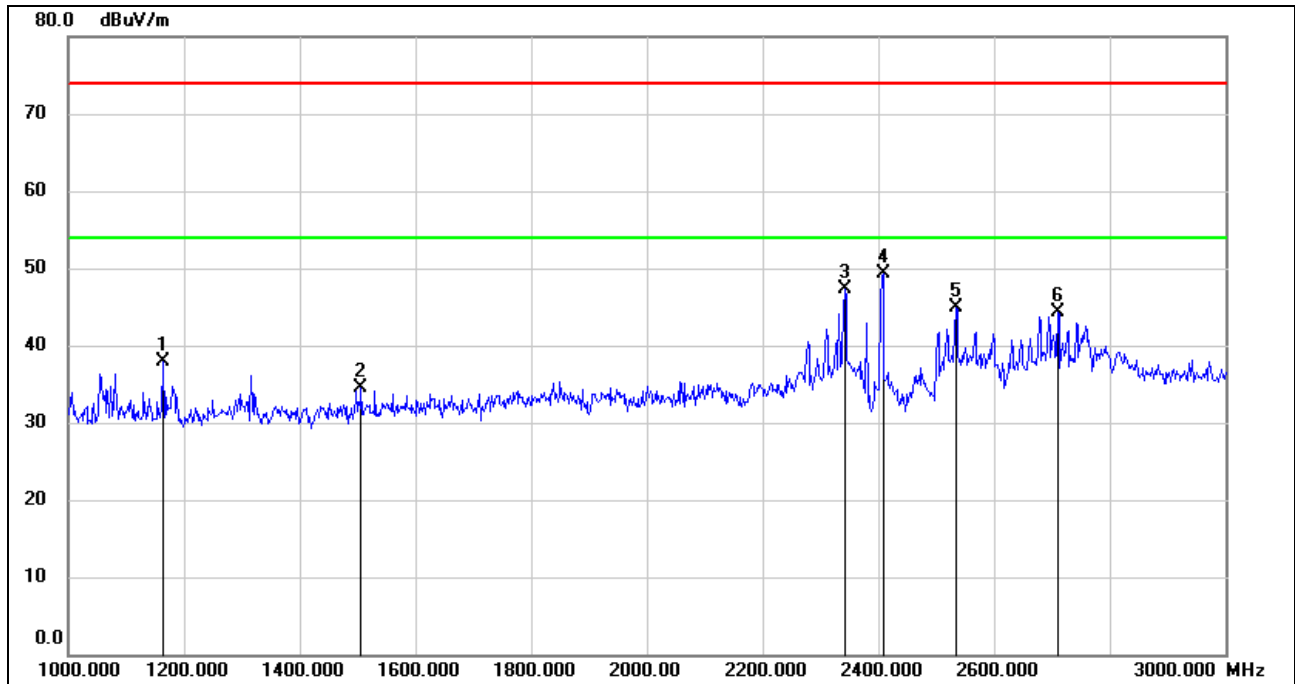
HARMONICS AND SPURIOUS EMISSIONS (LOW CHANNEL, VERTICAL)

No.	Frequency (MHz)	Reading (dBuV)	Correct (dB/m)	Result (dBuV/m)	Limit (dBuV/m)	Margin (dB)	Remark
1	1164.000	50.87	-12.97	37.90	74.00	-36.10	peak
2	1506.000	46.59	-12.16	34.43	74.00	-39.57	peak
3	2342.000	55.39	-8.05	47.34	74.00	-26.66	peak
4	2408.000	57.13	-7.80	49.33	74.00	-24.67	peak
5	2534.000	52.25	-7.35	44.90	74.00	-29.10	peak
6	2710.000	51.40	-7.01	44.39	74.00	-29.61	peak

Note: 1. Measurement = Reading Level + Correct Factor.

2. If Peak Result complies with AV limit, AV Result is deemed to comply with AV limit.

3. Peak: Peak detector.

4. Filter losses were only considered in the spurious frequency bands and the authorized band was not corrected for Band Reject Filter losses.

5. Proper operation of the transmitter prior to adding the filter to the measurement chain.

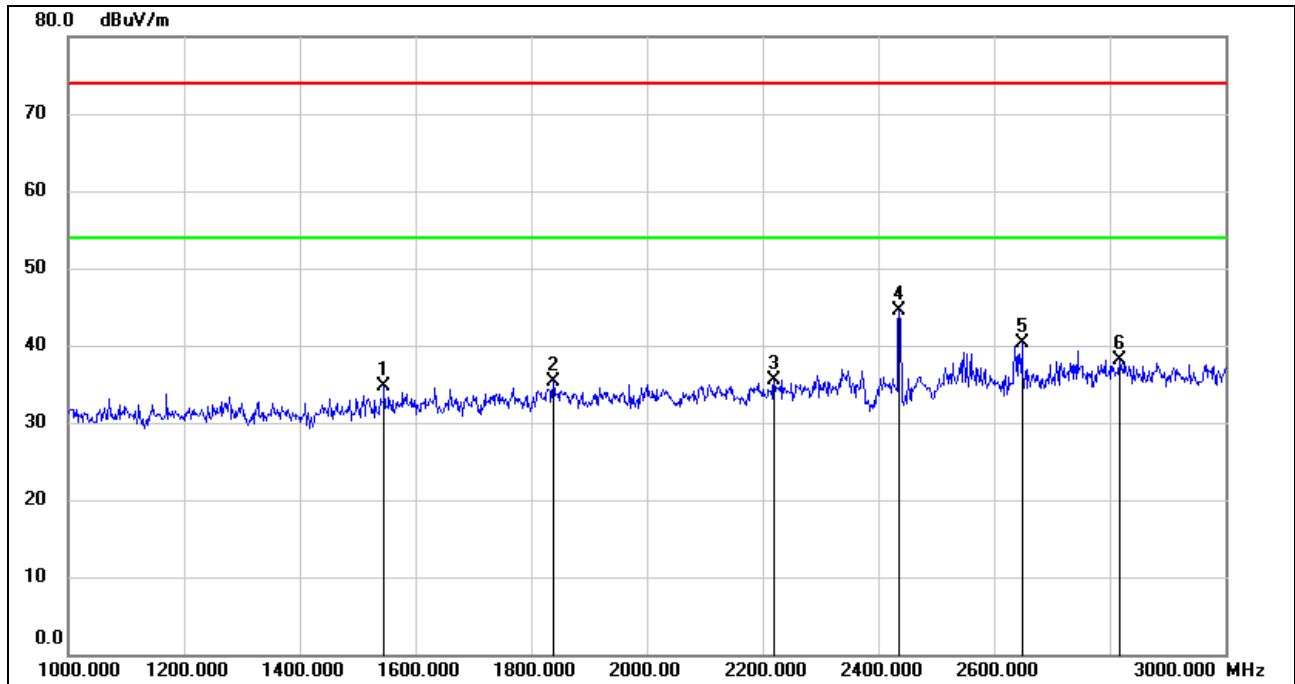
HARMONICS AND SPURIOUS EMISSIONS (MID CHANNEL, HORIZONTAL)

No.	Frequency (MHz)	Reading (dBuV)	Correct (dB/m)	Result (dBuV/m)	Limit (dBuV/m)	Margin (dB)	Remark
1	1546.000	46.64	-11.84	34.80	74.00	-39.20	peak
2	1838.000	45.15	-9.93	35.22	74.00	-38.78	peak
3	2220.000	44.08	-8.56	35.52	74.00	-38.48	peak
4	2436.000	52.14	-7.61	44.53	/	/	fundamental
5	2648.000	47.71	-7.43	40.28	74.00	-33.72	peak
6	2816.000	44.05	-5.97	38.08	74.00	-35.92	peak

Note: 1. Measurement = Reading Level + Correct Factor.

2. If Peak Result complies with AV limit, AV Result is deemed to comply with AV limit.

3. Peak: Peak detector.

4. Filter losses were only considered in the spurious frequency bands and the authorized band was not corrected for Band Reject Filter losses.

5. Proper operation of the transmitter prior to adding the filter to the measurement chain.

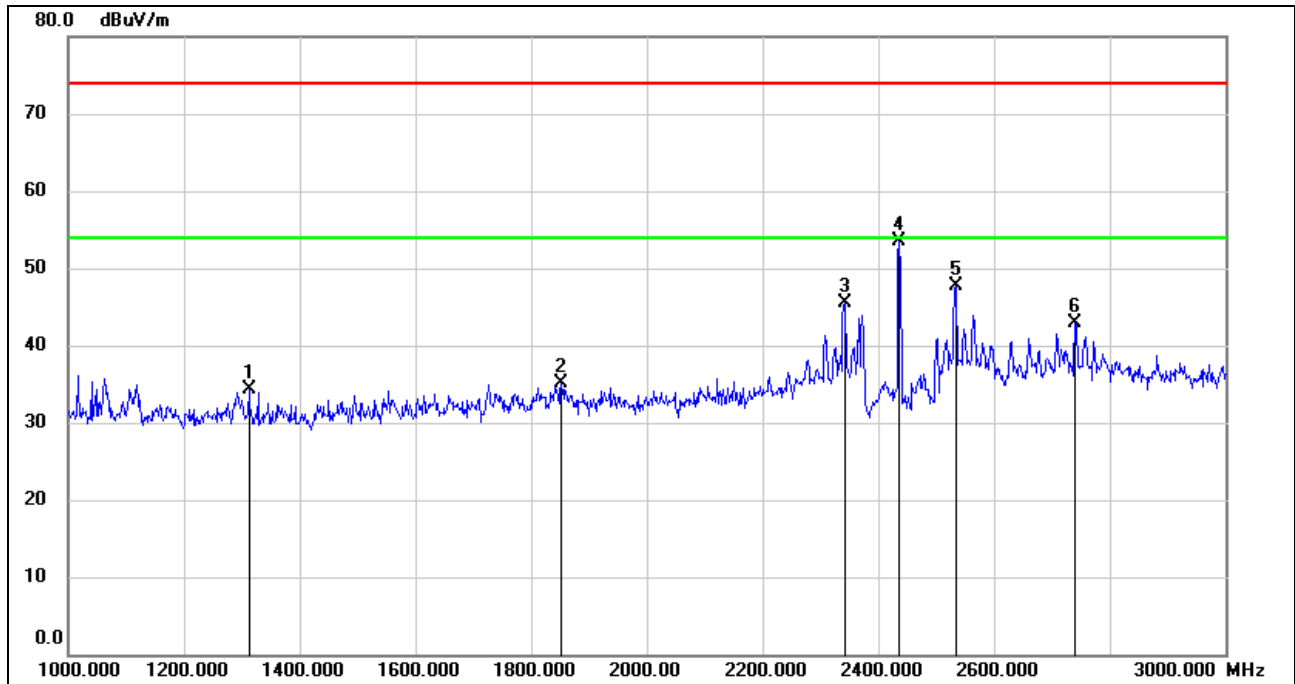
HARMONICS AND SPURIOUS EMISSIONS (MID CHANNEL, VERTICAL)

No.	Frequency (MHz)	Reading (dBuV)	Correct (dB/m)	Result (dBuV/m)	Limit (dBuV/m)	Margin (dB)	Remark
1	1312.000	46.56	-12.35	34.21	74.00	-39.79	peak
2	1852.000	45.00	-9.93	35.07	74.00	-38.93	peak
3	2342.000	53.65	-8.05	45.60	74.00	-28.40	peak
4	2436.000	61.12	-7.61	53.51	/	/	fundamental
5	2534.000	55.01	-7.35	47.66	74.00	-26.34	peak
6	2740.000	49.67	-6.71	42.96	74.00	-31.04	peak

Note: 1. Measurement = Reading Level + Correct Factor.

2. If Peak Result complies with AV limit, AV Result is deemed to comply with AV limit.

3. Peak: Peak detector.

4. Filter losses were only considered in the spurious frequency bands and the authorized band was not corrected for Band Reject Filter losses.

5. Proper operation of the transmitter prior to adding the filter to the measurement chain.

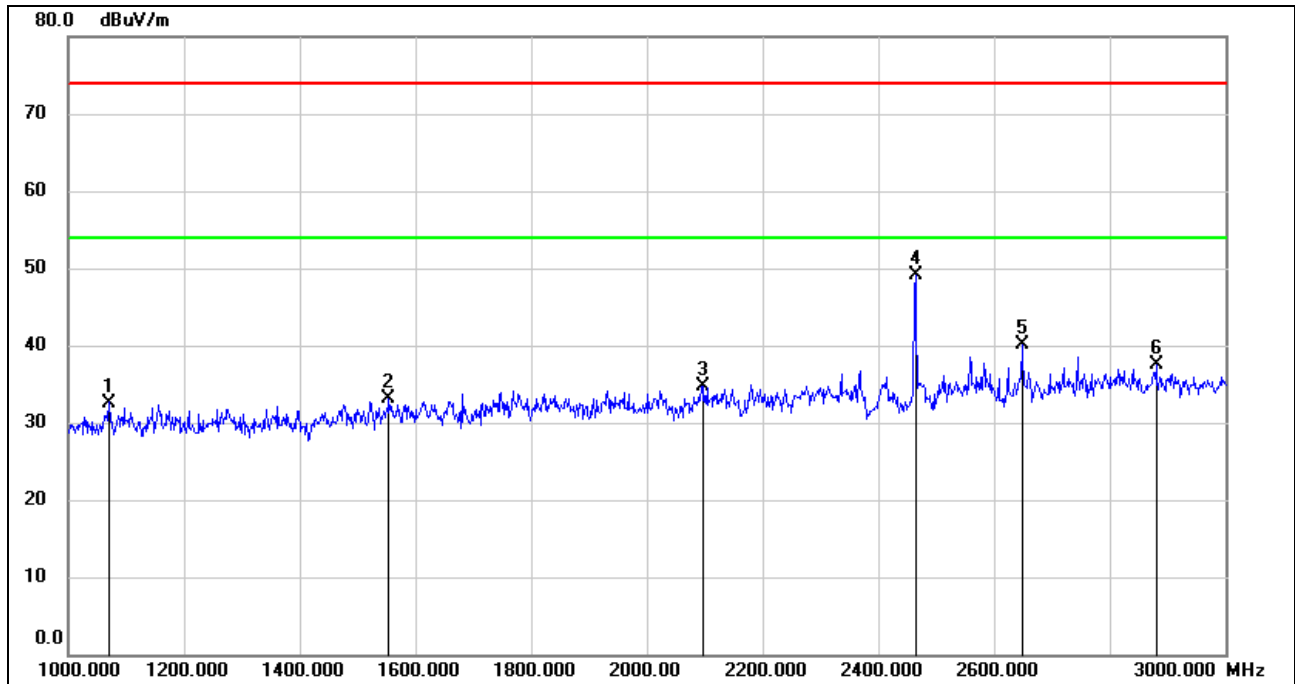
**HARMONICS AND SPURIOUS EMISSIONS (HIGH CHANNEL, HORIZONTAL)**

No.	Frequency (MHz)	Reading (dBuV)	Correct (dB/m)	Result (dBuV/m)	Limit (dBuV/m)	Margin (dB)	Remark
1	1070.000	46.13	-13.53	32.60	74.00	-41.40	peak
2	1554.000	44.81	-11.77	33.04	74.00	-40.96	peak
3	2098.000	43.83	-9.17	34.66	74.00	-39.34	peak
4	2463.000	56.59	-7.42	49.17	/	/	fundamental
5	2648.000	47.61	-7.43	40.18	74.00	-33.82	peak
6	2880.000	43.14	-5.62	37.52	74.00	-36.48	peak

Note: 1. Measurement = Reading Level + Correct Factor.

2. If Peak Result complies with AV limit, AV Result is deemed to comply with AV limit.

3. Peak: Peak detector.

4. Filter losses were only considered in the spurious frequency bands and the authorized band was not corrected for Band Reject Filter losses.

5. Proper operation of the transmitter prior to adding the filter to the measurement chain.

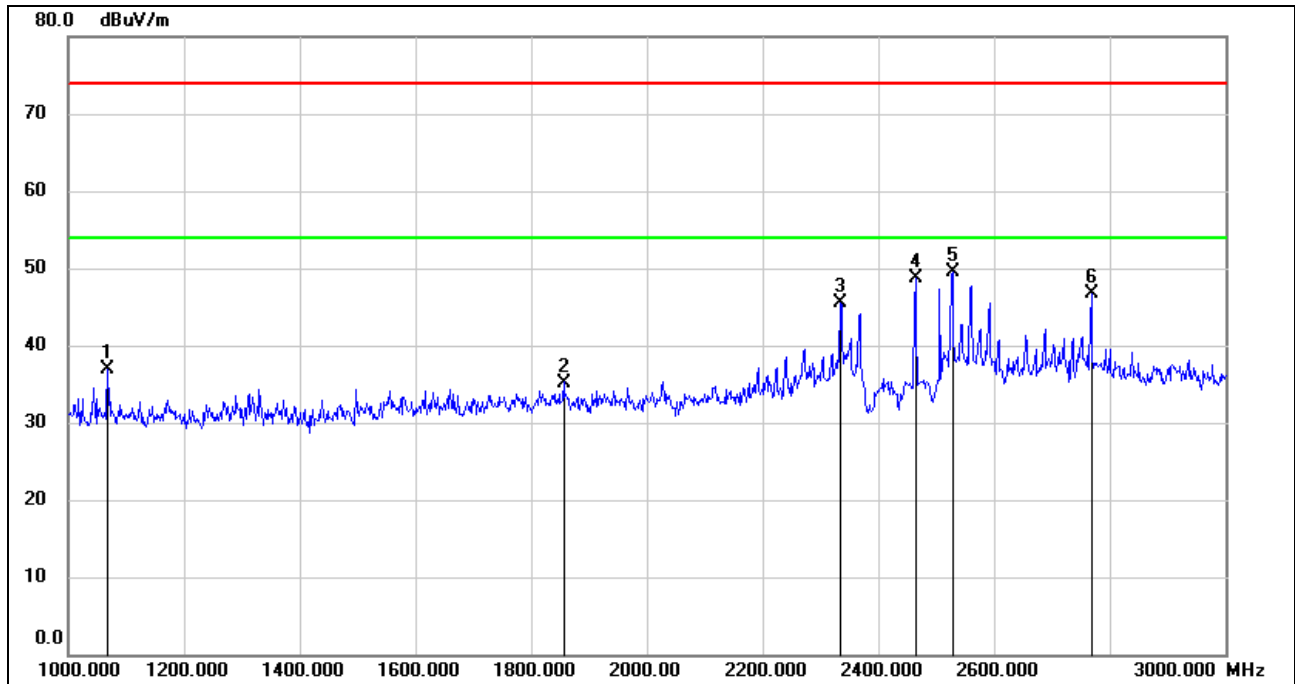
HARMONICS AND SPURIOUS EMISSIONS (HIGH CHANNEL, VERTICAL)

No.	Frequency (MHz)	Reading (dBuV)	Correct (dB/m)	Result (dBuV/m)	Limit (dBuV/m)	Margin (dB)	Remark
1	1068.000	50.40	-13.54	36.86	74.00	-37.14	peak
2	1856.000	45.13	-9.93	35.20	74.00	-38.80	peak
3	2334.000	53.66	-8.08	45.58	74.00	-28.42	peak
4	2463.000	56.09	-7.41	48.68	/	/	fundamental
5	2528.000	56.91	-7.32	49.59	74.00	-24.41	peak
6	2768.000	53.07	-6.40	46.67	74.00	-27.33	peak

- Note: 1. Measurement = Reading Level + Correct Factor.
 2. If Peak Result complies with AV limit, AV Result is deemed to comply with AV limit.
 3. Peak: Peak detector.
 4. Filter losses were only considered in the spurious frequency bands and the authorized band was not corrected for Band Reject Filter losses.
 5. Proper operation of the transmitter prior to adding the filter to the measurement chain.

8.3. SPURIOUS EMISSIONS (3GHz ~ 18GHz)

8.3.1. Baby Unit

HARMONICS AND SPURIOUS EMISSIONS (LOW CHANNEL, HORIZONTAL)

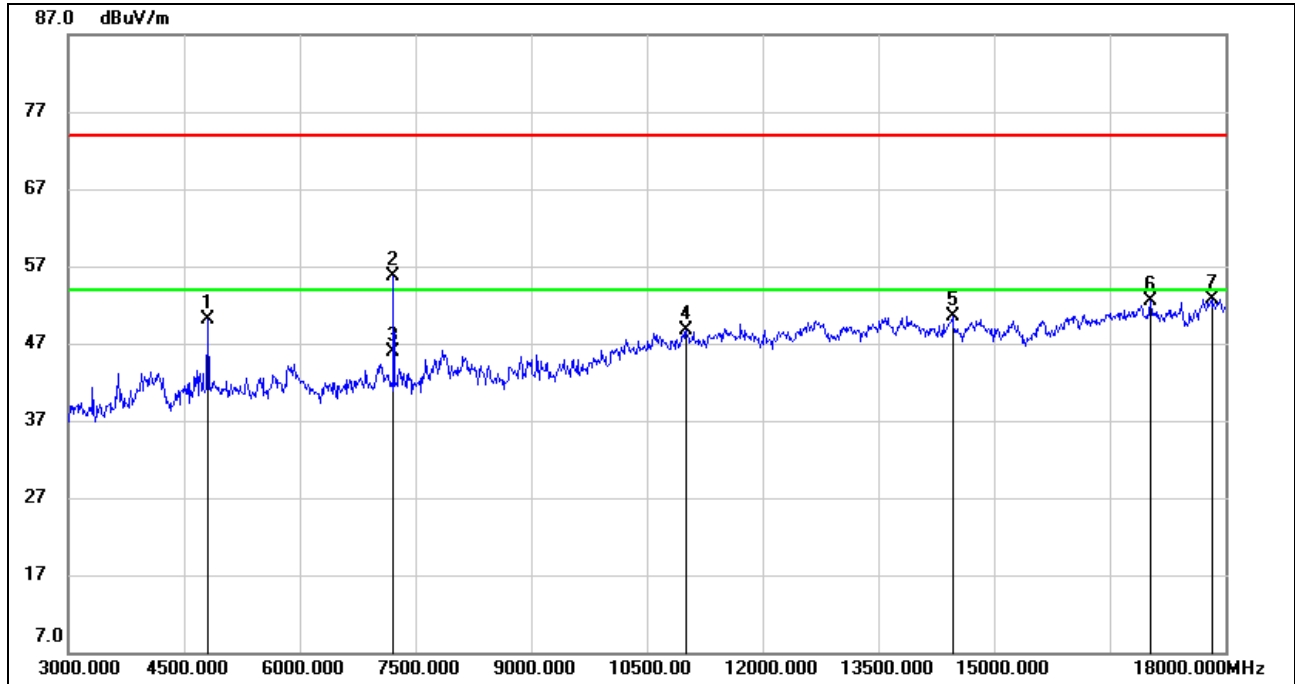

No.	Frequency (MHz)	Reading (dBuV)	Correct (dB/m)	Result (dBuV/m)	Limit (dBuV/m)	Margin (dB)	Remark
1	4800.000	49.63	0.46	50.09	74.00	-23.91	peak
2	7215.000	49.92	5.85	55.77	74.00	-18.23	peak
3	7215.000	40.12	5.85	45.97	54.00	-8.03	AVG
4	11010.000	36.02	12.63	48.65	74.00	-25.35	peak
5	14460.000	34.15	16.36	50.51	74.00	-23.49	peak
6	17025.000	32.08	20.46	52.54	74.00	-21.46	peak
7	17820.000	29.36	23.30	52.66	74.00	-21.34	peak

- Note:
1. Peak Result = Reading Level + Correct Factor.
 2. If Peak Result complies with AV limit, AV Result is deemed to comply with AV limit.
 3. Peak: Peak detector.
 4. AVG: $VBW=1/Ton$, where: Ton is the transmitting duration.
 5. For the transmitting duration, please refer to clause 7.1.
 6. Filter losses were only considered in the spurious frequency bands and the authorized band was not corrected for High Pass Filter losses.
 7. Proper operation of the transmitter prior to adding the filter to the measurement chain.

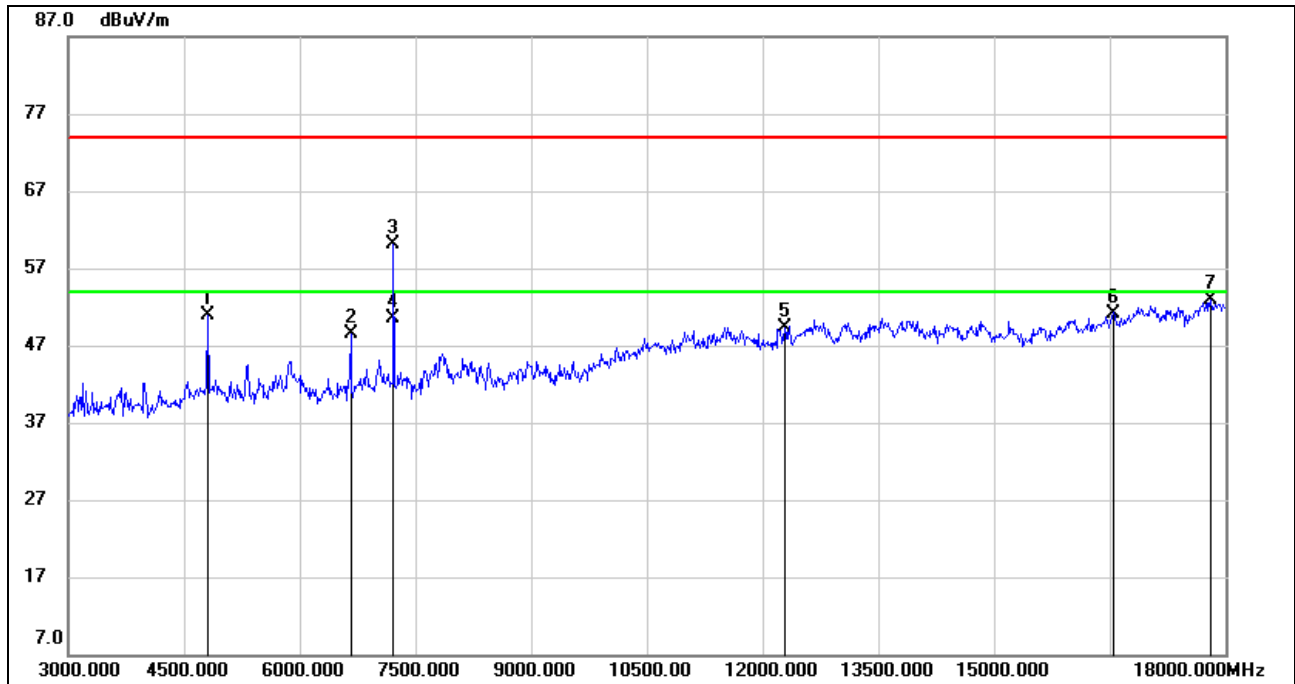
**HARMONICS AND SPURIOUS EMISSIONS (LOW CHANNEL, VERTICAL)**

No.	Frequency (MHz)	Reading (dBuV)	Correct (dB/m)	Result (dBuV/m)	Limit (dBuV/m)	Margin (dB)	Remark
1	4800.000	50.48	0.46	50.94	74.00	-23.06	peak
2	6660.000	43.22	5.22	48.44	74.00	-25.56	peak
3	7215.839	54.29	5.85	60.14	74.00	-13.86	peak
4	7215.839	44.71	5.85	50.56	54.00	-3.44	AVG
5	12285.000	35.24	14.01	49.25	74.00	-24.75	peak
6	16545.000	31.89	19.31	51.20	74.00	-22.80	peak
7	17805.000	29.58	23.31	52.89	74.00	-21.11	peak

- Note: 1. Peak Result = Reading Level + Correct Factor.
 2. If Peak Result complies with AV limit, AV Result is deemed to comply with AV limit.
 3. Peak: Peak detector.
 4. AVG: $VBW=1/Ton$, where: Ton is the transmitting duration.
 5. For the transmitting duration, please refer to clause 7.1.
 6. Filter losses were only considered in the spurious frequency bands and the authorized band was not corrected for High Pass Filter losses.
 7. Proper operation of the transmitter prior to adding the filter to the measurement chain.

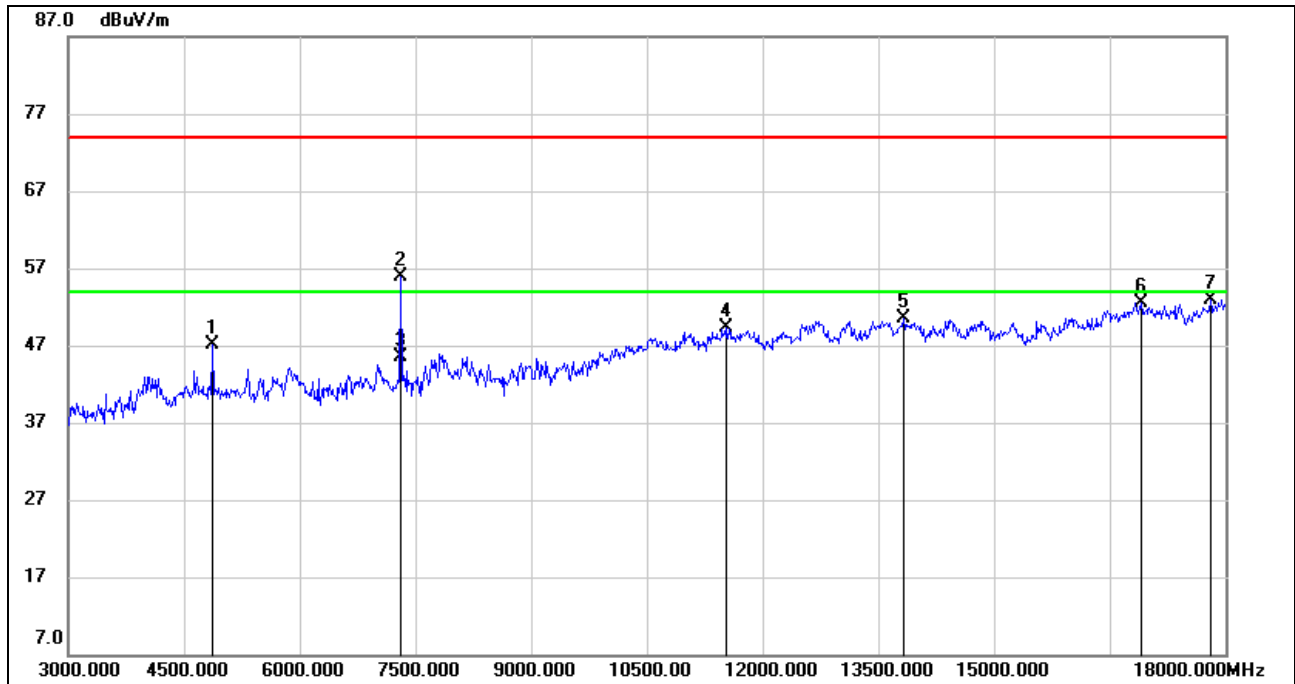
HARMONICS AND SPURIOUS EMISSIONS (MID CHANNEL, HORIZONTAL)

No.	Frequency (MHz)	Reading (dBuV)	Correct (dB/m)	Result (dBuV/m)	Limit (dBuV/m)	Margin (dB)	Remark
1	4875.000	46.32	0.76	47.08	74.00	-26.92	peak
2	7309.535	49.79	6.11	55.90	74.00	-18.10	peak
3	7309.535	39.49	6.11	45.60	54.00	-8.40	AVG
4	11535.000	35.93	13.33	49.26	74.00	-24.74	peak
5	13830.000	33.68	16.84	50.52	74.00	-23.48	peak
6	16905.000	32.56	19.99	52.55	74.00	-21.45	peak
7	17805.000	29.68	23.31	52.99	74.00	-21.01	peak

Note: 1. Peak Result = Reading Level + Correct Factor.

2. If Peak Result complies with AV limit, AV Result is deemed to comply with AV limit.

3. Peak: Peak detector.

4. AVG: $VBW=1/Ton$, where: Ton is the transmitting duration.

5. For the transmitting duration, please refer to clause 7.1.

6. Filter losses were only considered in the spurious frequency bands and the authorized band was not corrected for High Pass Filter losses.

7. Proper operation of the transmitter prior to adding the filter to the measurement chain.

HARMONICS AND SPURIOUS EMISSIONS (MID CHANNEL, VERTICAL)

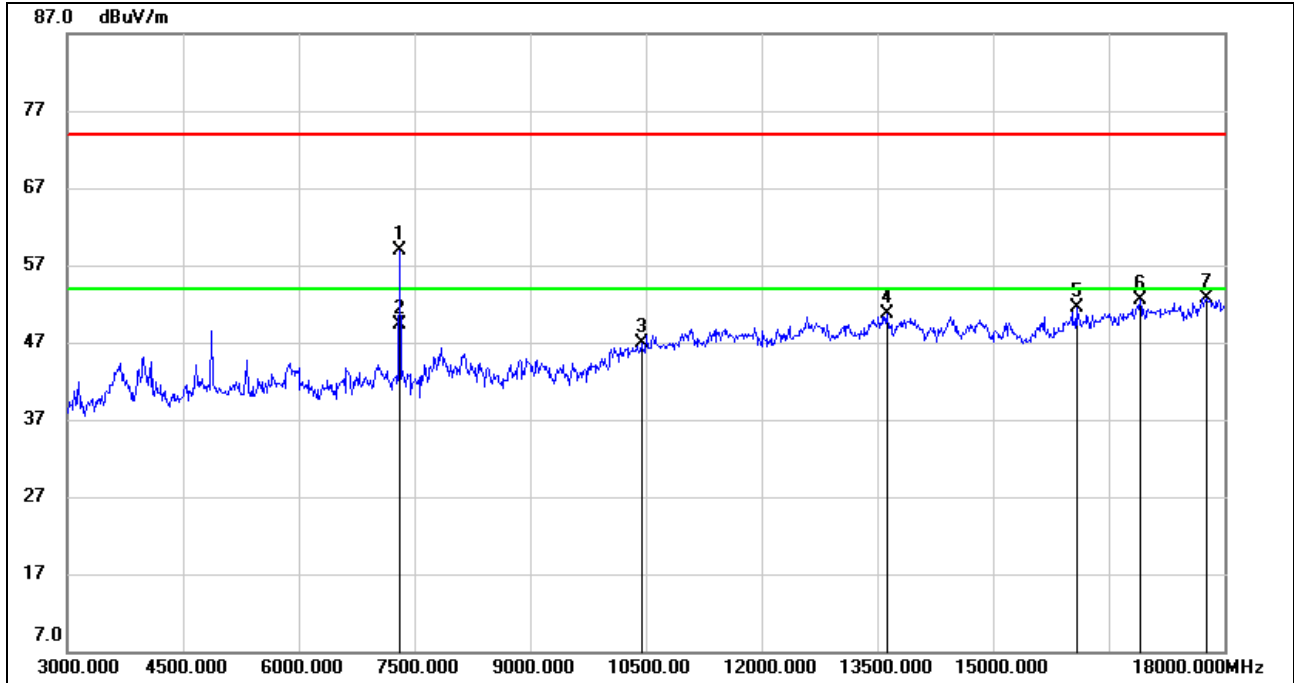

No.	Frequency (MHz)	Reading (dBuV)	Correct (dB/m)	Result (dBuV/m)	Limit (dBuV/m)	Margin (dB)	Remark
1	7309.535	52.71	6.11	58.82	74.00	-15.18	peak
2	7309.535	43.20	6.11	49.31	54.00	-4.69	AVG
3	10440.000	35.73	11.13	46.86	74.00	-27.14	peak
4	13620.000	34.72	15.99	50.71	74.00	-23.29	peak
5	16080.000	33.44	18.04	51.48	74.00	-22.52	peak
6	16905.000	32.56	19.99	52.55	74.00	-21.45	peak
7	17775.000	29.68	23.09	52.77	74.00	-21.23	peak

- Note: 1. Peak Result = Reading Level + Correct Factor.
 2. If Peak Result complies with AV limit, AV Result is deemed to comply with AV limit.
 3. Peak: Peak detector.
 4. AVG: $VBW=1/Ton$, where: Ton is the transmitting duration.
 5. For the transmitting duration, please refer to clause 7.1.
 6. Filter losses were only considered in the spurious frequency bands and the authorized band was not corrected for High Pass Filter losses.
 7. Proper operation of the transmitter prior to adding the filter to the measurement chain.

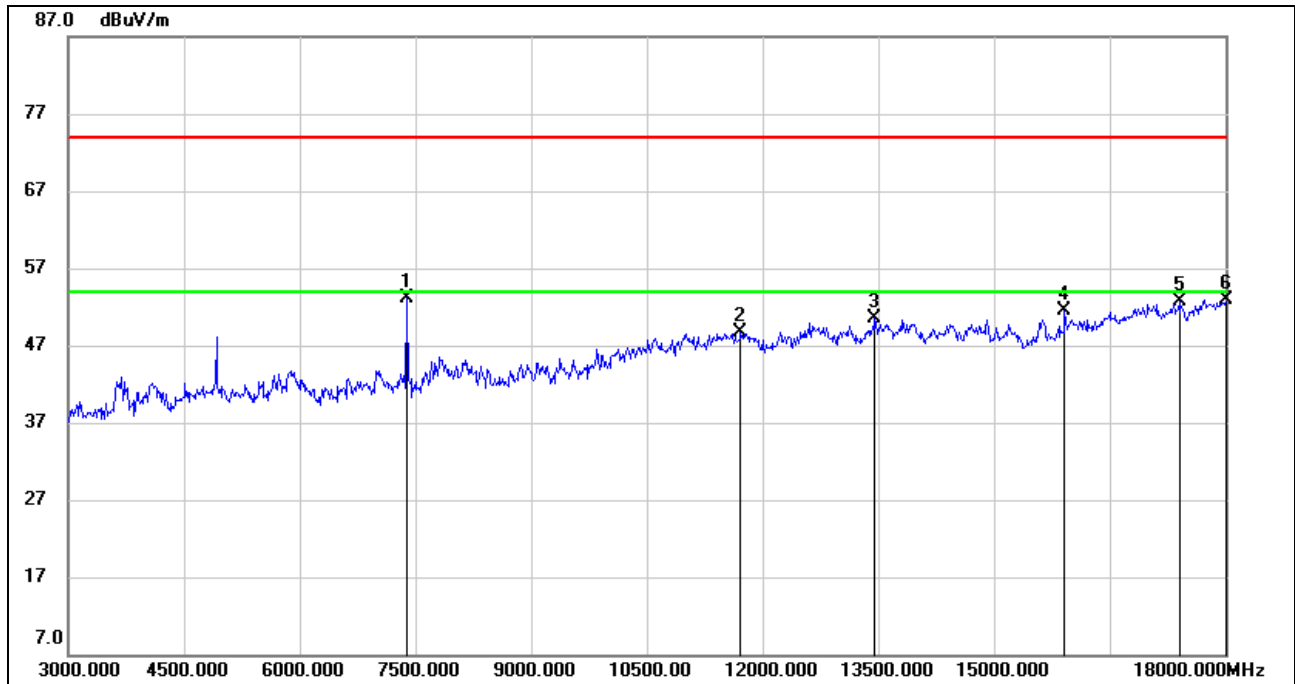
HARMONICS AND SPURIOUS EMISSIONS (HIGH CHANNEL, HORIZONTAL)

No.	Frequency (MHz)	Reading (dBuV)	Correct (dB/m)	Result (dBuV/m)	Limit (dBuV/m)	Margin (dB)	Remark
1	7380.000	46.71	6.41	53.12	74.00	-20.88	peak
2	11715.000	35.63	12.99	48.62	74.00	-25.38	peak
3	13455.000	34.59	15.93	50.52	74.00	-23.48	peak
4	15915.000	33.95	17.57	51.52	74.00	-22.48	peak
5	17400.000	31.30	21.41	52.71	74.00	-21.29	peak
6	18000.000	29.43	23.46	52.89	74.00	-21.11	peak

- Note: 1. Peak Result = Reading Level + Correct Factor.
 2. If Peak Result complies with AV limit, AV Result is deemed to comply with AV limit.
 3. Peak: Peak detector.
 4. Filter losses were only considered in the spurious frequency bands and the authorized band was not corrected for High Pass Filter losses.
 5. Proper operation of the transmitter prior to adding the filter to the measurement chain.

HARMONICS AND SPURIOUS EMISSIONS (HIGH CHANNEL, VERTICAL)

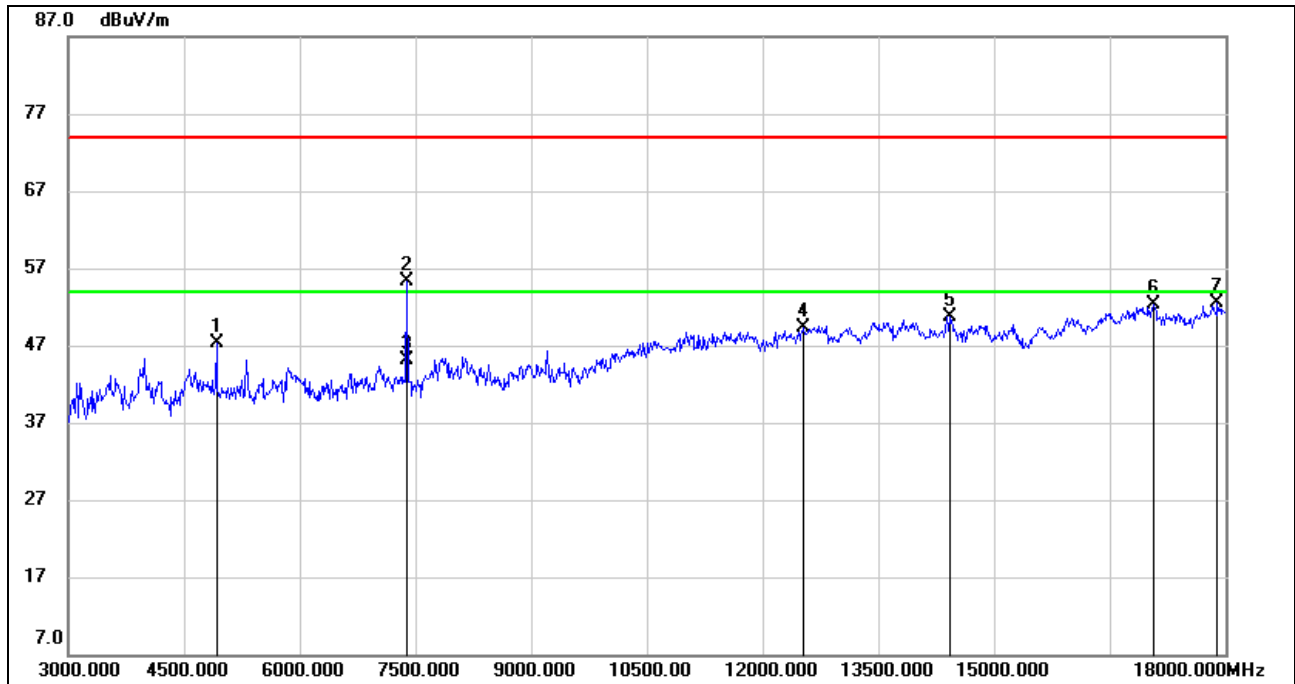

No.	Frequency (MHz)	Reading (dBuV)	Correct (dB/m)	Result (dBuV/m)	Limit (dBuV/m)	Margin (dB)	Remark
1	4920.000	46.31	0.96	47.27	74.00	-26.73	peak
2	7386.773	48.86	6.44	55.30	74.00	-18.70	peak
3	7386.773	38.71	6.44	45.15	54.00	-8.85	AVG
4	12525.000	34.84	14.41	49.25	74.00	-24.75	peak
5	14430.000	34.38	16.35	50.73	74.00	-23.27	peak
6	17070.000	31.71	20.57	52.28	74.00	-21.72	peak
7	17895.000	29.26	23.34	52.60	74.00	-21.40	peak

- Note: 1. Peak Result = Reading Level + Correct Factor.
 2. If Peak Result complies with AV limit, AV Result is deemed to comply with AV limit.
 3. Peak: Peak detector.
 4. AVG: $VBW=1/Ton$, where: Ton is the transmitting duration.
 5. For the transmitting duration, please refer to clause 7.1.
 6. Filter losses were only considered in the spurious frequency bands and the authorized band was not corrected for High Pass Filter losses.
 7. Proper operation of the transmitter prior to adding the filter to the measurement chain.

8.4. SPURIOUS EMISSIONS (18GHz ~ 26GHz)

8.4.1. Baby Unit

SPURIOUS EMISSIONS (MID CHANNEL, WORST-CASE CONFIGURATION, HORIZONTAL)

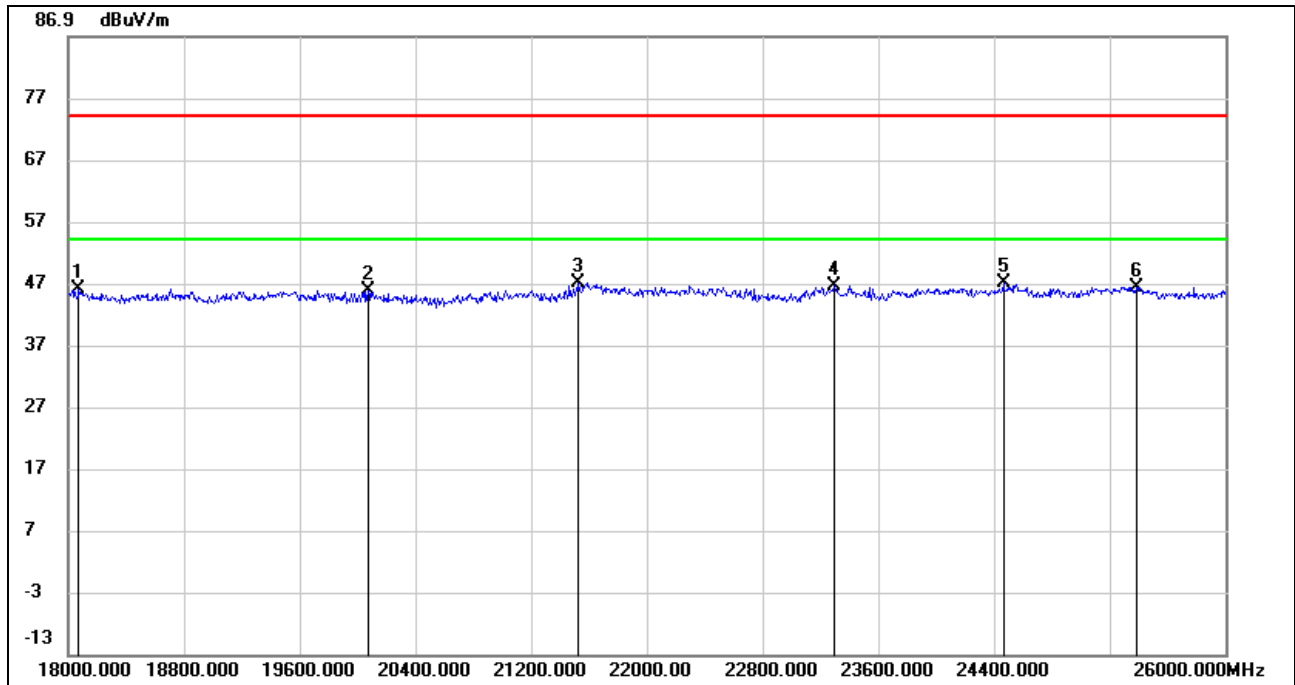

No.	Frequency (MHz)	Reading (dBuV)	Correct (dB/m)	Result (dBuV/m)	Limit (dBuV/m)	Margin (dB)	Remark
1	18072.000	50.05	-4.02	46.03	74.00	-27.97	peak
2	20072.000	50.34	-4.51	45.83	74.00	-28.17	peak
3	21528.000	52.92	-5.78	47.14	74.00	-26.86	peak
4	23296.000	51.80	-5.16	46.64	74.00	-27.36	peak
5	24464.000	49.78	-2.74	47.04	74.00	-26.96	peak
6	25384.000	47.92	-1.53	46.39	74.00	-27.61	peak

Note: 1. Peak Result = Reading Level + Correct Factor.

2. If Peak Result complies with AV limit, AV Result is deemed to comply with AV limit.

3. Peak: Peak detector.

4. The preamplifier only effect to the above 18GHz signal and no filter added to the measurement chain.

SPURIOUS EMISSIONS (MID CHANNEL, WORST-CASE CONFIGURATION, VERTICAL)

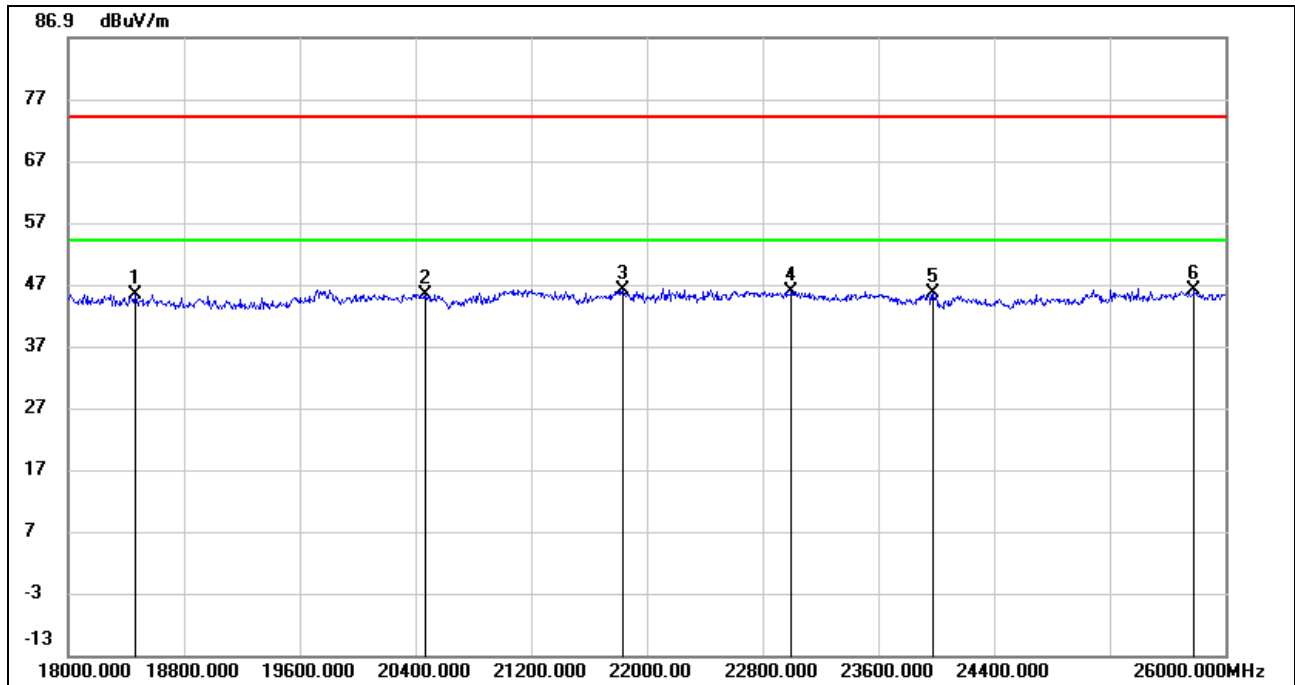

No.	Frequency (MHz)	Reading (dBuV)	Correct (dB/m)	Result (dBuV/m)	Limit (dBuV/m)	Margin (dB)	Remark
1	18464.000	49.70	-4.39	45.31	74.00	-28.69	peak
2	20464.000	50.34	-4.95	45.39	74.00	-28.61	peak
3	21832.000	52.03	-5.92	46.11	74.00	-27.89	peak
4	23000.000	51.45	-5.61	45.84	74.00	-28.16	peak
5	23976.000	49.54	-4.08	45.46	74.00	-28.54	peak
6	25784.000	47.58	-1.49	46.09	74.00	-27.91	peak

Note: 1. Peak Result = Reading Level + Correct Factor.
 2. If Peak Result complies with AV limit, AV Result is deemed to comply with AV limit.
 3. Peak: Peak detector.
 4. The preamplifier only effect to the above 18GHz signal and no filter added to the measurement chain.

Note: All the modes have been tested, only the worst data was recorded in the report.

8.5. SPURIOUS EMISSIONS (30MHz ~ 1 GHz)

8.5.1. Baby Unit

SPURIOUS EMISSIONS (MID CHANNEL, WORST-CASE CONFIGURATION, HORIZONTAL)

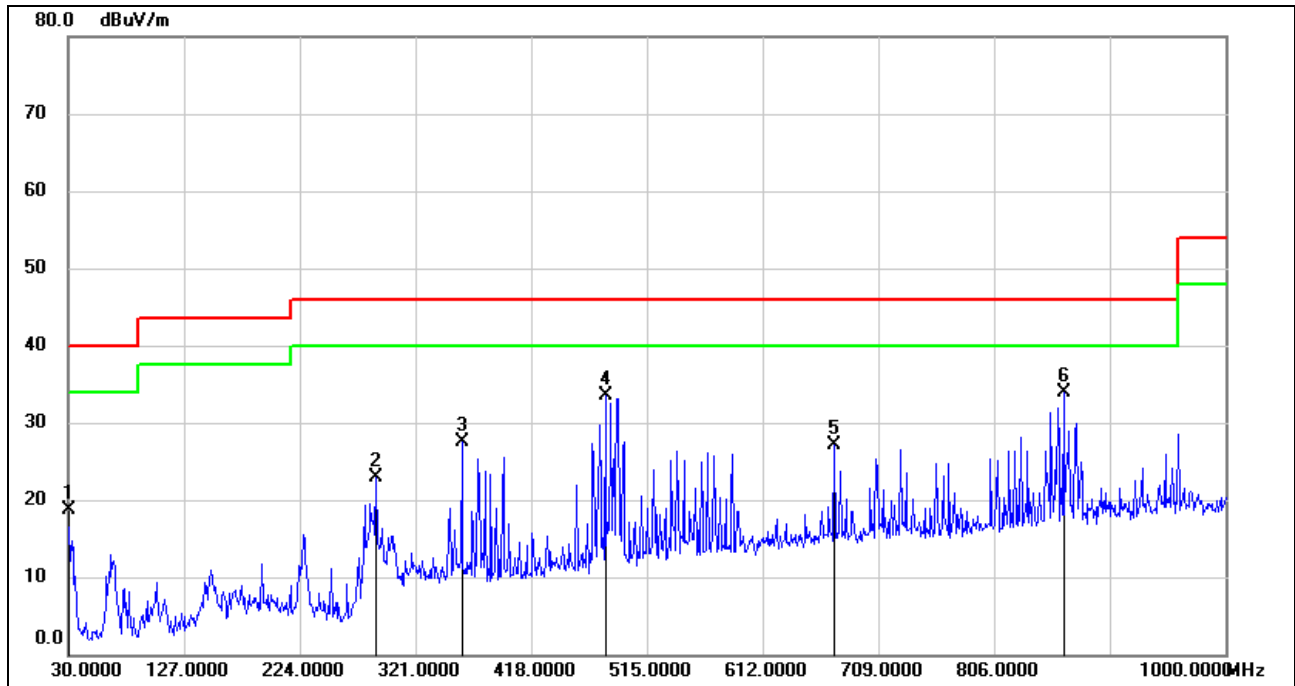

No.	Frequency (MHz)	Reading (dBuV)	Correct (dB/m)	Result (dBuV/m)	Limit (dBuV/m)	Margin (dB)	Remark
1	30.0000	37.71	-19.04	18.67	40.00	-21.33	QP
2	288.0200	39.46	-16.51	22.95	46.00	-23.05	QP
3	359.8000	41.90	-14.32	27.58	46.00	-18.42	QP
4	480.0800	45.39	-11.98	33.41	46.00	-12.59	QP
5	672.1400	36.29	-9.13	27.16	46.00	-18.84	QP
6	864.2000	40.16	-6.33	33.83	46.00	-12.17	QP

Note: 1. Result Level = Read Level + Antenna Factor + Cable loss.
 2. If Peak Result complies with QP limit, QP Result is deemed to comply with QP limit.
 3. Test setup: RBW: 120 kHz, VBW: 300 kHz, Sweep time: auto.

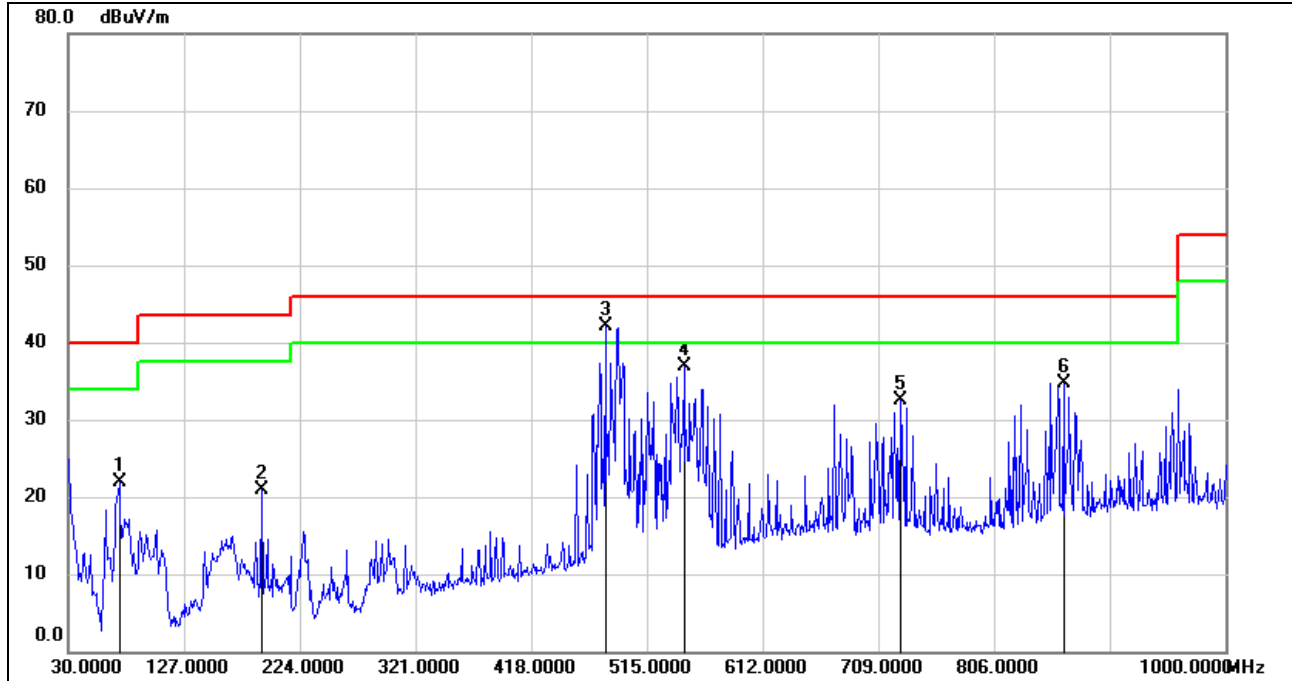
SPURIOUS EMISSIONS (MID CHANNEL, WORST-CASE CONFIGURATION, VERTICAL)

No.	Frequency (MHz)	Reading (dBuV)	Correct (dB/m)	Result (dBuV/m)	Limit (dBuV/m)	Margin (dB)	Remark
1	72.6800	42.70	-20.87	21.83	40.00	-18.17	QP
2	191.9900	37.70	-16.74	20.96	43.50	-22.54	QP
3	480.0800	54.07	-11.98	42.09	46.00	-3.91	QP
4	546.0400	47.70	-10.84	36.86	46.00	-9.14	QP
5	727.4300	41.13	-8.54	32.59	46.00	-13.41	QP
6	864.2000	41.11	-6.33	34.78	46.00	-11.22	QP

Note: 1. Result Level = Read Level + Antenna Factor + Cable loss.

2. If Peak Result complies with QP limit, QP Result is deemed to comply with QP limit.

3. Test setup: RBW: 120 kHz, VBW: 300 kHz, Sweep time: auto

Note: All the modes have been tested, only the worst data was recorded in the report.

8.6. SPURIOUS EMISSIONS BELOW 30MHz

8.6.1. Baby Unit

(MID CHANNEL, LOOP ANTENNA FACE ON TO THE EUT, WORST-CASE CONFIGURATION)

9kHz~ 150kHz

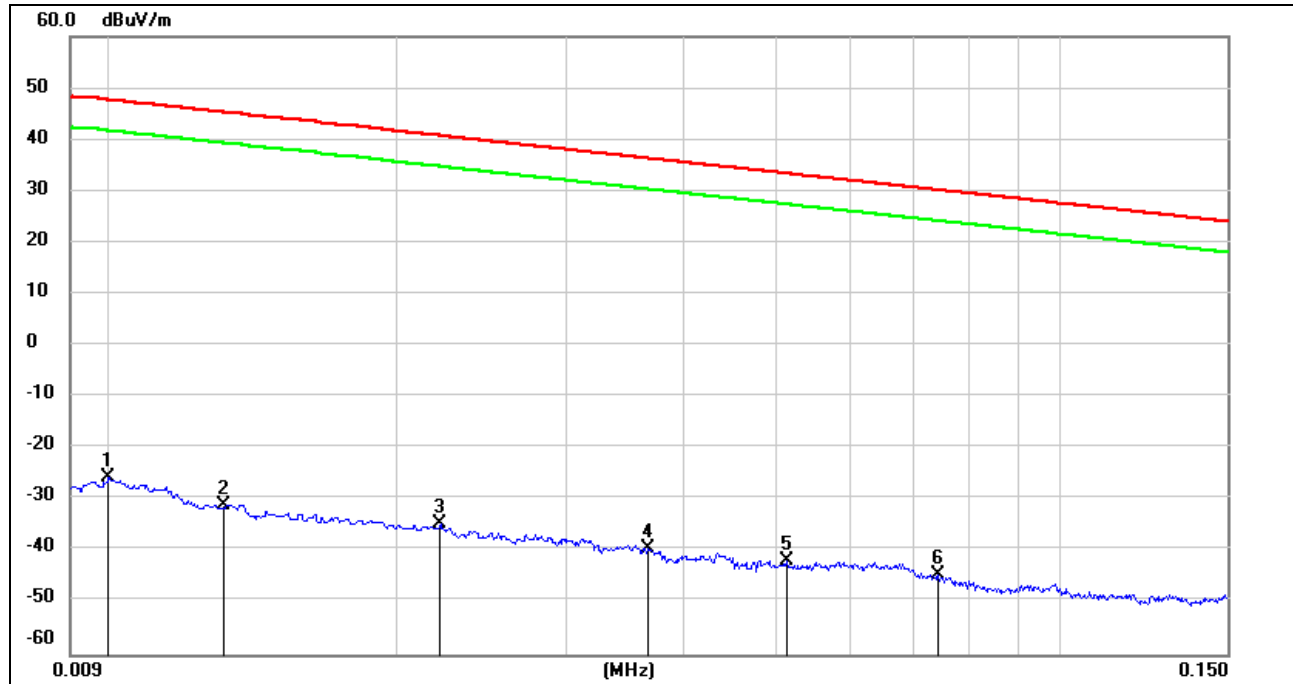

No.	Frequency (MHz)	Reading (dBUV)	Correct (dB/m)	FCC Result (dBUV/m)	FCC Limit (dBUV/m)	Margin (dB)	Remark
1	0.0100	75.72	-101.40	-25.68	47.60	-73.28	peak
2	0.0131	70.47	-101.38	-30.91	45.25	-76.16	peak
3	0.0221	66.63	-101.35	-34.72	40.71	-75.43	peak
4	0.0366	61.87	-101.42	-39.55	36.33	-75.88	peak
5	0.0514	59.68	-101.48	-41.80	33.38	-75.18	peak
6	0.0743	57.08	-101.59	-44.51	30.18	-74.69	peak

Note: 1. Measurement = Reading Level + Correct Factor.

2. If Peak Result complies with AV and QP limit, AV and QP Result are deemed to comply with AV limit.

3. All 3 polarizations(Horizontal, Face-on and Face-off) of the loop antenna had been tested, but only the worst data recorded in the report.

150kHz ~ 490kHz

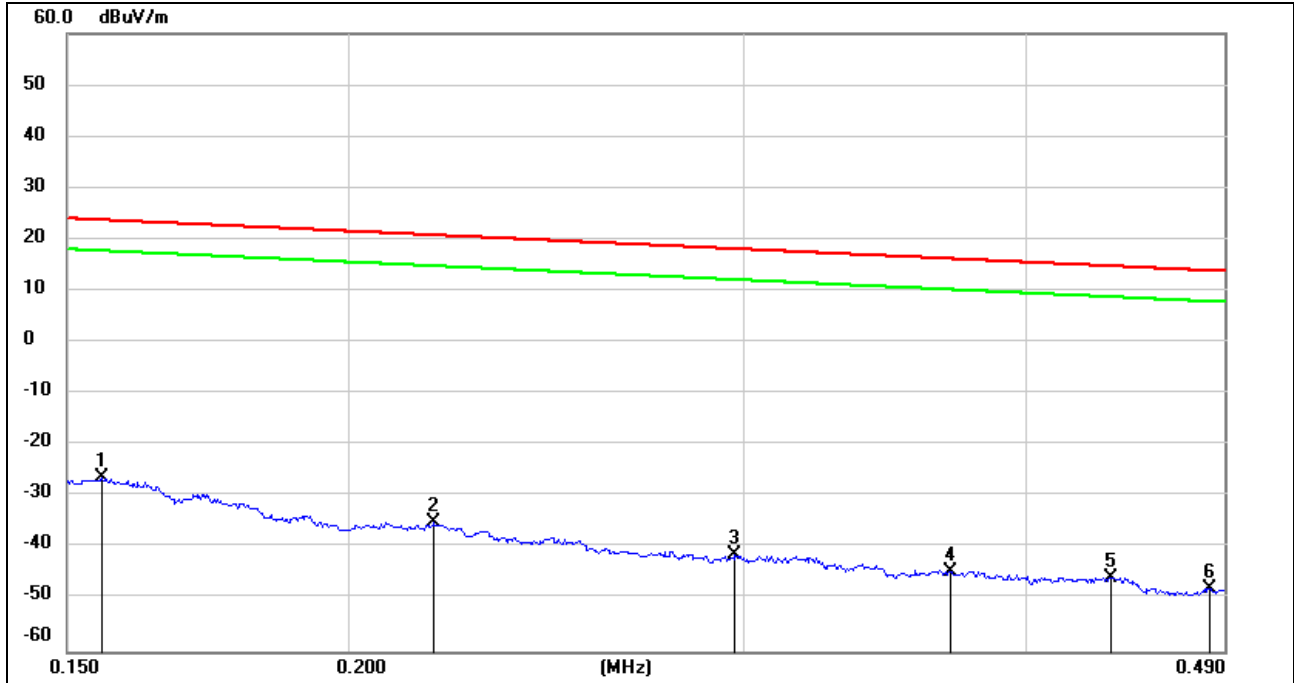

No.	Frequency (MHz)	Reading (dBuV)	Correct (dB/m)	FCC Result (dBuV/m)	FCC Limit (dBuV/m)	Margin (dB)	Remark
1	0.1554	75.27	-101.65	-26.38	23.77	-50.15	peak
2	0.2182	66.70	-101.75	-35.05	20.82	-55.87	peak
3	0.2972	60.66	-101.85	-41.19	18.14	-59.33	peak
4	0.3703	57.41	-101.93	-44.52	16.23	-60.75	peak
5	0.4364	56.36	-101.99	-45.63	14.80	-60.43	peak
6	0.4823	54.19	-102.04	-47.85	13.94	-61.79	peak

Note: 1. Measurement = Reading Level + Correct Factor.
 2. If Peak Result complies with AV and QP limit, AV and QP Result are deemed to comply with AV limit.
 3. All 3 polarizations(Horizontal, Face-on and Face-off) of the loop antenna had been tested, but only the worst data recorded in the report.

490kHz ~ 30MHz

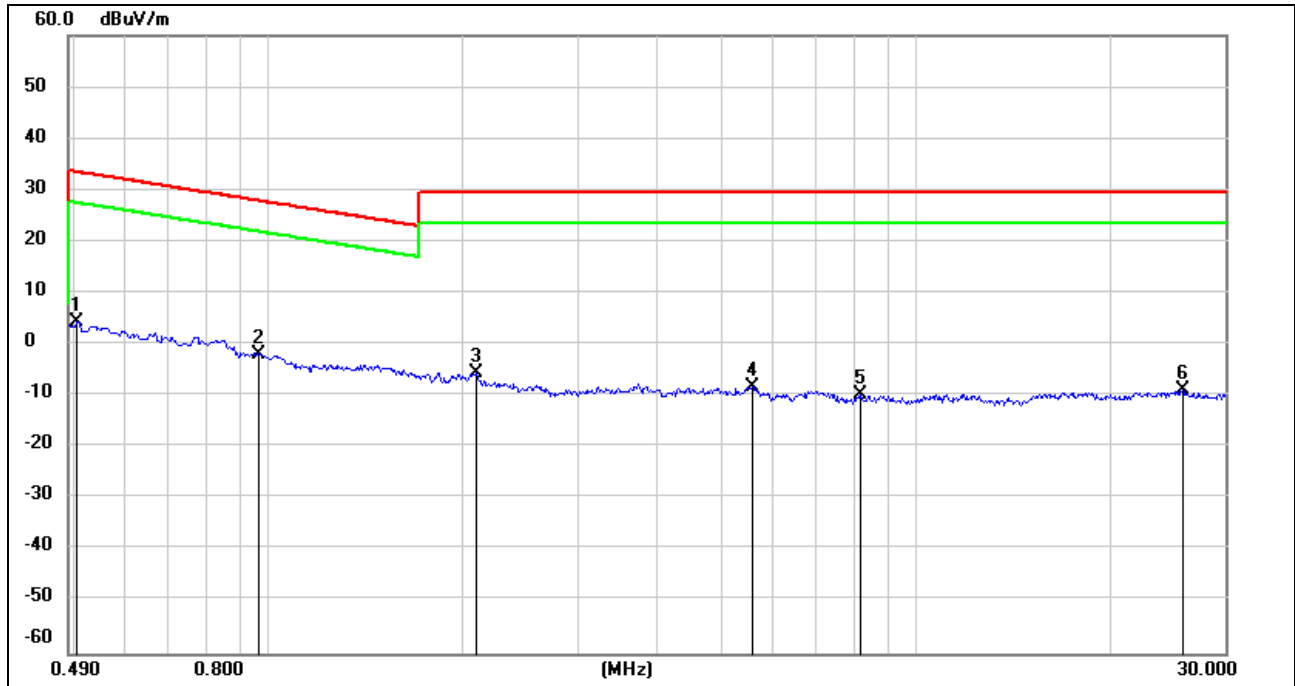

No.	Frequency (MHz)	Reading (dBuV)	Correct (dB/m)	FCC Result (dBuV/m)	FCC Limit (dBuV/m)	Margin (dB)	Remark
1	0.5039	66.44	-62.07	4.37	33.56	-29.19	peak
2	0.9657	60.39	-62.25	-1.86	27.90	-29.76	peak
3	2.0939	56.39	-61.79	-5.40	29.54	-34.94	peak
4	5.5952	53.05	-61.41	-8.36	29.54	-37.90	peak
5	8.1920	51.17	-61.05	-9.88	29.54	-39.42	peak
6	25.8094	51.41	-60.37	-8.96	29.54	-38.50	peak

- Note: 1. Measurement = Reading Level + Correct Factor.
 2. If Peak Result complies with AV and QP limit, AV and QP Result are deemed to comply with AV limit.
 3. All 3 polarizations(Horizontal, Face-on and Face-off) of the loop antenna had been tested, but only the worst data recorded in the report.

Note: All the modes have been tested, only the worst data was recorded in the report.

9. AC POWER LINE CONDUCTED EMISSIONS

LIMITS

Please refer to CFR 47 FCC §15.207 (a)

FREQUENCY (MHz)	Quasi-peak	Average
0.15 -0.5	66 - 56 *	56 - 46 *
0.50 -5.0	56.00	46.00
5.0 -30.0	60.00	50.00

TEST SETUP AND PROCEDURE

Refer to ANSI C63.10-2013 clause 6.2.

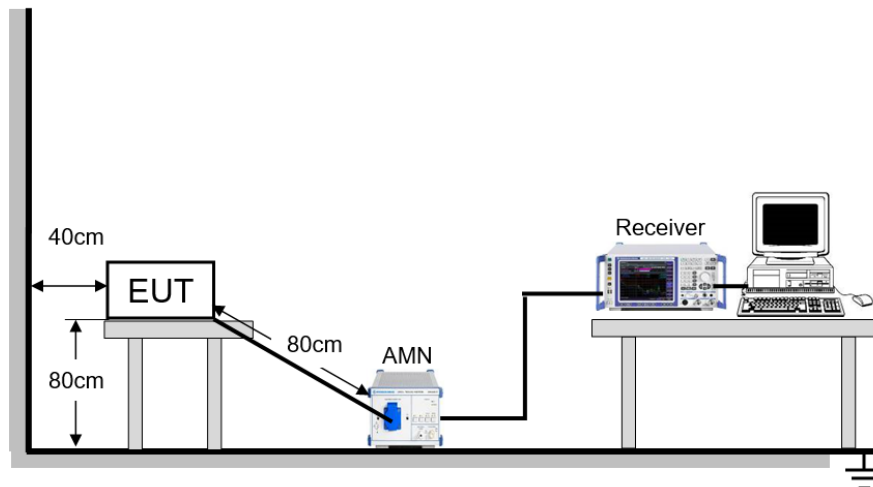

The EUT is put on a table of non-conducting material that is 80cm high. The vertical conducting wall of shielding is located 40cm to the rear of the EUT. The power line of the EUT is connected to the AC mains through a Artificial Mains Network (A.M.N.). A EMI Measurement Receiver (R&S Test Receiver ESR3) is used to test the emissions from both sides of AC line. According to the requirements in Section 6.2 of ANSI C63.10-2013. Conducted emissions from the EUT measured in the frequency range between 0.15 MHz and 30MHz using CISPR Quasi-Peak and average detector mode. The bandwidth of EMI test receiver is set at 9kHz.

The arrangement of the equipment is installed to meet the standards and operating in a manner, which tends to maximize its emission characteristics in a normal application.

TEST ENVIRONMENT

Temperature	26.4 °C	Relative Humidity	66.1%
Atmosphere Pressure	101kPa	Test Voltage	AC 120V, 60Hz

TEST RESULTS

9.1. Baby Unit

LINE L RESULTS (MID CHANNEL, WORST-CASE CONFIGURATION)

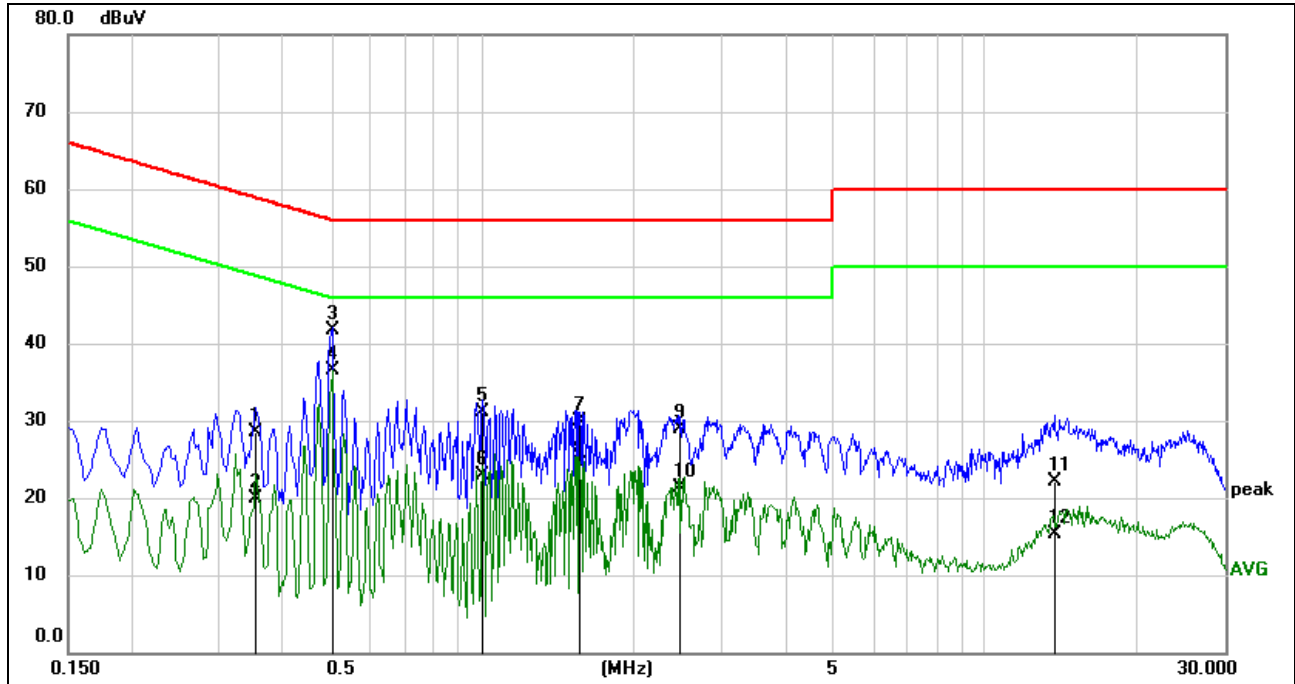

No.	Frequency (MHz)	Reading (dBuV)	Correct (dB)	Result (dBuV)	Limit (dBuV)	Margin (dB)	Remark
1	0.3530	18.82	9.60	28.42	58.89	-30.47	QP
2	0.3530	10.28	9.60	19.88	48.89	-29.01	AVG
3	0.5021	32.20	9.60	41.80	56.00	-14.20	QP
4	0.5021	26.90	9.60	36.50	46.00	-9.50	AVG
5	1.0057	21.49	9.61	31.10	56.00	-24.90	QP
6	1.0057	13.22	9.61	22.83	46.00	-23.17	AVG
7	1.5675	20.19	9.62	29.81	56.00	-26.19	QP
8	1.5675	14.65	9.62	24.27	46.00	-21.73	AVG
9	2.4876	19.20	9.63	28.83	56.00	-27.17	QP
10	2.4876	11.73	9.63	21.36	46.00	-24.64	AVG
11	13.6754	12.21	9.82	22.03	60.00	-37.97	QP
12	13.6754	5.43	9.82	15.25	50.00	-34.75	AVG

- Note: 1. Result = Reading +Correct Factor.
 2. If QP Result complies with AV limit, AV Result is deemed to comply with AV limit.
 3. Test setup: RBW: 200 Hz (9 kHz-150 kHz), 9 kHz (150 kHz-30 MHz).
 4. Step size: 80Hz (0.009MHz-0.15MHz), 4 kHz (0.15MHz-30MHz), Scan time: auto.

LINE N RESULTS (MID CHANNEL, WORST-CASE CONFIGURATION)

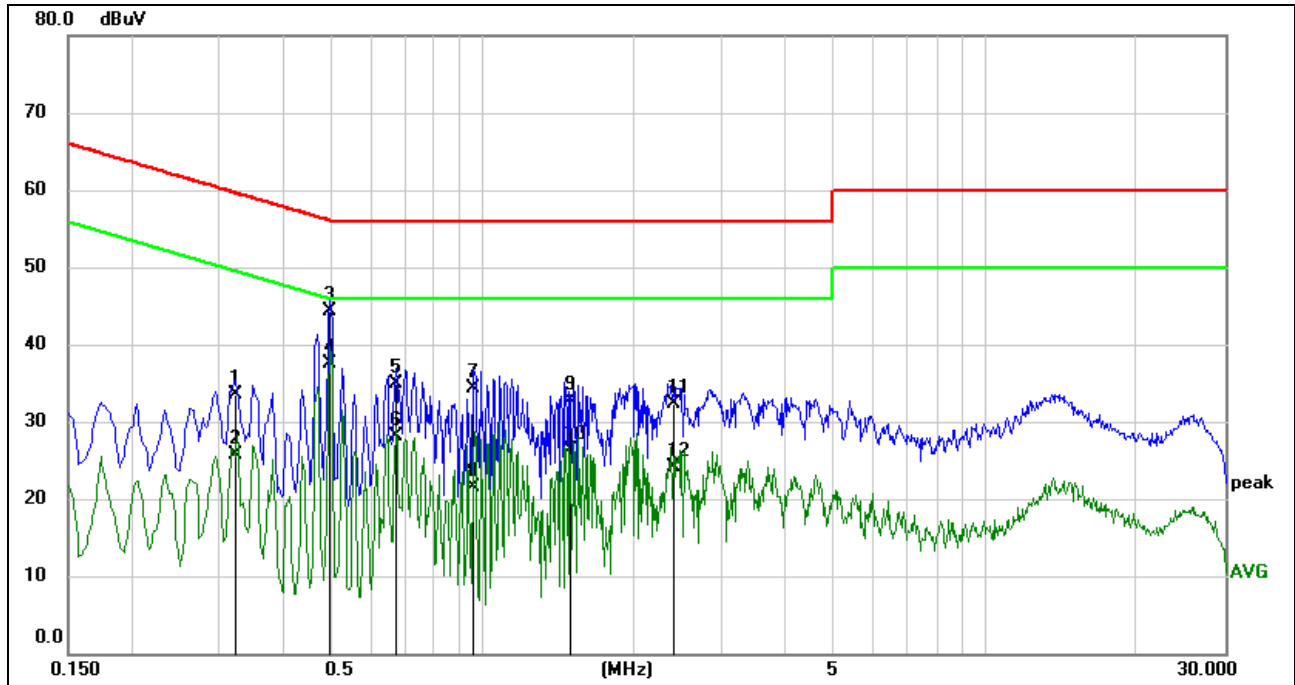

No.	Frequency (MHz)	Reading (dBuV)	Correct (dB)	Result (dBuV)	Limit (dBuV)	Margin (dB)	Remark
1	0.3237	23.86	9.60	33.46	59.61	-26.15	QP
2	0.3237	16.12	9.60	25.72	49.61	-23.89	AVG
3	0.4975	34.70	9.60	44.30	56.04	-11.74	QP
4	0.4975	27.94	9.60	37.54	46.04	-8.50	AVG
5	0.6765	25.34	9.60	34.94	56.00	-21.06	QP
6	0.6765	18.41	9.60	28.01	46.00	-17.99	AVG
7	0.9657	24.67	9.61	34.28	56.00	-21.72	QP
8	0.9657	11.83	9.61	21.44	46.00	-24.56	AVG
9	1.5008	23.16	9.62	32.78	56.00	-23.22	QP
10	1.5008	16.68	9.62	26.30	46.00	-19.70	AVG
11	2.3868	22.75	9.63	32.38	56.00	-23.62	QP
12	2.3868	14.46	9.63	24.09	46.00	-21.91	AVG

- Note: 1. Result = Reading +Correct Factor.
 2. If QP Result complies with AV limit, AV Result is deemed to comply with AV limit.
 3. Test setup: RBW: 200 Hz (9 kHz-150 kHz), 9 kHz (150 kHz-30 MHz).
 4. Step size: 80Hz (0.009MHz-0.15MHz), 4 kHz (0.15MHz-30MHz), Scan time: auto.

Note 1: All the modes have been tested, only the worst data was recorded in the report.
 Note 2: The EUT has two power adapters, both the two adapters had been tested, but only the worst data (ASSA105A-050100) was recorded in the report.



10. ANTENNA REQUIREMENTS

APPLICABLE REQUIREMENTS

Please refer to FCC §15.203

An intentional radiator shall be designed to ensure that no antenna other than that furnished by the responsible party shall be used with the device. The use of a permanently attached antenna or of an antenna that uses a unique coupling to the intentional radiator shall be considered sufficient to comply with the provisions of this section. The manufacturer may design the unit so that a broken antenna can be replaced by the user, but the use of a standard antenna jack or electrical connector is prohibited.

Please refer to FCC §15.247(b)(4)

The conducted output power limit specified in paragraph (b) of this section is based on the use of antennas with directional gains that do not exceed 6 dBi. Except as shown in paragraph (c) of this section, if transmitting antennas of directional gain greater than 6 dBi are used, the conducted output power from the intentional radiator shall be reduced below the stated values in paragraphs (b)(1), (b)(2), and (b)(3) of this section, as appropriate, by the amount in dB that the directional gain of the antenna exceeds 6 dBi.

RESULTS

Complies



APPENDIX A: DUTY CYCLE

Test Result

Mode	On Time (msec)	Period (msec)	Duty Cycle x (Linear)	Duty Cycle (%)	Duty Cycle Correction Factor (db)	1/T Minimum VBW (kHz)	Final setting For VBW (kHz)
Baby Unit	21.05	21.25	0.9906	99.06	0.04	0.05	0.01

Note:

Duty Cycle Correction Factor= $10\log(1/x)$.

Where: x is Duty Cycle (Linear)

Where: T is On Time (transmit duration)

If that calculated VBW is not available on the analyzer then the next higher value should be used.

And the duty cycle is greater than 98%, it can set VBW to 10Hz.



Test Graphs

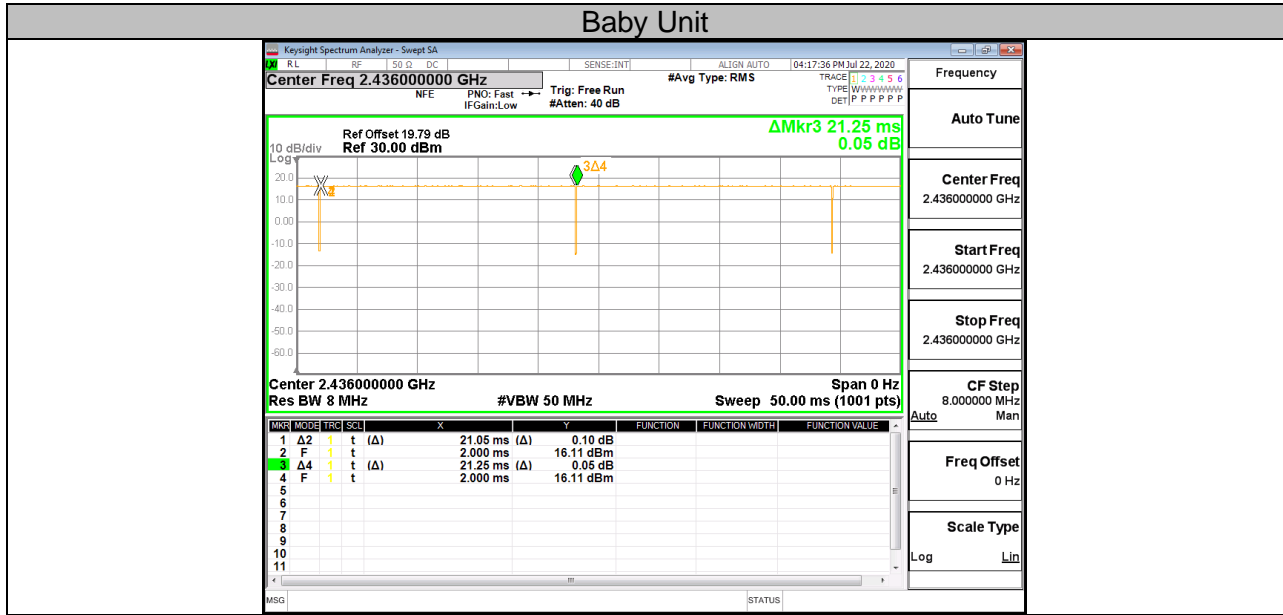



APPENDIX B: 20DB BANDWIDTH

Test Result

Test Mode	Antenna	Channel	20dB BW[MHz]	FL[MHz]	FH[MHz]	Limit[MHz]	Verdict
Baby Unit	Ant1	CH1	2.676	2404.542	2407.218	2400 to 2483.5	PASS
		CH11	2.670	2434.548	2437.218	2400 to 2483.5	PASS
		CH20	2.670	2461.542	2464.212	2400 to 2483.5	PASS



Test Graphs

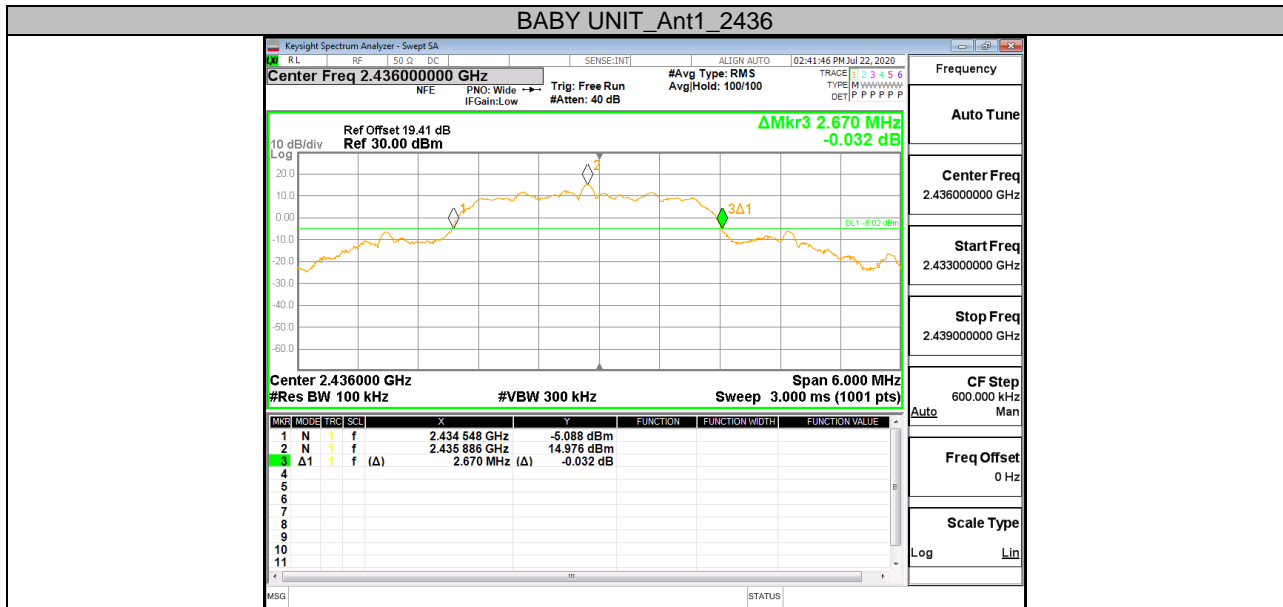
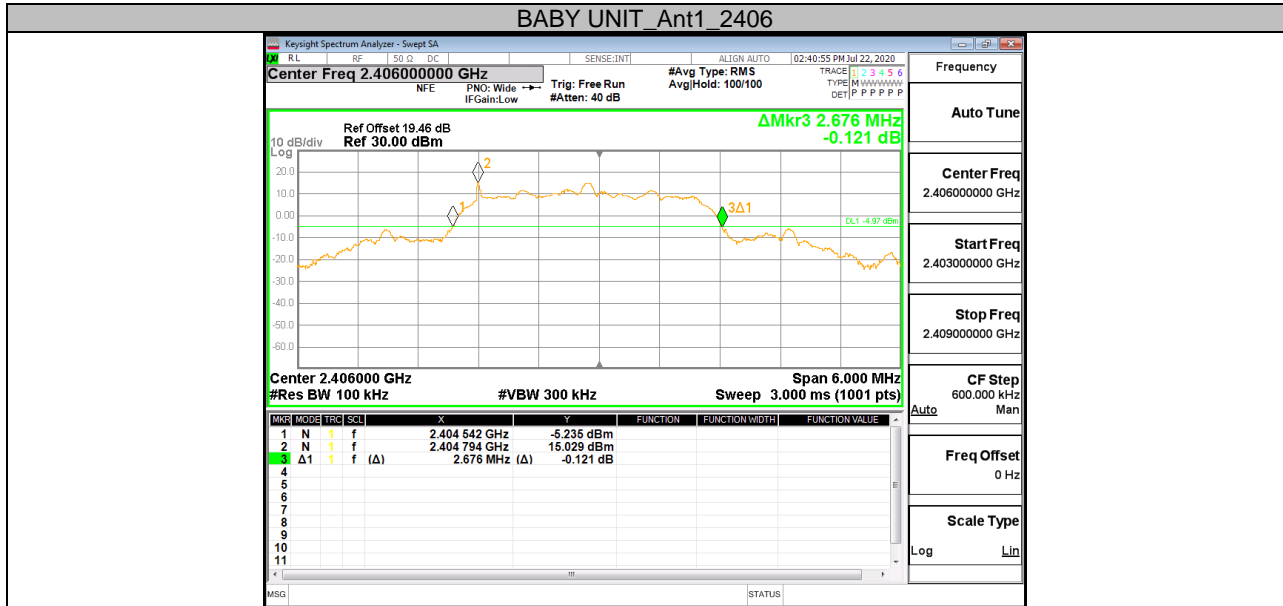

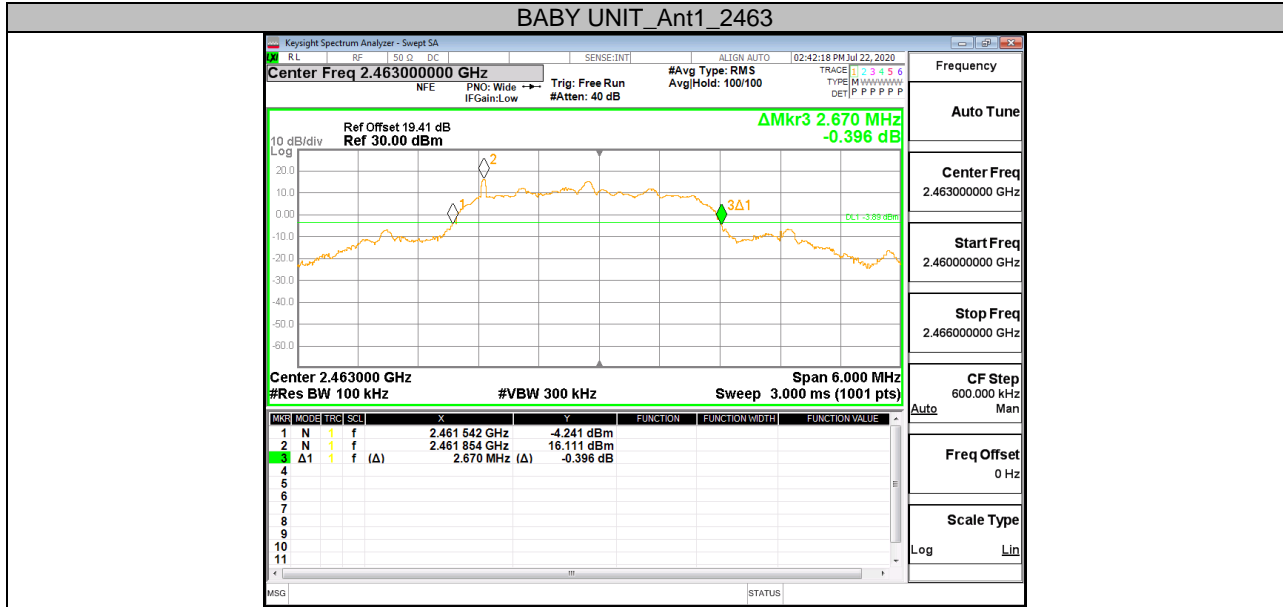

**APPENDIX C: OCCUPIED CHANNEL BANDWIDTH****Test Result**

Test Mode	Antenna	Channel	OCB [MHz]	FL[MHz]	FH[MHz]	Limit[MHz]	Verdict
Baby Unit	Ant1	CH1	2.7148	2404.520	2407.235	2400 to 2483.5	PASS
		CH11	2.7267	2434.509	2437.235	2400 to 2483.5	PASS
		CH20	2.6469	2461.542	2464.189	2400 to 2483.5	PASS



Test Graphs

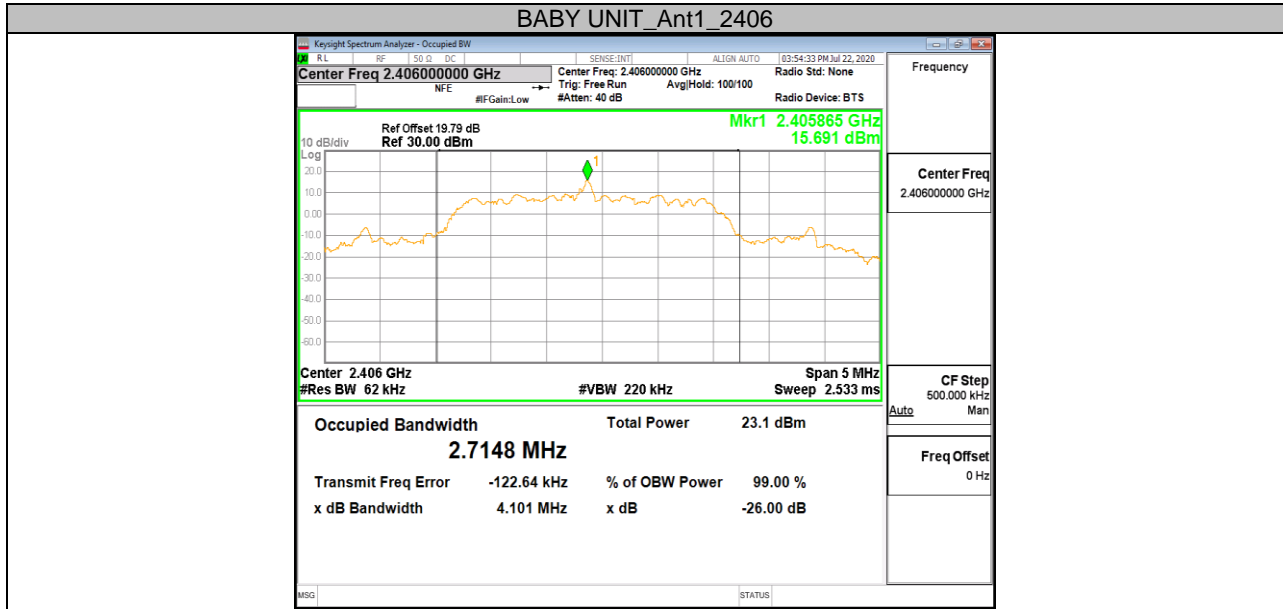

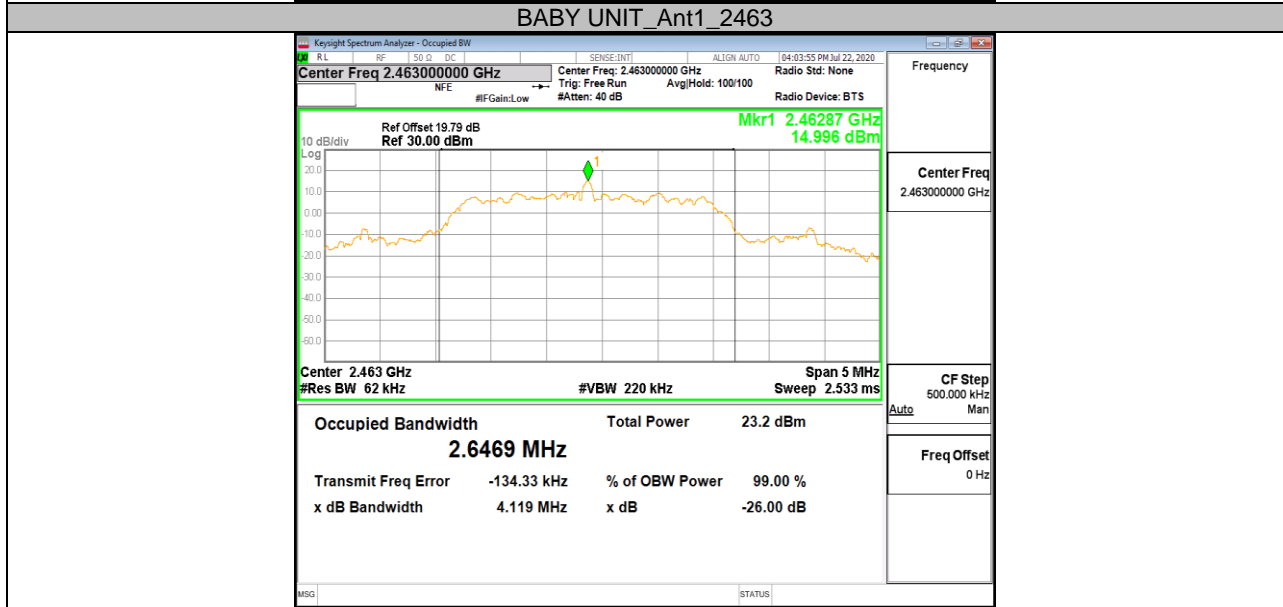
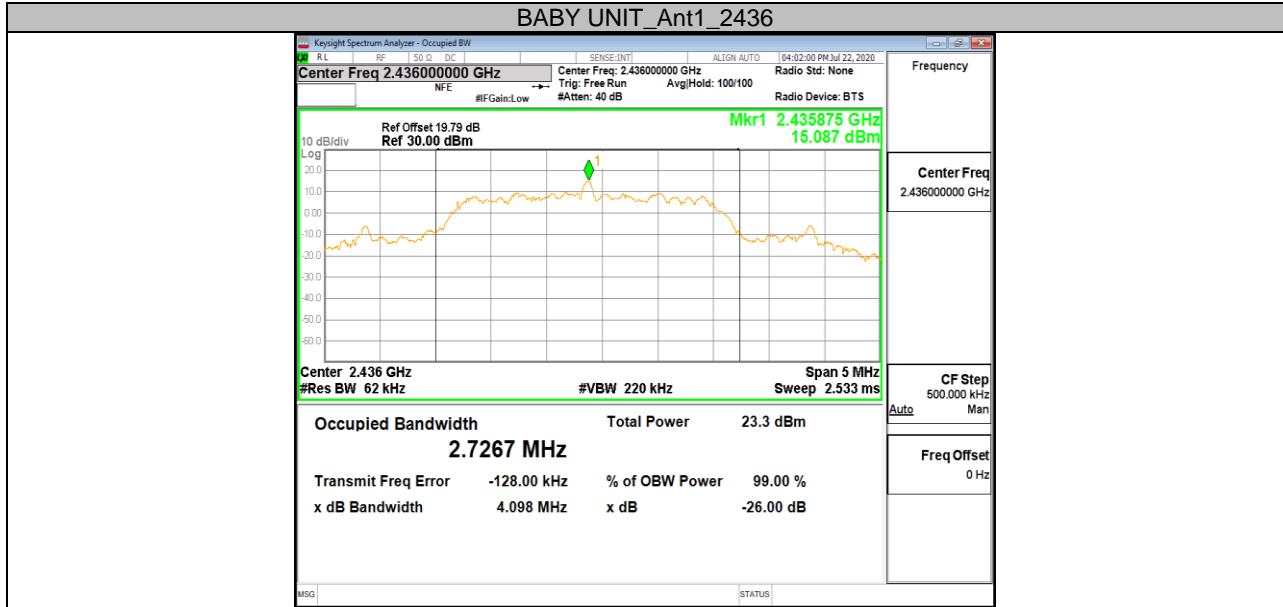



APPENDIX D: PEAK CONDUCTED OUTPUT POWER

Test Result

Test Mode	Antenna	Channel	Result[dBm]	Limit[dBm]	Verdict
Baby Unit	Ant1	CH1	18.28	<=30	PASS
		CH11	18.36	<=30	PASS
		CH20	18.14	<=30	PASS



APPENDIX E: CARRIER FREQUENCY SEPARATION

Test Result

Test Mode	Antenna	Channel	Result[MHz]	Limit[MHz]	Verdict
Baby Unit	Ant1	Hop	3.038	>=2.676	PASS

Test Graphs

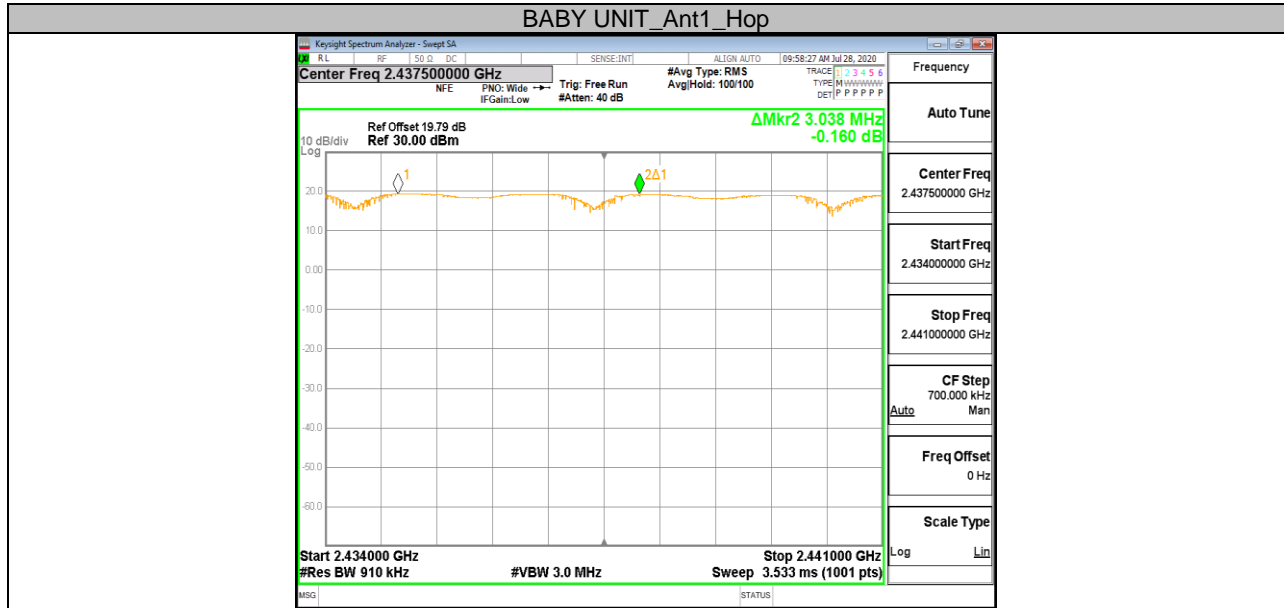



APPENDIX F: NUMBER OF HOPPING FREQUENCIES

Test Result

Test Mode	Antenna	Channel	Result[Num]	Limit[Num]	Verdict
Baby Unit	Ant1	Hop	20	>=15	PASS

Test Graphs

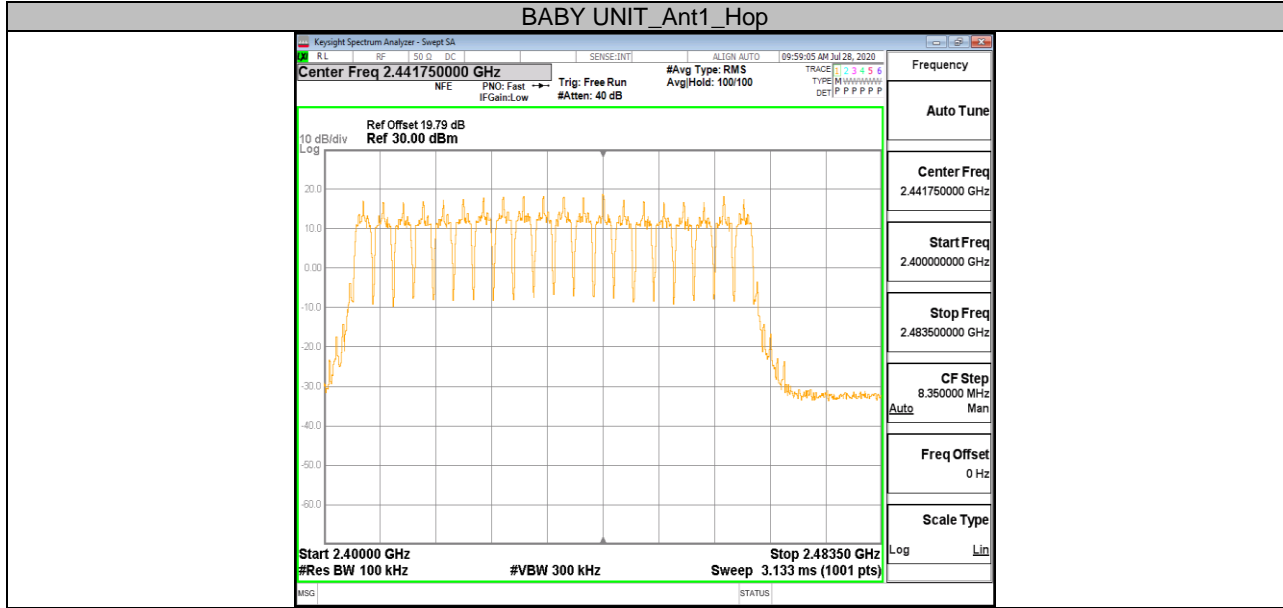



APPENDIX G: TIME OF OCCUPANCY (DWELL TIME)

Test Result

Test Mode	Antenna	Channel	Burst Width [ms]	TotalHops [Num]	Result[s]	Limit[s]	Verdict
Baby Unit	Ant1	Hop	21.02	19	0.399	<=0.4	PASS



Test Graphs

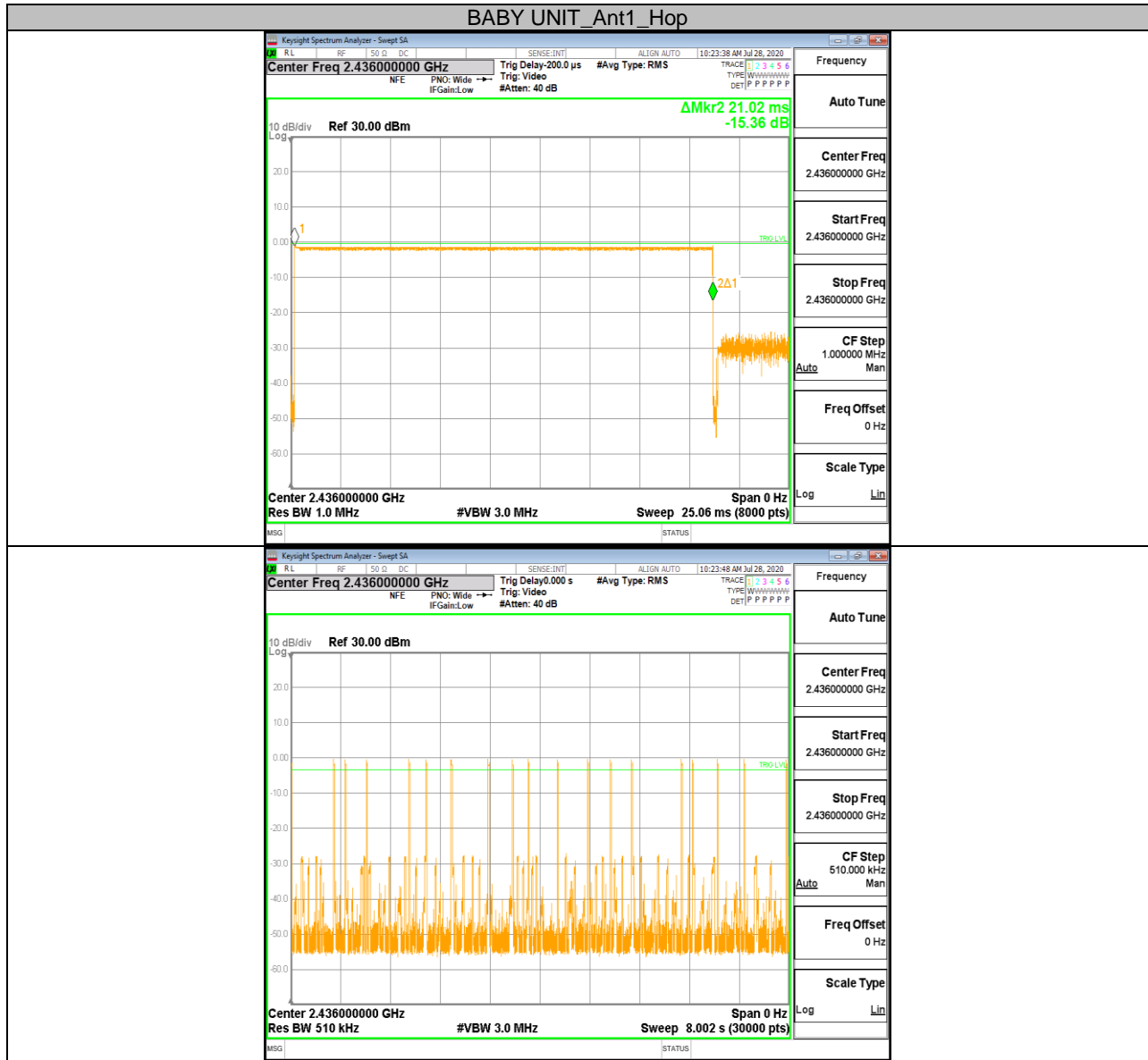



APPENDIX H: BAND EDGE MEASUREMENTS

Test Result

TestMode	Antenna	ChName	Channel	RefLevel [dBm]	Result [dBm]	Limit [dBm]	Verdict
BABY UNIT	Ant1	Low	2406	14.81	-28.55	<=-5.19	PASS
		High	2463	16.21	-40.03	<=-3.79	PASS
		Low	Hop-2406	16.90	-31.4	<=-3.11	PASS
		High	Hop-2463	17.23	-29.79	<=-2.77	PASS

Test Graphs



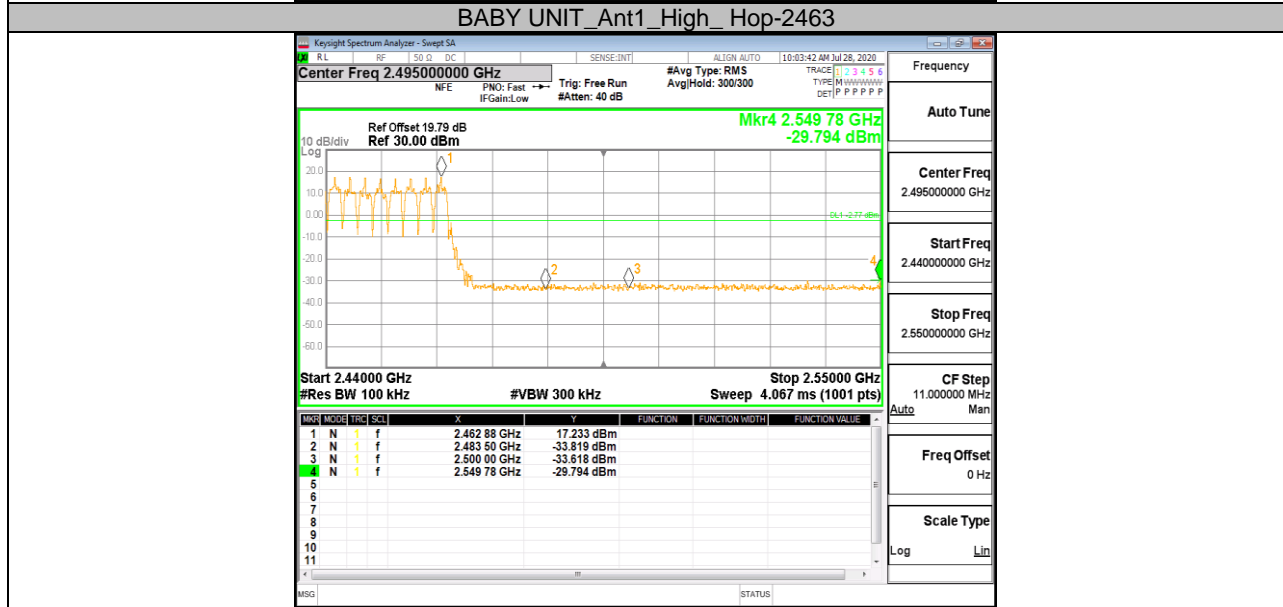
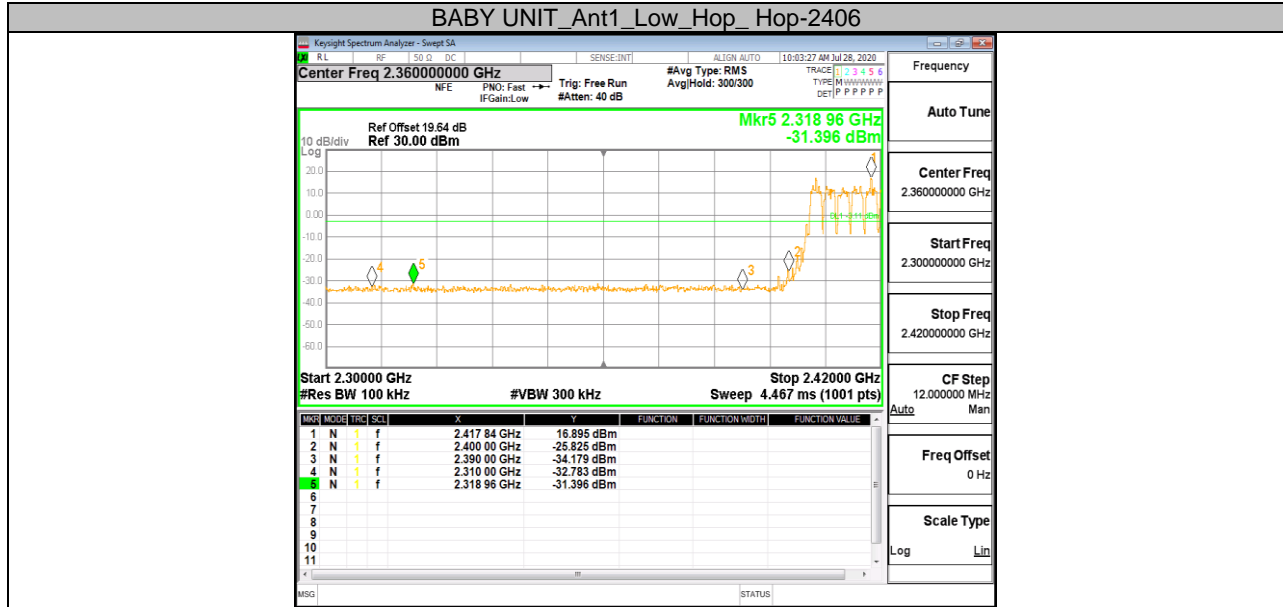

**APPENDIX I: CONDUCTED SPURIOUS EMISSION****Test Result**

TestMode	Antenna	Channel	FreqRange [MHz]	RefLevel [dBm]	Result [dBm]	Limit [dBm]	Verdict
BABY UNIT	Ant1	2406	Reference	15.550	15.550	---	PASS
			30~1000	30~1000	-63.536	<=-4.45	PASS
			1000~26500	1000~26500	-47.348	<=-4.45	PASS
		2436	Reference	15.605	15.605	---	PASS
			30~1000	30~1000	-62.703	<=-4.39	PASS
			1000~26500	1000~26500	-45.323	<=-4.39	PASS
		2463	Reference	16.253	16.253	---	PASS
			30~1000	30~1000	-63.053	<=-3.75	PASS
			1000~26500	1000~26500	-47.485	<=-3.75	PASS



Test Graphs



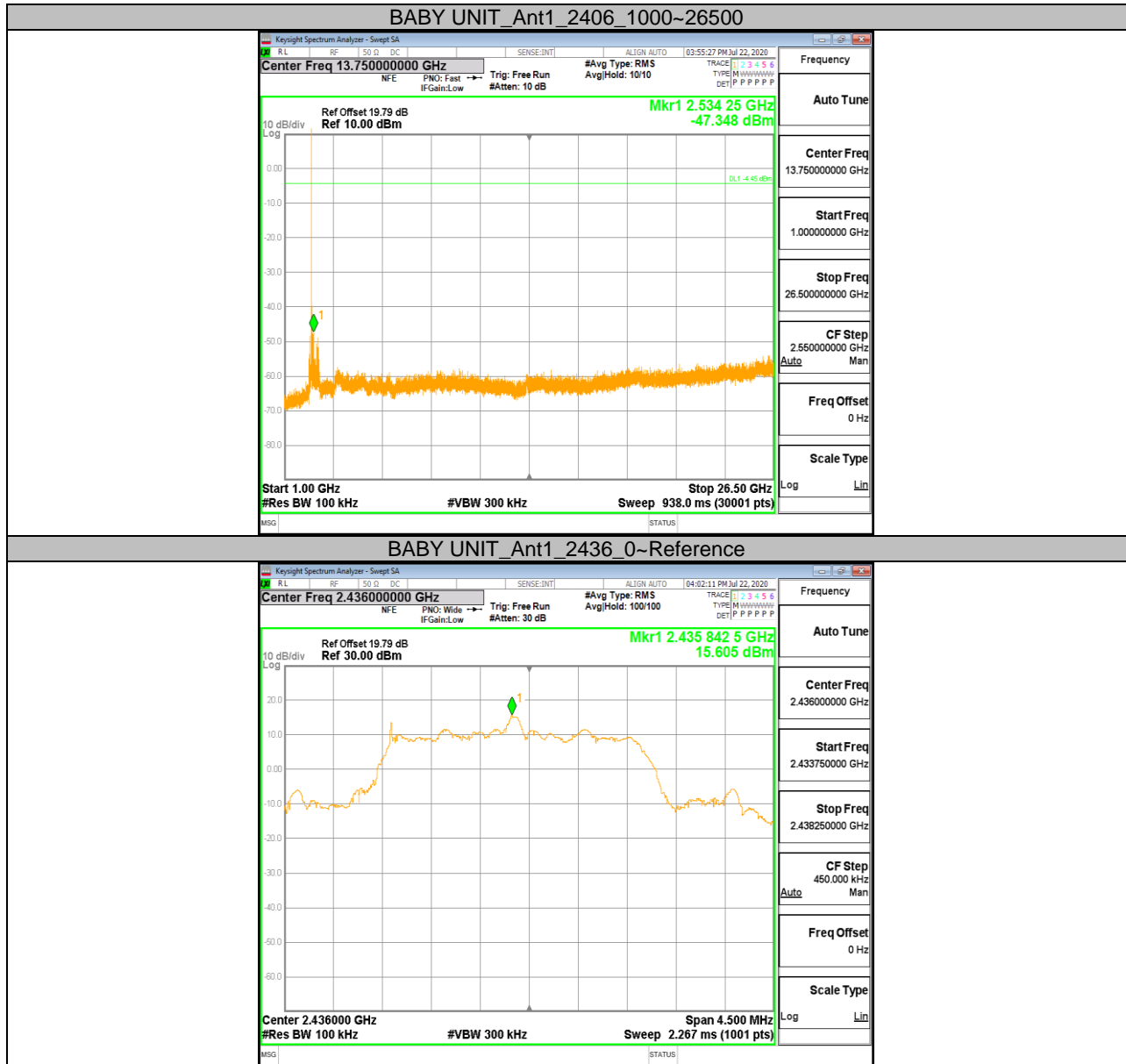

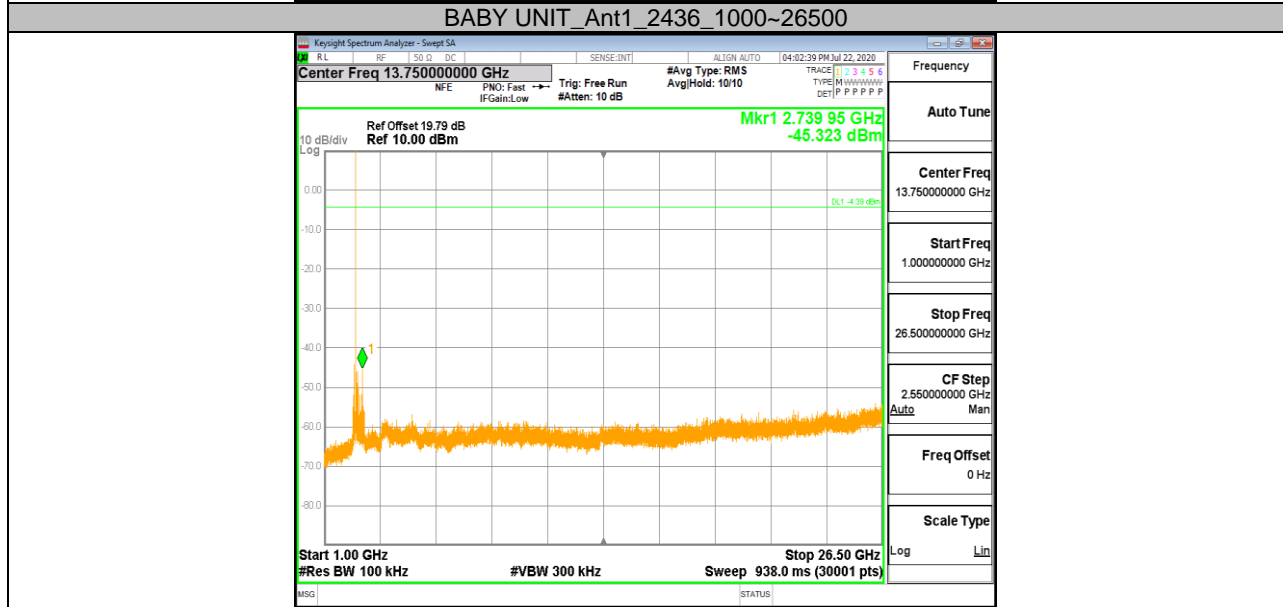
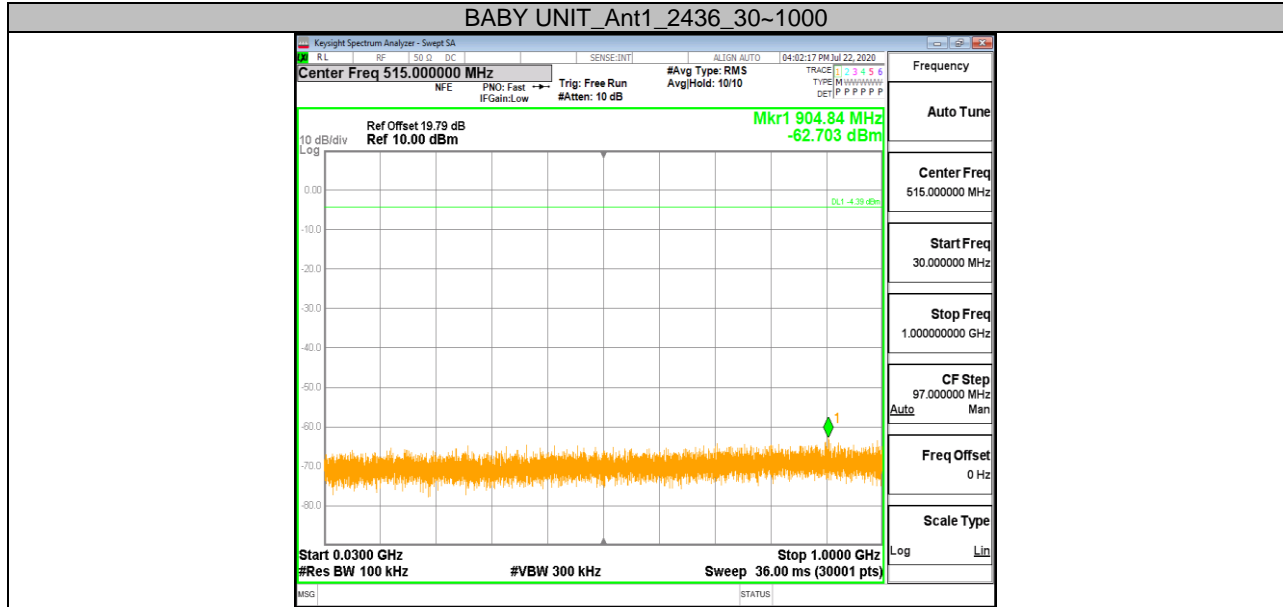

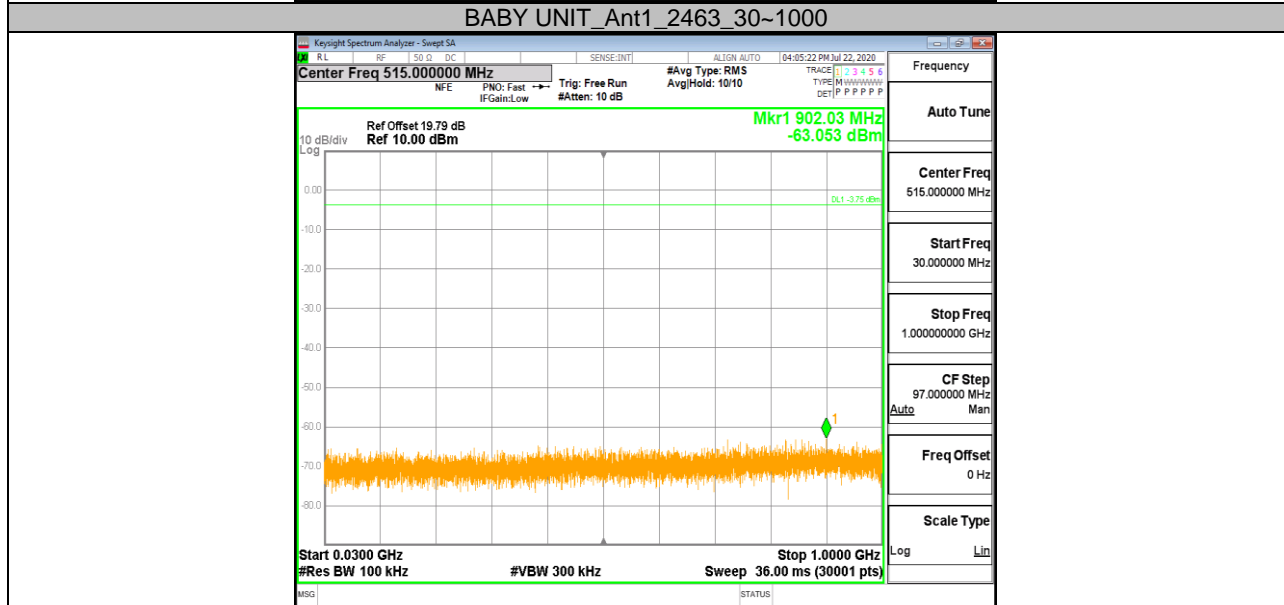
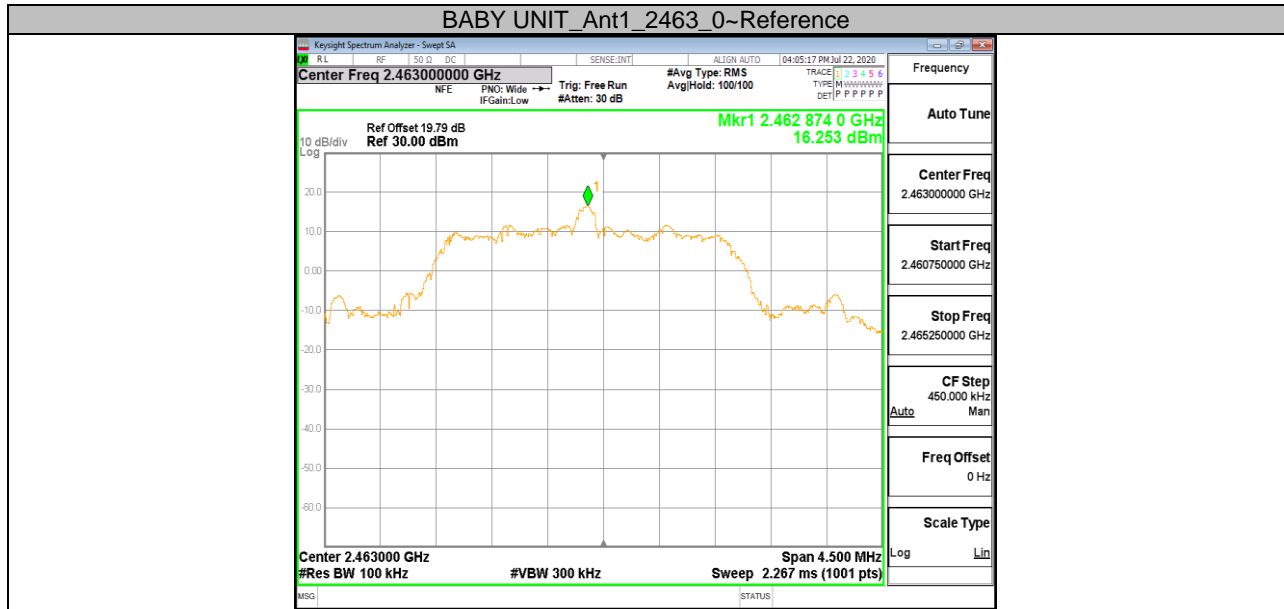

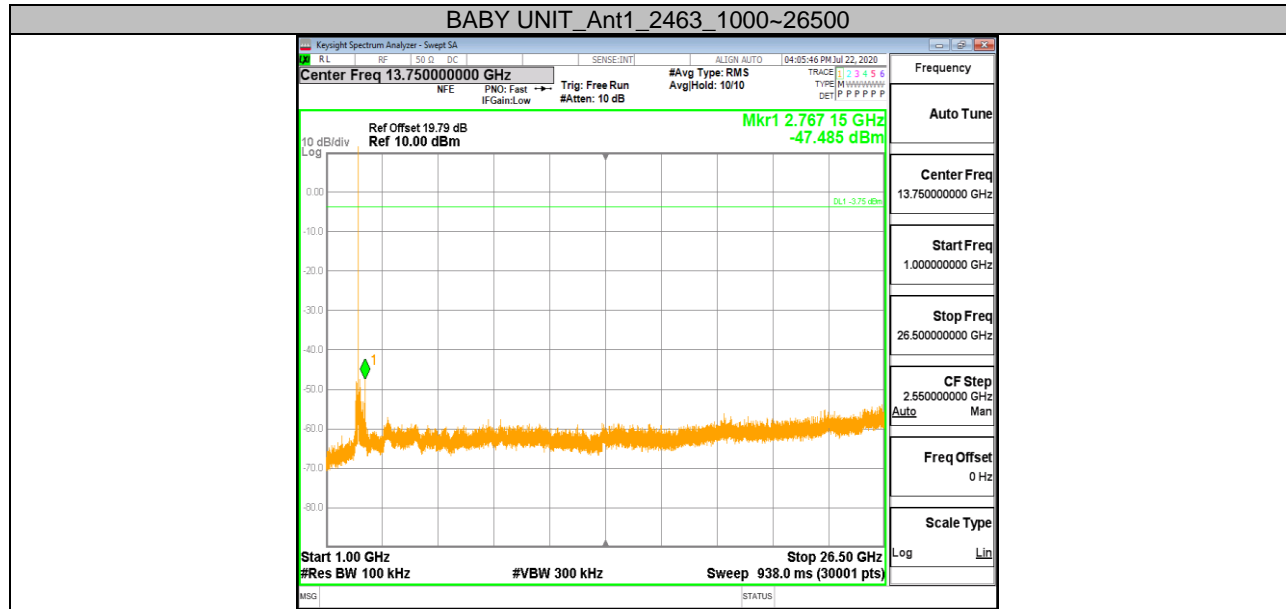

END OF REPORT