

For Services and Support

	TEL	86-755-21612590 1-833-629-4832 (NORTH AMERICA) 34-930-038094 (EUROPE)
	EMAIL	SUPPORT@TOPDON.COM
	WEBSITE	WWW.TOPDON.COM
	FACEBOOK	@TOPDONOFFICIAL
	X	@TOPDONOFFICIAL



RoHS



TOPDON®



ArtiDiag HY

Professional Diagnostic Tool

USER MANUAL

CONTENTS

Welcome.....	1
About.....	1
What's Included.....	1
Compatibility.....	1
Technical Specification.....	2
Notice.....	2
General Information of OBD II.....	3
Diagnostic Trouble Codes (DTCs).....	3
Product Overview.....	4
Preparation & Connection.....	5
Operation Introduction.....	9
Warnings.....	24
Cautions.....	24
FAQ.....	25
Warranty.....	26

WELCOME

Thank you for purchasing the Product, an automotive diagnostic tool. Please read manual prior to operation.

ABOUT

The Product is an ideal diagnostic tablet designed to work on all available electronic systems. Beyond OBD II diagnostics, the user can expect AutoVIN technology to accelerate diagnostic work, without needing to executing menu-driven commands step by step.

WHAT'S INCLUDED

1. Product
2. Diagnostic Cable
3. Charging Cable
4. Carrying Case
5. Quick User Guide
6. User Manual

COMPATIBILITY

Product is compatible with the following:

- KWP2000
- ISO9141
- J1850 VPW
- J1850 PWM
- CAN (Controller Area Network)
- And more

TECHNICAL SPECIFICATION

Display: 4-inch 800*480 Touchable Screen

RAM: 2G

ROM: 32GB

OBD II Input Voltage Range: 9~18V

Charging: Type-C charging port, or through connection to vehicle's DLC

Working Temperature: 32°F to 113°F (0°C to 45°C)

Storage Temperature: -4°F to 158°F (-20°C to 70°C)

NOTICE

Product may automatically reset while being disturbed by strong static electricity. THIS IS A NORMAL REACTION.

This User Manual is subject to change without written notice.

Read the instructions carefully and use the unit properly. Failure to do so may cause damage and/or personal injury, which will void the product warranty.

GENERAL INFORMATION OF OBD II

The OBD II system is designed to monitor emission control systems and key engine components by performing either continuous or periodic tests of specific components and vehicle conditions, which will relay the following information:

- Whether the Malfunction Indicator Light (MIL) is commanded “on” or “off”;
- Which, if any, Diagnostic Trouble Codes (DTCs) are stored;
- Readiness Monitor status.

DIAGNOSTIC TROUBLE CODES (DTCs)

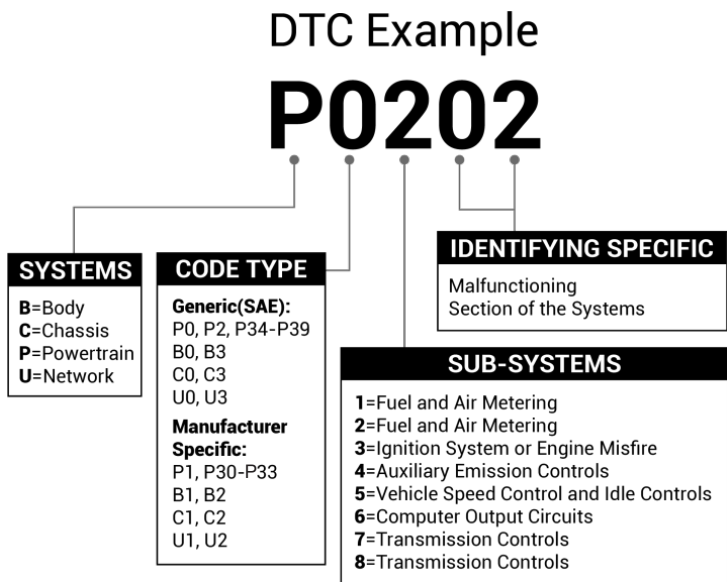

PRODUCT OVERVIEW

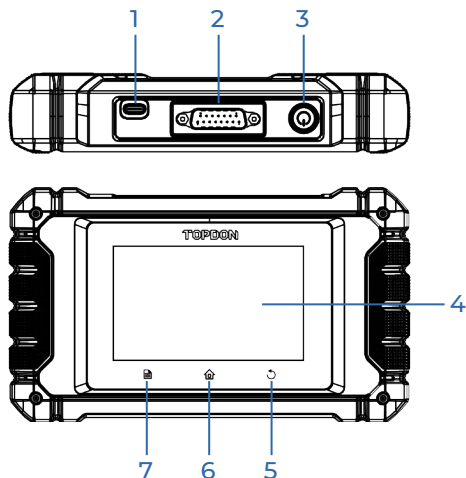

NO.	Name	Descriptions
1	Charging Port	To charge the tablet.
2	DB-15 Diagnostic Connector	To connect to the diagnostic cable.
3	Power/Screen Lock Button	<ul style="list-style-type: none"> • Hold the button for 3 seconds to turn the tablet on or off. • Hold the button for 8 seconds for a forced shutdown.
4	Touch Screen	Show test results.
5	Return Button	Back to previous screen.
6	Home Button	Navigate to the Home screen.
7	Settings Button	A quick dial to the Settings function.

PREPARATION & CONNECTION

1. Turn the ignition off.

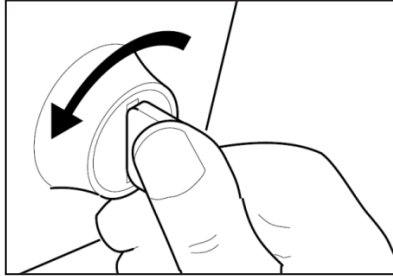

2. Locate the vehicle's DLC socket.

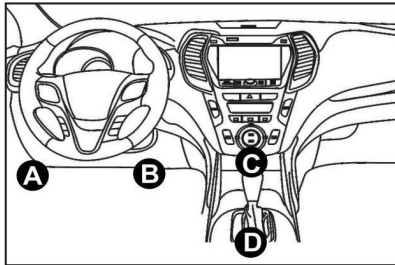

3. Connect one end of the diagnostic cable to the DB-15 port on the Product and tighten the captive screws.
4. Plug the adaptor to vehicle's DLC connector.
5. Turn the ignition on. The engine can be off or running.
6. Hold the power button for 3 seconds to turn the Product on. The tablet will start initializing and enter the welcome interface.

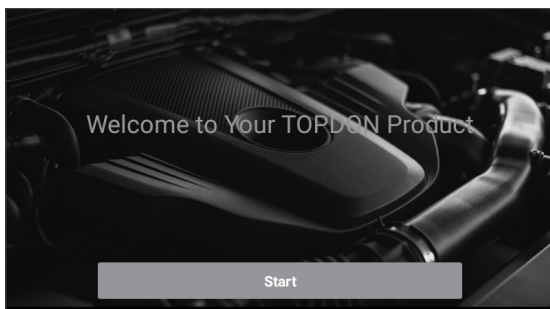

*Note: Don't connect or disconnect any test equipment with the ignition on or engine running.

7. Language Setting

Select the tool language in the following interface:

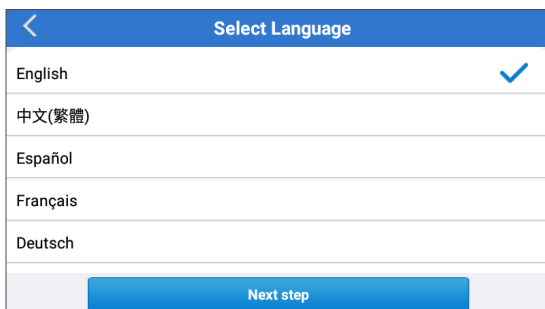

8. Choose Time Zone

Choose the time zone of your current location. The system will automatically configure the time according to the time zone you selected.

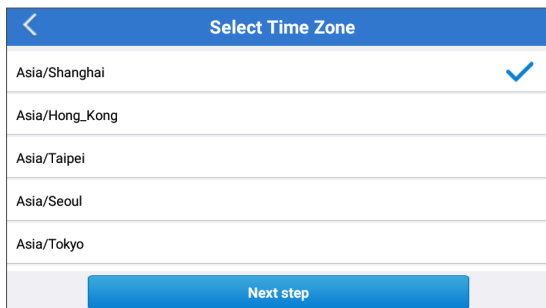

9. Connect Wi-Fi

The system will automatically search for all available Wi-Fi networks. You can choose the Wi-Fi needed.

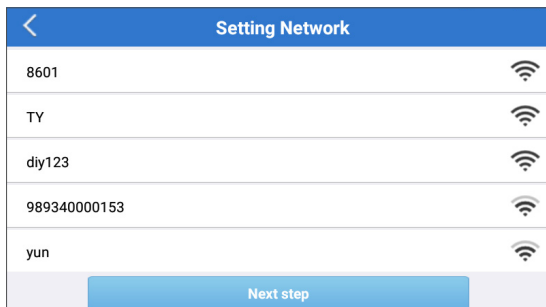

*Note: Upon first use, the tablet requires data interaction with the server for activation, necessitating Wi-Fi connectivity. Without this initial activation, the diagnostic software will not be accessible. However, once activated, the diagnostic function can be utilized offline.

10. Enter workshop information

Here you can configure workshop information and an email address (as the recipient by default when sharing reports or screenshots). After entering the email address, tap "Obtain Verification Code" to verify its validity.

11. User Agreement

Please read all the terms and conditions of the user agreement carefully. Check “Agree to all the above terms” and tap “Next” to complete the registration process.

It will automatically jump to the Home Menu.

OPERATION INTRODUCTION

Product has 5 major modules, including Diagnostics, OBD II, Upgrade, Feedback and Settings.

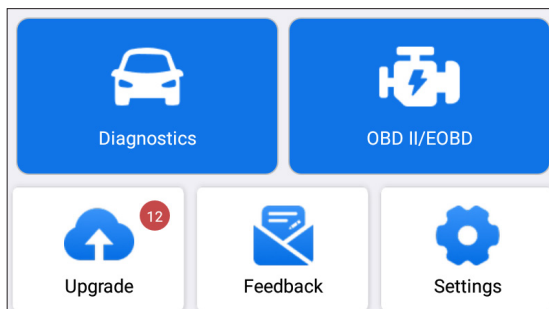

1. Diagnostics

Product supports Smart Diagnosis and Manual Diagnosis covering full system diagnosis.

A diagnostic report will be automatically generated after the diagnosis.

1.1 Smart Diagnosis (Auto-Detect)

Power on the Product. Tap "Settings", and make sure the "Automatic detection on connect" is on.

*Note: Alternatively, the user can also tap "Diagnostics" -> "AutoDetect" to start the smart diagnosis manually if the "Automatic detection on connect" is Off.

Connect to the DLC's port, and then turn the ignition key on. The Product will enter the Smart Diagnosis mode automatically.

*Note: If the automatic detection can not identify the vehicle, please try to connect to the network. Not all cars support the AutoDetect function due to auto manufacturers' settings.

1.1.1 Once the system successfully obtains the VIN (Vehicle Identification Number), it will continue scanning the vehicle systems. A diagnostic report will be automatically generated after the scanning is completed.

1.1.2 If the tablet fails to access the VIN information, the screen will display as follows:



Input the VIN and tap “OK”; the system will automatically identify the vehicle model.

If the VIN is successfully decoded, it will perform Smart Diagnosis until a diagnostic report is automatically generated. Otherwise it will enter the Manual Diagnosis mode.

*Note:

- A highly stable and solid network connection is recommended for successful VIN access.
- VIN characters may be capital letters A through Z and numbers 0 through 9; however, the letters I, O and Q would never be used in order to avoid misreading. No signs or spaces are allowed in the VIN.

1.2 Manual Diagnosis

If the tablet cannot obtain or analyze the VIN information, you can also perform Manual Diagnosis. In this mode, you need to execute the menu-driven command and follow the on-screen instruction to proceed.

Refer to the flowchart illustrated below to run the manual system diagnostics.

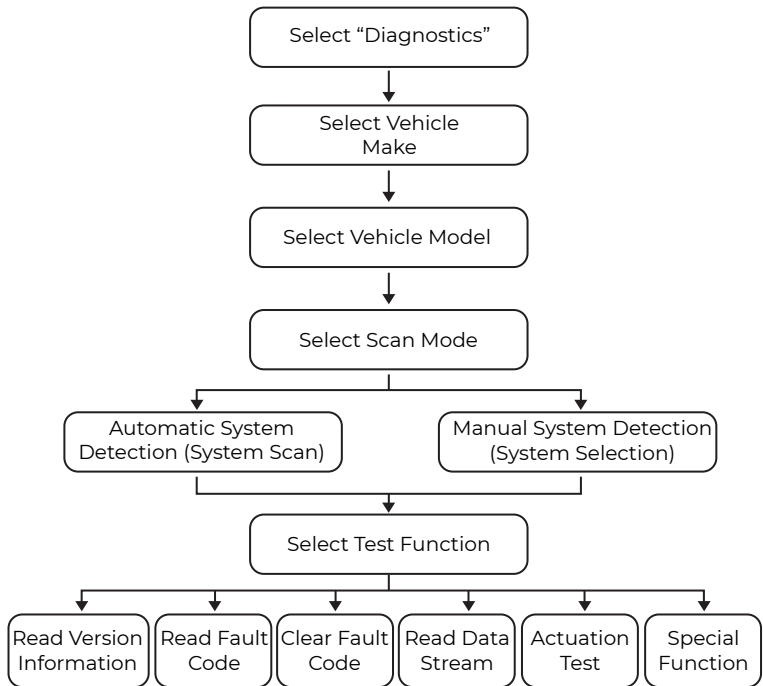

***Note:**

- Before diagnosing, please make sure the corresponding vehicle manufacturer software has been installed in the tablet.
- The diagnostic menu may vary by the vehicle's make, model, and year.

Take “Demo V15.55” as an example to demonstrate how to manually diagnose a vehicle.

Tap “OK” to continue.

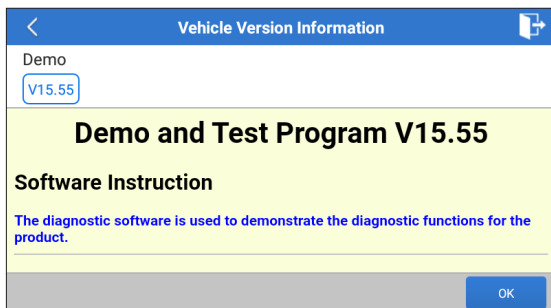

Select desired vehicle make and model to enter the following screen.

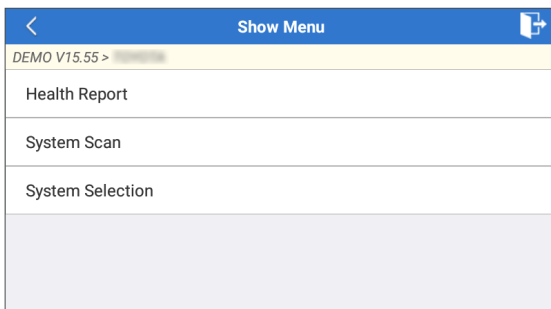

1.2.1 Health Report (Quick Test)

This function enables you to quickly access all electronic control units of the vehicle and generate a detailed report about vehicle health.

Tap “Health Report”, and the system will start scanning the ECUs.

Once the scanning is complete, the following screen will appear:

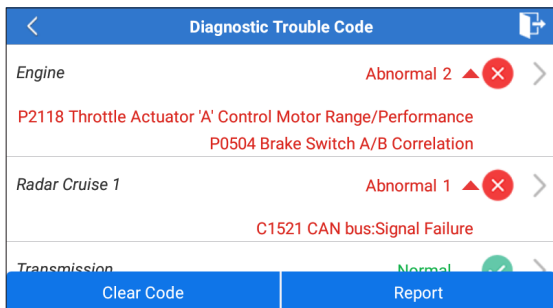

The system with fault codes will be displayed in red (❌). The system with no fault codes will be displayed in green (✅).

*Explanation of terms:

- Tap ▼ to display the details of DTCs existing in the current system. Tap ▲ to hide it.
- >: To select other test functions.
- Report: To save the diagnostic result as a report.
- Clear Code: To clear the existing diagnostic trouble codes.

1.2.2 System Scan (Automatic System Detection)

This function will scan the vehicle test system automatically. Tap “System Scan”. The following screen will appear:

Select Test Item	
DEMO V15.55 > > System Scan	
System Name	Result
Engine	Equipped
Transmission	Equipped
ABS/VSC/TRAC/EPB	Equipped
SRS Airbag	Equipped
Main Body	Equipped

1.2.3 System Selection (Manual System Detection)

This function allows you manually select the system and perform the related diagnostic functions.

Tap “System Selection”, and then select the desired system (take

“ENGINE” for example). The following screen will appear:

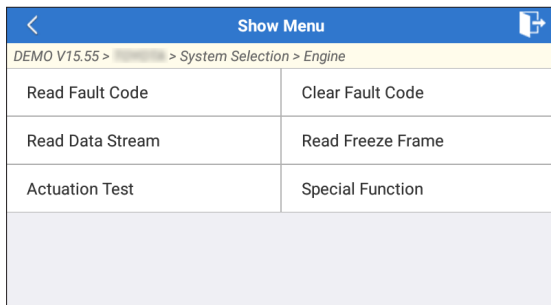

a. Read Fault Code

This function displays the detailed information of DTC records retrieved from the vehicle's control system.

The following screen will appear:

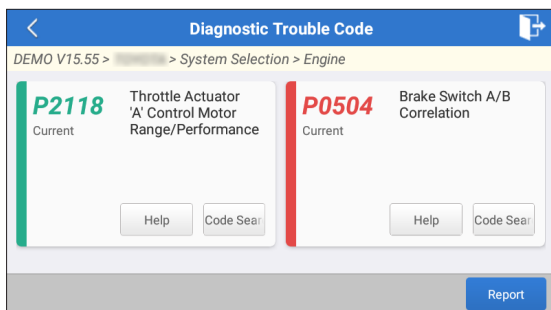

*Explanation of terms:

- Help: To view the help information.
- Code Search: To search for more information about the current DTC online.
- Report: To save the current data in text format. All diagnostic reports can be accessed from “Settings” -> “Data” -> “Diagnostic Report”.

b. Clear Fault Code

This function can erase the codes from the vehicle. Please make sure the vehicle's ignition key is in the ON position with the engine off before the operation.

c. Read Data Stream

This option retrieves and displays live data and parameters from the vehicle's ECU.

The following screen will appear:

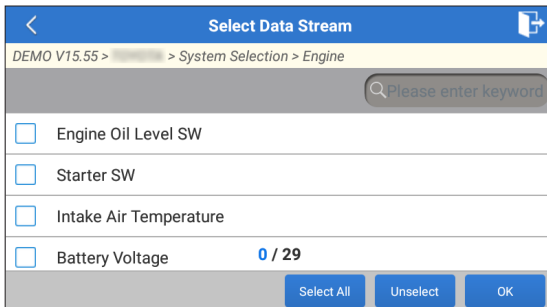

After selecting the desired items, tap “OK” to enter the data stream reading page.

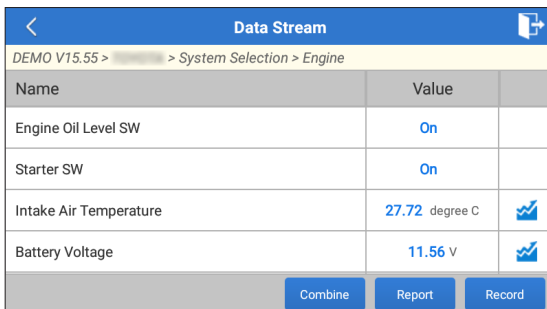

The system will display the selected data streams in 3 modes available:

- 1) Value (default): Shows parameters with numbers and lists.
- 2) Figure: Displays parameters with wave patterns.
- 3) Combine: The graphs can be merged for easier comparisons.

Tap to view the parameters in wave patterns:

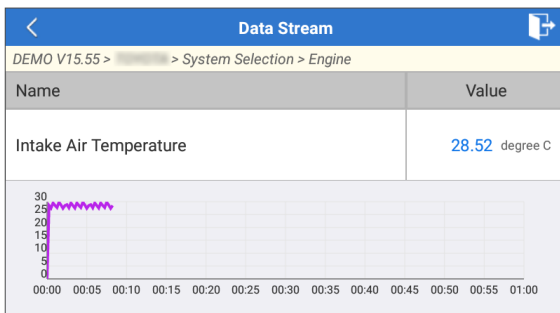

Tap "Combine" to merge values in waveform for easier comparisons. Maximum 4 values can be selected at the same time.

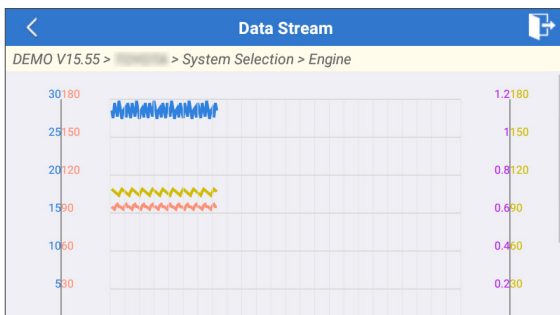

Tap "Report" to save the current data as a diagnostic report or share it with others. All diagnostic reports can be accessed from "Settings" -> "Data" -> "Diagnostic Report".

Tap "Record" to record and save the Live Data as valuable information to help troubleshoot and diagnose. All diagnostic records can be accessed from "Settings" -> "Data" -> "Diagnostic Record".

d. Read Freeze Frame

This option takes the snapshot of the operating conditions when a vehicle fault occurs.

e. Actuation Test

This option is used to access vehicle-specific subsystem and component tests. Available tests vary by vehicle manufacturer, year, and model.

During the actuation test, the display tablet outputs commands to the ECU in order to drive the actuators, and then determines the integrity of the system or parts by reading the ECU data, or by monitoring the operation of the actuators, such as switching an injector between two operating states.

The following screen will appear:

Show Menu	
DEMO V15.55 > System Selection > Engine	
EGR Test	ETCS(TAC) Test
A/C Clutch	Fuel Pump Off

Simply follow the on-screen instructions and make appropriate selections to complete the test.

Each time when an operation is successfully executed, "Completed" will display.

f. Special Functions

This option offers coding, reset, relearn, and more service functions, to help vehicles get back to functional status after repair or replacement. Available tests vary by vehicle manufacturer, year, and model.

Show Menu	
DEMO V15.55 > System Selection > Engine	
Injector Rate Adjustment	Learning Valvetronic Limit Positions
Register Battery Replacement	Fuel Consumption Display
Idle Speed Adjustment	Valvetronic Running-In Phase

1.3 Diagnostic History

The tablet will record every details of a diagnostic session.

The History function provides direct access to the previously tested vehicles. You can resume from the last operation without the necessity of starting from scratch.

Tap "History" in the "Diagnostics" module. All diagnostic records will be listed on the screen in a date sequence.

2. OBD II

This function presents a quick way to check for DTCs, isolate the cause of the illuminated Malfunction Indicator Lamp (MIL), check monitor status before emissions certification testing, verify repairs, and perform other services that are emission-related.

Tap "OBD II" in the Home Menu after the tablet is properly connected to the vehicle's DLC port. The tablet will start an automatic check of the vehicle's computer to determine which type of communication protocol it is using, then display the Monitor Status as follows:

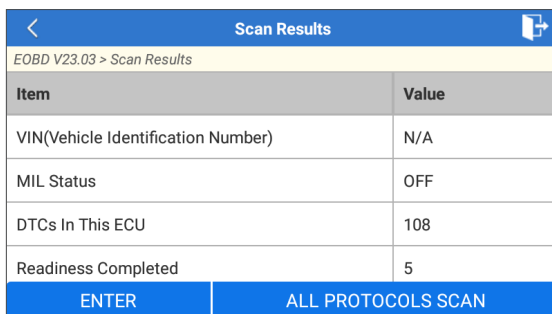

Scan Results	
<i>EOBD V23.03 > Scan Results</i>	
Item	Value
VIN(Vehicle Identification Number)	N/A
MIL Status	OFF
DTCs In This ECU	108
Readiness Completed	5

ENTER ALL PROTOCOLS SCAN

Tap "OK", the following OBD II function list appears.

Show Menu	
<i>EOBD V23.03 > Select DIAG. Function</i>	
Read I/M Readiness (Mode \$01)	Read Live Data (Mode \$01)
Read Freeze Frame (Mode \$02)	Read Fault Code (Mode \$03/\$07/\$0A)
Clear Fault Code (Mode \$04)	Test Results: On-Board Monitoring Test (Mode \$06)
Control Operation Of On-Board Component/System (Mode \$08)	Read Vehicle Information (Mode \$09)
EU OBFCM	

2.1 Read I/M Readiness

This function checks whether or not the various emissions-related systems on the vehicle are operating properly, and are ready for Inspection and Maintenance testing.

It can also be used to check the Monitor Run Status, and to confirm if the repair of a car fault has been performed correctly.

2.2 Read Live Data

This function retrieves and displays live data and parameters from the vehicle's ECU.

2.3 Read Freeze Frame

This function takes the snapshot of the operating conditions when an emission-related fault occurs.

2.4 Read Fault Code

This function can identify which section of the emission control system has malfunctioned.

2.5 Clear Fault Code

This function erases the codes from the vehicle, after retrieving codes from the vehicle and certain repairs have been carried out.

Make sure the vehicle's ignition key is in the ON position with the engine off before the operation.

2.6 Test Results: On-Board Monitoring Test

This function retrieves test results for emission-related powertrain components and systems that are not continuously monitored. The test's availability is determined by the vehicle manufacturer.

2.7 Control Operation of On-Board Component/System

This option is used to access vehicle-specific subsystem and component tests. Available tests vary by vehicle manufacturer, year, and model.

2.8 Read Vehicle Information

This function retrieves a list of information (provided by the vehicle manufacturer) from the vehicle's on-board computer.

This information may include: VIN (Vehicle Identification Number), CID (Calibration ID) and CVN (Calibration Verification Number).

2.9 EU OBFCM

This function displays a list of vehicle information provided by the vehicle manufacturer, which is in compliance with CO₂ emission performance standards for new passenger cars and for new light commercial vehicles (Regulation EU 2019/613).

This information may include: Vehicle Identification Number, Total Fuel Consumed (Lifetime) and Total Distance Traveled (Lifetime) etc.

3. Upgrade

A number will be displayed upon the "Upgrade" module in the Home Menu indicating a new version of software is available.

It is strongly suggested to update the software on regular basis for more functions and better service.

Once the download is finished, the software packages will be installed automatically.

*Note: Stable and solid network connection is required.

4. Feedback

If you encounter any unsolved problems in the diagnostic process, you can send the last 20 test records to us by using the "Feedback" feature for timely technical assistance.

Tap "Feedback" on the Home Menu. The following 3 options are available:

- **Diag Feedback:** To show the tested vehicle model list.
- **History Feedback:** To view all diagnostic feedback and check the processes.
- **Offline Feedback:** This feature presents all diagnostic feedback logs that have not been successfully submitted due to network failure. The failed logs are queued for automatic re-upload once the tablet

establishes a stable network connection.
Our technical support will handle your feedback as quickly as possible.

5. Settings

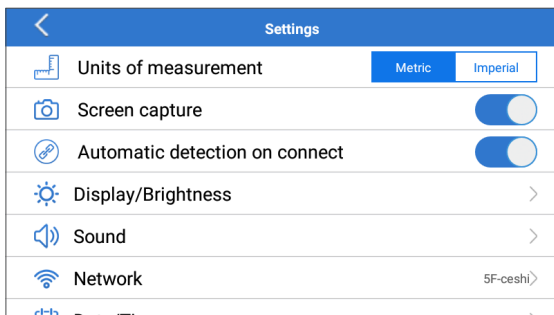

5.1 Units of measurement

This option allows you to set the measurement unit. Metric System and Imperial System are available.

5.2 Screen capture

This option allows you to set the Screen Capture icon to be shown or not on the screen.

5.3 Automatic detection on connect

This option enables you to determine whether to start an automatic VIN detection once the tool is properly connected to the vehicle's DLC.

5.4 Display/Brightness

This option allows you to set the standby time and screen brightness.

5.5 Sound

This option allows you to adjust the volume and other sound settings.

5.6 Network

This option allows you to set up Wi-Fi networks that can be connected.

5.7 Date/Time

This option allows you to set the system date & time.

5.8 Language

The tool supports multiple languages. You can use this option to set the preferred language.

*Note: After switching the language, please re-download all diagnostic software, otherwise the system will use the English software by default.

5.9 Workshop Information

This option allows you to set up the default email address for receiving the diagnostic reports or screenshots, and workshop information.

5.10 Recovery

This option allows you to reset the tool to the default factory setting.

5.11 Clean up

This option allows you to clear some cache files and free up storage space.

5.12 Data

Tap "Data". The following screen will appear:

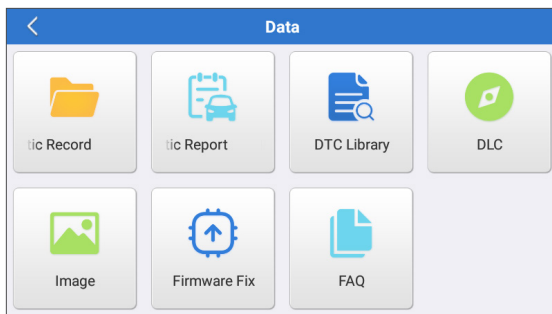

5.12.1 Diagnostic Record

This module stores the running parameters or waveform graphs the user records.

5.12.2 Diagnostic Report

This module stores all diagnostic reports generated in the process of vehicle diagnosis.

Diagnostic Record		
Name	Value	
Engine Oil Level SW	On	
Starter SW	On	
Intake Air Temperature	29.52 degree C	

(1 / 3)

Auto Playback(x1) 0/9

Graph
Combine
Value

*Explanation of terms:

- Graph: Display parameters in waveform graphs.
- Combine: Merge graphs for data comparison. Items will be displayed in different colors.
- Value (default): Display the parameters as text in a list format.
- Auto Playback: Automatic playback of the selected data stream items. When in Auto Playback mode, the bar will change to "Frame Playback".

5.12.3 DTC Library

This module helps you to get the details of the DTC, which will greatly help simplify the diagnostic process.

5.12.4 DLC (Data Link Connector)

This function helps you to find the location of the vehicle's DLC.

5.12.5 Image

This module allows you to view and manage all screenshots. All screenshots created in the vehicle diagnostic work will be saved in this module.

5.12.6 Firmware Fix

Use this module to upgrade and fix diagnostic firmware.

Do not cut power or switch to other interfaces in the upgrading process.

5.12.7 FAQ

This module lists some frequently asked questions and answers related to this tablet.

5.13 About

This option displays the hardware configuration information of the tool and the license agreement.

5.14 Version

This option allows you to check whether the current system version is the latest one.

WARNINGS

- Always perform automotive testing in a safe environment.
- DO NOT smoke near the vehicle during testing.
- DO NOT place the diagnostic tool near the engine or exhaust pipe to avoid damage from high temperatures.
- DO NOT wear loose clothing or jewelry when working on an engine.
- DO NOT connect or disconnect any test equipment while the ignition is on or the engine is running.
- DO NOT disassemble the code reader.
- Engine parts will become hot when the engine is running. To prevent severe burns, avoid contact with hot engine parts.
- When an engine is running, it produces carbon monoxide, a toxic and poisonous gas. Operate the vehicle ONLY in a well-ventilated area.
- Wear safety eye protection that meets ANSI standards.

CAUTIONS

- Please ensure that the vehicle battery is fully charged and the tablet is firmly connected to the vehicle DLC to avoid erroneous data generated by the tablet and diagnostic systems.
- Please do not use the diagnostic tool during driving.
- Keep clothing, hair, hands, tools, test equipment, etc. away from all moving or hot engine parts.
- Keep the tablet dry, clean, free from oil/water, or grease. Use a mild detergent on a clean cloth to clean the outside of the scan tool, when necessary.
- Keep the tablet out of the reach of children.

FAQ

Q: System halts when reading the data stream. What is the reason?

A: It may be caused by a slackened connector. Please turn off the tablet, firmly connect the connector, and switch it on again.

Q: Screen flashes at engine ignition start. What is the reason?

A: Normally caused by an electromagnetic disturbance.

Q: There is no response when communicating with the on-board computer. How to solve it?

A: Please confirm the proper voltage of the power supply and check the following:

- Whether the throttle has been closed;
- Whether the transmission is in the proper position;
- Whether the water is the proper temperature.

Q: What to do if the system fails to start auto VIN detection?

A: Please check the following possible causes:

- Whether the tool is properly connected to the vehicle's DLC.
- Whether the "Automatic detection on Connect" switch is OFF. If yes, slide it to ON.

Q: Why are there so many fault codes?

A: Usually it's caused by a poor connection or fault circuit grounding.

Q: How to upgrade the system software?

A:

1. Power the tool on and ensure a stable internet connection.
2. Tap "Settings" on the Home Menu, select "Version", and tap "Detect System Update" to enter the system upgrading page.
3. Follow the on-screen instructions step by step to finish the process. It may take a while to finish the upgrade depending on the internet speed. The tool will automatically restart and enters the Home Menu when the upgrade is finished.

Q: What if the tablet cannot be turned on even after recharging?

A: Please charge the tablet for at least 3 hours.

WARRANTY

TOPDON's One Year Limited Warranty

TOPDON warrants to its original purchaser that the company's products will be free from defects in material and workmanship for 12 months from the date of purchase (Warranty Period).

For the defects reported during the Warranty Period, TOPDON will either repair or replace the defective part or product according to its technical support analysis and confirmation.

TOPDON shall not be liable for any incidental or consequential damages arising from the device's use, misuse, or mounting.

If there is any conflict between the TOPDON warranty policy and local laws, the local laws shall prevail.

This limited warranty is void under the following conditions:

- Misused, disassembled, altered or repaired by unauthorized stores or technicians.
- Careless handling and operation's violation.

Notice: All information in this manual is based on the latest information available at the time of publication and no warranty can be made for its accuracy or completeness. TOPDON reserves the right to make changes at any time without notice.

Compliance Information

FCC ID: 2AVYW-ADEU

IC: 32511-ADEU

Any changes or modifications not expressly approved by the party responsible for compliance could void the user's authority to operate the equipment.

This device complies with Part 15 of the FCC Rules and Industry Canada licence-exempt RSS standard(s). Operation is subject to the following two conditions:

- (1) This device may not cause harmful interference, and
- (2) This device must accept any interference received, including interference that may cause undesired operation.

The digital apparatus complies with Canadian CAN ICES-3 (B)/NMB-3(B).

Cet appareil est conforme aux normes RSS exemptes de licence d'Industrie Canada. Le fonctionnement est soumis aux deux conditions suivantes:

- (1) Cet appareil ne doit pas causer d'interférences nuisibles, et
- (2) Cet appareil doit accepter toute interférence reçue, y compris les interférences susceptibles de provoquer un fonctionnement indésirable de l'appareil.

L'appareil numérique est conforme à la norme canadienne CAN ICES-3 (B)/NMB-3(B).

Note: This equipment has been tested and found to comply with the limits for a Class B digital device, pursuant to part 15 of the FCC Rules. These limits are designed to provide reasonable protection against harmful interference in a residential installation. This equipment generates, uses and can radiate radio frequency energy and, if not installed and used in accordance with the instructions, may cause harmful interference to radio communications. However, there is no guarantee that interference will not occur in a particular installation. If this equipment does cause harmful interference to radio or television reception, which can be determined by turning the equipment off and on, the user is encouraged to try to correct the interference by one or more of the following measures:

- Reorient or relocate the receiving antenna.
- Increase the separation between the equipment and receiver.
- Connect the equipment into an outlet on a circuit different from that to which the receiver is connected.
- Consult the dealer or an experienced radio/TV technician for help.

This device meets the exemption from the routine evaluation limits in section 2.5 of RSS 102 and compliance with RSS 102 RF exposure users can obtain Canadian information on RF exposure and compliance.

Cet appareil respecte l'exemption des limites d'évaluation de routine de la section 2.5 de la norme RSS 102 et la conformité à la norme RSS 102. Les utilisateurs d'exposition aux RF peuvent obtenir des informations canadiennes sur l'exposition aux RF et la conformité.

RF Exposure Statement

The device has been evaluated to meet general RF exposure requirement.

L'appareil a été évalué pour répondre aux exigences générales en matière d'exposition aux RF.

The SAR limit adopted by USA and Canada is 1.6 watts/kilogram (W/kg) averaged over one gram of tissue. The highest SAR value reported to the Federal Communications Commission (FCC) the Industry Canada (IC) for this device type when it is tested for the properly worn on the body is under 1g 1.6W/Kg.

La limite de SAR adoptée par les États-Unis et le Canada est de 1,6 watts/ kilogramme (W/kg) en moyenne pour un gramme de tissu. La valeur de SAR la plus élevée signalée à la Federal Communications Commission (FCC) à l'industrie Canada (IC) pour ce type d'appareil lorsqu'il est testé pour vérifier s'il est bien porté sur le corps est inférieure à 1g 1,6w /Kg.

This device is in compliance with the essential requirements and other relevant provisions of Radio Equipment Directive 2014/53/EU. The RF frequencies can be used in Europe without restriction.