

INSTRUCTION MANUAL

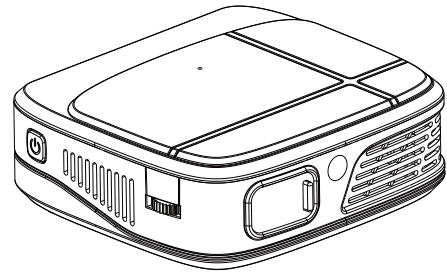

Mini Smart DLP Projector

● Contents

Projector Overview	1
Specifications.....	3
Remote Control.....	4
Powering ON/OFF	5
Focusing	6
Use USB interface	7
Use HDMI interface.....	8
WiFi Connection	9
Factory Data Reset	10
System Local Upgrade.....	11
Bluetooth	12
Settings	13
System Online Upgrade.....	14
How to Charge	15
Safety Instruction	16
Warranty Card.....	17

● Warranty Card

Name/Company: _____

Telephone: _____

Address: _____

Fax No.: _____

Product Purchased: _____

Model No.: _____

Series No.: _____

Dealer Name: _____

Date of Purchase: _____

Invoice No.: _____

Customer need to keep this warranty card.

Thank you for purchasing the projector.

From date of purchased, we offer one year warranty on projector and 6 months warranty on the lamp.

When you need to fix, please return the defective product, completed warranty card and original invoice to the address indicated on the warranty card.

● Safety Instruction

Installation

- To get the better watching, please use this projector while draw the curtain or in dark room.
- Please use this projector carefully, dropping or crash may damage parts or result in blurred image, abnormal displaying.

Power

- Be careful while using the power cord, avoid to excessive bending; the damage of power cable may cause electric shock and fire.
- It is better to unplug the power cord after power off.

Cleaning

- Unplug the power cable first.
- Clean the shell regularly with a damp cloth, neutral detergent can be used.
- Please use a glasses cloth or lens paper, not to scratch the lens.
- Please clean projector's vents and speakers regularly by banister brush, or the vents will be blocked.

High temperature attention

- While projection or just finish, near the exhaust port will be very hot, may be scald if touch it.
- While projection, please do not look the lens directly, or may hurt eyes.

*Warm tips

- Do not disassemble the projector, with a risk of electric shock, also affect the normal warranty.
- Please do not put any liquid or heavy stuff on the projector.

● Projector Overview

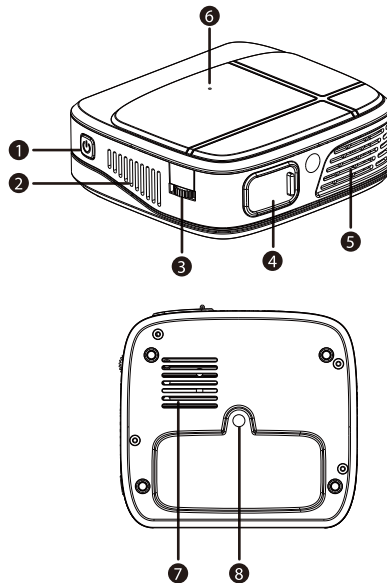

- | | |
|--------------------------|--------------------------------------|
| 1. Power on / off button | 5. Ventilation slots |
| 2. Ventilation slots | 6. Charge LED (charge bule,full off) |
| 3. Focus ring | 7. Ventilation slots |
| 4. Projector lens | 8. Stand hole (1/4inch) |

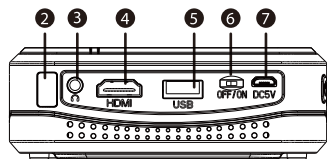
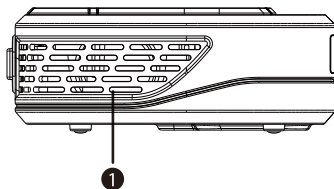

1. Speaker
2. IR remote sensor
3. AUX cord jack (Earphone jack)
4. HDMI port
5. USB port
6. Master Switch
7. Micro USB Charging port

Warning tips:

It's strictly prohibited to block the air intake window.
This may cause over heating and damage the projector.

● How to Charge

1. To Charge when projector is off:

When the projector is connected with the power adapter, the projector can be charged by connecting the adapter (regardless of whether the main switch is "ON or Off"), the indicator light is blue when charging.

2. To charge when the projector is on:

When the projector is connected with the power adapter, put the switch in the "ON" position, and press the switch, the charging icon will be displayed on the upper right of the main interface, it means it is charging.

Tips:

- Please charge the battery with the original power adapter;
- The product is only suitable for a non high temperature environment;
- When it is charging, do not block the battery cooling holes;
- Please don't stab or crash the battery when it is charging;
- Do not get the battery wet.

Attention: This function is only for projector with battery.



Safety Precautions for the long-term unused projector with batteries:

• Keep "OFF" on Master switch, cut off the power completely.

• **Charge up battery at regular:**

During the period of long-term non-use, the battery may be in over-discharge condition because of its self-discharging characteristics which will result in loss of battery performance. In order to avoid such situation, the battery should be charged regularly for 2 hours every 2 months.

● System Online Upgrade

Choose "System Update" on the "Settings" page of the navigation bar and choose "System Net Update", then search newest version automatically, and update the system according to the prompts.

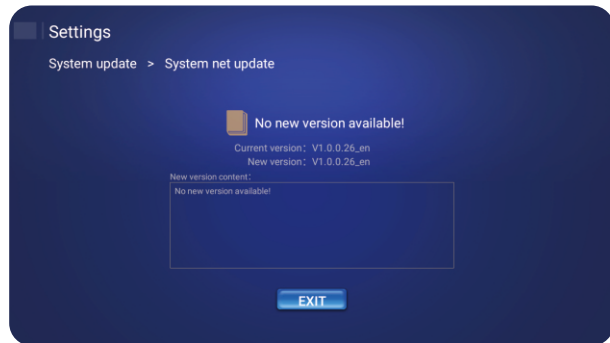
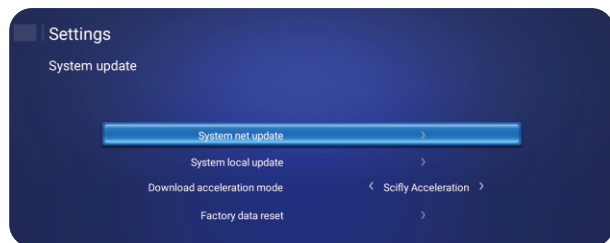

● Specifications

Optical Parameters:

Display chip:	0.2" DMD RGB-LED
Lens:	High light transmittance coating glasses
Brightness uniformity:	98%
NTSC:	≥120%
Resolution:	Support Max 1080p
3D display:	Yes

Physical Parameters:

Projection size:	5-250 inch
Throw ratio:	1.2:1
Keystone:	Electronical adjusting±40°
Focus mode:	manual focus
Power adapter:	DC5V/3A
Power:	15W
Speaker:	4Q/3W
Size:	100×108×40mm
N.W.:	280g

● System Parameter

CPU:	RK3128
RAM:	1G
ROM:	8G
OS:	Based on Android 7.1
WiFi:	WiFi2.4G/5G, 802.11b/g/n
Bluetooth:	Bluetooth 4.0

● Accessories:

User Manual	×1
Power Adapter	×1
Tripod	×1
Micro USB wire	×1
Remote Control	×1

● Remote Control

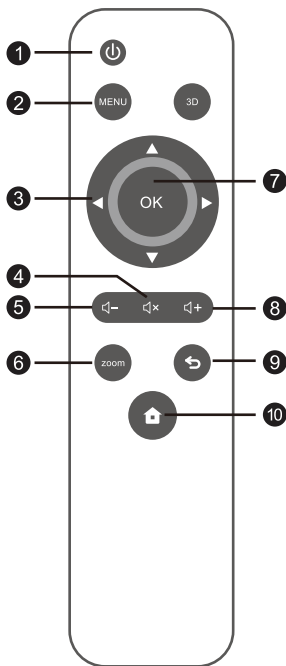

1. Power
2. Menu
3. Arrow keys
4. Mute
5. Volume Down
6. Aspect Ratio
7. Enter
8. Volume Up
9. Exit
10. Homepage

● Settings

Choose "Projector Settings" on the "Settings" page of navigation bar.

1. Projection Method

Choose "Projection mode" and press the OK button to choose the desired projection method.

2. Choose "Aspect Ratio" and press the OK button to set "Full Screen" & "16/9" & "4/3" respectively.

3. Choose the "Image Correction" and press the OK button.

When "Auto Keystone" is on, the projector supports vertical keystone correction.

Note: When the automatic trapezoidal correction angle is not correct, you can turn off the Auto Keystone function and place the projector on the horizontal table to perform "Gyroscope Calibration".

When "Auto Keystone" is turned off, the "vertical" & "horizontal" or "four-corner keystone" can be manually set.



● Bluetooth

Step1: Choose “Network Settings” on the “Settings” page of the navigation bar.

Step2: Open “Bluetooth” and choose the corresponding Bluetooth device, then follow the prompts to connect.

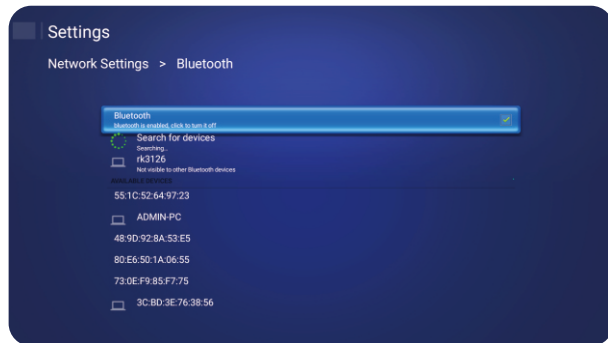

● Powering ON/OFF

Powering ON

Step1: Plug the DC terminal of the power adaptor into “Micro USB Charging port” terminal of projector.

Step2: Move the master switch right to “ON”, press the power key.

Powering OFF

Step1: Press the power key, the projector is off.

Step2: When the projector is off, return the master switch to the off position.

Failure to do so may result in the projector turning on while in transit resulting in electrical fires.

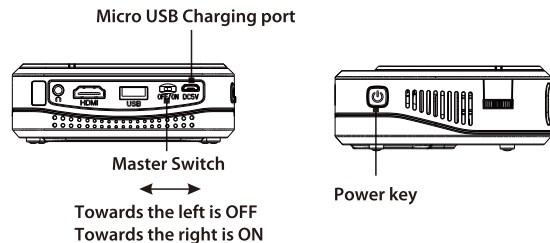

● Focusing

Adjust the focus ring front or back lightly until the image is clear.

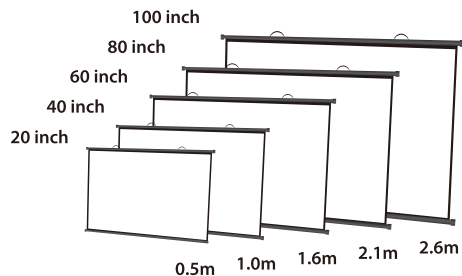
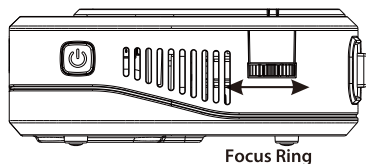

● System Local Upgrade

Step1: Prepare a USB disk (**Note:** the format of USB disk must be FAT32. NTFS format is NOT supported).

Step2: Place the upgrade package "update_signed.zip" (note that the file name cannot be modified) in the root directory of the USB disk.

Step3: Insert the USB disk to the projector.

Step4: Choose "System Update" on the Settings page of the navigation bar and choose "System Local Upgrade", then follow the system prompts to upgrade.

Step5: After rebooting, choose "Reboot system now" and upgrade automatically.

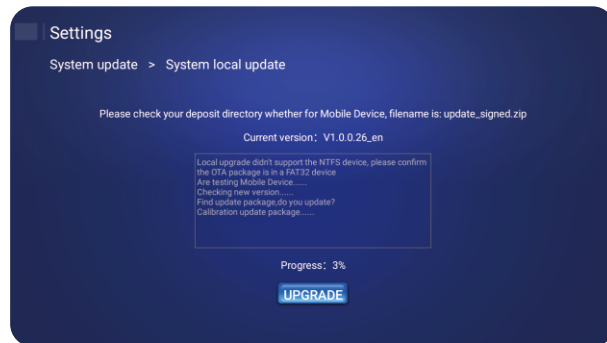

● Factory Data Reset

Choose "System Update" in the "Settings" page of the navigation bar then choose "Factory Data Reset".

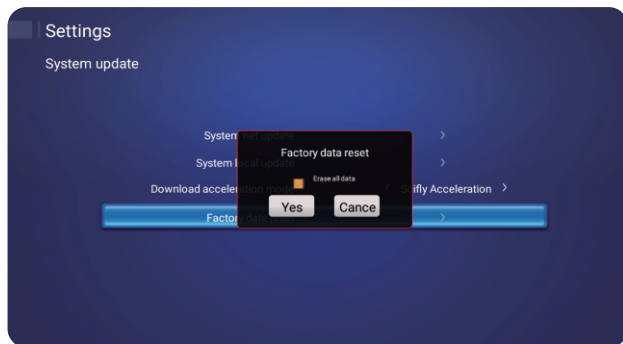

● Use USB interface

1. Insert the USB disk (support FAT32/NTFS) to the projector, enter the USB disk according to the prompt or open the "Media Player" in the "Settings" page of the navigation bar to enter the USB disk.
2. It can read the "Picture / Video / Music / Text File" and so on and it also can be installed the APK applications.



● Supported multimedia formats:

Picture Format	JPG, JPEG, BMP, PNG
Audio Format	MP1, MP2, MP3,WMA,WAV,OGG, OGA,FLAC,AAC, M4A
Video Coding	MPEG1/2, MPEG4, H.264, MVC, H.265/HEVC, H.263
Video Format	MPG, VOB, TS, AVI, MKV, MP4, MOV, 3GP, FLV
File Format	TXT

● Use HDMI interface

Step1: Connect PC/DVD (or other HDMI signal output device) to the projector with HDMI cable.

Step2: Choose "HDMI" channel in the "Apps" interface of the navigation bar to switch the signal to enter HDMI.

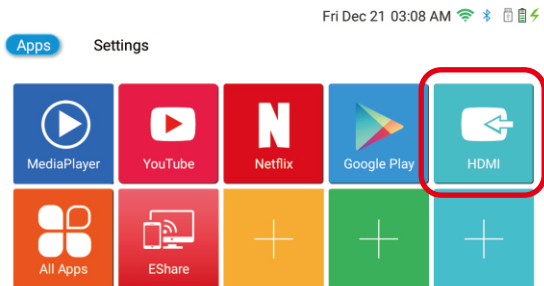

8

● WiFi Connection

Step1: Choose "Network Settings" on the "Settings" page of the navigation bar.

Step2: Open "WiFi Settings" and choose the AP hotspot to be connected, then type in the password according to the prompt to connect.

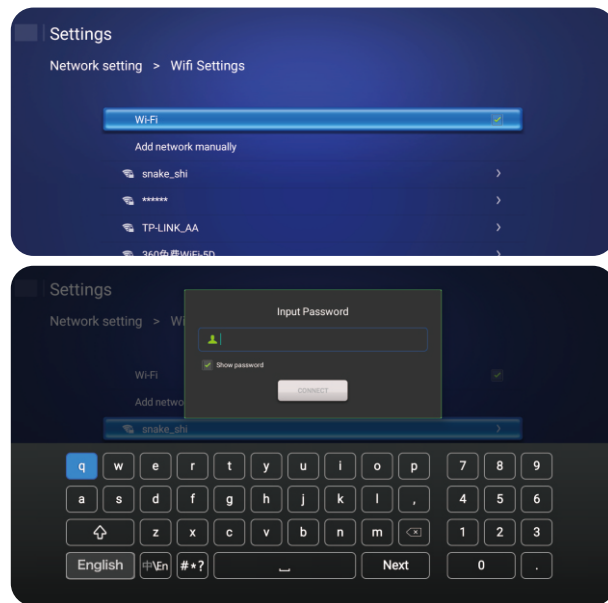

9

FCC Warning

This device complies with part 15 of the FCC rules. Operation is subject to the following two conditions: (1) this device may not cause harmful interference, and (2) this device must accept any interference received, including interference that may cause undesired operation.

Changes or modifications not expressly approved by the party responsible for compliance could void the user's authority to operate the equipment.

NOTE: This equipment has been tested and found to comply with the limits for a Class B digital device, pursuant to part 15 of the FCC Rules. These limits are designed to provide reasonable protection against harmful interference in a residential installation. This equipment generates uses and can radiate radio frequency energy and, if not installed and used in accordance with the instructions, may cause harmful interference to radio communications. However, there is no guarantee that interference will not occur in a particular installation. If this equipment does cause harmful interference to radio or television reception, which can be determined by turning the equipment off and on, the user is encouraged to try to correct the interference by one or more of the following measures:

- Reorient or relocate the receiving antenna.
- Increase the separation between the equipment and receiver.
- Connect the equipment into an outlet on a circuit different from that to which the receiver is connected.
- Consult the dealer or an experienced radio/TV technician for help.

Radiation Exposure Statement

This equipment complies with FCC radiation exposure limits set forth for an uncontrolled environment. This equipment should be installed and operated with minimum distance 20cm between the radiator and your body.