

# MEASUREMENT REPORT

## FCC PART95 Subpart M

---

**FCC ID:** 2AV2OITS-AXX

**Applicant:** Changsha Microbrain Intelligent Technology Co., Ltd.

**Application Type:** Certification

**Product:** Millimeter wave radar

**Model No.:** ITS-A08

**Serial Model No.:** ITS-AXX (X means 0-9)

**FCC Classification:** Part 95 Vehicular Radar Systems

**FCC Rule Part(s):** FCC Part 95, Subpart M

**Test Procedure(s):** ANSI C63.10-2013

**Test Date:** March 28 ~ 30, 2020

Reviewed By:   
\_\_\_\_\_  
( Sunny Sun )

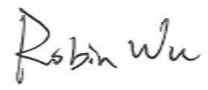
Approved By:   
\_\_\_\_\_  
( Robin Wu )



The test results relate only to the samples tested.

This equipment has been shown to be capable of compliance with the applicable technical standards as indicated in the measurement report and was tested in accordance with the measurement procedures specified in ANSI C63.10-2013. Test results reported herein relate only to the item(s) tested.

The test report shall not be reproduced except in full without the written approval of MRT Technology (Suzhou) Co., Ltd.

---

### Revision History

Report No.	Version	Description	Issue Date	Note
2009RSU016-U1	Rev. 01	Initial Report	09-01-2020	Valid

---

## CONTENTS

Description	Page
<b>1. INTRODUCTION .....</b>	<b>6</b>
1.1. Scope .....	6
1.2. MRT Test Location .....	6
<b>2. PRODUCT INFORMATION .....</b>	<b>7</b>
2.1. Equipment Description .....	7
2.2. Test Mode .....	7
2.3. EMI Suppression Device(s)/Modifications .....	7
2.4. Labeling Requirements .....	7
<b>3. DESCRIPTION of TEST.....</b>	<b>8</b>
3.1. Evaluation Procedure .....	8
3.2. Radiated Emissions.....	8
<b>4. TEST EQUIPMENT CALIBRATION DATA .....</b>	<b>10</b>
<b>5. MEASUREMENT UNCERTAINTY .....</b>	<b>11</b>
<b>6. TEST RESULT .....</b>	<b>12</b>
6.1. Summary .....	12
6.2. EIRP.....	13
6.2.1. Test Limit .....	13
6.2.2. Test Procedure used .....	13
6.2.3. Test Setting.....	13
6.2.4. Test Setup .....	14
6.2.5. Test Result.....	15
6.3. Occupied bandwidth.....	16
6.3.1. Test Limit .....	16
6.3.2. Test Procedure used .....	16
6.3.3. Test Setting.....	16
6.3.4. Test Setup .....	16
6.3.5. Test Result.....	17
6.4. Unwanted Emissions.....	18
6.4.1. Test Limit .....	18
6.4.2. Test Procedure used .....	18
6.4.3. Test Procedure .....	19
6.4.4. Test Setup .....	20
6.4.5. Test Results.....	22

---

6.5.	Frequency Stability.....	25
6.5.1.	Test Limit .....	25
6.5.2.	Test Procedure used .....	25
6.5.3.	Test Procedure .....	25
6.5.4.	Test Setup .....	26
6.5.5.	Test Result.....	27
<b>7.</b>	<b>CONCLUSION.....</b>	<b>28</b>
	<b>Appendix A - Test Setup Photograph.....</b>	<b>29</b>
	<b>Appendix B - EUT Photograph .....</b>	<b>30</b>

## General Information

<b>Applicant:</b>	Changsha Microbrain Intelligent Technology Co., Ltd.
<b>Applicant Address:</b>	8th Floor, HeadquarterBuilding of CEC Software Park, NO.39 Jianshan Road, High-Tech Development Zone, Changsha, Hunan, China
<b>Manufacturer:</b>	Changsha Microbrain Intelligent Technology Co., Ltd.
<b>Manufacturer Address:</b>	8th Floor, HeadquarterBuilding of CEC Software Park, NO.39 Jianshan Road, High-Tech Development Zone, Changsha, Hunan, China
<b>Test Site:</b>	MRT Technology (Suzhou) Co., Ltd
<b>Test Site Address:</b>	D8 Building, No.2 Tian'edang Rd., Wuzhong Economic Development Zone, Suzhou, China

## Test Facility / Accreditations

Measurements were performed at MRT Laboratory located in Tian'edang Rd., Suzhou, China.

- MRT facility is an FCC accredited testing laboratory (MRT Designation No. CN1166) on the FCC website.
- MRT facility is an ISED recognized testing laboratory (MRT Reg. No. CN0001) on the ISED website.
- MRT facility is a VCCI registered (R-20025, G-20034, C-20020, T-20020) test laboratory with the site description on file at VCCI Council.
- MRT Lab is accredited to ISO 17025 by the A2LA under the A2LA Program (Cert. No. 3628.01) and CNAS under the CNAS Program (Cert. No. L10551) in EMC, Safety, Radio, Telecommunications and SAR testing.

## 1. INTRODUCTION

### 1.1. Scope

Measurement and determination of electromagnetic emissions (EMC) of radio frequency devices including intentional and/or unintentional radiators for compliance with the technical rules and regulations of the Federal Communications Commission and the Innovation, Science and Economic Development Canada and Certification and Engineering Bureau.

### 1.2. MRT Test Location

The map below shows the location of the MRT LABORATORY, its proximity to the Taihu Lake. These measurement tests were conducted at the MRT Technology (Suzhou) Co., Ltd. Facility located at D8 Building, No.2 Tian'edang Rd., Wuzhong Economic Development Zone, Suzhou, China. The measurement facility compliant with the test site requirements specified in ANSI C63.4-2014.



## 2. PRODUCT INFORMATION

### 2.1. Equipment Description

Product Name:	Millimeter wave radar
Model No.:	ITS-A08
Serial Model No.:	ITS-AXX (X means 0-9)
Transmitting Frequency:	77 ~ 81GHz
Type of Modulation:	FMCW
Emission Designator:	2G86N0N
Working Voltage Range:	10VDC ~ 16VDC
Working Temperature Range:	-40°C ~ 85°C
Antenna Type:	Integrated antenna

Note: The different of models only for marketing different client, the other was the same.

### 2.2. Test Mode

Test Mode:	Transmit
------------	----------

Note: The engineer test sample was provided by the manufacturer, it was configured into continuous TX status after power on.

### 2.3. EMI Suppression Device(s)/Modifications

No EMI suppression device(s) were added and/or no modifications were made during testing.

### 2.4. Labeling Requirements

Per 2.1074; Docket 95-19

The label shall be permanently affixed at a conspicuous location on the device; instruction manual or pamphlet supplied to the user and be readily visible to the purchaser at the time of purchase.

However, when the device is so small wherein placement of the label with specified statement is not practical, only the FCC ID must be displayed on the device per Section 15.19(a)(5). Please see attachment for FCC ID label and label location.

### **3. DESCRIPTION of TEST**

#### **3.1. Evaluation Procedure**

The measurement procedures described in the American National Standard for Testing Unlicensed Wireless Devices (ANSI C63.10-2013), and the requirement provided in FCC Part 95M were used in the measurement of the EUT.

#### **3.2. Radiated Emissions**

The radiated test facilities consisted of an indoor 3 meter semi-anechoic chamber used for final measurements and exploratory measurements, when necessary. The measurement area is contained within the semi-anechoic chamber which is shielded from any ambient interference. For measurements above 1GHz absorbers are arranged on the floor between the turn table and the antenna mast in such a way so as to maximize the reduction of reflections. For measurements below 1GHz, the absorbers are removed. A MF Model 210SS turntable is used for radiated measurement. It is a continuously rotatable, remote controlled, metallic turntable and 2 meters (6.56 ft.) in diameter. The turn table is flush with the raised floor of the chamber in order to maintain its function as a ground plane. An 80cm high PVC support structure is placed on top of the turntable.

For all measurements, the spectrum was scanned through all EUT azimuths and from 1 to 4 meter receive antenna height using a broadband antenna from 30MHz up to the upper frequency shown in 15.33(b)(1) depending on the highest frequency generated or used in the device or on which the device operates or tunes. For frequencies above 1GHz, linearly polarized double ridge horn antennas were used. For frequencies below 30MHz, a calibrated loop antenna was used. When exploratory measurements were necessary, they were performed at 1 meter test distance inside the semi-anechoic chamber using broadband antennas, broadband amplifiers, and spectrum analyzers to determine the frequencies and modes producing the maximum emissions. Sufficient time for the EUT, support equipment, and test equipment was allowed in order for them to warm up to their normal operating condition. The test set-up for frequencies below 1GHz was placed on top of the 0.8 meter high, 1 x 1.5 meter table; and test set-up for frequencies 1-40GHz was placed on top of the 1.5 meter high, 1 x 1.5 meter table. The EUT, support equipment, and interconnecting cables were arranged and manipulated to maximize each emission. Appropriate precaution was taken to ensure that all emissions from the EUT were maximized and investigated. The system configuration, clock speed, mode of operation or video resolution, if applicable, turntable azimuth, and receive antenna height was noted for each frequency found.

Final measurements were made in the semi-anechoic chamber using calibrated, linearly polarized broadband and horn antennas. The test setup was configured to the setup that produced the worst case emissions. The spectrum analyzer was set to investigate all frequencies required for testing to compare the highest radiated disturbances with respect to the specified limits. The turntable containing the EUT was rotated through 360 degrees and the height of the receive antenna was



varied 1 to 4 meters and stopped at the azimuth and height producing the maximum emission. Each emission was maximized by changing the orientation of the EUT through three orthogonal planes and changing the polarity of the receive antenna, whichever produced the worst-case emissions. According to 3dB Beam-Width of horn antenna, the horn antenna should be always directed to the EUT when rising height.

## 4. TEST EQUIPMENT CALIBRATION DATA

### Radiated Emission - AC1

Instrument	Manufacturer	Type No.	Asset No.	Cali. Interval	Cali. Due Date
EMI Test Receiver	R&S	ESR7	MRTSUE06001	1 year	2020/08/01
EXA Signal Analyzer	Keysight	N9010B	MRTSUE06607	1 year	2021/01/08
Loop Antenna	Schwarzbeck	FMZB 1519	MRTSUE06025	1 year	2019/11/09
Bilog Period Antenna	Schwarzbeck	VULB 9168	MRTSUE06172	1 year	2020/03/31
Broad-Band Horn Antenna	Schwarzbeck	BBHA9120D	MRTSUE06023	1 year	2020/10/13
Broad Band Horn Antenna	Schwarzbeck	BBHA 9170	MRTSUE06024	1 year	2020/12/17
Preamplifier	Schwarzbeck	BBV 9721	MRTSUE06121	1 year	2020/06/11
Micro-Wave Antenna	MI-WWAVE	261U-25	MRTSUE06273	N/A	N/A
Micro-Wave Antenna	MI-WWAVE	261E-25	MRTSUE06276	N/A	N/A
Micro-Wave Antenna	MI-WWAVE	261F-25	MRTSUE06275	N/A	N/A
Micro-Wave Antenna	MI-WWAVE	261G	MRTSUE06274	N/A	N/A
Micro-Wave Antenna	VDI	WR3.4	MRTSUE06277	N/A	N/A
Standard Gain Horn Antenna	A-INFOMW	LB-10-25-A	MRTSUE06410	N/A	N/A
Standard Gain Horn Antenna	A-INFOMW	LB-15-25-A	MRTSUE06409	N/A	N/A
Waveguide Harmonic Mixer	Keysight	M1970V	MRTSUE06271	N/A	N/A
Waveguide Harmonic Mixer	Keysight	M1970W	MRTSUE06272	N/A	N/A
RF Signal Generator	Keysight	E8257D	MRTSUE06453	N/A	N/A
SA Extension Module	Keysight	N9029AV06	MRTSUE06368	N/A	N/A
SA Extension Module	Keysight	N9029AV05	MRTSUE06367	N/A	N/A
SA Extension Module	Keysight	N9029AV03	MRTSUE06366	N/A	N/A
Millimeter wave signal source frequency expander	Keysight	E8257DV15	MRTSUE06456	N/A	N/A
Millimeter wave signal source frequency expander	Keysight	E8257DV10	MRTSUE06458	N/A	N/A
USB wideband power sensor	Keysight	U8489A	MRTSUE06448	N/A	N/A
Oscilloscope	Agilent	DSO-X 6002A	MRTSUE06107	N/A	N/A
Hygrothermograph	Testo	608-H1	MRTSUE06403	1 year	2020/08/08
Anechoic Chamber	TDK	Chamber-AC1	MRTSUE06212	1 year	2020/04/30

Software	Version	Function
EMI Test Software	V3	EMI Test Software

## 5. MEASUREMENT UNCERTAINTY

Where relevant, the following test uncertainty levels have been estimated for tests performed on the EUT as specified in CISPR 16-4-2. This uncertainty represents an expanded uncertainty expressed at approximately the 95% confidence level using a coverage factor of  $k = 2$ .

### Radiated Emission Measurement - AC1

The maximum measurement uncertainty is evaluated as:

Horizontal: 30MHz~300MHz: 4.07dB

300MHz~1GHz: 3.63dB

1GHz~18GHz: 4.16dB

Vertical: 30MHz~300MHz: 4.18dB

300MHz~1GHz: 3.60dB

1GHz~18GHz: 4.76dB

### Radiated Emission Measurement - AC2

The maximum measurement uncertainty is evaluated as:

Horizontal: 30MHz~300MHz: 3.75dB

300MHz~1GHz: 3.53dB

1GHz~18GHz: 4.28dB

Vertical: 30MHz~300MHz: 3.86dB

300MHz~1GHz: 3.53dB

1GHz~18GHz: 4.33dB

## 6. TEST RESULT

### 6.1. Summary

FCC Part Section(s)	Test Description	Test Limit	Test Condition	Test Result	Reference
95.3367	EIRP	Peak EIRP < 55dBm/MHz Average EIRP < 50dBm/MHz	Radiated	Pass	Section 6.2
2.1049	Occupied bandwidth	N/A		Pass	Section 6.3
95.3379(a)	Unwanted Emissions	Refer to Section 6.4.1		Pass	Section 6.4
95.3379(b)	Frequency stability	Fall within the frequency band 76-81GHz		Pass	Section 6.5

**Notes:** The radiation measurements are performed in X, Y, Z axis positioning. Only the worst case data is shown in the report.

## 6.2. EIRP

### 6.2.1. Test Limit

The fundamental radiated emission limits within the 76-81 GHz band are expressed in terms of Equivalent Isotropically Radiated Power (EIRP) and are as follows:

- (a) The maximum power (EIRP) within the 76-81 GHz band shall not exceed 50 dBm based on measurements employing a power averaging detector with a 1 MHz Resolution Bandwidth (RBW).
- (b) The maximum peak power (EIRP) within the 76-81 GHz band shall not exceed 55 dBm based on measurements employing a peak detector with a 1 MHz RBW.

### 6.2.2. Test Procedure used

ANSI C63.10 Section 9.10

Note: Far-field boundary calculation as below.

According to ANSI C63.10-2013, Clause 9, for mm-wave measurements,  $L \gg \lambda$  and a more suitable formula for the far-field boundary distance:  $R_{(\text{Far Field})} = 2L^2/\lambda$

- L is the largest antenna dimension of the transmit antenna in m
- $\lambda$  is the wavelength in m

Far-field boundary calculation			
Frequency Range (GHz)	$\lambda$ (m)	L (m)	$R_{(\text{Far Field})}$ (m)
77 ~ 81	0.0037	0.0267	0.38

Our measurement is performed at a minimum distance of  $0.45\text{m} > R_{(\text{Far Field})}$

### 6.2.3. Test Setting

1. Span = approximately two times to three times the EBW, centered on the carrier frequency
2. RBW = 1MHz
3. VBW = 3MHz
4. Detector function = Peak for peak EIRP, Average for average EIRP.
5. Sweep time = auto
6. Trace mode = max hold.
7. Allow the trace to stabilize.
8. Use the peak search function to mark the max of the emission.

### 6.2.4. Test Setup

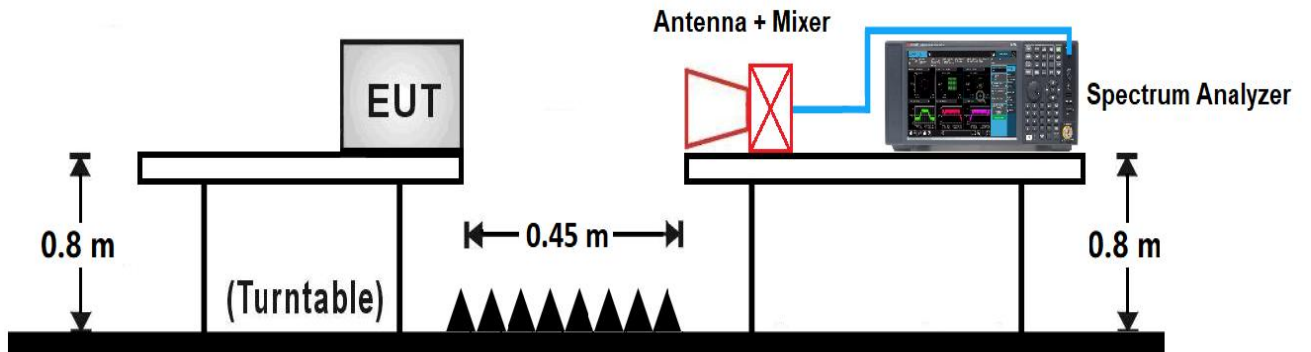

**6.2.5. Test Result**

Product	Millimeter wave radar	Temperature	24°C
Test Engineer	Vincent Yu	Relative Humidity	54%
Test Site	AC1	Test Date	2020/03/28

EIRP (dBm)		EIRP Limit (dBm)		Result
Peak	Average	Peak	Average	
7.79	N/A (Note)	≤ 55	≤ 50	Pass

Note: Average EIRP measurement was not performed when the Peak EIRP level lower than average limit.

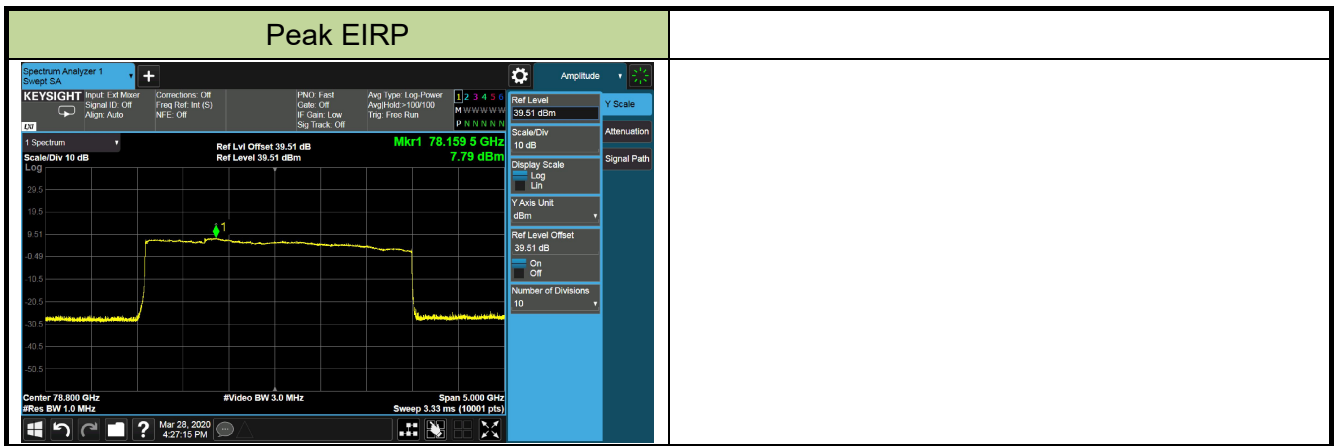

### 6.3. Occupied bandwidth

#### 6.3.1. Test Limit

N/A

#### 6.3.2. Test Procedure used

ANSI C63.10 Section 6.9.3

#### 6.3.3. Test Setting

1. Span = approximately 1.5 times to 5 times the OBW, centered on the carrier frequency
2. RBW = 1MHz
3. VBW = 3MHz
4. Detector function = Peak
5. Sweep time = auto
6. Trace mode = max hold.
7. The EUT shall be transmitting at its maximum data rate. Allow the trace to stabilize.
8. Use the 99% power bandwidth function of the instrument (if available) and report the measured bandwidth.

#### 6.3.4. Test Setup

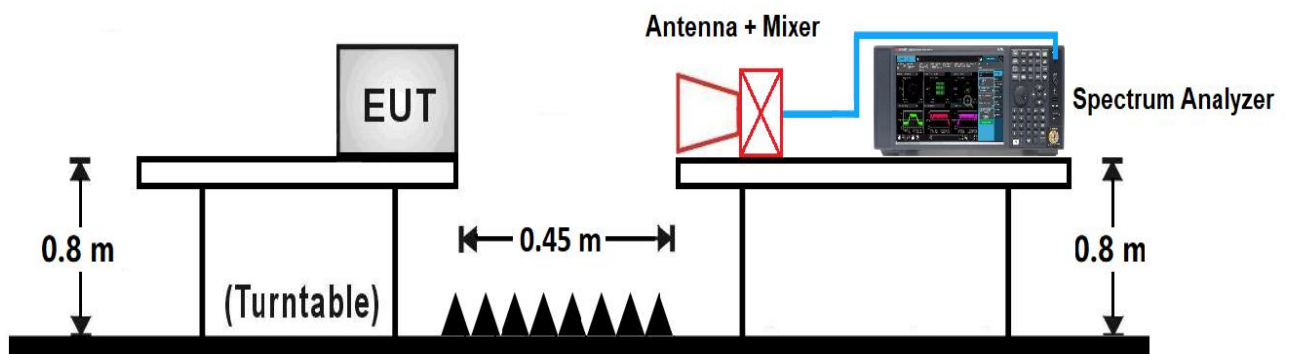



### 6.3.5. Test Result

Product	Millimeter wave radar	Temperature	24°C
Test Engineer	Vincent Yu	Relative Humidity	54%
Test Site	AC1	Test Date	2020/03/28

99% Bandwidth (GHz)	26dB Bandwidth (GHz)	Result
2.8646	2.942	Pass



**6.4. Unwanted Emissions**

**6.4.1. Test Limit**

The power density of any emissions outside the 76-81 GHz band shall consist solely of spurious emissions and shall not exceed the following:

- (1) Radiated emissions below 40 GHz shall not exceed the field strength as shown in the following emissions table.

Frequency (MHz)	Field Strength (uV/m)	Measurement Distance (m)
0.009 ~ 0.490	2400/F(kHz)	300
0.490 ~ 1.705	24000/F(kHz)	30
1.705 ~ 30.0	30	30
30 ~ 88	100	3
88 ~ 216	150	3
216 ~ 960	200	3
Above 960	500	3

- (i) The tighter limit applies at the band edges.
- (ii) The limits in the table are based on the frequency of the unwanted emissions and not the fundamental frequency. However, the level of any unwanted emissions shall not exceed the level of the fundamental frequency.
- (iii) The emissions limits shown in the table are based on measurements employing a CISPR quasi-peak detector except for the frequency bands 9.0-90.0 kHz, 110.0-490.0 kHz, and above 1000 MHz. Radiated emissions limits in these three bands are based on measurements employing an average detector with a 1 MHz RBW.

- (2) The power density of radiated emissions outside the 76-81 GHz band above 40.0 GHz shall not exceed the following, based on measurements employing an average detector with a 1 MHz RBW:

- (i) For radiated emissions between 40 GHz and 200 GHz: 600 pW/cm<sup>2</sup> at a distance of 3 meters from the exterior surface of the radiating structure.
- (ii) For radiated emissions above 200 GHz: 1000 pW/cm<sup>2</sup> at a distance of 3 meters from the exterior surface of the radiating structure.

- (3) For field disturbance sensors and radar systems operating in the 76-81 GHz band, the spectrum shall be investigated up to 231.0 GHz.

**6.4.2. Test Procedure used**

ANSI C63.10 Section 9.12 and Section 9.13

**6.4.3. Test Procedure**

**Measurement of harmonic and spurious emissions above 40 GHz**

1. Connect the test antenna covering the appropriate frequency range to a spectrum analyzer via an external mixer.
2. Set spectrum analyzer RBW = 1MHz, VBW = 3MHz, average detector.
3. Maximize all observed emissions. Note the maximum power indicated on the spectrum analyzer. Adjust this reading, if necessary, by the conversion loss of the external mixer used at the frequency under investigation and the external mixer IF cable loss.
4. Calculate the maximum field strength of the emission at the measurement distance.
5. Calculate the power density at the distance specified by the limit from the field strength at the distance specified by the limit.
6. Repeat the preceding sequence for every emission observed in the frequency band under investigation.

**Measurement of harmonic and spurious emissions below 40 GHz**

**Peak Field Strength Measurements**

1. Analyzer center frequency was set to the frequency of the radiated spurious emission of interest
2. RBW = as specified in Table 1
3. VBW = 3 x RBW
4. Detector = Peak
5. Sweep time = auto couple
6. Trace mode = max hold
7. Trace was allowed to stabilize

**Table 1 – RBW**

Frequency	RBW
9 ~ 90 kHz	1 MHz
90 ~ 110 kHz	200 Hz
110 ~ 490 kHz	1 MHz
0.49 ~ 30 MHz	9 kHz
30 ~ 1000 MHz	120 kHz
> 1000 MHz	1 MHz

### Average Field Strength Measurements

1. Analyzer center frequency was set to the frequency of the radiated spurious emission of interest
2. RBW = 1MHz
3. VBW  $\geq 1/T$
4. As an alternative, the instrument may be set to linear detector mode. Ensure that video filtering is applied in linear voltage domain (rather than in a log or dB domain). Some instruments require linear display mode in order to accomplish this. Others have a setting for Average-VBW Type, which can be set to "Voltage" regardless of the display mode
5. Detector = Peak
6. Sweep time = auto
7. Trace mode = max hold
8. Allow max hold to run for at least 50 times (1/duty cycle) traces

#### 6.4.4. Test Setup

Below 1GHz Test Setup:

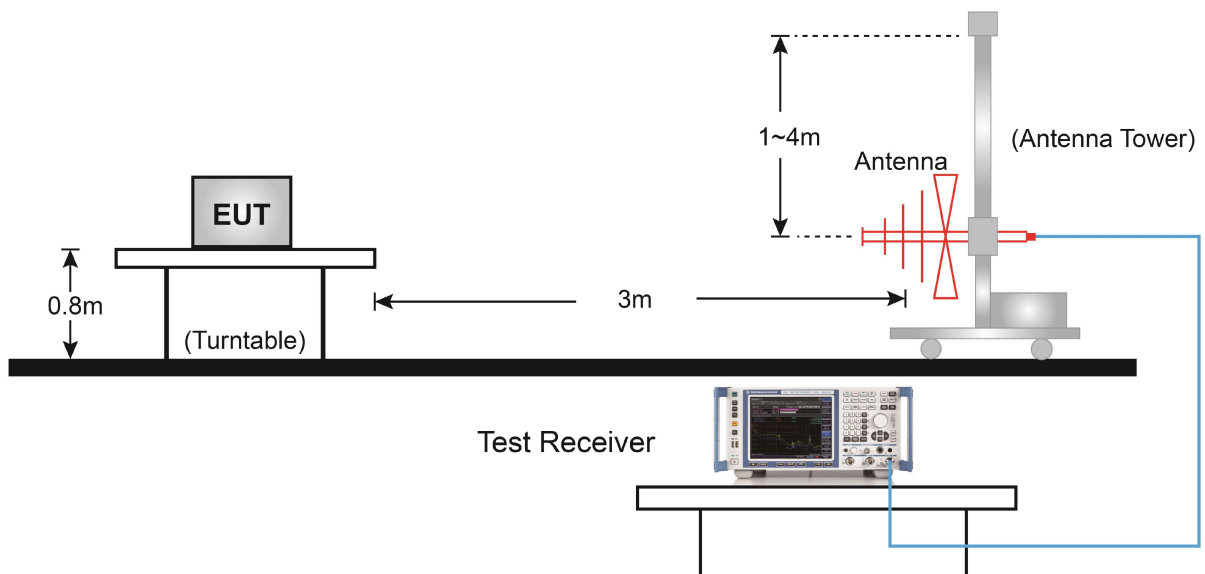

1GHz ~ 40GHz Test Setup:

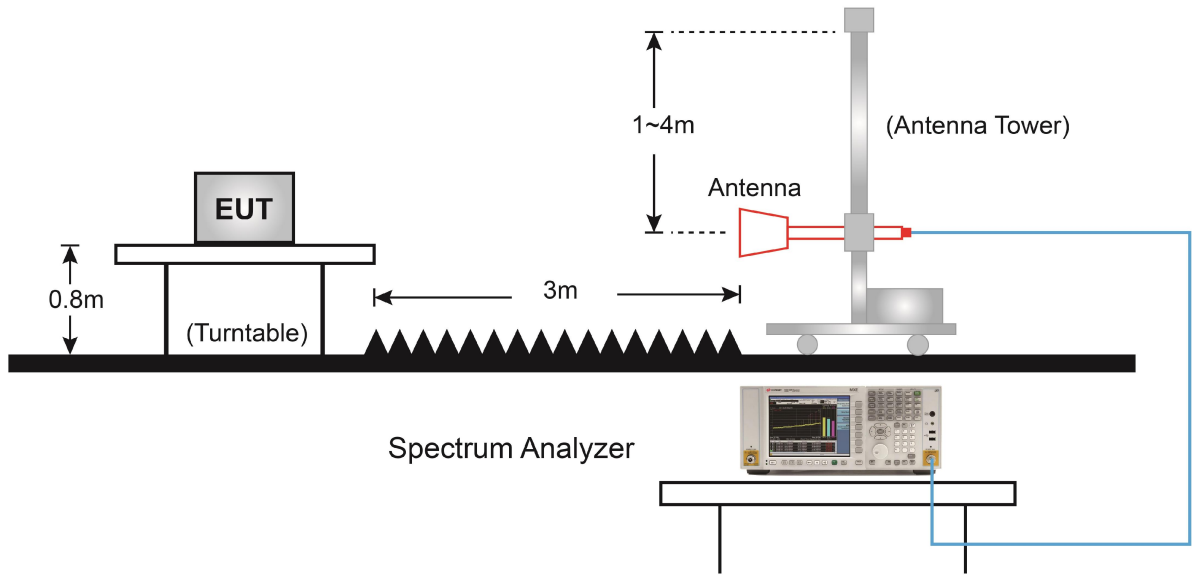

Above 40GHz Test Setup:

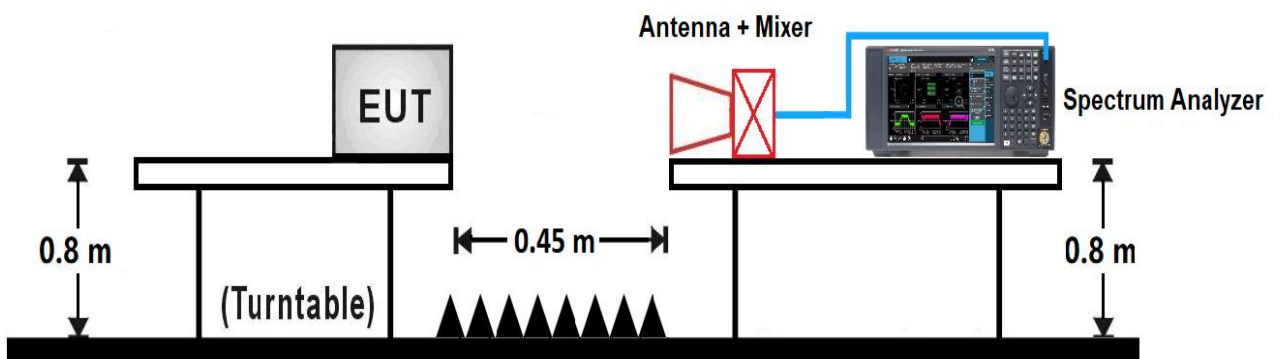

**6.4.5. Test Results**

Product	Millimeter wave radar	Temperature	23°C
Test Engineer	Messiah Li	Relative Humidity	54%
Test Site	AC1	Test Date	2020/03/28
Remark	Below 1GHz		

Frequency (MHz)	Reading Level (dBμV)	Factor (dB)	Measure Level (dBμV/m)	Limit (dBμV/m)	Margin (dB)	Detector	Polarization
38.7	8.2	14.4	22.6	40.0	-17.4	QP	Horizontal
57.6	4.3	13.6	17.9	40.0	-22.1	QP	Horizontal
168.7	14.3	14.5	28.8	43.5	-14.7	QP	Horizontal
253.1	16.3	13.0	29.3	46.0	-16.7	QP	Horizontal
361.7	13.3	15.8	29.1	46.0	-16.9	QP	Horizontal
550.4	11.3	19.6	30.9	46.0	-15.1	QP	Horizontal
38.7	17.9	14.4	32.3	40.0	-7.7	QP	Vertical
57.6	19.5	13.6	33.1	40.0	-6.9	QP	Vertical
60.1	19.4	13.4	32.8	40.0	-7.2	QP	Vertical
168.3	17.3	14.5	31.8	43.5	-11.7	QP	Vertical
253.1	17.5	13.0	30.5	46.0	-15.5	QP	Vertical
598.9	9.0	20.6	29.6	46.0	-16.4	QP	Vertical

**Note:**

1. Measure Level (dBμV/m) = Reading Level (dBμV) + Factor (dB)

Factor (dB) = Cable Loss (dB) + Antenna Factor (dB/m)

2. The amplitude of radiated emissions (frequency range from 9KHz to 30MHz) is that proximity to ambient noise, which also are attenuated more than 20 dB below the permissible value. Therefore, the data is not presented in the report.

Product	Millimeter wave radar	Temperature	23°C
Test Engineer	Messiah Li	Relative Humidity	54%
Test Site	AC1	Test Date	2020/03/29
Remark	1 ~ 40GHz		

Frequency (MHz)	Reading Level (dBμV)	Factor (dB)	Measure Level (dBμV/m)	Limit (dBμV/m)	Margin (dB)	Detector	Polarization
3779.5	37.6	2.8	40.4	74.0	-33.6	Peak	Horizontal
4961.0	38.0	6.2	44.2	74.0	-29.8	Peak	Horizontal
5751.5	37.0	7.4	44.4	74.0	-29.6	Peak	Horizontal
6652.5	36.4	9.7	46.1	74.0	-27.9	Peak	Horizontal
35243.5	37.0	16.3	53.3	74.0	-20.7	Peak	Horizontal
3881.5	37.5	3.0	40.5	74.0	-33.5	Peak	Vertical
5071.5	36.4	6.7	43.1	74.0	-30.9	Peak	Vertical
5845.0	35.7	7.7	43.4	74.0	-30.6	Peak	Vertical
7111.5	36.6	11.3	47.9	74.0	-26.1	Peak	Vertical
35213.8	36.5	16.4	52.9	74.0	-21.1	Peak	Vertical

Note:

1. Measure Level (dBμV/m) = Reading Level (dBμV) + Factor (dB)

Factor (dB) = Cable Loss (dB) + Antenna Factor (dB/m) - Pre\_Amplifier Gain (dB)

2. Average measurement was not performed when the peak level lower than average limit

Product	Millimeter wave radar	Temperature	23°C
Test Engineer	Vincent Yu	Relative Humidity	54%
Test Site	AC1	Test Date	2020/03/30
Test Range	Above 40GHz		

Frequency (GHz)	Reading Level @0.45m (dBμV)	Factor (dB)	Measure Level @0.45m (dBμV/m)	Measure Level @3m (dBμV/m)	Power Density (pW/cm <sup>2</sup> )	Limit (pW/cm <sup>2</sup> )	Result
40GHz ~ 231GHz							
47.741	42.80	45.73	88.53	72.1	4.3	600	Pass
60.253	35.50	41.46	76.96	60.5	0.3	600	Pass
75.923	37.75	44.01	81.76	65.3	0.9	600	Pass
85.786	39.17	44.28	83.45	67.0	1.3	600	Pass
117.284	15.22	57.80	73.02	56.5	0.1	600	Pass
165.228	15.70	59.74	75.44	59.0	0.2	600	Pass
208.215	15.94	60.57	76.51	60.0	0.3	1000	Pass

**Note:**

- Measure Level @0.45m = Reading Level @0.45m + Factor  
Factor (dB) = Cable Loss (dB) + Antenna Factor (dB/m) + Mixer Conversion Loss (dB)
- Measure Level @3m = Measure Level @0.45m + 20 \* log(0.45m / 3m)
- Power Density =  $(10^8 / 377) * \{10^{[(\text{Measure Level @3m} - 120) / 20]}\}^2$



## **6.5. Frequency Stability**

### **6.5.1. Test Limit**

Fundamental emissions must be contained within the frequency bands 76 - 81GHz during all conditions of operation. Equipment is presumed to operate over the temperature range -20 to +50 degrees Celsius with an input voltage variation of 85% to 115% of rated input voltage, unless justification is presented to demonstrate otherwise.

### **6.5.2. Test Procedure used**

ANSI C63.10 Section 9.14

### **6.5.3. Test Procedure**

1. Arrange EUT and test equipment according Section 6.5.4.
2. With the EUT at ambient temperature (20 °C) and voltage source set to the EUT nominal operating voltage (12VDC, 100%)
3. RBW = 1MHz, VBW = 3MHz
4. Detector = Peak
5. Trace Mode = Max Hold
6. Record the Low and high frequencies ( $f_L$  and  $f_H$ ) of the fundamental frequency emission. The applicable spurious emissions limit  $600\text{pW}/\text{cm}^2$  (-1.61dBm) was used to define  $f_L$  and  $f_H$ .
7. Vary EUT power supply between 85% (10.2VDC) and 115% (13.8VDC) of nominal, record the  $f_L$  and  $f_H$ .
8. Set the power supply to 100% nominal setting, and raise EUT operating temperature to 50 °C.
9. Record the  $f_L$  and  $f_H$  of the fundamental frequency emission.
10. Repeat step 9 at each 10°C increment down to -20 °C.

### 6.5.4. Test Setup

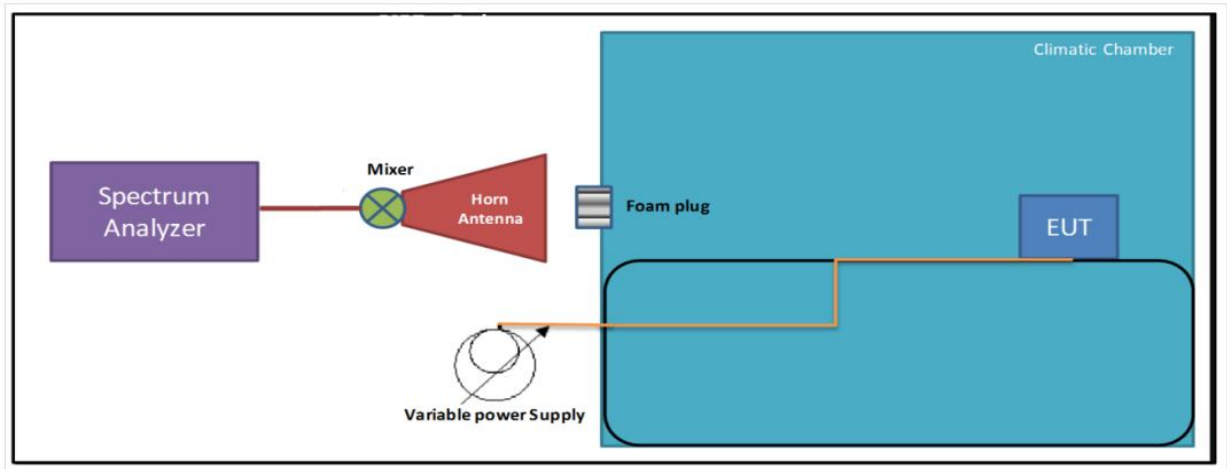

**6.5.5. Test Result**

Test Engineer	Vincent Yu	Temperature	-20 ~ 50°C
Test Time	2020/03/28	Relative Humidity	52%RH
Test Mode	Mode 1	Test Site	TR3

Voltage (%)	Power (VDC)	Temp (°C)	f <sub>L</sub> (GHz)	f <sub>H</sub> (GHz)	Limit (GHz)	Result
100%	12.0	- 20	77.3840	80.2918	76 ~ 81	Pass
		- 10	77.3840	80.2928	76 ~ 81	Pass
		0	77.3840	80.2928	76 ~ 81	Pass
		+ 10	77.3840	80.2928	76 ~ 81	Pass
		+ 20 (Ref)	77.3840	80.2923	76 ~ 81	Pass
		+ 30	77.3840	80.2938	76 ~ 81	Pass
		+ 40	77.3840	80.2928	76 ~ 81	Pass
		+ 50	77.3830	80.2928	76 ~ 81	Pass
115%	13.8	+ 20	77.3830	80.2948	76 ~ 81	Pass
85%	10.2	+ 20	77.3840	80.2928	76 ~ 81	Pass

## 7. CONCLUSION

The data collected relate only the item(s) tested and show that this device is in compliance with Part 95M of the FCC Rules.

\_\_\_\_\_ The End \_\_\_\_\_

## **Appendix A - Test Setup Photograph**

Refer to "2009RSU016-UT" file.

## **Appendix B - EUT Photograph**

Refer to "2009RSU016-UE" file.