



# FCC RF Test Report

**APPLICANT** : FairPhone B.V.  
**EQUIPMENT** : Fairphone (Gen.6)  
**BRAND NAME** : Fairphone  
**MODEL NAME** : FP6  
**FCC ID** : 2AUWUFP6  
**STANDARD** : 47 CFR Part 24(E), 27(L)  
**CLASSIFICATION** : PCS Licensed Transmitter Held to Ear (PCE)  
**TEST DATE(S)** : Apr. 25, 2025 ~ May 29, 2025

We, Sporton International Inc. (Kunshan), would like to declare that the tested sample has been evaluated in accordance with the procedures given in ANSI C63.26-2015 and shown compliance with the applicable technical standards.

The test results in this report apply exclusively to the tested model / sample. Without written approval of Sporton International Inc. (Kunshan), the test report shall not be reproduced except in full.

Jason Jia

Approved by: Jason Jia



**Sporton International Inc. (Kunshan)**

**No. 1098, Pengxi North Road, Kunshan Economic Development Zone Jiangsu Province 215300  
People's Republic of China**



TABLE OF CONTENTS

REVISION HISTORY... 3
SUMMARY OF TEST RESULT ... 4
1 GENERAL DESCRIPTION ... 5
1.1 Applicant ... 5
1.2 Manufacturer ... 5
1.3 Product Feature of Equipment Under Test ... 5
1.4 Product Specification of Equipment Under Test ... 6
1.5 Modification of EUT ... 6
1.6 Maximum ERP/EIRP Power and Emission Designator ... 6
1.7 Testing Location ... 8
1.8 Test Software ... 8
1.9 Applicable Standards ... 8
2 TEST CONFIGURATION OF EQUIPMENT UNDER TEST ... 9
2.1 Test Mode ... 9
2.2 Connection Diagram of Test System ... 10
2.3 Support Unit used in test configuration and system ... 10
2.4 Measurement Results Explanation Example ... 10
2.5 Frequency List of Low/Middle/High Channels ... 11
3 CONDUCTED TEST ITEMS ... 13
3.1 Measuring Instruments ... 13
3.2 Test Setup ... 13
3.3 Test Result of Conducted Test ... 13
3.4 Conducted Output Power and ERP/EIRP ... 14
3.5 Peak-to-Average Ratio ... 15
3.6 Occupied Bandwidth ... 16
3.7 Conducted Band Edge ... 17
3.8 Conducted Spurious Emission ... 18
3.9 Frequency Stability ... 19
4 RADIATED TEST ITEMS ... 20
4.1 Measuring Instruments ... 20
4.2 Test Setup ... 20
4.3 Test Result of Radiated Test ... 21
4.4 Radiated Spurious Emission ... 22
5 LIST OF MEASURING EQUIPMENT ... 23
6 MEASUREMENT UNCERTAINTY ... 24
APPENDIX A. TEST RESULTS OF CONDUCTED TEST
APPENDIX B. TEST RESULTS OF RADIATED TEST
APPENDIX C. TEST SETUP PHOTOGRAPHS



### REVISION HISTORY

REPORT NO.	VERSION	DESCRIPTION	ISSUED DATE
FG521107-01B	Rev. 01	Initial issue of report	Jul. 25, 2025



### SUMMARY OF TEST RESULT

Report Section	FCC Rule	Description	Limit	Result	Remark
3.4	§2.1046	Conducted Output Power	-	Report Only	-
	§24.232(c) §27.50(h)(2)	Equivalent Isotropic Radiated Power (Band 2) (Band 25)	EIRP < 2Watt	PASS	-
	§27.50(d)(4)	Equivalent Isotropic Radiated Power (Band 4) (Band 66)	EIRP < 1Watt		-
3.5	§24.232(d)	Peak-to-Average Ratio	<13 dB	PASS	-
3.6	§2.1049	Occupied Bandwidth	-	Report Only	-
3.7	§2.1051 §24.238(a) §27.53(c)(2)(4) §27.53(g) §27.53(h)	Conducted Band Edge Measurement (Band 2) (Band 4) (Band 25) (Band 66)	< 43+10log10(P[Watts])	PASS	-
3.8	§2.1051 §24.238(a) §27.53(c)(2) §27.53(g) §27.53(h)	Conducted Spurious Emission (Band 2) (Band 4) (Band 25) (Band 66)	< 43+10log10(P[Watts])	PASS	-
3.9	§2.1055 §24.235 §27.54	Frequency Stability Temperature & Voltage	Within Authorized Band	PASS	-
4.4	§2.1053 §24.238(a) §27.53(c)(2) §27.53(f) §27.53(g) §27.53(h)	Radiated Spurious Emission (Band 2) (Band 4) (Band 25) (Band 66)	< 43+10log <sub>10</sub> (P[Watts])	PASS	Under limit 39.98 dB at 7500.00 MHz

**Conformity Assessment Condition:**

- The test results (PASS/FAIL) with all measurement uncertainty excluded are presented against the regulation limits or in accordance with the requirements stipulated by the applicant/manufacturer who shall bear all the risks of non-compliance that may potentially occur if measurement uncertainty is taken into account.
- The measurement uncertainty please refer to each test result in the section "Measurement Uncertainty"

**Disclaimer:**

The product specifications of the EUT presented in the test report that may affect the test assessments are declared by the manufacturer who shall take full responsibility for the authenticity.



# 1 General Description

## 1.1 Applicant

FairPhone B.V.

Van Diemenstraat 200, 1013 CP,Amsterdam, The Netherlands

## 1.2 Manufacturer

FairPhone B.V.

Van Diemenstraat 200, 1013 CP,Amsterdam, The Netherlands

## 1.3 Product Feature of Equipment Under Test

Product Feature	
Equipment	Fairphone (Gen.6)
Brand Name	Fairphone
Model Name	FP6
FCC ID	2AUWUFP6
IMEI Code	Conducted: 355870094594675/355870094594601 355870094594667/355870094594601 Radiation: 355870094596159
HW Version	DVT2
SW Version	FP6.DEV.15.66.0
EUT Stage	Identical Prototype



### 1.4 Product Specification of Equipment Under Test

Standards-related Product Specification	
<b>Tx Frequency</b>	LTE Band 2 : 1850 MHz ~ 1910 MHz LTE Band 4 : 1710 MHz ~ 1755 MHz LTE Band 25 : 1850 MHz ~ 1915 MHz LTE Band 66 : 1710 MHz ~ 1780 MHz
<b>Rx Frequency</b>	LTE Band 2 : 1930 MHz ~ 1990 MHz LTE Band 4 : 2110 MHz ~ 2155 MHz LTE Band 25 : 1930 MHz ~ 1995 MHz LTE Band 66 : 2110 MHz~ 2180 MHz
<b>Bandwidth</b>	LTE Band 2 : 1.4MHz / 3MHz / 5MHz / 10MHz / 15MHz / 20MHz LTE Band 4 : 1.4MHz / 3MHz / 5MHz / 10MHz / 15MHz / 20MHz LTE Band 25 : 1.4MHz / 3MHz / 5MHz / 10MHz / 15MHz / 20MHz LTE Band 66 : 1.4MHz / 3MHz / 5MHz / 10MHz / 15MHz / 20MHz
<b>Maximum Output Power to Antenna</b>	LTE Band 2 : 22.92 dBm LTE Band 4 : 23.04 dBm LTE Band 25 : 22.99 dBm LTE Band 66 : 23.09 dBm
<b>Antenna Gain</b>	<ANT2>: LTE Band 2 : -0.4 dBi LTE Band 4 : -1.3 dBi LTE Band 25 : -0.4 dBi LTE Band 66 : -1.3 dBi
<b>Type of Modulation</b>	QPSK / 16QAM / 64QAM / 256QAM

### 1.5 Modification of EUT

No modifications are made to the EUT during all test items.

### 1.6 Maximum EIRP Power and Emission Designator

LTE Band 2		QPSK		16QAM/64QAM/256QAM	
BW (MHz)	Frequency Range (MHz)	Maximum EIRP(W)	Emission Designator (99%OBW)	Maximum EIRP(W)	Emission Designator (99%OBW)
1.4	1850.7 ~ 1909.3	0.1758	1M10G7D	0.1406	1M10W7D
3	1851.5 ~ 1908.5	0.1762	2M72G7D	0.1400	2M73W7D
5	1852.5 ~ 1907.5	0.1734	4M51G7D	0.1390	4M54W7D
10	1855.0 ~ 1905.0	0.1762	9M05G7D	0.1409	9M01W7D
15	1857.5 ~ 1902.5	0.1774	13M5G7D	0.1403	13M5W7D
20	1860.0 ~ 1900.0	0.1786	17M9G7D	0.1422	17M9W7D



LTE Band 25		QPSK		16QAM/64QAM/256QAM	
BW (MHz)	Frequency Range (MHz)	Maximum EIRP(W)	Emission Designator (99%OBW)	Maximum EIRP(W)	Emission Designator (99%OBW)
1.4	1850.7 ~ 1914.3	0.1710	1M10G7D	0.1365	1M10W7D
3	1851.5 ~ 1913.5	0.1722	2M72G7D	0.1368	2M73W7D
5	1852.5 ~ 1912.5	0.1698	4M51G7D	0.1384	4M54W7D
10	1855.0 ~ 1910.0	0.1738	9M05G7D	0.1384	9M01W7D
15	1857.5 ~ 1907.5	0.1726	13M5G7D	0.1380	13M5W7D
20	1860.0 ~ 1905.0	0.1816	17M9G7D	0.1439	17M9W7D
LTE Band 4		QPSK		16QAM/64QAM/256QAM	
BW (MHz)	Frequency Range (MHz)	Maximum EIRP(W)	Emission Designator (99%OBW)	Maximum EIRP(W)	Emission Designator (99%OBW)
1.4	1710.7 ~ 1754.3	0.1476	1M09G7D	0.1167	1M10W7D
3	1711.5 ~ 1753.5	0.1472	2M75G7D	0.1180	2M73W7D
5	1712.5 ~ 1752.5	0.1466	4M47G7D	0.1153	4M51W7D
10	1715.0 ~ 1750.0	0.1483	9M01G7D	0.1156	9M01W7D
15	1717.5 ~ 1747.5	0.1483	13M5G7D	0.1148	13M5W7D
20	1720.0 ~ 1745.0	0.1493	17M9G7D	0.1186	17M9W7D
LTE Band 66		QPSK		16QAM/64QAM/256QAM	
BW (MHz)	Frequency Range (MHz)	Maximum EIRP(W)	Emission Designator (99%OBW)	Maximum EIRP(W)	Emission Designator (99%OBW)
1.4	1710.7 ~ 1779.3	0.1486	1M09G7D	0.1169	1M10W7D
3	1711.5 ~ 1778.5	0.1469	2M75G7D	0.1172	2M73W7D
5	1712.5 ~ 1777.5	0.1466	4M47G7D	0.1169	4M51W7D
10	1715.0 ~ 1775.0	0.1503	9M01G7D	0.1161	9M01W7D
15	1717.5 ~ 1772.5	0.1486	13M5G7D	0.1159	13M5W7D
20	1720.0 ~ 1770.0	0.1510	17M9G7D	0.1180	17M9W7D

Note:

1. LTE Band 66 overlaps the entire frequency range of LTE Band 4. Therefore, the test results provided in this report covers Band 66 as well as Band 4.
2. LTE Band 25 overlaps the entire frequency range of LTE Band 2. Therefore, the test results provided in this report covers Band 25 as well as Band 2.
3. All modulations have been tested, and only the worst test results of PSK & QAM are shown in the report.



### 1.7 Testing Location

Sporton International Inc. (Kunshan) is accredited to ISO/IEC 17025:2017 by American Association for Laboratory Accreditation with Certificate Number 5145.02.

<b>Test Firm</b>	Sporton International Inc. (Kunshan)		
<b>Test Site Location</b>	No. 1098, Pengxi North Road, Kunshan Economic Development Zone Jiangsu Province 215300 People's Republic of China TEL : +86-512-57900158		
<b>Test Site No.</b>	<b>Sporton Site No.</b>	<b>FCC Designation No.</b>	<b>FCC Test Firm Registration No.</b>
	03CH04-KS TH01-KS	CN1257	314309

### 1.8 Test Software

Item	Site	Manufacture	Name	Version
1.	TH01-KS	SPORTON	FCC LTE_Ver2.0 Auto_china_210503	2.0
2.	03CH04-KS	AUDIX	E3	210616

### 1.9 Applicable Standards

According to the specifications of the manufacturer, the EUT must comply with the requirements of the following standards:

- ♦ 47 CFR Part 24(E), 27(L)
- ♦ ANSI C63.26-2015
- ♦ FCC KDB 971168 D01 Power Meas License Digital Systems v03r01
- ♦ FCC KDB 412172 D01 Determining ERP and EIRP v01r01

**Remark:**

1. All test items were verified and recorded according to the standards and without any deviation during the test.
2. This EUT has also been tested and complied with the requirements of FCC Part 15, Subpart B, recorded in a separate test report.





## 2 Test Configuration of Equipment Under Test

### 2.1 Test Mode

Antenna port conducted and radiated test items listed below are performed according to KDB 971168 D01 Power Meas License Digital Systems v03r01 with maximum output power.

Radiated measurements are performed by rotating the EUT in three different orthogonal test planes to find the maximum emission.

Test Items	Band	Bandwidth (MHz)						Modulation				RB #			Test Channel			
		1.4	3	5	10	15	20	QPSK	16QA M	64QA M	256 QAM	1	Half	Full	L	M	H	
Max. Output Power	2	v	v	v	v	v	v	v	v	v	v	v	v	v	v	v	v	
	4	v	v	v	v	v	v	v	v	v	v	v	v	v	v	v	v	
	25	v	v	v	v	v	v	v	v	v	v	v	v	v	v	v	v	
	66	v	v	v	v	v	v	v	v	v	v	v	v	v	v	v	v	
Peak-to-Average Ratio	25						v	v	v	v	v			v		v		
	66						v	v	v	v	v			v		v		
26dB and 99% Bandwidth	25	v	v	v	v	v	v	v	v					v		v		
	66	v	v	v	v	v	v	v	v					v		v		
Conducted Band Edge	25	v	v	v	v	v	v	v	v	v	v	v		v	v		v	
	66	v	v	v	v	v	v	v	v	v	v	v		v	v		v	
Conducted Spurious Emission	25	v	v	v	v	v	v	v				v			v	v	v	
	66	v	v	v	v	v	v	v				v			v	v	v	
Frequency Stability	25				v			v						v		v		
	66				v			v						v		v		
E.I.R.P.	2	v	v	v	v	v	v	v	v	v	v	v	v	v	v	v	v	
	4	v	v	v	v	v	v	v	v	v	v	v	v	v	v	v	v	
	25	v	v	v	v	v	v	v	v	v	v	v	v	v	v	v	v	
	66	v	v	v	v	v	v	v	v	v	v	v	v	v	v	v	v	
Radiated Spurious Emission	25	Worst Case															v	
	66	Worst Case															v	
Note	<ol style="list-style-type: none"> <li>The mark "v" means that this configuration is chosen for testing</li> <li>The mark "-" means that this bandwidth is not supported.</li> <li>The device is investigated from 30MHz to 10 times of fundamental signal for radiated spurious emission test under different RB size/offset and modulations in exploratory test. Subsequently, only the worst case emissions are reported.</li> </ol>																	

## 2.2 Connection Diagram of Test System

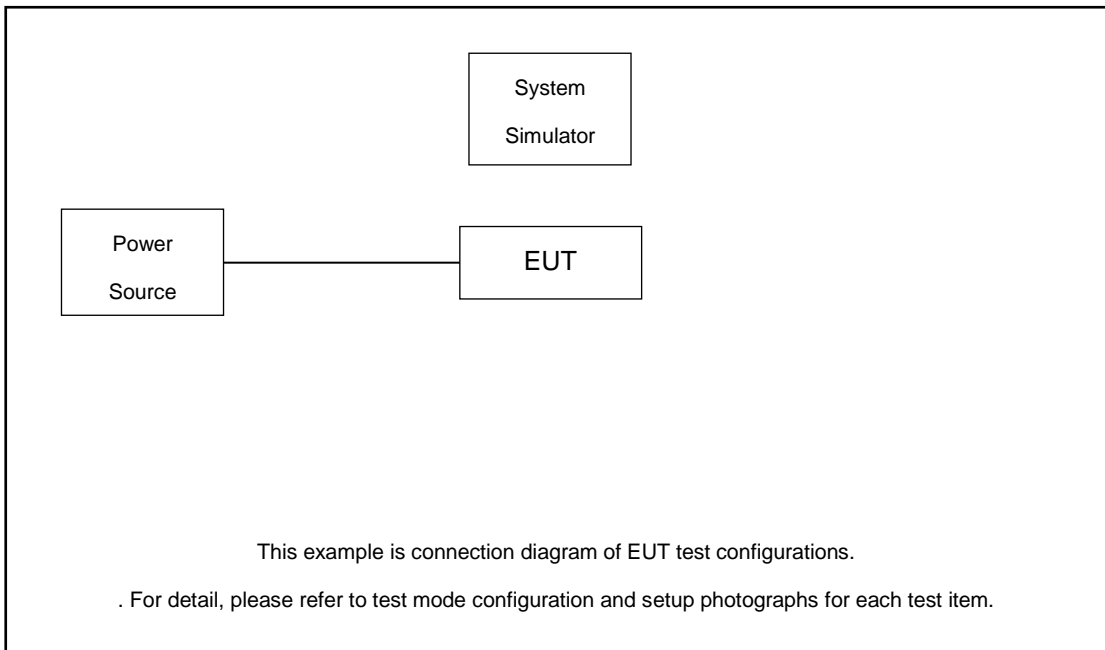

## 2.3 Support Unit used in test configuration and system

Item	Equipment	Trade Name	Model No.	FCC ID	Data Cable	Power Cord
1.	Power Supply	GWINSTEK	PSS-2002	N/A	N/A	Unshielded, 1.8 m
2.	LTE Base Station	Anritsu	MT8820C	N/A	N/A	Unshielded, 1.8 m
3.	Adapter	Fairphone B.V	N/A	N/A	N/A	N/A
4.	USB Cable	Fairphone B.V	N/A	N/A	N/A	N/A

## 2.4 Measurement Results Explanation Example

### For all conducted test items:

The offset level is set in the spectrum analyzer to compensate the RF cable loss and attenuator factor between EUT conducted output port and spectrum analyzer. With the offset compensation, the spectrum analyzer reading level is exactly the EUT RF output level.

The spectrum analyzer offset is derived from RF cable loss.

*Offset = RF cable loss.*

Following shows an offset computation example with cable loss 5.6 dB.

Example :

*Offset(dB) = RF cable loss(dB).*



= 5.6 (dB)

### 2.5 Frequency List of Low/Middle/High Channels

LTE Band 2 Channel and Frequency List				
BW [MHz]	Channel/Frequency(MHz)	Lowest	Middle	Highest
20	Channel	18700	18900	19100
	Frequency	1860	1880	1900
15	Channel	18675	18900	19125
	Frequency	1857.5	1880	1902.5
10	Channel	18650	18900	19150
	Frequency	1855	1880	1905
5	Channel	18625	18900	19175
	Frequency	1852.5	1880	1907.5
3	Channel	18615	18900	19185
	Frequency	1851.5	1880	1908.5
1.4	Channel	18607	18900	19193
	Frequency	1850.7	1880	1909.3

LTE Band 4 Channel and Frequency List				
BW [MHz]	Channel/Frequency(MHz)	Lowest	Middle	Highest
20	Channel	20050	20175	20300
	Frequency	1720	1732.5	1745
15	Channel	20025	20175	20325
	Frequency	1717.5	1732.5	1747.5
10	Channel	20000	20175	20350
	Frequency	1715	1732.5	1750
5	Channel	19975	20175	20375
	Frequency	1712.5	1732.5	1752.5
3	Channel	19965	20175	20385
	Frequency	1711.5	1732.5	1753.5
1.4	Channel	19957	20175	20393
	Frequency	1710.7	1732.5	1754.3



LTE Band 25 Channel and Frequency List				
BW [MHz]	Channel/Frequency(MHz)	Lowest	Middle	Highest
20	Channel	26140	26340	26590
	Frequency	1860	1880	1905
15	Channel	26115	26340	26615
	Frequency	1857.5	1880	1907.5
10	Channel	26090	26340	26640
	Frequency	1855	1880	1910
5	Channel	26065	26340	26665
	Frequency	1852.5	1880	1912.5
3	Channel	26055	26340	26675
	Frequency	1851.5	1880	1913.5
1.4	Channel	26047	26340	26683
	Frequency	1850.7	1880	1914.3

LTE Band 66 Channel and Frequency List				
BW [MHz]	Channel/Frequency(MHz)	Lowest	Middle	Highest
20	Channel	132072	132322	132572
	Frequency	1720	1745	1770
15	Channel	132047	132322	132597
	Frequency	1717.5	1745	1772.5
10	Channel	132022	132322	132622
	Frequency	1715	1745	1775
5	Channel	131997	132322	132647
	Frequency	1712.5	1745	1777.5
3	Channel	131987	132322	132657
	Frequency	1711.5	1745	1778.5
1.4	Channel	131979	132322	132665
	Frequency	1710.7	1745	1779.3

### 3 Conducted Test Items

#### 3.1 Measuring Instruments

See list of measuring instruments of this test report.

#### 3.2 Test Setup

##### 3.2.1 Conducted Output Power

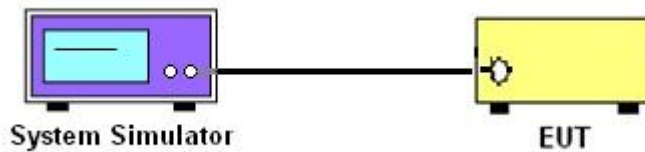

##### 3.2.2 Peak-to-Average Ratio, Occupied Bandwidth ,Conducted Band-Edge and Conducted Spurious Emission



##### 3.2.3 Frequency Stability

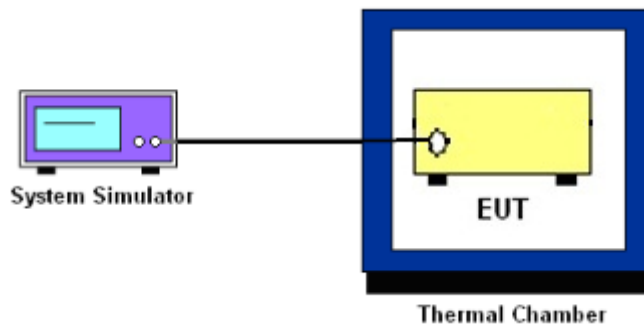

### 3.3 Test Result of Conducted Test

Please refer to Appendix A.



### 3.4 Conducted Output Power and ERP/EIRP

#### 3.4.1 Description of the Conducted Output Power Measurement and ERP/EIRP Measurement

A system simulator was used to establish communication with the EUT. Its parameters were set to force the EUT transmitting at maximum output power. The measured power in the radio frequency on the transmitter output terminals shall be reported.

The EIRP of mobile transmitters must not exceed 2 Watts for LTE Band 2 and Band 25.

The EIRP of mobile transmitters must not exceed 1 Watts for LTE Band 4 and Band 66.

According to KDB 412172 D01 Power Approach,

$EIRP = P_T + G_T - L_C$ ,  $ERP = EIRP - 2.15$ , where

$P_T$  = transmitter output power in dBm

$G_T$  = gain of the transmitting antenna in dBi

$L_C$  = signal attenuation in the connecting cable between the transmitter and antenna in dB

#### 3.4.2 Test Procedures

1. The testing follows ANSI C63.26 Section 5.2
2. The transmitter output port was connected to the system simulator.
3. Set EUT at maximum power through the system simulator.
4. Select lowest, middle, and highest channels for each band and different modulation.
5. Measure and record the power level from the system simulator.



## **3.5 Peak-to-Average Ratio**

### **3.5.1 Description of the PAR Measurement**

Power Complementary Cumulative Distribution Function (CCDF) curves provide a means for characterizing the power peaks of a digitally modulated signal on a statistical basis. A CCDF curve depicts the probability of the peak signal amplitude exceeding the average power level. Most contemporary measurement instrumentation include the capability to produce CCDF curves for an input signal provided that the instrument's resolution bandwidth can be set wide enough to accommodate the entire input signal bandwidth. In measuring transmissions in this band using an average power technique, the peak-to-average ratio (PAR) of the transmission may not exceed 13 dB.

### **3.5.2 Test Procedures**

1. The testing follows ANSI C63.26 Section 5.2.3.4 (CCDF).
2. The EUT was connected to spectrum and system simulator via a power divider.
3. Set the CCDF (Complementary Cumulative Distribution Function) option in spectrum analyzer.
4. The highest RF powers were measured and recorded the maximum PAPR level associated with a probability of 0.1 %.
5. Record the deviation as Peak to Average Ratio.



### 3.6 Occupied Bandwidth

#### 3.6.1 Description of Occupied Bandwidth Measurement

The occupied bandwidth is the width of a frequency band such that, below the lower and above the upper frequency limits, the mean powers emitted are each equal to a specified percentage 0.5% of the total mean transmitted power.

The 26 dB emission bandwidth is defined as the frequency range between two points, one above and one below the carrier frequency, at which the spectral density of the emission is attenuated 26 dB below the maximum in-band spectral density of the modulated signal. Spectral density (power per unit bandwidth) is to be measured with a detector of resolution bandwidth equal to approximately 1.0% of the emission bandwidth.

#### 3.6.2 Test Procedures

1. The testing follows ANSI C63.26 Section 5.4
2. The EUT was connected to spectrum analyzer and system simulator via a power divider.
3. The spectrum analyzer center frequency is set to the nominal EUT channel center frequency. The span range for the spectrum analyzer shall be between two and five times the anticipated OBW.
4. The nominal resolution bandwidth (RBW) shall be in the range of 1 to 5 % of the anticipated OBW, and the VBW shall be at least 3 times the RBW.
5. Set the detection mode to peak, and the trace mode to max hold.
6. Determine the reference value: Set the EUT to transmit a modulated signal. Allow the trace to stabilize. Set the spectrum analyzer marker to the highest level of the displayed trace.  
(this is the reference value)
7. Determine the “-26 dB down amplitude” as equal to (Reference Value – X).
8. Place two markers, one at the lowest and the other at the highest frequency of the envelope of the spectral display such that each marker is at or slightly below the “-X dB down amplitude” determined in step 6. If a marker is below this “-X dB down amplitude” value it shall be placed as close as possible to this value. The OBW is the positive frequency difference between the two markers.
9. Use the 99 % power bandwidth function of the spectrum analyzer and report the measured bandwidth.





### 3.7 Conducted Band Edge

#### 3.7.1 Description of Conducted Band Edge Measurement

24.238 (a)

For operations in the 1850-1910 and 1930-1990 MHz band, the FCC limit is  $43 + 10\log_{10}(P[\text{Watts}])$  dB below the transmitter power  $P(\text{Watts})$  in a 1MHz bandwidth. However, in the 1 MHz bands immediately outside and adjacent to the frequency block a resolution bandwidth of at least one percent of the emission bandwidth of the fundamental emission of the transmitter may be employed.

27.53 (h)

For operations in the 1710 – 1755 MHz band, the FCC limit is  $43 + 10\log_{10}(P[\text{Watts}])$  dB below the transmitter power  $P(\text{Watts})$  in a 1 MHz bandwidth. However, in the 1MHz bands immediately outside and adjacent to the licensee's frequency block, a resolution bandwidth of at least one percent of the emission bandwidth of the fundamental emission of the transmitter may be employed.

#### 3.7.2 Test Procedures

1. The testing follows ANSI C63.26 section 5.7
1. The EUT was connected to spectrum analyzer and system simulator via a power divider.
2. The band edges of low and high channels for the highest RF powers were measured.
3. Set RBW  $\geq$  1% EBW in the 1MHz band immediately outside and adjacent to the band edge.
4. Beyond the 1 MHz band from the band edge, RBW=1MHz was used.
5. Set spectrum analyzer with RMS detector.
6. The RF fundamental frequency should be excluded against the limit line in the operating frequency band.
7. Checked that all the results comply with the emission limit line.

Example:

$$\begin{aligned} & \text{The limit line is derived from } 43 + 10\log(P)\text{dB below the transmitter power } P(\text{Watts}) \\ & = P(\text{W}) - [43 + 10\log(P)] \text{ (dB)} \\ & = [30 + 10\log(P)] \text{ (dBm)} - [43 + 10\log(P)] \text{ (dB)} = -13\text{dBm}. \end{aligned}$$

8. When using the integration method, the starting frequency of the integration shall be centered at one-half of the RBW away from the band edge.



### 3.8 Conducted Spurious Emission

#### 3.8.1 Description of Conducted Spurious Emission Measurement

The power of any emission outside of the authorized operating frequency ranges must be lower than the transmitter power (P) by a factor of at least  $43 + 10 \log (P)$  dB.

It is measured by means of a calibrated spectrum analyzer and scanned from 30 MHz up to a frequency including its 10<sup>th</sup> harmonic.

#### 3.8.2 Test Procedures

1. The testing follows ANSI C63.26 section 5.7
2. The EUT was connected to spectrum analyzer and system simulator via a power divider.
3. The RF output of EUT was connected to the spectrum analyzer by RF cable and attenuator. The path loss was compensated to the results for each measurement.
4. The middle channel for the highest RF power within the transmitting frequency was measured.
5. The conducted spurious emission for the whole frequency range was taken.
6. Make the measurement with the spectrum analyzer's RBW = 1MHz, VBW = 3MHz.
7. Set spectrum analyzer with RMS detector.
8. Taking the record of maximum spurious emission.
9. The RF fundamental frequency should be excluded against the limit line in the operating frequency band.
10. The limit line is derived from  $43 + 10\log(P)$ dB below the transmitter power P(Watts)  
= P(W)- [43 + 10log(P)] (dB)  
= [30 + 10log(P)] (dBm) - [43 + 10log(P)] (dB)  
= -13dBm.



## 3.9 Frequency Stability

### 3.9.1 Description of Frequency Stability Measurement

The frequency stability shall be measured by variation of ambient temperature and variation of primary supply voltage to ensure that the fundamental emission stays within the authorized frequency block..

### 3.9.2 Test Procedures for Temperature Variation

1. The testing follows ANSI C63.26 section 5.6.4
2. The EUT was set up in the thermal chamber and connected with the system simulator.
3. With power OFF, the temperature was decreased to -30°C and the EUT was stabilized before testing. Power was applied and the maximum change in frequency was recorded within one minute.
4. With power OFF, the temperature was raised in 10°C step up to 50°C. The EUT was stabilized at each step for at least half an hour. Power was applied and the maximum frequency change was recorded within one minute.

### 3.9.3 Test Procedures for Voltage Variation

1. The testing follows ANSI C63.26 section 5.6.5
2. The EUT was placed in a temperature chamber at 20±5°C and connected with the system simulator.
3. The power supply voltage to the EUT was varied from 85% to 115% of the nominal value for other than hand carried battery equipment.
4. For hand carried, battery powered equipment, reduce the primary ac or dc supply voltage to the battery operating end point, which shall be specified by the manufacturer.
5. The variation in frequency was measured for the worst case.

## 4 Radiated Test Items

### 4.1 Measuring Instruments

See list of measuring instruments of this test report.

### 4.2 Test Setup

#### 4.2.1 For radiated test below 30MHz

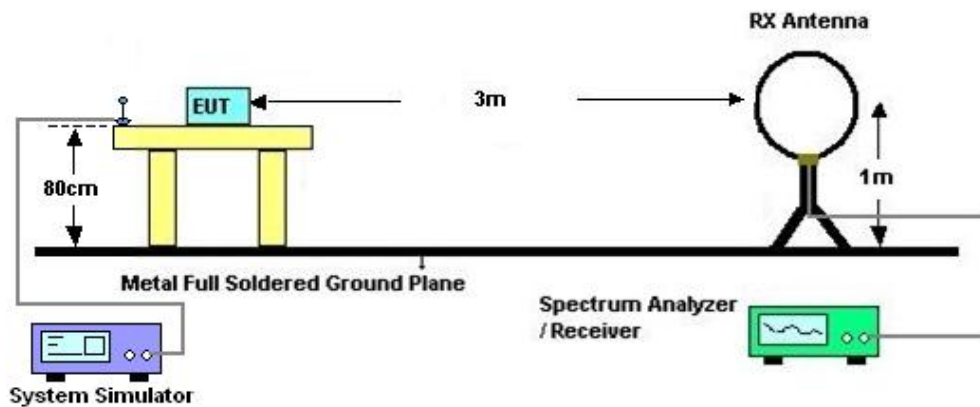

#### 4.2.2 For radiated test from 30MHz to 1GHz

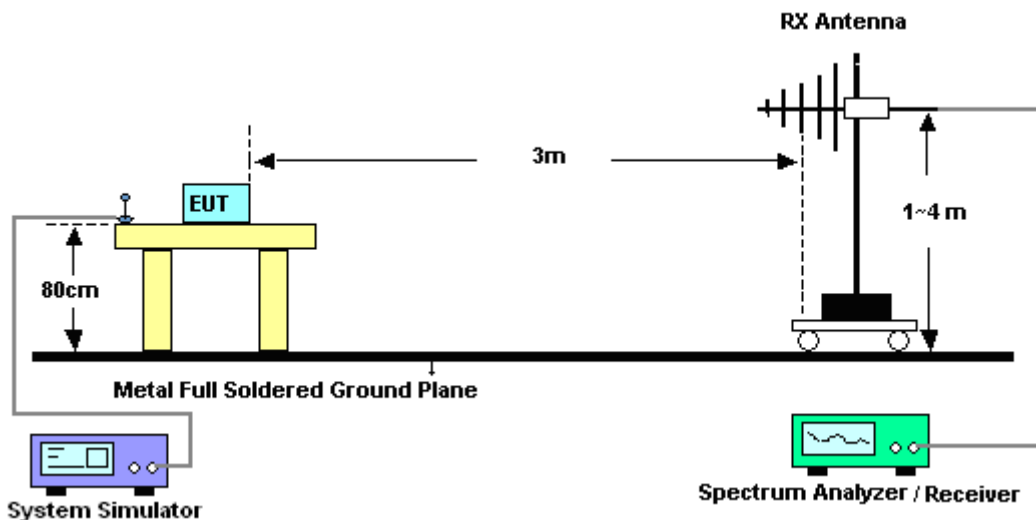

### 4.2.3 For radiated test above 1GHz

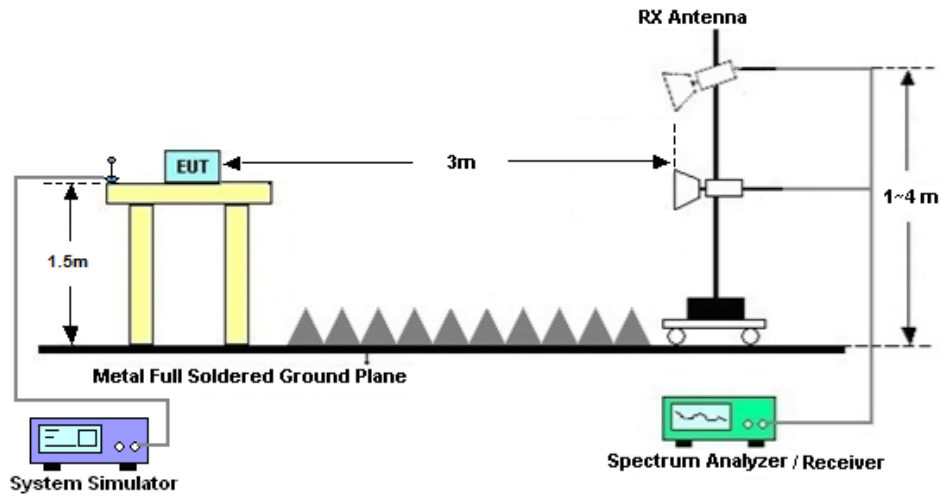

### 4.3 Test Result of Radiated Test

The low frequency, which started from 9 kHz to 30MHz, was pre-scanned and the result which was 20dB lower than the limit line was not reported.

Please refer to Appendix B.



## 4.4 Radiated Spurious Emission

### 4.4.1 Description of Radiated Spurious Emission

The radiated spurious emission was measured by substitution method according to ANSI C63.26. The power of any emission outside of the authorized operating frequency ranges must be attenuated below the transmitter power (P) by a factor of at least  $43 + 10 \log (P)$  dB.

The spectrum is scanned from 30 MHz up to a frequency including its 10th harmonic.

### 4.4.2 Test Procedures

1. The testing follows ANSI C63.26 Section 5.5
2. The EUT was placed on a turntable with 0.8 meter height for frequency below 1GHz and 1.5 meter height for frequency above 1GHz respectively above ground.
3. The EUT was set 3 meters from the receiving antenna mounted on the antenna tower.
4. The table was rotated 360 degrees to determine the position of the highest spurious emission.
5. The height of the receiving antenna is varied between 1m to 4m to search the maximum spurious emission for both horizontal and vertical polarizations.
6. During the measurement, the system simulator parameters were set to force the EUT transmitting at maximum output power.
7. Make the measurement with the spectrum analyzer's RBW = 1MHz, VBW = 3MHz, taking the record of maximum spurious emission.
8. A horn antenna was substituted in place of the EUT and was driven by a signal generator.
9. Tune the output power of signal generator to the same emission level with EUT maximum spurious emission.
10.  $EIRP \text{ (dBm)} = S.G. \text{ Power} - Tx \text{ Cable Loss} + Tx \text{ Antenna Gain}$
11.  $ERP \text{ (dBm)} = EIRP - 2.15$
12. The RF fundamental frequency should be excluded against the limit line in the operating frequency band.

The limit line is derived from  $43 + 10\log(P)$ dB below the transmitter power P(Watts)  
=  $P(W) - [43 + 10\log(P)]$  (dB)  
=  $[30 + 10\log(P)]$  (dBm) -  $[43 + 10\log(P)]$  (dB)  
= -13dBm.



## 5 List of Measuring Equipment

Instrument	Manufacturer	Model No.	Serial No.	Characteristics	Calibration Date	Test Date	Due Date	Remark
Spectrum Analyzer	R&S	FSV40	101040	10Hz~40GHz	Oct. 10, 2024	Apr. 25, 2025~ Apr. 27, 2025	Oct. 09, 2025	Conducted (TH01-KS)
Power divider	STI	STI08-0055	-	0.5~40GHz	NCR	Apr. 25, 2025~ Apr. 27, 2025	NCR	Conducted (TH01-KS)
Temperature & humidity	Hongzhan	LP-150U	H2014011440	-40~+150°C 20%~95%RH	Jul. 04, 2024	Apr. 25, 2025~ Apr. 27, 2025	Jul. 03, 2025	Conducted (TH01-KS)
EXA Spectrum Analyzer	Keysight	N9010A	MY55370528	10Hz~44G,MAX 30dB	Dec. 03, 2024	May 29, 2025	Dec. 02, 2025	Radiation (03CH04-KS)
Loop Antenna	R&S	HFH2-Z2E	101125	9kHz~30MHz	Sep. 08, 2024	May 29, 2025	Sep. 07, 2025	Radiation (03CH04-KS)
Bilog Antenna	TeseQ	CBL6111D	44483	30MHz~1GHz	Nov. 23, 2024	May 29, 2025	Nov. 22, 2025	Radiation (03CH04-KS)
Double Ridge Horn Antenna	ETS-Lindgren	3117	00227860	1GHz~18GHz	Aug. 16, 2024	May 29, 2025	Aug. 15, 2025	Radiation (03CH04-KS)
SHF-EHF Horn	Com-power	AH-840	101116	18GHz~40GHz	Oct. 22, 2024	May 29, 2025	Oct. 21, 2025	Radiation (03CH04-KS)
Amplifier	SONOMA	310N	380826	9KHz~1GHz	Jul. 03, 2024	May 29, 2025	Jul. 02, 2025	Radiation (03CH04-KS)
Amplifier	EM	EM18G40G A	060852	18~40GHz	Jan. 03, 2025	May 29, 2025	Jan. 02, 2026	Radiation (03CH04-KS)
high gain Amplifier	EM	EM01G18G A	060840	1Ghz~18Ghz	Oct. 09, 2024	May 29, 2025	Oct. 08, 2025	Radiation (03CH04-KS)
Amplifier	EM	EM01G18G A	060892	1Ghz~18Ghz	Oct. 09, 2024	May 29, 2025	Oct. 08, 2025	Radiation (03CH04-KS)
AC Power Source	Chroma	61601	F104090004	N/A	NCR	May 29, 2025	NCR	Radiation (03CH04-KS)
Turn Table	ChamPro	EM 1000-T	060762-T	0~360 degree	NCR	May 29, 2025	NCR	Radiation (03CH04-KS)
Antenna Mast	ChamPro	EM 1000-A	060762-A	1 m~4 m	NCR	May 29, 2025	NCR	Radiation (03CH04-KS)

NCR: No Calibration Required



## 6 Measurement Uncertainty

The measurement uncertainties shown below were calculated in accordance with the requirements of ANSI 63.26-2015. All the measurement uncertainty value were shown with a coverage K=2 to indicate 95% level of confidence. The measurement data show herein meets or exceeds the CISPR measurement uncertainty values specified in CISPR 16-4-2 and can be compared directly to specified limit to determine compliance.

### Uncertainty of Conducted Measurement

Test Item	Uncertainty
Conducted Spurious Emission & Bandedge	±2.22 dB
Occupied Channel Bandwidth	±0.1%
Conducted Power	±0.50 dB
Peak to Average Ratio	±0.46 dB
Frequency Stability	±0.4 Hz

### Uncertainty of Radiated Emission Measurement (9 KHz ~ 30 MHz)

Measuring Uncertainty for a Level of Confidence of 95% (U = 2Uc(y))	3.30dB
---	--------

### Uncertainty of Radiated Emission Measurement (30 MHz ~ 1000 MHz)

Measuring Uncertainty for a Level of Confidence of 95% (U = 2Uc(y))	2.83dB
---	--------

### Uncertainty of Radiated Emission Measurement (1 GHz ~ 18 GHz)

Measuring Uncertainty for a Level of Confidence of 95% (U = 2Uc(y))	2.83dB
---	--------

### Uncertainty of Radiated Emission Measurement (18 GHz ~ 40 GHz)

Measuring Uncertainty for a Level of Confidence of 95% (U = 2Uc(y))	2.82dB
---	--------

----- THE END -----





### Appendix A. Test Results of Conducted Test

Test Engineer :	Simle Wang	Temperature :	22~23°C
		Relative Humidity :	40~42%

### Conducted Output Power(Average power) and ERP/EIRP

#### LTE Band 2\_ANT2:

BW [MHz]	Modulation	RB Size	RB Offset	Power Low Ch. / Freq.	Power Middle Ch. / Freq.	Power High Ch. / Freq.	EIRP(W)		
Channel				18700	18900	19100	EIRP(W)		
Frequency (MHz)				1860	1880	1900	L	M	H
20	QPSK	1	0	22.89	22.92	22.85	0.1774	0.1786	0.1758
20	QPSK	1	99	22.87	22.87	22.80	0.1766	0.1766	0.1738
20	QPSK	100	0	21.86	21.95	21.85	0.1400	0.1429	0.1396
20	16QAM	1	0	21.93	21.91	21.88	0.1422	0.1416	0.1406
20	64QAM	1	0	20.96	20.95	20.83	0.1138	0.1135	0.1104
20	256QAM	1	0	18.01	18.13	18.19	0.0577	0.0593	0.0601
Channel				18675	18900	19125	EIRP(W)		
Frequency (MHz)				1857.5	1880	1902.5	L	M	H
15	QPSK	1	0	22.86	22.89	22.71	0.1762	0.1774	0.1702
15	16QAM	1	0	21.82	21.87	21.84	0.1387	0.1403	0.1393
Channel				18650	18900	19150	EIRP(W)		
Frequency (MHz)				1855	1880	1905	L	M	H
10	QPSK	1	0	22.84	22.86	22.82	0.1754	0.1762	0.1746
10	16QAM	1	0	21.89	21.81	21.77	0.1409	0.1384	0.1371
Channel				18625	18900	19175	EIRP(W)		
Frequency (MHz)				1852.5	1880	1907.5	L	M	H
5	QPSK	1	0	22.78	22.79	22.76	0.1730	0.1734	0.1722
5	16QAM	1	0	21.80	21.83	21.75	0.1380	0.1390	0.1365
Channel				18615	18900	19185	EIRP(W)		
Frequency (MHz)				1851.5	1880	1908.5	L	M	H
3	QPSK	1	0	22.77	22.86	22.82	0.1726	0.1762	0.1746
3	16QAM	1	0	21.86	21.79	21.80	0.1400	0.1377	0.1380
Channel				18607	18900	19193	EIRP(W)		
Frequency (MHz)				1850.7	1880	1909.3	L	M	H
1.4	QPSK	1	0	22.85	22.84	22.77	0.1758	0.1754	0.1726
1.4	16QAM	1	0	21.88	21.83	21.76	0.1406	0.1390	0.1368



LTE Band 4\_ANT2:

BW [MHz]	Modulation	RB Size	RB Offset	Power Low Ch. / Freq.	Power Middle Ch. / Freq.	Power High Ch. / Freq.	EIRP(W)		
Channel				20050	20175	20300	EIRP(W)		
Frequency (MHz)				1720	1732.5	1745	L	M	H
20	QPSK	1	0	22.97	23.04	22.91	0.1469	0.1493	0.1449
20	QPSK	1	99	22.94	22.95	22.83	0.1459	0.1462	0.1422
20	QPSK	100	0	21.99	22.05	21.92	0.1172	0.1189	0.1153
20	16QAM	1	0	21.99	22.04	21.92	0.1172	0.1186	0.1153
20	64QAM	1	0	20.98	21.01	20.96	0.0929	0.0935	0.0925
20	256QAM	1	0	18.09	18.11	18.15	0.0478	0.0480	0.0484
Channel				20025	20175	20325	EIRP(W)		
Frequency (MHz)				1717.5	1732.5	1747.5	L	M	H
15	QPSK	1	0	22.93	23.01	22.86	0.1455	0.1483	0.1432
15	16QAM	1	0	21.90	21.90	21.86	0.1148	0.1148	0.1138
Channel				20000	20175	20350	EIRP(W)		
Frequency (MHz)				1715	1732.5	1750	L	M	H
10	QPSK	1	0	22.88	23.01	22.83	0.1439	0.1483	0.1422
10	16QAM	1	0	21.88	21.93	21.79	0.1143	0.1156	0.1119
Channel				19975	20175	20375	EIRP(W)		
Frequency (MHz)				1712.5	1732.5	1752.5	L	M	H
5	QPSK	1	0	22.86	22.96	22.84	0.1432	0.1466	0.1426
5	16QAM	1	0	21.92	21.91	21.89	0.1153	0.1151	0.1146
Channel				19965	20175	20385	EIRP(W)		
Frequency (MHz)				1711.5	1732.5	1753.5	L	M	H
3	QPSK	1	0	22.90	22.98	22.88	0.1445	0.1472	0.1439
3	16QAM	1	0	21.96	22.02	21.85	0.1164	0.1180	0.1135
Channel				19950	20175	20393	EIRP(W)		
Frequency (MHz)				1710	1732.5	1754.3	L	M	H
1.4	QPSK	1	0	22.83	22.99	22.81	0.1422	0.1476	0.1416
1.4	16QAM	1	0	21.97	21.92	21.84	0.1167	0.1153	0.1132



LTE Band 25\_ANT2:

BW [MHz]	Modulation	RB Size	RB Offset	Power Low Ch. / Freq.	Power Middle Ch. / Freq.	Power High Ch. / Freq.	EIRP(W)		
Channel				26140	26340	26590	EIRP(W)		
Frequency (MHz)				1860	1880	1905	L	M	H
20	QPSK	1	0	22.95	22.99	22.86	0.1799	0.1816	0.1762
20	QPSK	1	99	22.95	22.89	22.76	0.1799	0.1774	0.1722
20	QPSK	100	0	21.87	21.99	21.84	0.1403	0.1442	0.1393
20	16QAM	1	0	21.93	21.98	21.95	0.1422	0.1439	0.1429
20	64QAM	1	0	20.93	21.02	20.85	0.1130	0.1153	0.1109
20	256QAM	1	0	17.95	17.99	17.86	0.0569	0.0574	0.0557
Channel				26115	26340	26615	EIRP(W)		
Frequency (MHz)				1857.5	1880	1907.5	L	M	H
15	QPSK	1	0	22.61	22.72	22.77	0.1663	0.1706	0.1726
15	16QAM	1	0	21.64	21.72	21.80	0.1330	0.1355	0.1380
Channel				26090	26340	26640	EIRP(W)		
Frequency (MHz)				1855	1880	1910	L	M	H
10	QPSK	1	0	22.61	22.80	22.69	0.1663	0.1738	0.1694
10	16QAM	1	0	21.63	21.66	21.81	0.1327	0.1337	0.1384
Channel				26065	26340	26665	EIRP(W)		
Frequency (MHz)				1852.5	1880	1912.5	L	M	H
5	QPSK	1	0	22.61	22.70	22.70	0.1663	0.1698	0.1698
5	16QAM	1	0	21.59	21.66	21.81	0.1315	0.1337	0.1384
Channel				26055	26340	26675	EIRP(W)		
Frequency (MHz)				1851.5	1880	1913.5	L	M	H
3	QPSK	1	0	22.63	22.76	22.76	0.1671	0.1722	0.1722
3	16QAM	1	0	21.57	21.65	21.76	0.1309	0.1334	0.1368
Channel				26047	26340	26683	EIRP(W)		
Frequency (MHz)				1850.7	1880	1914.3	L	M	H
1.4	QPSK	1	0	22.65	22.73	22.73	0.1679	0.1710	0.1710
1.4	16QAM	1	0	21.57	21.70	21.75	0.1309	0.1349	0.1365



LTE Band 66\_ANT2:

BW [MHz]	Modulation	RB Size	RB Offset	Power Low Ch. / Freq.	Power Middle Ch. / Freq.	Power High Ch. / Freq.	EIRP(W)		
Channel				132072	132322	132572	EIRP(W)		
Frequency (MHz)				1720	1745	1770	L	M	H
20	QPSK	1	0	22.99	23.09	22.91	0.1476	0.1510	0.1449
20	QPSK	1	99	22.90	22.92	22.90	0.1445	0.1452	0.1445
20	QPSK	100	0	22.01	22.10	21.93	0.1178	0.1202	0.1156
20	16QAM	1	0	22.02	22.02	21.89	0.1180	0.1180	0.1146
20	64QAM	1	0	20.97	21.03	21.01	0.0927	0.0940	0.0935
20	256QAM	1	0	17.99	18.09	17.91	0.0467	0.0478	0.0458
Channel				132047	132322	132597	EIRP(W)		
Frequency (MHz)				1717.5	1745	1772.5	L	M	H
15	QPSK	1	0	22.94	23.02	22.80	0.1459	0.1486	0.1413
15	16QAM	1	0	21.91	21.94	21.76	0.1151	0.1159	0.1112
Channel				132022	132322	132622	EIRP(W)		
Frequency (MHz)				1715	1745	1775	L	M	H
10	QPSK	1	0	22.93	23.07	22.82	0.1455	0.1503	0.1419
10	16QAM	1	0	21.95	21.92	21.85	0.1161	0.1153	0.1135
Channel				131997	132322	132647	EIRP(W)		
Frequency (MHz)				1712.5	1745	1777.5	L	M	H
5	QPSK	1	0	22.86	22.96	22.87	0.1432	0.1466	0.1435
5	16QAM	1	0	21.96	21.98	21.86	0.1164	0.1169	0.1138
Channel				131987	132322	132657	EIRP(W)		
Frequency (MHz)				1711.5	1745	1778.5	L	M	H
3	QPSK	1	0	22.90	22.97	22.86	0.1445	0.1469	0.1432
3	16QAM	1	0	21.93	21.99	21.78	0.1156	0.1172	0.1117
Channel				131979	132322	132665	EIRP(W)		
Frequency (MHz)				1710.7	1745	1779.3	L	M	H
1.4	QPSK	1	0	22.92	23.02	22.79	0.1452	0.1486	0.1409
1.4	16QAM	1	0	21.98	21.95	21.78	0.1169	0.1161	0.1117



# LTE Band 25

## Peak-to-Average Ratio

Mode	LTE Band 25 / 20MHz				
Mod.	QPSK	16QAM	64QAM	256QAM	Limit: 13dB
RB Size	Full RB	Full RB	Full RB	Full RB	Result
Middle CH	5.07	6.03	6.52	6.64	PASS

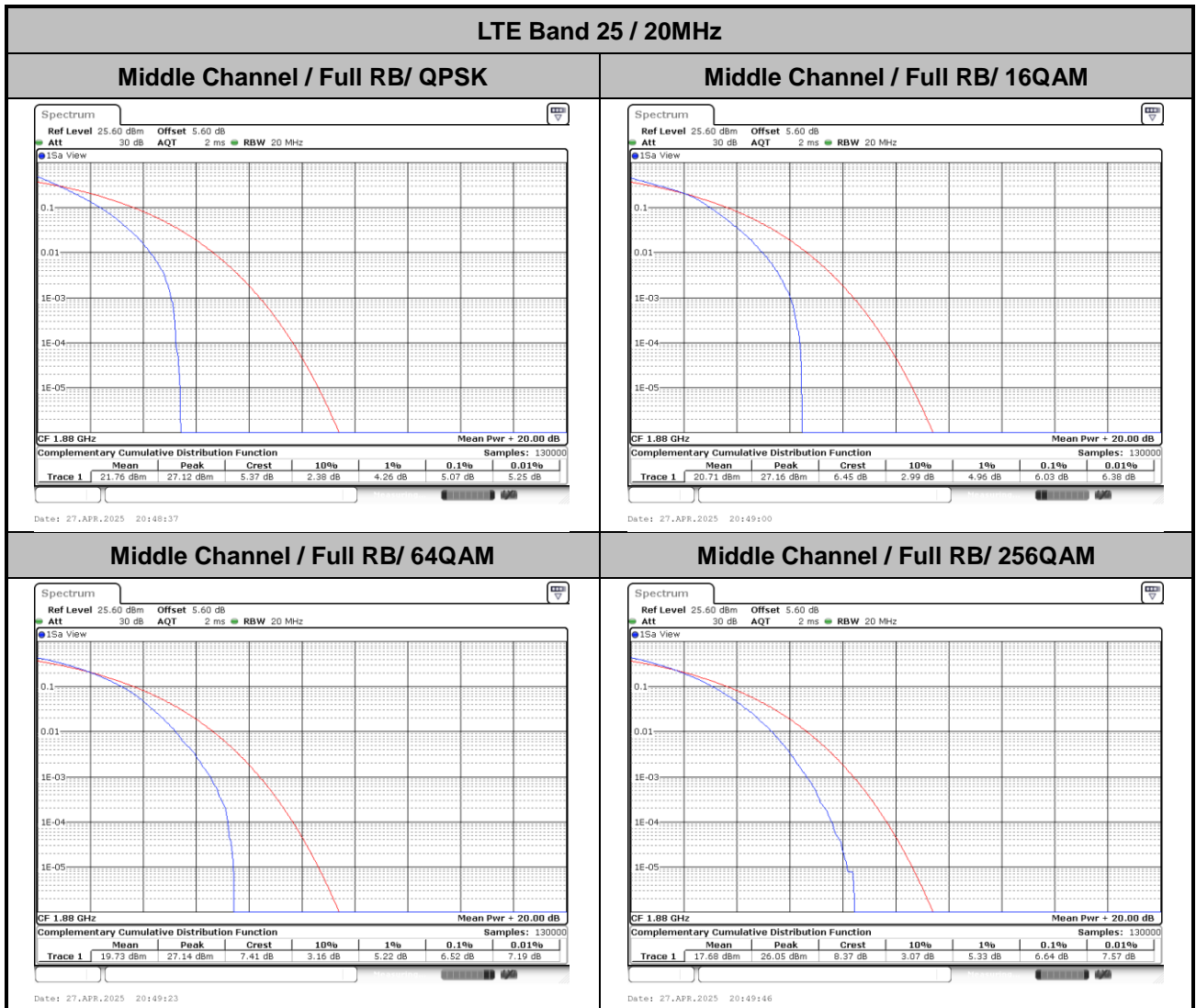



**26dB Bandwidth**

Mode	LTE Band 25 : 26dB BW(MHz)	
<b>BW</b>	<b>1.4MHz</b>	
<b>Mod.</b>	<b>QPSK</b>	<b>16QAM</b>
<b>Middle CH</b>	1.32	1.34
<b>BW</b>	<b>3MHz</b>	
<b>Mod.</b>	<b>QPSK</b>	<b>16QAM</b>
<b>Middle CH</b>	3.07	3.11
<b>BW</b>	<b>5MHz</b>	
<b>Mod.</b>	<b>QPSK</b>	<b>16QAM</b>
<b>Middle CH</b>	4.98	5.05
<b>BW</b>	<b>10MHz</b>	
<b>Mod.</b>	<b>QPSK</b>	<b>16QAM</b>
<b>Middle CH</b>	10.15	9.81
<b>BW</b>	<b>15MHz</b>	
<b>Mod.</b>	<b>QPSK</b>	<b>16QAM</b>
<b>Middle CH</b>	14.69	14.48
<b>BW</b>	<b>20MHz</b>	
<b>Mod.</b>	<b>QPSK</b>	<b>16QAM</b>
<b>Middle CH</b>	19.02	19.26



LTE Band 25

Middle Channel / 1.4MHz / QPSK

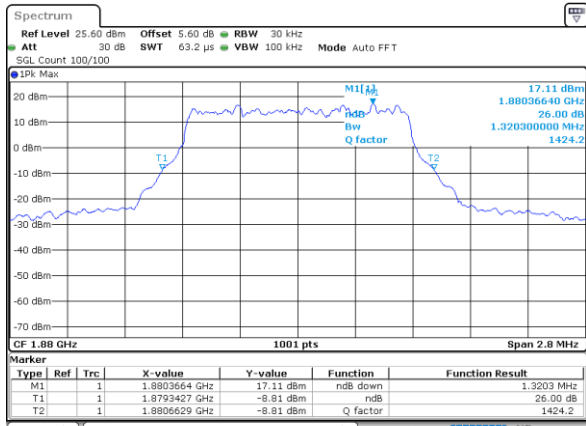

Date: 27.APR.2025 21:18:09

Middle Channel / 1.4MHz / 16QAM

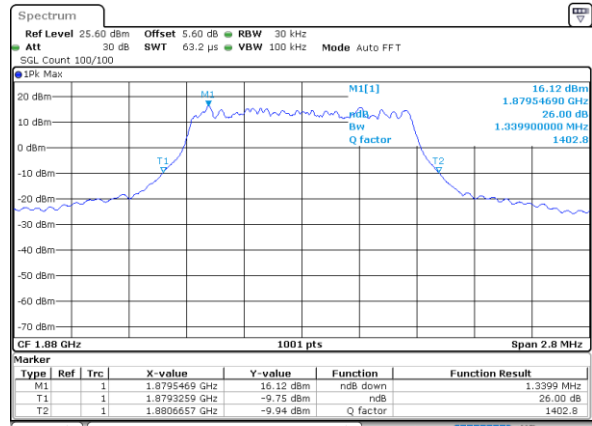

Date: 27.APR.2025 21:18:31

Middle Channel / 3MHz / QPSK

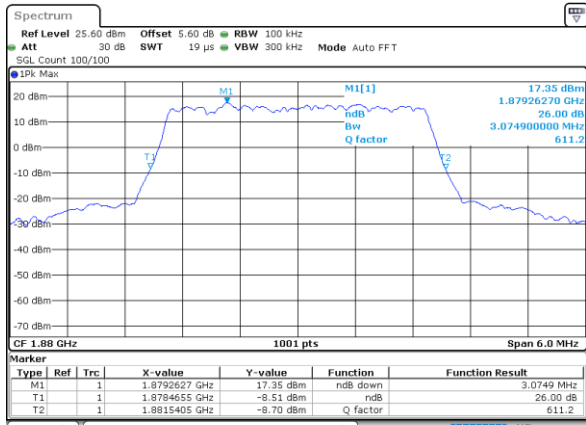

Date: 27.APR.2025 21:15:13

Middle Channel / 3MHz / 16QAM

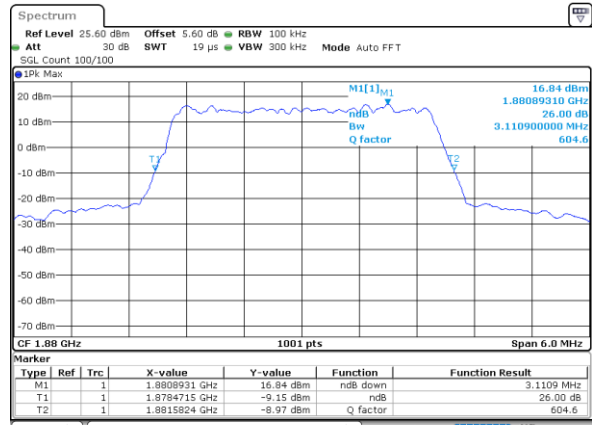

Date: 27.APR.2025 21:15:34

Middle Channel / 5MHz / QPSK

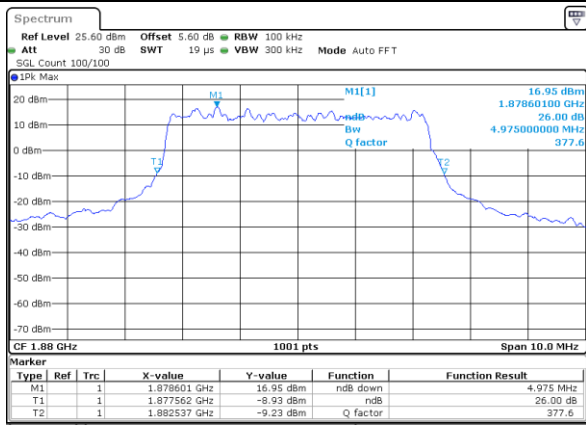

Date: 27.APR.2025 21:13:47

Middle Channel / 5MHz / 16QAM

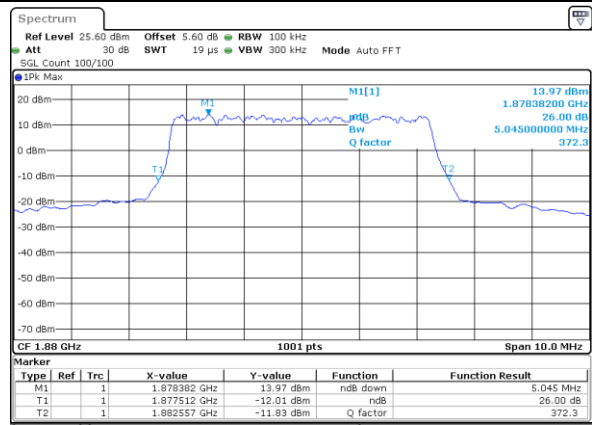

Date: 27.APR.2025 21:14:08



LTE Band 25

Middle Channel / 10MHz / QPSK

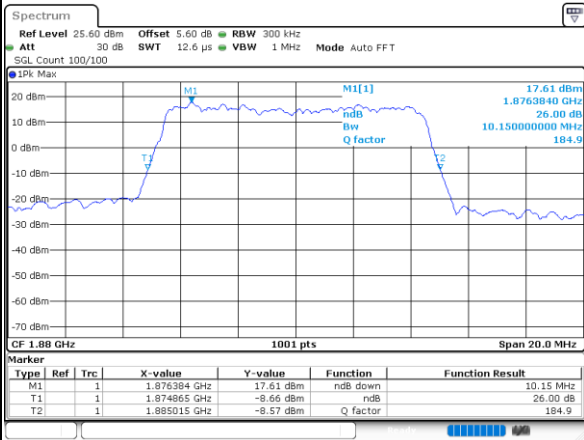

Date: 27.APR.2025 21:12:21

Middle Channel / 10MHz / 16QAM

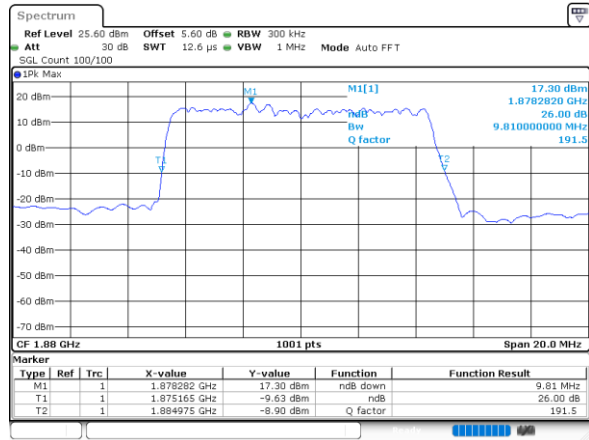

Date: 27.APR.2025 21:12:42

Middle Channel / 15MHz / QPSK

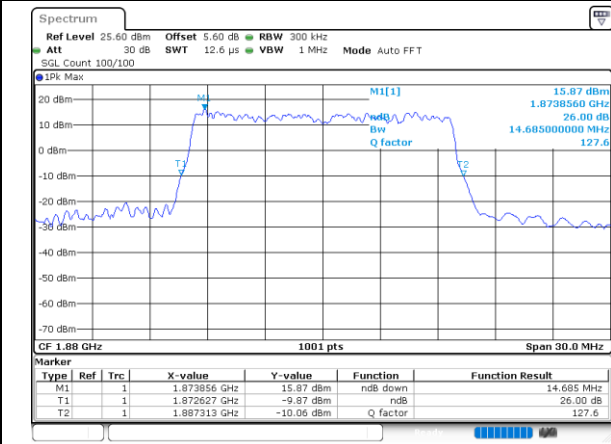

Date: 27.APR.2025 21:10:54

Middle Channel / 15MHz / 16QAM

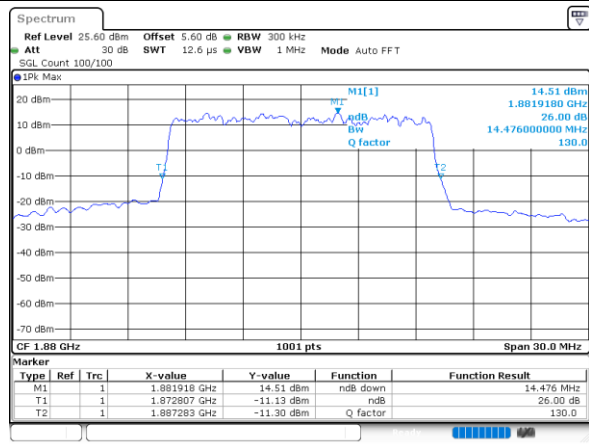

Date: 27.APR.2025 21:11:16

Middle Channel / 20MHz / QPSK

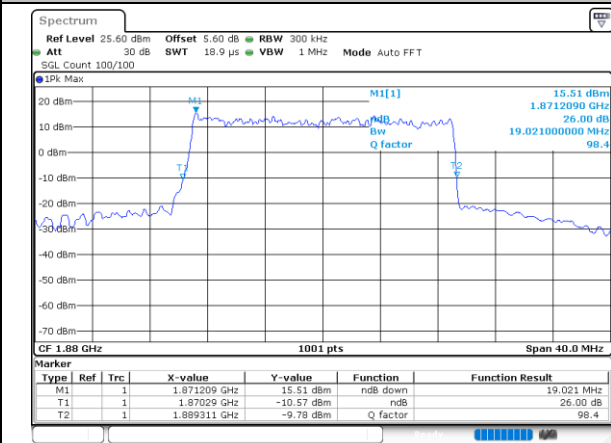

Date: 27.APR.2025 20:36:58

Middle Channel / 20MHz / 16QAM

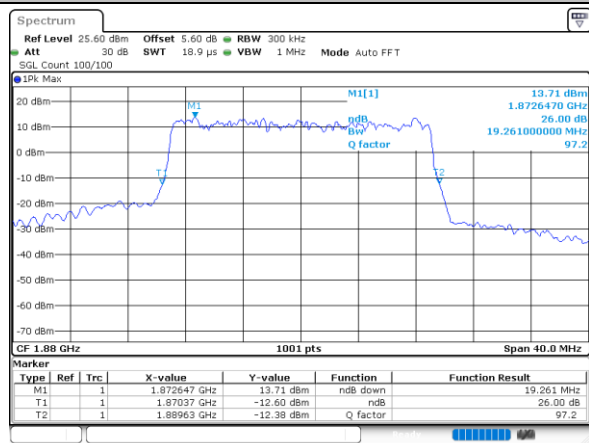

Date: 27.APR.2025 20:37:19





### Occupied Bandwidth

Mode	LTE Band 25 : 99%OBW(MHz)	
<b>BW</b>	<b>1.4MHz</b>	
<b>Mod.</b>	<b>QPSK</b>	<b>16QAM</b>
<b>Middle CH</b>	1.10	1.10
<b>BW</b>	<b>3MHz</b>	
<b>Mod.</b>	<b>QPSK</b>	<b>16QAM</b>
<b>Middle CH</b>	2.72	2.73
<b>BW</b>	<b>5MHz</b>	
<b>Mod.</b>	<b>QPSK</b>	<b>16QAM</b>
<b>Middle CH</b>	4.51	4.54
<b>BW</b>	<b>10MHz</b>	
<b>Mod.</b>	<b>QPSK</b>	<b>16QAM</b>
<b>Middle CH</b>	9.05	9.01
<b>BW</b>	<b>15MHz</b>	
<b>Mod.</b>	<b>QPSK</b>	<b>16QAM</b>
<b>Middle CH</b>	13.46	13.46
<b>BW</b>	<b>20MHz</b>	
<b>Mod.</b>	<b>QPSK</b>	<b>16QAM</b>
<b>Middle CH</b>	17.94	17.90



LTE Band 25

Middle Channel / 1.4MHz / QPSK

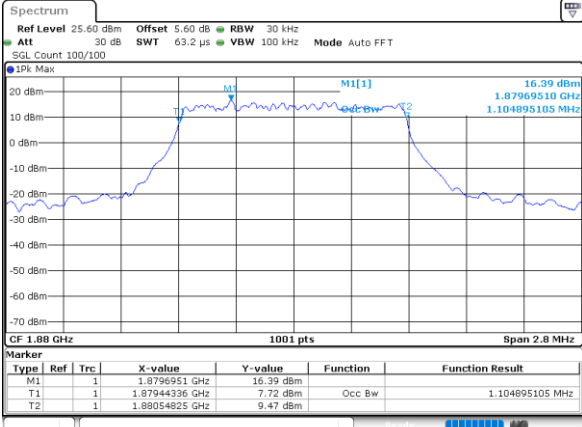

Date: 27.APR.2025 21:17:48

Middle Channel / 1.4MHz / 16QAM

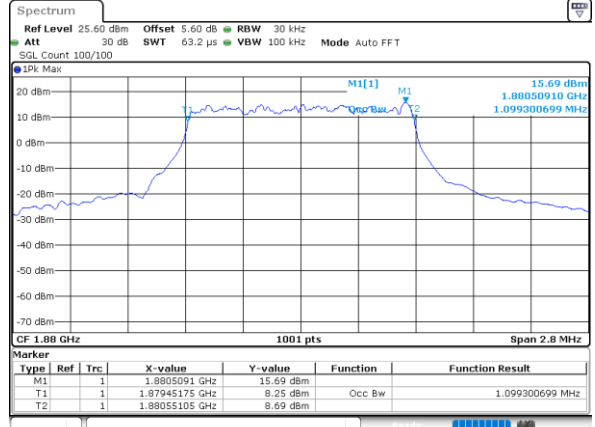

Date: 27.APR.2025 21:18:52

Middle Channel / 3MHz / QPSK

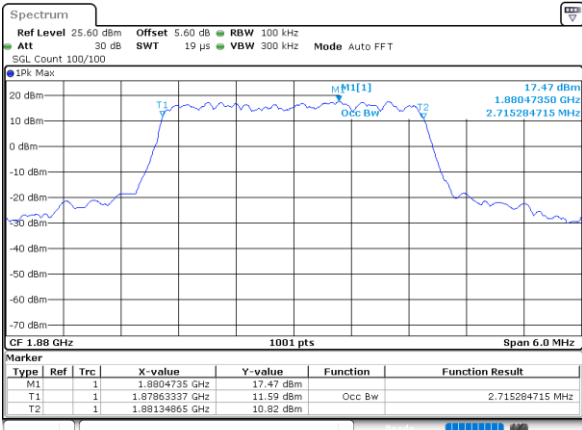

Date: 27.APR.2025 21:14:52

Middle Channel / 3MHz / 16QAM

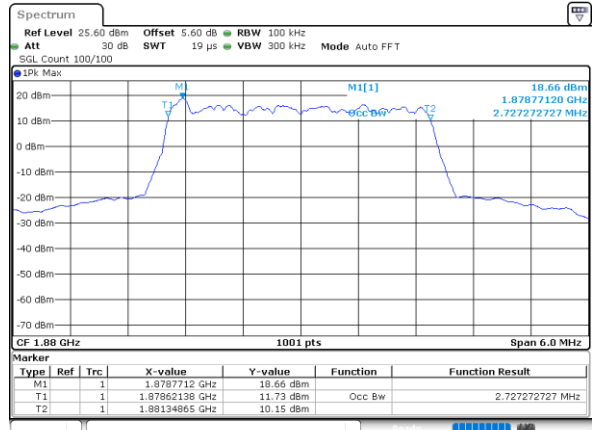

Date: 27.APR.2025 21:15:56

Middle Channel / 5MHz / QPSK

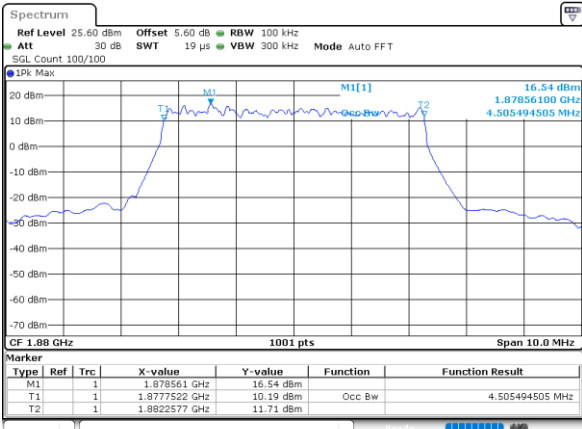

Date: 27.APR.2025 21:13:25

Middle Channel / 5MHz / 16QAM

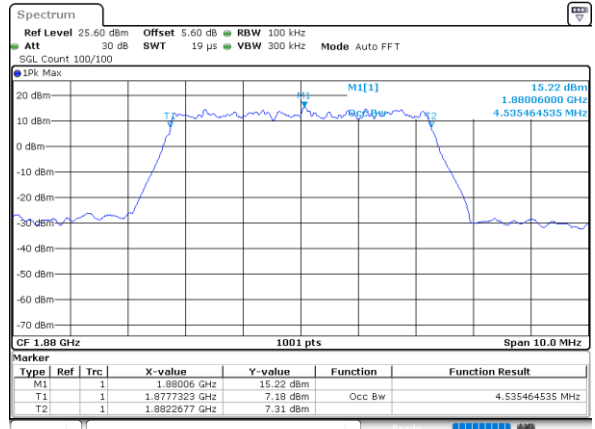

Date: 27.APR.2025 21:14:29



LTE Band 25

Middle Channel / 10MHz / QPSK

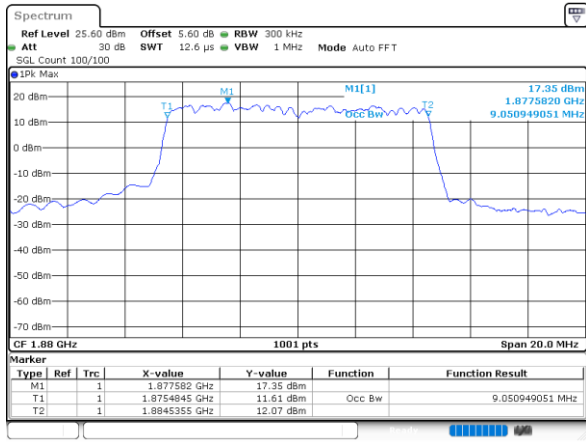

Date: 27.APR.2025 21:11:59

Middle Channel / 10MHz / 16QAM

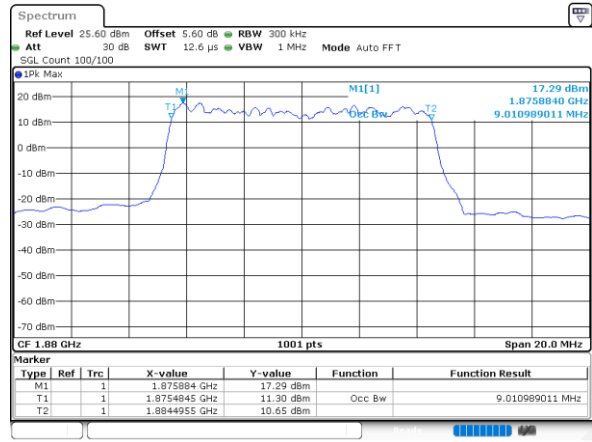

Date: 27.APR.2025 21:11:03

Middle Channel / 15MHz / QPSK

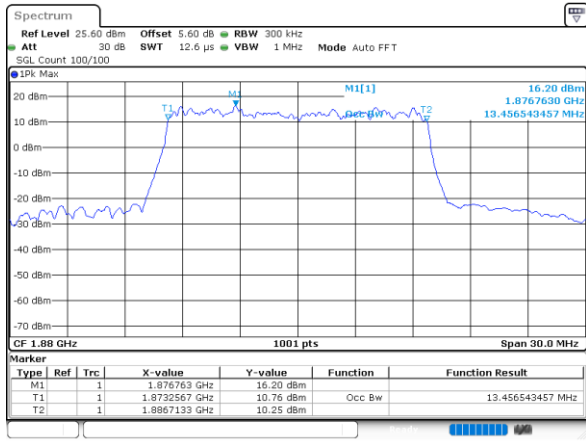

Date: 27.APR.2025 21:11:33

Middle Channel / 15MHz / 16QAM

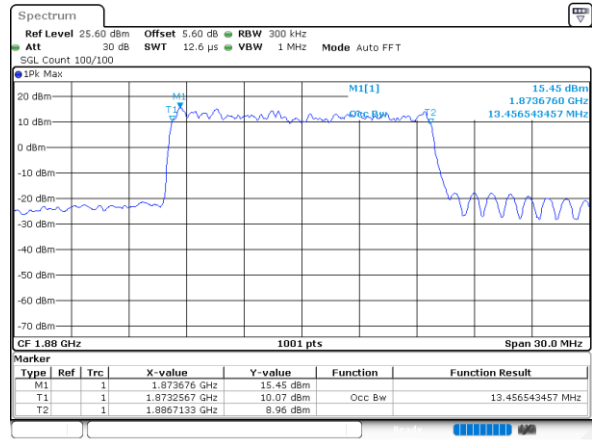

Date: 27.APR.2025 21:11:37

Middle Channel / 20MHz / QPSK

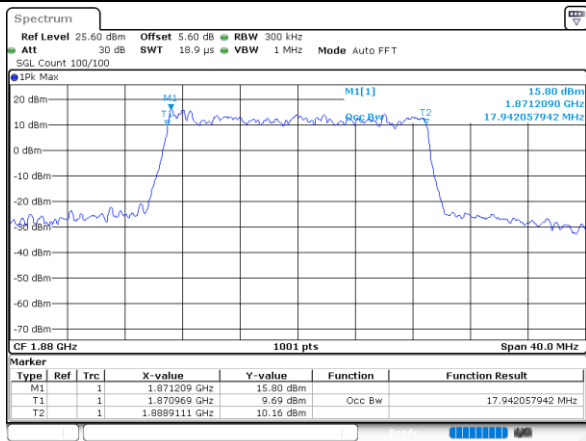

Date: 27.APR.2025 20:36:36

Middle Channel / 20MHz / 16QAM

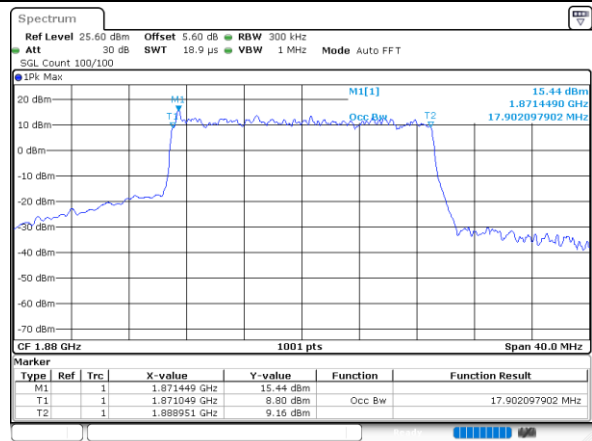

Date: 27.APR.2025 20:37:41



# Conducted Band Edge

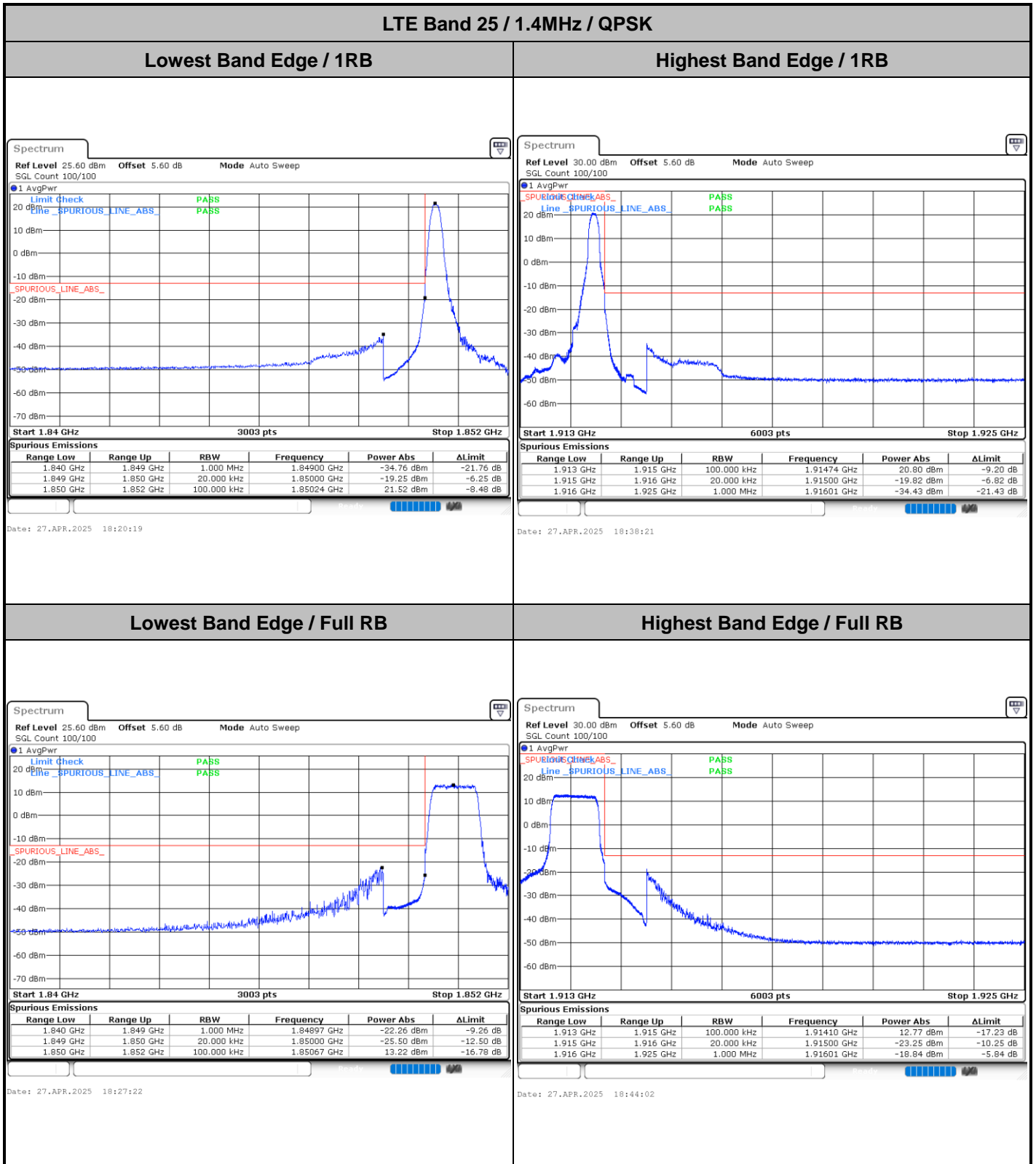



LTE Band 25 / 1.4MHz / 16QAM

Lowest Band Edge / 1 RB

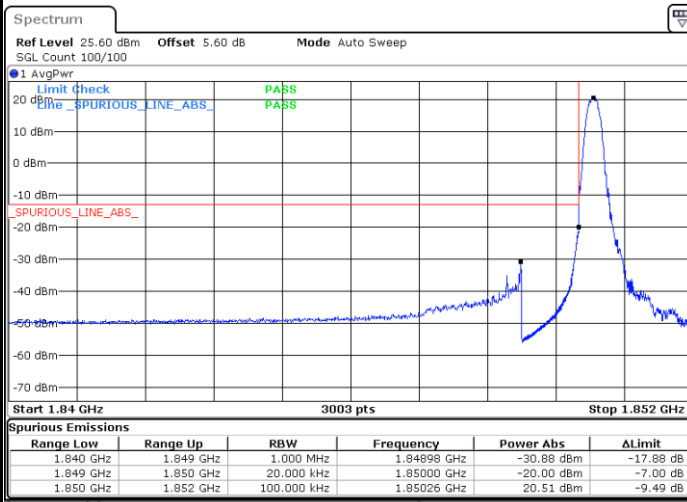

Date: 27.APR.2025 18:21:44

Highest Band Edge / 1 RB

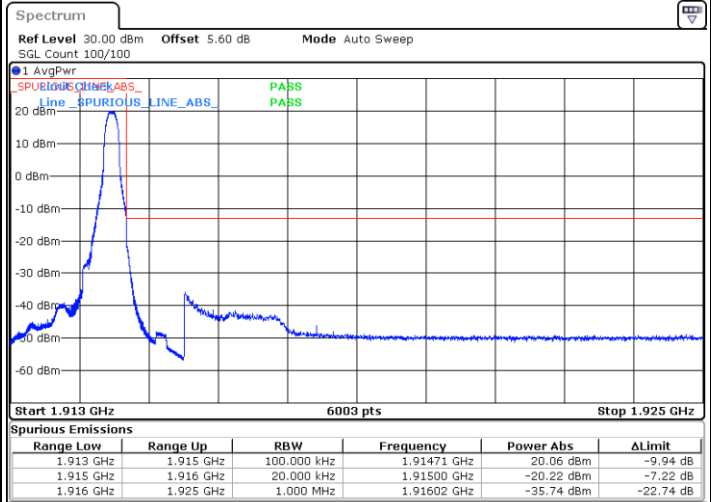

Date: 27.APR.2025 18:39:46

Lowest Band Edge / Full RB

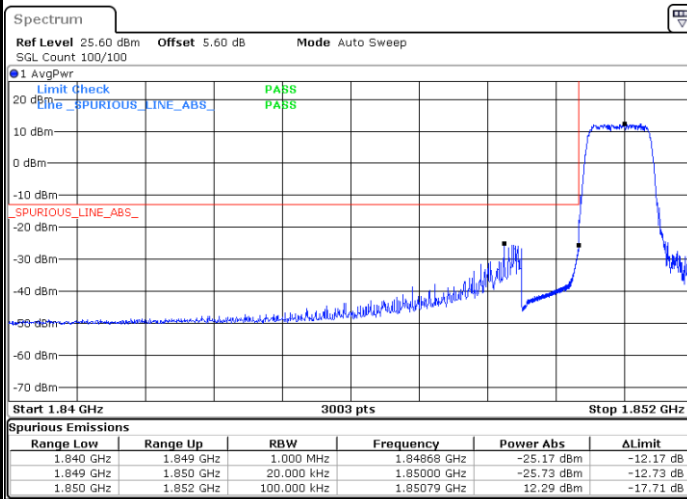

Date: 27.APR.2025 18:28:47

Highest Band Edge / Full RB

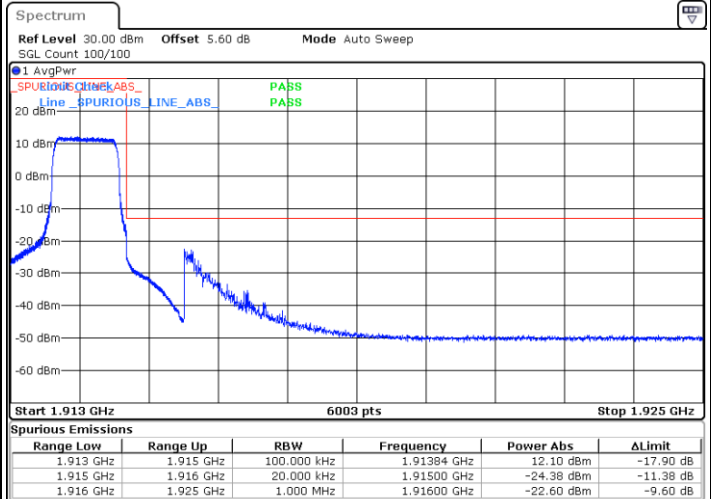

Date: 27.APR.2025 18:45:27



LTE Band 25 / 1.4MHz / 64QAM

Lowest Band Edge / 1 RB

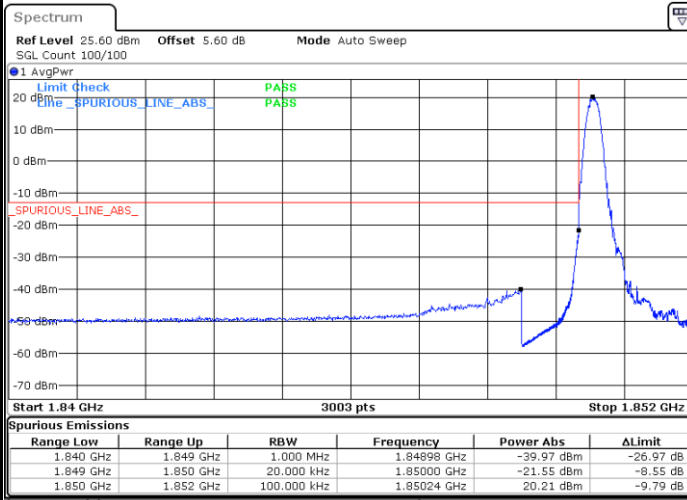

Date: 27.APR.2025 18:23:09

Highest Band Edge / 1 RB

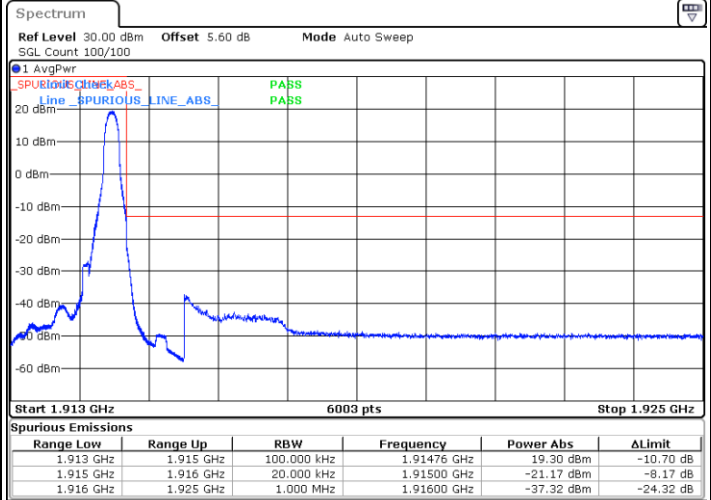

Date: 27.APR.2025 18:41:11

Lowest Band Edge / Full RB

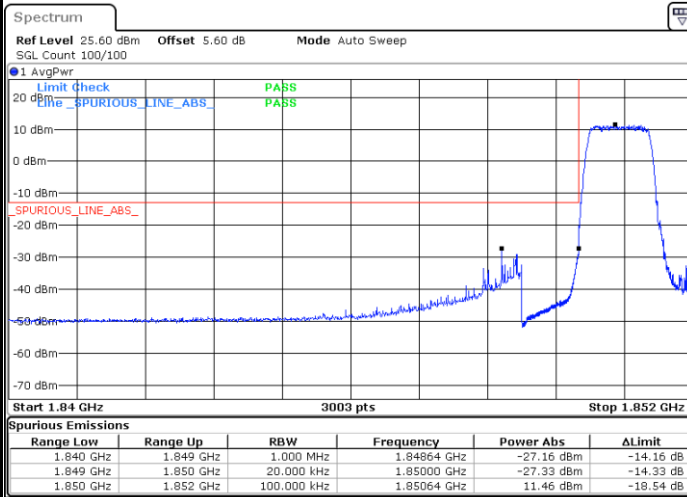

Date: 27.APR.2025 18:30:12

Highest Band Edge / Full RB

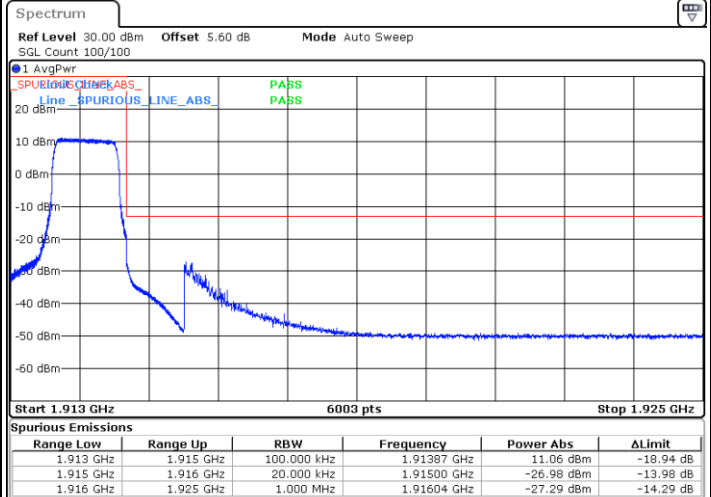

Date: 27.APR.2025 18:46:52



LTE Band 25 / 1.4MHz / 256QAM

Lowest Band Edge / 1 RB

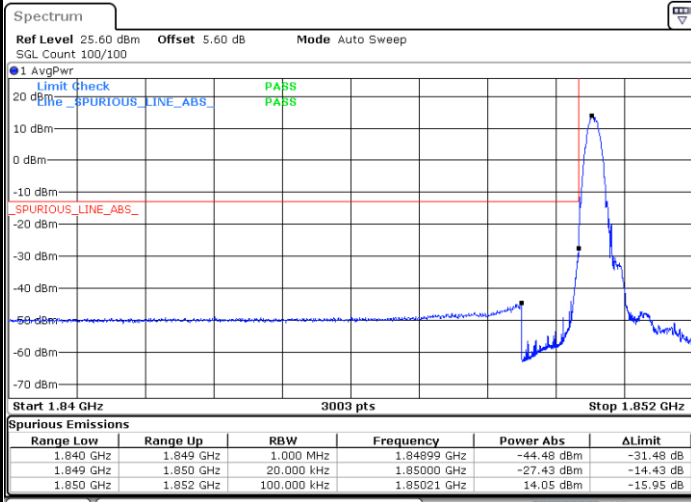

Highest Band Edge / 1 RB

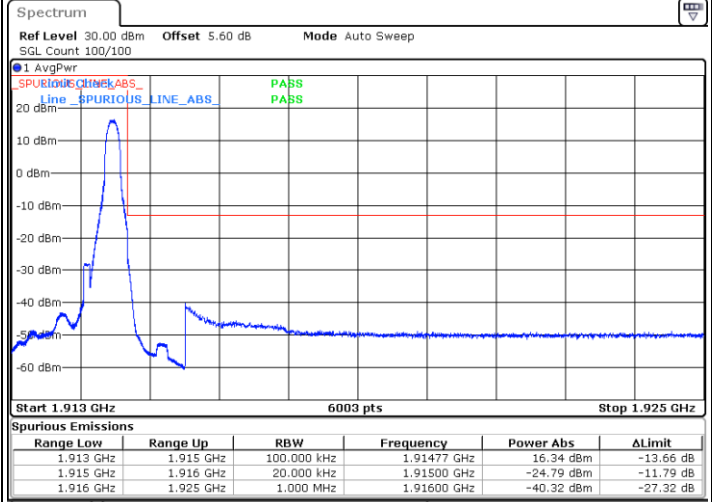

Lowest Band Edge / Full RB

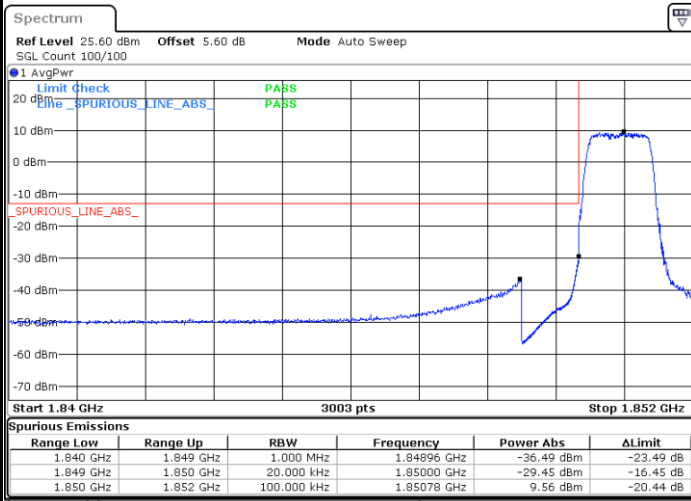

Highest Band Edge / Full RB

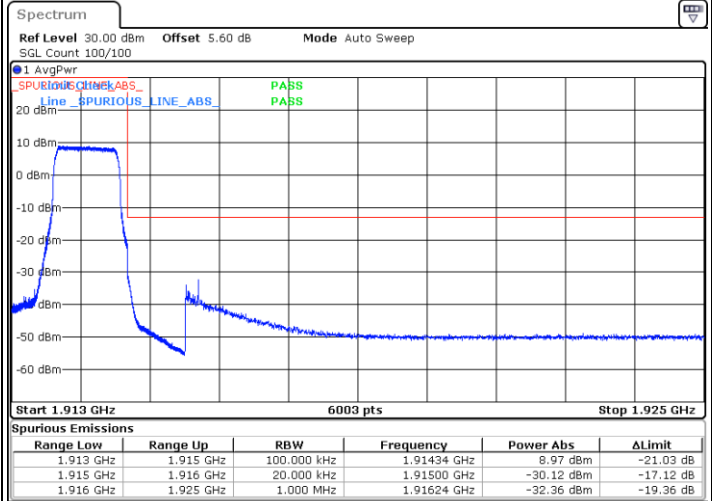



LTE Band 25 / 3MHz / QPSK

Lowest Band Edge / 1RB

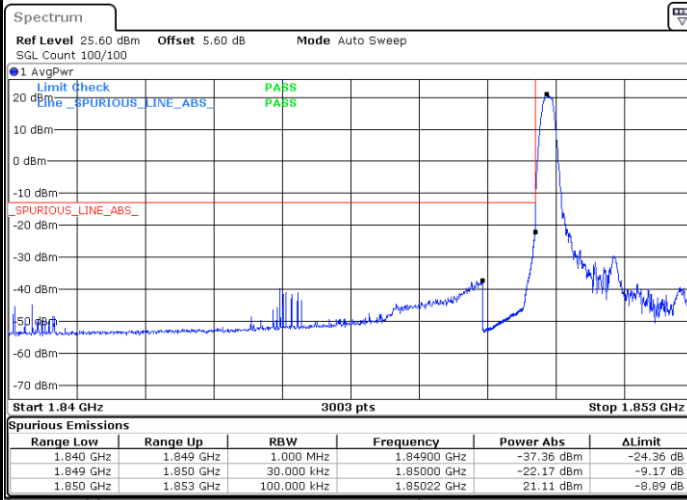

Date: 27.APR.2025 18:59:40

Highest Band Edge / 1 RB

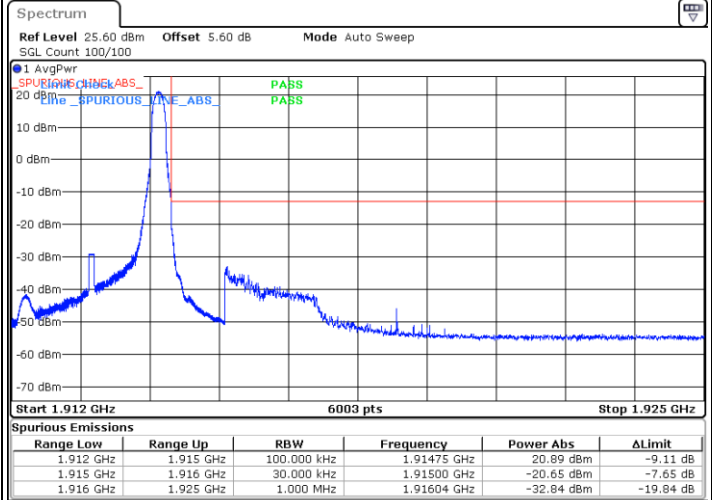

Date: 27.APR.2025 19:09:24

Lowest Band Edge / Full RB

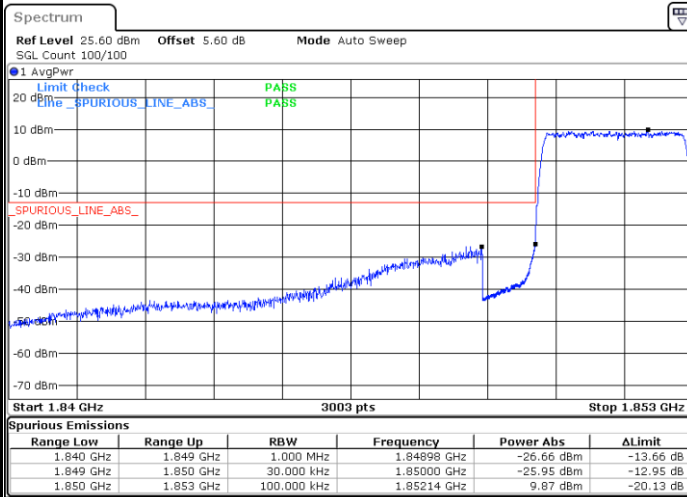

Date: 27.APR.2025 18:51:59

Highest Band Edge / Full RB

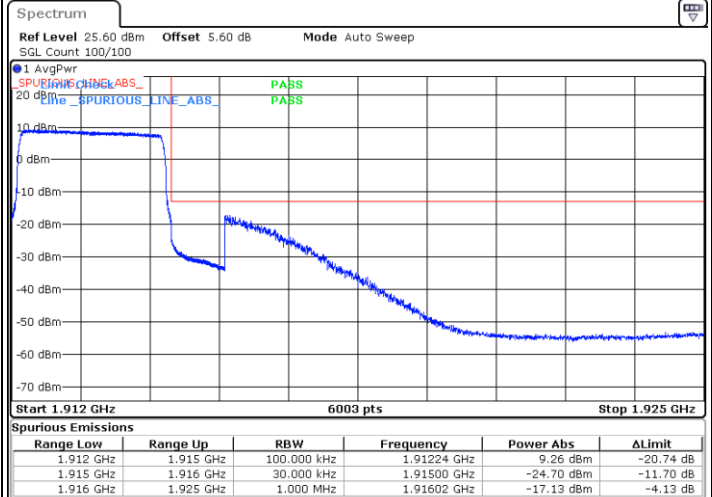

Date: 27.APR.2025 19:15:07





LTE Band 25 / 3MHz / 16QAM

Lowest Band Edge / 1 RB

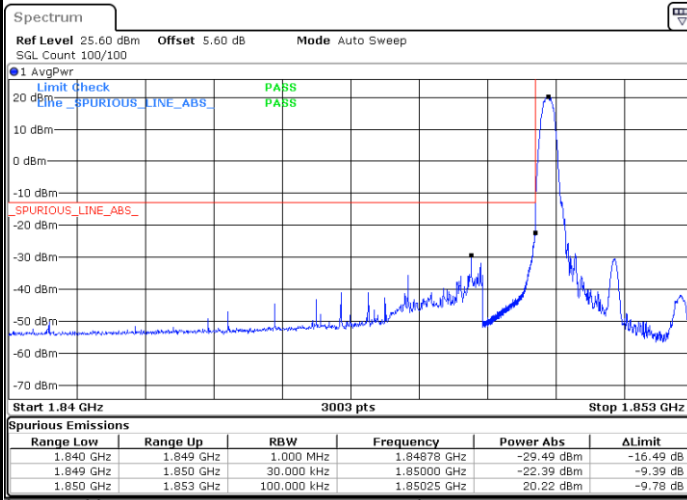

Date: 27.APR.2025 19:01:05

Highest Band Edge / 1 RB

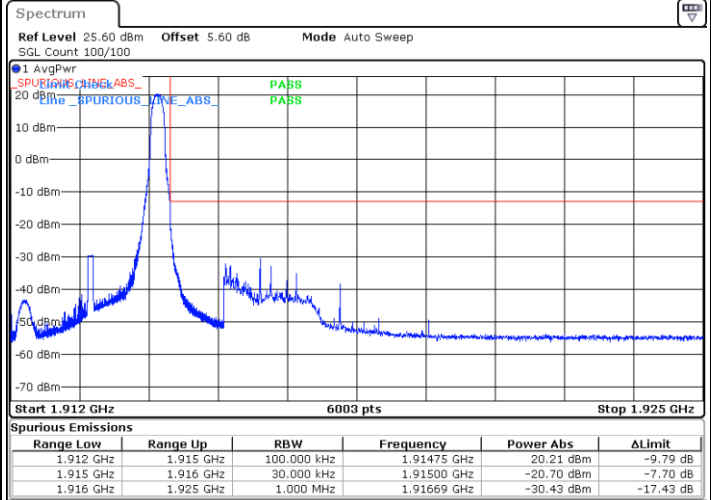

Date: 27.APR.2025 19:10:49

Lowest Band Edge / Full RB

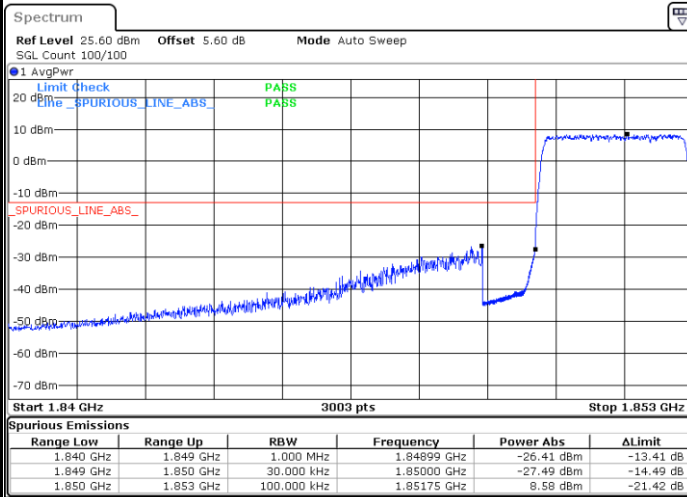

Date: 27.APR.2025 18:53:24

Highest Band Edge / Full RB

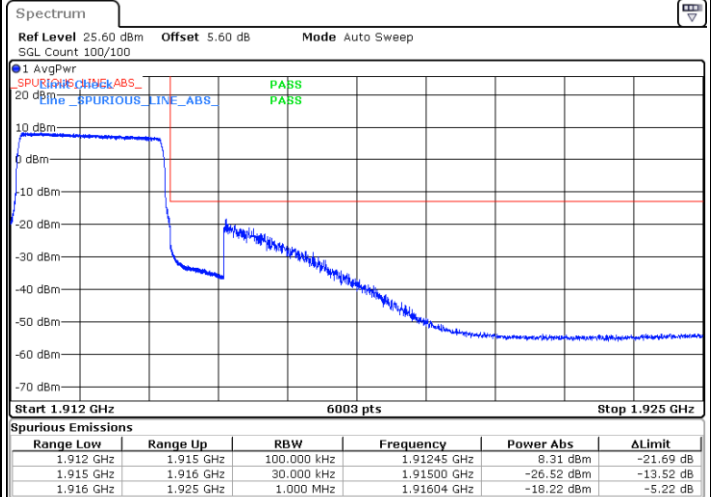

Date: 27.APR.2025 19:16:32



LTE Band 25 / 3MHz / 64QAM

Lowest Band Edge / 1 RB

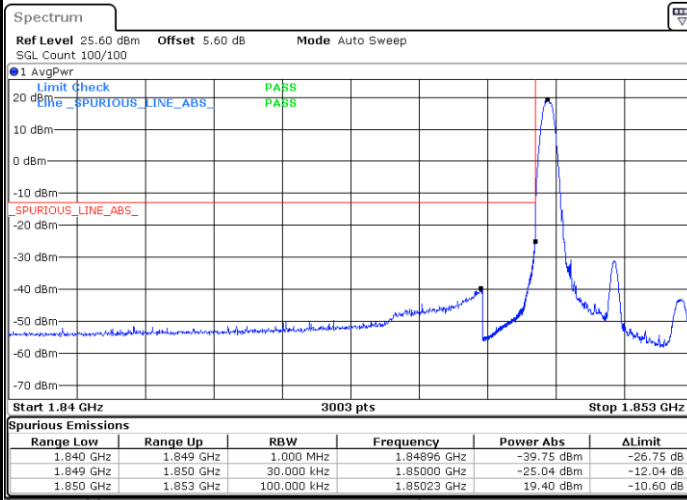

Date: 27.APR.2025 19:02:30

Highest Band Edge / 1 RB

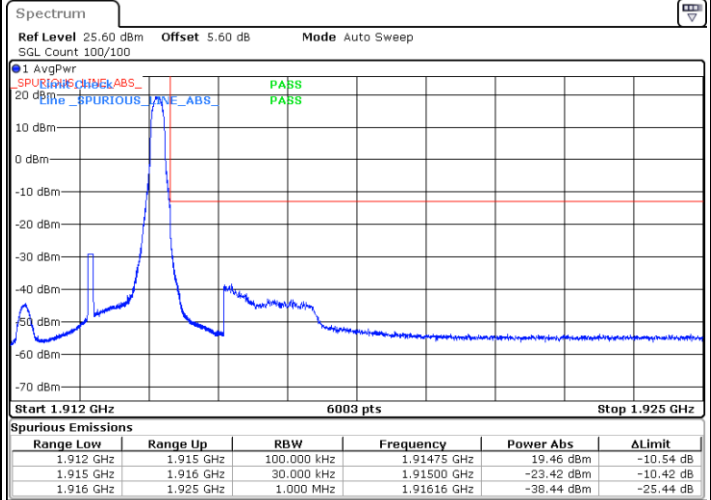

Date: 27.APR.2025 19:12:14

Lowest Band Edge / Full RB

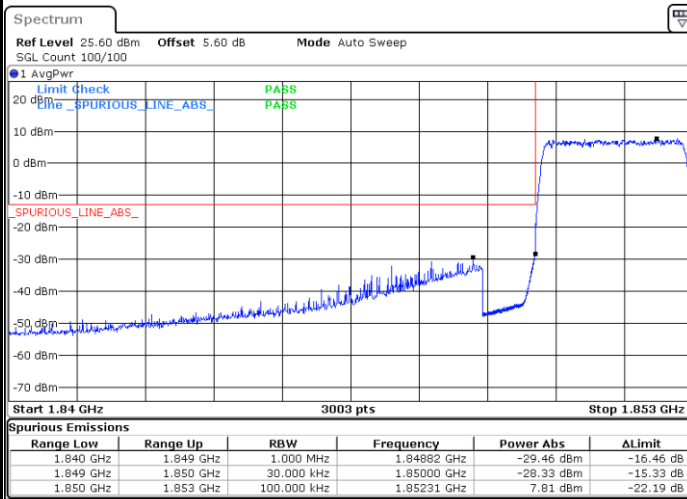

Date: 27.APR.2025 18:54:49

Highest Band Edge / Full RB

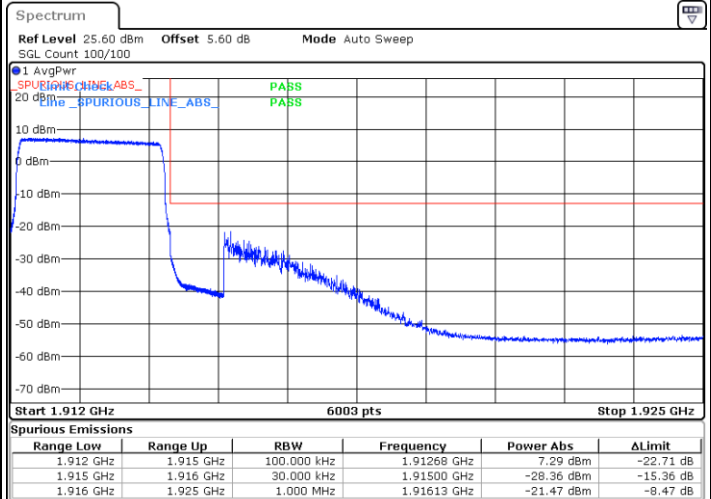

Date: 27.APR.2025 19:17:57



LTE Band 25 / 3MHz / 256QAM

Lowest Band Edge / 1 RB

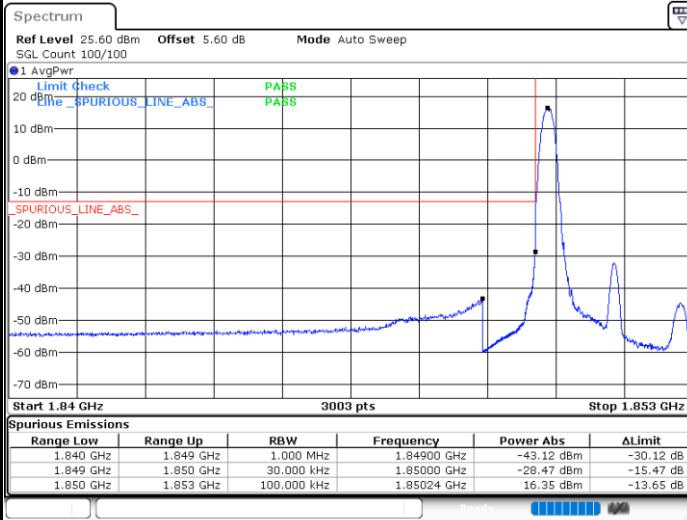

Date: 27.APR.2025 19:03:56

Highest Band Edge / 1 RB

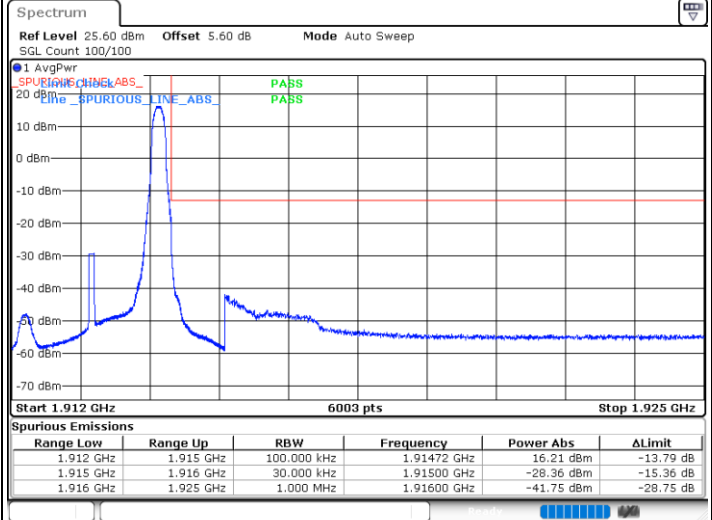

Date: 27.APR.2025 19:13:39

Lowest Band Edge / Full RB

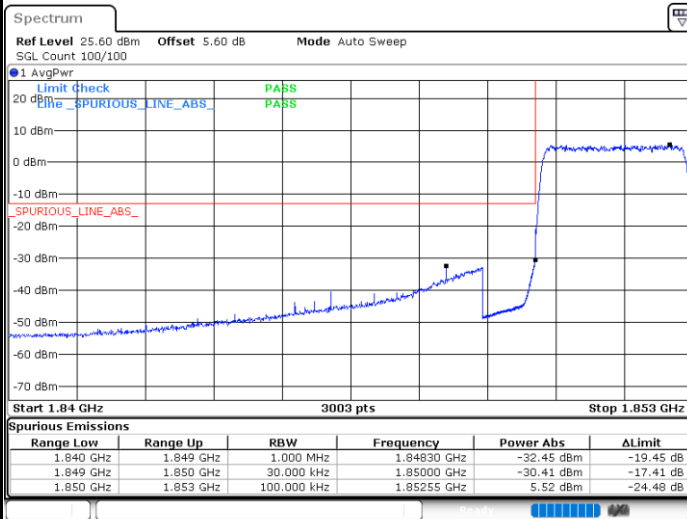

Date: 27.APR.2025 18:56:15

Highest Band Edge / Full RB

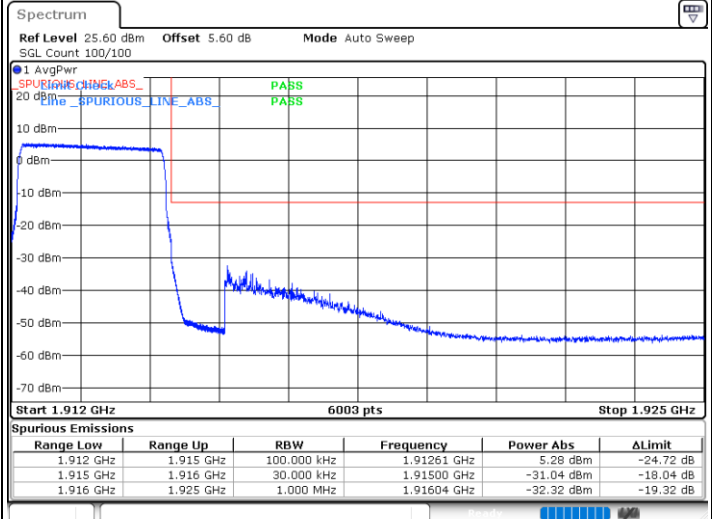

Date: 27.APR.2025 19:19:23



LTE Band 25 / 5MHz / QPSK

Lowest Band Edge / 1 RB

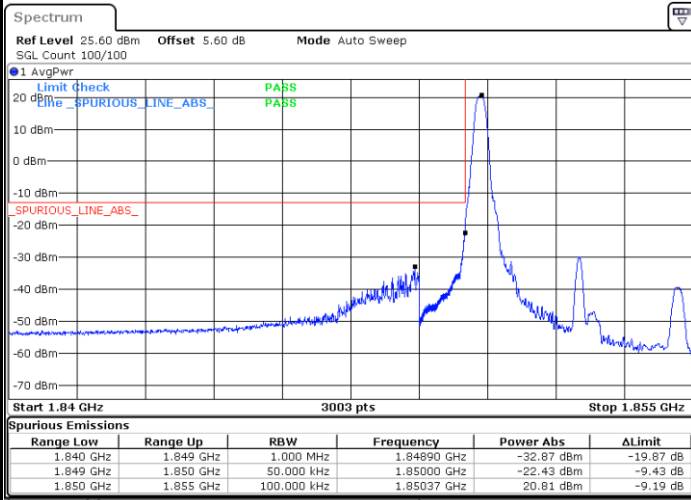

Date: 27.APR.2025 19:26:50

Highest Band Edge / 1 RB

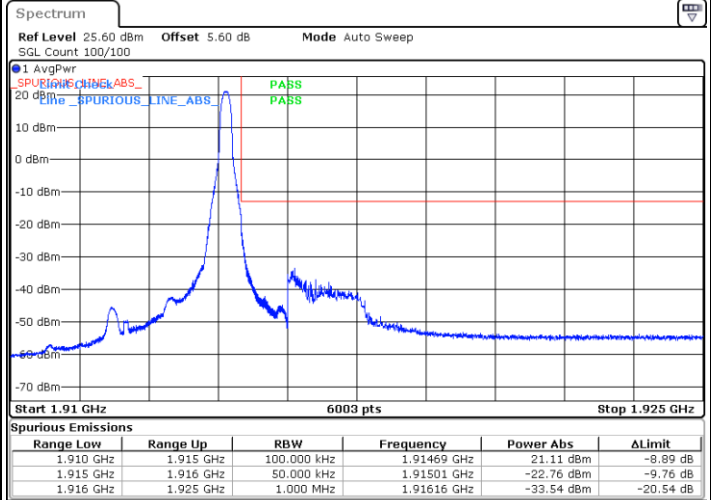

Date: 27.APR.2025 19:38:17

Lowest Band Edge / Full RB

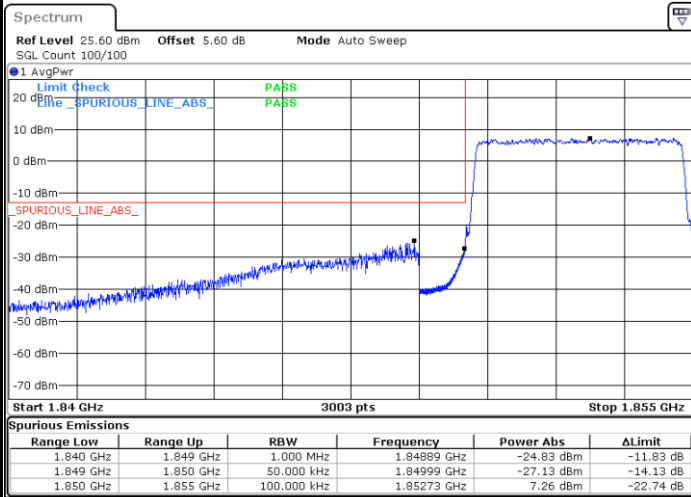

Date: 27.APR.2025 19:21:09

Highest Band Edge / Full RB

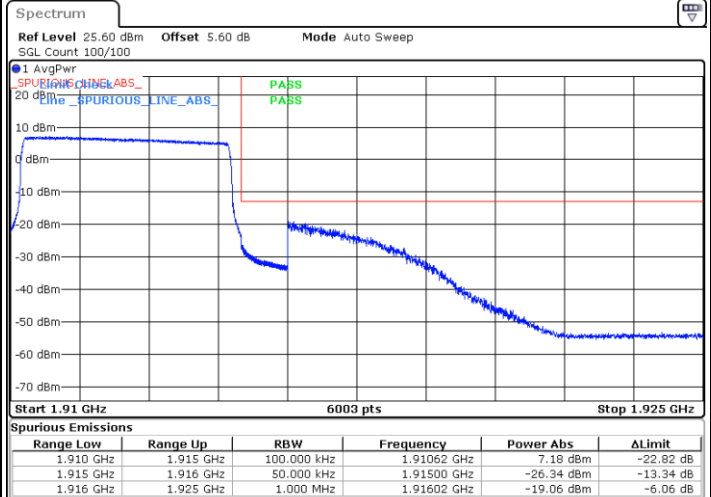

Date: 27.APR.2025 19:34:34



LTE Band 25 / 5MHz / 16QAM

Lowest Band Edge / 1RB

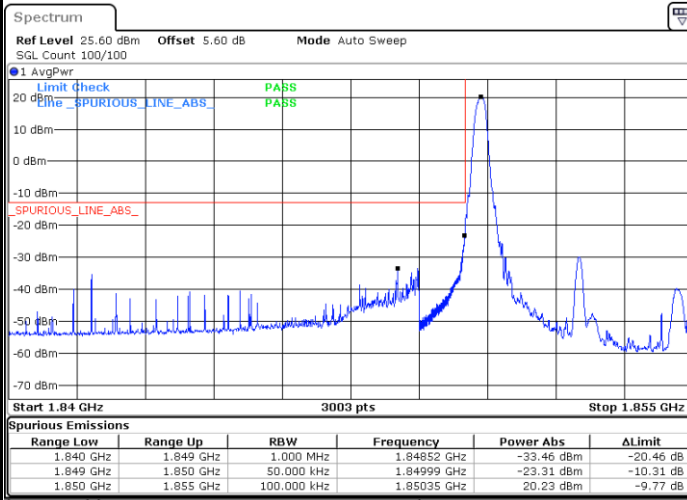

Date: 27.APR.2025 19:27:45

Highest Band Edge / 1 RB

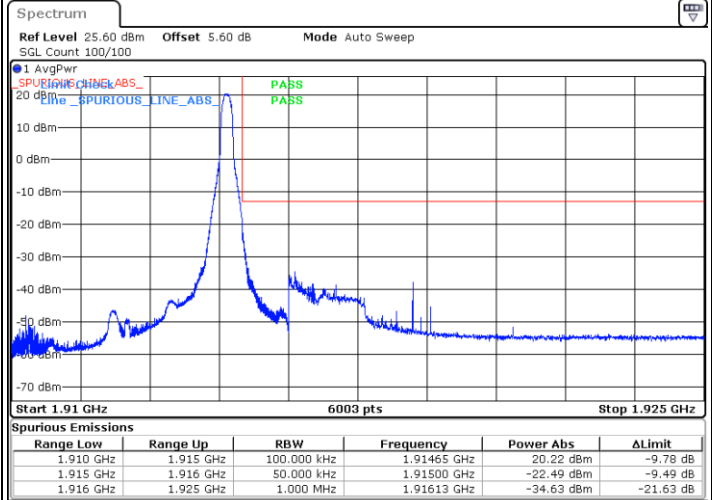

Date: 27.APR.2025 19:39:13

Lowest Band Edge / Full RB

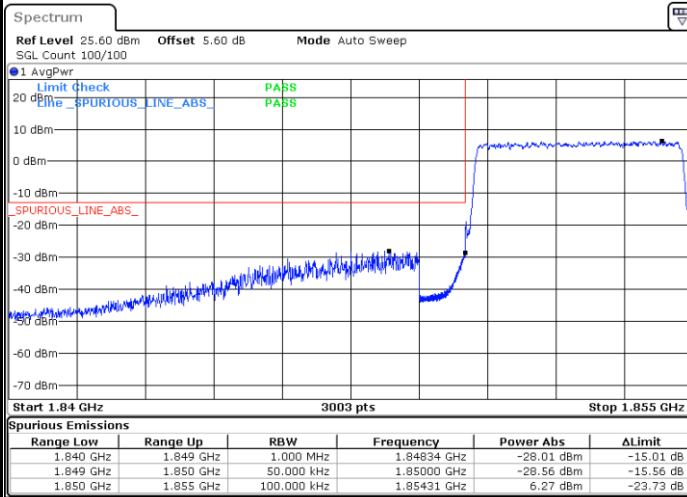

Date: 27.APR.2025 19:22:04

Highest Band Edge / Full RB

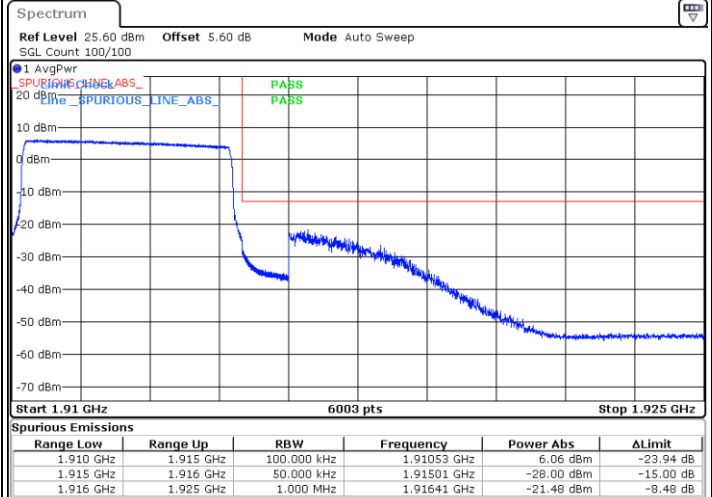

Date: 27.APR.2025 19:35:29



LTE Band 25 / 5MHz / 64QAM

Lowest Band Edge / 1RB

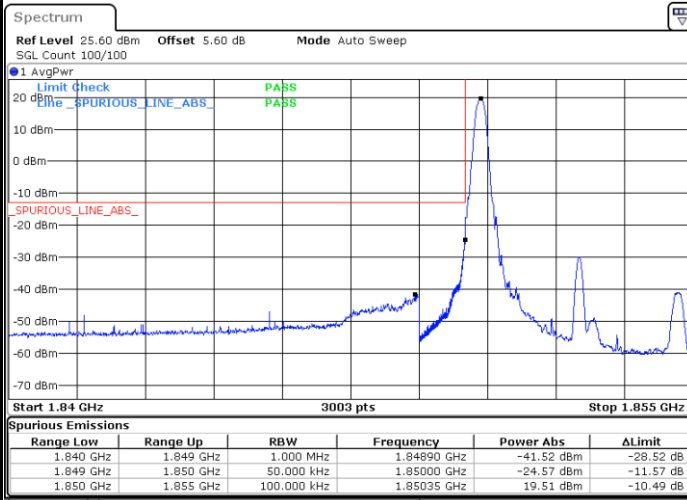

Date: 27.APR.2025 19:28:40

Highest Band Edge / 1 RB

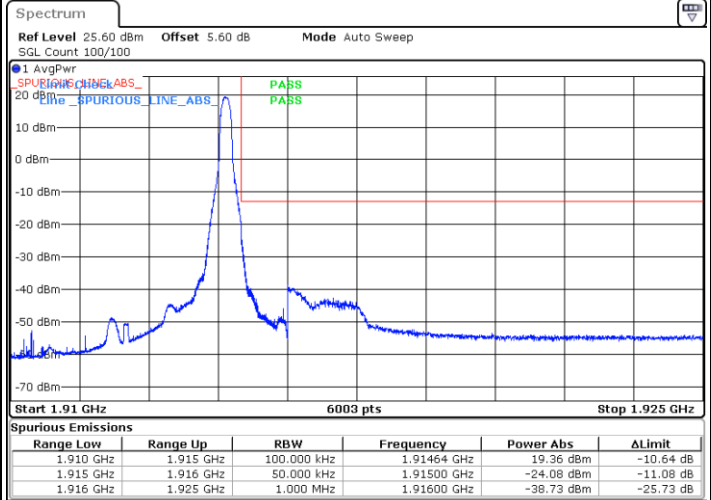

Date: 27.APR.2025 19:40:08

Lowest Band Edge / Full RB

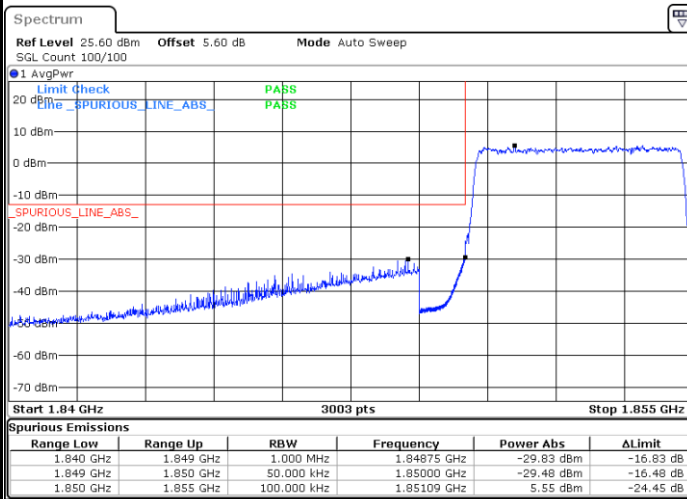

Date: 27.APR.2025 19:22:59

Highest Band Edge / Full RB

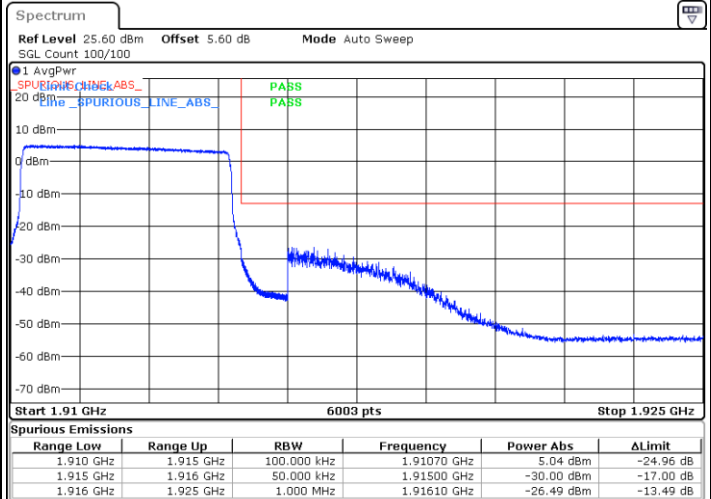

Date: 27.APR.2025 19:36:24



LTE Band 25 / 5MHz / 256QAM

Lowest Band Edge / 1RB

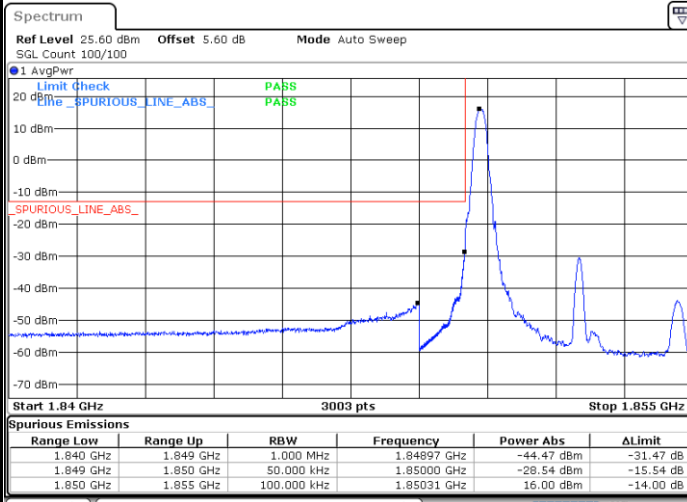

Date: 27.APR.2025 19:29:36

Highest Band Edge / 1 RB

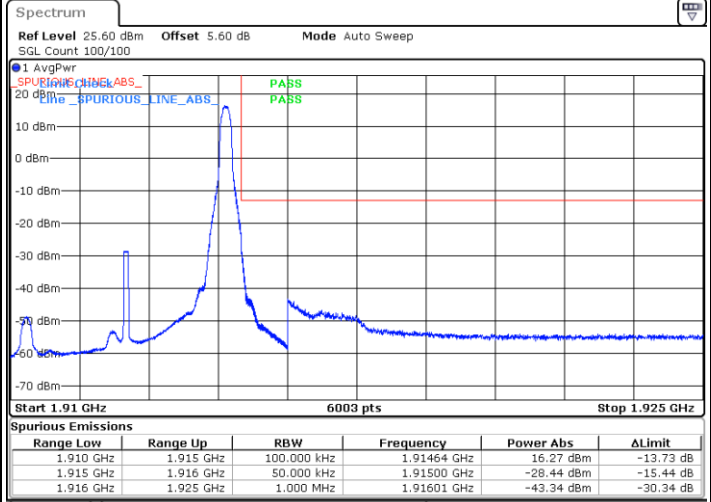

Date: 27.APR.2025 19:41:03

Lowest Band Edge / Full RB

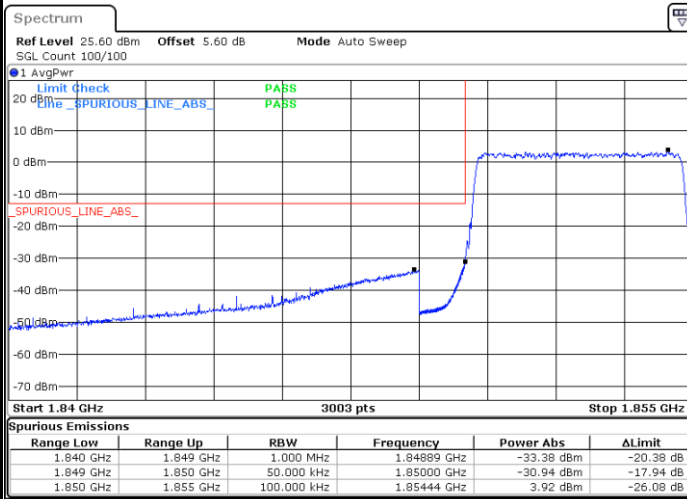

Date: 27.APR.2025 19:23:54

Highest Band Edge / Full RB

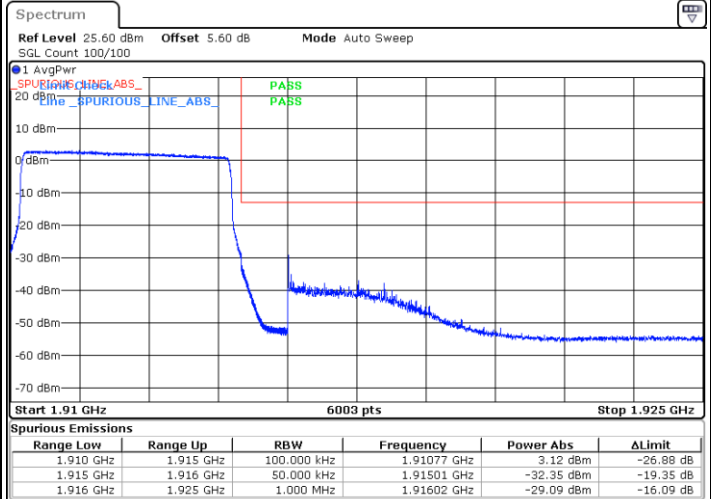

Date: 27.APR.2025 19:37:19



LTE Band 25 / 10MHz / QPSK

Lowest Band Edge / 1 RB

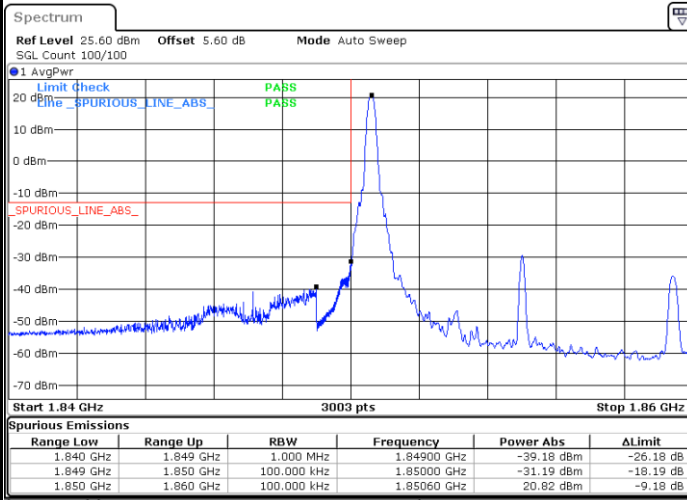

Date: 27.APR.2025 19:46:26

Highest Band Edge / 1 RB

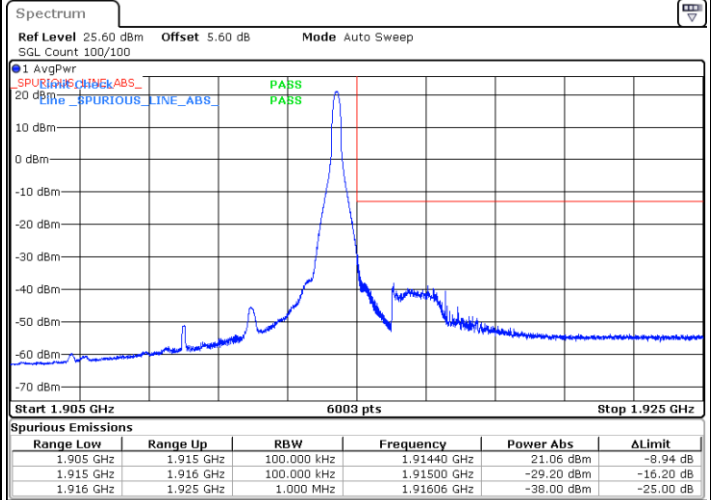

Date: 27.APR.2025 19:59:51

Lowest Band Edge / Full RB

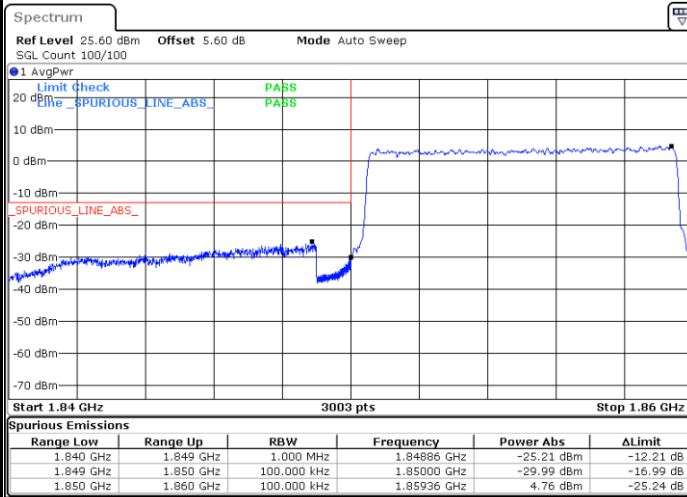

Date: 27.APR.2025 19:42:43

Highest Band Edge / Full RB

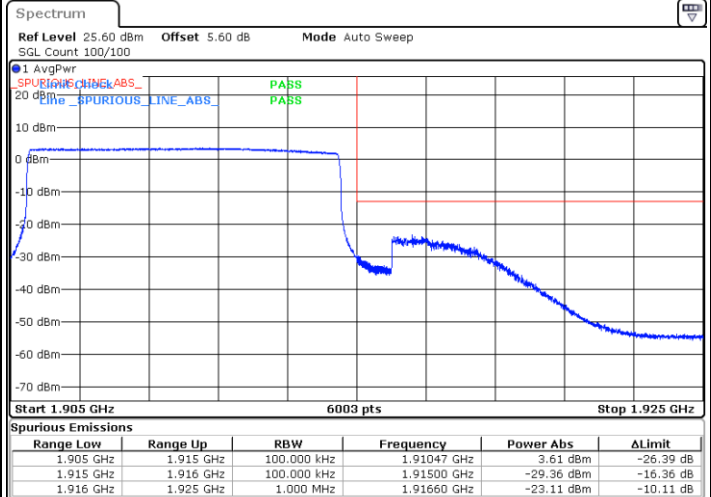

Date: 27.APR.2025 19:56:08





LTE Band 25 / 10MHz / 16QAM

Lowest Band Edge / 1 RB

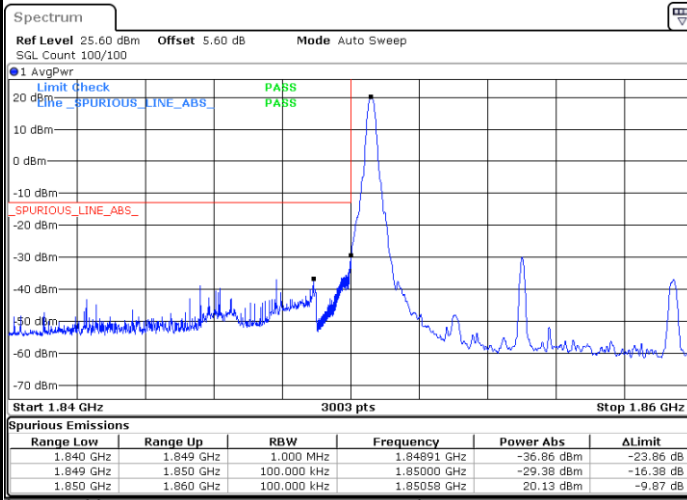

Date: 27.APR.2025 19:49:22

Highest Band Edge / 1 RB

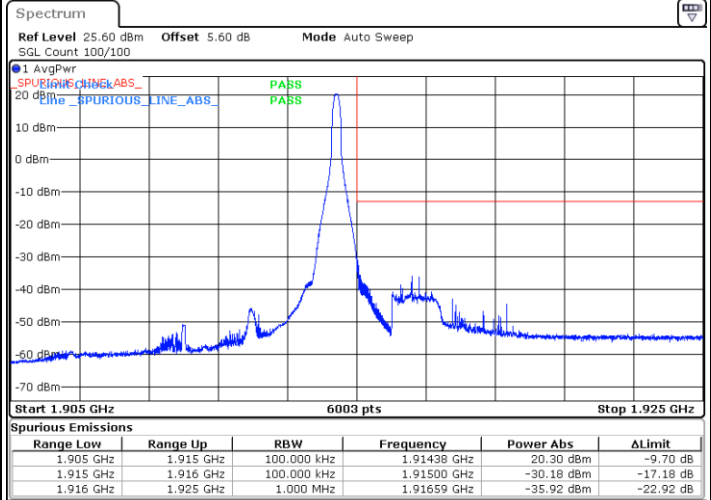

Date: 27.APR.2025 20:00:47

Lowest Band Edge / Full RB

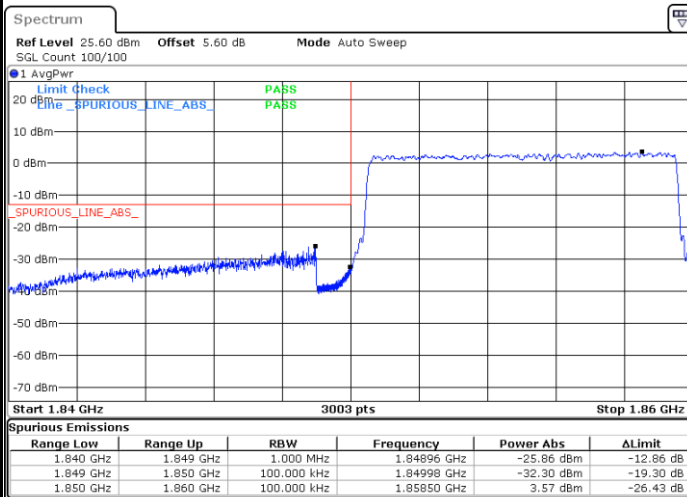

Date: 27.APR.2025 19:43:38

Highest Band Edge / Full RB

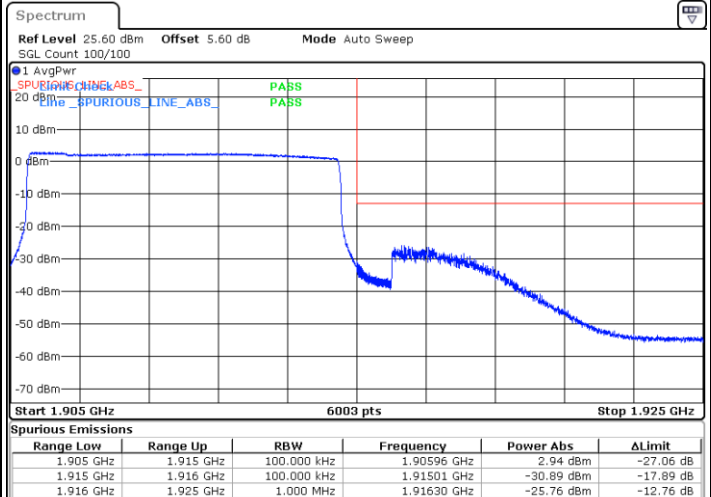

Date: 27.APR.2025 19:57:03



LTE Band 25 / 10MHz / 64QAM

Lowest Band Edge / 1 RB

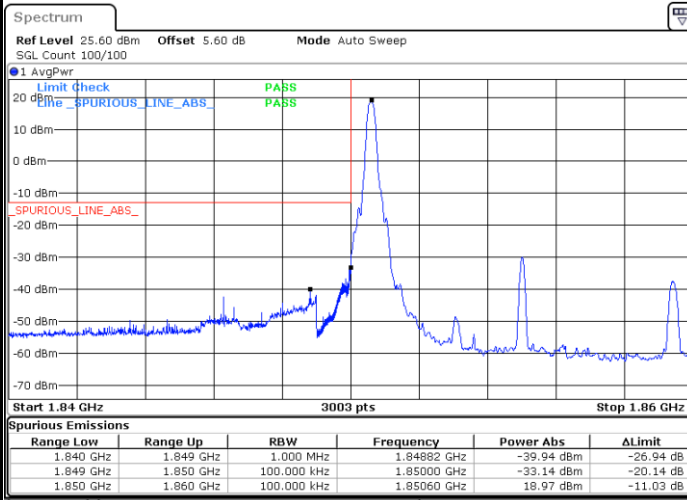

Date: 27.APR.2025 19:50:17

Highest Band Edge / 1 RB

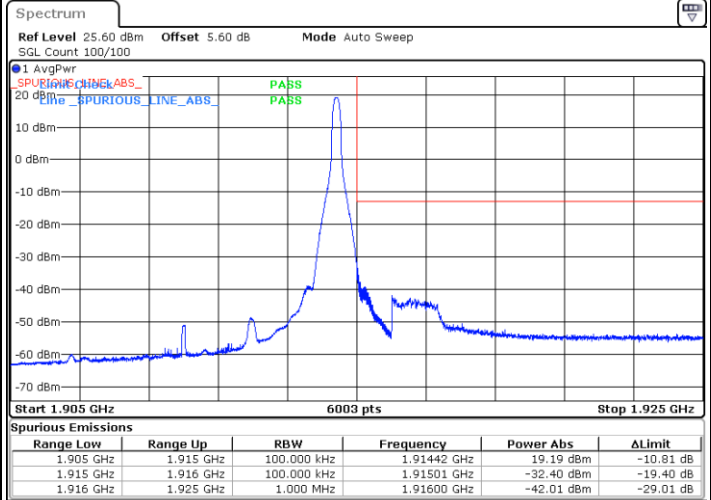

Date: 27.APR.2025 20:01:42

Lowest Band Edge / Full RB

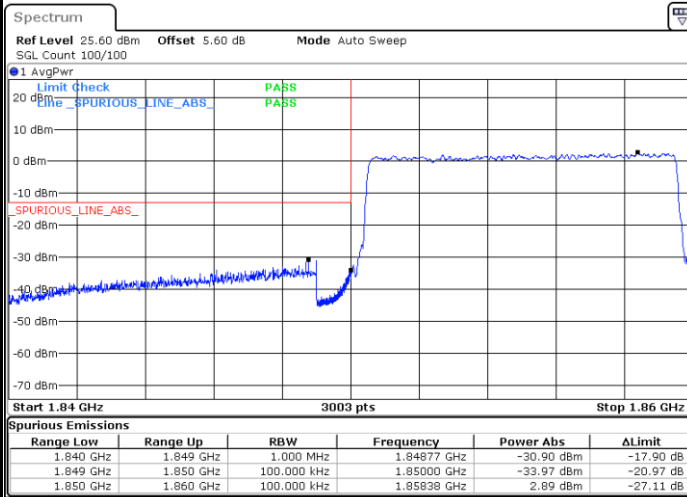

Date: 27.APR.2025 19:44:33

Highest Band Edge / Full RB

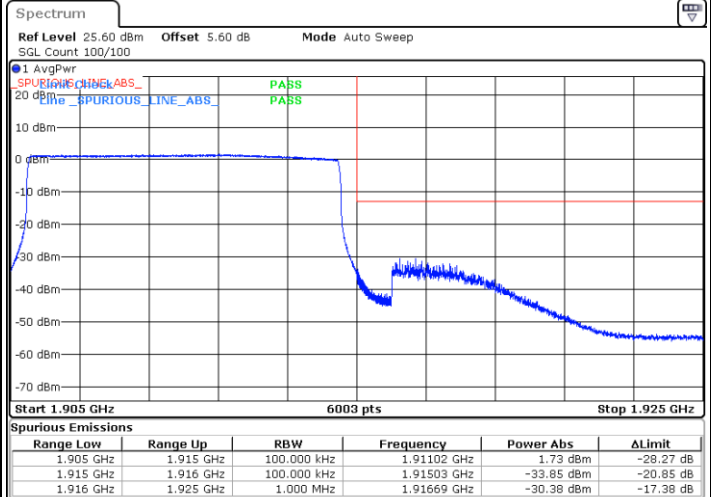

Date: 27.APR.2025 19:57:58



LTE Band 25 / 10MHz / 256QAM

Lowest Band Edge / 1 RB

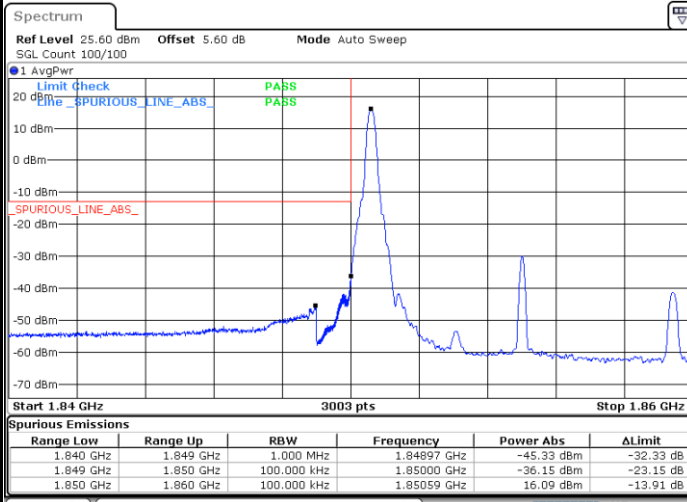

Date: 27.APR.2025 19:51:12

Highest Band Edge / 1 RB

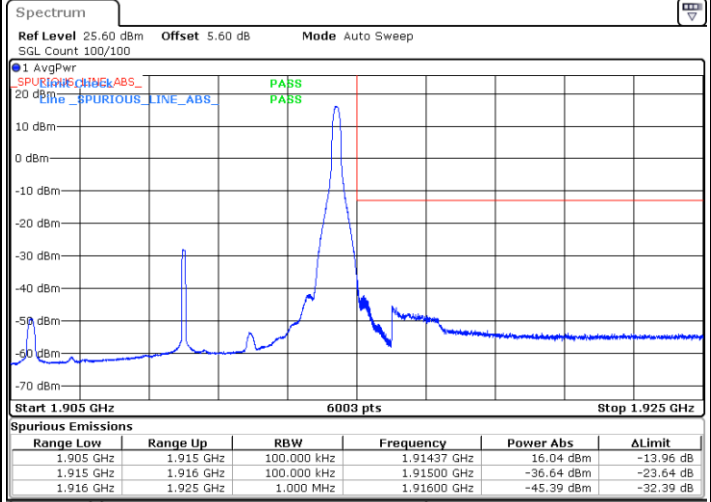

Date: 27.APR.2025 20:02:37

Lowest Band Edge / Full RB

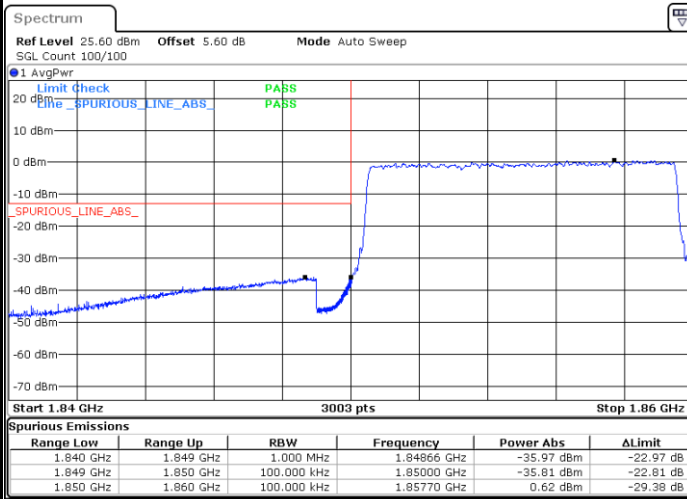

Date: 27.APR.2025 19:45:28

Highest Band Edge / Full RB

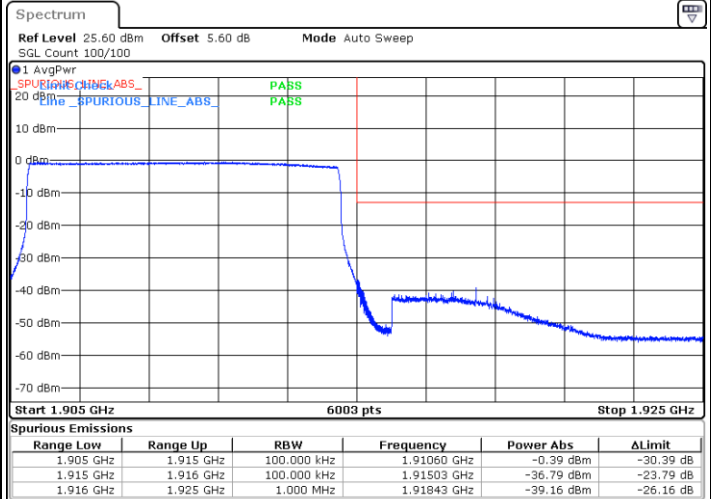

Date: 27.APR.2025 19:58:53



LTE Band 25 / 15MHz / QPSK

Lowest Band Edge / 1 RB

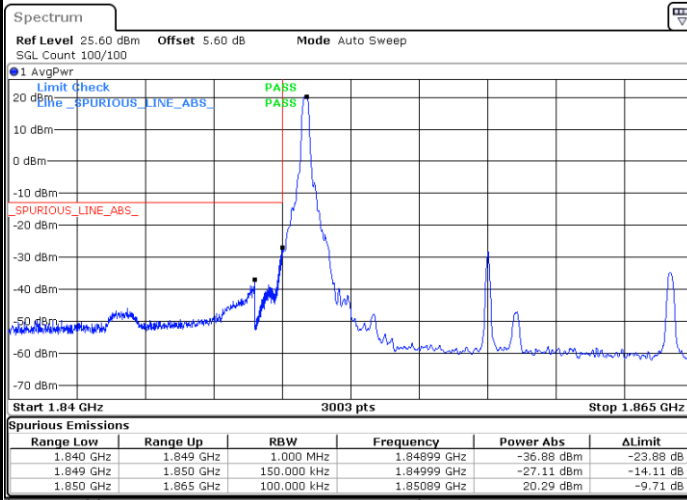

Date: 27.APR.2025 20:09:55

Highest Band Edge / 1 RB

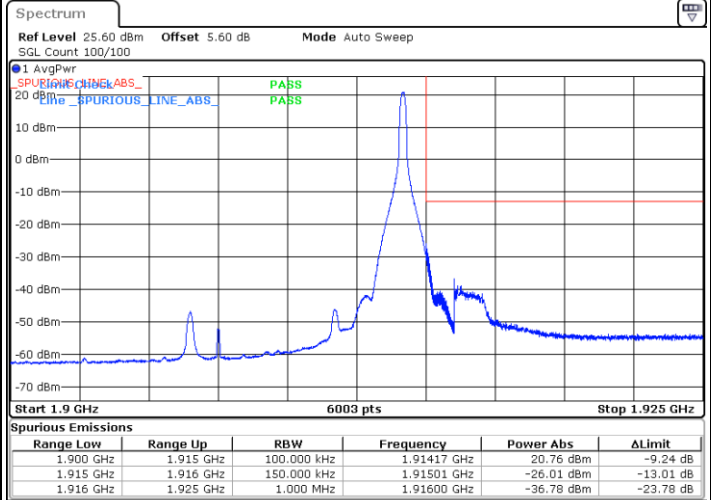

Date: 27.APR.2025 20:21:19

Lowest Band Edge / Full RB

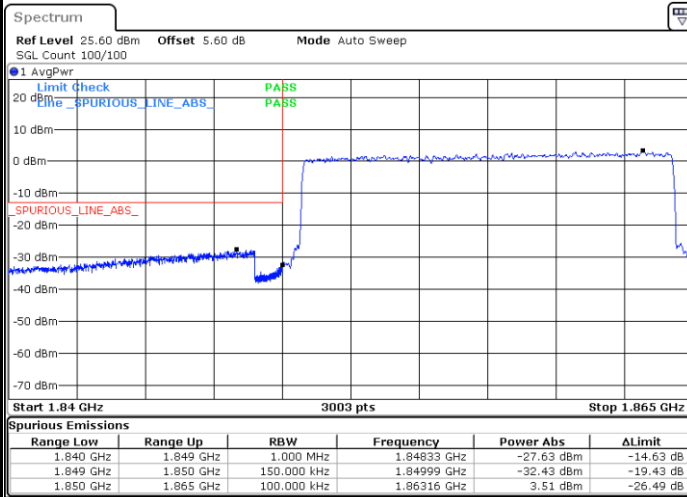

Date: 27.APR.2025 20:04:14

Highest Band Edge / Full RB

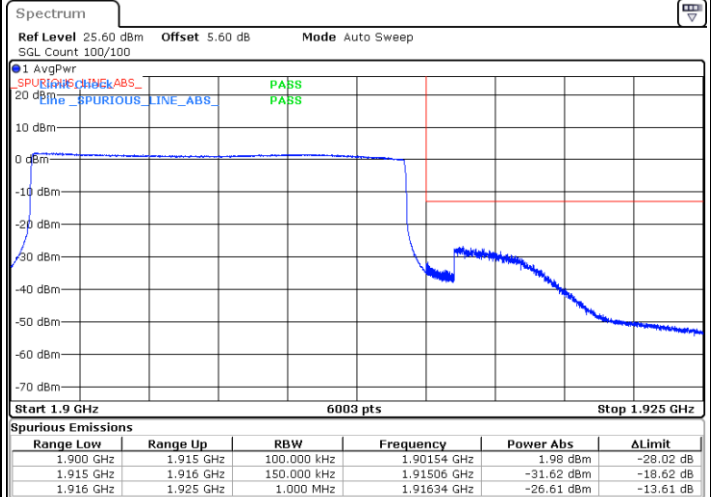

Date: 27.APR.2025 20:17:39