

TEST REPORT

FCC ID: 2AUWK-ROK1

Product: MOBILE PHONE

Model No.: Rok 1

Additional Model No.: N/A

Trade Mark: N/A

Report No.: TCT210205E037

Issued Date: Apr. 21, 2021

Issued for:

Mdc Corp

2920 nw 72 ave, Miami, Florida 33122, United States

Issued By:

Shenzhen Tongce Testing Lab.

TCT Testing Industrial Park, Fuqiao 5th Industrial Zone, Fuhai Street, Bao'an District, Shenzhen, Guangdong, 518103, People's Republic of China

TEL: +86-755-27673339

FAX: +86-755-27673332

Note: *This report shall not be reproduced except in full, without the written approval of Shenzhen Tongce Testing Lab.*

This document may be altered or revised by Shenzhen Tongce Testing Lab personnel only, and shall be noted in the revision section of the document. The test results in the report only apply to the tested sample.

TABLE OF CONTENTS

1. Test Certification	3
2. Test Result Summary	4
3. EUT Description.....	5
4. General Information.....	5
4.1. Test environment and mode.....	6
4.2. Test Mode.....	8
4.3. Description of Support Units.....	9
4.4. Configuration of Tested System	10
4.5. Measurement Results Explanation Example.....	10
5. Facilities and Accreditations	11
5.1. Facilities	11
5.2. Location	11
5.3. Measurement Uncertainty.....	11
6. Test Results and Measurement Data	12
6.1. Conducted Output Power Measurement	12
6.2. Peak to Average Ratio.....	14
6.3. 99% Occupied Bandwidth and 26dB Bandwidth Measurement	18
6.4. Band Edge and Conducted Spurious Emission Measurement	22
6.5. Effective Radiated Power and Effective Isotropic Radiated Power Measurement	27
6.6. Field Strength of Spurious Radiation Measurement	33
6.7. Frequency Stability Measurement	39

Appendix A: Photographs of Test Setup

Appendix B: Photographs of EUT

1. Test Certification

Product:	MOBILE PHONE
Model No.:	Rok 1
Additional Model No.:	N/A
Trade Mark:	N/A
Applicant:	Mdc Corp
Address:	2920 nw 72 ave, Miami, Florida 33122, United States
Manufacturer:	Mdc Corp
Address:	2920 nw 72 ave, Miami, Florida 33122, United States
Date of Test:	Feb. 08, 2021 – Apr. 20, 2021
Applicable Standards:	FCC CFR Title 47 Part 2 FCC CFR Title 47 Part22 FCC CFR Title 47 Part24

The above equipment has been tested by Shenzhen Tongce Testing Lab and found compliance with the requirements set forth in the technical standards mentioned above. The results of testing in this report apply only to the product/system, which was tested. Other similar equipment will not necessarily produce the same results due to production tolerance and measurement uncertainties.

Tested By:



Rleo

Date:

Apr. 20, 2021

Reviewed By:



Beryl Zhao

Date:

Apr. 21, 2021

Approved By:



Tomsin

Date:

Apr. 21, 2021

2. Test Result Summary

Requirement	CFR 47 Section	Result
Conducted Output Power	§22.913; §2.1046 §24.232;	PASS
Peak-to-Average Ratio	§2.1046; §24.232(d) §22.913;	PASS
Effective Radiated Power	§2.1046; §22.913(a) §24.232;	PASS
Equivalent Isotropic Radiated Power	§2.1046; §22.913(a) §24.232;	PASS
Occupied Bandwidth	§2.1049	PASS
Band Edge	§2.1051 §22.917(a) §24.238(a)	PASS
Conducted Spurious Emission	§2.1051; §22.917 §24.238;	PASS
Field Strength of Spurious Radiation	§2.1053; §22.917(a) §24.238;	PASS
Frequency Stability for Temperature & Voltage	§2.1055; §22.355 §24.235;	PASS

Note:

1. PASS: Test item meets the requirement.
2. Fail: Test item does not meet the requirement.
3. N/A: Test case does not apply to the test object.
4. The test result judgment is decided by the limit of test standard.

3. EUT Description

Product:	MOBILE PHONE
Model No.:	Rok 1
Additional Model No.:	N/A
Trade Mark:	N/A
Tx Frequency:	GSM/GPRS 850: 824.2MHz ~ 848.8MHz GSM/GPRS 1900: 1850.2MHz ~ 1909.8MHz
Rx Frequency:	GSM/GPRS 850: 869.2MHz ~ 893.8MHz GSM/GPRS 1900: 1930.2MHz ~ 1989.8MHz
Maximum Output Power to Antenna:	GSM850: 32.9dBm GSM1900: 28.9dBm GPRS850: 32.8dBm GPRS1900: 28.7dBm
99% Occupied Bandwidth:	GSM850: 245KGXW GSM1900: 245KGXW GPRS850 Class 8: 245KGXW GPRS1900 Class 8: 245KGXW
Type of Modulation:	GSM/GPRS: GMSK
Antenna Type:	Internal Antenna
Antenna Gain:	GSM/GPRS 850: 1.4dBi GSM/GPRS 1900: 3.1dBi
Power Supply:	Rechargeable Li-ion Battery DC 3.7V
AC adapter:	Adapter Information: Model: CH-35X Input: AC 100-240 V, 50/60 Hz Output: DC 5.0 V, 500mA

Note: The antenna gain listed in this report is provided by applicant, and the test laboratory is not responsible for this parameter.

4. General Information

4.1. Test environment and mode

Operating Environment:	
Temperature:	25.0 °C
Humidity:	56 % RH
Atmospheric Pressure:	1010 mbar
Test Mode:	
Operation mode:	Keep the EUT in communication with CMU200 and select channel with modulation

The sample was placed 0.8m & 1.5m for the measurement below & above 1GHz above the ground plane of 3m chamber. Measurements in both horizontal and vertical polarities were performed. During the test, each emission was maximized by: having the EUT continuously working, investigated all operating modes, rotated about all 3 axis (X, Y & Z) and considered typical configuration to obtain worst position, manipulating interconnecting cables, rotating the turntable, varying antenna height from 1m to 4m in both horizontal and vertical polarizations. The emissions worst-case (Z axis) are shown in Test Results of the following pages.

Description Operation Frequency

GSM 850		PCS1900	
Channel:	Frequency (MHz)	Channel:	Frequency (MHz)
128	824.20	512	1850.20
129	824.40	513	1850.40
....
189	836.40	660	1879.80
190	836.60	661	1880.00
191	836.80	662	1880.20
...
250	848.60	809	1909.60
251	848.80	810	1909.80

4.2. Test Mode

Antenna port conducted and radiated test items were performed according to KDB 971168 D01 Power Meas. License Digital Systems v03r01 with maximum output power. Radiated measurements were performed with rotating EUT in different three orthogonal test planes to find the maximum emission.

Radiated emissions were investigated as following frequency range:

1. 30 MHz to 10000 MHz for GSM850.
2. 30 MHz to 20000 MHz for PCS1900.

All modes and data rates and positions were investigated.

Test modes are chosen to be reported as the worst case configuration below:

Test Mode		
Band	Radiated TCs	Conducted TCs
GSM 850	GSM Link GPRS class 12 Link	GSM Link GPRS class 12 Link
PCS 1900	GSM Link GPRS class 12 Link	GSM Link GPRS class 12 Link

Note: The maximum power levels are chosen to test as the worst case configuration as follows:

GPRS multi-slot class 12 mode for GMSK modulation. only these modes were used for all tests. In addition to above worst-case test, below investigating on all data rates and all modes are compliance with each FCC test case which has specific test limits. For spurious emissions at antenna port, the EUT was investigated the band edges on low and high channels, and the unwanted spurious emissions on middle channel for all modes, the results are PASS, then only the worst-results were reported in the test report. The Radiated Spurious emissions for GPRS modes were investigated on the middle channel and the PASS results were not worst than those data tested from the highest power channels.

4.3. Description of Support Units

The EUT has been tested as an independent unit together with other necessary accessories or support units. The following support units or accessories were used to form a representative test configuration during the tests.

Equipment	Model No.	Serial No.	FCC ID	Trade Name
/	/	/	/	/

Note:

1. All the equipment/cables were placed in the worst-case configuration to maximize the emission during the test.
2. Grounding was established in accordance with the manufacturer's requirements and conditions for the intended use.

4.4. Configuration of Tested System

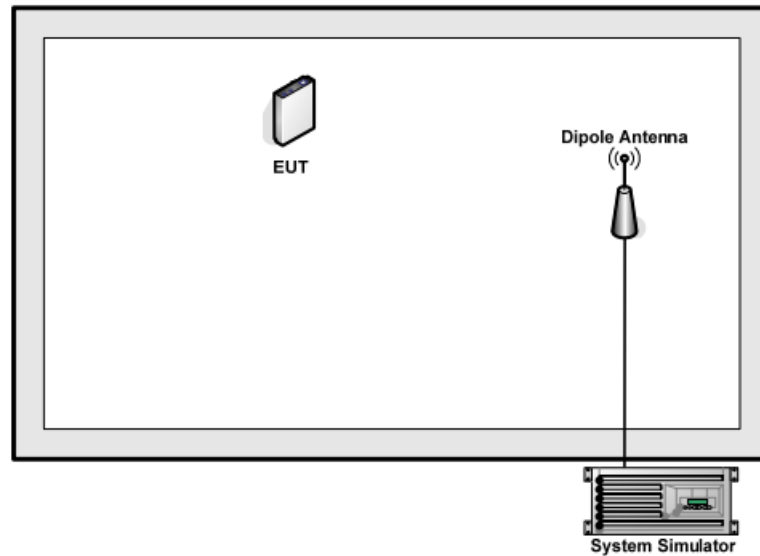

4.5. Measurement Results Explanation Example

For all conducted test items:

The offset level is set in the spectrum analyzer to compensate the RF cable loss and attenuator factor between RF conducted output port and spectrum analyzer. With the offset compensation, the spectrum analyzer reading level will be exactly the RF output level. The spectrum analyzer offset is derived from RF cable loss and attenuator factor.

Offset = RF cable loss + attenuator factor.

The following shows an offset computation example with RF cable loss 3 dB and a 5dB attenuator.

Example: $Offset (dB) = RF\ cable\ loss (dB) + attenuator\ factor (dB)$
 $= 8(dB)$

5. Facilities and Accreditations

5.1. Facilities

The test facility is recognized, certified, or accredited by the following organizations:

- FCC - Registration No.: 645098

Shenzhen Tongce Testing Lab.

The 3m Semi-anechoic chamber has been registered and fully described in a report with the (FCC) Federal Communications Commission. The acceptance letter from the FCC is maintained in our files.

- IC - Registration No.: 10668A-1

The 3m Semi-anechoic chamber of SHENZHEN TONGCE TESTING LAB has been registered by Certification and Engineering Bureau of Industry Canada for radio equipment testing

5.2. Location

Shenzhen Tongce Testing Lab.

Address: TCT Testing Industrial Park, Fuqiao 5th Industrial Zone, Fuhai Street, Bao'an District, Shenzhen, Guangdong, 518103, People's Republic of China

TEL: +86-755-27673339

5.3. Measurement Uncertainty

The reported uncertainty of measurement $y \pm U$, where expanded uncertainty U is based on a standard uncertainty multiplied by a coverage factor of $k=2$, providing a level of confidence of approximately 95 %.

No.	Item	MU
1	Conducted Emission	$\pm 2.56\text{dB}$
2	RF power, conducted	$\pm 0.12\text{dB}$
3	Spurious emissions, conducted	$\pm 0.11\text{dB}$
4	All emissions, radiated(<1G)	$\pm 3.92\text{dB}$
5	All emissions, radiated(>1G)	$\pm 4.28\text{dB}$
6	Temperature	$\pm 0.1^\circ\text{C}$
7	Humidity	$\pm 1.0\%$

6. Test Results and Measurement Data

6.1. Conducted Output Power Measurement

6.1.1. Test Specification

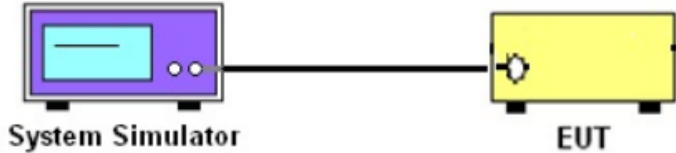
Test Requirement:	FCC part 22.913(a) and FCC part 24.232(b) FCC part 27.50(d);
Test Method:	FCC KDB 971168 D01 v03r01
Operation mode:	Refer to item 4.1
Limits:	GSM 850: 7W PCS 1900: 2W
Test Setup:	 <p>The diagram illustrates the test setup. On the left is a purple box labeled 'System Simulator' with a screen and two buttons. A black line representing a cable connects it to a yellow box on the right labeled 'EUT' (Equipment Under Test) which has a circular port on its side.</p>
Test Procedure:	<ol style="list-style-type: none"> 1. The transmitter output port was connected to the system simulator. 2. Set EUT at maximum power through system simulator. 3. Select lowest, middle, and highest channels for each band and different modulation. 4. Measure the maximum burst average power for GSM and maximum average power for other modulation signal.
Test Result:	PASS

6.1.2. Test Instruments

Equipment	Manufacturer	Model	Serial Number	Calibration Due
System simulator	R&S	CMU200	110188	Sep. 11, 2021
RF cable (9kHz-40GHz)	TCT	RE-05	N/A	Sep. 02, 2021
Antenna Connector	TCT	RFC-02	N/A	Sep. 02, 2021

Note: The calibration interval of the above test instruments is 12 months and the calibrations are traceable to international system unit (SI).

6.1.3. Test data

Conducted Power Measurement Results:

Average Conducted Power (*Unit: dBm)						
Band	GSM850			PCS 1900		
Channel	128	190	251	512	661	810
Frequency(MHz)	824.2	836.6	848.8	1850.2	1880.0	1909.8
GSM	32.7	32.9	32.7	28.6	28.9	28.7
GPRS class8	32.5	32.8	32.4	28.5	28.7	28.6
GPRS class10	31.46	31.62	31.44	28.13	28.15	28.13
GPRS class11	30.53	30.56	30.52	27.24	27.26	27.23
GPRS class12	29.50	29.49	29.62	26.18	26.22	26.20

6.2. Peak to Average Ratio

6.2.1. Test Specification

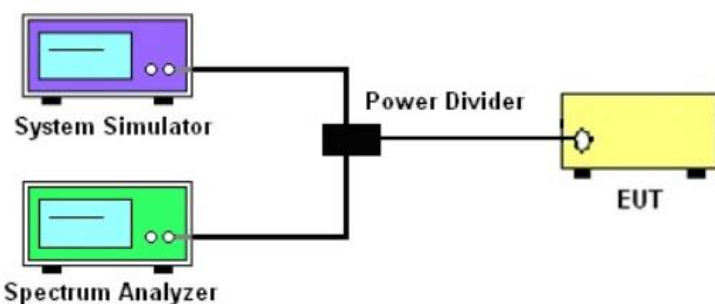
Test Requirement:	FCC part 24.232(d) ; FCC part 22.913;
Test Method:	ANSI C63.26:2013
Operation mode:	Refer to item 4.1
Limit:	The peak-to-average ratio (PAR) of the transmission may not exceed 13 dB.
Test Setup:	 <p>The diagram illustrates the test setup. On the left, there are two instruments: a purple System Simulator and a green Spectrum Analyzer. Both are connected to a central black Power Divider. The Power Divider is then connected to a yellow EUT (Equipment Under Test) on the right.</p>
Test Procedure:	<ol style="list-style-type: none"> 1. The testing follows FCC KDB 971168 D01v03r01 Section 5.7.1. 2. The EUT was connected to spectrum analyzer and system simulator via a power divider. 3. Set EUT to transmit at maximum output power. 4. For GSM/EGPRS operating modes, signal gating is implemented on the spectrum analyzer by triggering from the system simulator. 5. Set the CCDF (Complementary Cumulative Distribution Function) option of the spectrum analyzer. Record the maximum PAPR level associated with a probability of 0.1%.
Test Result:	PASS

6.2.2. Test Instruments

Equipment	Manufacturer	Model	Serial Number	Calibration Due
System simulator	R&S	CMU200	110188	Sep. 11, 2021
Spectrum Analyzer	R&S	FSU	200054	Sep. 11, 2021
RF cable (9kHz-40GHz)	TCT	RE-05	N/A	Sep. 02, 2021
Antenna Connector	TCT	RFC-02	N/A	Sep. 02, 2021

Note: The calibration interval of the above test instruments is 12 months and the calibrations are traceable to international system unit (SI).

6.2.3. Test Data

Cellular Band			
Mode	GSM850		
Channel	128	190	251
Frequency (MHz)	824.2	836.6	848.8
Peak-to-Average Ratio (dB)	7.69	7.69	7.66

PCS Band			
Mode	GSM 1900		
Channel	512	661	810
Frequency (MHz)	1850.2	1880	1909.8
Peak-to-Average Ratio (dB)	7.66	7.69	8.72

Test plots as follows:

GSM 850

Peak-to-Average Ratio on Channel 128

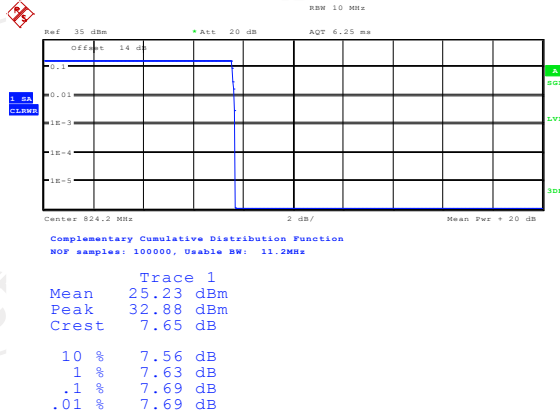

Date: 20.APR.2021 09:58:14

Peak-to-Average Ratio on Channel 190

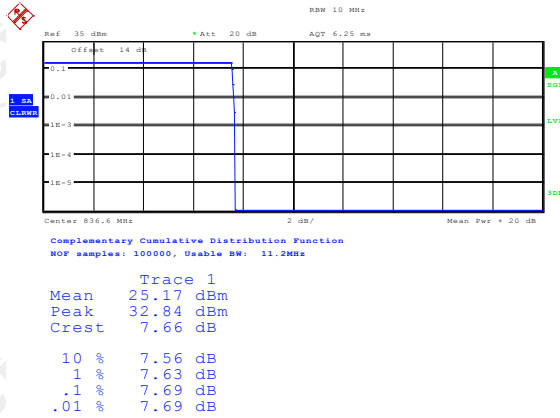

Date: 20.APR.2021 10:00:37

Peak-to-Average Ratio on Channel 251

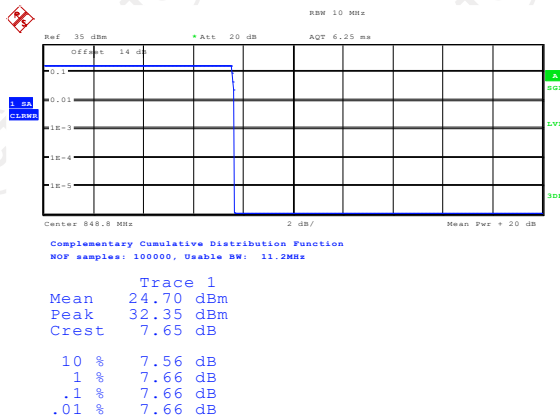

Date: 20.APR.2021 10:01:36

GSM 1900

Peak-to-Average Ratio on Channel 512

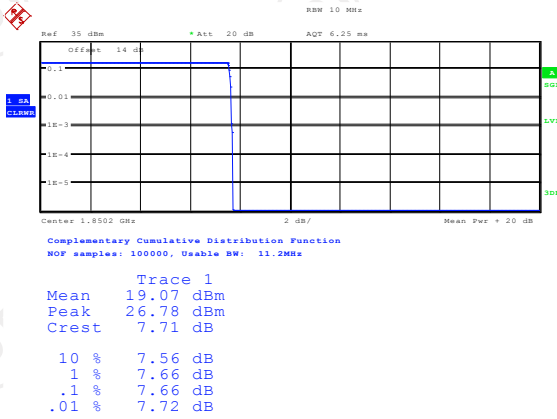

Date: 20.APR.2021, 11:40:12

Peak-to-Average Ratio on Channel 661

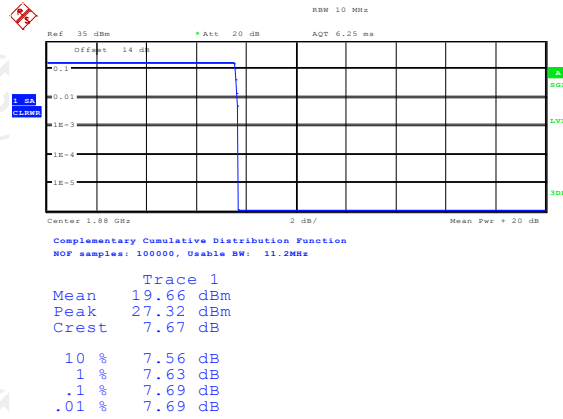

Date: 20.APR.2021 11:40:43

Peak-to-Average Ratio on Channel 810

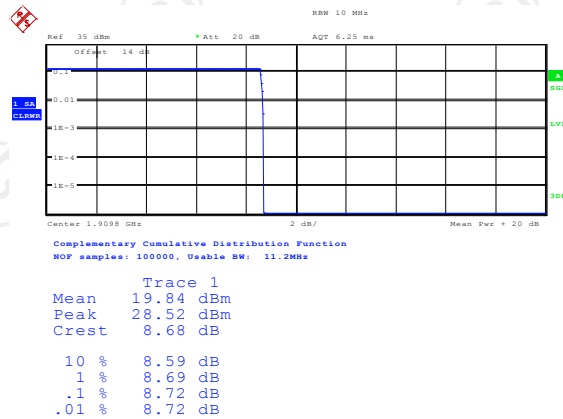

Date: 20.APR.2021 11:41:24

Note: All modes (GSM, GPRS) have been tested, only the test data of the worst mode(GSM) have been reported.

6.3. 99% Occupied Bandwidth and 26dB Bandwidth Measurement

6.3.1. Test Specification

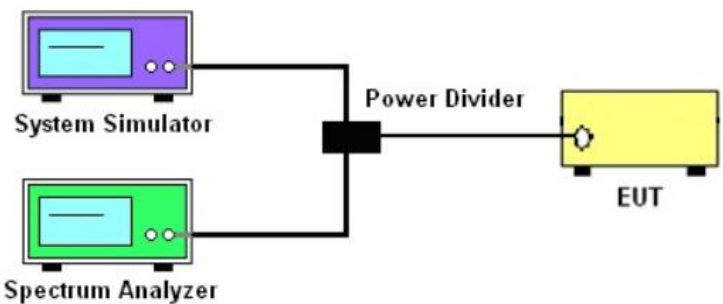
Test Requirement:	FCC part 2.1049
Test Method:	FCC KDB 971168 D01v03r01
Operation mode:	Refer to item 4.1
Limit:	N/A
Test Setup:	 <p>The diagram illustrates the test setup. A System Simulator (purple box) and a Spectrum Analyzer (green box) are connected to a Power Divider (black box). The Power Divider is then connected to the EUT (yellow box).</p>
Test Procedure:	<ol style="list-style-type: none"> 1. The testing follows FCC KDB 971168 D01v03r01 Section 4.2. 2. The EUT was connected to the spectrum analyzer and system simulator via a power divider. 3. The RF output of the EUT was connected to the spectrum analyzer by RF cable and attenuator. The path loss was compensated to the results for each measurement. 4. The 99% occupied bandwidth were measured, set RBW= 1% of span, VBW= 3*RBW, sample detector, trace maximum hold. 5. The 26dB bandwidth were measured, set RBW= 1% of EBW, VBW= 3*RBW, peak detector, trace maximum hold.
Test Result:	PASS

6.3.2. Test Instruments

Equipment	Manufacturer	Model	Serial Number	Calibration Due
System simulator	R&S	CMU200	110188	Sep. 11, 2021
Spectrum Analyzer	R&S	FSU	200054	Sep. 11, 2021
RF cable (9kHz-40GHz)	TCT	RE-05	N/A	Sep. 02, 2021
Antenna Connector	TCT	RFC-02	N/A	Sep. 02, 2021

Note: The calibration interval of the above test instruments is 12 months and the calibrations are traceable to international system unit (SI).

6.3.3. Test data

Cellular Band			
Mode	GSM850		
Channel	128	190	251
Frequency (MHz)	824.2	836.6	848.8
99% OBW (kHz)	245.50	243.50	244.50
26dB BW (kHz)	310.90	314.10	321.14

Cellular Band			
Mode	GSM1900		
Channel	512	661	810
Frequency (MHz)	1850.2	1880.0	1909.8
99% OBW (kHz)	245.00	245.00	243.50
26dB BW (kHz)	312.50	310.90	314.10

Test plots as follows:

Band: GSM 850 Test Mode: GSM Link (GMSK)

26dB&99% Occupied Bandwidth Plot on Channel 128

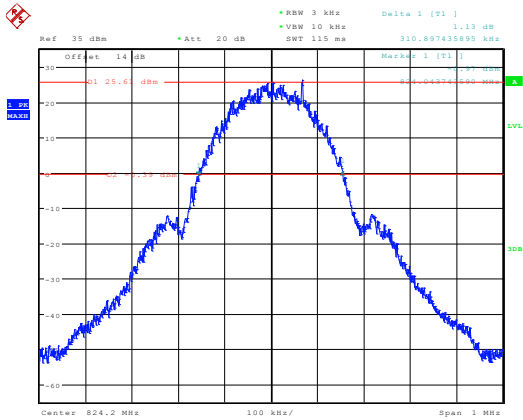

Date: 20 APR 2021 10:17:52

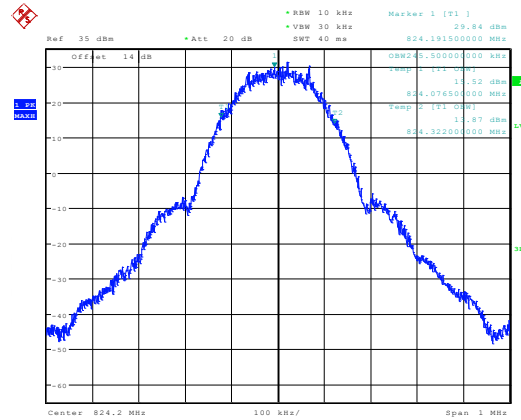

Date: 20 APR 2021 10:16:41

26dB&99% Occupied Bandwidth Plot on Channel 190

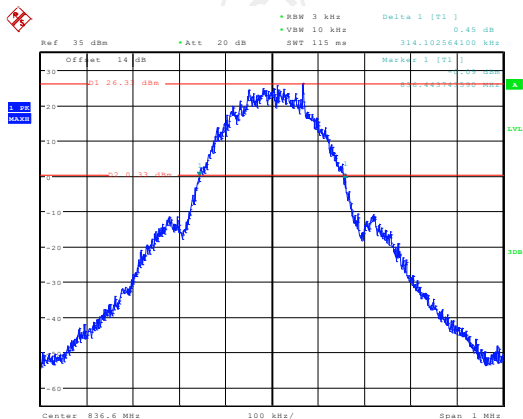

Date: 20 APR 2021 10:14:55

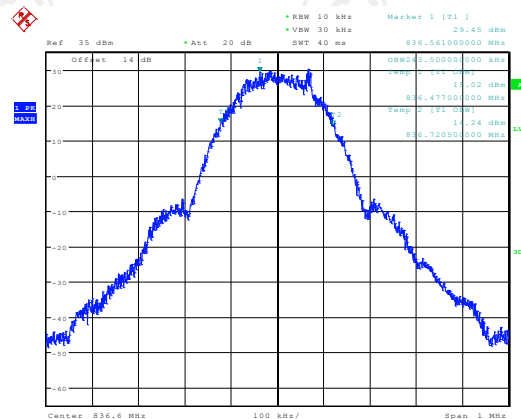

Date: 20 APR 2021 10:15:40

26dB&99% Occupied Bandwidth Plot on Channel 251

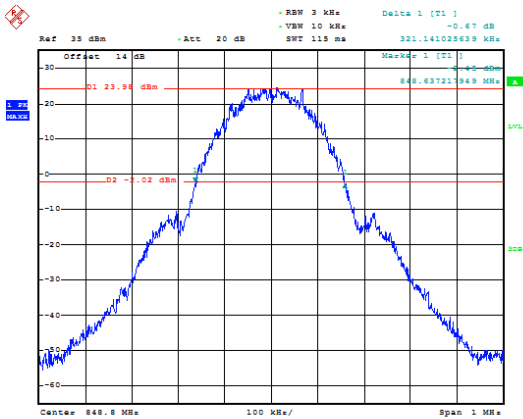

Date: 20 APR 2021 10:13:18

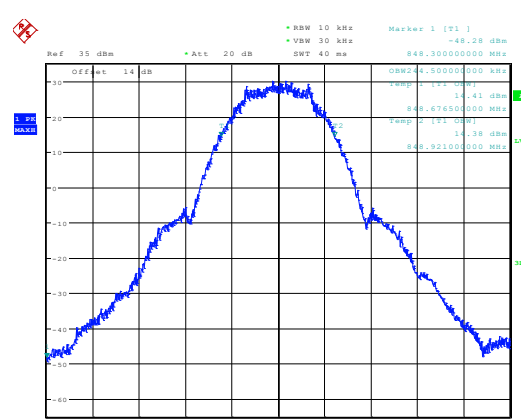

Date: 20 APR 2021 10:11:17

Band: GSM 1900 Test Mode: GSM Link (GMSK)

26dB&99% Occupied Bandwidth Plot on Channel 512

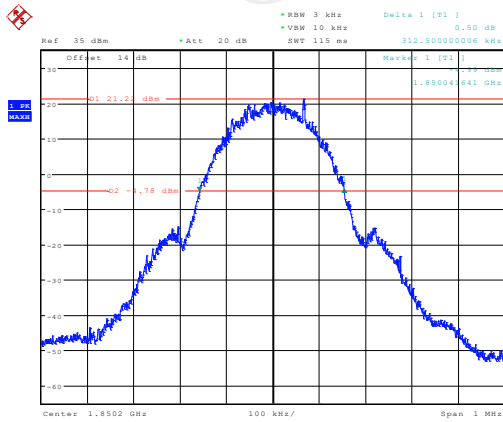

Date: 20 APR 2021 11:26:10

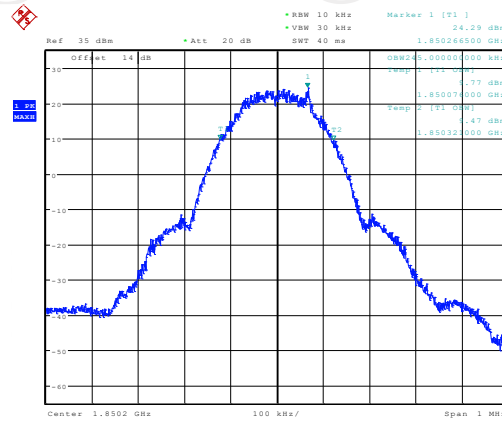

Date: 20 APR 2021 11:27:17

26dB&99% Occupied Bandwidth Plot on Channel 661

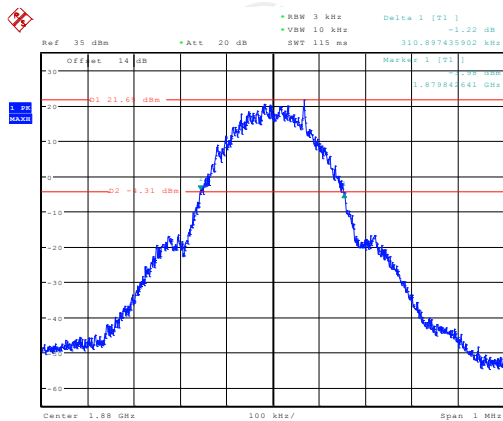

Date: 20 APR 2021 11:32:06

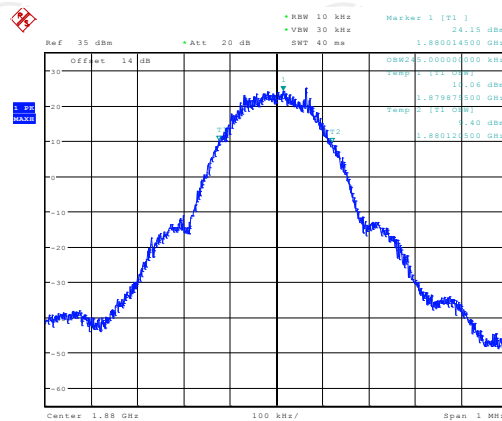

Date: 20 APR 2021 11:32:57

26dB&99% Occupied Bandwidth Plot on Channel 810

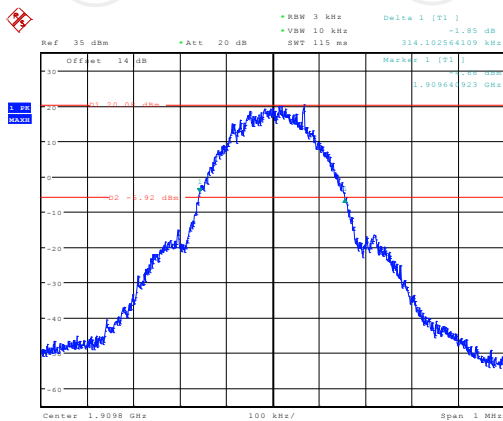

Date: 20 APR 2021 11:30:47

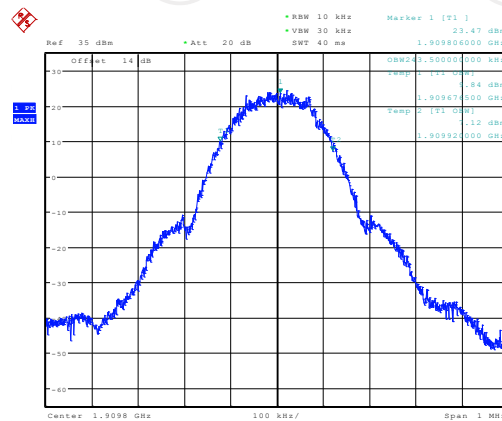

Date: 20 APR 2021 11:33:53

Note: All modes (GSM, GPRS) have been tested, only the test data of the worst mode (GSM) have been reported.

6.4. Band Edge and Conducted Spurious Emission Measurement

6.4.1. Test Specification

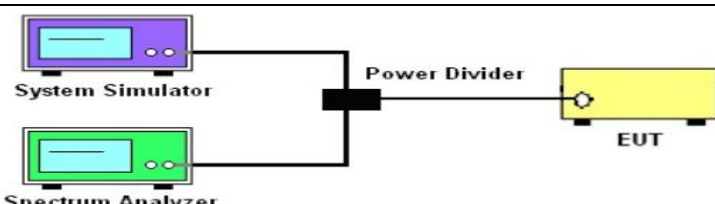
Test Requirement:	FCC part22.917(a) and FCC part24.238(a)
Test Method:	FCC KDB 971168 D01v03r01
Operation mode:	Refer to item 4.1
Limit:	-13dBm
Test Setup:	
Test Procedure:	<ol style="list-style-type: none"> 1. The testing follows FCC KDB 971168 D01v03r01 Section 6.0. 2. The EUT was connected to the spectrum analyzer and system simulator via a power divider. 3. The RF output of EUT was connected to the spectrum analyzer by an RF cable and attenuator. The path loss was compensated to the results for each measurement. 4. The band edges of low and high channels for the highest RF powers were measured. 5. The conducted spurious emission for the whole frequency range was taken. 6. The RF fundamental frequency should be excluded against the limit line in the operating frequency band. 7. The limit line is derived from $43 + 10\log(P)$ dB below the transmitter power $P(\text{Watts}) = P(\text{W}) - [43 + 10\log(P)] (\text{dB}) = [30 + 10\log(P)] (\text{dBm}) - [43 + 10\log(P)] (\text{dB}) = -13\text{dBm}$.
Test Result:	PASS

6.4.2. Test Instruments

Equipment	Manufacturer	Model	Serial Number	Calibration Due
System simulator	R&S	CMU200	110188	Sep. 11, 2021
Spectrum Analyzer	R&S	FSU	200054	Sep. 11, 2021
RF cable (9kHz-40GHz)	TCT	RE-05	N/A	Sep. 02, 2021
Antenna Connector	TCT	RFC-02	N/A	Sep. 02, 2021

Note: The calibration interval of the above test instruments is 12 months and the calibrations are traceable to international system unit (SI).

6.4.3. Test data

Test plots as follows:

Band:	GSM 850	Test Mode:	GSM Link (GMSK)
-------	---------	------------	-----------------

Lower Band Edge Plot on Channel 128

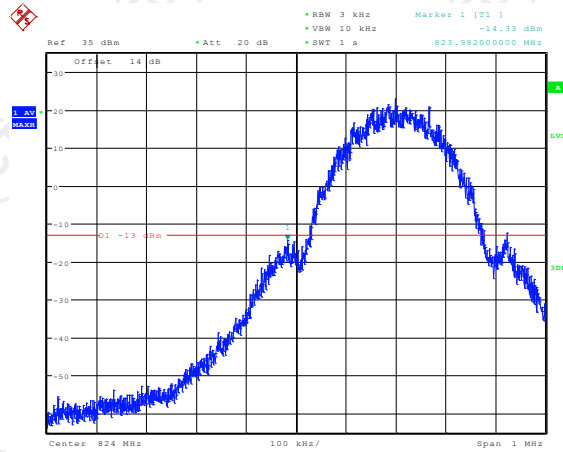

Date: 20 APR 2021 10:43:51

Higher Band Edge Plot on Channel 251

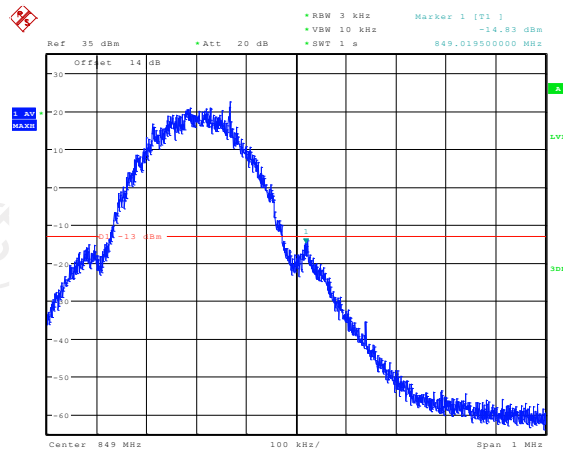

Date: 20 APR 2021 10:41:34

Band:	GSM 1900	Test Mode:	GSM Link (GMSK)
-------	----------	------------	-----------------

Lower Band Edge Plot on Channel 512

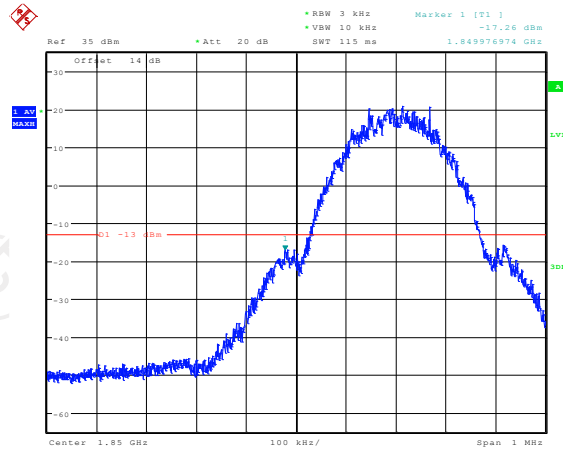

Date: 20.APR.2021 11:22:19

Higher Band Edge Plot on Channel 810

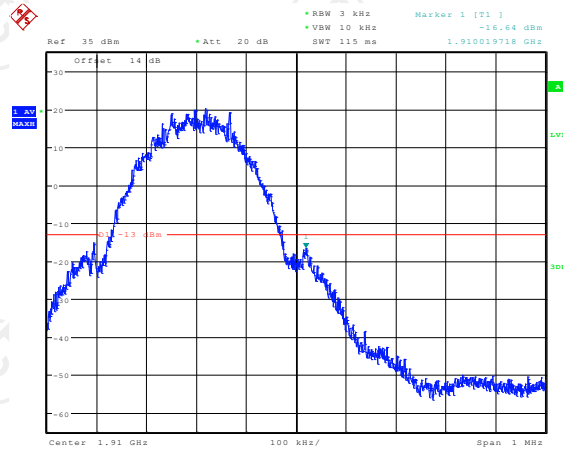

Date: 20.APR.2021 11:21:13

Note: All modes (GSM, GPRS) have been tested ,only the test data of the worst mode(GSM) have be reported .

Band: GSM 850 Test Mode: GSM Link (GMSK)

Conducted Spurious Emission on Channel 128

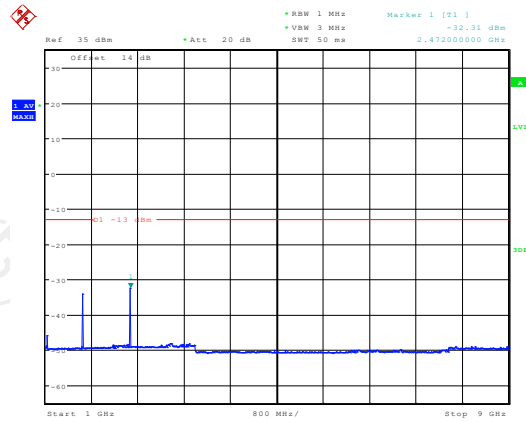
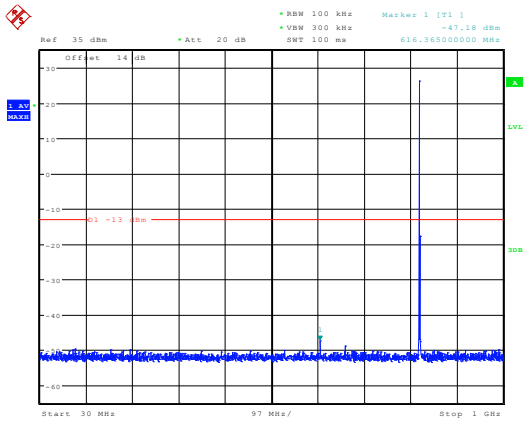

Date: 20.APR.2021 10:46:18

Date: 20.APR.2021 10:47:04

Conducted Spurious Emission on Channel 190

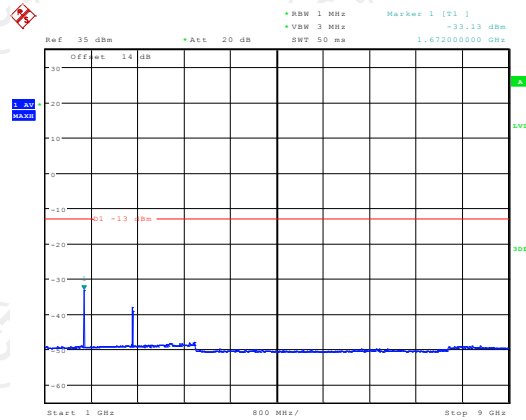
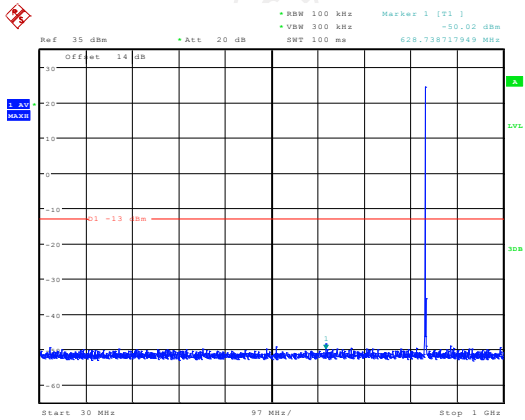

Date: 20 APR 2021 10:48:44

Date: 20 APR 2021 10:47:45

Conducted Spurious Emission on Channel 251

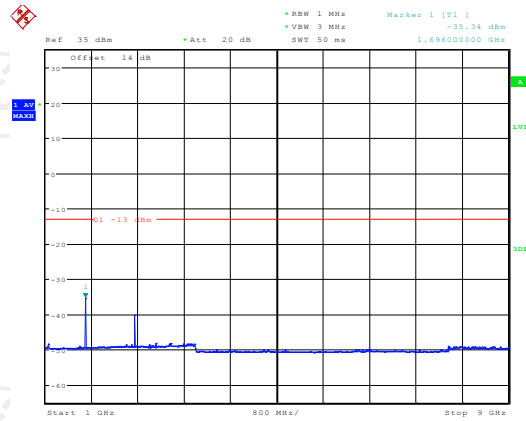
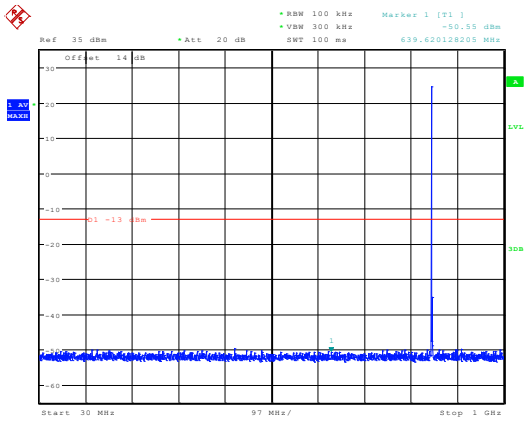

Date: 20.APR.2021 10:49:14

Date: 20.APR.2021 10:49:48

Band: GSM 1900 Test Mode: GSM Link (GMSK)

Conducted Spurious Emission on Channel 512

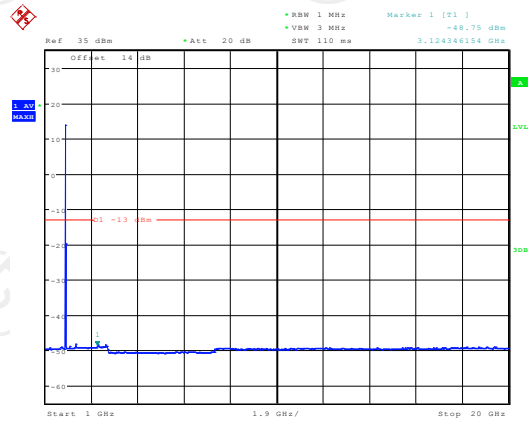
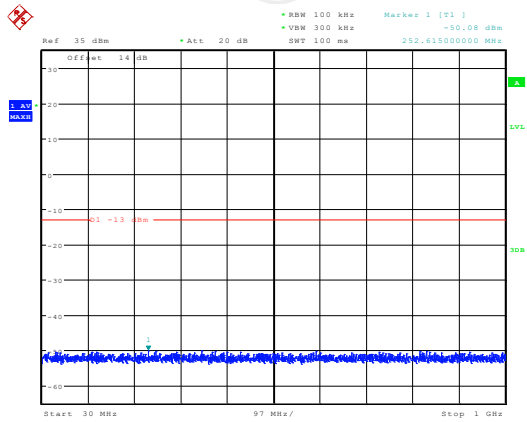

Date: 20 APR 2021 11:15:45

Date: 20 APR 2021 11:15:10

Conducted Spurious Emission on Channel 661

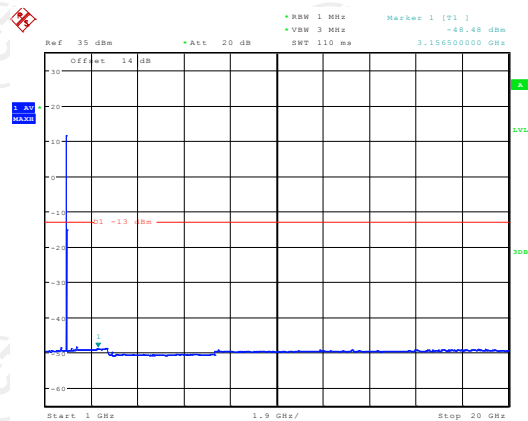
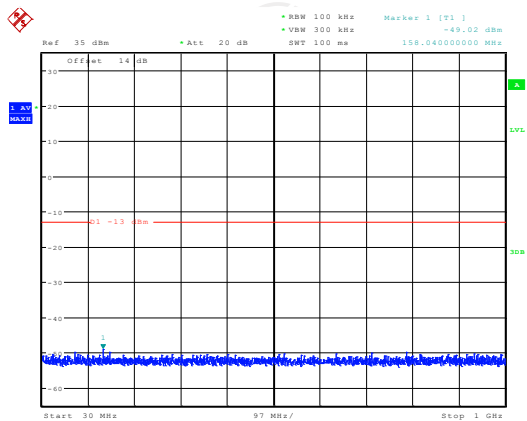

Date: 20.APR.2021 11:16:10

Date: 20.APR.2021 11:17:42

Conducted Spurious Emission on Channel 810

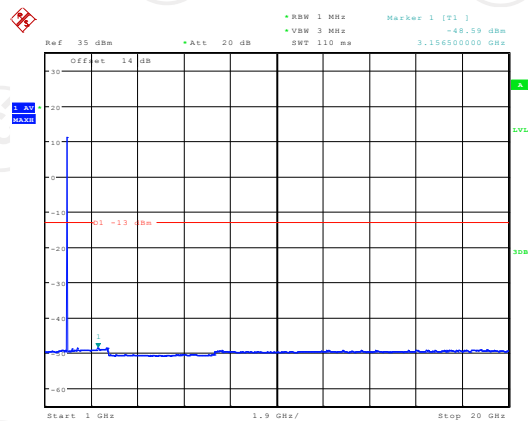
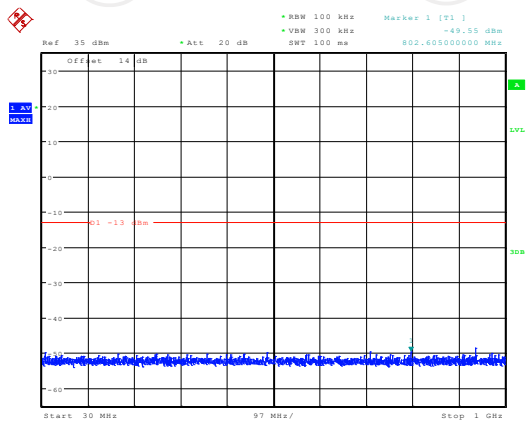

Date: 20.APR.2021 11:19:18

Date: 20.APR.2021 11:18:57

Note: All modes (GSM, GPRS) have been tested ,only the test data of the worst mode(GSM) have be reported .

GSM1900(GSM) Conducted Spurious Emission for Below 1G

Channel	RBW (KHz)	Test result (dBm)	RBW (MHz)	Calculate result (dBm)	Limit (-13dBm)
512	100	-50.08	1	-40.08	Pass
661	100	-49.02	1	-39.02	Pass
810	100	-49.55	1	-39.55	Pass

Compensate 10dB is for Exchange rate of RBW

Exchange rate of RBW = $10 \cdot \log_{10}(\text{Reference bandwidth}/\text{RBW at measurement}) = 10[\text{dB}]$

where Reference bandwidth = 1 MHz

6.5. Effective Radiated Power and Effective Isotropic Radiated Power Measurement

6.5.1. Test Specification

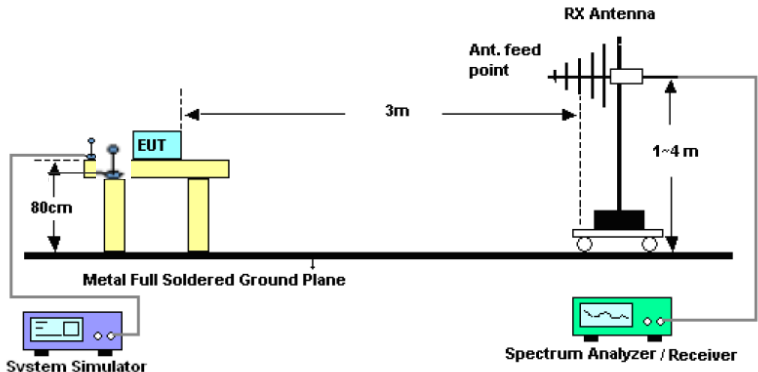
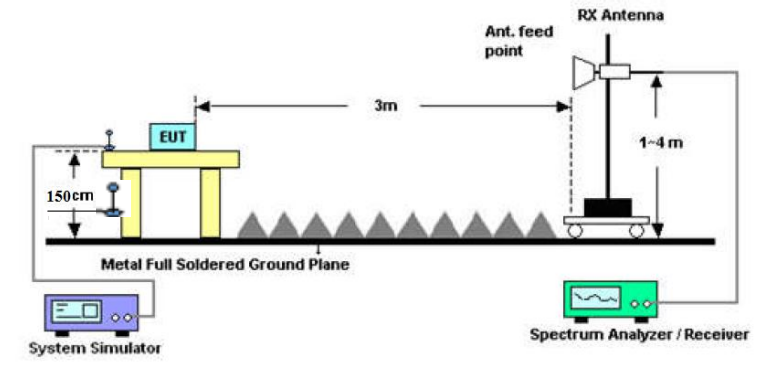
Test Requirement:	FCC part 22.913(a) and FCC part 24.232(c)	
Test Method:	FCC KDB 971168 D01v03r01	
Receiver Setup:	GSM/GPRS	
	SPAN	500kHz
	RBW	10kHz
	VBW	30kHz
	Detector	RMS
	Trace	Average
	Average Type	Power
Sweep Count	100	
Limit:	GSM850: 7W ERP PCS1900: 2W EIRP	
Test Setup:	From 30MHz to 1GHz 	
	Above 1GHz 	
Test Procedure:	<ol style="list-style-type: none"> The testing follows FCC KDB 971168 D01v03r01 Section 5.8. and ANSI / TIA-603-D-2010 Section 2.2.17. The EUT was placed on a non-conductive rotating 	

	<p>platform 0.8 meters high in a semi-anechoic chamber. The radiated emission at the fundamental frequency was measured at 3 m with a test antenna and a spectrum analyzer with RMS detector per section 5. of KDB 971168 D01v03.</p> <ol style="list-style-type: none"> 3. Key the transmitter, then rotate the EUT 360° azimuthally and record spectrum analyzer power level (LVL) measurements at angular increments that are sufficiently small to permit resolution of all peaks. If a standard radiation test site is used, raise and lower the test antenna to obtain a maximum reading at each angular increment. 4. Replace the transmitter under test with a substitution antenna. The center of the antenna should be at the same location as the center of the antenna under test. 5. Connect the antenna to a signal generator with a known output power and record the path loss (in dB) as LOSS. If a standard radiation test site is used, raise and lower the test antenna to obtain a maximum reading. LOSS = Generator Output Power (dBm) – Analyzer reading (dBm) 6. Determine the effective radiated output power at each angular position from the readings in steps 3) and 5) using the following equation: ERP (dBm) = LVL (dBm) + LOSS (dB) 7. The maximum ERP is the maximum value determined in the preceding step. 8. Calculating ERP: ERP (dBm) = Output Power (dBm) - Losses (dB) + Antenna Gain (dBd) Antenna Gain (dBd) = Antenna Gain (dBi) - 2.15 EIRP = ERP + 2.15
Test results:	PASS

6.5.2. Test Instruments

Radiated Emission Test Site (966)				
Name of Equipment	Manufacturer	Model	Serial Number	Calibration Due
System simulator	R&S	CMU200	110188	Sep. 11, 2021
Spectrum Analyzer	ROHDE&SCHW ARZ	R&S	FSQ40	Sep. 11, 2021
Signal Generator	HP	83623B	3614A00396	Sep. 02, 2021
Broadband Antenna	Schwarzbeck	VULB9163	340	Sep. 04, 2022
Horn Antenna	Schwarzbeck	BBHA 9120D	631	Sep. 04, 2022
Broadband Antenna	Schwarzbeck	VULB9163	412	Sep. 04, 2022
Horn Antenna	Schwarzbeck	BBHA 9120D	1201	Sep. 04, 2022
Horn Antenna	A-INFO	LB-180400-KF	J211020657	Sep. 04, 2022
Dipole Antenna	TCT	TCT-RF	N/A	Sep. 02, 2021
Line-4	TCT	RE-high-04	N/A	Sep. 02, 2021
Line-8	TCT	RE-01	N/A	Jul. 27, 2021
Antenna Mast	Keleto	RE-AM	N/A	N/A
EMI Test Software	Shurple Technology	EZ-EMC	N/A	N/A

Note: The calibration interval of the above test instruments is 12 months and the calibrations are traceable to international system unit (SI).

6.5.3. Test Data

Test Result of ERP

GSM850 (GSM) Radiated Power ERP					
Horizontal Polarization (Antenna Pol.)					
Frequency (MHz)	(EUT Pol.)	LVL (dBm)	Correction Factor (dB)	ERP (dBm)	ERP (W)
824.2	H	12.14	21.66	31.65	1.46
836.6	H	12.33	21.54	31.72	1.49
848.8	H	12.52	21.46	31.83	1.52
Vertical Polarization (Antenna Pol.)					
Frequency (MHz)	(EUT Pol.)	LVL (dBm)	Correction Factor (dB)	ERP (dBm)	ERP (W)
824.2	H	12.08	21.66	31.59	1.44
836.6	H	12.57	21.54	31.96	1.57
848.8	H	12.89	21.46	32.20	1.66

GPRS 850 (1-slot) Radiated Power ERP					
Horizontal Polarization (Antenna Pol.)					
Frequency (MHz)	(EUT Pol.)	LVL (dBm)	Correction Factor (dB)	ERP (dBm)	ERP (W)
824.2	H	11.88	21.66	31.39	1.38
836.6	H	12.21	21.54	31.60	1.45
848.8	H	12.74	21.46	32.05	1.60
Vertical Polarization (Antenna Pol.)					
Frequency (MHz)	(EUT Pol.)	LVL (dBm)	Correction Factor (dB)	ERP (dBm)	ERP (W)
824.2	H	11.95	21.66	31.46	1.40
836.6	H	12.16	21.54	31.55	1.43
848.8	H	12.63	21.46	31.94	1.56

Note: All GPRS slot have been tested, but only the worst GPRS 1-slot show in this test item.

* ERP = LVL (dBm) + Correction Factor (dB) - 2.15

Correction Factor= S.G. Power - Cable loss + Antenna Gain- SPA. Reading

Test Result of EIRP

GSM1900 (GSM) Radiated Power EIRP					
Horizontal Polarization (Antenna Pol.)					
Frequency (MHz)	(EUT Pol.)	LVL (dBm)	Correction Factor (dB)	EIRP (dBm)	EIRP (W)
1850.2	H	6.97	21.66	28.63	0.73
1880.0	H	7.12	21.54	28.66	0.73
1909.8	H	7.23	21.46	28.69	0.74
Vertical Polarization (Antenna Pol.)					
Frequency (MHz)	(EUT Pol.)	LVL (dBm)	Correction Factor (dB)	EIRP (dBm)	EIRP (W)
1850.2	H	6.87	21.66	28.53	0.71
1880.0	H	7.05	21.54	28.59	0.72
1909.8	H	7.11	21.46	28.57	0.72

GPRS1900 (1-solt) Radiated Power EIRP					
Horizontal Polarization (Antenna Pol.)					
Frequency (MHz)	(EUT Pol.)	LVL (dBm)	Correction Factor (dB)	EIRP (dBm)	EIRP (W)
1850.2	H	6.92	21.66	28.58	0.72
1880.0	H	7.12	21.54	28.66	0.73
1909.8	H	7.25	21.46	28.71	0.74
Vertical Polarization (Antenna Pol.)					
Frequency (MHz)	(EUT Pol.)	LVL (dBm)	Correction Factor (dB)	EIRP (dBm)	EIRP (W)
1850.2	H	6.83	21.66	28.49	0.71
1880.0	H	7.06	21.54	28.60	0.72
1909.8	H	7.14	21.46	28.60	0.72

Note: All GPRS slot have been tested, but only the worst GPRS 1-slot show in this test item

* EIRP = LVL (dBm) + Correction Factor (dB)

Correction Factor= S.G. Power - Cable loss + Substitution Antenna Gain- SPA. Reading

6.6. Field Strength of Spurious Radiation Measurement

6.6.1. Test Specification

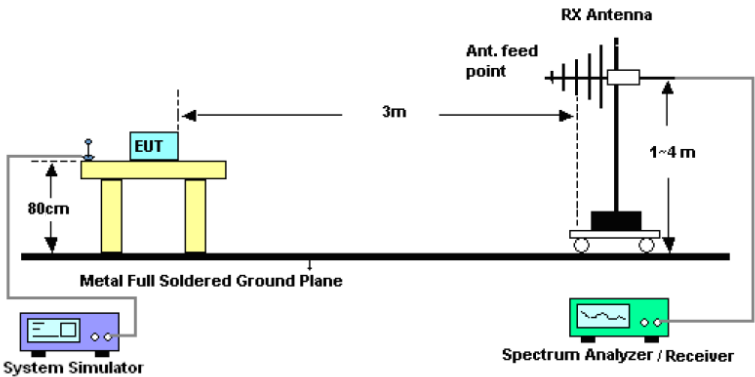
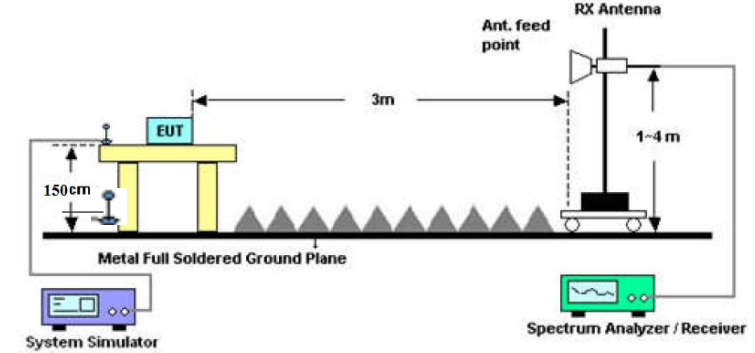
Test Requirement:	FCC part 22.917(a) and FCC part 24.238(a)
Test Method:	FCC KDB 971168 D01v03r01
Operation mode:	Refer to item 4.1
Limit:	-13dBm
Test setup:	<p>For 30MHz~1GHz</p>  <p>Above 1GHz</p> 
Test Procedure:	<ol style="list-style-type: none"> 1. The testing follows FCC KDB 971168 D01v03r01 Section 6 and ANSI / TIA-603-D-2010 Section 2.2.12. 2. The EUT was placed on a rotatable wooden table 0.8 meters above the ground. 3. The EUT was set 3 meters from the receiving antenna, which was mounted on the antenna tower. 4. The table was rotated 360 degrees to determine the position of the highest spurious emission. 5. The height of the receiving antenna is varied between one meter and four meters to search for the maximum spurious emission for both horizontal and vertical polarizations. 6. Make the measurement with the spectrum analyzer's RBW = 1MHz, VBW = 3MHz, taking record of

	<p>maximum spurious emission.</p> <p>7. A horn antenna was substituted in place of the EUT and was driven by a signal generator.</p> <p>8. Tune the output power of signal generator to the same emission level with EUT maximum spurious emission.</p> <p>9. Taking the record of output power at antenna port.</p> <p>10. Repeat step 7 to step 8 for another polarization.</p> <p>11. $EIRP (dBm) = S.G. Power - Tx Cable Loss + Tx Antenna Gain$</p> <p>12. $ERP (dBm) = EIRP - 2.15$</p> <p>13. The RF fundamental frequency should be excluded against the limit line in the operating frequency band.</p> <p>14. The limit line is derived from $43 + 10\log(P)$ dB below the transmitter power P(Watts)</p> <p>$= P(W) - [43 + 10\log(P)] (dB)$</p> <p>$= [30 + 10\log(P)] (dBm) - [43 + 10\log(P)] (dB)$</p> <p>$= -13dBm.$</p>
Test results:	PASS
Remark:	All modulations have been tested, but only the worst modulation show in this test item.

6.6.2. Test Instruments

Radiated Emission Test Site (966)				
Name of Equipment	Manufacturer	Model	Serial Number	Calibration Due
System simulator	R&S	CMU200	110188	Sep. 11, 2021
Spectrum Analyzer	ROHDE&SCHW ARZ	R&S	FSQ40	Sep. 11, 2021
Signal Generator	HP	83623B	3614A00396	Sep. 02, 2021
Broadband Antenna	Schwarzbeck	VULB9163	340	Sep. 04, 2022
Horn Antenna	Schwarzbeck	BBHA 9120D	631	Sep. 04, 2022
Broadband Antenna	Schwarzbeck	VULB9163	412	Sep. 04, 2022
Horn Antenna	Schwarzbeck	BBHA 9120D	1201	Sep. 04, 2022
Horn Antenna	A-INFO	LB-180400-KF	J211020657	Sep. 04, 2022
Dipole Antenna	TCT	TCT-RF	N/A	Sep. 02, 2021
Line-4	TCT	RE-high-04	N/A	Sep. 02, 2021
Line-8	TCT	RE-01	N/A	Jul. 27, 2021
Antenna Mast	Keleto	RE-AM	N/A	N/A
EMI Test Software	Shurple Technology	EZ-EMC	N/A	N/A

Note: The calibration interval of the above test instruments is 12 months and the calibrations are traceable to international system unit (SI).

6.6.3. Test Data

Frequency Range (9 kHz-30MHz)

Frequency (MHz)	Level@3m (dB μ V/m)	Limit@3m (dB μ V/m)
--	--	--
--	--	--
--	--	--
--	--	--

Note: 1. Emission Level=Reading+ Cable loss+Antenna factor-Amp factor

2. The emission levels are 20 dB below the limit value, which are not reported. It is deemed to comply with the requirement

Band	GSM 850	Test channel:	Lowest
Test mode:		Temperature :	25°C
		Relative Humidity:	56%

Note: Spurious emissions within 30-1000MHz were found more than 20dB below limit line.

Frequency (MHz)	Spurious Emission				Limit (dBm)	Result
	Polarization	Level (dBm)	Correction Factor (dB)	Spurious emissions (dBm)		
1648.4	Vertical	-56.17	23.12	-33.05	-13.00	PASS
2472.6	V	-63.02	23.20	-39.82		
3296.8	V	-75.98	23.28	-52.70		
1648.4	Horizontal	-55.36	23.12	-32.24		
2472.6	H	-61.27	23.20	-38.07		
3296.8	H	-74.97	23.28	-51.69		

Band	GSM 850	Test channel:	Middle
Test mode:		Temperature :	25°C
		Relative Humidity:	56%

Note: Spurious emissions within 30-1000MHz were found more than 20dB below limit line.

Frequency (MHz)	Spurious Emission				Limit (dBm)	Result
	Polarization	Level (dBm)	Correction Factor (dB)	Spurious emissions (dBm)		
1673.2	Vertical	-56.23	23.17	-33.06	-13.00	PASS
2509.8	V	-67.17	23.26	-43.91		
3346.4	V	-76.13	23.38	-52.75		
1673.2	Horizontal	-54.54	23.17	-31.37		
2509.8	H	-62.28	23.26	-39.02		
3346.4	H	-75.19	23.38	-51.81		

Band	GSM 850	Test channel:	Highest
Test mode:		Temperature :	25°C
		Relative Humidity:	56%

Note: Spurious emissions within 30-1000MHz were found more than 20dB below limit line.

Frequency (MHz)	Spurious Emission				Limit (dBm)	Result
	Polarization	Level (dBm)	Correction Factor (dB)	Spurious emissions (dBm)		
1697.6	Vertical	-58.13	23.23	-34.90	-13.00	PASS
2546.4	V	-68.07	23.32	-44.75		
3395.2	V	-76.09	23.44	-52.65		
1697.6	Horizontal	-54.32	23.23	-31.09		
2546.4	H	-62.65	23.32	-39.33		
3395.2	H	-77.94	23.44	-54.50		

Band	PCS 1900	Test channel:	Lowest
Test mode:		Temperature :	25°C
		Relative Humidity:	56%

Note: Spurious emissions within 30-1000MHz were found more than 20dB below limit line.

Frequency (MHz)	Spurious Emission				Limit (dBm)	Result
	Polarization	Level (dBm)	Correction Factor (dB)	Spurious emissions (dBm)		
3700.4	Vertical	-63.11	23.49	-39.62	-13.00	PASS
5550.6	V	-71.06	23.75	-47.31		
7400.8	V	-77.77	23.89	-53.88		
3700.4	Horizontal	-59.56	23.49	-36.07		
5550.6	H	-65.49	23.75	-41.74		
7400.8	H	-76.15	23.89	-52.26		

Band	PCS 1900	Test channel:	Middle
Test mode:		Temperature :	25°C
		Relative Humidity:	56%

Note: Spurious emissions within 30-1000MHz were found more than 20dB below limit line.

Frequency (MHz)	Spurious Emission				Limit (dBm)	Result
	Polarization	Level (dBm)	Correction Factor (dB)	Spurious emissions (dBm)		
3760.0	Vertical	-63.08	23.58	-39.50	-13.00	PASS
5640.0	V	-73.12	23.85	-49.27		
7520.0	V	-71.33	23.99	-47.34		
3760.0	Horizontal	-59.05	23.58	-35.47		
5640.0	H	-72.42	23.85	-48.57		
7520.0	H	-76.39	23.99	-52.40		

Band	PCS 1900	Test channel:	Highest
Test mode:		Temperature :	25°C
		Relative Humidity:	56%

Note: Spurious emissions within 30-1000MHz were found more than 20dB below limit line.

Frequency (MHz)	Spurious Emission				Limit (dBm)	Result
	Polarization	Level (dBm)	Correction Factor (dB)	Spurious emissions (dBm)		
3819.6	Vertical	-60.52	23.64	-36.88	-13.00	PASS
5729.4	V	-70.11	23.93	-46.18		
7639.2	V	-77.67	24.08	-53.59		
3819.6	Horizontal	-58.52	23.64	-34.88		
5729.4	H	-65.30	23.93	-41.37		
7639.2	H	-77.51	24.08	-53.43		

6.7. Frequency Stability Measurement

6.7.1. Test Specification

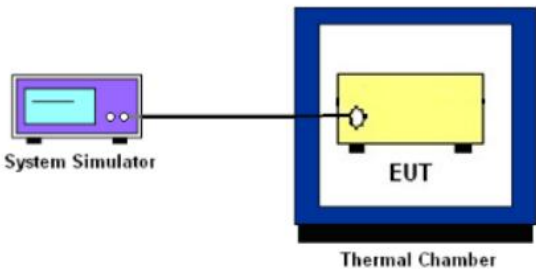
Test Requirement:	FCC Part 2.1055 ; FCC Part 22.355 ; FCC Part 24.235
Test Method:	FCC KDB 971168 D01v03r01
Operation mode:	Refer to item 4.1
Limit:	FCC Part 22.355 : ± 2.5 ppm FCC Part 24.235 : The frequency stability shall be sufficient to ensure that the fundamental emission stays within the authorized frequency block.
Test Setup:	 <p>The diagram illustrates the test setup. On the left, a purple box labeled 'System Simulator' is connected by a black line to a yellow box labeled 'EUT' (Equipment Under Test). The EUT is positioned inside a blue square frame labeled 'Thermal Chamber'.</p>
Test Procedure:	<p>Test Procedures for Temperature Variation</p> <ol style="list-style-type: none"> 1. The testing follows FCC KDB 971168 D01v03r01 Section 9.0. 2. The EUT was set up in the thermal chamber and connected with the system simulator. 3. With power OFF, the temperature was decreased to -30°C and the EUT was stabilized before testing. Power was applied and the maximum change in frequency was recorded within one minute. 4. With power OFF, the temperature was raised in 10°C steps up to 50°C. The EUT was stabilized at each step for at least half an hour. Power was applied and the maximum frequency change was recorded within one minute. <p>Test Procedures for Voltage Variation</p> <ol style="list-style-type: none"> 1. The testing follows FCC KDB 971168 D01v03r01 Section 9.0. 2. The EUT was placed in a temperature chamber at $25 \pm 5^{\circ}\text{C}$ and connected with the system simulator. 3. The power supply voltage to the EUT was varied from BEP to 115% of the nominal value measured at the input to the EUT. 4. The variation in frequency was measured for the worst case.
Test Result:	PASS
Remark:	All three channels of all modulations have been tested, but only the worst channel and the worst modulation show in this test item.

6.7.2. Test Instruments

Equipment	Manufacturer	Model	Serial Number	Calibration Due
System simulator	R&S	CMU200	110188	Sep. 11, 2021
Programable tempratuce and humidity chamber	JQ	JQ-2000	N/A	Sep. 02, 2021
DC power supply	Kingrang	KR3005K	N/A	Sep. 02, 2021
RF cable (9kHz-40GHz)	TCT	RE-04	N/A	Sep. 02, 2021
Antenna Connector	TCT	RFC-03	N/A	Sep. 02, 2021

Note: The calibration interval of the above test instruments is 12 months and the calibrations are traceable to international system unit (SI).

6.7.3. Test Data

Test Result of Temperature Variation

Band :	GSM 850	Channel:	190
Limit (ppm) :	2.5	Frequency:	836.6MHz
Temperature (°C)	Deviation (ppm)		Result
50	0.016		PASS
40	0.013		
30	0.011		
20	0.010		
10	0.011		
0	0.013		
-10	0.015		
-20	0.017		
-30	0.018		

Band :	GSM 1900	Channel:	661
Limit (ppm) :	Note	Frequency:	1880MHz
Temperature (°C)	Deviation (ppm)		Result
50	0.019		PASS
40	0.016		
30	0.014		
20	0.013		
10	0.014		
0	0.016		
-10	0.018		
-20	0.019		
-30	0.021		

Note: The frequency fundamental emissions stay within the authorized frequency block based on the frequency deviation measured is small.

Test Result of Voltage Variation

Band & Channel	Mode	Voltage (Volt)	Deviation (ppm)	Limit (ppm)	Result
GSM 850 CH190	GSM	4.2	+0.016	2.5	PASS
		3.7	+0.015		
		BEP	+0.013		
GSM 1900 CH661	GSM	4.2	+0.017	(Note 3.)	
		3.7	+0.014		
		BEP	+0.012		

Note:

1. Normal Voltage = 3.7V.
2. Battery End Point (BEP) = 3.7V.
3. The frequency fundamental emissions stay within the authorized frequency block based on the frequency deviation measured is small.

Appendix A: Photographs of Test Setup

Refer to the test report No. TCT210205E029

Appendix B: Photographs of EUT

Refer to the test report No. TCT210205E029

*******END OF REPORT*******