

Test Results:

Tx. Spurious 802.11b 2412MHz Ref

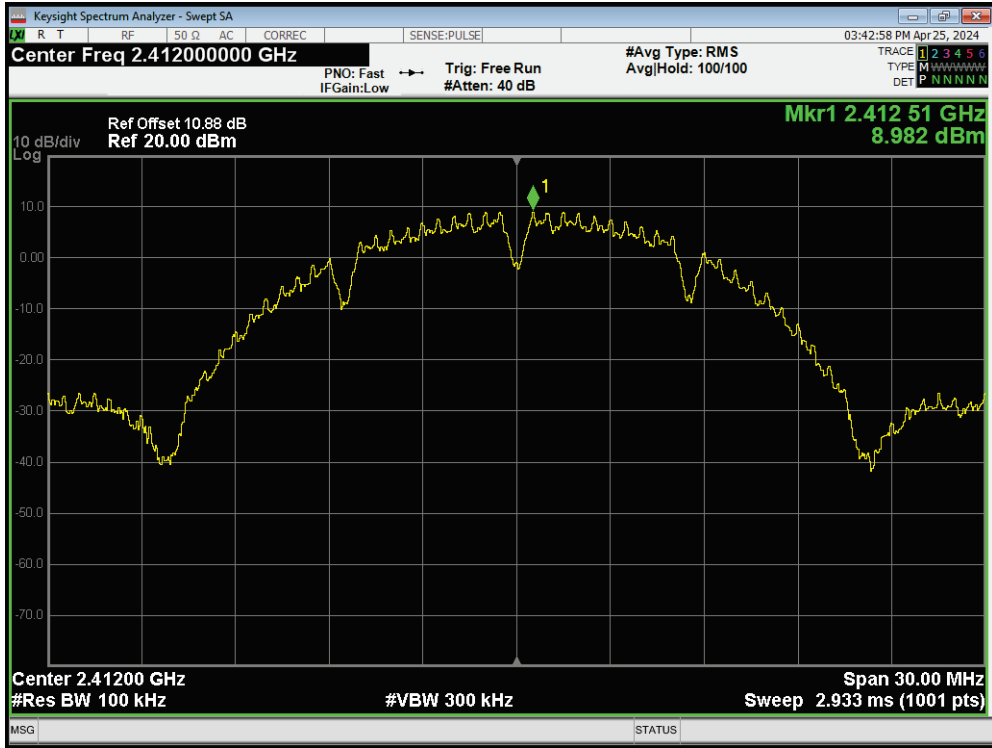

Tx. Spurious 802.11b 2412MHz Emission

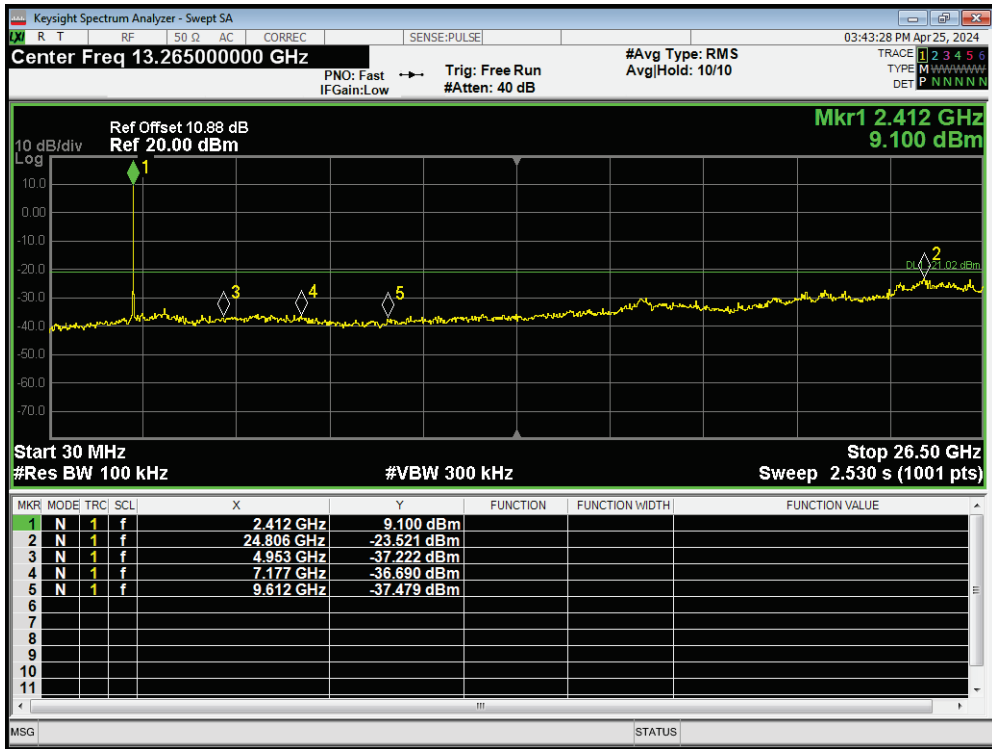

Tx. Spurious 802.11b 2437MHz Ref

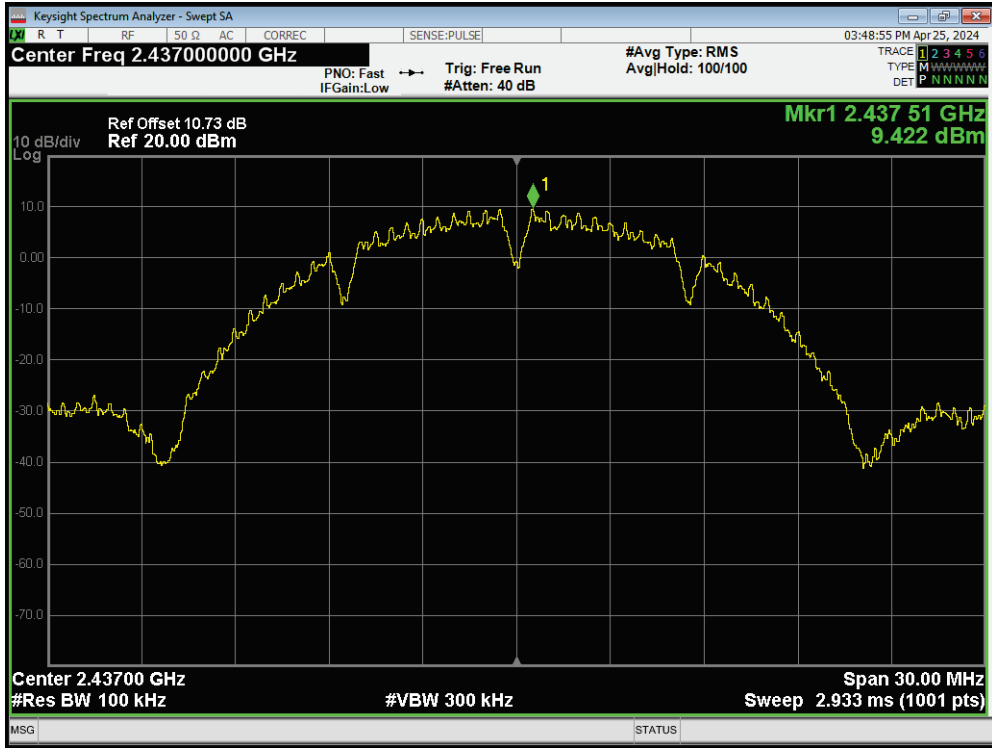

Tx. Spurious 802.11b 2437MHz Emission

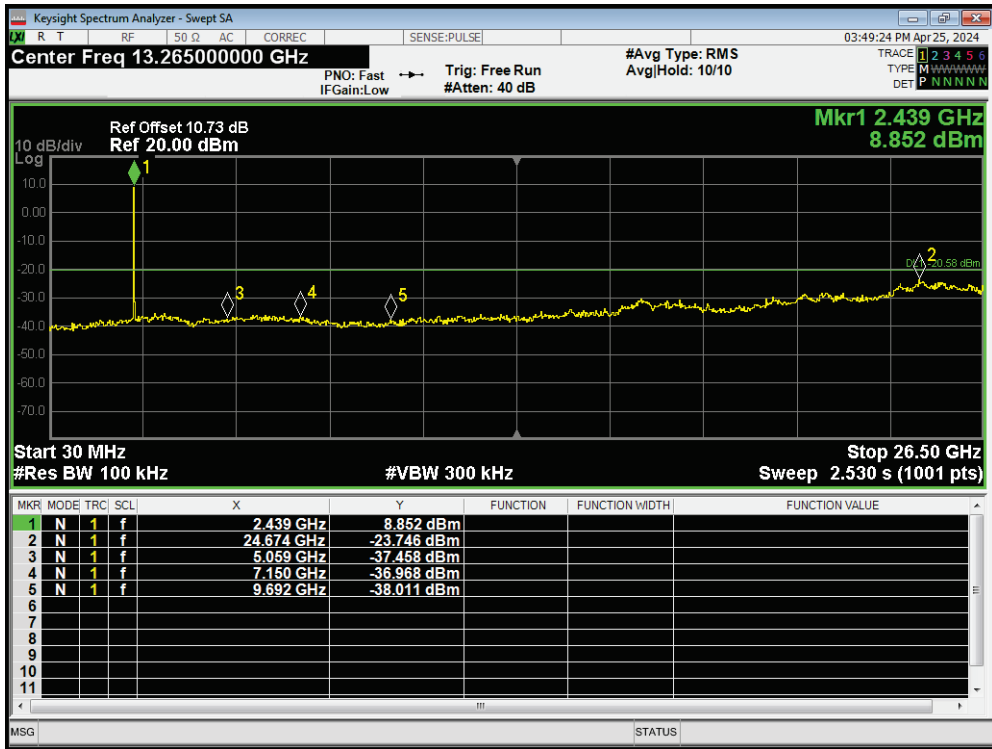

Tx. Spurious 802.11b 2462MHz Ref

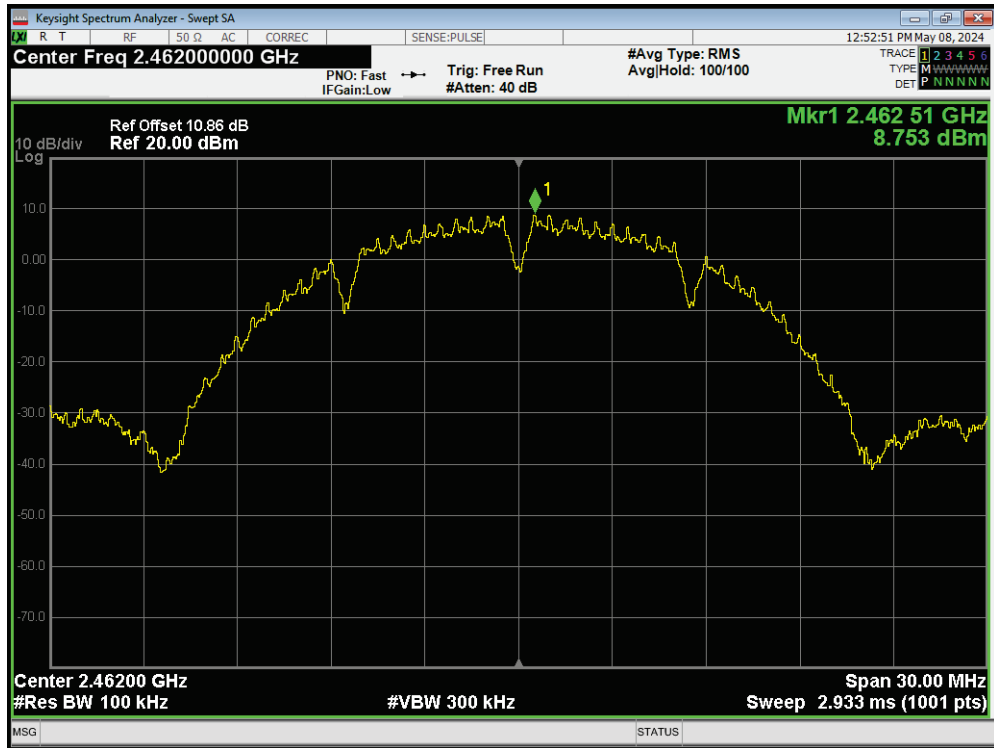

Tx. Spurious 802.11b 2462MHz Emission

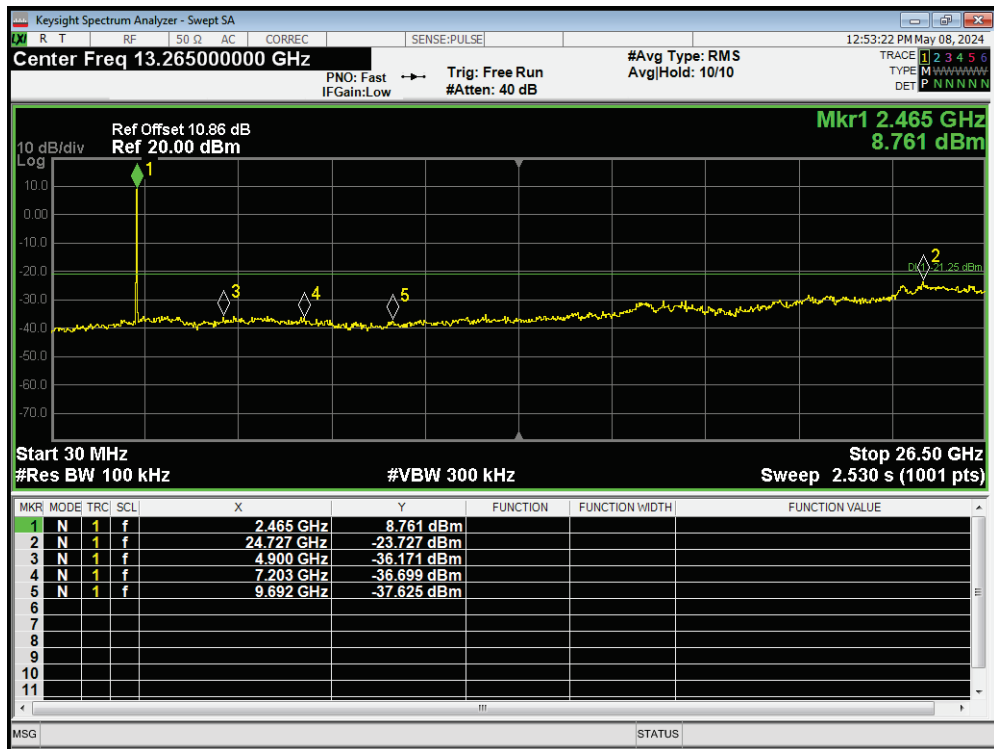

Tx. Spurious 802.11g 2412MHz Ref

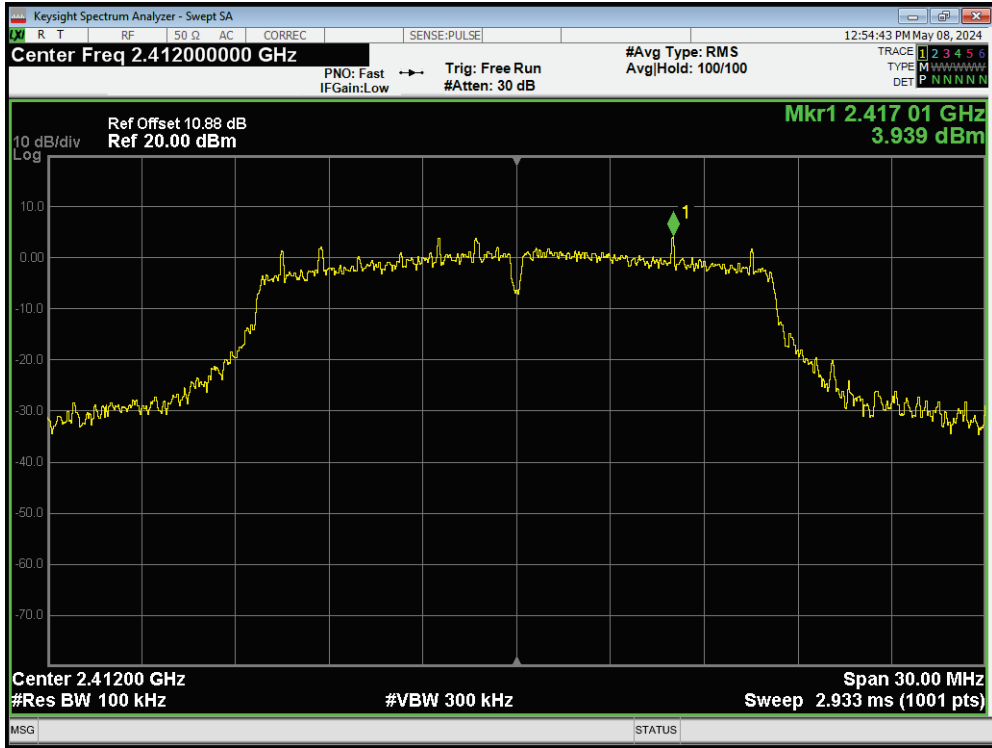

Tx. Spurious 802.11g 2412MHz Emission

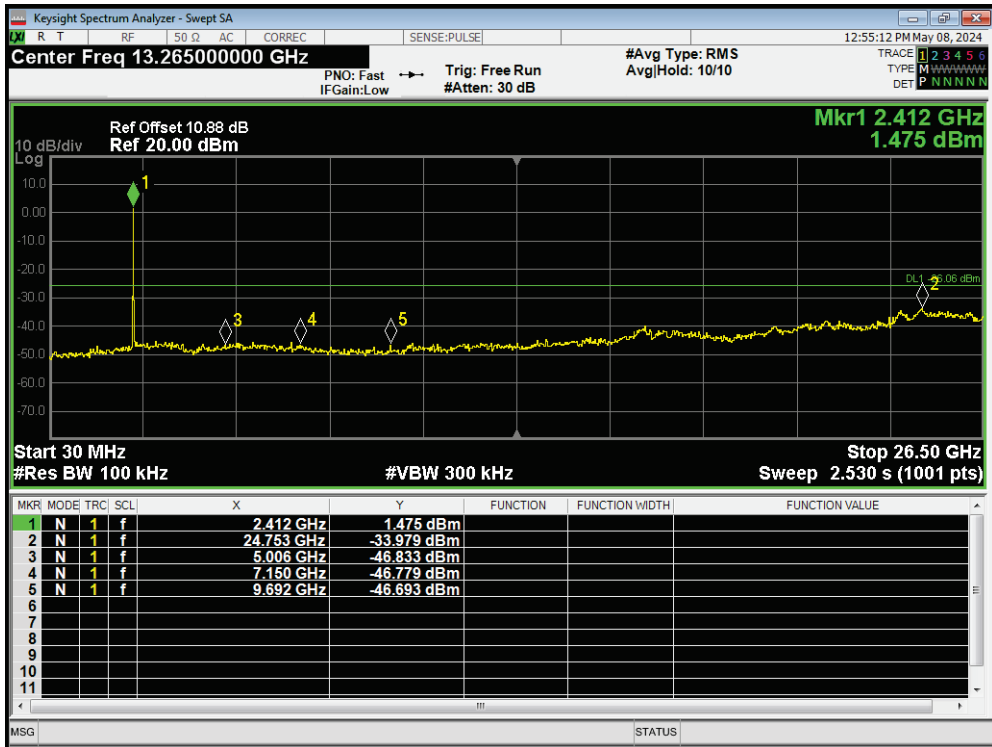

Tx. Spurious 802.11g 2417MHz Ref

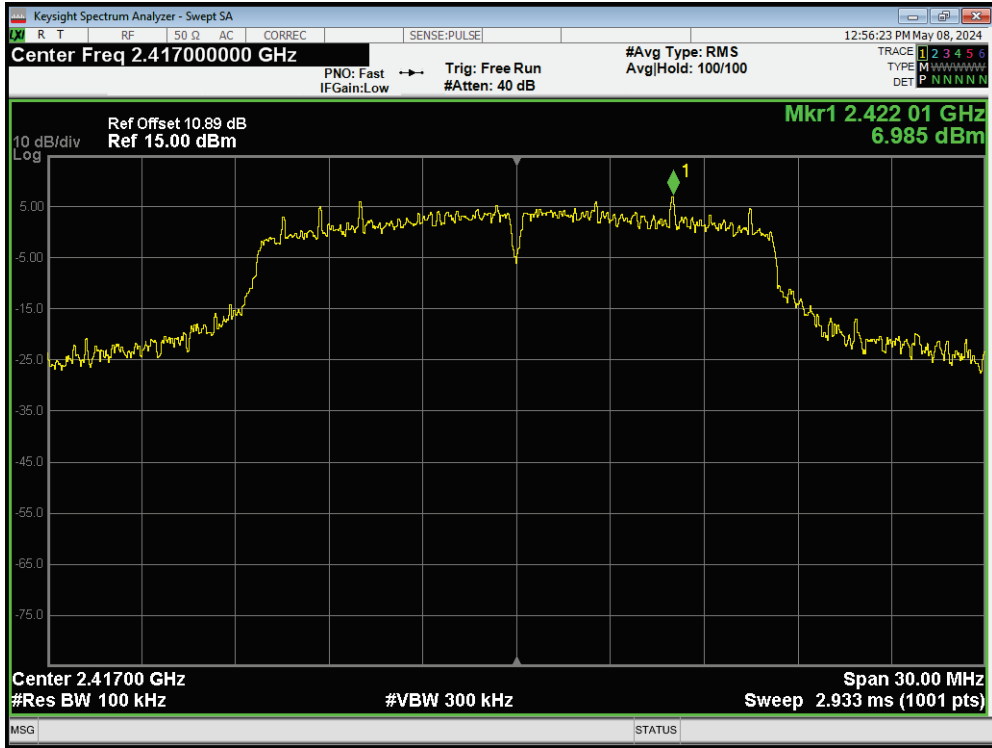

Tx. Spurious 802.11g 2417MHz Emission

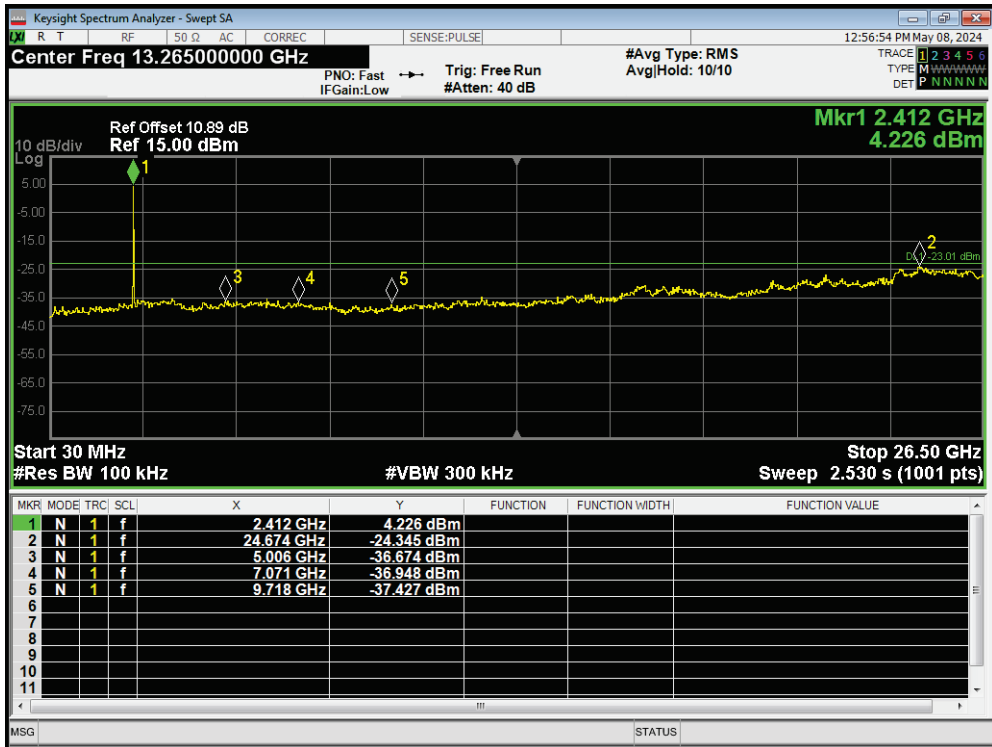

Tx. Spurious 802.11g 2422MHz Ref

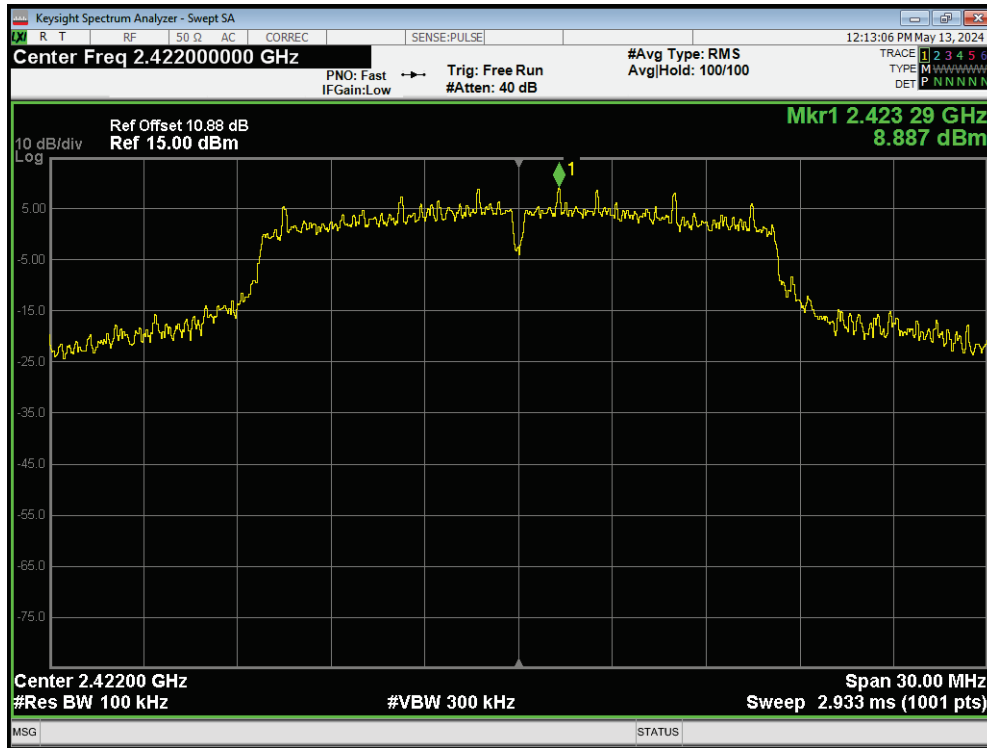

Tx. Spurious 802.11g 2422MHz Emission

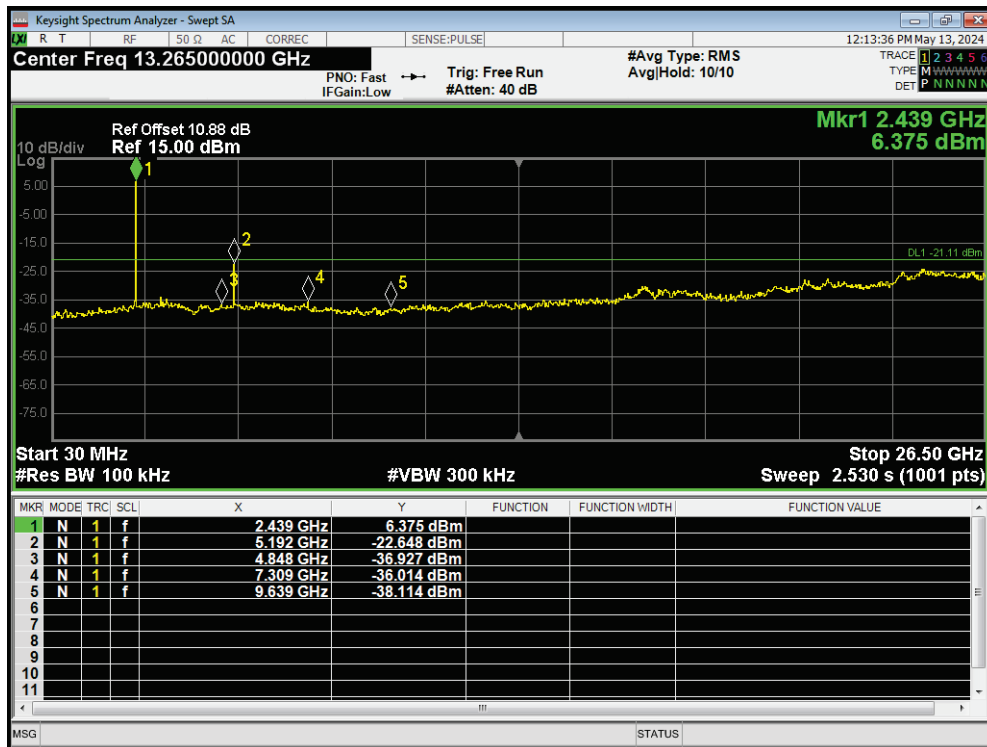

Tx. Spurious 802.11g 2437MHz Ref

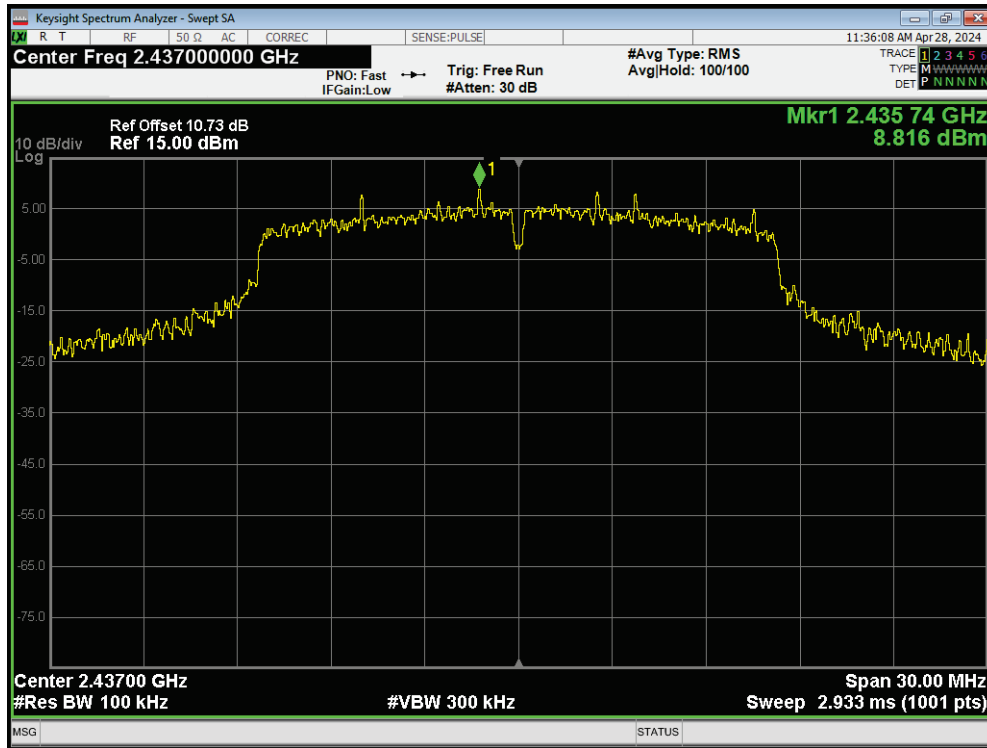

Tx. Spurious 802.11g 2437MHz Emission

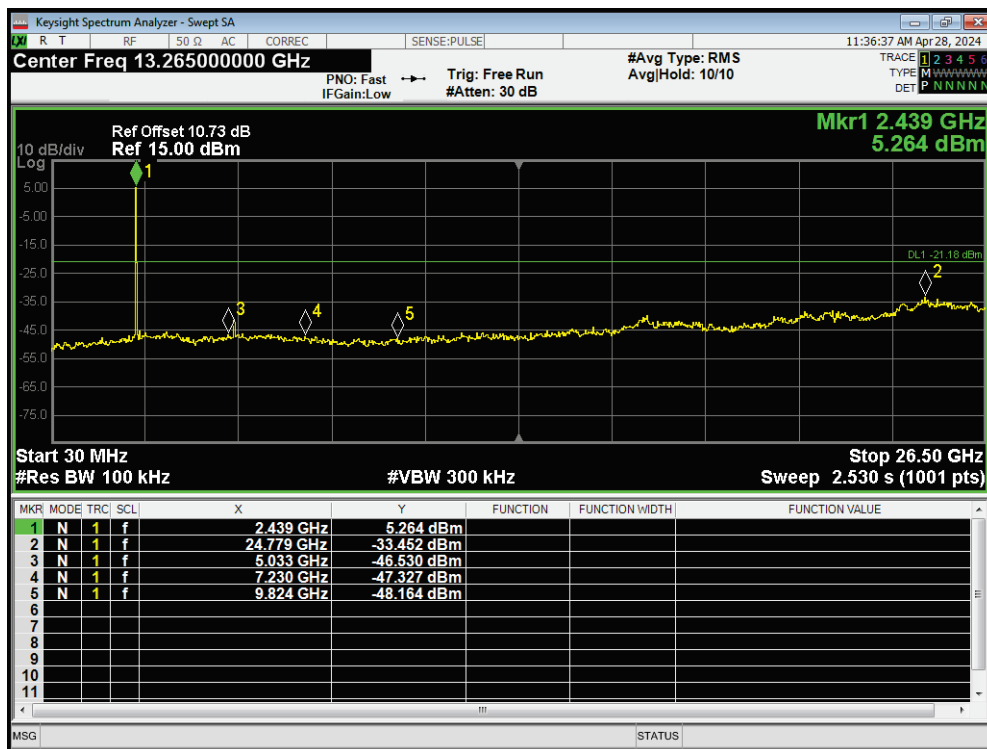

Tx. Spurious 802.11g 2452MHz Ref

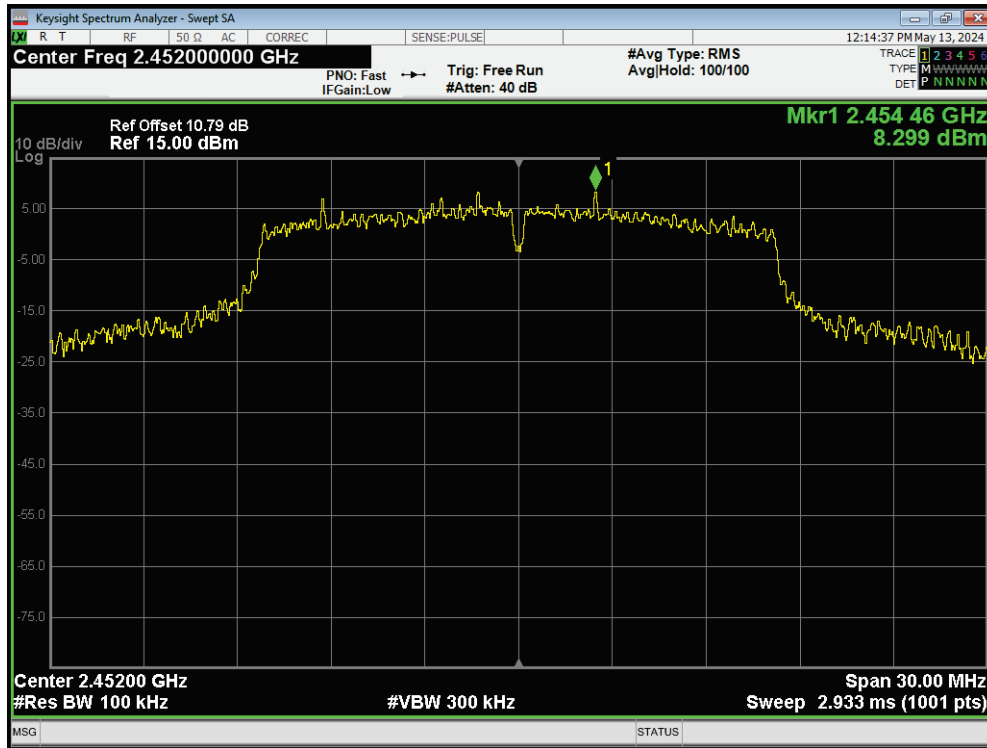

Tx. Spurious 802.11g 2452MHz Emission

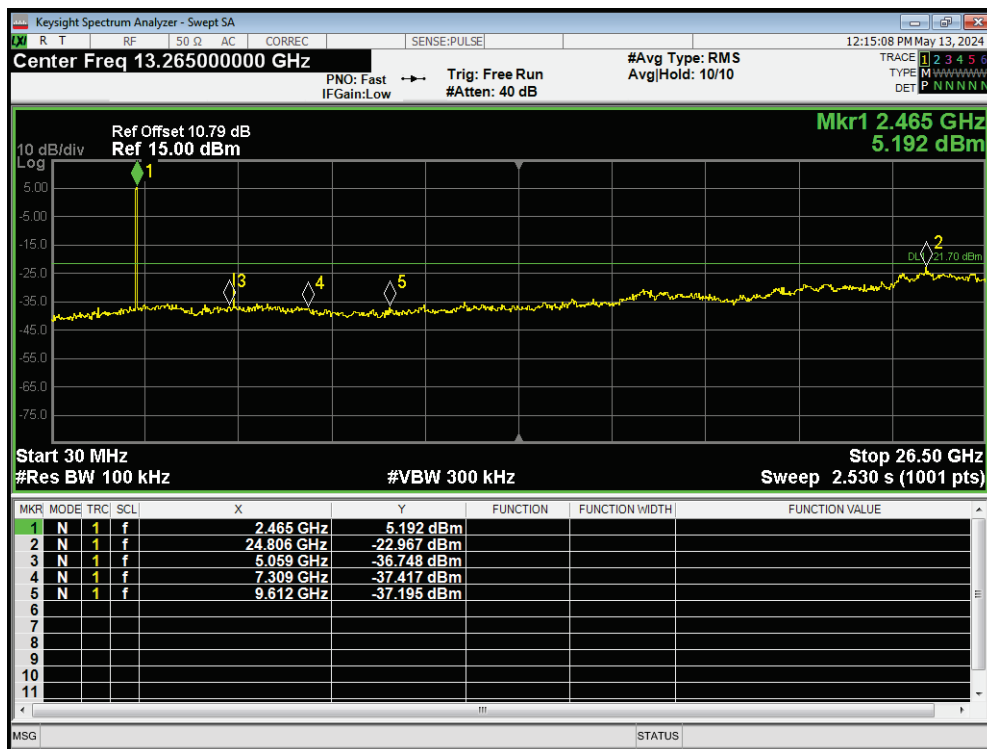

Tx. Spurious 802.11g 2457MHz Ref

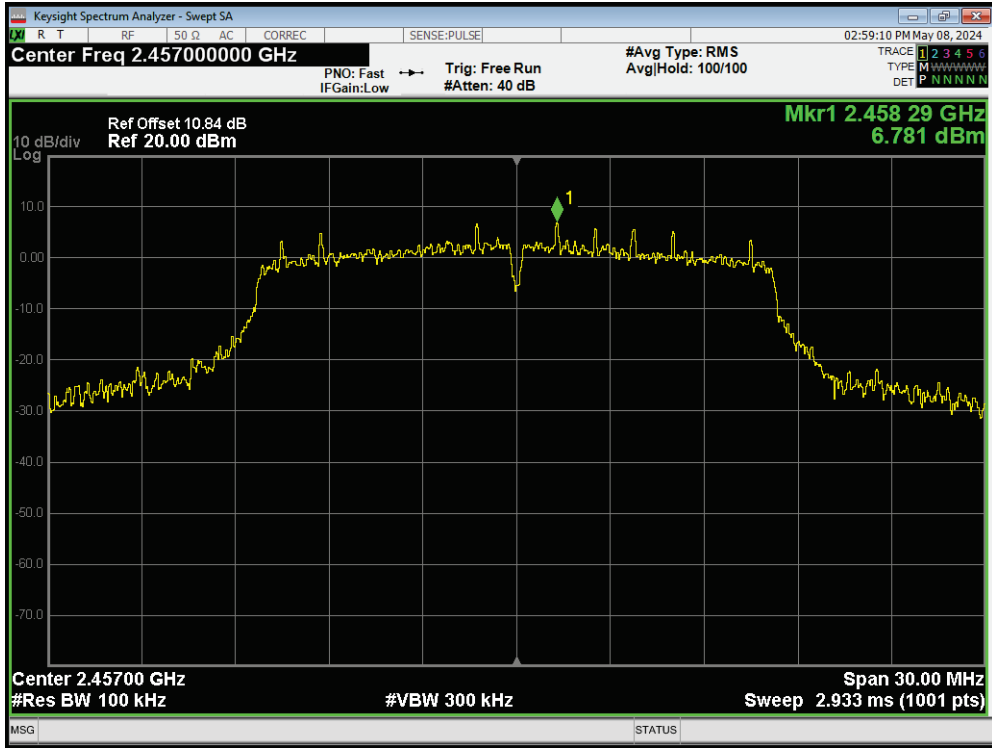

Tx. Spurious 802.11g 2457MHz Emission

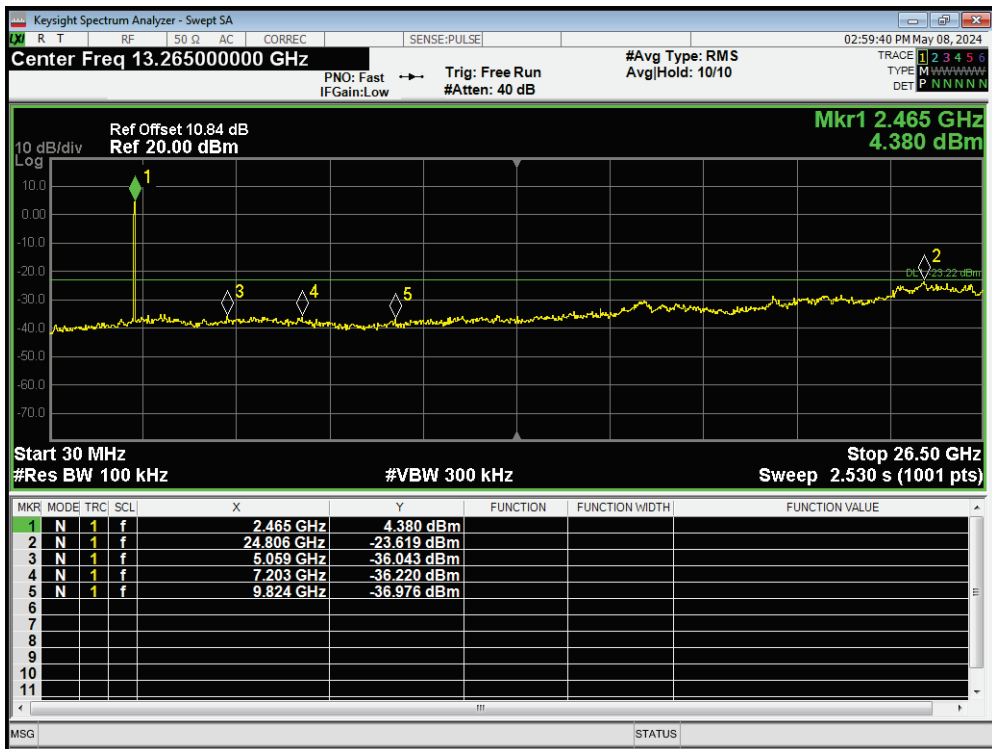

Tx. Spurious 802.11g 2462MHz Ref

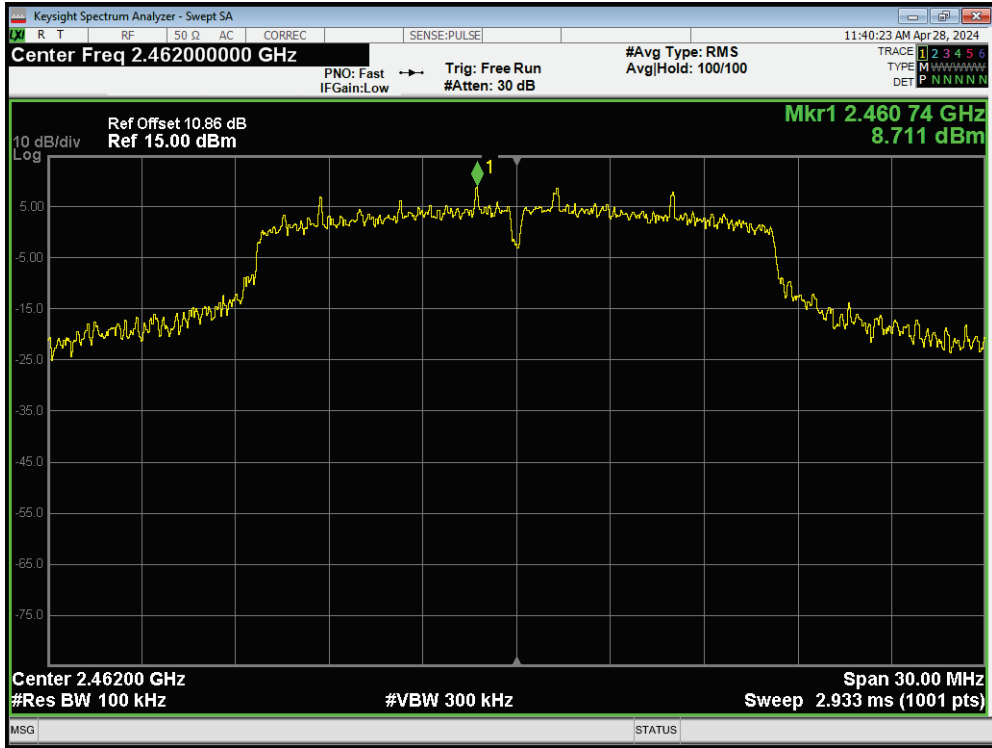

Tx. Spurious 802.11g 2462MHz Emission

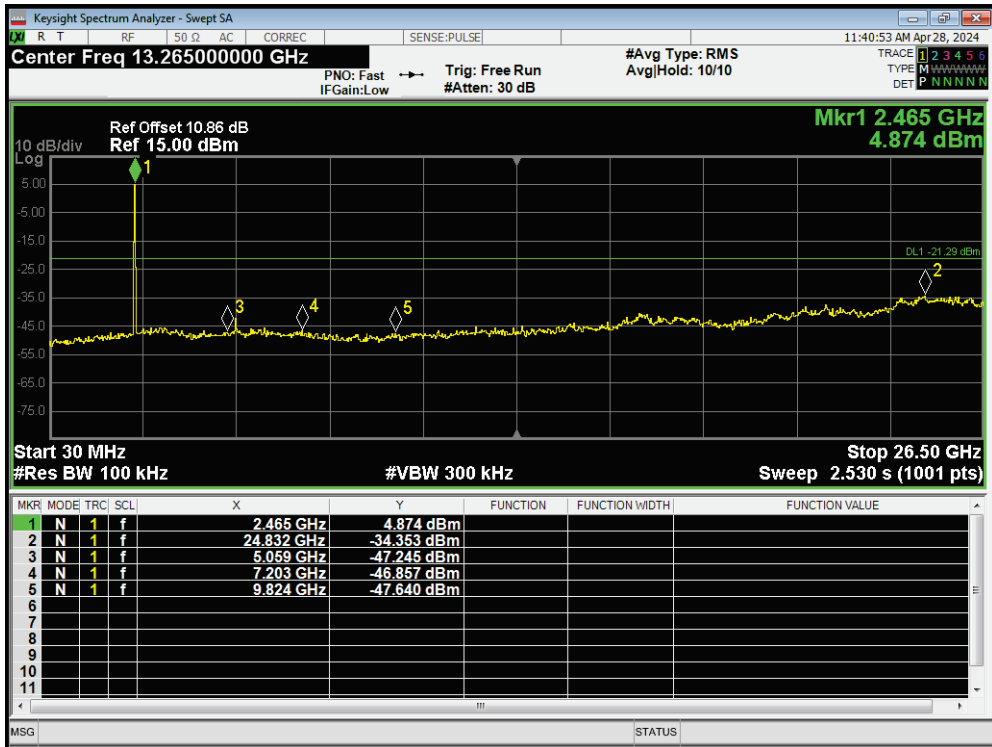

Tx. Spurious 802.11n(HT20) 2412MHz Ref

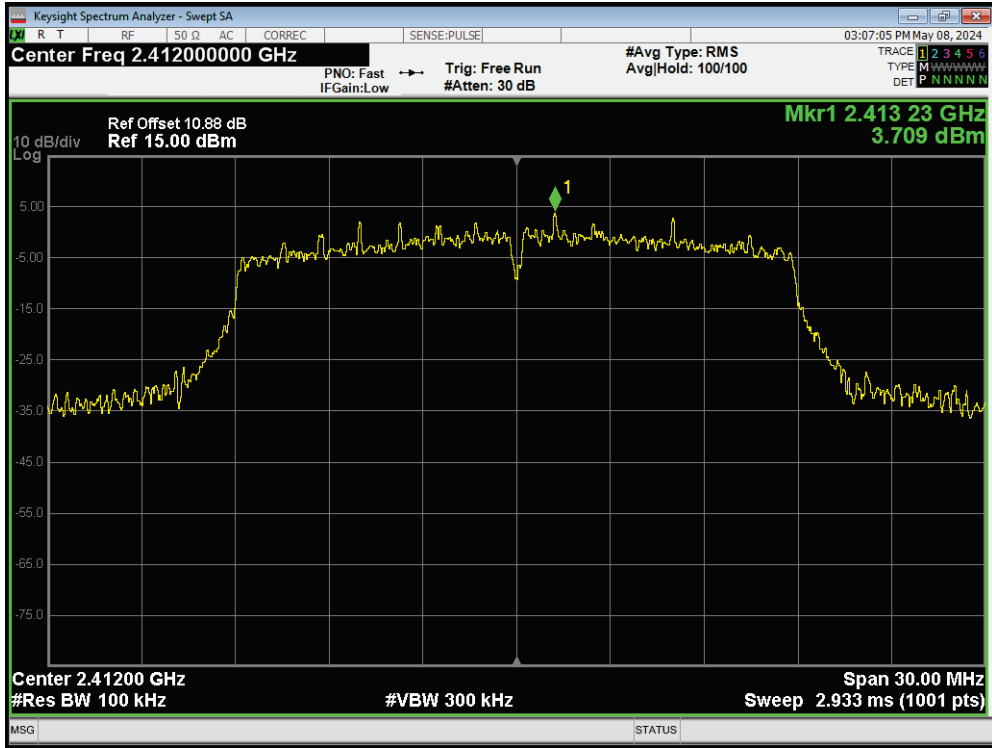

Tx. Spurious 802.11n(HT20) 2412MHz Emission

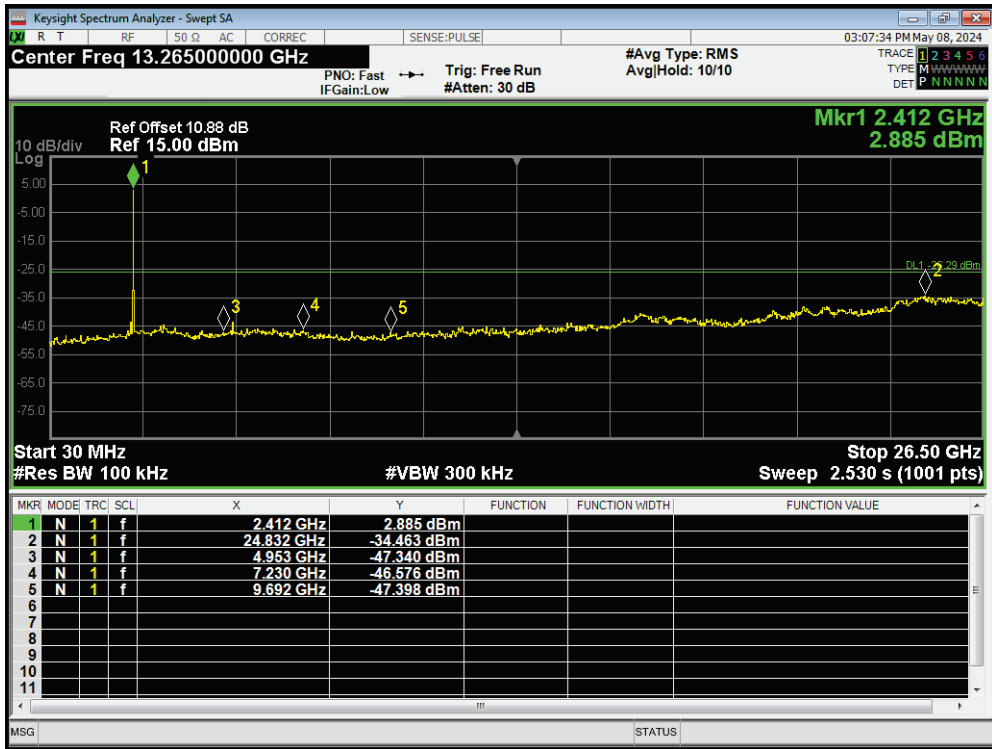

Tx. Spurious 802.11n(HT20) 2417MHz Ref

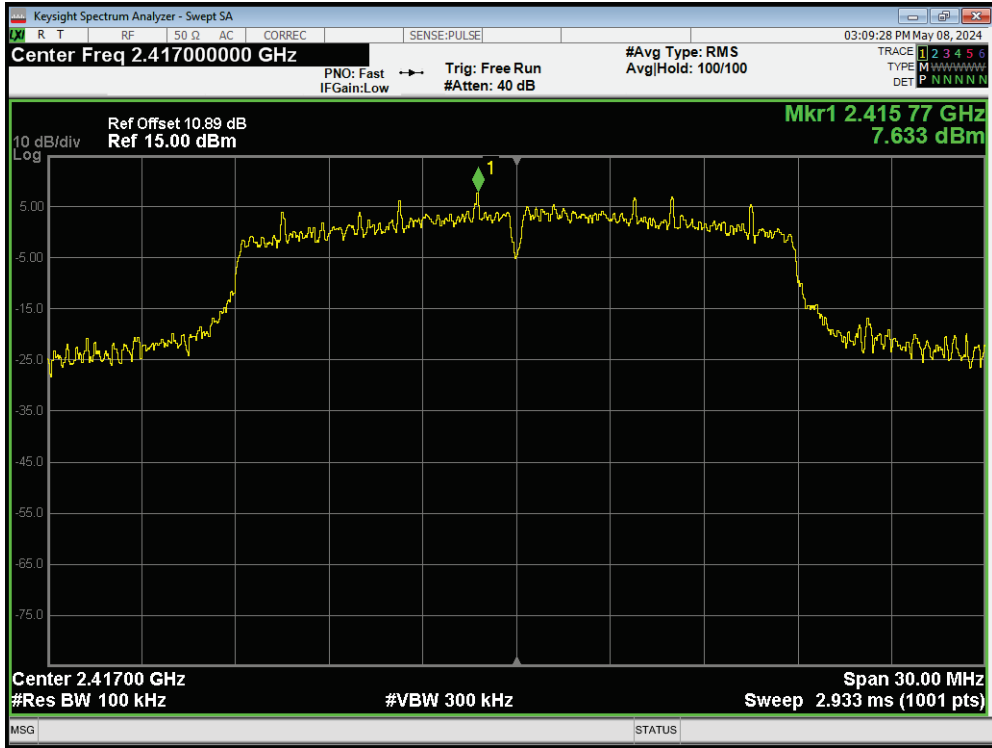

Tx. Spurious 802.11n(HT20) 2417MHz Emission

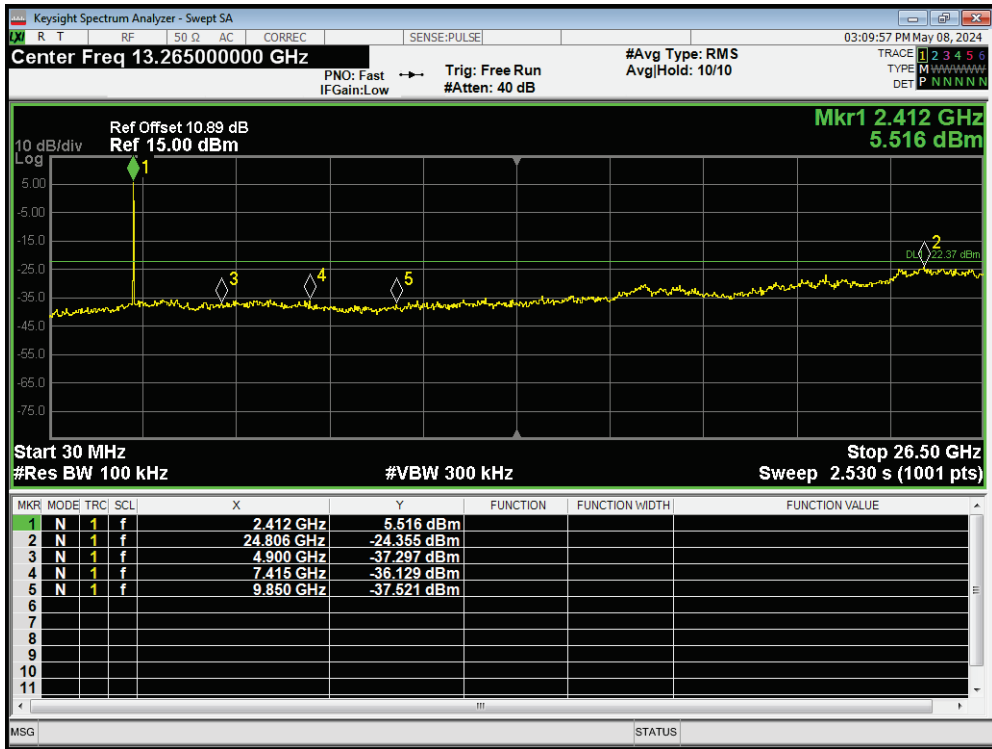

Tx. Spurious 802.11n(HT20) 2422MHz Ref

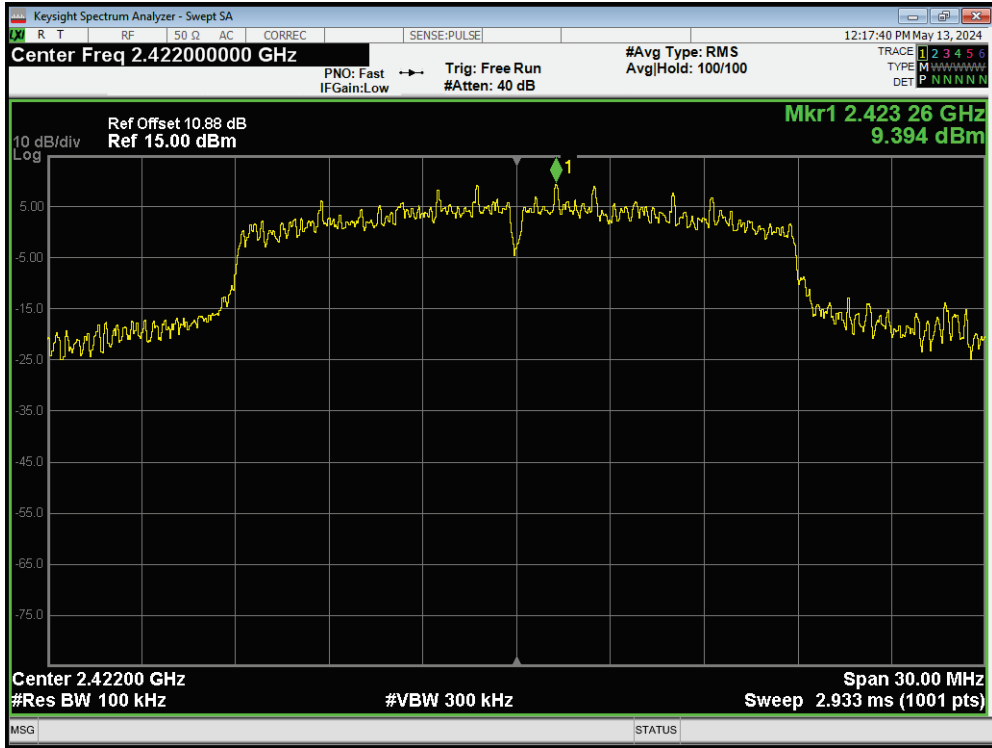

Tx. Spurious 802.11n(HT20) 2422MHz Emission

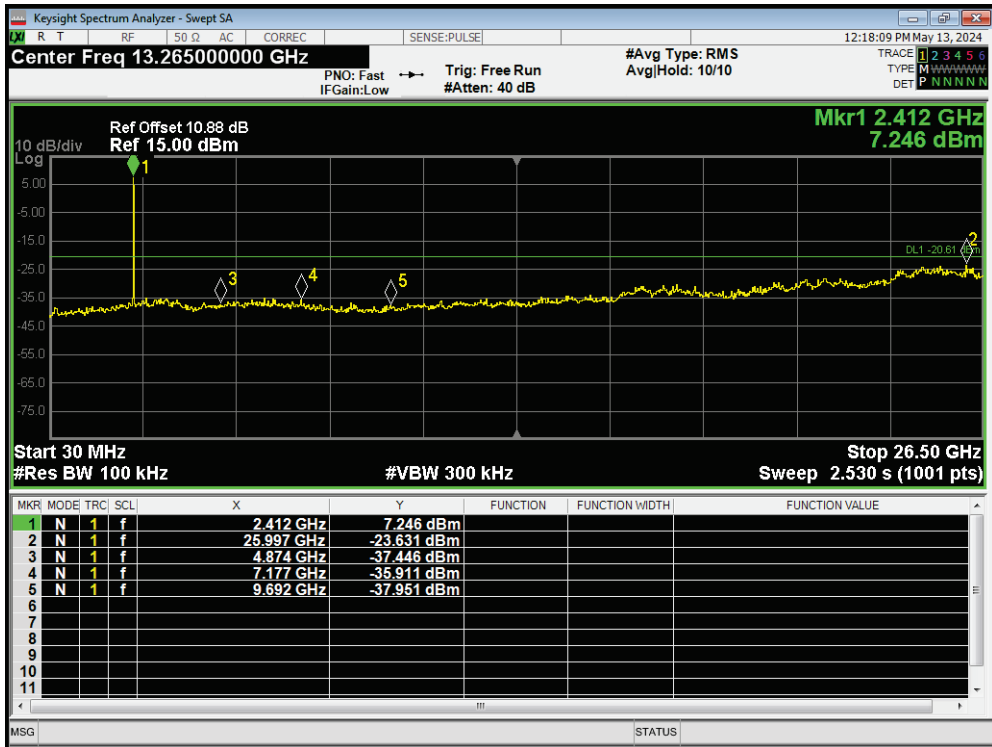

Tx. Spurious 802.11n(HT20) 2437MHz Ref

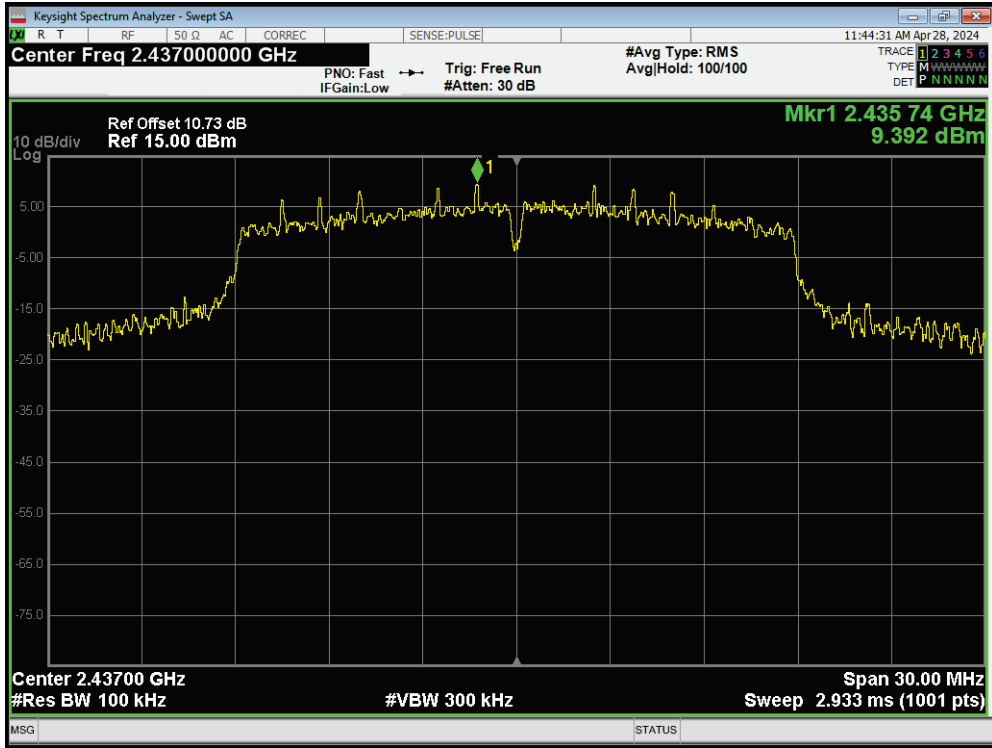

Tx. Spurious 802.11n(HT20) 2437MHz Emission

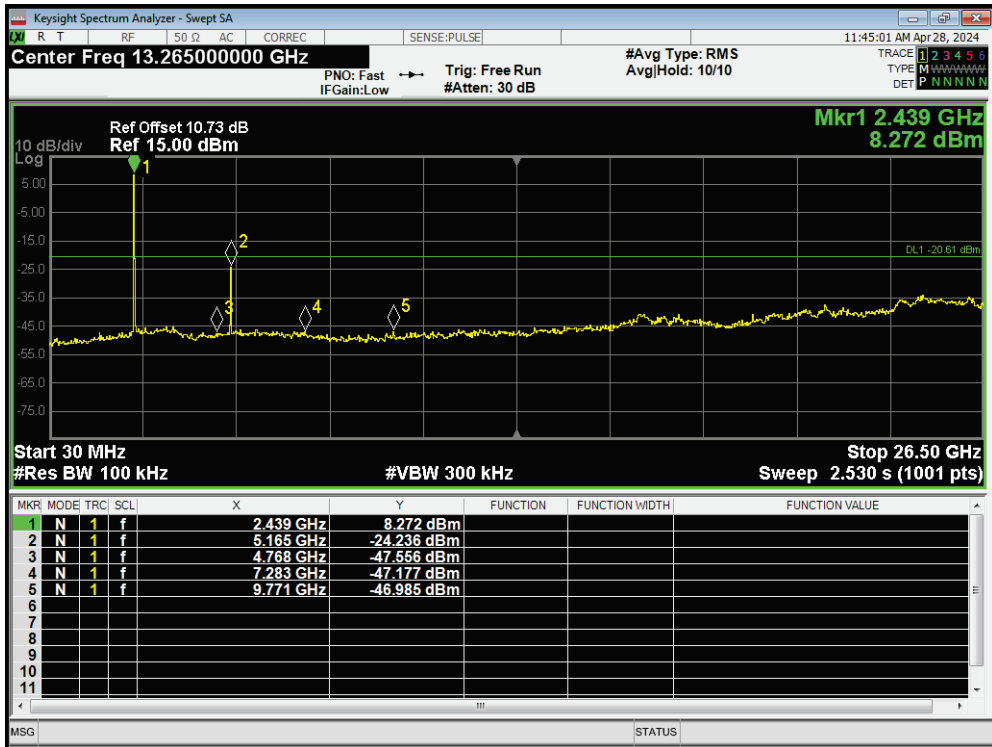

Tx. Spurious 802.11n(HT20) 2452MHz Ref

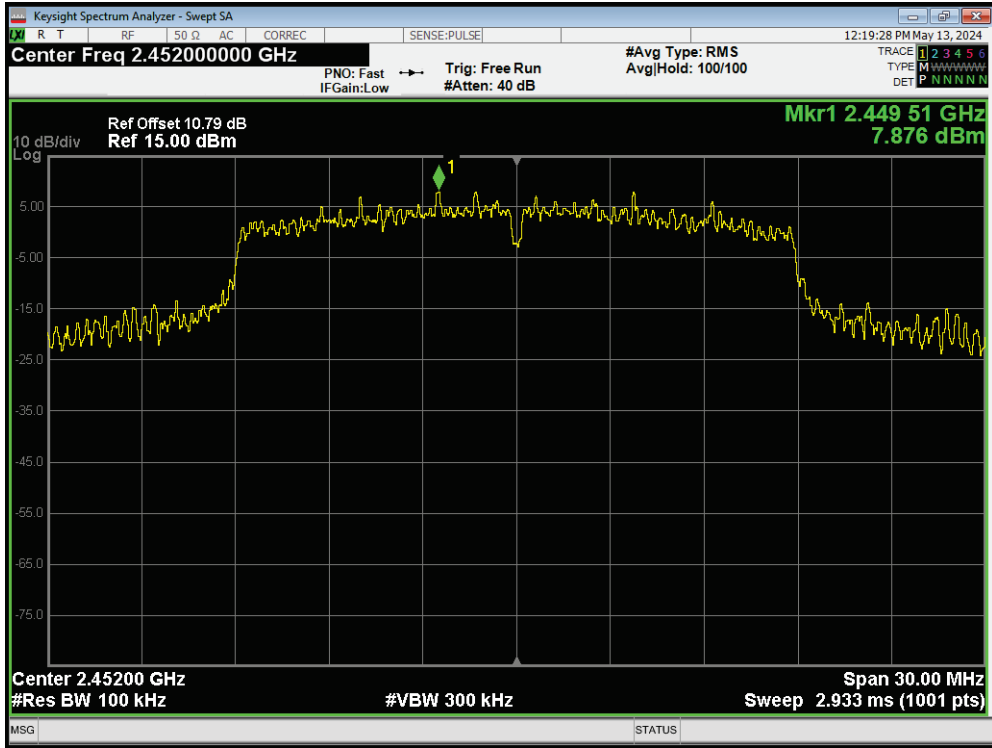

Tx. Spurious 802.11n(HT20) 2452MHz Emission

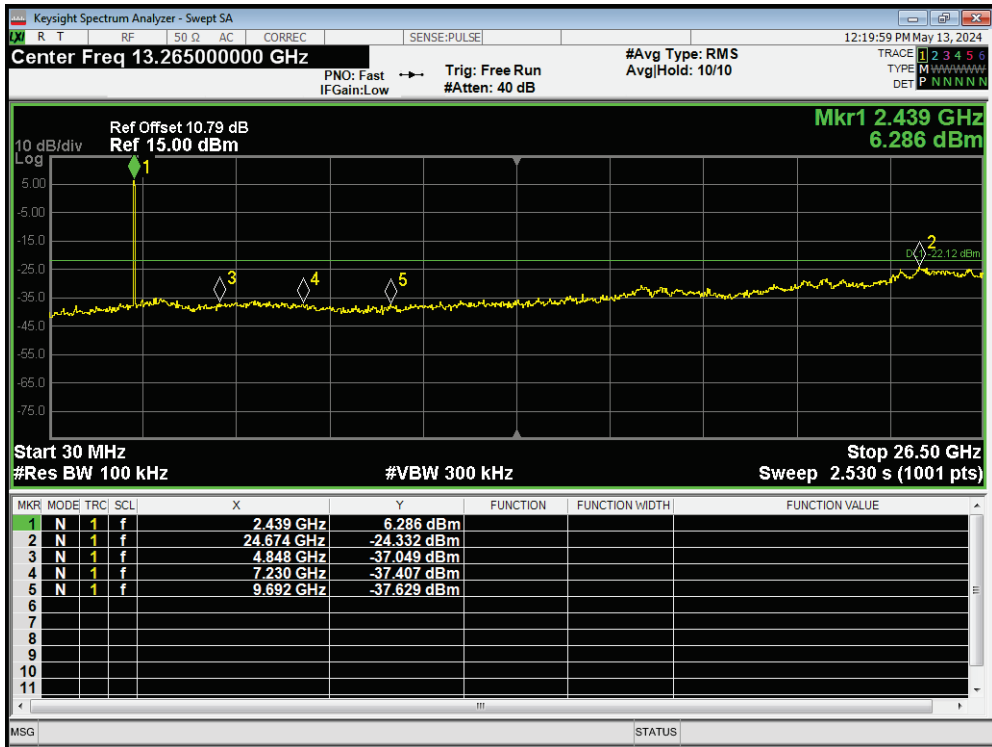

Tx. Spurious 802.11n(HT20) 2457MHz Ref

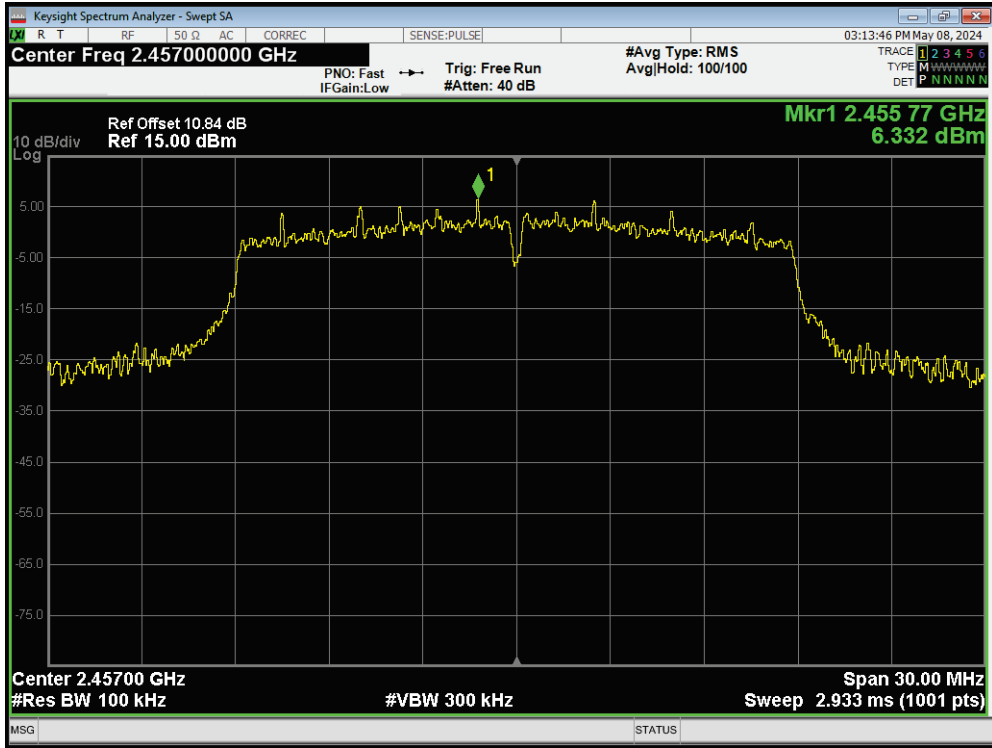

Tx. Spurious 802.11n(HT20) 2457MHz Emission

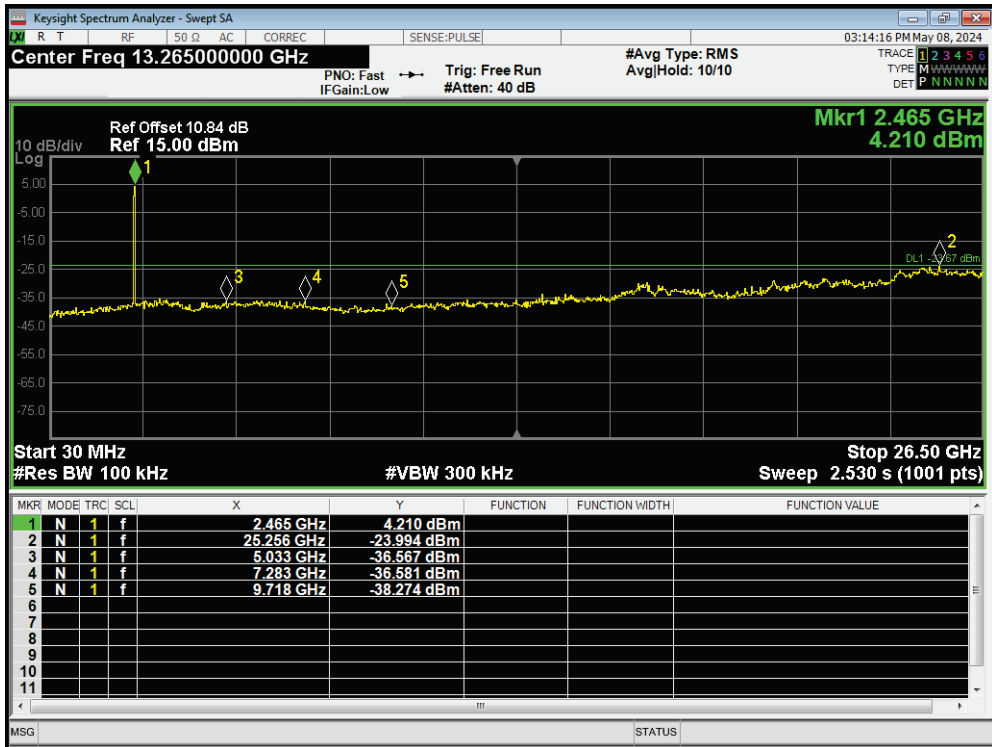

Tx. Spurious 802.11n(HT20) 2462MHz Ref

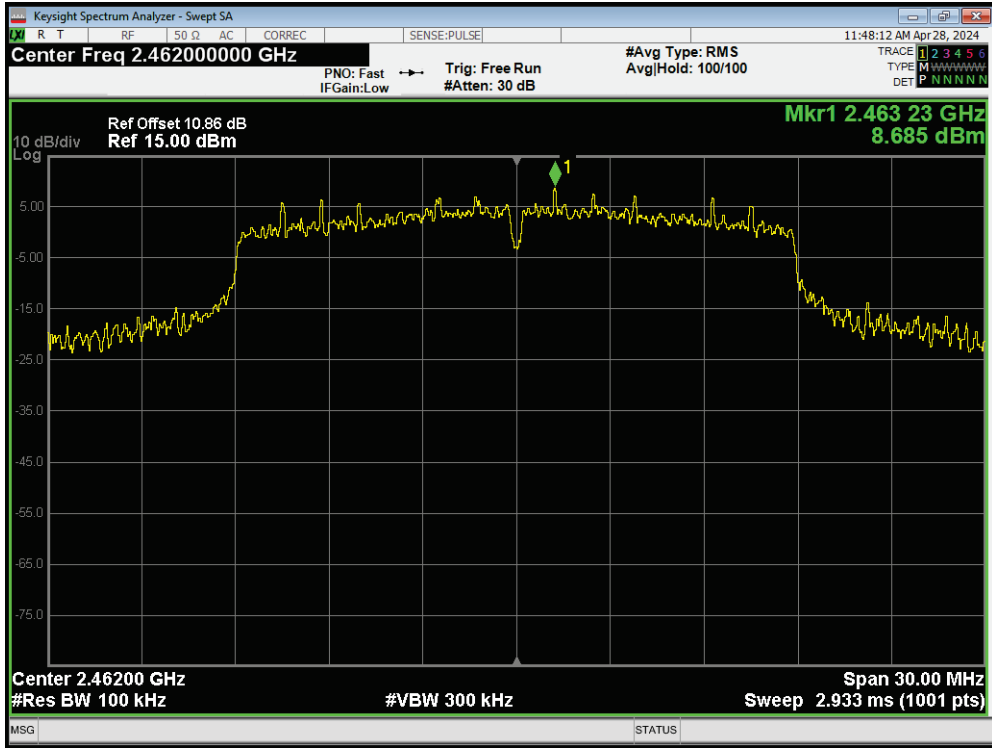

Tx. Spurious 802.11n(HT20) 2462MHz Emission

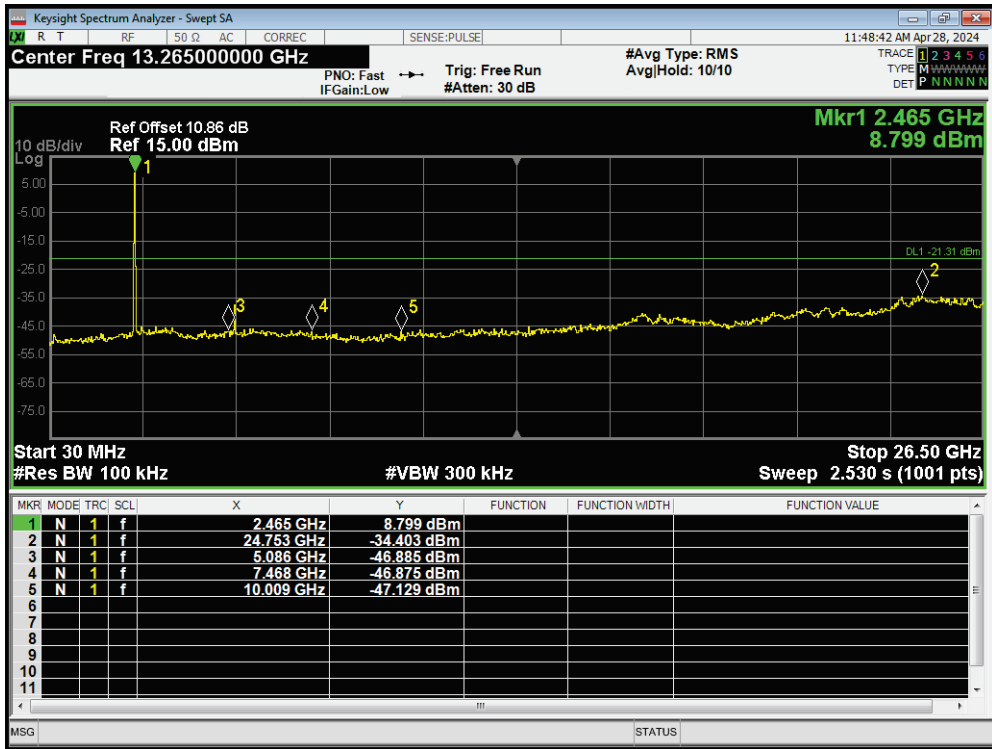

Tx. Spurious 802.11n(HT40) 2422MHz Ref

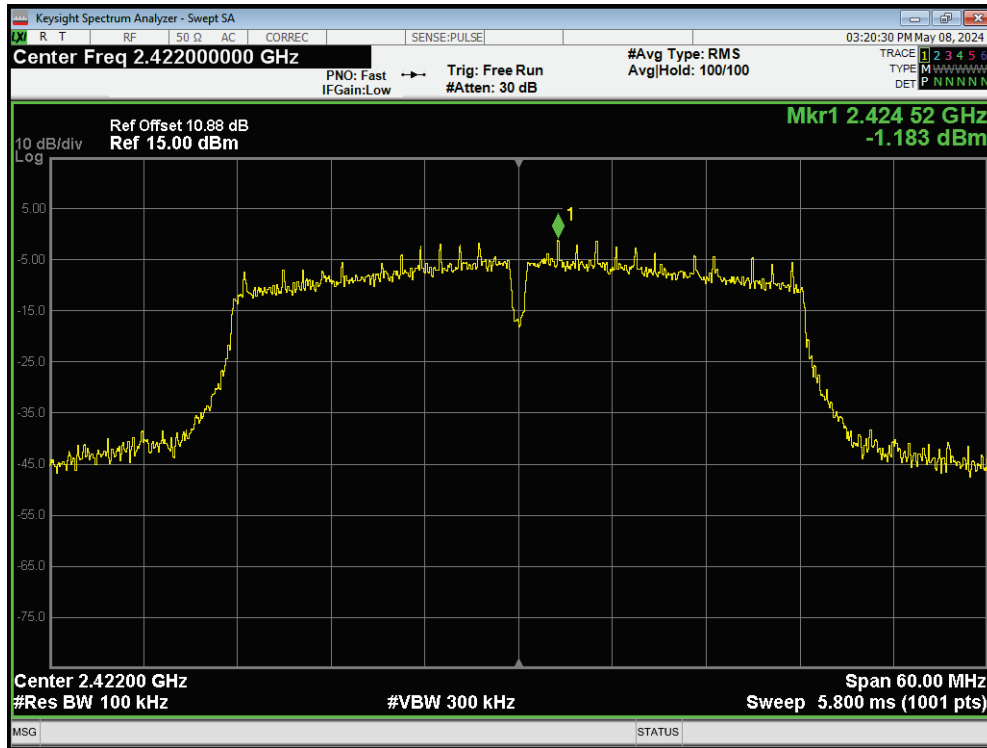

Tx. Spurious 802.11n(HT40) 2422MHz Emission

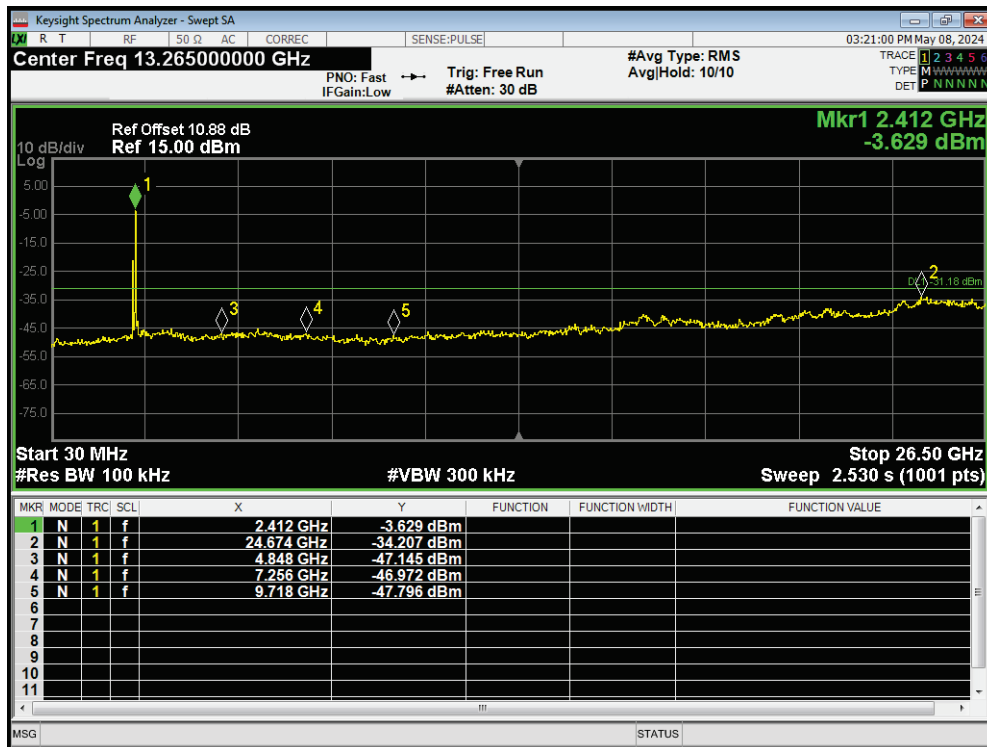

Tx. Spurious 802.11n(HT40) 2427MHz Ref

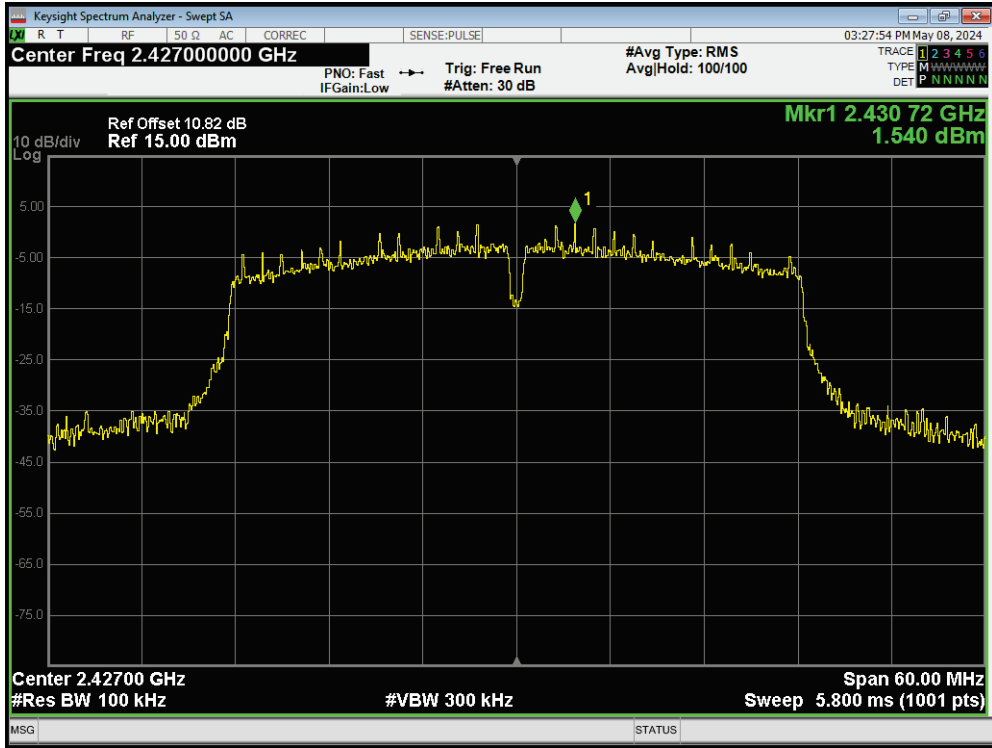

Tx. Spurious 802.11n(HT40) 2427MHz Emission

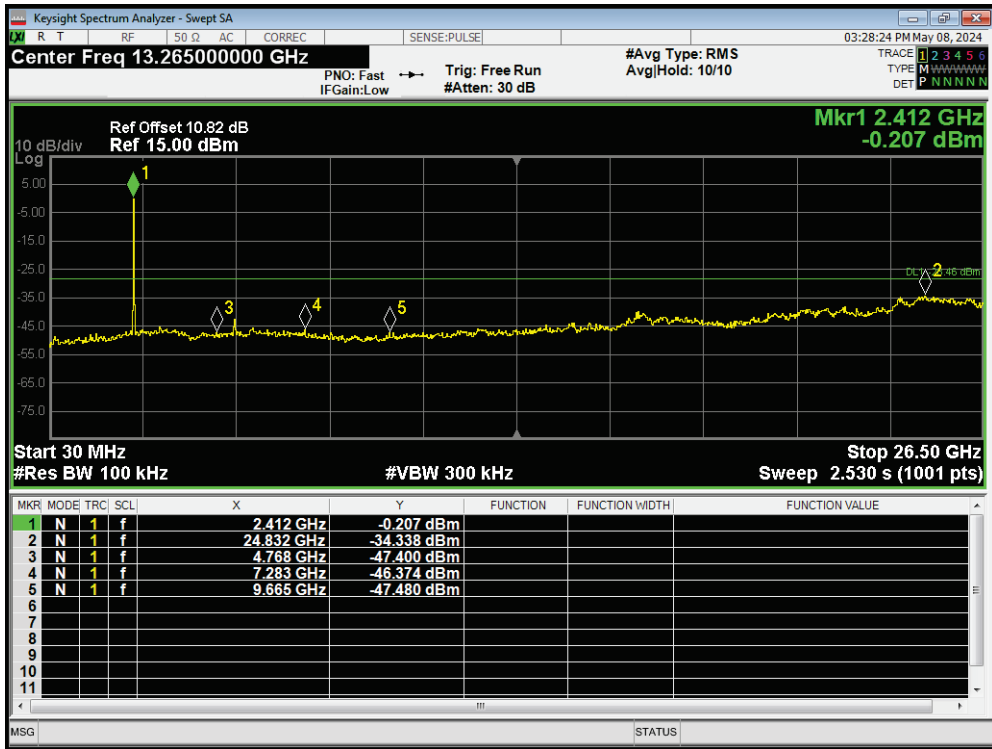

Tx. Spurious 802.11n(HT40) 2432MHz Ref

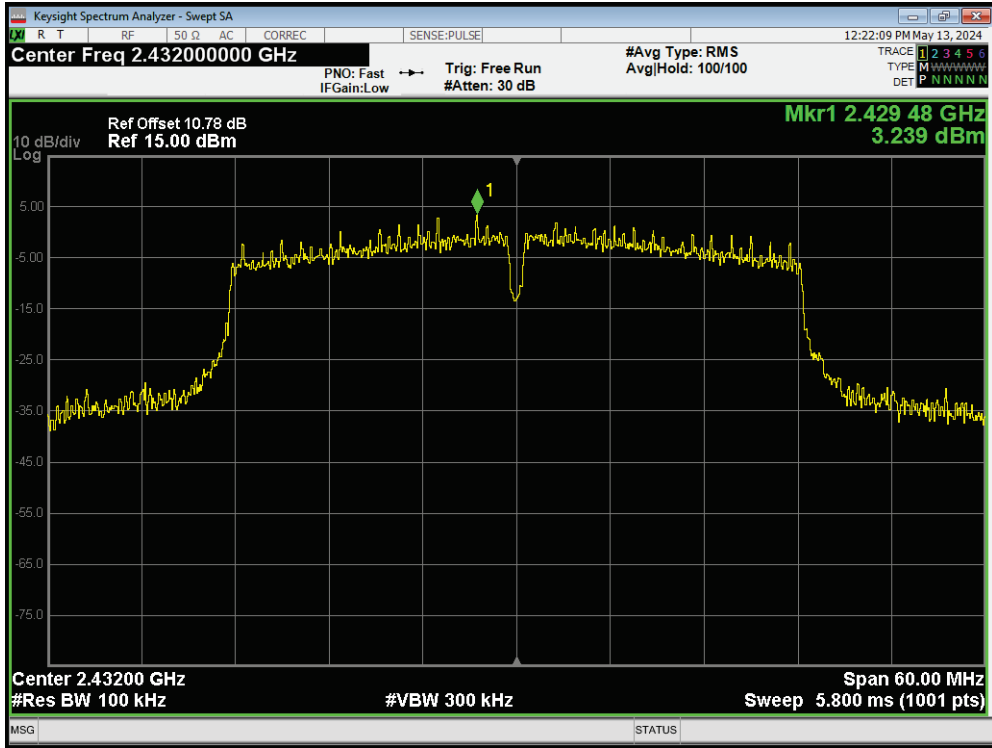

Tx. Spurious 802.11n(HT40) 2432MHz Emission

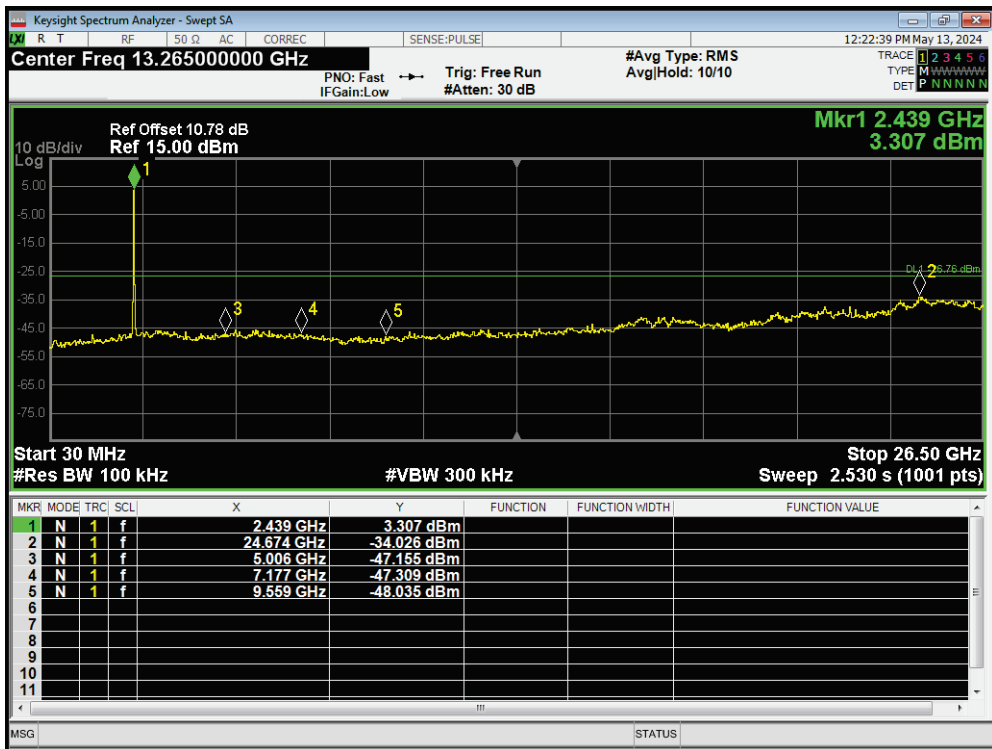

Tx. Spurious 802.11n(HT40) 2437MHz Ref

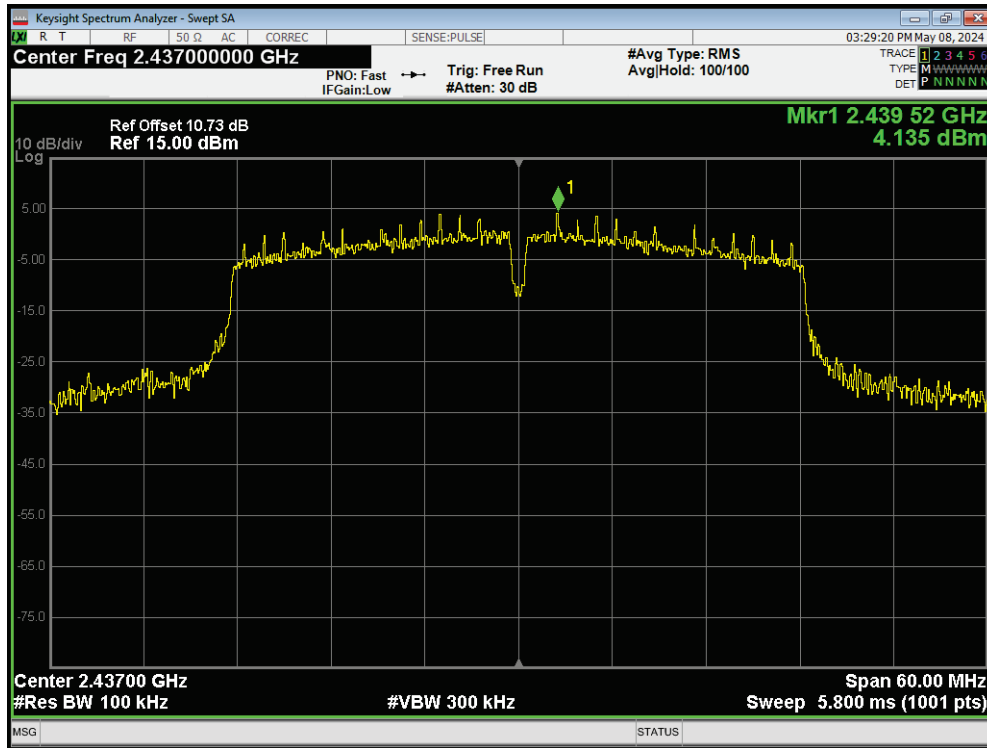

Tx. Spurious 802.11n(HT40) 2437MHz Emission

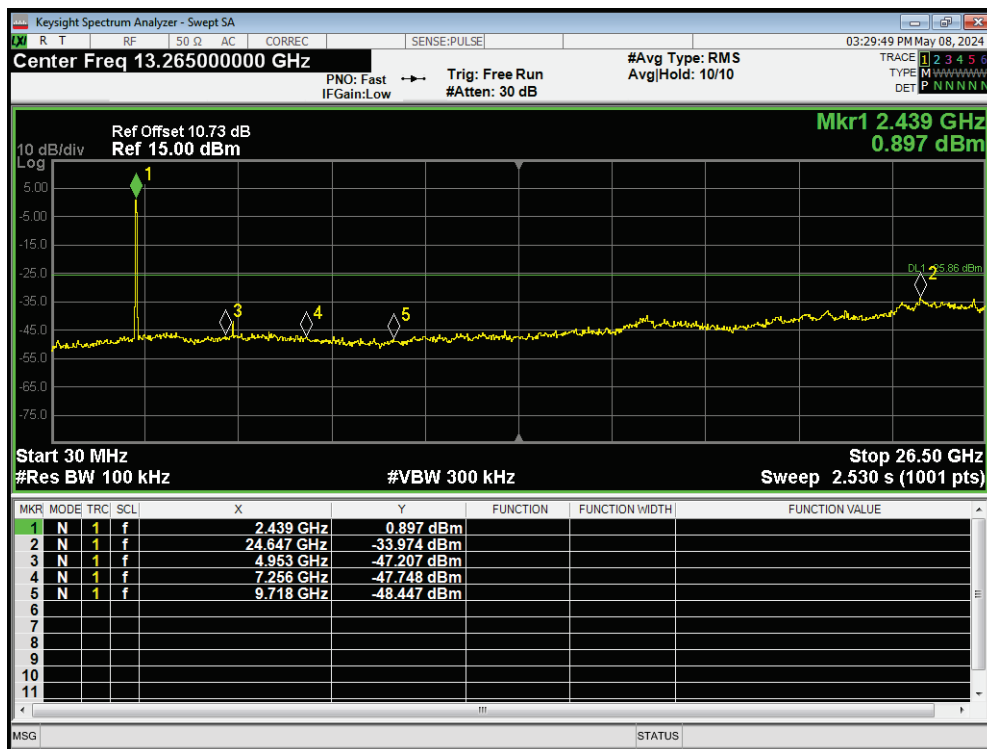

Tx. Spurious 802.11n(HT40) 2442MHz Ref

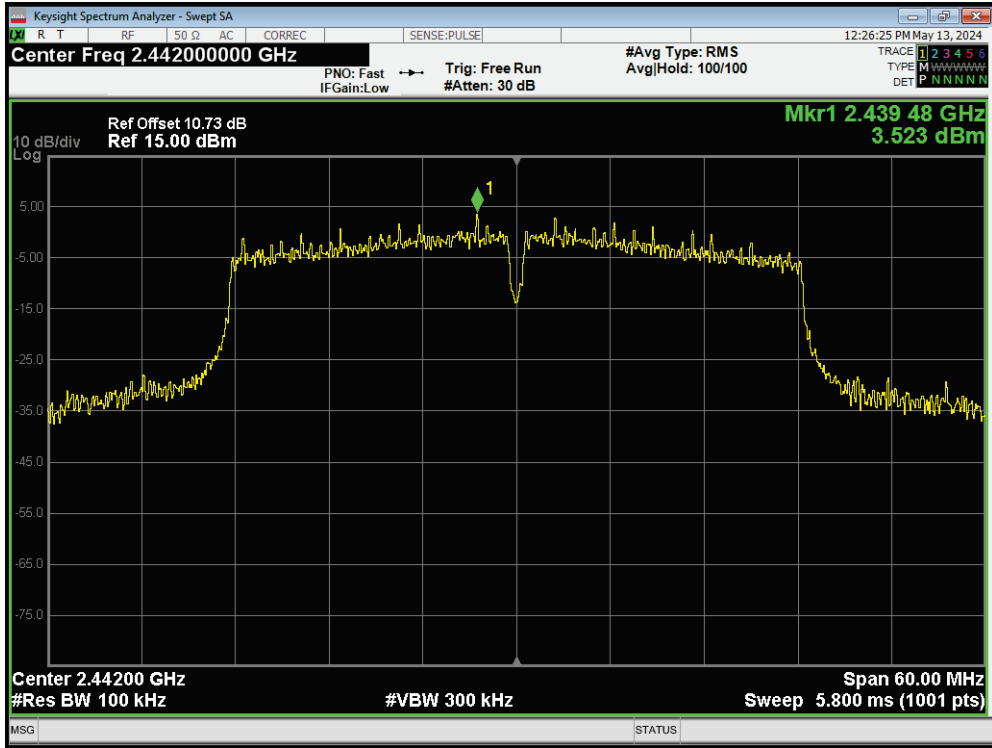

Tx. Spurious 802.11n(HT40) 2442MHz Emission

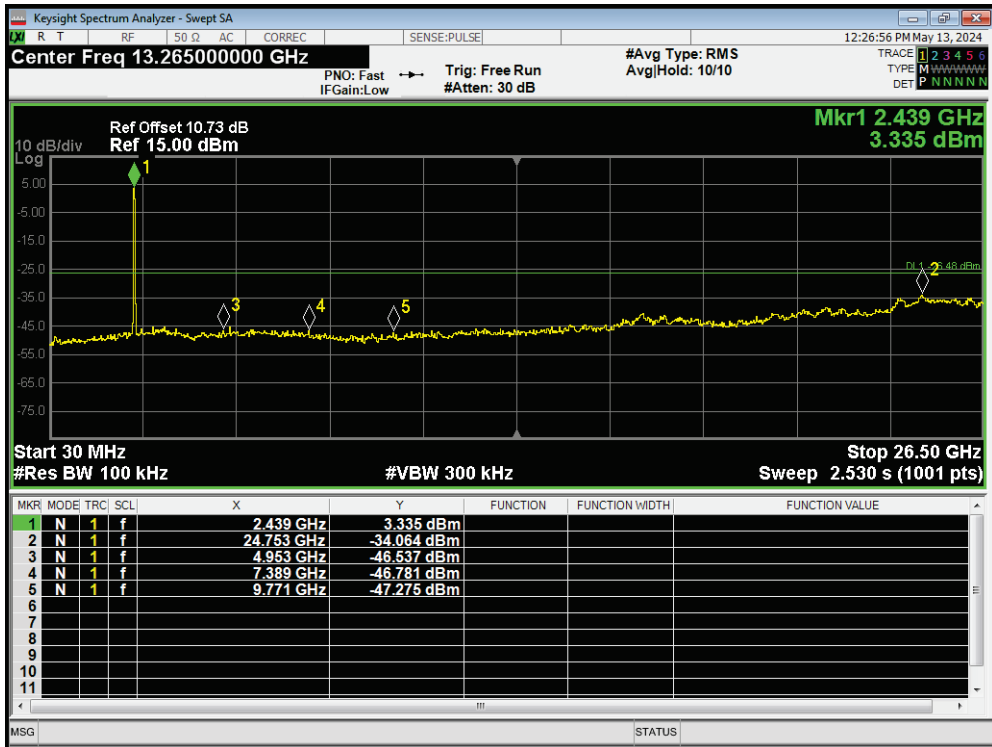

Tx. Spurious 802.11n(HT40) 2447MHz Ref

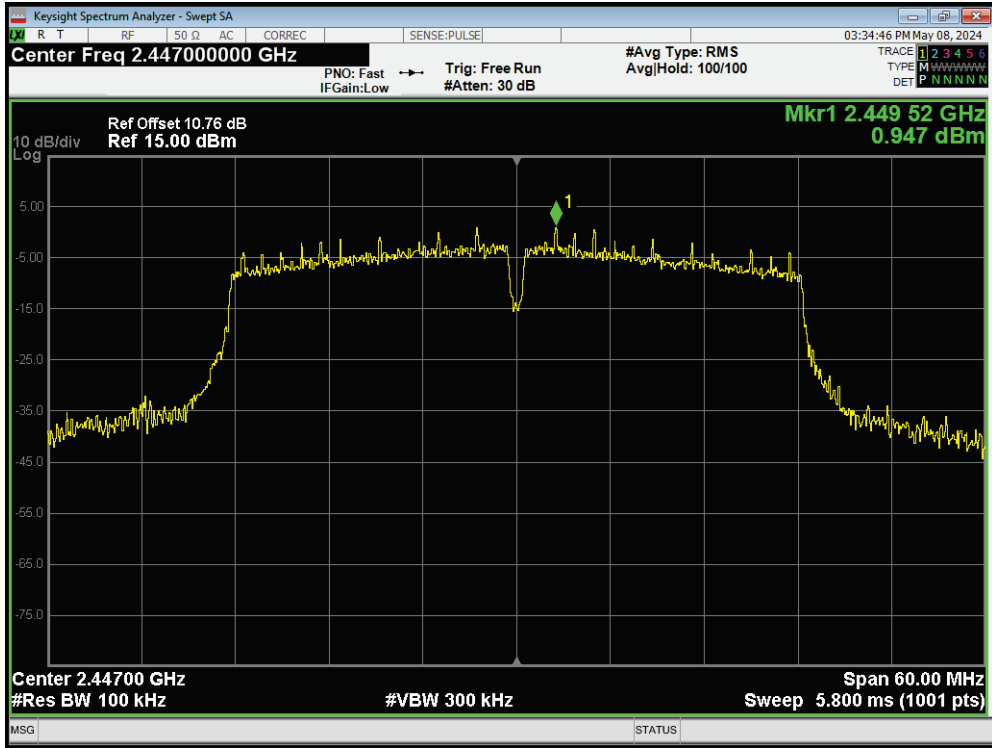

Tx. Spurious 802.11n(HT40) 2447MHz Emission

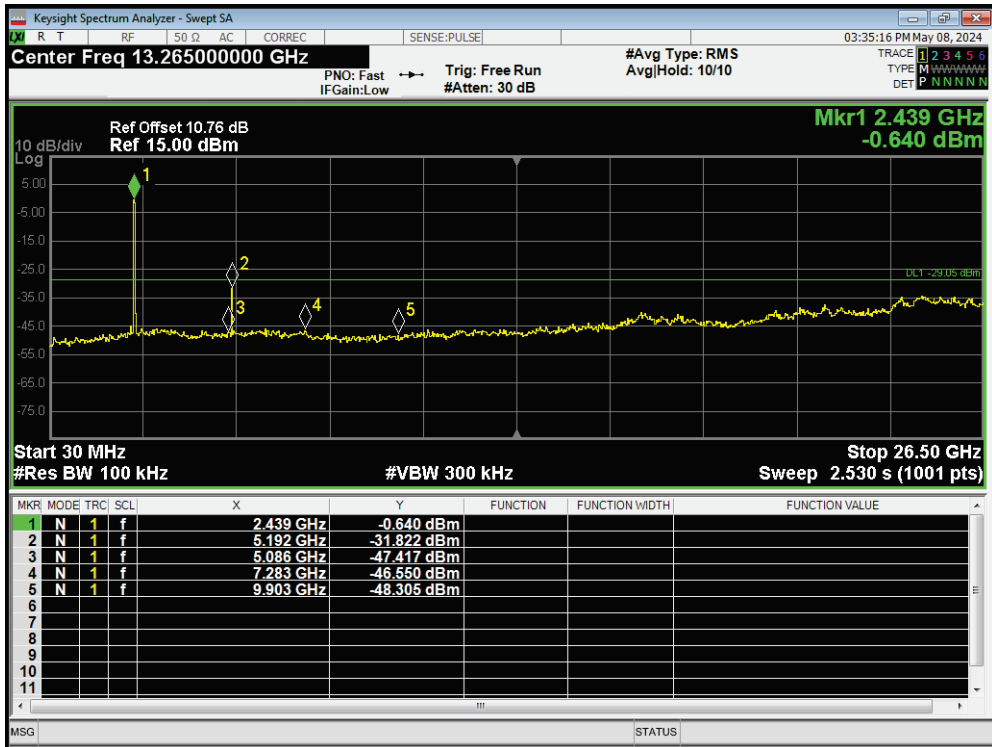

Tx. Spurious 802.11n(HT40) 2452MHz Ref

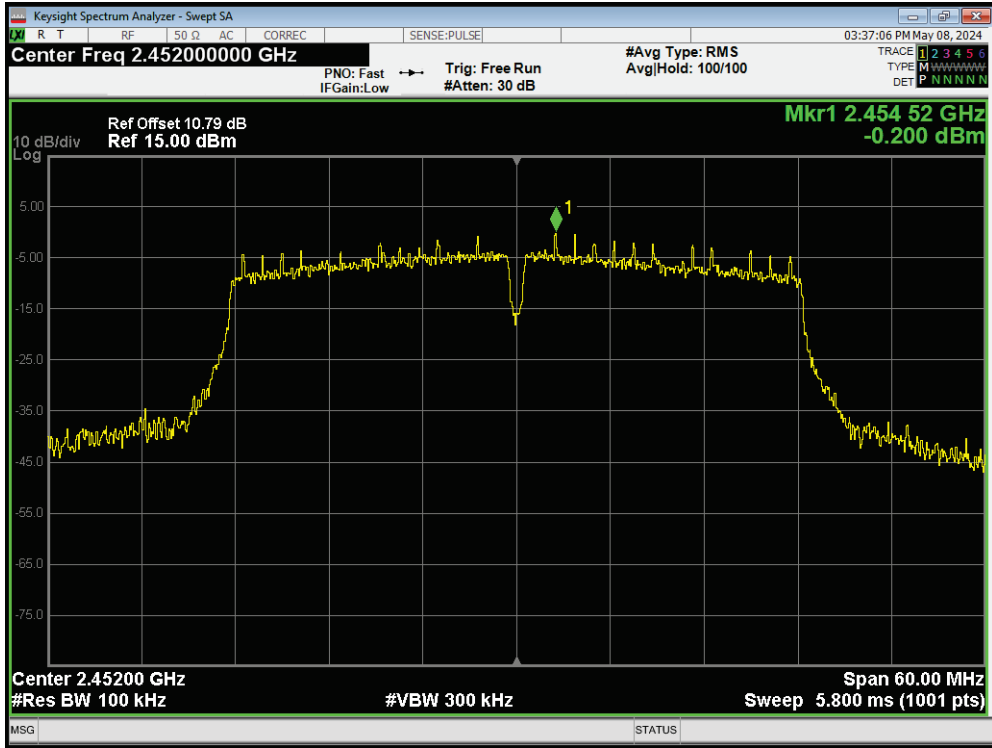

Tx. Spurious 802.11n(HT40) 2452MHz Emission

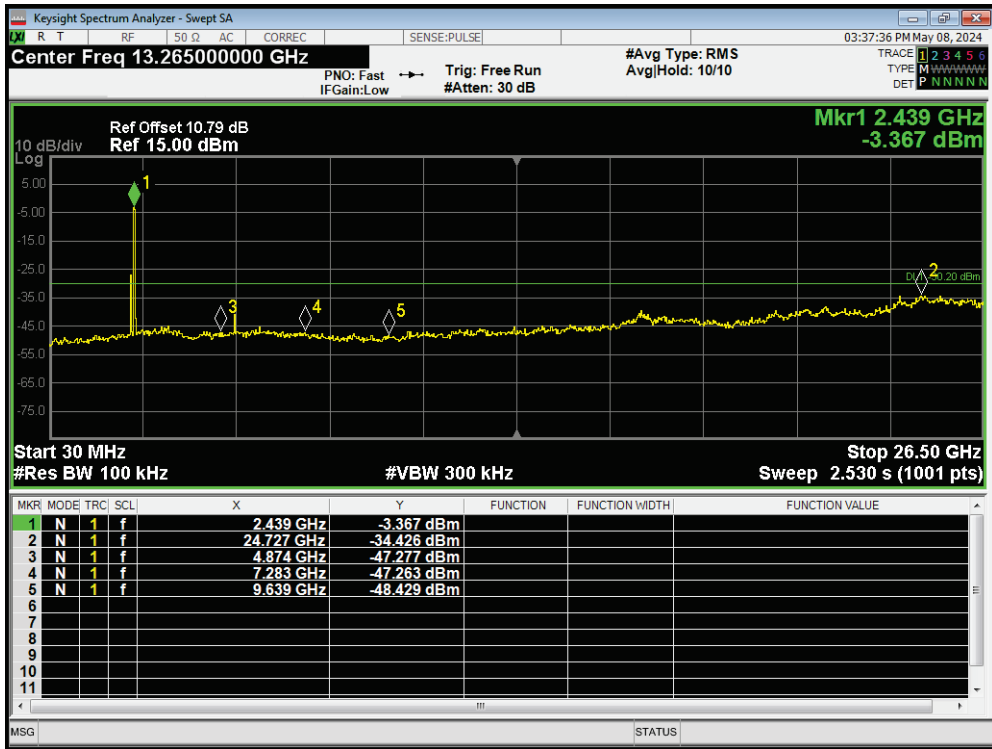

5.6. Unwanted Emission

Ambient Condition

Temperature	Relative humidity
15°C ~ 35°C	20% ~ 80%

Method of Measurement

The test set-up was made in accordance to the general provisions of ANSI C63.10. The Equipment Under Test (EUT) was set up on a non-conductive table in the semi-anechoic chamber. The test was performed at the distance of 3 m between the EUT and the receiving antenna.

The turntable shall be rotated from 0 to 360 degrees for detecting the maximum of radiated spurious signal level. The measurements shall be repeated with orthogonal polarization of the test antenna. The data of cable loss and antenna factor has been calibrated in full testing frequency range before the testing. Sweep the Restricted Band and the emissions less than 20 dB below the permissible value are reported.

The radiated emissions measurements were made in a typical installation configuration. Sweep the whole frequency band through the range from 9 kHz to the 10th harmonic of the carrier, and the emissions less than 20 dB below the permissible value are reported.

This method refer to ANSI C63.10.

The procedure for peak unwanted emissions measurements above 1000 MHz is as follows:

Set the spectrum analyzer in the following:

9kHz~150 kHz

RBW=200Hz, VBW=1kHz/ Sweep=AUTO

150 kHz~30MHz

RBW=9KHz, VBW=30KHz,/ Sweep=AUTO

Below 1GHz

RBW=100kHz / VBW=300kHz / Sweep=AUTO

a) Peak emission levels are measured by setting the instrument as follows:

Above 1GHz

PEAK: RBW=1MHz VBW=3MHz/ Sweep=AUTO

b) Average emission levels are measured by setting the instrument as follows:

Above 1GHz

AVERAGE: RBW=1MHz / VBW=3MHz / Sweep=AUTO

c) Detector: The measurements employing a CISPR quasi-peak detector except for the frequency bands 9-90 kHz, 110-490 kHz and above 1000 MHz. Radiated emission limits in these three bands are based on measurements employing an average detector.

d) Averaging type = power (i.e., rms) (As an alternative, the detector and averaging type may be set for linear voltage averaging. Some instruments require linear display mode to use linear voltage

averaging. Log or dB averaging shall not be used.)

e) Sweep time = auto.

f) Perform a trace average of at least 100 traces if the transmission is continuous. If the transmission is not continuous, then the number of traces shall be increased by a factor of $1 / D$, where D is the duty cycle. For example, with 50% duty cycle, at least 200 traces shall be averaged. (If a specific emission is demonstrated to be continuous—i.e., 100% duty cycle—then rather than turning ON and OFF with the transmit cycle, at least 100 traces shall be averaged.)

g) If tests are performed with the EUT transmitting at a duty cycle less than 98%, then a correction factor shall be added to the measurement results prior to comparing with the emission limit, to compute the emission level that would have been measured had the test been performed at 100% duty cycle. The correction factor is computed as follows:

1) If power averaging (rms) mode was used in the preceding step e), then the correction factor is $[10 \log (1 / D)]$, where D is the duty cycle. For example, if the transmit duty cycle was 50%, then 3 dB shall be added to the measured emission levels.

2) If linear voltage averaging mode was used in the preceding step e), then the correction factor is $[20 \log (1 / D)]$, where D is the duty cycle. For example, if the transmit duty cycle was 50%, then 6 dB shall be added to the measured emission levels.

3) If a specific emission is demonstrated to be continuous (100% duty cycle) rather than turning ON and OFF with the transmit cycle, then no duty cycle correction is required for that emission.

The test is in transmitting mode.

Test Setup

9KHz~ 30MHz

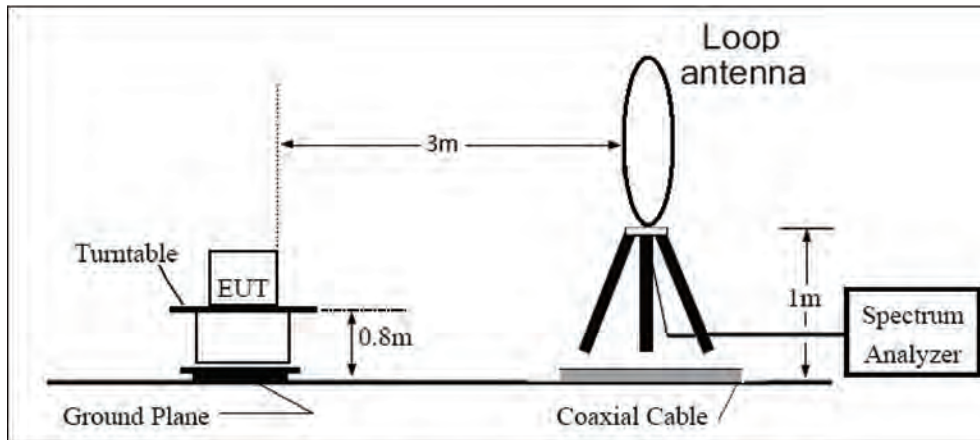

30MHz~ 1GHz

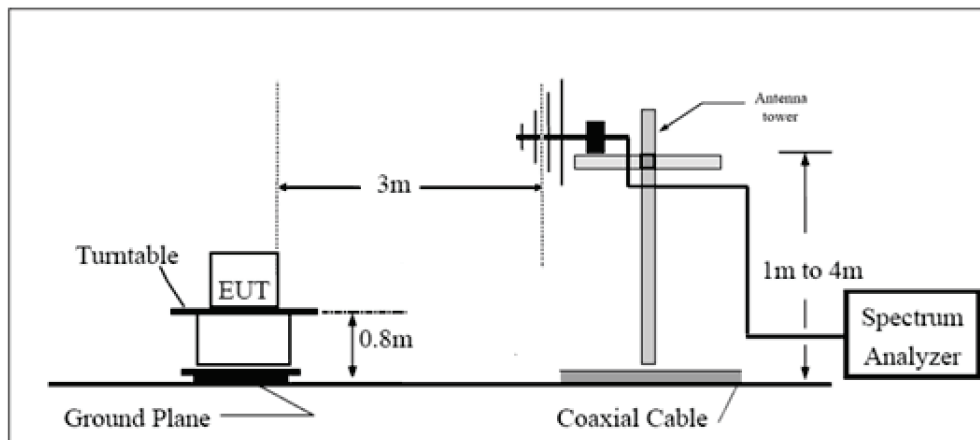

Above 1GHz

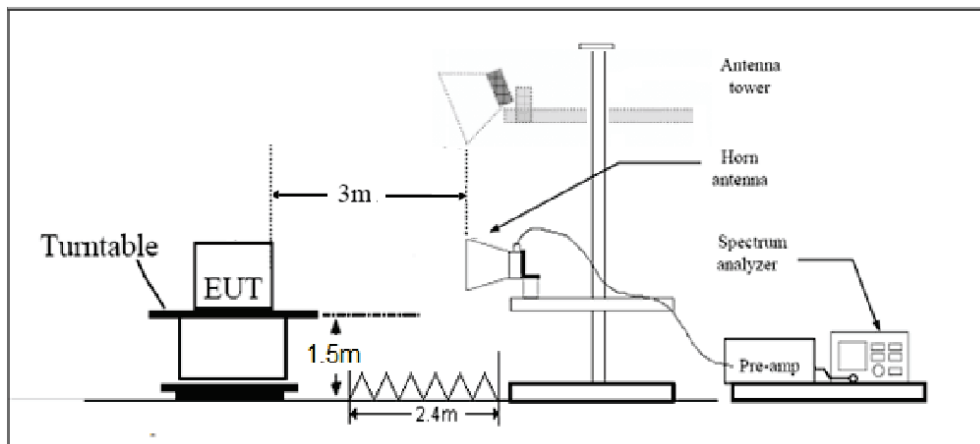

Note: Area side:2.4mX3.6m

Limits

Rule Part 15.247(d) specifies that “In addition, radiated emissions which fall in the restricted bands, as defined in § 15.205(a), must also comply with the radiated emission limits specified in § 15.209(a) (see § 15.205(c)).”

Limit in restricted band

Frequency of emission (MHz)	Field strength(μ V/m)	Field strength(dB μ V/m)
0.009–0.490	2400/F(kHz)	/
0.490–1.705	24000/F(kHz)	/
1.705–30.0	30	/
30-88	100	40
88-216	150	43.5
216-960	200	46
Above960	500	54

§15.35(b)

There is also a limit on the radio frequency emissions, as measured using instrumentation with a peak detector function, corresponding to 20 dB above the maximum permitted average limit.

Peak Limit=74 dB μ V/m

Average Limit=54 dB μ V/m

Spurious Radiated Emissions are permitted in any of the frequency bands listed below:

MHz	MHz	MHz	GHz
0.090-0.110	16.42-16.423	399.9-410	4.5-5.15
¹ 0.495-0.505	16.69475-16.69525	608-614	5.35-5.46
2.1735-2.1905	16.80425-16.80475	960-1240	7.25-7.75
4.125-4.128	25.5-25.67	1300-1427	8.025-8.5
4.17725-4.17775	37.5-38.25	1435-1626.5	9.0-9.2
4.20725-4.20775	73-74.6	1645.5-1646.5	9.3-9.5
6.215-6.218	74.8-75.2	1660-1710	10.6-12.7
6.26775-6.26825	108-121.94	1718.8-1722.2	13.25-13.4
6.31175-6.31225	123-138	2200-2300	14.47-14.5
8.291-8.294	149.9-150.05	2310-2390	15.35-16.2
8.362-8.366	156.52475-156.52525	2483.5-2500	17.7-21.4
8.37625-8.38675	156.7-156.9	2690-2900	22.01-23.12
8.41425-8.41475	162.0125-167.17	3260-3267	23.6-24.0
12.29-12.293	167.72-173.2	3332-3339	31.2-31.8
12.51975-12.52025	240-285	3345.8-3358	36.43-36.5
12.57675-12.57725	322-335.4	3600-4400	(²)
13.36-13.41			

Measurement Uncertainty

The assessed measurement uncertainty to ensure 95% confidence level for the normal distribution is with the coverage factor $k = 1.96$.

Frequency	Uncertainty
9KHz-30MHz	3.55 dB
30MHz-200MHz	4.17 dB
200MHz-1GHz	4.84 dB
1-18GHz	6.51 dB
18-26.5GHz	5.90 dB
26.5GHz~40GHz	5.92 dB

Test Results:

The following graphs display the maximum values of horizontal and vertical by software. Blue trace uses the peak detection, Green trace uses the average detection.

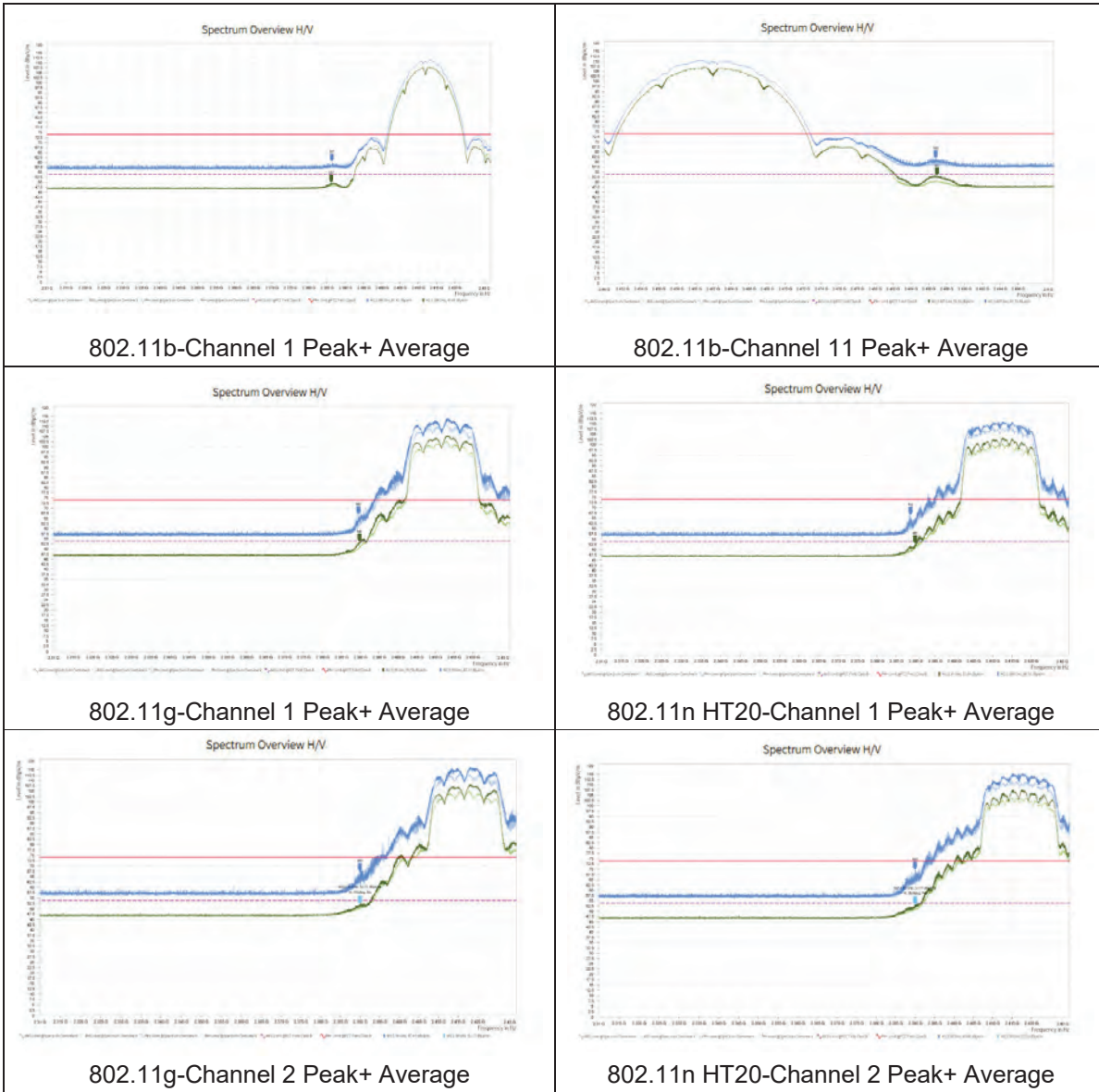

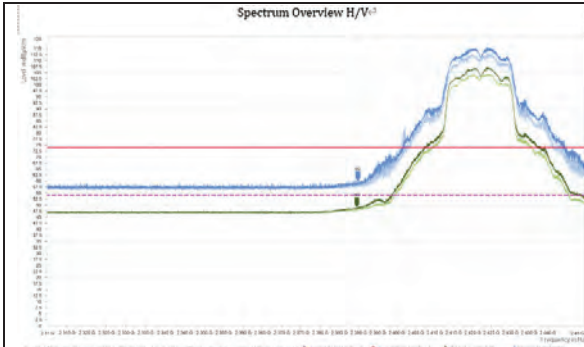

802.11g-Channel 3 Peak+ Average

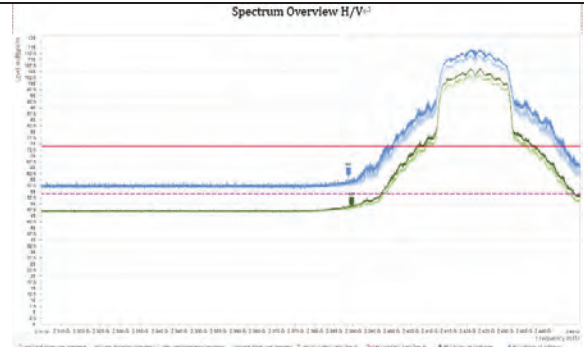

802.11n HT20-Channel 3 Peak+ Average

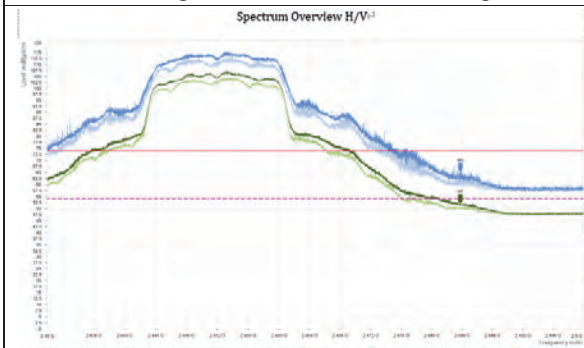

802.11g-Channel 9 Peak+ Average

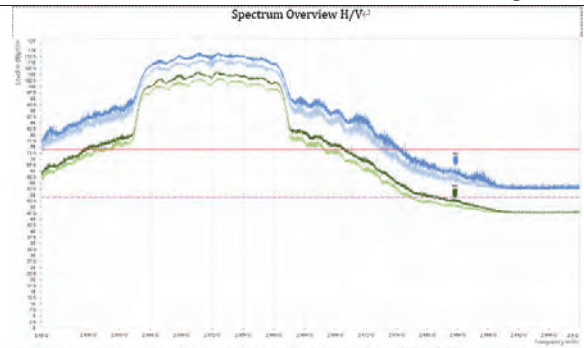

802.11n HT20-Channel 9 Peak+ Average

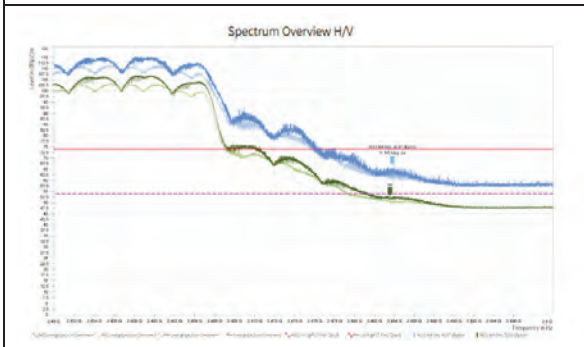

802.11g-Channel 10 Peak+ Average

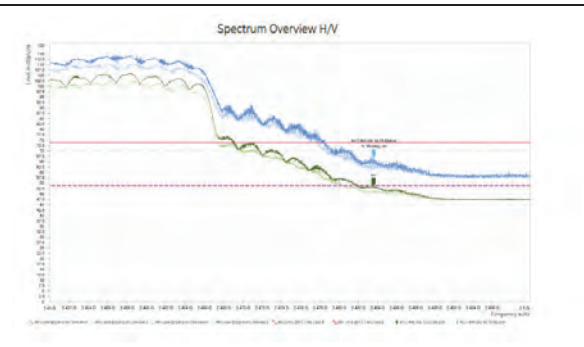

802.11n HT20-Channel 10 Peak+ Average

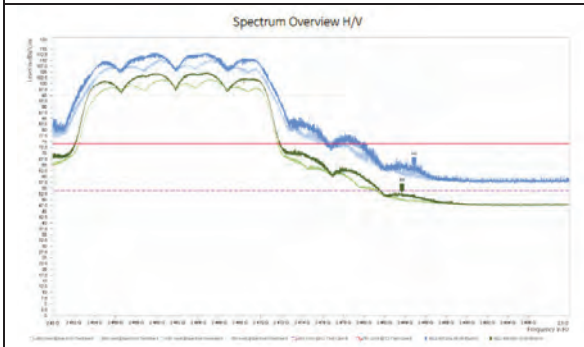

802.11g-Channel 11 Peak+ Average

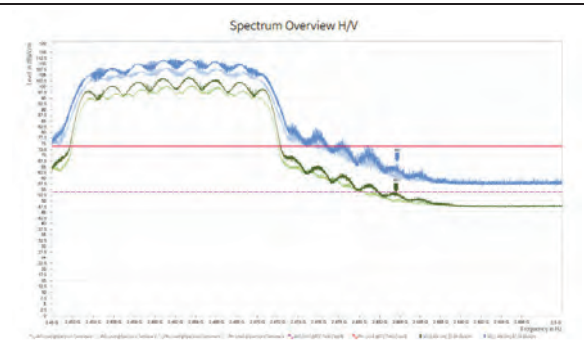

802.11n HT20-Channel 11 Peak+ Average

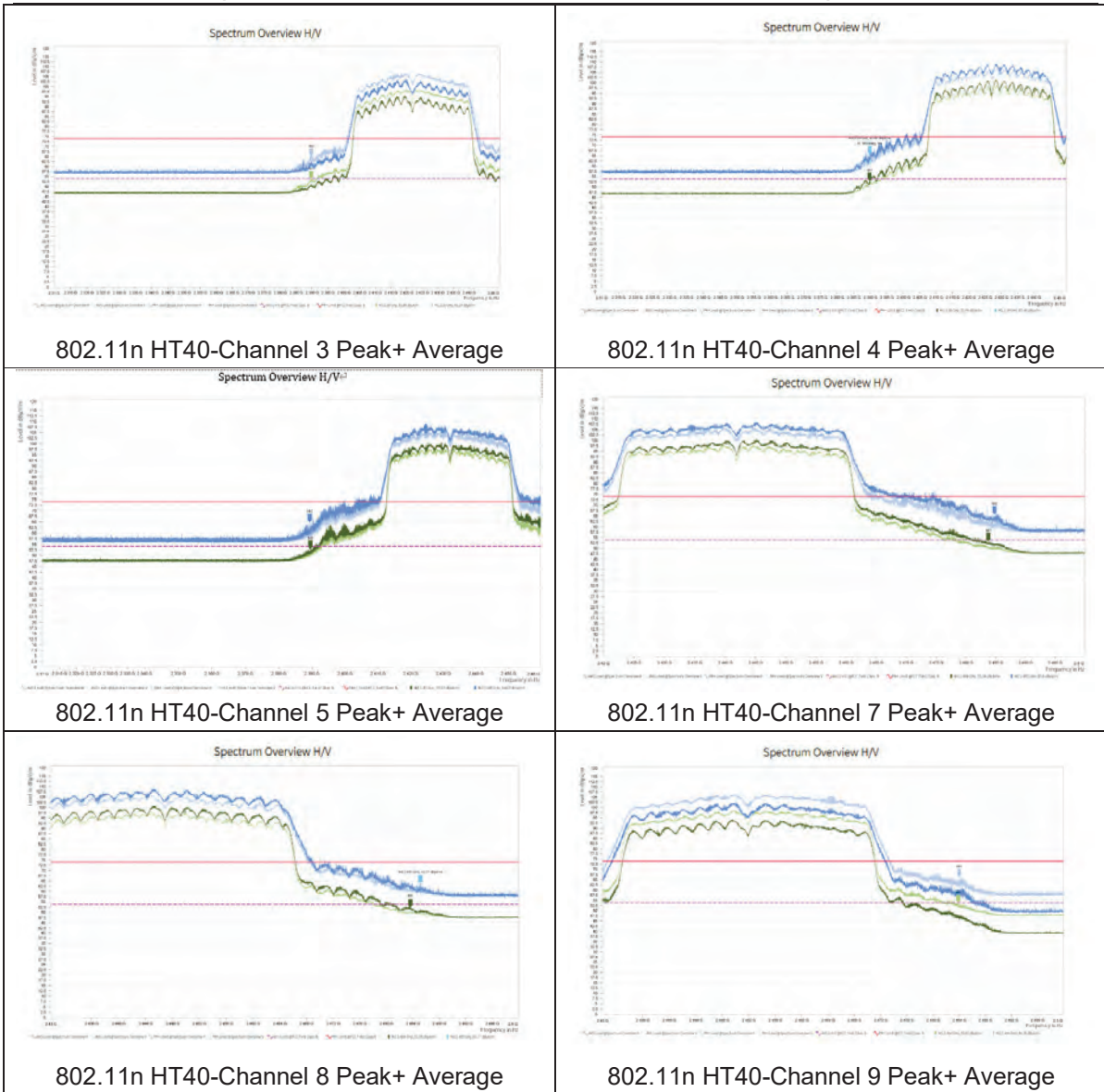

Result of RE
Test result

Sweep the whole frequency band through the range from 9kHz to the 10th harmonic of the carrier, the Emissions in the frequency band 9kHz-30MHz are more than 20dB below the limit are not reported.

The following graphs display the maximum values of horizontal and vertical by software.

For above 1GHz, Blue trace uses the peak detection, Green trace uses the average detection.

After the pretest, MIMO was selected as the worst antenna.

Continuous TX mode:

During the test, the Radiates Emission from 30MHz to 1GHz was performed in all modes with all channels, 802.11n (HT40) CH4 are selected as the worst condition. The test data of the worst-case condition was recorded in this report.

A symbol ($\text{dB } \mu\text{V/m}$) in the test plot below means ($\text{dB}\mu\text{V/m}$)

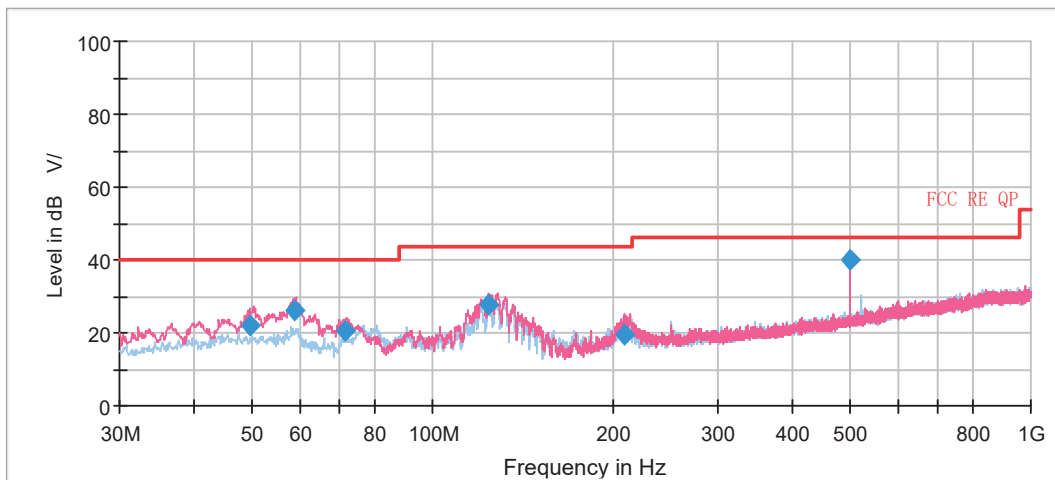

Radiates Emission from 30MHz to 1GHz

Frequency (MHz)	Quasi-Peak ($\text{dB}\mu\text{V/m}$)	Limit ($\text{dB}\mu\text{V/m}$)	Margin (dB)	Height (cm)	Polarization	Azimuth (deg)	Correct Factor (dB)
49.728750	21.83	40.00	18.17	100.0	V	9.0	21.0
58.900000	26.01	40.00	13.99	100.0	V	348.0	19.8
71.310000	20.26	40.00	19.74	100.0	V	0.0	16.1
123.853750	27.89	43.50	15.61	100.0	V	76.0	16.4
209.092500	19.49	43.50	24.01	100.0	V	181.0	18.3
500.005000	40.24	46.00	5.76	125.0	V	91.0	25.1

Remark: 1. Correction Factor = Antenna factor + Insertion loss (cable loss + amplifier gain)

2. Margin = Limit – Quasi-Peak

802.11b CH1

Spectrum Overview H/V

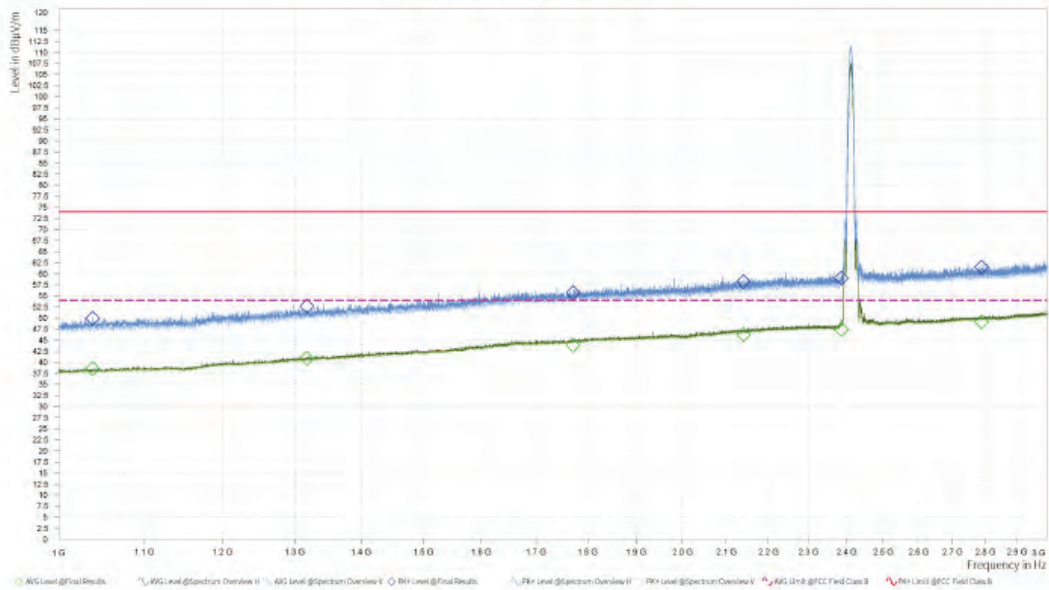

Note: The signal beyond the limit is carrier.
Radiates Emission from 1GHz to 3GHz

Spectrum Overview H/V



Radiates Emission from 3GHz to 18GHz

Frequency (MHz)	MaxPeak (dB μ V/m)	MaxPeak Limit (dB μ V/m)	MaxPeak Margin (dB)	Average (dB μ V/m)	Average Limit (dB μ V/m)	Average Margin (dB)	Meas. Time (s)	Pol	Azimuth (deg)	Height (m)	Corr. (dB/m)
1,038.500	49.93	74.00	24.07	38.54	54.00	15.46	1.000	H	68.9	1.00	-6.58
1,317.750	52.64	74.00	21.36	40.92	54.00	13.08	1.000	H	38.5	1.00	-3.78
1,771.250	55.77	74.00	18.23	43.84	54.00	10.16	1.000	V	354.3	2.00	-0.76
2,140.500	58.26	74.00	15.74	46.28	54.00	7.72	1.000	V	360	2.00	1.34
2,387.000	58.98	74.00	15.02	47.41	54.00	6.59	1.000	H	191.7	1.00	2.38
2,789.250	61.49	74.00	12.51	49.18	54.00	4.82	1.000	H	168.2	1.00	3.61

Remark: 1. Correction Factor = Antenna factor + Insertion loss (cable loss + amplifier gain)

2. Margin = Limit -MAX Peak/ Average

802.11b CH6

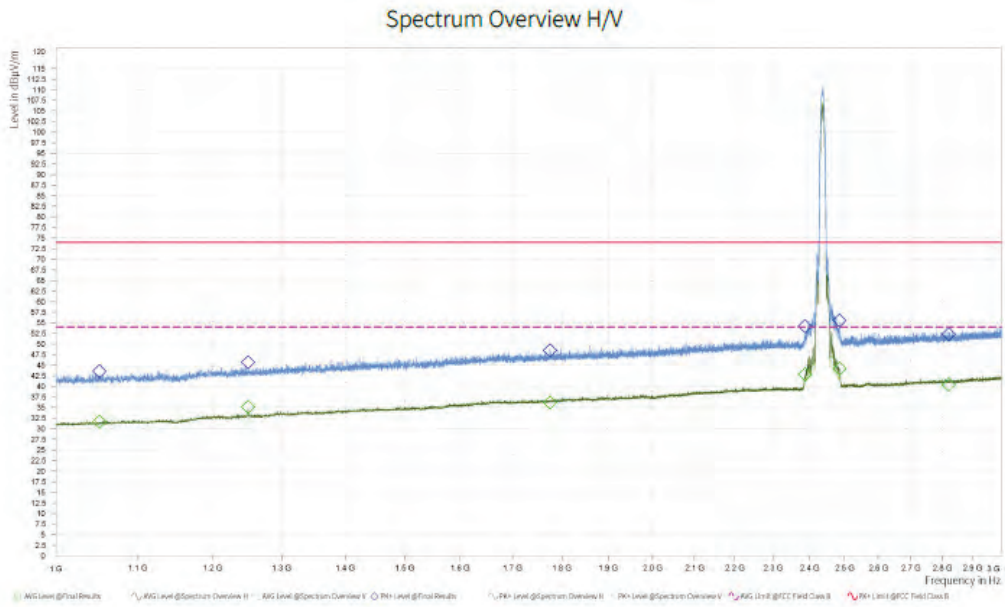

Note: The signal beyond the limit is carrier.
Radiates Emission from 1GHz to 3GHz

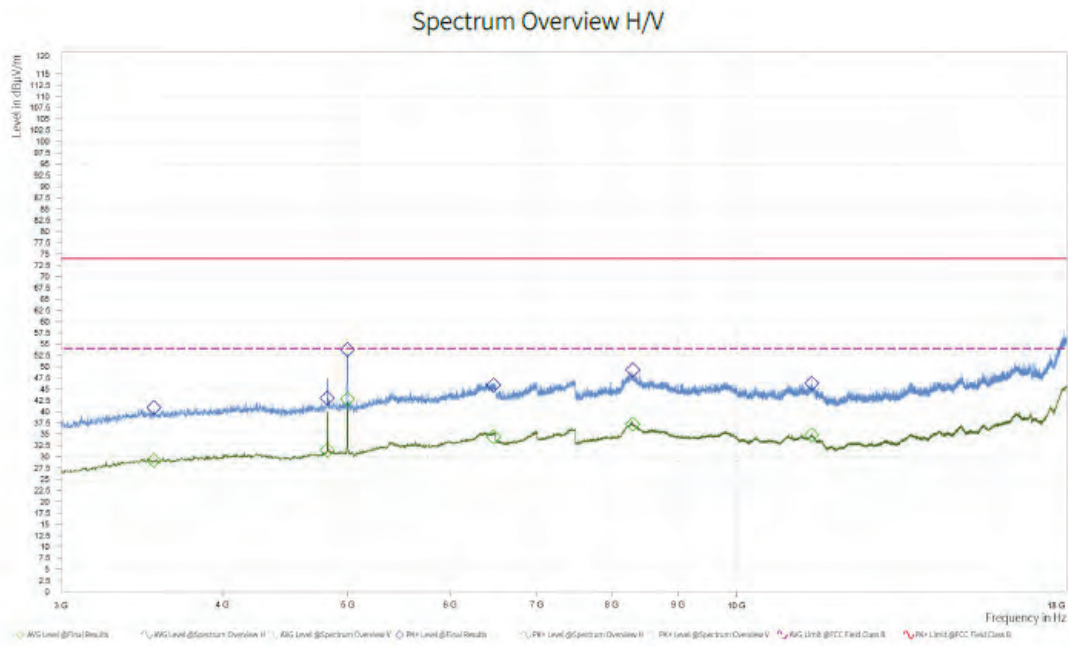

Radiates Emission from 3GHz to 18GHz

Frequency (MHz)	MaxPeak (dB μ V/m)	MaxPeak Limit (dB μ V/m)	MaxPeak Margin (dB)	Average (dB μ V/m)	Average Limit (dB μ V/m)	Average Margin (dB)	Meas. Time (s)	Pol	Azimuth (deg)	Height (m)	Corr. (dB/m)
1,051.750	43.59	74.00	30.41	31.67	54.00	22.33	1.000	H	46.3	1.00	-6.48
1,250.000	45.73	74.00	28.27	35.21	54.00	18.79	1.000	V	214.3	1.00	-4.37
1,775.250	48.51	74.00	25.49	36.23	54.00	17.77	1.000	H	15.5	1.00	-0.72
2,387.750	54.24	74.00	19.76	42.84	54.00	11.16	1.000	H	144.7	2.00	2.39
2,485.000	55.60	74.00	18.40	44.17	54.00	9.83	1.000	H	152.6	2.00	2.81
2,821.750	52.35	74.00	21.65	40.48	54.00	13.52	1.000	V	107.1	1.00	3.70

Remark: 1. Correction Factor = Antenna factor + Insertion loss (cable loss + amplifier gain)

2. Margin = Limit –MAX Peak/ Average

802.11b CH11

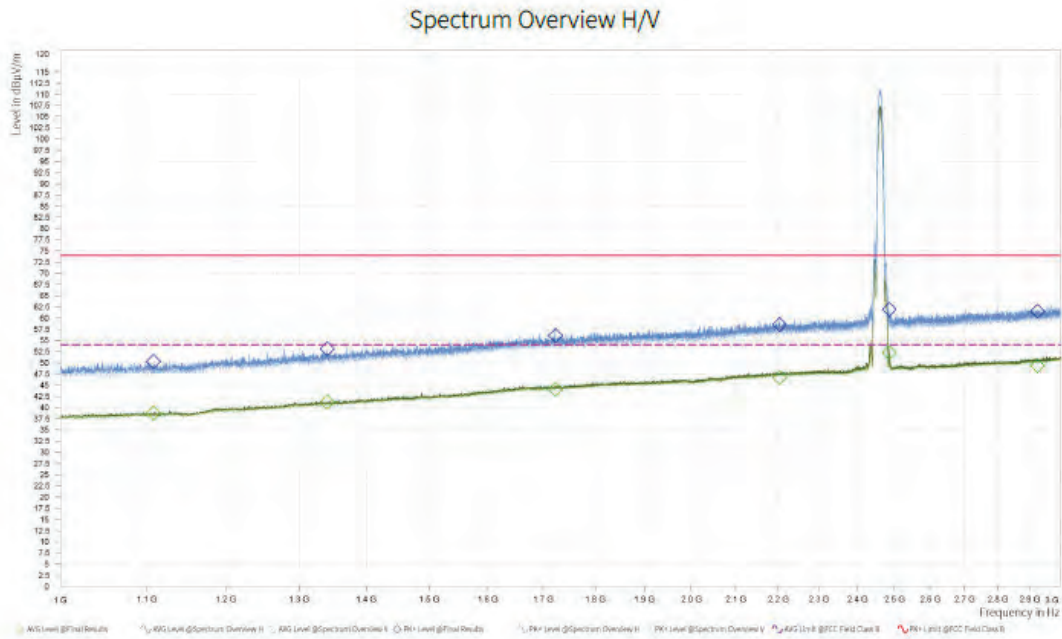

Note: The signal beyond the limit is carrier.
Radiates Emission from 1GHz to 3GHz

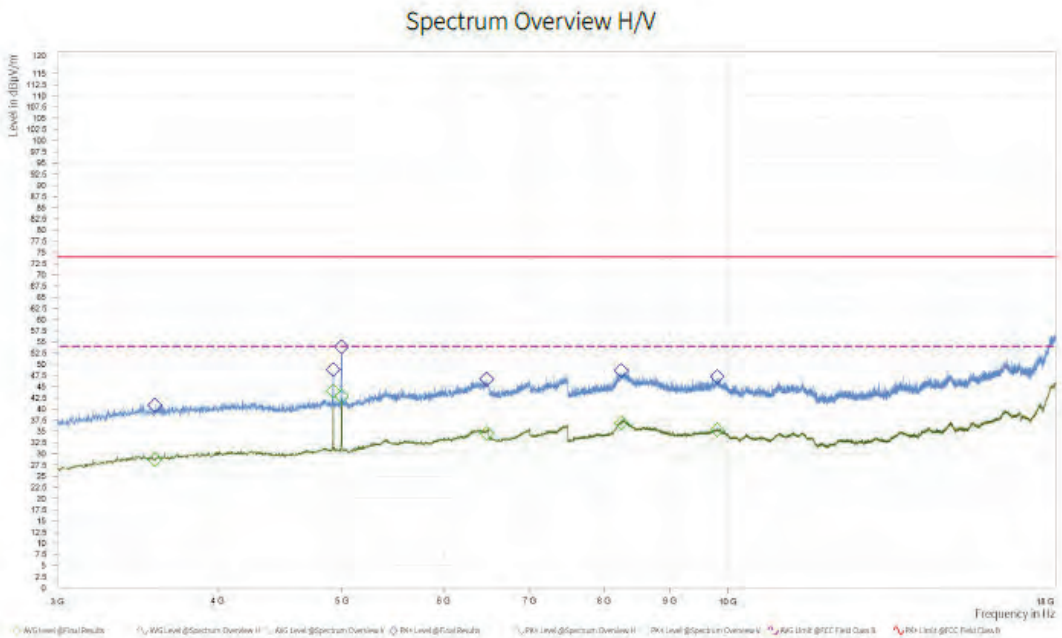

Radiates Emission from 3GHz to 18GHz

Frequency (MHz)	MaxPeak (dB μ V/m)	MaxPeak Limit (dB μ V/m)	MaxPeak Margin (dB)	Average (dB μ V/m)	Average Limit (dB μ V/m)	Average Margin (dB)	Meas. Time (s)	Pol	Azimuth (deg)	Height (m)	Corr. (dB/m)
1,107.750	50.31	74.00	23.69	38.77	54.00	15.23	1.000	H	316	1.00	-5.99
1,340.500	53.17	74.00	20.83	41.19	54.00	12.81	1.000	H	153.6	2.00	-3.57
1,722.750	56.13	74.00	17.87	44.07	54.00	9.93	1.000	H	99.8	1.00	-1.05
2,204.500	58.56	74.00	15.44	46.68	54.00	7.32	1.000	H	262.1	1.00	1.78
2,486.750	61.94	74.00	12.06	52.31	54.00	1.69	1.000	H	161.3	2.00	2.80
2,926.000	61.55	74.00	12.45	49.40	54.00	4.60	1.000	V	360	2.00	4.04

Remark: 1. Correction Factor = Antenna factor + Insertion loss (cable loss + amplifier gain)

2. Margin = Limit –MAX Peak/ Average

802.11g CH1

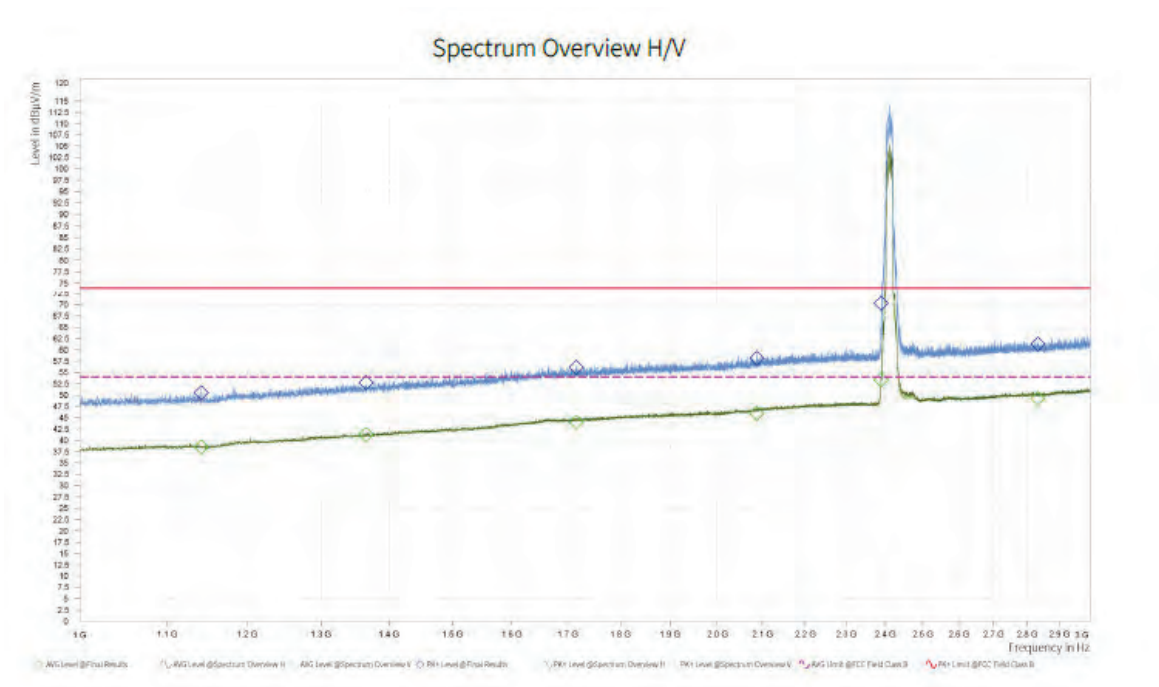

Note: The signal beyond the limit is carrier.
Radiates Emission from 1GHz to 3GHz

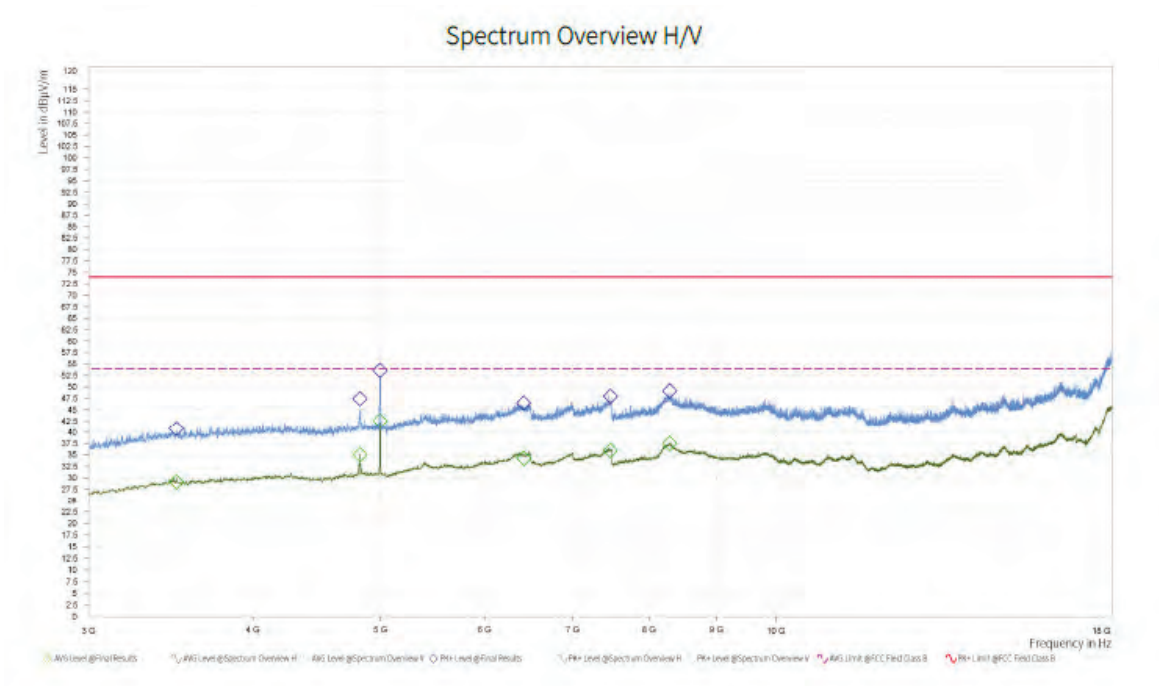

Radiates Emission from 3GHz to 18GHz

Frequency (MHz)	MaxPeak (dB μ V/m)	MaxPeak Limit (dB μ V/m)	MaxPeak Margin (dB)	Average (dB μ V/m)	Average Limit (dB μ V/m)	Average Margin (dB)	Meas. Time (s)	Pol	Azimuth (deg)	Height (m)	Corr. (dB/m)
1,141.250	50.57	74.00	23.43	38.53	54.00	15.47	1.000	H	169.1	1.00	-5.73
1,365.250	52.71	74.00	21.29	41.30	54.00	12.70	1.000	V	49.4	1.00	-3.44
1,716.000	56.09	74.00	17.91	44.03	54.00	9.97	1.000	H	357.2	1.00	-1.07
2,087.500	58.16	74.00	15.84	46.00	54.00	8.00	1.000	H	3.2	1.00	1.18
2,389.750	70.29	74.00	3.71	53.41	54.00	0.59	1.000	H	153.1	2.00	2.43
2,833.500	61.32	74.00	12.68	49.19	54.00	4.81	1.000	H	291.5	1.00	3.71

Remark: 1. Correction Factor = Antenna factor + Insertion loss (cable loss + amplifier gain)

2. Margin = Limit –MAX Peak/ Average

802.11g CH2

Spectrum Overview H/V

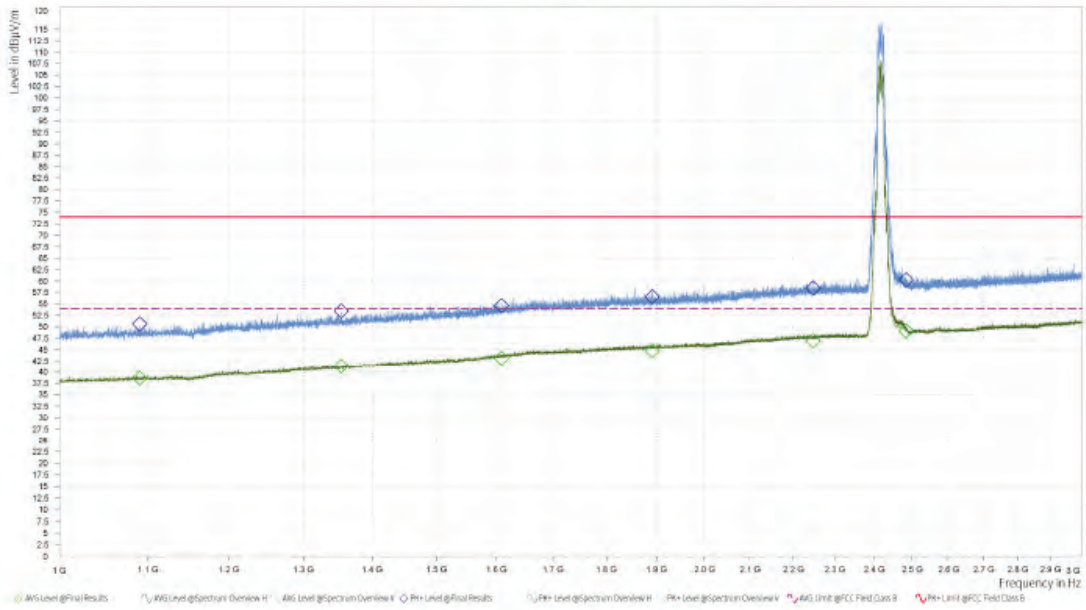

Note: The signal beyond the limit is carrier.
Radiates Emission from 1GHz to 3GHz

Spectrum Overview H/V

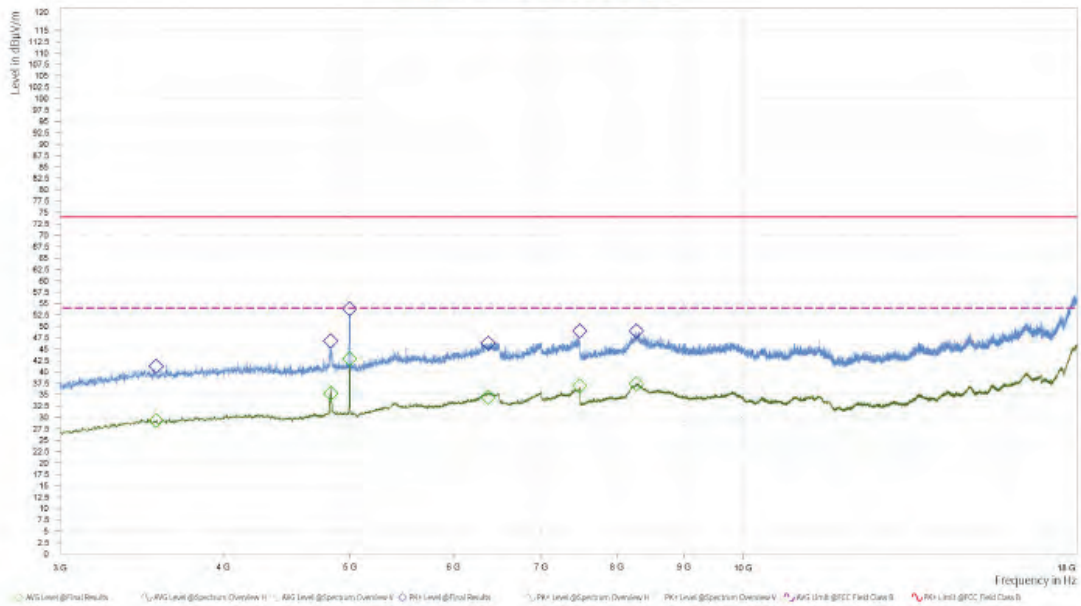

Radiates Emission from 3GHz to 18GHz

Frequency (MHz)	MaxPeak (dB μ V/m)	MaxPeak Limit (dB μ V/m)	MaxPeak Margin (dB)	Average (dB μ V/m)	Average Limit (dB μ V/m)	Average Margin (dB)	Meas. Time (s)	Pol	Azimuth (deg)	Height (m)	Corr. (dB/m)
1,090.000	50.62	74.00	23.38	38.61	54.00	15.39	1.000	H	5	1.00	-6.09
1,353.556	53.44	74.00	20.56	41.33	54.00	12.67	1.000	H	332.4	2.00	-3.54
1,608.222	54.62	74.00	19.38	43.10	54.00	10.90	1.000	V	356.8	1.00	-1.71
1,891.111	56.59	74.00	17.41	44.76	54.00	9.24	1.000	H	177.8	2.00	-0.11
2,248.222	58.44	74.00	15.56	46.92	54.00	7.08	1.000	H	251.1	2.00	1.89
2,484.444	60.24	74.00	13.76	49.05	54.00	4.95	1.000	V	179.2	1.00	2.81

Remark: 1. Correction Factor = Antenna factor + Insertion loss (cable loss + amplifier gain)

2. Margin = Limit -MAX Peak/ Average

802.11g CH3

Spectrum Overview H/V

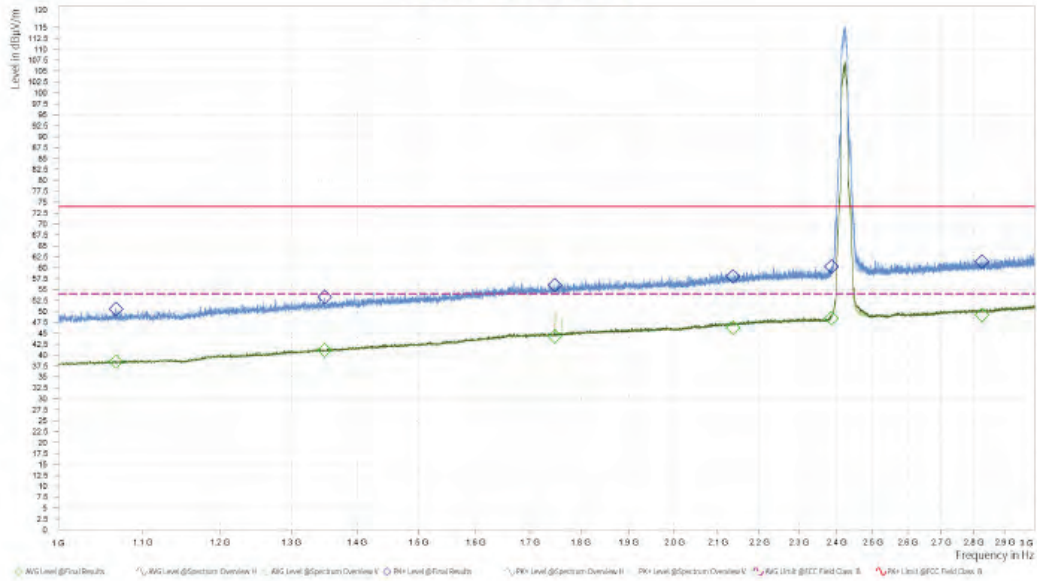

Note: The signal beyond the limit is carrier.
Radiates Emission from 1GHz to 3GHz

Spectrum Overview H/V

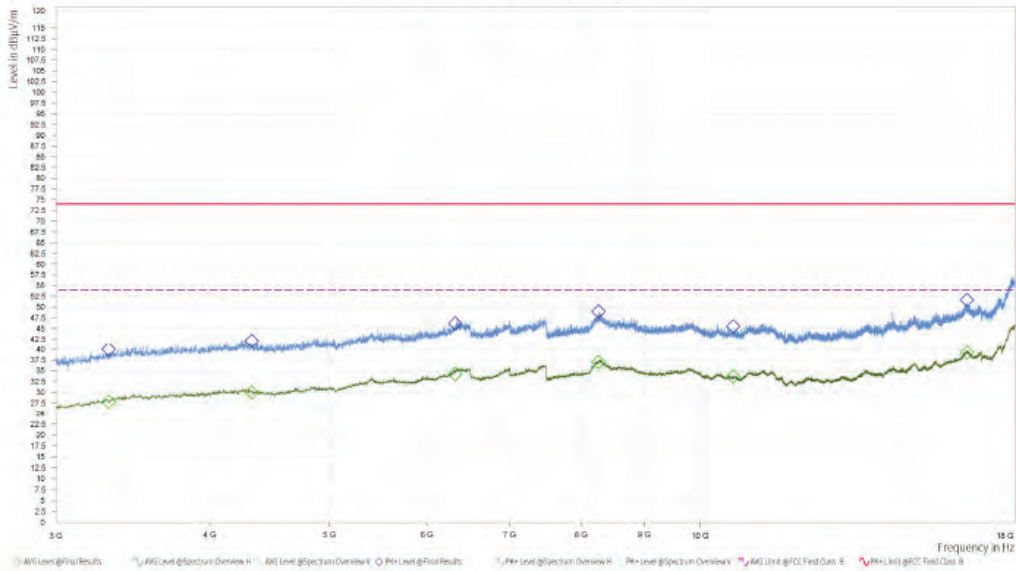

Radiates Emission from 3GHz to 18GHz

Frequency (MHz)	MaxPeak (dB μ V/m)	MaxPeak Limit (dB μ V/m)	MaxPeak Margin (dB)	Average (dB μ V/m)	Average Limit (dB μ V/m)	Average Margin (dB)	Meas. Time (s)	Pol	Azimuth (deg)	Height (m)	Corr. (dB/m)
1,067.000	50.57	74.00	23.43	38.49	54.00	15.51	1.000	H	360	2.00	-6.34
1,349.500	53.29	74.00	20.71	41.14	54.00	12.86	1.000	H	4.9	2.00	-3.57
1,748.500	56.05	74.00	17.95	44.29	54.00	9.71	1.000	V	210.6	1.00	-0.94
2,137.000	58.02	74.00	15.98	46.28	54.00	7.72	1.000	V	187.9	1.00	1.34
2,387.000	60.25	74.00	13.75	48.41	54.00	5.59	1.000	H	1.1	2.00	2.38
2,827.000	61.39	74.00	12.61	49.23	54.00	4.77	1.000	V	282.5	2.00	3.70

Remark: 1. Correction Factor = Antenna factor + Insertion loss (cable loss + amplifier gain)

2. Margin = Limit -MAX Peak/ Average

802.11g CH6

Spectrum Overview H/V

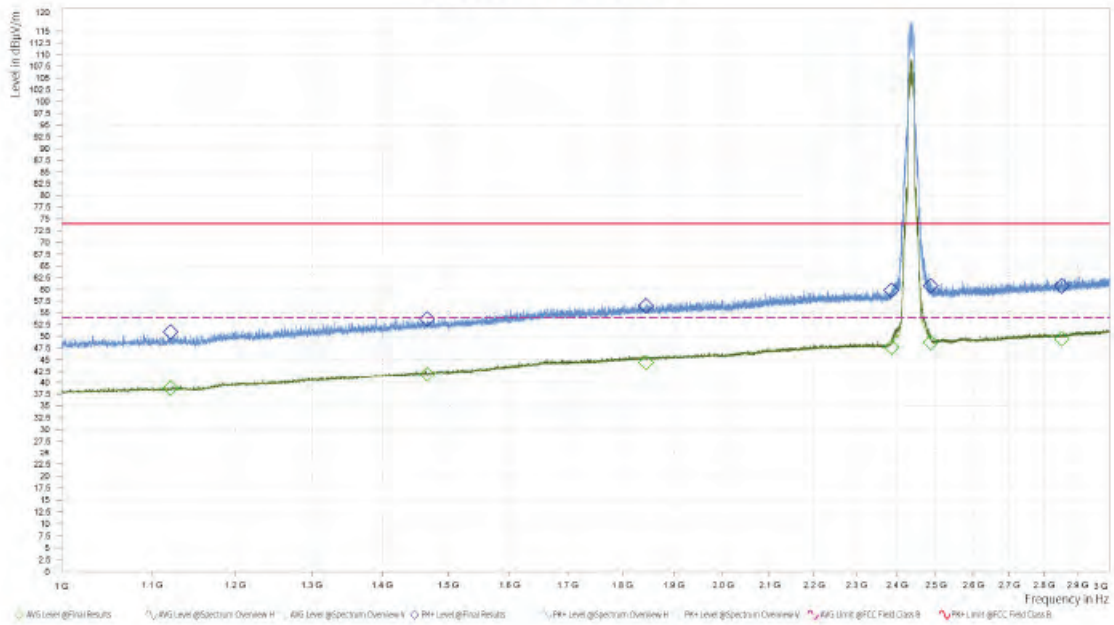

Note: The signal beyond the limit is carrier.
Radiates Emission from 1GHz to 3GHz

Spectrum Overview H/V

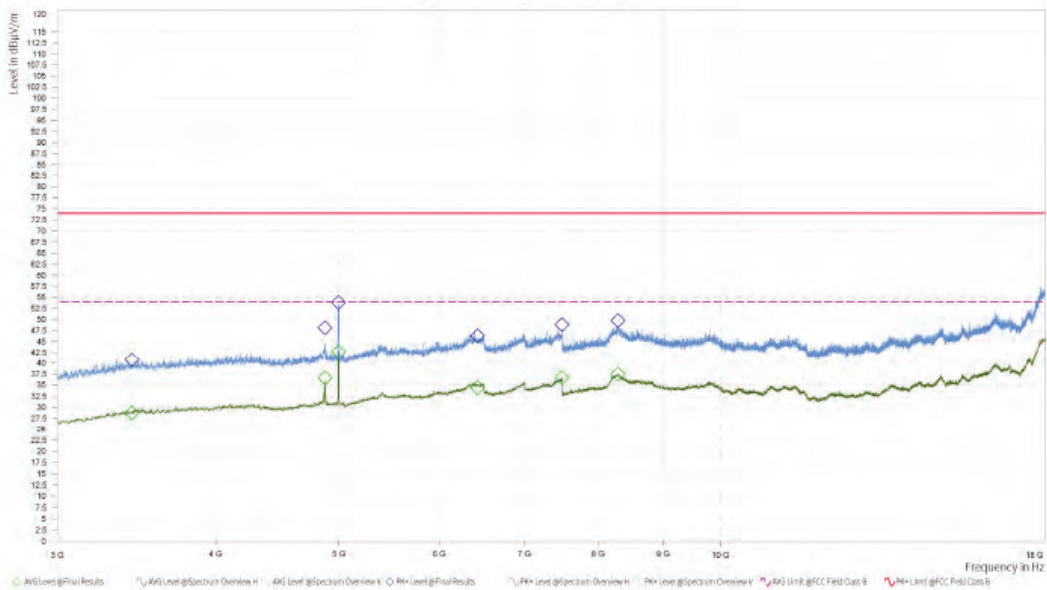

Radiates Emission from 3GHz to 18GHz

Frequency (MHz)	MaxPeak (dB μ V/m)	MaxPeak Limit (dB μ V/m)	MaxPeak Margin (dB)	Average (dB μ V/m)	Average Limit (dB μ V/m)	Average Margin (dB)	Meas. Time (s)	Pol	Azimuth (deg)	Height (m)	Corr. (dB/m)
1,121.250	50.97	74.00	23.03	38.78	54.00	15.22	1.000	V	3.7	1.00	-5.82
1,467.000	53.73	74.00	20.27	41.75	54.00	12.25	1.000	H	346.6	1.00	-2.71
1,845.250	56.54	74.00	17.46	44.48	54.00	9.52	1.000	V	194.3	1.00	-0.31
2,386.750	59.83	74.00	14.17	47.66	54.00	6.34	1.000	V	221.8	2.00	2.38
2,487.000	60.71	74.00	13.29	48.69	54.00	5.31	1.000	H	77.7	1.00	2.80
2,853.750	60.75	74.00	13.25	49.48	54.00	4.52	1.000	H	323.4	1.00	3.70

Remark: 1. Correction Factor = Antenna factor + Insertion loss (cable loss + amplifier gain)

2. Margin = Limit –MAX Peak/ Average

802.11g CH9

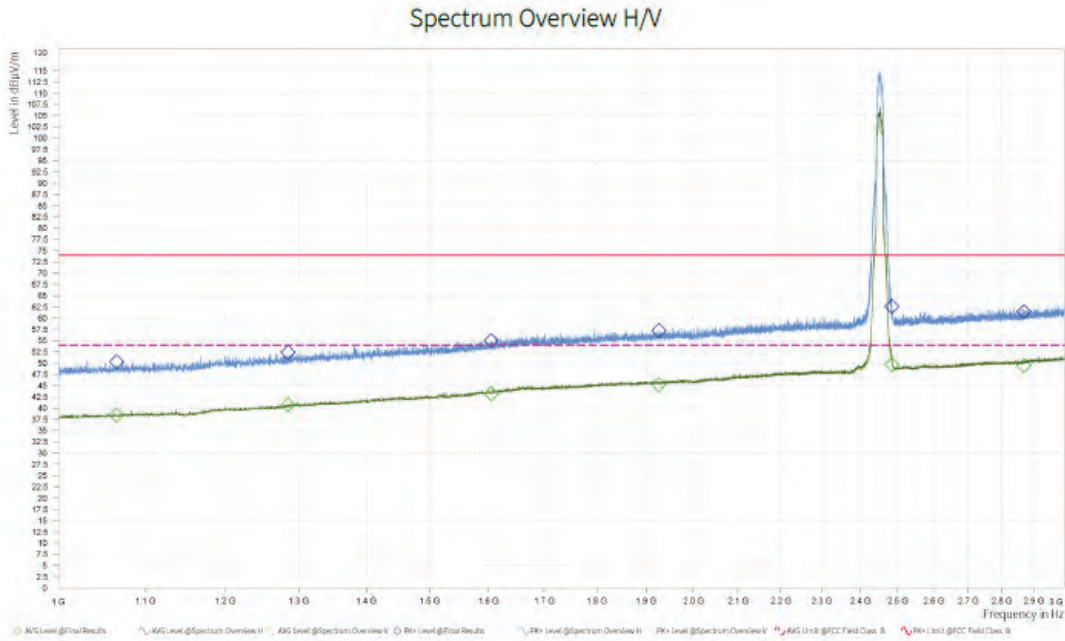

Note: The signal beyond the limit is carrier.
Radiates Emission from 1GHz to 3GHz

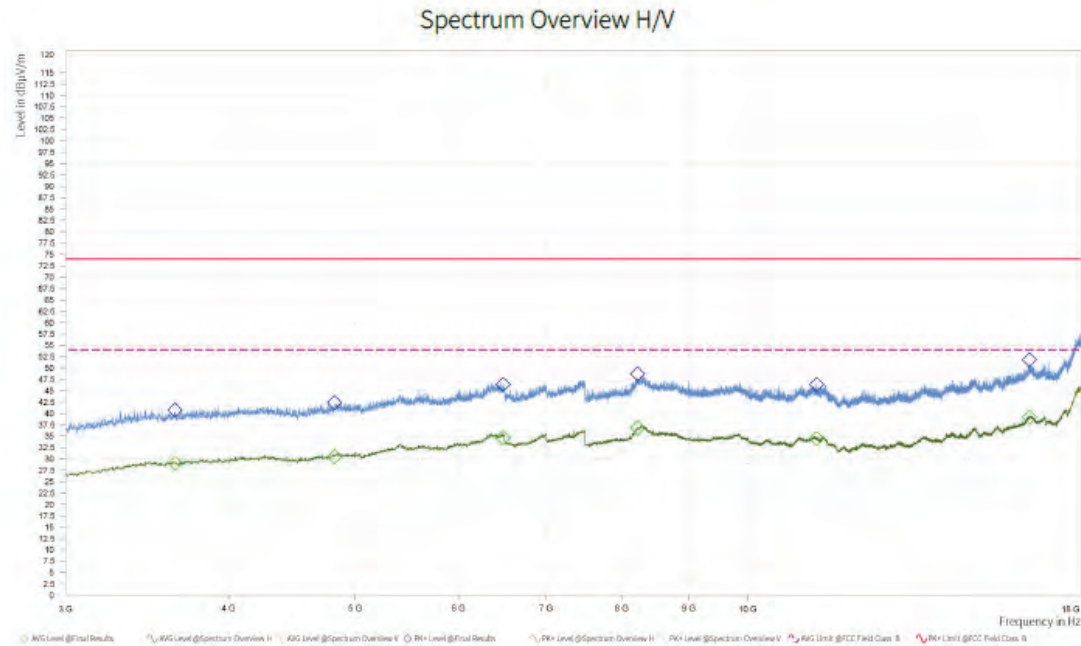

Radiates Emission from 3GHz to 18GHz

Frequency (MHz)	MaxPeak (dB μ V/m)	MaxPeak Limit (dB μ V/m)	MaxPeak Margin (dB)	Average (dB μ V/m)	Average Limit (dB μ V/m)	Average Margin (dB)	Meas. Time (s)	Pol	Azimuth (deg)	Height (m)	Corr. (dB/m)
1,065.750	50.34	74.00	23.66	38.43	54.00	15.57	1.000	H	306.6	2.00	-6.35
1,284.750	52.42	74.00	21.58	40.75	54.00	13.25	1.000	V	15.6	1.00	-4.03
1,604.000	55.01	74.00	18.99	43.22	54.00	10.78	1.000	H	336.3	1.00	-1.73
1,926.250	57.33	74.00	16.67	45.26	54.00	8.74	1.000	V	316.7	1.00	0.12
2,484.250	62.65	74.00	11.35	49.69	54.00	4.31	1.000	H	53.8	2.00	2.82
2,870.000	61.45	74.00	12.55	49.49	54.00	4.51	1.000	V	15.6	1.00	3.77

Remark: 1. Correction Factor = Antenna factor + Insertion loss (cable loss + amplifier gain)

2. Margin = Limit –MAX Peak/ Average

802.11g CH10

Spectrum Overview H/V

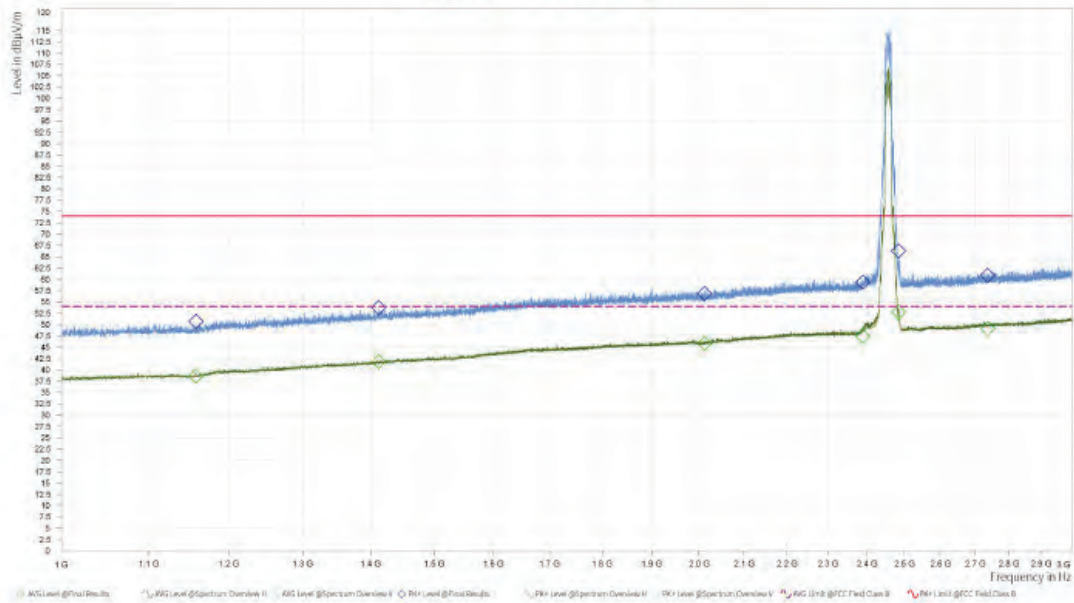

Note: The signal beyond the limit is carrier.
Radiates Emission from 1GHz to 3GHz

Spectrum Overview H/V

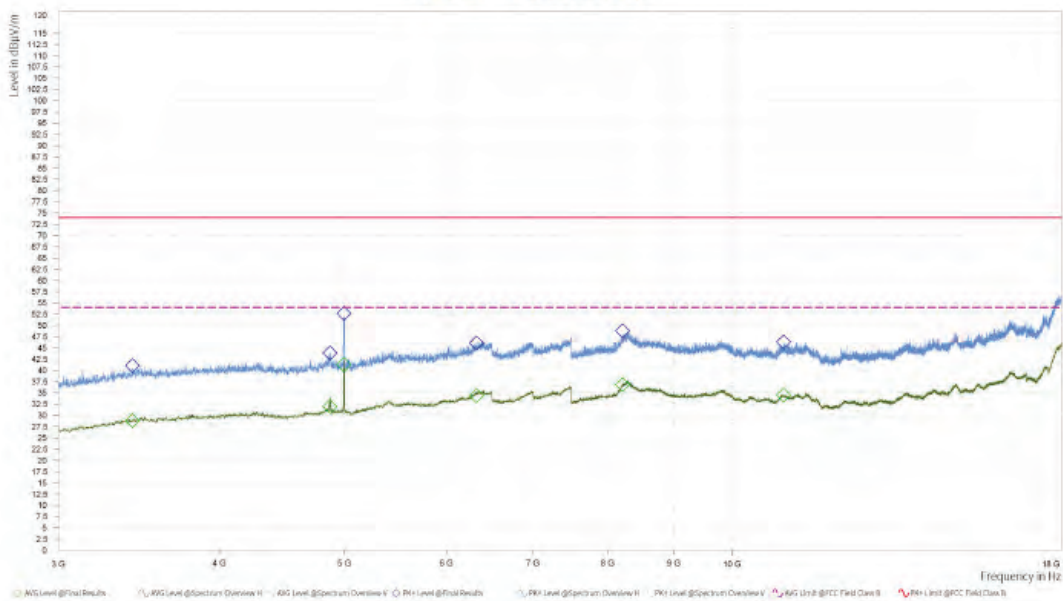

Radiates Emission from 3GHz to 18GHz

Frequency (MHz)	MaxPeak (dB μ V/m)	MaxPeak Limit (dB μ V/m)	MaxPeak Margin (dB)	Average (dB μ V/m)	Average Limit (dB μ V/m)	Average Margin (dB)	Meas. Time (s)	Pol	Azimuth (deg)	Height (m)	Corr. (dB/m)
1,157.333	50.72	74.00	23.28	38.64	54.00	15.36	1.000	V	8.7	1.00	-5.63
1,411.556	53.81	74.00	20.19	41.88	54.00	12.12	1.000	H	64.3	1.00	-3.00
2,011.778	56.94	74.00	17.06	45.83	54.00	8.17	1.000	H	324.6	2.00	0.55
2,389.778	59.34	74.00	14.66	47.47	54.00	6.53	1.000	H	308.4	2.00	2.43
2,484.889	66.28	74.00	7.72	52.77	54.00	1.23	1.000	H	138.2	2.00	2.81
2,737.778	60.93	74.00	13.07	49.12	54.00	4.88	1.000	H	162.3	2.00	3.45

Remark: 1. Correction Factor = Antenna factor + Insertion loss (cable loss + amplifier gain)

2. Margin = Limit –MAX Peak/ Average

802.11g CH11

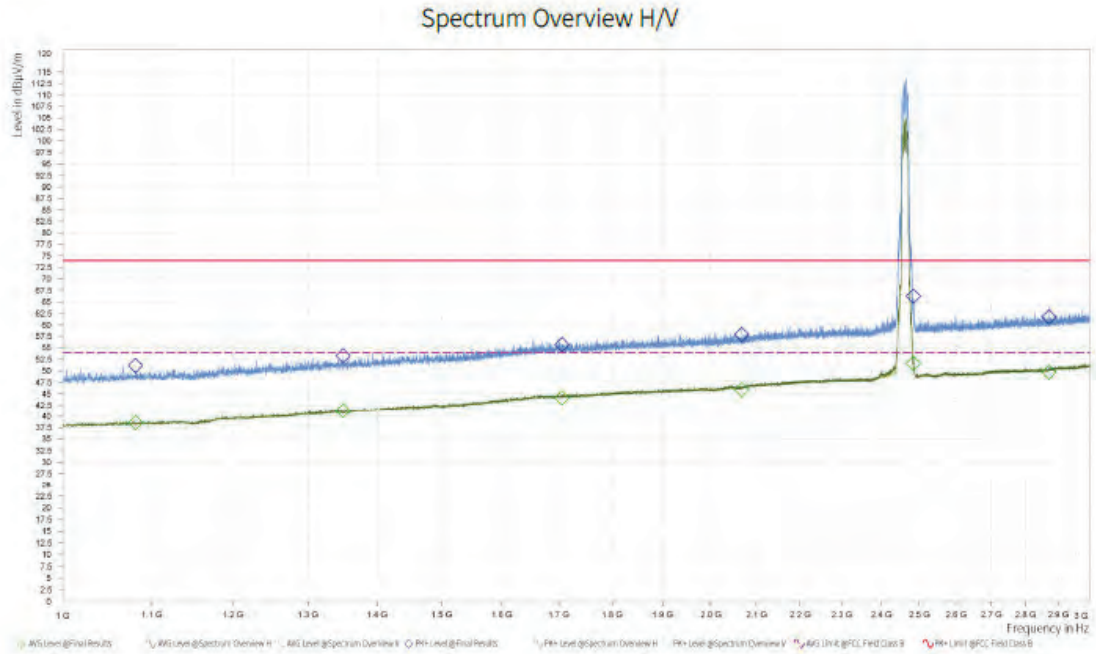

Note: The signal beyond the limit is carrier.
Radiates Emission from 1GHz to 3GHz

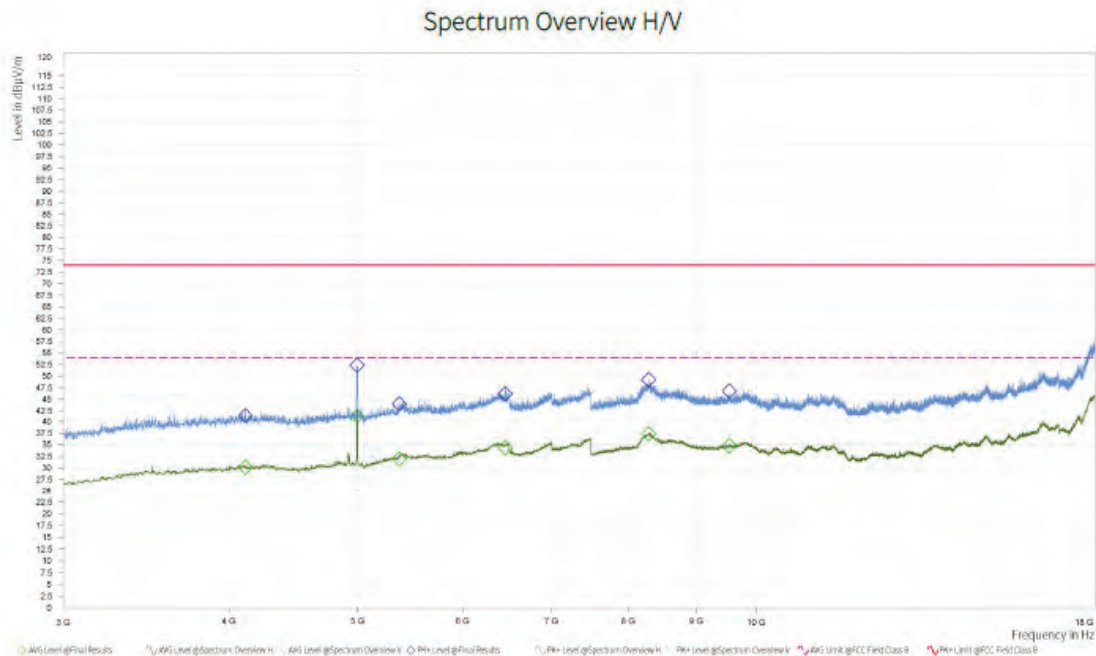

Radiates Emission from 3GHz to 18GHz

Frequency (MHz)	MaxPeak (dB μ V/m)	MaxPeak Limit (dB μ V/m)	MaxPeak Margin (dB)	Average (dB μ V/m)	Average Limit (dB μ V/m)	Average Margin (dB)	Meas. Time (s)	Pol	Azimuth (deg)	Height (m)	Corr. (dB/m)
1,081.000	51.18	74.00	22.82	38.53	54.00	15.47	1.000	H	0	2.00	-6.19
1,349.500	53.28	74.00	20.72	41.24	54.00	12.76	1.000	V	354.6	2.00	-3.57
1,706.250	55.74	74.00	18.26	44.11	54.00	9.89	1.000	H	77.9	1.00	-1.12
2,067.500	57.91	74.00	16.09	45.97	54.00	8.03	1.000	V	15.6	2.00	0.87
2,484.500	66.19	74.00	7.81	51.67	54.00	2.33	1.000	H	139.4	1.00	2.81
2,872.250	61.74	74.00	12.26	49.66	54.00	4.34	1.000	H	185.9	1.00	3.80

Remark: 1. Correction Factor = Antenna factor + Insertion loss (cable loss + amplifier gain)

2. Margin = Limit –MAX Peak/ Average

802.11n (HT20) CH1

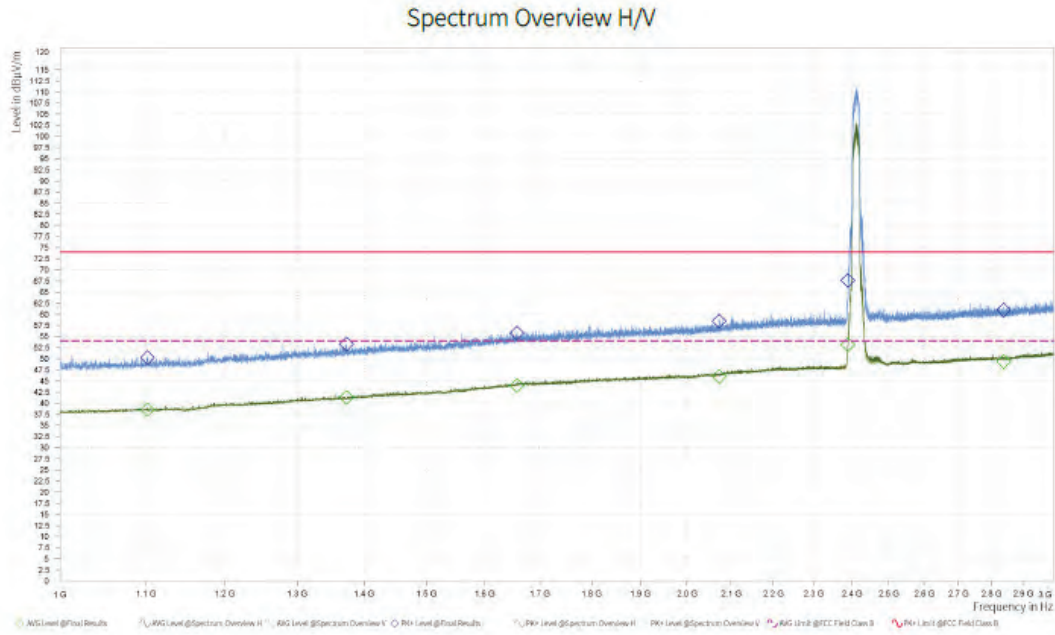

Note: The signal beyond the limit is carrier.
Radiates Emission from 1GHz to 3GHz

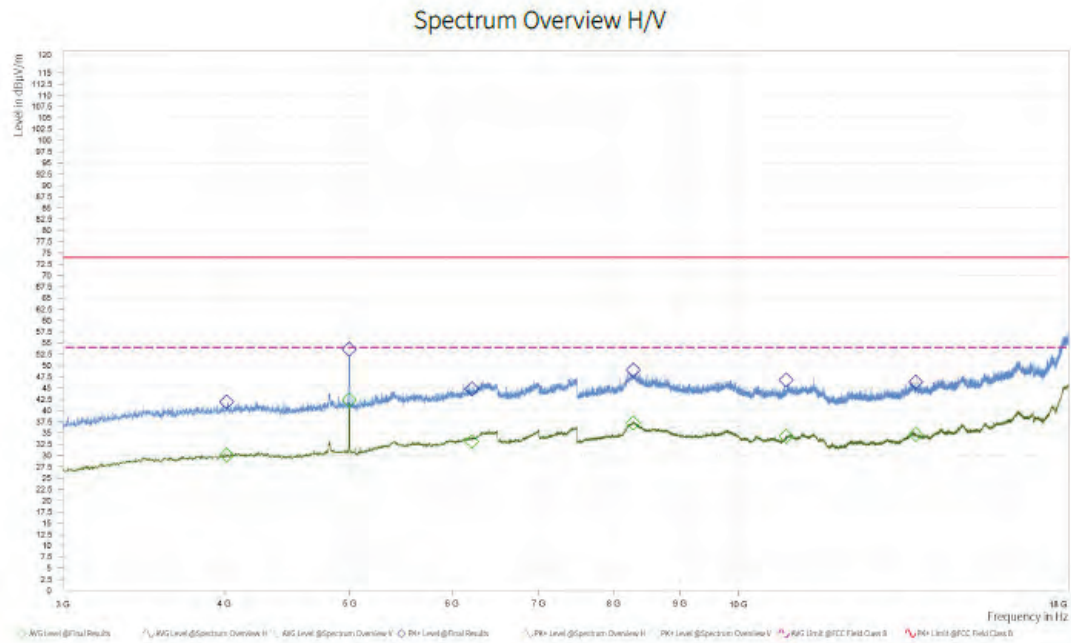

Radiates Emission from 3GHz to 18GHz

Frequency (MHz)	MaxPeak (dB μ V/m)	MaxPeak Limit (dB μ V/m)	MaxPeak Margin (dB)	Average (dB μ V/m)	Average Limit (dB μ V/m)	Average Margin (dB)	Meas. Time (s)	Pol	Azimuth (deg)	Height (m)	Corr. (dB/m)
1,101.500	50.21	74.00	23.79	38.57	54.00	15.43	1.000	H	216.5	1.00	-6.02
1,372.500	53.30	74.00	20.70	41.29	54.00	12.71	1.000	H	285.5	1.00	-3.38
1,657.250	55.84	74.00	18.16	43.96	54.00	10.04	1.000	V	176.6	2.00	-1.18
2,073.000	58.51	74.00	15.49	46.04	54.00	7.96	1.000	H	178.2	1.00	0.96
2,389.750	67.66	74.00	6.34	53.17	54.00	0.83	1.000	H	139.6	1.00	2.43
2,839.750	61.01	74.00	12.99	49.35	54.00	4.65	1.000	H	262.2	1.00	3.71

Remark: 1. Correction Factor = Antenna factor + Insertion loss (cable loss + amplifier gain)

2. Margin = Limit –MAX Peak/ Average

802.11n (HT20) CH2

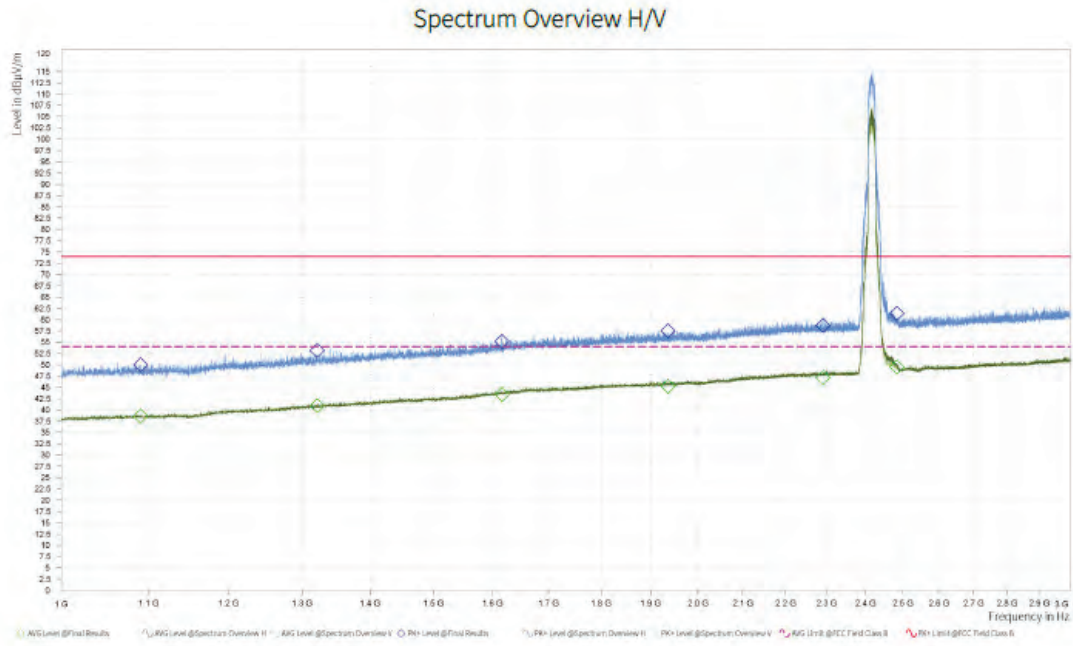

Note: The signal beyond the limit is carrier.
Radiates Emission from 1GHz to 3GHz

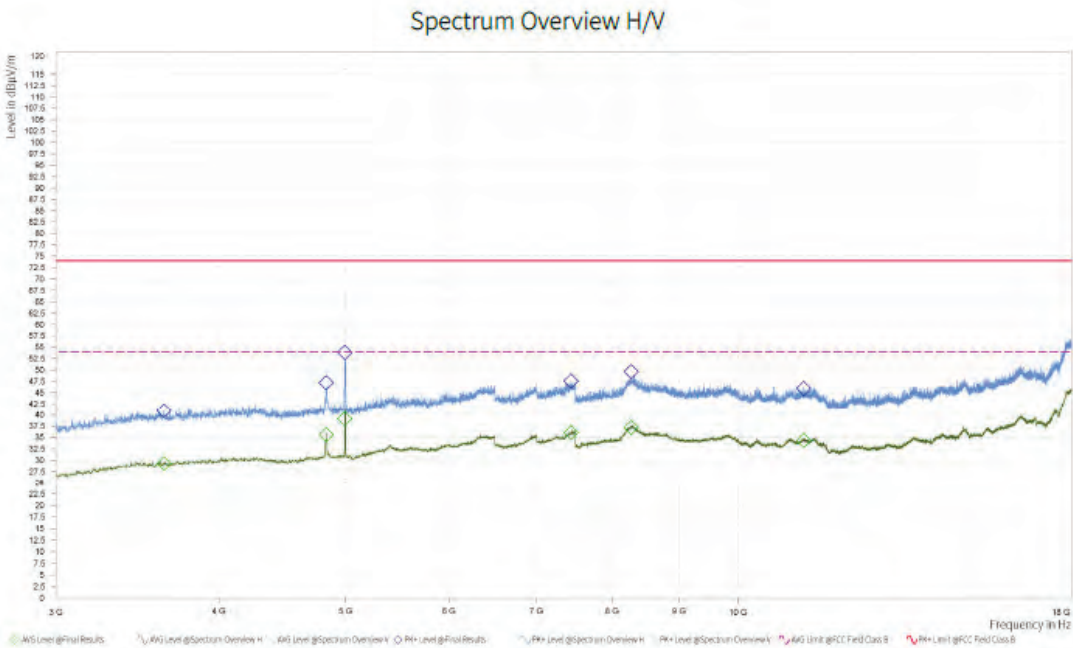

Radiates Emission from 3GHz to 18GHz

Frequency (MHz)	MaxPeak (dB μ V/m)	MaxPeak Limit (dB μ V/m)	MaxPeak Margin (dB)	Average (dB μ V/m)	Average Limit (dB μ V/m)	Average Margin (dB)	Meas. Time (s)	Pol	Azimuth (deg)	Height (m)	Corr. (dB/m)
1,090.000	49.98	74.00	24.02	38.64	54.00	15.36	1.000	H	298.3	2.00	-6.09
1,321.333	53.18	74.00	20.82	40.91	54.00	13.09	1.000	H	330.3	2.00	-3.75
1,615.556	55.15	74.00	18.85	43.39	54.00	10.61	1.000	H	338.5	2.00	-1.64
1,936.222	57.50	74.00	16.50	45.24	54.00	8.76	1.000	H	242.2	2.00	0.19
2,292.222	58.74	74.00	15.26	47.20	54.00	6.80	1.000	H	348.1	2.00	2.13
2,484.889	61.40	74.00	12.60	49.53	54.00	4.47	1.000	H	137.6	2.00	2.81

Remark: 1. Correction Factor = Antenna factor + Insertion loss (cable loss + amplifier gain)

2. Margin = Limit -MAX Peak/ Average

802.11n (HT20) CH3

Spectrum Overview H/V

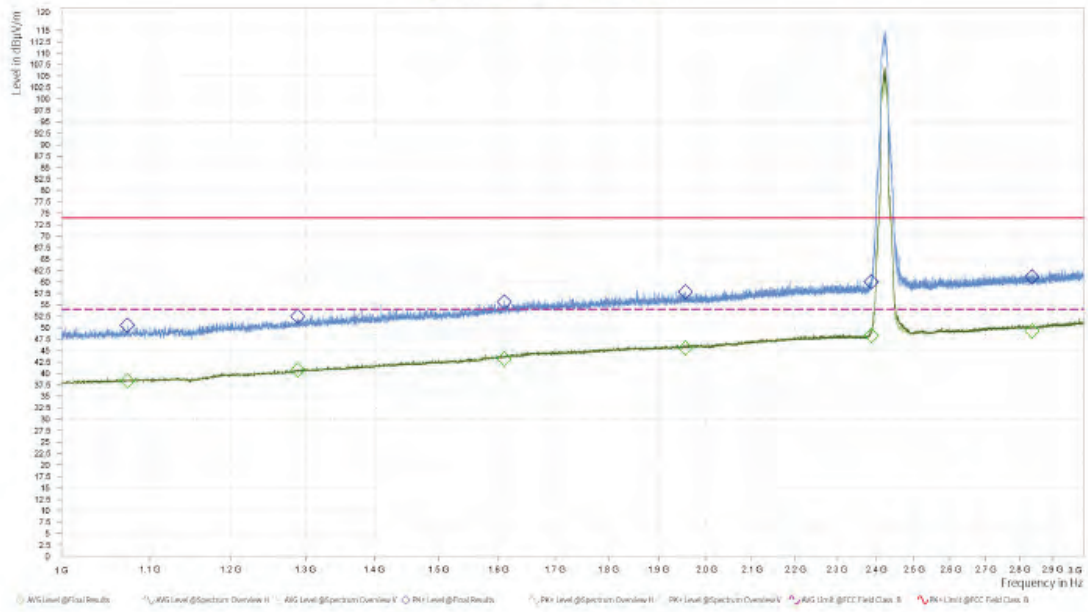

Note: The signal beyond the limit is carrier.
Radiates Emission from 1GHz to 3GHz

Spectrum Overview H/V

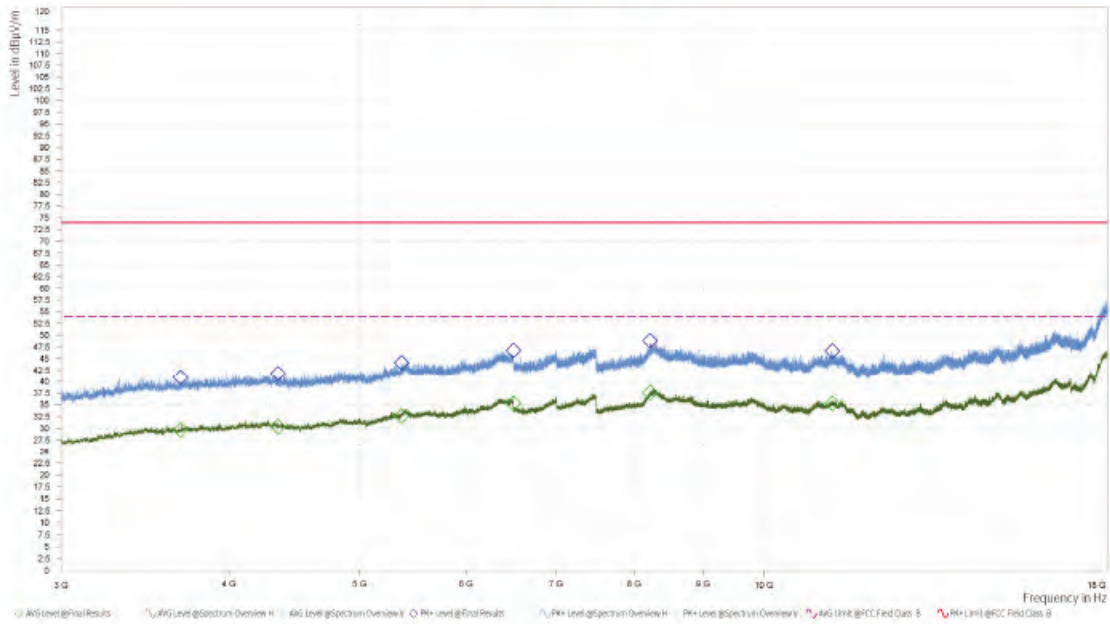

Radiates Emission from 3GHz to 18GHz

Frequency (MHz)	MaxPeak (dB μ V/m)	MaxPeak Limit (dB μ V/m)	MaxPeak Margin (dB)	Average (dB μ V/m)	Average Limit (dB μ V/m)	Average Margin (dB)	Meas. Time (s)	Pol	Azimuth (deg)	Height (m)	Corr. (dB/m)
1,073.500	50.56	74.00	23.44	38.42	54.00	15.58	1.000	H	287.5	2.00	-6.28
1,289.000	52.52	74.00	21.48	40.74	54.00	13.26	1.000	V	0.4	1.00	-3.96
1,609.500	55.64	74.00	18.36	43.17	54.00	10.83	1.000	H	240.9	1.00	-1.70
1,956.000	57.87	74.00	16.13	45.50	54.00	8.50	1.000	H	232.7	1.00	0.35
2,388.250	60.06	74.00	13.94	48.27	54.00	5.73	1.000	H	191.2	2.00	2.40
2,838.500	61.11	74.00	12.89	49.29	54.00	4.71	1.000	V	142.9	1.00	3.71

Remark: 1. Correction Factor = Antenna factor + Insertion loss (cable loss + amplifier gain)

2. Margin = Limit –MAX Peak/ Average

802.11n (HT20) CH6

Spectrum Overview H/V

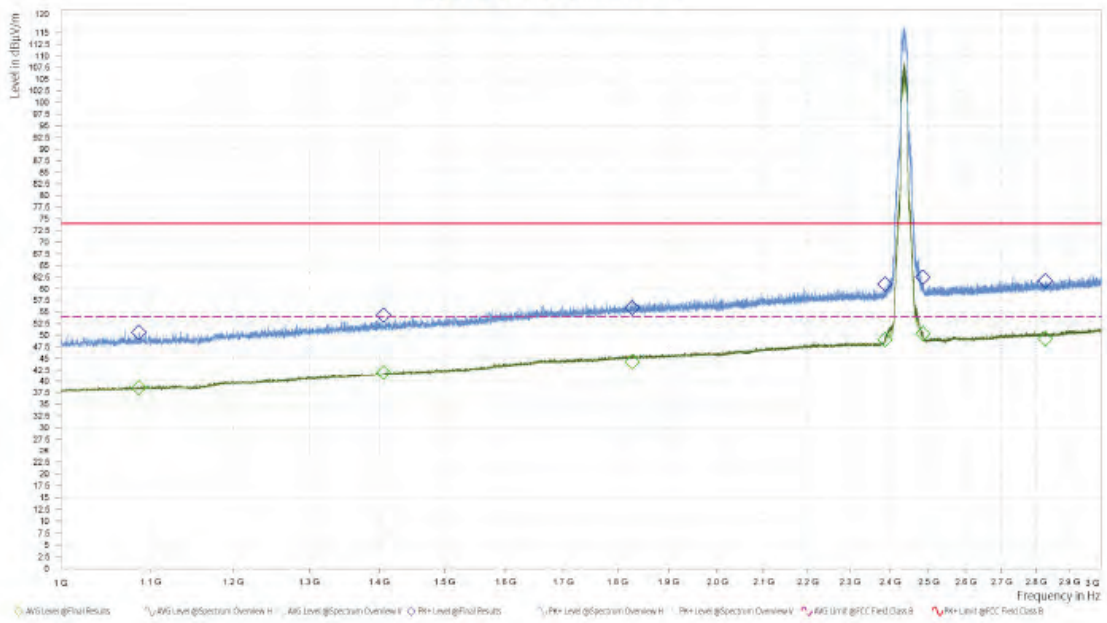

Note: The signal beyond the limit is carrier.
Radiates Emission from 1GHz to 3GHz

Spectrum Overview H/V

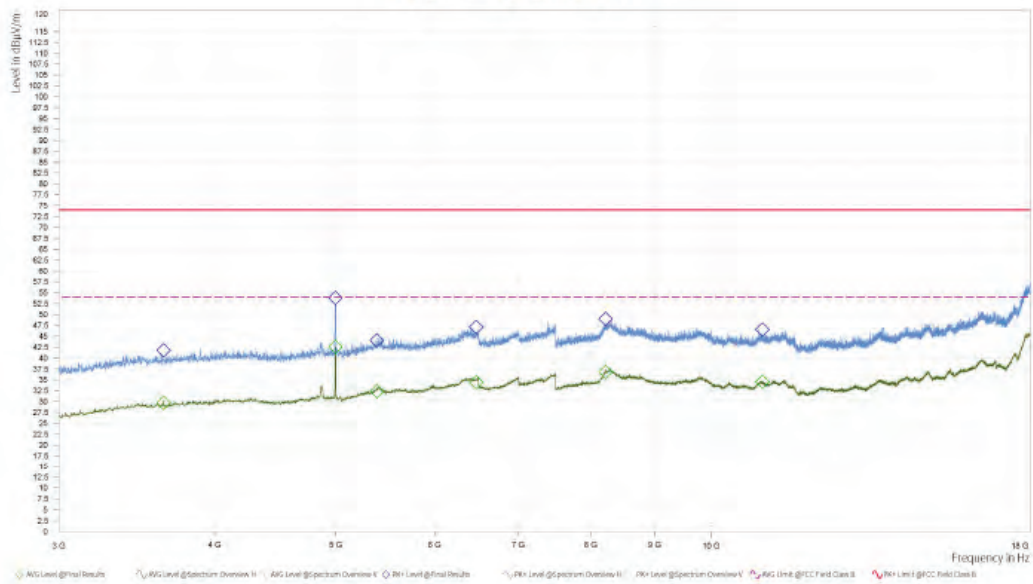

Radiates Emission from 3GHz to 18GHz

Frequency (MHz)	MaxPeak (dB μ V/m)	MaxPeak Limit (dB μ V/m)	MaxPeak Margin (dB)	Average (dB μ V/m)	Average Limit (dB μ V/m)	Average Margin (dB)	Meas. Time (s)	Pol	Azimuth (deg)	Height (m)	Corr. (dB/m)
1,086.000	50.65	74.00	23.35	38.51	54.00	15.49	1.000	H	194.2	1.00	-6.13
1,406.500	54.33	74.00	19.67	41.83	54.00	12.17	1.000	V	248.1	2.00	-3.08
1,828.000	55.91	74.00	18.09	44.27	54.00	9.73	1.000	H	85	1.00	-0.40
2,387.500	61.01	74.00	12.99	49.05	54.00	4.95	1.000	H	141.2	2.00	2.39
2,485.000	62.48	74.00	11.52	50.30	54.00	3.70	1.000	H	148.2	1.00	2.81
2,828.250	61.67	74.00	12.33	49.24	54.00	4.76	1.000	H	347.8	1.00	3.70

Remark: 1. Correction Factor = Antenna factor + Insertion loss (cable loss + amplifier gain)

2. Margin = Limit –MAX Peak/ Average

802.11n (HT20) CH9

Spectrum Overview H/V

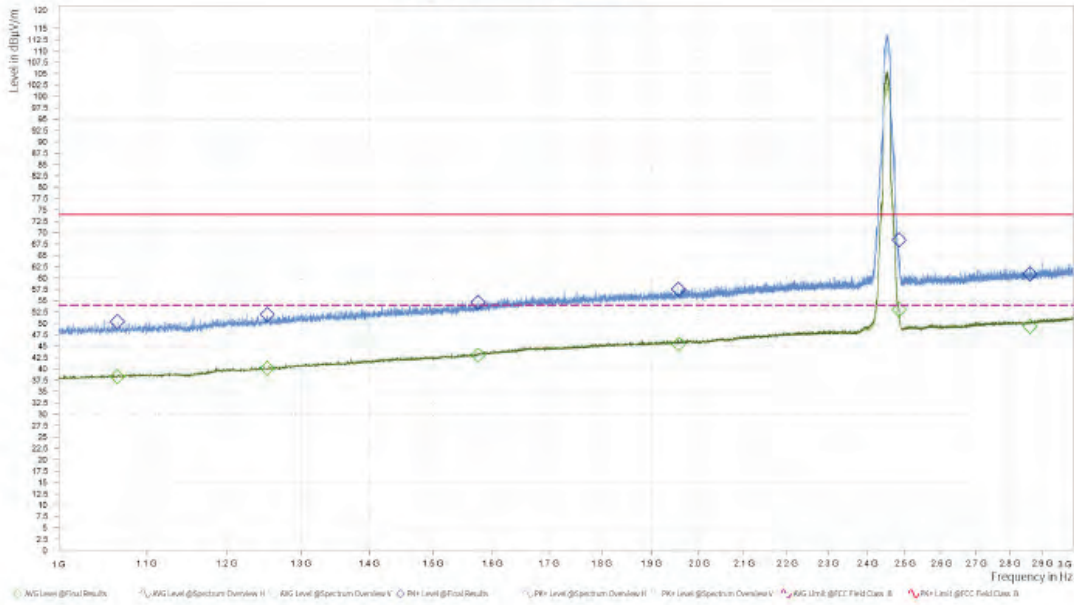

Note: The signal beyond the limit is carrier.
Radiates Emission from 1GHz to 3GHz

Spectrum Overview H/V

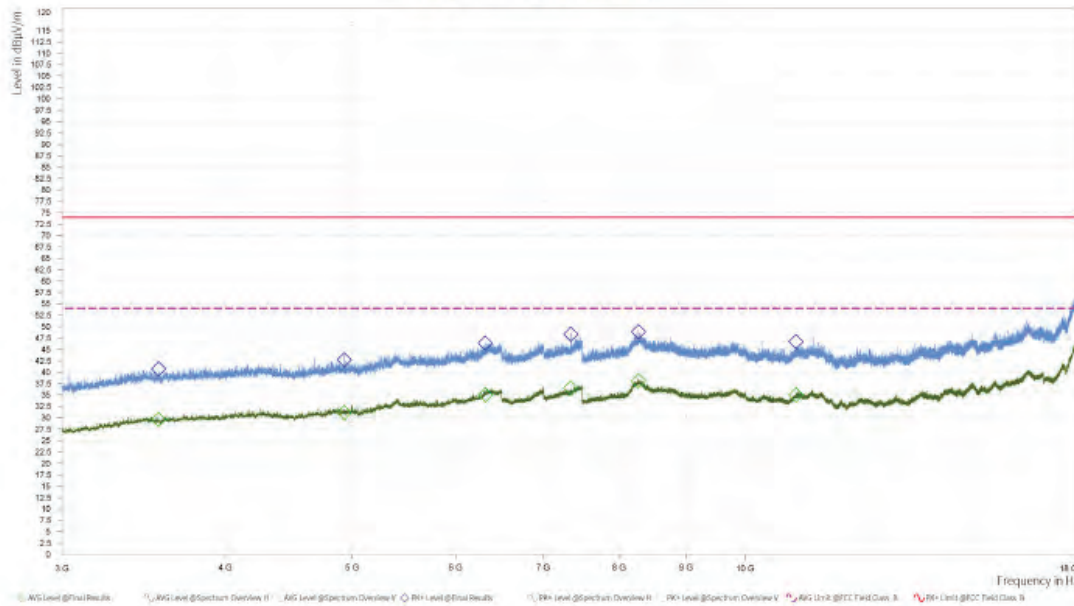

Radiates Emission from 3GHz to 18GHz

Frequency (MHz)	MaxPeak (dB μ V/m)	MaxPeak Limit (dB μ V/m)	MaxPeak Margin (dB)	Average (dB μ V/m)	Average Limit (dB μ V/m)	Average Margin (dB)	Meas. Time (s)	Pol	Azimuth (deg)	Height (m)	Corr. (dB/m)
1,065.750	50.38	74.00	23.62	38.32	54.00	15.68	1.000	V	2.7	1.00	-6.35
1,253.250	52.00	74.00	22.00	40.11	54.00	13.89	1.000	H	308.9	1.00	-4.35
1,574.750	54.61	74.00	19.39	43.00	54.00	11.00	1.000	V	153.9	1.00	-1.93
1,956.750	57.53	74.00	16.47	45.46	54.00	8.54	1.000	V	29	2.00	0.36
2,484.000	68.42	74.00	5.58	53.07	54.00	0.93	1.000	H	30.9	2.00	2.82
2,862.250	60.91	74.00	13.09	49.36	54.00	4.64	1.000	H	192.2	2.00	3.72

Remark: 1. Correction Factor = Antenna factor + Insertion loss (cable loss + amplifier gain)

2. Margin = Limit -MAX Peak/ Average

802.11n (HT20) CH10

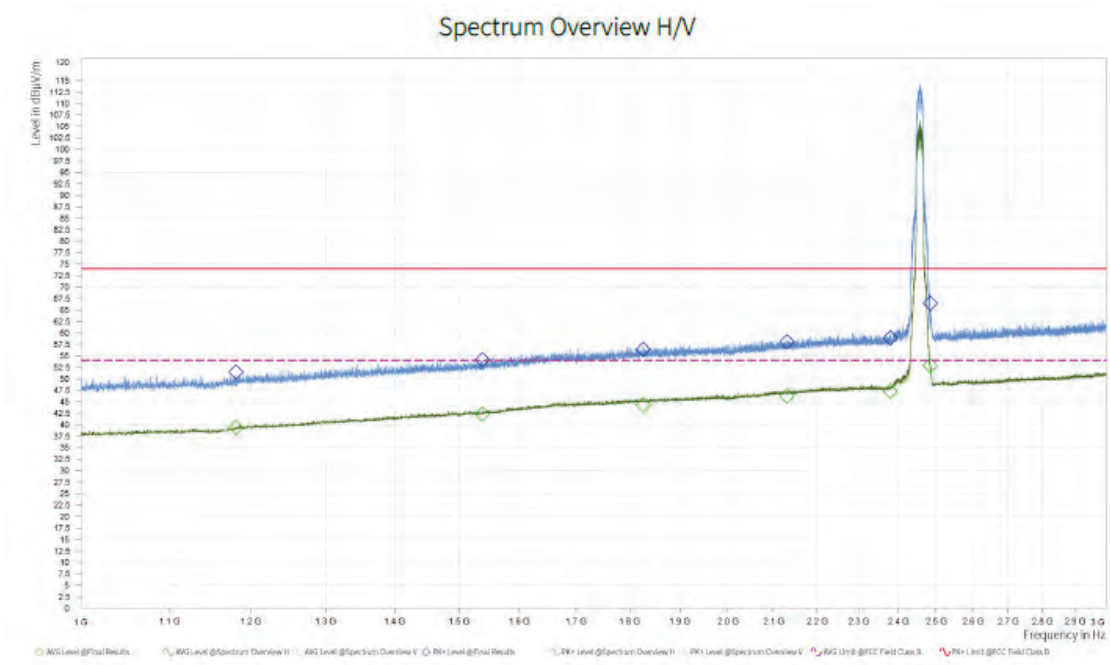

Note: The signal beyond the limit is carrier.
Radiates Emission from 1GHz to 3GHz

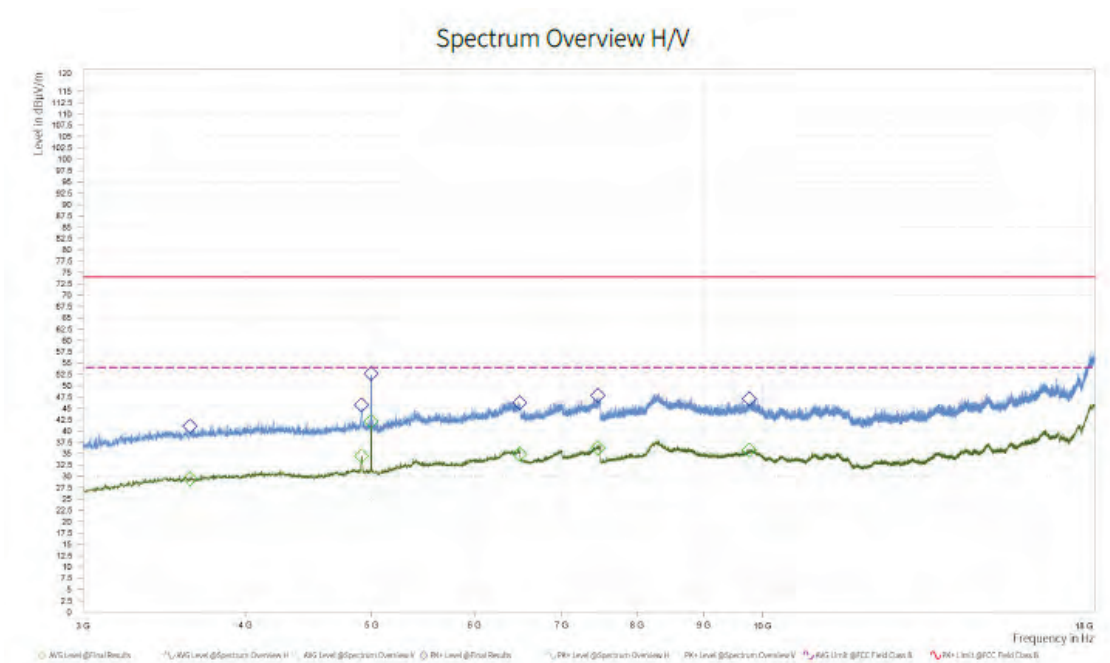

Radiates Emission from 3GHz to 18GHz

Frequency (MHz)	MaxPeak (dB μ V/m)	MaxPeak Limit (dB μ V/m)	MaxPeak Margin (dB)	Average (dB μ V/m)	Average Limit (dB μ V/m)	Average Margin (dB)	Meas. Time (s)	Pol	Azimuth (deg)	Height (m)	Corr. (dB/m)
1,180.750	51.46	74.00	22.54	39.42	54.00	14.58	1.000	H	210	2.00	-4.86
1,537.750	54.16	74.00	19.84	42.33	54.00	11.67	1.000	V	0	2.00	-2.34
1,827.000	56.41	74.00	17.59	44.25	54.00	9.75	1.000	H	239	2.00	-0.40
2,131.250	58.09	74.00	15.91	46.25	54.00	7.75	1.000	V	262.8	1.00	1.34
2,380.250	58.93	74.00	15.07	47.23	54.00	6.77	1.000	H	199.6	2.00	2.26
2,484.750	66.48	74.00	7.52	52.89	54.00	1.11	1.000	H	145	2.00	2.81

Remark: 1. Correction Factor = Antenna factor + Insertion loss (cable loss + amplifier gain)

2. Margin = Limit –MAX Peak/ Average

Spectrum Overview H/V

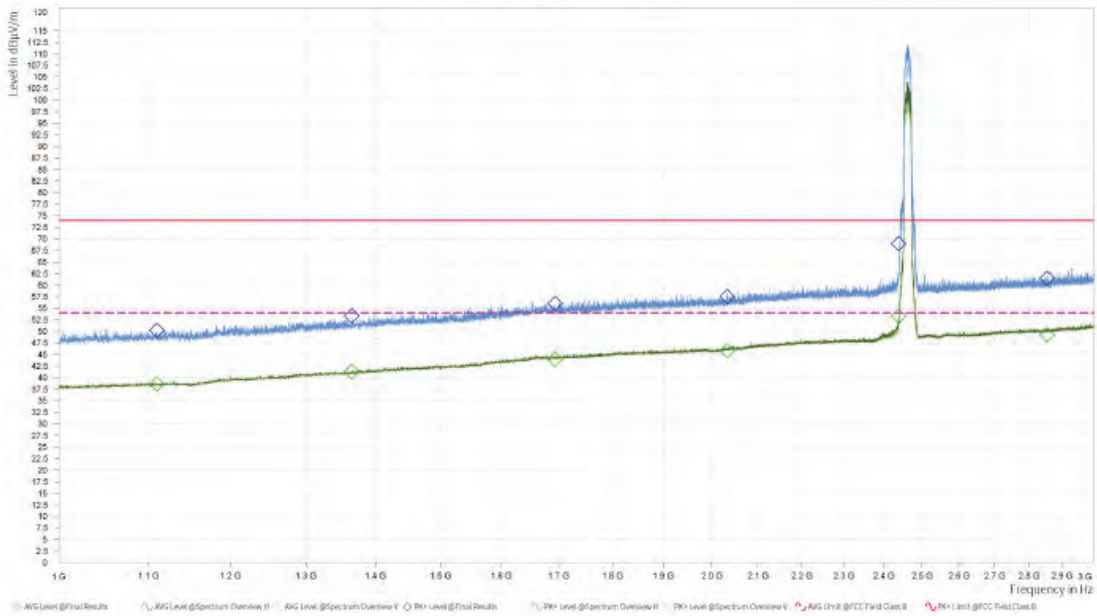

Note: The signal beyond the limit is carrier.
Radiates Emission from 1GHz to 3GHz

Spectrum Overview H/V

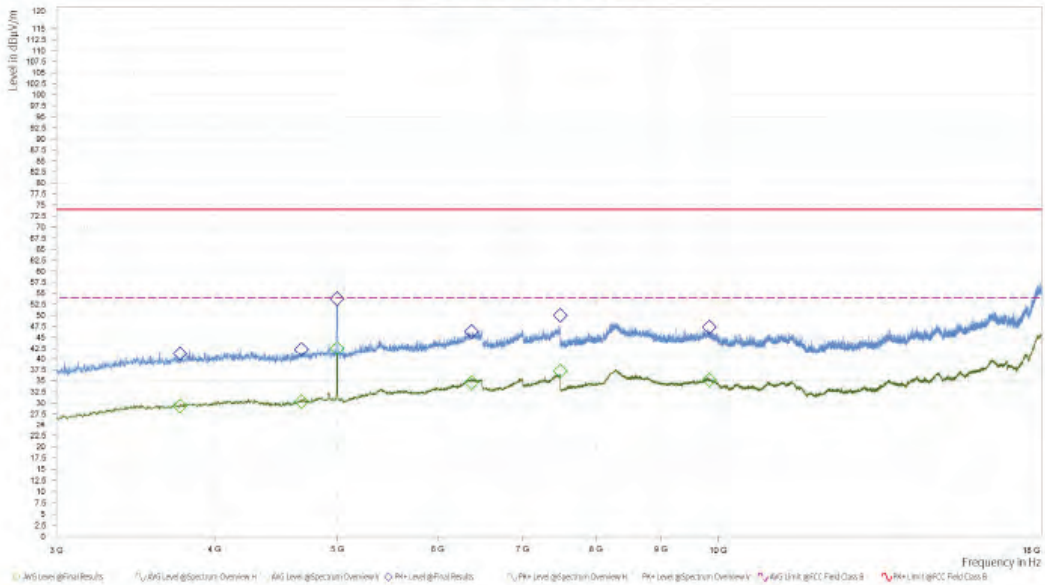

Radiates Emission from 3GHz to 18GHz

Frequency (MHz)	MaxPeak (dB μ V/m)	MaxPeak Limit (dB μ V/m)	MaxPeak Margin (dB)	Average (dB μ V/m)	Average Limit (dB μ V/m)	Average Margin (dB)	Meas. Time (s)	Pol	Azimuth (deg)	Height (m)	Corr. (dB/m)
1,109.500	50.22	74.00	23.78	38.62	54.00	15.38	1.000	V	141.2	2.00	-5.98
1,364.750	53.41	74.00	20.59	41.33	54.00	12.67	1.000	H	320.3	1.00	-3.45
1,693.250	56.04	74.00	17.96	43.97	54.00	10.03	1.000	H	242.9	1.00	-1.20
2,032.750	57.51	74.00	16.49	45.85	54.00	8.15	1.000	H	86.9	2.00	0.83
2,438.750	68.95	74.00	5.05	53.33	54.00	0.67	1.000	H	149.4	2.00	2.55
2,856.250	61.56	74.00	12.44	49.31	54.00	4.69	1.000	H	79.3	1.00	3.70

Remark: 1. Correction Factor = Antenna factor + Insertion loss (cable loss + amplifier gain)

2. Margin = Limit –MAX Peak/ Average

802.11n (HT40) CH3

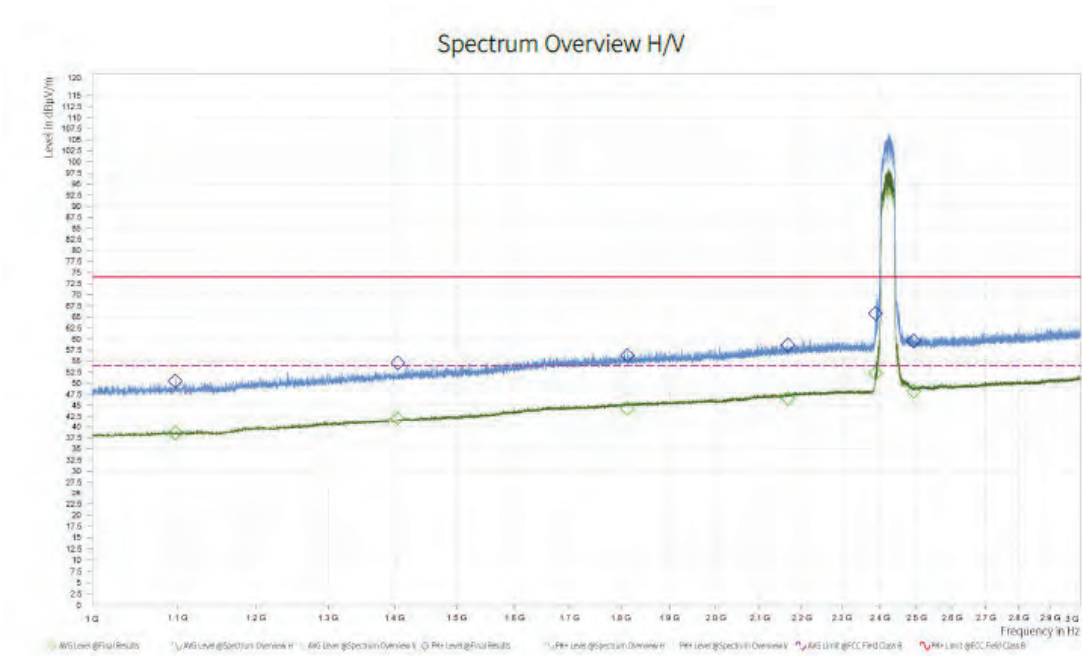

Note: The signal beyond the limit is carrier.
Radiates Emission from 1GHz to 3GHz

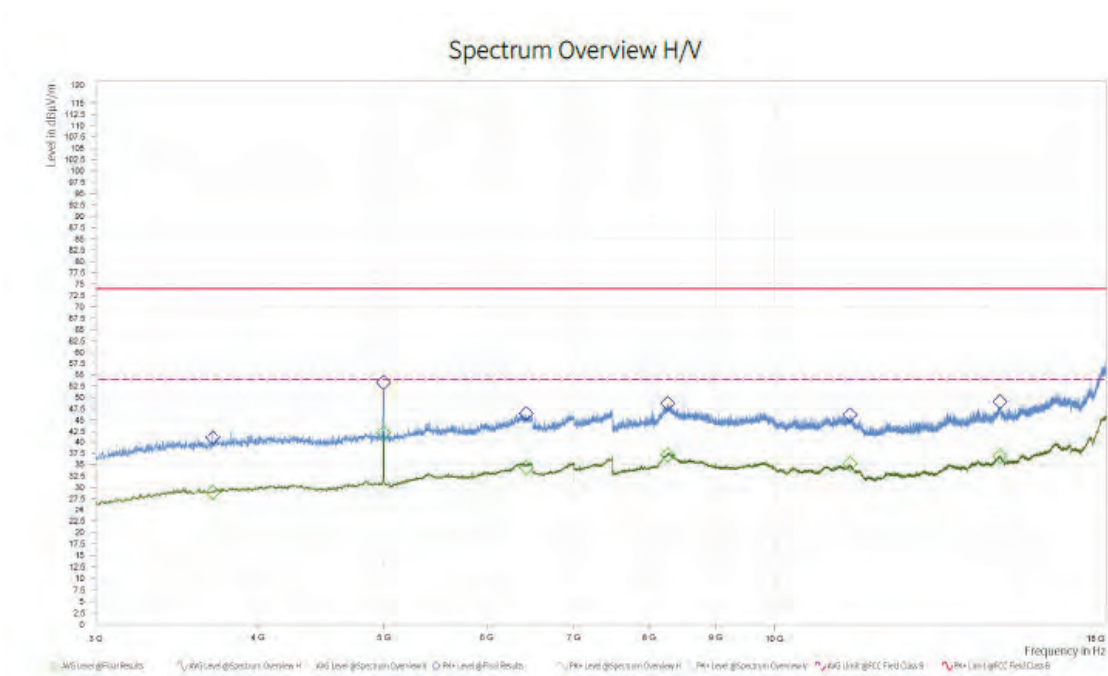

Radiates Emission from 3GHz to 18GHz

Frequency (MHz)	MaxPeak (dB μ V/m)	MaxPeak Limit (dB μ V/m)	MaxPeak Margin (dB)	Average (dB μ V/m)	Average Limit (dB μ V/m)	Average Margin (dB)	Meas. Time (s)	Pol	Azimuth (deg)	Height (m)	Corr. (dB/m)
1,096.889	50.49	74.00	23.51	38.53	54.00	15.47	1.000	H	248.4	2.00	-6.03
1,404.444	54.60	74.00	19.40	41.90	54.00	12.10	1.000	V	230.4	1.00	-3.11
1,812.667	56.28	74.00	17.72	44.36	54.00	9.64	1.000	H	198.6	2.00	-0.44
2,166.889	58.62	74.00	15.38	46.57	54.00	7.43	1.000	V	65.8	1.00	1.50
2,388.444	65.73	74.00	8.27	52.29	54.00	1.71	1.000	H	139.8	2.00	2.41
2,491.778	59.53	74.00	14.47	48.18	54.00	5.82	1.000	V	5.2	2.00	2.77

Remark: 1. Correction Factor = Antenna factor + Insertion loss (cable loss + amplifier gain)

2. Margin = Limit -MAX Peak/ Average

802.11n (HT40) CH4

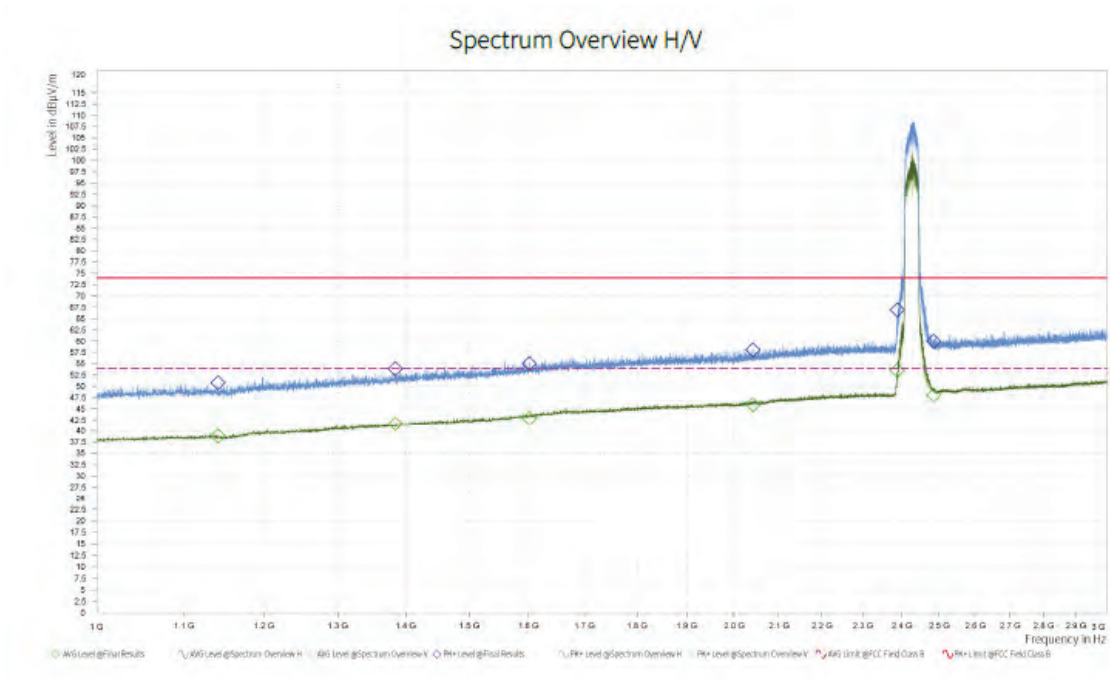

Note: The signal beyond the limit is carrier.
Radiates Emission from 1GHz to 3GHz

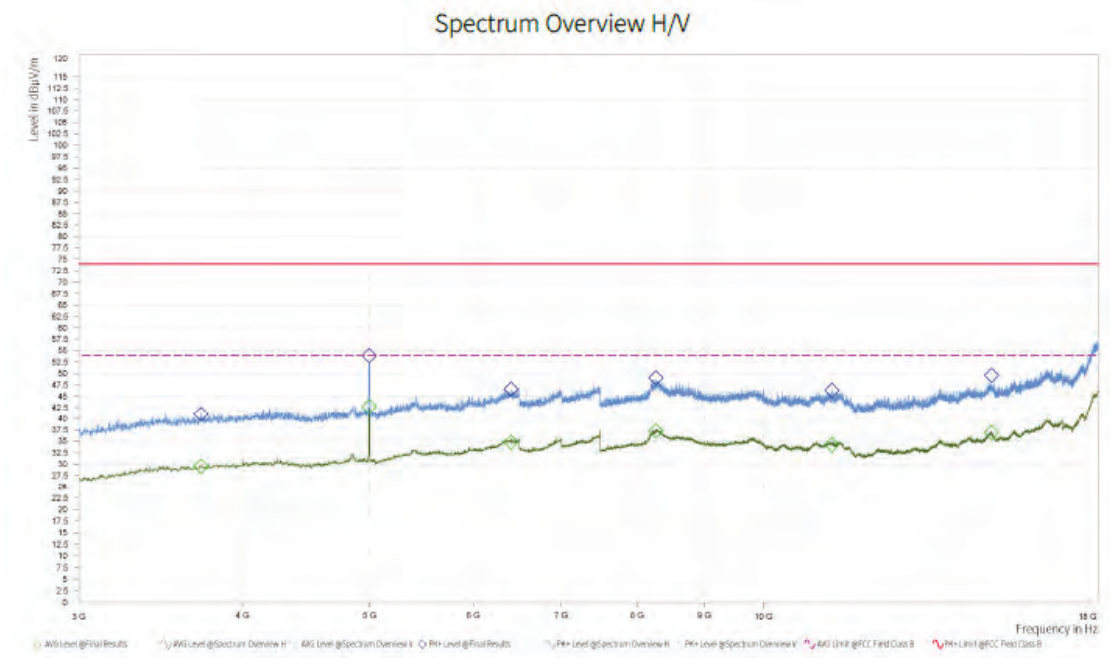

Radiates Emission from 3GHz to 18GHz

Frequency (MHz)	MaxPeak (dB μ V/m)	MaxPeak Limit (dB μ V/m)	MaxPeak Margin (dB)	Average (dB μ V/m)	Average Limit (dB μ V/m)	Average Margin (dB)	Meas. Time (s)	Pol	Azimuth (deg)	Height (m)	Corr. (dB/m)
1,141.000	50.77	74.00	23.23	38.76	54.00	15.24	1.000	H	26.4	1.00	-5.72
1,383.500	53.95	74.00	20.05	41.61	54.00	12.39	1.000	H	177.1	2.00	-3.26
1,601.000	55.01	74.00	18.99	42.89	54.00	11.11	1.000	H	208.5	2.00	-1.75
2,041.750	58.04	74.00	15.96	45.96	54.00	8.04	1.000	V	118.4	2.00	0.95
2,388.500	66.92	74.00	7.08	53.54	54.00	0.46	1.000	H	145	2.00	2.41
2,485.000	59.98	74.00	14.02	48.04	54.00	5.96	1.000	H	114.5	1.00	2.81

Remark: 1. Correction Factor = Antenna factor + Insertion loss (cable loss + amplifier gain)

2. Margin = Limit –MAX Peak/ Average

802.11n (HT40) CH5

Spectrum Overview H/V

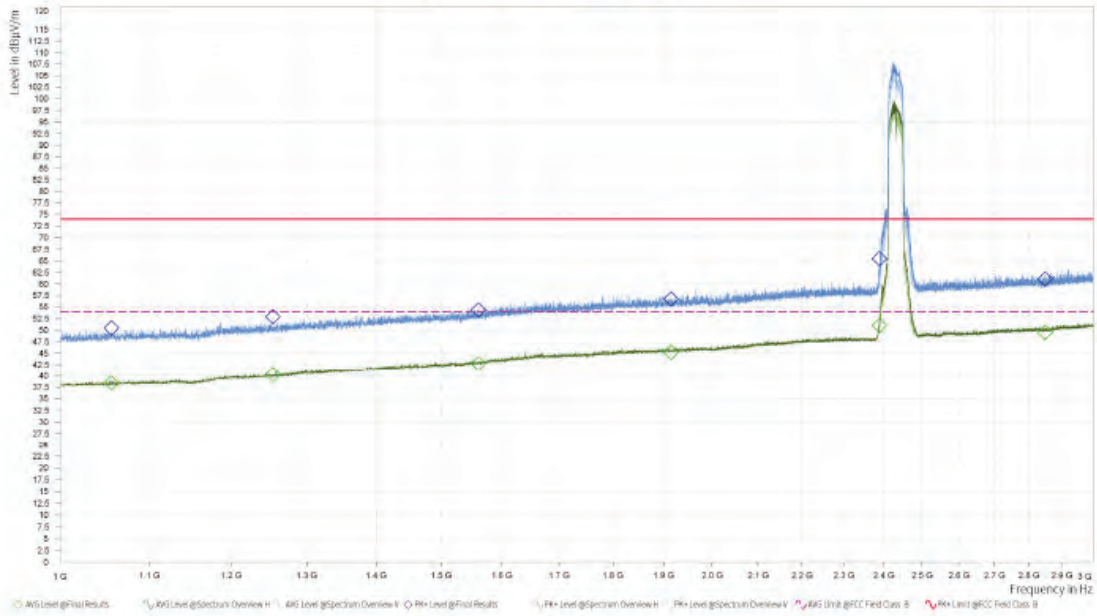

Note: The signal beyond the limit is carrier.
Radiates Emission from 1GHz to 3GHz

Spectrum Overview H/V

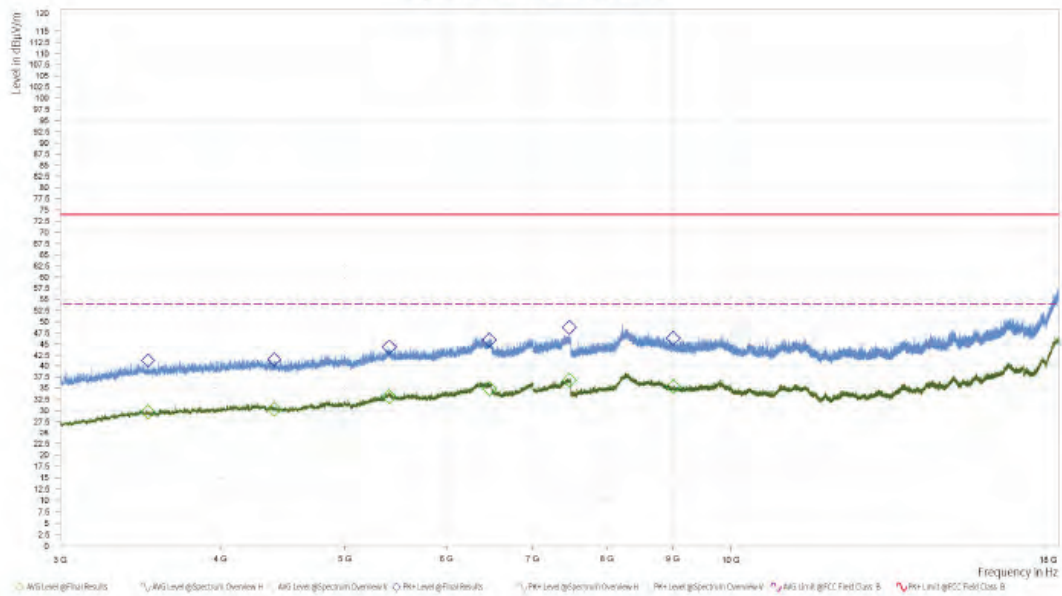

Radiates Emission from 3GHz to 18GHz

Frequency (MHz)	MaxPeak (dB μ V/m)	MaxPeak Limit (dB μ V/m)	MaxPeak Margin (dB)	Average (dB μ V/m)	Average Limit (dB μ V/m)	Average Margin (dB)	Meas. Time (s)	Pol	Azimuth (deg)	Height (m)	Corr. (dB/m)
1,056.000	50.45	74.00	23.55	38.44	54.00	15.56	1.000	V	199.5	1.00	-6.44
1,254.000	52.88	74.00	21.12	40.27	54.00	13.73	1.000	V	143.2	1.00	-4.34
1,560.000	54.43	74.00	19.57	42.80	54.00	11.20	1.000	H	360	1.00	-2.18
1,914.500	56.78	74.00	17.22	45.24	54.00	8.76	1.000	V	153.2	2.00	0.05
2,389.500	65.45	74.00	8.55	51.05	54.00	2.95	1.000	H	0	2.00	2.42
2,850.750	61.06	74.00	12.94	49.48	54.00	4.52	1.000	H	360	1.00	3.69

Remark: 1. Correction Factor = Antenna factor + Insertion loss (cable loss + amplifier gain)

2. Margin = Limit -MAX Peak/ Average

802.11n (HT40) CH6

Spectrum Overview H/V

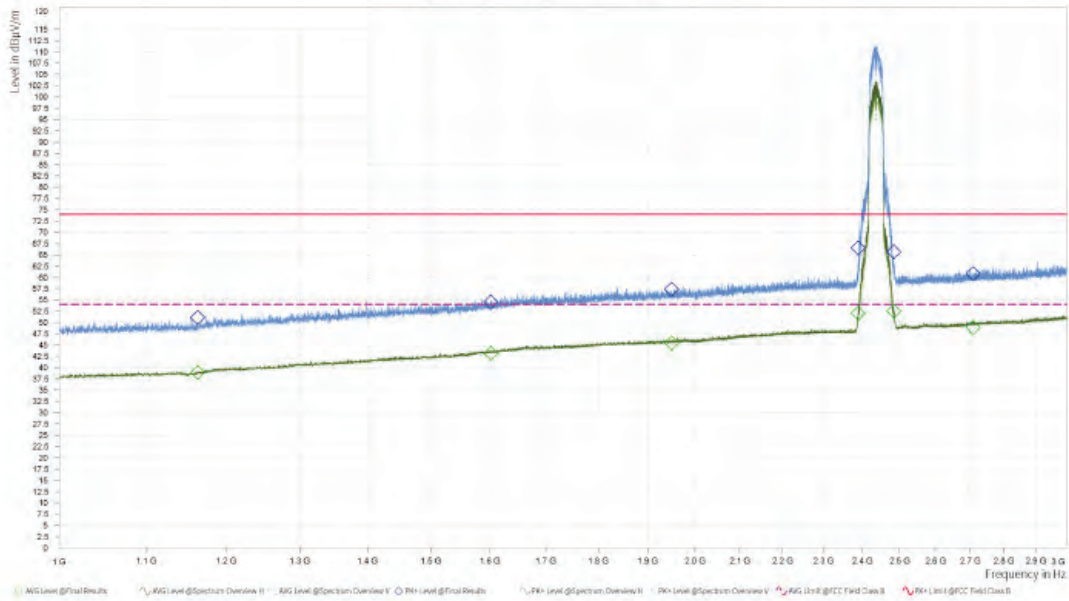

Note: The signal beyond the limit is carrier.
Radiates Emission from 1GHz to 3GHz

Spectrum Overview H/V

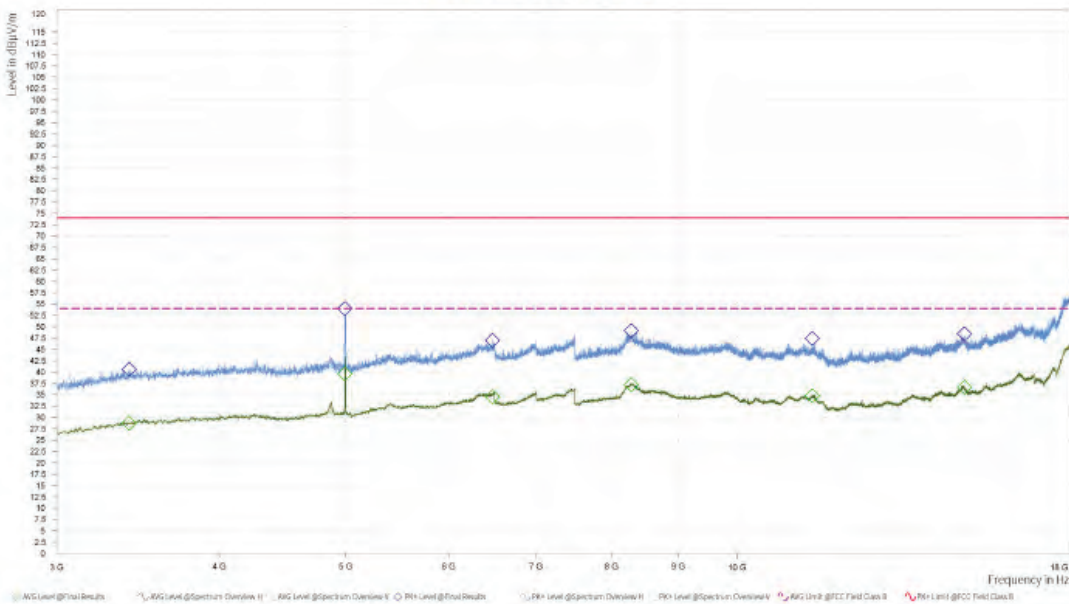

Radiates Emission from 3GHz to 18GHz

Frequency (MHz)	MaxPeak (dB μ V/m)	MaxPeak Limit (dB μ V/m)	MaxPeak Margin (dB)	Average (dB μ V/m)	Average Limit (dB μ V/m)	Average Margin (dB)	Meas. Time (s)	Pol	Azimuth (deg)	Height (m)	Corr. (dB/m)
1,162.750	51.07	74.00	22.93	38.93	54.00	15.07	1.000	H	331.3	1.00	-5.48
1,601.250	54.54	74.00	19.46	43.16	54.00	10.84	1.000	H	141.8	1.00	-1.75
1,949.500	57.39	74.00	16.61	45.49	54.00	8.51	1.000	H	31.7	1.00	0.30
2,390.000	66.58	74.00	7.42	52.05	54.00	1.95	1.000	H	141.8	1.00	2.43
2,484.250	65.64	74.00	8.36	52.53	54.00	1.47	1.000	H	155.4	2.00	2.82
2,708.750	60.85	74.00	13.15	48.92	54.00	5.08	1.000	V	252	2.00	3.36

Remark: 1. Correction Factor = Antenna factor + Insertion loss (cable loss + amplifier gain)

2. Margin = Limit –MAX Peak/ Average

802.11n (HT40) CH7

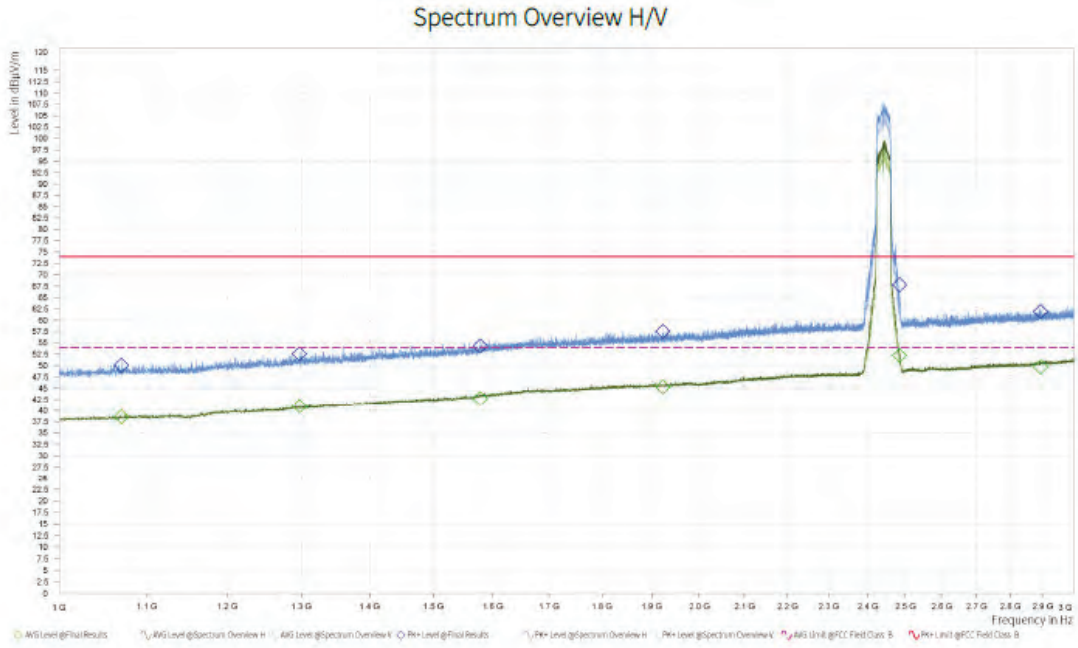

Note: The signal beyond the limit is carrier.
Radiates Emission from 1GHz to 3GHz

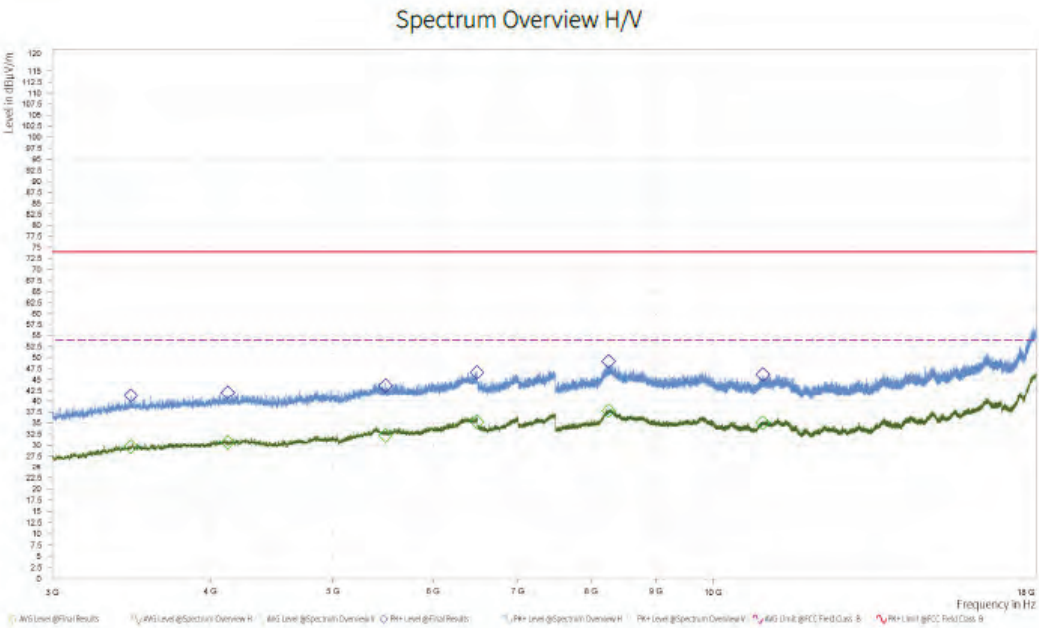

Radiates Emission from 3GHz to 18GHz

Frequency (MHz)	MaxPeak (dB μ V/m)	MaxPeak Limit (dB μ V/m)	MaxPeak Margin (dB)	Average (dB μ V/m)	Average Limit (dB μ V/m)	Average Margin (dB)	Meas. Time (s)	Pol	Azimuth (deg)	Height (m)	Corr. (dB/m)
1,069.750	50.11	74.00	23.89	38.54	54.00	15.46	1.000	H	239.4	2.00	-6.32
1,297.250	52.63	74.00	21.37	40.98	54.00	13.02	1.000	H	151.7	2.00	-3.85
1,577.750	54.33	74.00	19.67	42.72	54.00	11.28	1.000	H	333.7	1.00	-1.86
1,922.750	57.50	74.00	16.50	45.34	54.00	8.66	1.000	V	127.4	1.00	0.10
2,484.500	67.78	74.00	6.22	52.22	54.00	1.78	1.000	H	165.4	1.00	2.81
2,894.000	61.95	74.00	12.05	49.73	54.00	4.27	1.000	H	63.9	2.00	4.05

Remark: 1. Correction Factor = Antenna factor + Insertion loss (cable loss + amplifier gain)

2. Margin = Limit -MAX Peak/ Average

802.11n (HT40) CH8

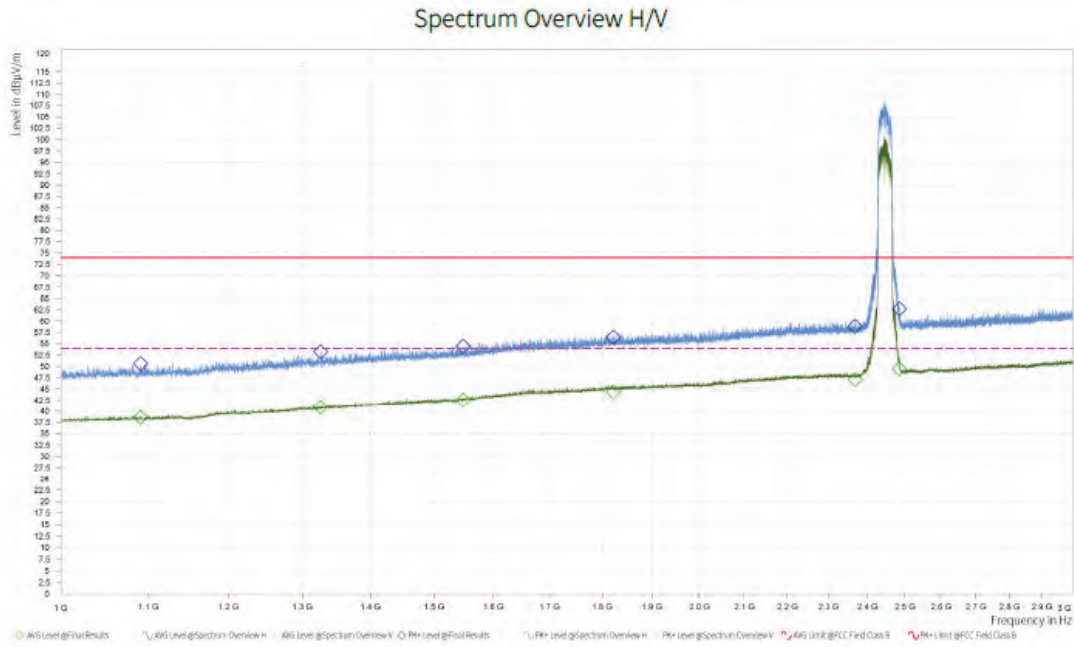

Note: The signal beyond the limit is carrier.
Radiates Emission from 1GHz to 3GHz

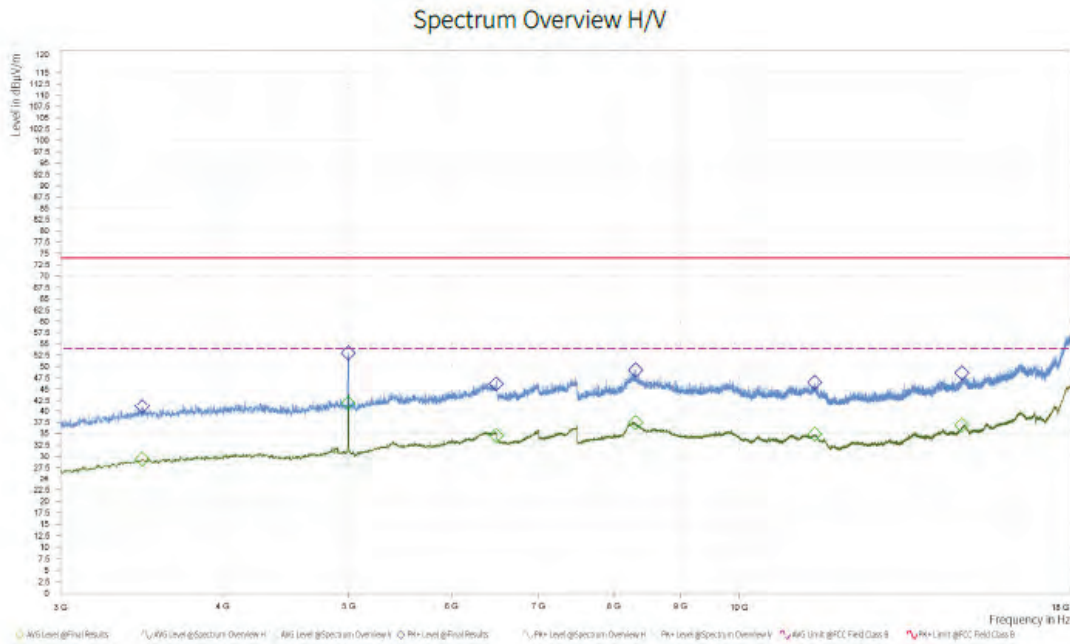

Radiates Emission from 3GHz to 18GHz

Frequency (MHz)	MaxPeak (dB μ V/m)	MaxPeak Limit (dB μ V/m)	MaxPeak Margin (dB)	Average (dB μ V/m)	Average Limit (dB μ V/m)	Average Margin (dB)	Meas. Time (s)	Pol	Azimuth (deg)	Height (m)	Corr. (dB/m)
1,090.500	50.66	74.00	23.34	38.68	54.00	15.32	1.000	V	181	1.00	-6.08
1,325.750	53.24	74.00	20.76	40.89	54.00	13.11	1.000	H	114.4	2.00	-3.68
1,547.500	54.45	74.00	19.55	42.56	54.00	11.44	1.000	V	3.4	1.00	-2.14
1,822.250	56.46	74.00	17.54	44.36	54.00	9.64	1.000	V	263.9	1.00	-0.40
2,369.000	58.87	74.00	15.13	47.08	54.00	6.92	1.000	H	257	2.00	2.14
2,485.750	62.73	74.00	11.27	49.45	54.00	4.55	1.000	H	74.2	2.00	2.81

Remark: 1. Correction Factor = Antenna factor + Insertion loss (cable loss + amplifier gain)

2. Margin = Limit -MAX Peak/ Average

802.11n (HT40) CH9

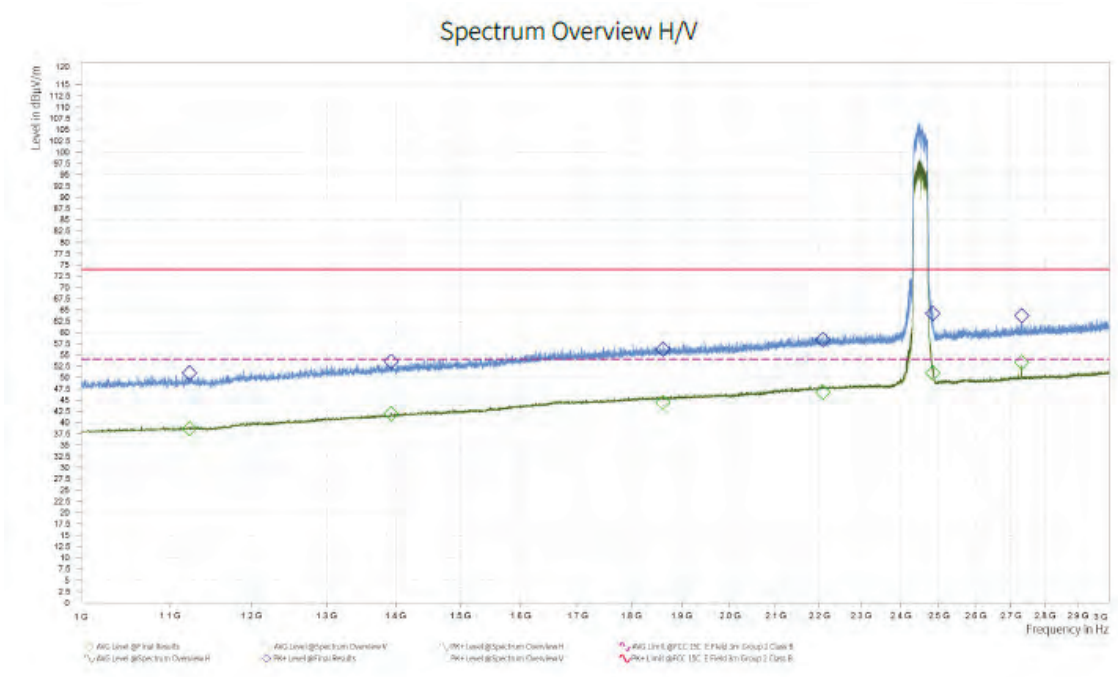

Note: The signal beyond the limit is carrier.
Radiates Emission from 1GHz to 3GHz

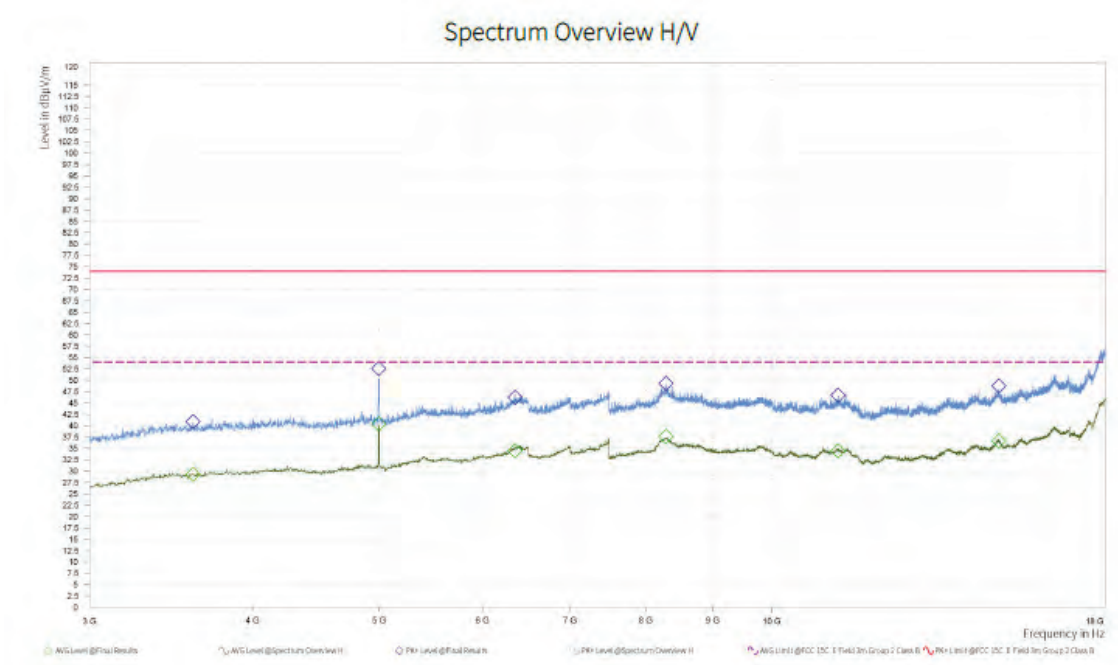

Radiates Emission from 3GHz to 18GHz

Frequency (MHz)	MaxPeak (dB μ V/m)	MaxPeak Limit (dB μ V/m)	MaxPeak Margin (dB)	Average (dB μ V/m)	Average Limit (dB μ V/m)	Average Margin (dB)	Meas. Time (s)	Pol	Azimuth (deg)	Height (m)	Corr. (dB/m)
1,122.750	50.98	74.00	23.02	38.64	54.00	15.36	1.000	H	2	2.00	-5.78
1,393.000	53.53	74.00	20.47	41.91	54.00	12.09	1.000	V	358.6	1.00	-3.19
1,862.500	56.25	74.00	17.75	44.51	54.00	9.49	1.000	H	257.6	2.00	-0.26
2,209.000	58.36	74.00	15.64	46.77	54.00	7.23	1.000	V	0.6	1.00	1.82
2,484.250	64.18	74.00	9.82	51.02	54.00	2.98	1.000	H	155	2.00	2.82
2,732.250	63.72	74.00	10.28	53.34	54.00	0.66	1.000	H	141.6	2.00	3.43

Remark: 1. Correction Factor = Antenna factor + Insertion loss (cable loss + amplifier gain)

2. Margin = Limit –MAX Peak/ Average

During the test, the Radiates Emission from 18GHz to 26.5GHz was performed in all modes with all channels, 802.11n (HT40) CH4 are selected as the worst condition. The test data of the worst-case condition was recorded in this report.

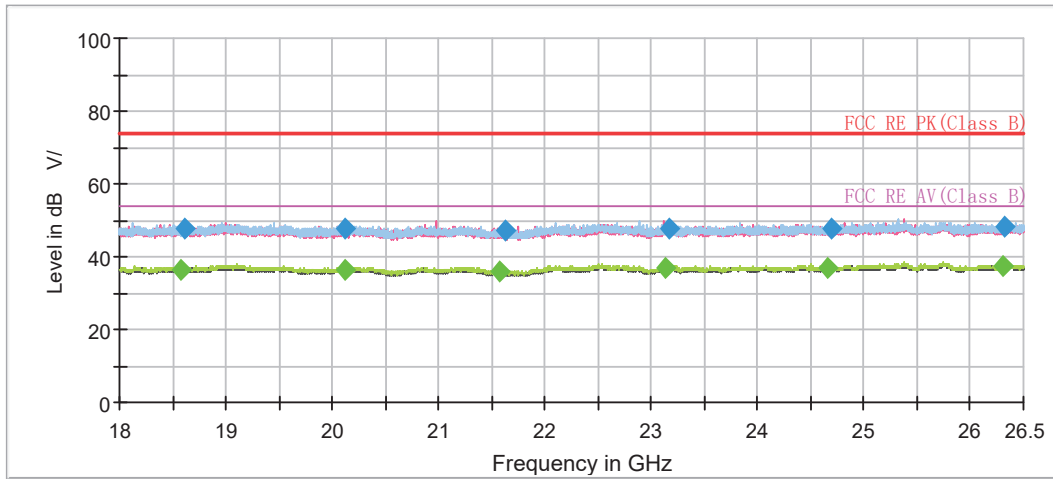

Radiates Emission from 18GHz to 26.5GHz

Frequency (MHz)	MaxPeak (dB μ V/m)	Average (dB μ V/m)	Limit (dB μ V/m)	Margin (dB)	Meas. Time (s)	Height (cm)	Pol	Azimuth (deg)	Corr. (dB/m)
18574.987500	---	36.64	54.00	17.36	500.0	200.0	H	229.0	-4.6
18613.400000	47.81	---	74.00	26.19	500.0	200.0	V	180.0	-4.6
20117.577500	47.65	---	74.00	26.35	500.0	200.0	H	270.0	-4.5
20127.847500	---	36.49	54.00	17.51	500.0	200.0	H	284.0	-4.4
21570.187500	---	35.72	54.00	18.28	500.0	200.0	H	0.0	-4.1
21629.440000	47.05	---	74.00	26.95	500.0	200.0	H	26.0	-4.0
23137.100000	---	36.83	54.00	17.17	500.0	100.0	H	307.0	-2.9
23163.282500	47.73	---	74.00	26.27	500.0	200.0	V	344.0	-2.9
24653.643750	---	36.81	54.00	17.19	500.0	100.0	H	220.0	-2.2
24702.160000	47.70	---	74.00	26.30	500.0	100.0	H	339.0	-2.2
26300.315000	---	37.30	54.00	16.70	500.0	200.0	H	12.0	-1.3
26325.420000	48.07	---	74.00	25.93	500.0	200.0	V	143.0	-1.3

Remark: 1. Correction Factor = Antenna factor + Insertion loss (cable loss + amplifier gain)

2. Margin = Limit –MAX Peak/ Average

5.7. Conducted Emission

Ambient Condition

Temperature	Relative humidity
15°C ~ 35°C	20% ~ 80%

Methods of Measurement

The EUT is placed on a non-metallic table of 80cm height above the horizontal metal reference ground plane. During the test, the EUT was operating in its typical mode. The test method is according to ANSI C63.10. Connect the AC power line of the EUT to the L.I.S.N. Use EMI receiver to detect the average and Quasi-peak value. RBW is set to 9 kHz, VBW is set to 30kHz.

The measurement result should include both L line and N line.

The test is in transmitting mode.

Test Setup

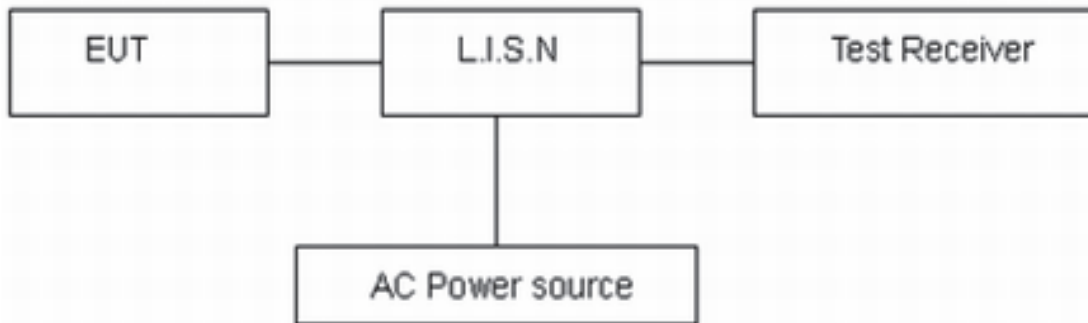

Note: AC Power source is used to change the voltage 110V/60Hz.

Limits

Frequency (MHz)	Conducted Limits(dB μ V)	
	Quasi-peak	Average
0.15 - 0.5	66 to 56 *	56 to 46*
0.5 - 5	56	46
5 - 30	60	50

*: Decreases with the logarithm of the frequency.

Measurement Uncertainty

The assessed measurement uncertainty to ensure 95% confidence level for the normal distribution is with the coverage factor $k = 1.96$, $U = 2.69$ dB.

Test Results:

Following plots, Blue trace uses the peak detection and Green trace uses the average detection. During the test, the Conducted Emission was performed in all modes with all channels, 802.11n (HT40) CH4 are selected as the worst condition. The test data of the worst-case condition was recorded in this report.

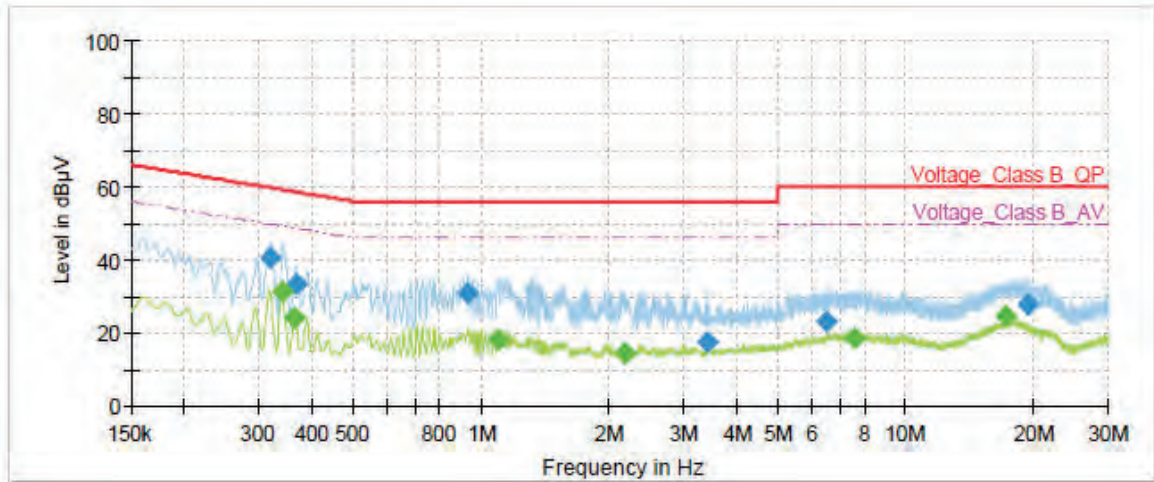

Frequency (MHz)	QuasiPeak (dBµV)	Average (dBµV)	Limit (dBµV)	Margin (dB)	Meas. Time (s)	Bandwidth (kHz)	Line	Filter	Corr. (dB)
0.32	40.63	---	59.74	19.11	1000.0	9.000	L1	ON	21.0
0.34	---	31.28	49.17	17.89	1000.0	9.000	L1	ON	21.0
0.36	---	23.85	48.64	24.79	1000.0	9.000	L1	ON	21.0
0.37	33.16	---	58.59	25.43	1000.0	9.000	L1	ON	21.0
0.93	30.69	---	56.00	25.31	1000.0	9.000	L1	ON	20.3
1.10	---	17.73	46.00	28.27	1000.0	9.000	L1	ON	20.2
2.17	---	14.15	46.00	31.85	1000.0	9.000	L1	ON	19.7
3.43	17.27	---	56.00	38.73	1000.0	9.000	L1	ON	19.5
6.50	23.31	---	60.00	36.69	1000.0	9.000	L1	ON	19.5
7.56	---	18.51	50.00	31.49	1000.0	9.000	L1	ON	19.5
17.25	---	24.42	50.00	25.58	1000.0	9.000	L1	ON	19.7
19.31	27.62	---	60.00	32.38	1000.0	9.000	L1	ON	19.7

Remark: Correct factor=cable loss + LISN factor

L line Conducted Emission from 150 KHz to 30 MHz

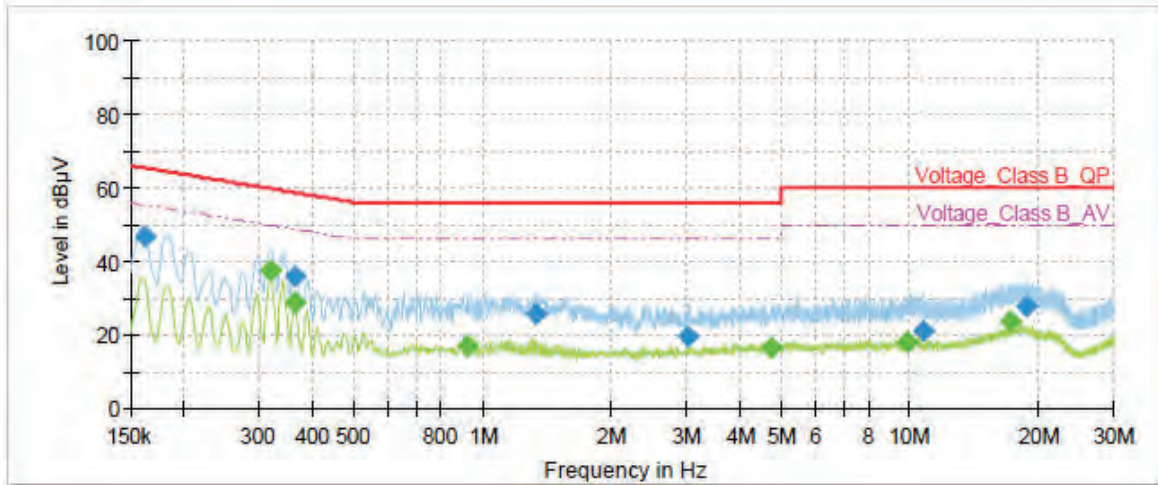

Frequency (MHz)	QuasiPeak (dBµV)	Average (dBµV)	Limit (dBµV)	Margin (dB)	Meas. Time (s)	Bandwidth (kHz)	Line	Filter	Corr. (dB)
0.16	46.66	---	65.40	18.74	1000.0	9.000	N	ON	21.0
0.32	---	37.19	49.74	12.55	1000.0	9.000	N	ON	21.0
0.36	---	28.95	48.64	19.69	1000.0	9.000	N	ON	21.0
0.36	35.85	---	58.64	22.79	1000.0	9.000	N	ON	21.0
0.92	---	17.05	46.00	28.95	1000.0	9.000	N	ON	20.3
1.33	25.41	---	56.00	30.59	1000.0	9.000	N	ON	20.0
3.01	19.54	---	56.00	36.46	1000.0	9.000	N	ON	19.6
4.72	---	16.20	46.00	29.80	1000.0	9.000	N	ON	19.5
9.90	---	18.04	50.00	31.96	1000.0	9.000	N	ON	19.6
10.70	20.91	---	60.00	39.09	1000.0	9.000	N	ON	19.6
17.25	---	23.55	50.00	26.45	1000.0	9.000	N	ON	19.7
18.84	27.60	---	60.00	32.40	1000.0	9.000	N	ON	19.7

Remark: Correct factor=cable loss + LISN factor

N line Conducted Emission from 150 KHz to 30 MHz

6. Main Test Instruments

Name	Manufacturer	Type	Serial Number	Calibration Date	Expiration Date
Power sensor	R&S	NRP18S	101954	2023-05-12	2024-05-11
Spectrum Analyzer	KEYSIGHT	N9020A	MY51330870	2023-05-12	2024-05-11
DC Power Supply	UNI-T	UTP1306S+	2205D0517426	2023-12-05	2024-12-04
Temperature Chamber	ESPEC	SU-242	93000506	2023-12-05	2024-12-04
Unwanted Emission					
Antenna Tower	ETS	2175	00095628	/	/
EMI Test Receiver	R&S	ESR	102389	2023-05-12	2024-05-11
Signal Analyzer	R&S	FSV40	101298	2023-05-12	2024-05-11
Signal Analyzer	R&S	FSV3044	103495	2023-09-19	2024-09-18
Loop Antenna	SCHWARZBECK	FMZB1519	1519-047	2023-04-16	2026-04-15
TRILOG Broadband Antenna	SCHWARZBECK	VULB 9163	1023	2023-07-14	2026-07-13
Horn Antenna	R&S	HF907	102723	2021-07-24	2024-07-23
Amplifier	R&S	SCU18	10034	2023-05-12	2024-05-11
Horn Antenna	ETS-Lindgren	3160-09	00102643	2021-10-10	2024-10-09
Amplifier	MicroWave	KLNA-1804 0050	220826001	2023-05-12	2024-05-11
Software	R&S	EMC32	9.26.01	/	/
Conducted Emission					
Artificial main network	R&S	ENV216	102191	2022-12-10	2024-12-09
EMI Test Receiver	R&S	ESR	101667	2023-05-12	2024-05-11
Software	R&S	EMC32	10.35.10	/	/

ANNEX A: The EUT Appearance

The EUT Appearance are submitted separately.

ANNEX B: Test Setup Photos

The Test Setup Photos are submitted separately.

***** END OF REPORT *****