



FCC PART 24TEST REPORT
Part 24 Subpart E

Report Reference No......: HK2205182092-10E

FCC ID.....: **2AU4T-TM22-LCC**

Compiled by
(position+printed name+signature)..: File administrators Gary Qian

Supervised by
(position+printed name+signature)..: Technique principal Eden Hu

Approved by
(position+printed name+signature)..: Manager Jason Zhou

Date of issue.....: Jun. 16, 2022

Testing Laboratory Name: **Shenzhen HUAK Testing Technology Co., Ltd.**

Address.....: 1-2/F., Building B2, Junfeng Zhongcheng Zhizao Innovation Park,
Heping, Fuhai Street, Bao'an District, Shenzhen, Guangdong, China

Applicant's name.....: **Shanghai TUGE Data Technologies Co., Ltd.**

Address: Room 316, Lane 302, Lane 838, Shuyuan Town, Pudong New Area,
Shanghai, China

Test specification

Standard: **FCC CFR Title 47 Part 2, Part 24E**

TRF Originator.....: Shenzhen HUAK Testing Technology Co., Ltd.

Shenzhen HUAK Testing Technology Co., Ltd.All rights reserved.

This publication may be reproduced in whole or in part for non-commercial purposes as long as the Shenzhen HUAK Testing Technology Co., Ltd.as copyright owner and source of the material. Shenzhen HUAK Testing Technology Co., Ltd.takes no responsibility for and will not assume liability for damages resulting from the reader's interpretation of the reproduced material due to its placement and context.

Test item description: 4G module

Trade Mark: N/A

Manufacturer.....: **Shanghai Stoneoim Intelligent Technology Co., Ltd.**

Model/Type reference.....: TM22-LCC

Series Models: TM22, TM22G, TM22G-LCC, TM22C, TM22C-LCC

Modulation Type: QPSK, 16QAM

Rating: DC 5V

Hardware version: V1.1

Software version.....: V1.1

Result.....: **PASS**



TEST REPORT

Test Report No. :	HK2205182092-10E	Jun. 16, 2022
		Date of issue

Equipment under Test : 4G module

Model /Type : TM22-LCC

Series Models : TM22, TM22G, TM22G-LCC, TM22C, TM22C-LCC

Applicant : **Shanghai TUGE Data Technologies Co., Ltd.**

Address : Room 316, Lane 302, Lane 838, Shuyuan Town, Pudong New Area, Shanghai, China

Manufacturer : **Shanghai Stoneoim Intelligent Technology Co., Ltd.**

Address : Floors 11, building 7, Innovation and Intelligence Center, No.410, Yunzhen Road, Songjiang District, Shanghai, China

Test Result:	PASS
---------------------	-------------

The test report merely corresponds to the test sample.
It is not permitted to copy extracts of these test result without the written permission of the test laboratory.



**** Modified History ****

Revision	Description	Issued Data	Remark
Revision 1.0	Initial Test Report Release	Jun. 16, 2022	Jason Zhou



Contents

1	<u>TEST STANDARDS.....</u>	5
2	<u>SUMMARY</u>	6
2.1	General Remarks	6
2.2	Product Description	6
2.3	Equipment under Test	6
2.4	Short description of the Equipment under Test (EUT)	6
2.5	Normal Accessory setting	7
2.6	EUT configuration	7
2.7	Related Submittal(s) / Grant (s)	7
2.8	Modifications	7
2.9	GeneralTest Conditions/Configurations	7
3	<u>TEST ENVIRONMENT.....</u>	8
3.1	Information of The Test Laboratory	8
3.2	Environmental conditions	8
3.3	Test Description	8
3.4	Equipments Used during the Test	9
4	<u>TEST CONDITIONS AND RESULTS.....</u>	10
4.1	Output Power	10
4.2	Peak-to-Average Ratio (PAR)	16
4.3	Occupied Bandwidth and Emission Bandwidth	23
4.4	Band Edge compliance	30
4.5	Spurious Emssion on Antenna Port	37
4.6	Radiated Spurious Emssion	56
4.7	Frequency Stability	64
5	<u>TEST SETUP PHOTOS OF THE EUT</u>	66
6	<u>PHOTOS OF THE EUT.....</u>	67



1 TEST STANDARDS

The tests were performed according to following standards:

[FCC Part 24](#) :PUBLIC MOBILE SERVICES

[TIA/EIA 603 D June 2010](#):Land Mobile FM or PM Communications Equipment Measurement and Performance Standards.

[47 CFR FCC Part 15 Subpart B](#) : - Unintentional Radiators

[FCC Part 2](#): FREQUENCY ALLOCA-TIONS AND RADIO TREATY MAT-TERS; GENERAL RULES AND REG-ULATIONS

[KDB971168 D01:v02r02](#)MEASUREMENT GUIDANCE FOR CERTIFICATION OF LICENSED DIGITAL TRANSMITTERS

[ANSI C63.4:2014](#):Methods of Measurement of Radio-Noise Emissions from Low-Voltage Electrical and Electronic Equipment in the Range of 9 kHz to 40 GHz



2 SUMMARY

2.1 General Remarks

Date of receipt of test sample	:	May. 09, 2022
Testing commenced on	:	May. 09, 2022
Testing concluded on	:	Jun. 16, 2022

2.2 Product Description

The **Shanghai TUGE Data Technologies Co., Ltd.**'s Model:TM22-LCC or the "EUT" as referred to in this report; more general information as follows,for more details, refer to the user's manual of the EUT.

Name of EUT	4G module
Model/Type reference:	TM22-LCC
Series Models:	TM22, TM22G, TM22G-LCC, TM22C, TM22C-LCC
Power supply:	DC 5V
Modulation Type	QPSK,16QAM
Antenna Type	FPC Antenna
Antenna Gain	1dBi
Operation Frequency Band	LTE Band 25
Operation frequency	LTE Band 25: 1850 to 1915MHz
LTE Release	R8
Extreme temp. Tolerance	-30°C to +70°C
Extreme vol. Limits	4.25VDC to 5.75VDC (nominal: 5.0VDC)

2.3 Equipment under Test

Power supply system utilised

Power supply voltage	:	<input type="radio"/> 120V/ 60 Hz	<input type="radio"/> 115V/60Hz
		<input type="radio"/> 12 V DC	<input type="radio"/> 24 V DC
		<input checked="" type="radio"/> Other (specified in blank below)	

2.4 Short description of the Equipment under Test (EUT)

2.4.1 GeneralDescription

This is a 4G module.

For more details, refer to the user's manual of the EUT



2.5 Normal Accessory setting

Fully charged battery was used during the test.

2.6 EUT configuration

The following peripheral devices and interface cables were connected during the measurement:

- - supplied by the manufacturer
- - supplied by the lab

<input type="radio"/>	Power Cable	Length (m) :	/
		Shield :	/
		Detachable :	/
<input type="radio"/>	Multimeter	Manufacturer :	/
		Model No. :	/

2.7 Related Submittal(s) / Grant (s)

This submittal(s) (test report) is intended for FCC ID: 2AU4T-TM22-LCC filing to comply with FCC Part 24, Rules.

2.8 Modifications

No modifications were implemented to meet testing criteria.

2.9 General Test Conditions/Configurations

2.10.1 Test Environment

Environment Parameter	Selected Values During Tests	
Relative Humidity	Ambient	
Temperature	TN	Ambient
Voltage	VL	4.25V
	VN	5.0V
	VH	5.75V

NOTE: VL=lower extreme test voltage VN=nominal voltage VH=upper extreme test voltage TN=normal temperature



3 TEST ENVIRONMENT

3.1 Information of The Test Laboratory

Shenzhen HUAK Testing Technology Co., Ltd.
Add.: 1-2/F., Building B2, Junfeng Zhongcheng Zhizao Innovation Park, Heping,
Fuhai Street, Bao'an District, Shenzhen, Guangdong, China

Testing Laboratory Authorization:

A2LA Accreditation Code is 4781.01.
FCC Designation Number is CN1229.
Canada IC CAB identifier is CN0045.
CNAS Registration Number is L9589.

3.2 Environmental conditions

During the measurement the environmental conditions were within the listed ranges:

Temperature:	15-35 ° C
Humidity:	30-60 %
Atmospheric pressure:	950-1050mbar

3.3 Test Description

PCSBand (1850-1915MHz pairedwith 1930-1995MHz)

Test Item	FCCRuleNo.	Requirements	Verdict
Effective(Isotropic)RadiatedOutputPower	Part§2.1046, Part§24.232	EIRP ≤ 2W	Pass
Peak-AverageRatio	Part§2.1046, Part§24.232	FCC:Limit≤13dB	Pass
Bandwidth	Part§2.1049 RSS-133	OBW: Nolimit. EBW: Nolimit.	Pass
BandEdgesCompliance	Part§2.1051, Part§24.238	≤ -13dBm/1%*EBW, In1MHzbandsimmediatelyoutsideandadjacentto Thefrequency block.	Pass
SpuriousEmissionatAntennaTerminals	Part§2.1051, Part§24.238	≤-13dBm/1MHz, from9kHzto10thharmonicsbut outsideauthorized Operatingfrequency ranges.	Pass
Field Strengthof Spurious Radiation	Part§2.1053, Part§24.238	≤ -13dBm/1MHz.	Pass
Frequency Stability	Part§2.1055, Part§24.235	FCC:withinauthorizedfrequency block.	Pass

NOTE 1:For the verdict,the“N/A”denotes“not applicable”,the“N/T”denotes “nottested”.

Remark:

1. The measurement uncertainty is not included in the test result.



3.4 Equipments Used during the Test

Test Equipment	Manufacturer	Model No.	Serial No.	Calibration Date	Calibration Due Date
LISN	ENV216	R&S	HKE-059	2022/02/18	2023/02/17
LISN	R&S	ENV216	HKE-002	2022/02/18	2023/02/17
Broadband antenna	Schwarzbeck	VULB 9163	HKE-012	2022/02/18	2023/02/17
Receiver	R&S	ESCI 7	HKE-010	2022/02/18	2023/02/17
Spectrum analyzer	Agilent	N9020A	HKE-048	2022/02/18	2023/02/17
RF automatic control unit	Tonscend	JS0806-2	HKE-060	2022/02/18	2023/02/17
Horn antenna	Schwarzbeck	9120D	HKE-013	2022/02/18	2023/02/17
Loop antenna	Schwarzbeck	FMZB 1519 B	HKE-014	2022/02/18	2023/02/17
Preamplifier	EMCI	EMC051845SE	HKE-015	2022/02/18	2023/02/17
Preamplifier	Agilent	83051A	HKE-016	2022/02/18	2023/02/17
Temperature and humidity meter	Boyang	HTC-1	HKE-075	2022/02/18	2023/02/17
High pass filter unit	Tonscend	JS0806-F	HKE-055	2022/02/18	2023/02/17
RF cable	Times	1-40G	HKE-034	2022/02/18	2023/02/17
Power meter	Agilent	E4419B	HKE-085	2022/02/18	2023/02/17
Power Sensor	Agilent	E9300A	HKE-086	2022/02/18	2023/02/17
Wireless Communication Test Set	R&S	CMW500	HKE-026	2022/02/18	2023/02/17

The results shown in this test report refer only to the sample(s) tested unless otherwise stated and the sample(s) are retained for 30 days only. The document is issued by HUAKE, this document cannot be reproduced except in full with our prior written permission. The more details and the authenticity of the report will be confirmed at <http://www.cer-mark.com>.

TEL : +86-755 2302 9901 FAX : +86-755 2302 9901 E-mail : service@cer-mark.com

Add: 1-2F., Building B2, Junfeng Zhongcheng Zhizao Innovation Park, Heping Community, Fuhai Street, Bao'an District, Shenzhen, Guangdong, China



4 TEST CONDITIONS AND RESULTS

4.1 Output Power

4.1.1 Conducted Output Power

TEST APPLICABLE

During the process of testing, the EUT was controlled via R&S Digital Radio Communication tester (CMW500) to ensure max power transmission and proper modulation. This result contains output power and EIRP measurements for the EUT. In all cases, output power is within the specified limits.

TEST CONFIGURATION

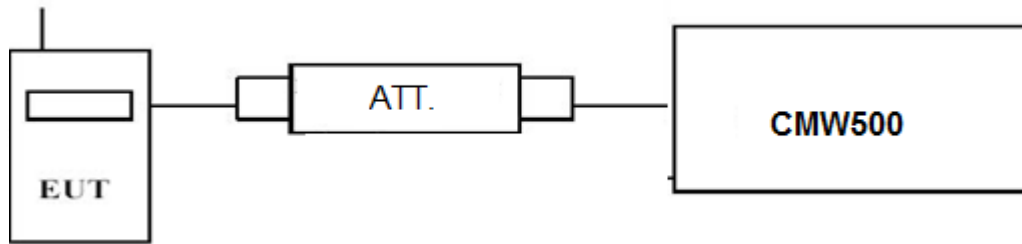

TEST PROCEDURE

Conducted Power Measurement:

- Place the EUT on a bench and set it in transmitting mode.
- Connect a low loss RF cable from the antenna port to a CMW500 by an Att.
- EUT Communicate with CMW500 then selects a channel for testing.
- Add a correction factor to the display CMW500, and then test.

TEST RESULTS

Remark:

- We measured all RB Configuration refer 3GPP TS136 521 for each Channel Bandwidth of LTE Band 25;

LTE Band 25				
TX Channel Bandwidth	Frequency (MHz)	RB Size/Offset	Burst Average Power [dBm]	
			QPSK	16QAM
1.4 MHz	1850.7	1 RB low	23.82	23.36
		1 RB high	23.83	23.36
		50% RB mid	23.79	23.13
		100% RB	23.77	22.63
	1882.5	1 RB low	23.75	22.62
		1 RB high	23.87	22.62
		50% RB mid	22.84	22.11
		100% RB	23.41	22.36
	1914.3	1 RB low	23.37	22.34
		1 RB high	23.18	22.03
		50% RB mid	23.46	22.33
		100% RB	23.44	22.31
3 MHz	1851.5	1 RB low	23.26	22.45
		1 RB high	23.22	21.99
		50% RB mid	23.29	22.34
		100% RB	22.33	21.62
	1882.5	1 RB low	22.29	21.58
		1 RB high	22.31	21.67
		50% RB mid	22.22	21.42

The results shown in this test report refer only to the sample(s) tested unless otherwise stated and the sample(s) are retained for 30 days only. The document is issued by HUAK, this document cannot be reproduced except in full with our prior written permission. The more details and the authenticity of the report will be confirmed at <http://www.cer-mark.com>.



	1913.5	100% RB	22.84	21.84
		1 RB low	22.84	21.75
		1 RB high	22.85	21.92
		50% RB mid	21.88	21.07
		100% RB	21.89	21.09
5 MHz	1852.5	1 RB low	23.29	22.44
		1 RB high	23.36	21.80
		50% RB mid	23.32	21.62
		100% RB	22.31	21.36
	1882.5	1 RB low	22.22	21.39
		1 RB high	22.33	21.40
		50% RB mid	22.33	21.51
		100% RB	22.97	21.36
	1912.5	1 RB low	22.99	21.39
		1 RB high	22.98	21.33
		50% RB mid	21.91	21.04
		100% RB	21.99	21.10
10 MHz	1855.0	1 RB low	23.17	21.97
		1 RB high	23.21	22.30
		50% RB mid	23.12	22.15
		100% RB	22.24	21.39
	1882.5	1 RB low	22.26	21.33
		1 RB high	22.27	21.36
		50% RB mid	22.33	21.38
		100% RB	22.83	21.94
	1910	1 RB low	22.79	22.61
		1 RB high	22.71	21.58
		50% RB mid	22.00	21.17
		100% RB	21.89	21.03
15 MHz	1857.5	1 RB low	23.33	22.51
		1 RB high	23.13	22.19
		50% RB mid	22.90	22.08
		100% RB	22.26	21.48
	1882.5	1 RB low	22.28	21.48
		1 RB high	22.29	21.42
		50% RB mid	22.20	21.31
		100% RB	22.82	22.09
	1907.5	1 RB low	22.74	21.60
		1 RB high	22.63	21.49
		50% RB mid	21.93	20.91
		100% RB	21.99	21.11
20 MHz	1860.0	1 RB low	23.29	22.15
		1 RB high	23.18	21.86
		50% RB mid	22.87	21.55
		100% RB	22.15	21.33
	1882.5	1 RB low	22.15	21.38
		1 RB high	22.14	21.40
		50% RB mid	22.01	21.23
		100% RB	22.90	22.03
	1905	1 RB low	23.98	22.17
		1 RB high	22.89	22.13
		50% RB mid	21.86	20.94
		100% RB	21.87	20.99

The results shown in this test report refer only to the sample(s) tested unless otherwise stated and the sample(s) are retained for 30 days only. The document is issued by HUAKE, this document cannot be reproduced except in full with our prior written permission. The more details and the authenticity of the report will be confirmed at <http://www.cer-mark.com>.

TEL : +86-755 2302 9901 FAX : +86-755 2302 9901 E-mail : service@cer-mark.com

Add: 1-2F., Building B2, Junfeng Zhongcheng Zhizao Innovation Park, Heping Community, Fuhai Street, Bao'an District, Shenzhen, Guangdong, China

4.1.2. Radiated Output Power

LIMIT

This is the test for the maximum radiated power from the EUT.

Rule Part 24.232(b) specifies, "Mobile/portable stations are limited to 2 watts e.i.r.p.

TEST CONFIGURATION

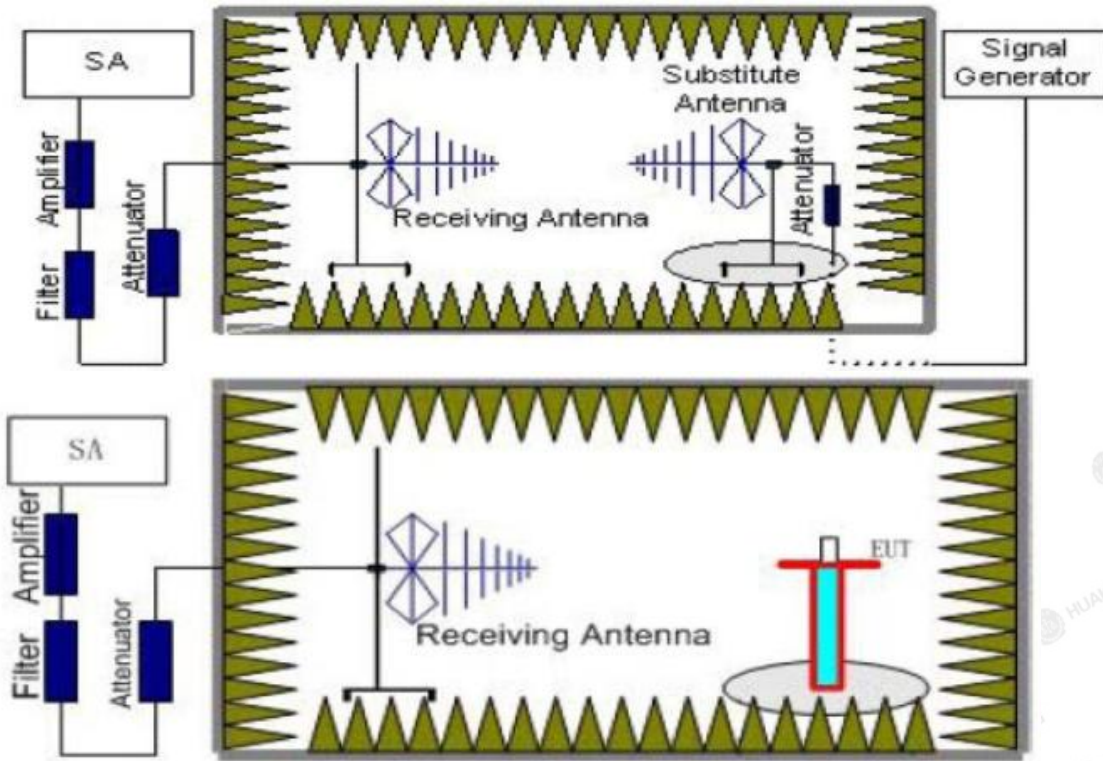

TEST PROCEDURE

1. EUT was placed on a 1.50 meter high non-conductive stand at a 3 meter test distance from the receive antenna. A receiving antenna was placed on the antenna mast 3 meters from the EUT for emission measurements. The height of receiving antenna is 1.50m. Detected emissions were maximized at each frequency by rotating the EUT through 360° and adjusting the receiving antenna polarization. The radiated emission measurements of all transmit frequencies in three channels (High, Middle, Low) were measured with peak detector.
2. A log-periodic antenna or double-ridged waveguide horn antenna shall be substituted in place of the EUT. The log-periodic antenna will be driven by a signal generator and the level will be adjusted till the same power value on the spectrum analyzer or receiver. The level of the spurious emissions can be calculated through the level of the signal generator, cable loss, the gain of the substitution antenna and the reading of the spectrum analyzer or receiver.
3. The EUT is then put into continuously transmitting mode at its maximum power level during the test. Set Test Receiver or Spectrum RBW=1MHz, VBW=3MHz, And the maximum value of the receiver should be recorded as (P_r).
4. The EUT shall be replaced by a substitution antenna. In the chamber, an substitution antenna for the frequency band of interest is placed at the reference point of the chamber. An RF Signal source for the frequency band of interest is disconnected to the substitution antenna with a cable that has been constructed to not interfere with the radiation pattern of the antenna. A power (P_{Mea}) is applied to the input of the substitution antenna, and adjust the level of the signal generator output until the value of the receiver reach the previously recorded (P_r). The power of signal source (P_{Mea}) is recorded. The test should be performed by rotating the test item and adjusting the receiving antenna polarization.



5. A amplifier should be connected to the Signal Source output port. And the cable should be connect between the Amplifier and the Substitution Antenna. The cable loss (P_{cl}), the Substitution Antenna Gain (G_a) and the Amplifier Gain (P_{Ag}) should be recorded after test.

The measurement results are obtained as described below:

Power(EIRP)=P_{Mea}- P_{Ag} - P_{cl}+ G_a

We used SMF100A microwave signal generator which signal level can up to 33dBm,so we not used power Amplifier for substitution test; The measurement results are amend as described below:

Power(EIRP)=P_{Mea}- P_{cl}+ G_a

6. This value is EIRP since the measurement is calibrated using an antenna of known gain (2.15 dBi) and known input power.

7. ERP can be calculated from EIRP by subtracting the gain of the dipole, ERP = EIRP-2.15dBi.

TEST RESULTS

Radiated Measurement:

Remark:

- 1. We measured all RB Configuration refer 3GPP TS136 521 for each Channel Bandwidth of LTE Band 25; recorded worst case for each Channel Bandwidth of LTE Band 25.
2. EIRP=P_{Mea}(dBm)-P_{cl}(dB)+P_{Ag}(dB)+G_a(dBi)
3. We measured both Horizontal and Vertical direction, recorded worst case direction.

LTE Band 25_Channel Bandwidth 1.4MHz_QPSK

Table with 9 columns: Frequency (MHz), P_Mea (dBm), P_cl (dB), G_a Antenna Gain(dB), P_Ag (dB), Burst Average EIRP (dBm), Limit (dBm), Margin (dB), Polarization. Rows include frequencies 1850.7, 1882.5, and 1914.3.

LTE Band 25_Channel Bandwidth 3MHz_QPSK

Table with 9 columns: Frequency (MHz), P_Mea (dBm), P_cl (dB), G_a Antenna Gain(dB), P_Ag (dB), Burst Average EIRP (dBm), Limit (dBm), Margin (dB), Polarization. Rows include frequencies 1851.5, 1882.5, and 1913.5.

LTE Band 25_Channel Bandwidth 5MHz_QPSK

Table with 9 columns: Frequency (MHz), P_Mea (dBm), P_cl (dB), G_a Antenna Gain(dB), P_Ag (dB), Burst Average EIRP (dBm), Limit (dBm), Margin (dB), Polarization. Rows include frequencies 1852.5, 1882.5, and 1912.5.

LTE Band 25_Channel Bandwidth 10MHz_QPSK

Table with 9 columns: Frequency (MHz), P_Mea (dBm), P_cl (dB), G_a Antenna Gain(dB), P_Ag (dB), Burst Average EIRP (dBm), Limit (dBm), Margin (dB), Polarization. Rows include frequencies 1855.0, 1882.5, and 1910.

The results shown in this test report refer only to the sample(s) tested unless otherwise stated and the sample(s) are retained for 30 days only. The document is issued by HUAKE, this document cannot be reproduced except in full with our prior written permission. The more details and the authenticity of the report will be confirmed at http://www.cer-mark.com.



LTE Band 25_Channel Bandwidth 15MHz_QPSK

Frequency (MHz)	P _{Mea} (dBm)	P _{cl} (dB)	G _a Antenna Gain(dB)	P _{Aq} (dB)	Burst Average EIRP (dBm)	Limit (dBm)	Margin (dB)	Polarization
1857.5	-20.74	3.41	10.24	33.60	19.69	33.01	13.32	V
1882.5	-19	3.49	10.24	33.60	21.35	33.01	11.66	V
1907.5	-20.61	3.55	10.23	33.60	19.67	33.01	13.34	V

LTE Band 25_Channel Bandwidth 20MHz_QPSK

Frequency (MHz)	P _{Mea} (dBm)	P _{cl} (dB)	G _a Antenna Gain(dB)	P _{Aq} (dB)	Burst Average EIRP (dBm)	Limit (dBm)	Margin (dB)	Polarization
1860.0	-21.42	3.41	10.24	33.60	19.01	33.01	14	V
1882.5	-18.35	3.49	10.24	33.60	22	33.01	11.01	V
1905	-20.52	3.55	10.23	33.60	19.76	33.01	13.25	V

LTE Band 25_Channel Bandwidth 1.4MHz_16QAM

Frequency (MHz)	P _{Mea} (dBm)	P _{cl} (dB)	G _a Antenna Gain(dB)	P _{Aq} (dB)	Burst Average EIRP (dBm)	Limit (dBm)	Margin (dB)	Polarization
1850.7	-21.13	3.41	10.24	33.60	19.3	33.01	13.71	V
1882.5	-18.72	3.49	10.24	33.60	21.63	33.01	11.38	V
1914.3	-19.5	3.55	10.23	33.60	20.78	33.01	12.23	V

LTE Band 25_Channel Bandwidth 3MHz_16QAM

Frequency (MHz)	P _{Mea} (dBm)	P _{cl} (dB)	G _a Antenna Gain(dB)	P _{Aq} (dB)	Burst Average EIRP (dBm)	Limit (dBm)	Margin (dB)	Polarization
1851.5	-21.37	3.41	10.24	33.60	19.06	33.01	13.95	V
1882.5	-19.07	3.49	10.24	33.60	21.28	33.01	11.73	V
1913.5	-20.44	3.55	10.23	33.60	19.84	33.01	13.17	V

LTE Band 25_Channel Bandwidth 5MHz_16QAM

Frequency (MHz)	P _{Mea} (dBm)	P _{cl} (dB)	G _a Antenna Gain(dB)	P _{Aq} (dB)	Burst Average EIRP (dBm)	Limit (dBm)	Margin (dB)	Polarization
1852.5	-22.1	3.41	10.24	33.60	18.33	33.01	14.68	V
1882.5	-18.99	3.49	10.24	33.60	21.36	33.01	11.65	V
1912.5	-19.84	3.55	10.23	33.60	20.44	33.01	12.57	V

LTE Band 25_Channel Bandwidth 10MHz_16QAM

Frequency (MHz)	P _{Mea} (dBm)	P _{cl} (dB)	G _a Antenna Gain(dB)	P _{Aq} (dB)	Burst Average EIRP (dBm)	Limit (dBm)	Margin (dB)	Polarization
1855.0	-21.15	3.41	10.24	33.60	19.28	33.01	13.73	V
1882.5	-19.34	3.49	10.24	33.60	21.01	33.01	12	V
1910	-19.05	3.55	10.23	33.60	21.23	33.01	11.78	V

The results shown in this test report refer only to the sample(s) tested unless otherwise stated and the sample(s) are retained for 30 days only. The document is issued by HUAKE, this document cannot be reproduced except in full with our prior written permission. The more details and the authenticity of the report will be confirmed at <http://www.cer-mark.com>.

TEL : +86-755 2302 9901 FAX : +86-755 2302 9901 E-mail : service@cer-mark.com

Add: 1-2F., Building B2, Junfeng Zhongcheng Zhizao Innovation Park, Heping Community, Fuhai Street, Bao'an District, Shenzhen, Guangdong, China



LTE Band 25_Channel Bandwidth 15MHz_16QAM

Frequency (MHz)	P _{Mea} (dBm)	P _{cl} (dB)	G _a Antenna Gain(dB)	P _{Aq} (dB)	Burst Average EIRP (dBm)	Limit (dBm)	Margin (dB)	Polarization
1857.5	-21.12	3.41	10.24	33.60	19.31	33.01	13.7	V
1882.5	-19.22	3.49	10.24	33.60	21.13	33.01	11.88	V
1907.5	-19.89	3.55	10.23	33.60	20.39	33.01	12.62	V

LTE Band 25_Channel Bandwidth 20MHz_16QAM

Frequency (MHz)	P _{Mea} (dBm)	P _{cl} (dB)	G _a Antenna Gain(dB)	P _{Aq} (dB)	Burst Average EIRP (dBm)	Limit (dBm)	Margin (dB)	Polarization
1860.0	-21.4	3.41	10.24	33.60	19.03	33.01	13.98	V
1882.5	-18.73	3.49	10.24	33.60	21.62	33.01	11.39	V
1905	-19.76	3.55	10.23	33.60	20.52	33.01	12.49	V

The results shown in this test report refer only to the sample(s) tested unless otherwise stated and the sample(s) are retained for 30 days only. The document is issued by HUAK, this document cannot be reproduced except in full with our prior written permission. The more details and the authenticity of the report will be confirmed at <http://www.cer-mark.com>.

TEL : +86-755 2302 9901 FAX : +86-755 2302 9901 E-mail : service@cer-mark.com

Add: 1-2F., Building B2, Junfeng Zhongcheng Zhizao Innovation Park, Heping Community, Fuhai Street, Bao'an District, Shenzhen, Guangdong, China



4.2 Peak-to-Average Ratio (PAR)

LIMIT

The Peak-to-Average Ratio (PAR) of the transmission may not exceed 13 dB.

TEST CONFIGURATION

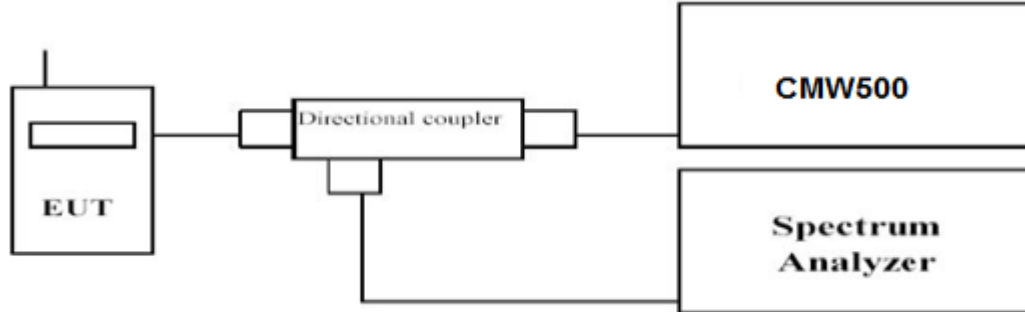

TEST PROCEDURE

1. Refer to instrument's analyzer instruction manual for details on how to use the power statistics/CCDF function;
2. Set resolution/measurement bandwidth \geq signal's occupied bandwidth;
3. Set the number of counts to a value that stabilizes the measured CCDF curve;
4. Set the measurement interval as follows:
 - 1). for continuous transmissions, set to 1 ms,
 - 2). for burst transmissions, employ an external trigger that is synchronized with the EUT burst timing sequence, or use the internal burst trigger with a trigger level that allows the burst to stabilize and set the measurement interval to a time that is less than or equal to the burst duration.
5. Record the maximum PAPR level associated with a probability of 0.1%.

TEST RESULTS

Remark:

1. We measured all RB Configuration refer 3GPP TS136 521 for each Channel Bandwidth of LTE Band 25; recorded worst case for each Channel Bandwidth of LTE Band 25.

LTE Band 25				
TX Channel Bandwidth	Frequency (MHz)	RB Size/Offset	PAPR(dB)	
			QPSK	16QAM
1.4 MHz	1850.7	1RB#0	4.86	5.59
	1882.5		4.85	8.45
	1914.3		8.16	0.26
3 MHz	1851.5	1RB#0	4.98	8.50
	1882.5		4.75	8.50
	1913.5		5.28	8.45
5 MHz	1852.5	1RB#0	5.49	8.51
	1882.5		4.77	8.46
	1912.5		5.22	8.45
10 MHz	1855.0	1RB#0	5.27	8.49
	1882.5		4.84	9.44
	1910		3.94	8.51
15 MHz	1857.5	1RB#0	8.50	6.13
	1882.5		4.68	8.46
	1907.5		8.47	4.99
20 MHz	1860.0	1RB#0	4.97	9.14
	1882.5		8.28	5.32
	1905		4.60	8.49

The results shown in this test report refer only to the sample(s) tested unless otherwise stated and the sample(s) are retained for 30 days only. The document is issued by HUAK, this document cannot be reproduced except in full with our prior written permission. The more details and the authenticity of the report will be confirmed at <http://www.cer-mark.com>.



LTE Band 25 – 1.4 MHz Channel Bandwidth PAPR

QPSK

16QAM

Low Channel

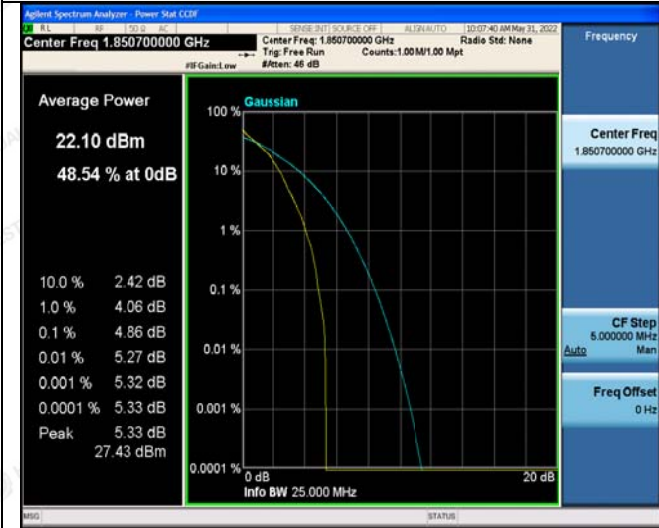

1RB#0

1RB#0

Middle Channel



1RB#0

1RB#0

High Channel

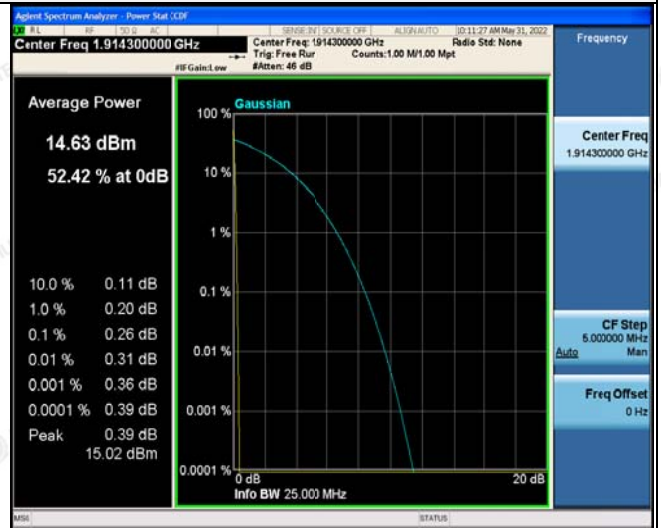

1RB#0

1RB#0

The results shown in this test report refer only to the sample(s) tested unless otherwise stated and the sample(s) are retained for 30 days only. This document is issued by HUAJ, this document cannot be reproduced except in full with our prior written permission. The more details and the authenticity of the report will be confirmed at <http://www.cer-mark.com>.

TEL : +86-755 2302 9901 FAX : +86-755 2302 9901 E-mail : service@cer-mark.com

Add: 1-2F., Building B2, Junfeng Zhongcheng Zhizao Innovation Park, Heping Community, Fuhai Street, Bao'an District, Shenzhen, Guangdong, China



LTE Band 25-3MHz Channel Bandwidth PAPP

QPSK

16QAM

Low Channel



1RB#0

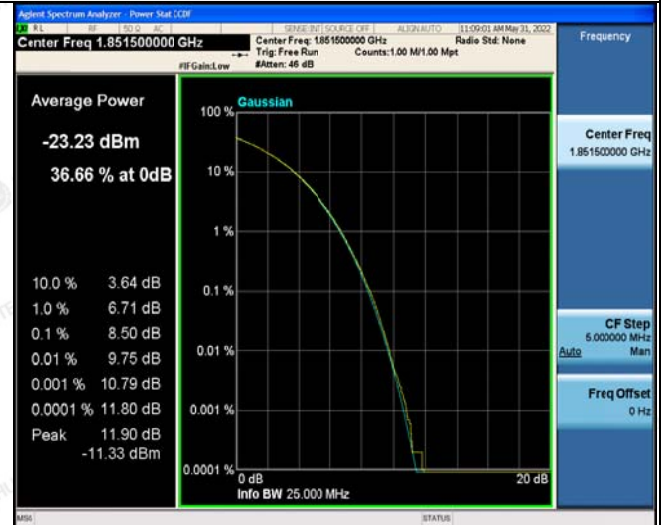

1RB#0

Middle Channel



1RB#0



1RB#0

High Channel



1RB#0



1RB#0

The results shown in this test report refer only to the sample(s) tested unless otherwise stated and the sample(s) are retained for 30 days only. The document is issued by HUAJ, this document cannot be reproduced except in full with our prior written permission. The more details and the authenticity of the report will be confirmed at http://www.cer-mark.com.

TEL : +86-755 2302 9901 FAX : +86-755 2302 9901 E-mail : service@cer-mark.com

Add: 1-2F., Building B2, Junfeng Zhongcheng Zhizao Innovation Park, Heping Community, Fuhai Street, Bao'an District, Shenzhen, Guangdong, China



LTE Band 25-5MHz Channel Bandwidth PAPP

QPSK

16QAM

Low Channel

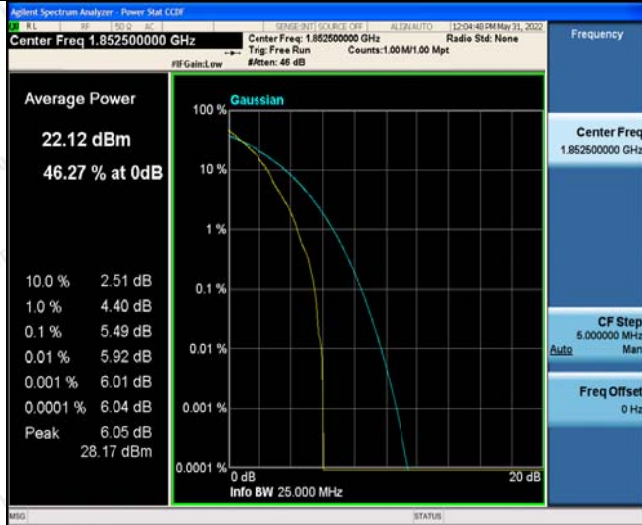

1RB#0



1RB#0

Middle Channel



1RB#0



1RB#0

High Channel



1RB#0



1RB#0

The results shown in this test report refer only to the sample(s) tested unless otherwise stated and the sample(s) are retained for 30 days only. The document is issued by HUAJ, this document cannot be reproduced except in full with our prior written permission. The more details and the authenticity of the report will be confirmed at http://www.cer-mark.com.

TEL : +86-755 2302 9901 FAX : +86-755 2302 9901 E-mail : service@cer-mark.com

Add: 1-2F., Building B2, Junfeng Zhongcheng Zhizao Innovation Park, Heping Community, Fuhai Street, Bao'an District, Shenzhen, Guangdong, China



LTE Band 25-10MHz Channel BandwidthPAPR

QPSK

16QAM

Low Channel



1RB#0

1RB#0

Middle Channel



1RB#0

1RB#0

High Channel

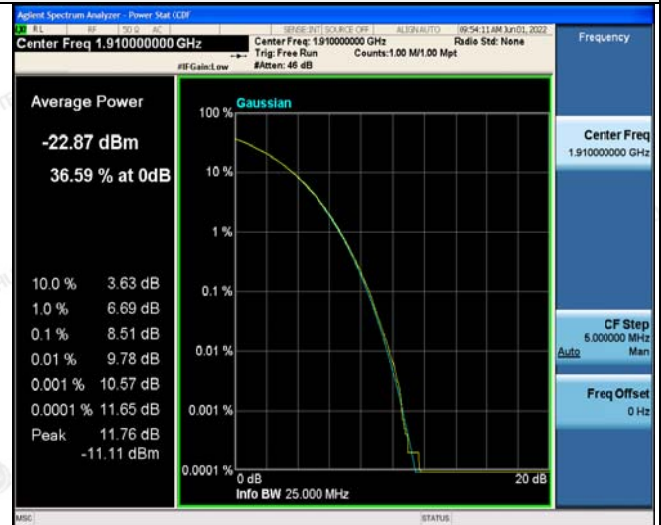

1RB#0

1RB#0

The results shown in this test report refer only to the sample(s) tested unless otherwise stated and the sample(s) are retained for 30 days only. The document is issued by HUAJ, this document cannot be reproduced except in full with our prior written permission. The more details and the authenticity of the report will be confirmed at http://www.cer-mark.com.

TEL : +86-755 2302 9901 FAX : +86-755 2302 9901 E-mail : service@cer-mark.com

Add: 1-2F., Building B2, Junfeng Zhongcheng Zhizao Innovation Park, Heping Community, Fuhai Street, Bao'an District, Shenzhen, Guangdong, China



LTE Band 25- 15 MHz Channel BandwidthPAPR

QPSK

16QAM

Low Channel

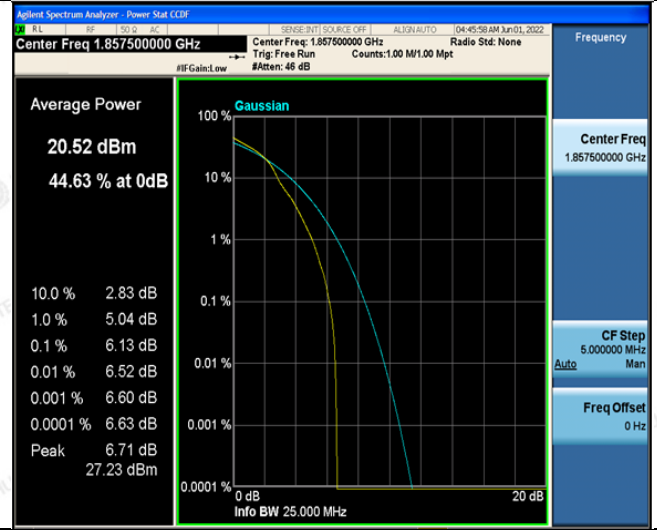
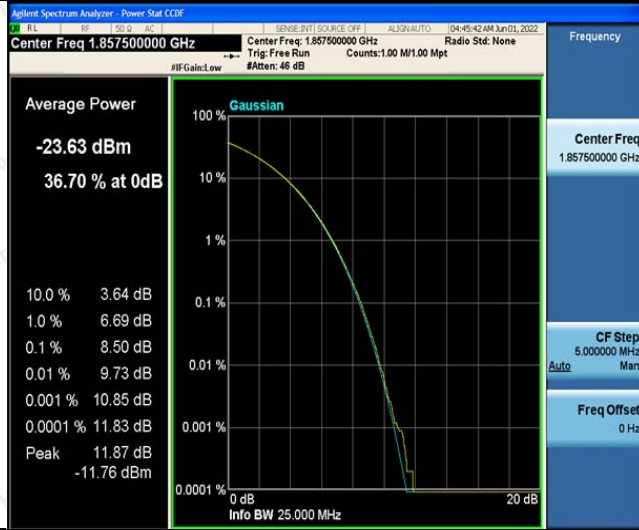

1RB#0

1RB#0

Middle Channel

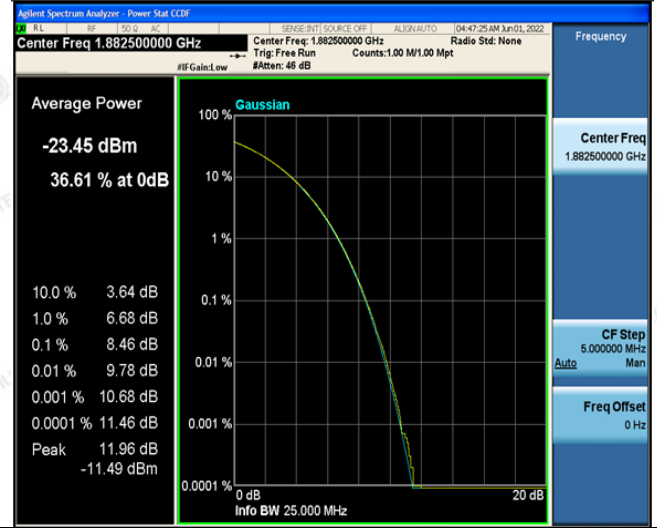

1RB#0

1RB#0

High Channel

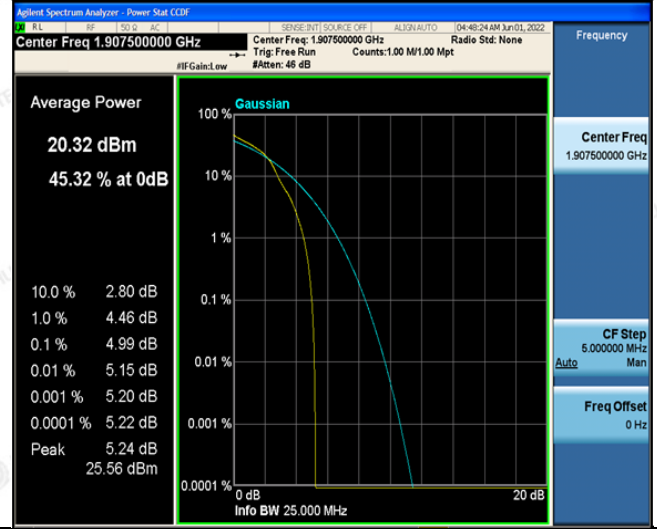
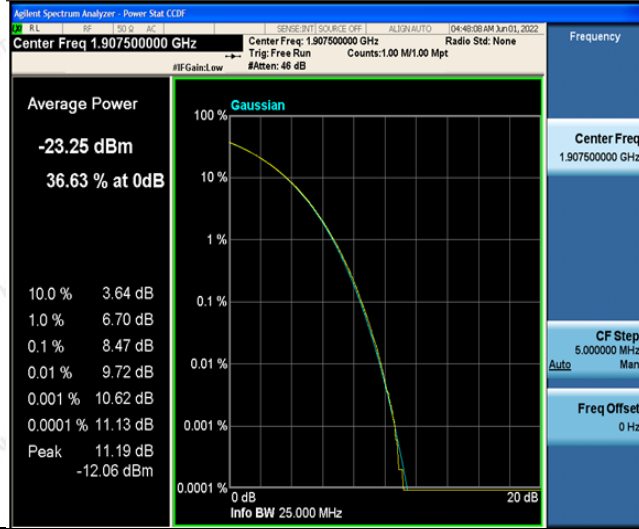

1RB#0

1RB#0

The results shown in this test report refer only to the sample(s) tested unless otherwise stated and the sample(s) are retained for 30 days only. The document is issued by HUAJ, this document cannot be reproduced except in full with our prior written permission. The more details and the authenticity of the report will be confirmed at http://www.cer-mark.com.

TEL : +86-755 2302 9901 FAX : +86-755 2302 9901 E-mail : service@cer-mark.com

Add: 1-2F., Building B2, Junfeng Zhongcheng Zhizao Innovation Park, Heping Community, Fuhai Street, Bao'an District, Shenzhen, Guangdong, China



LTE Band 25-20MHz Channel BandwidthPAPR

QPSK

16QAM

Low Channel



1RB#0

1RB#0

Middle Channel

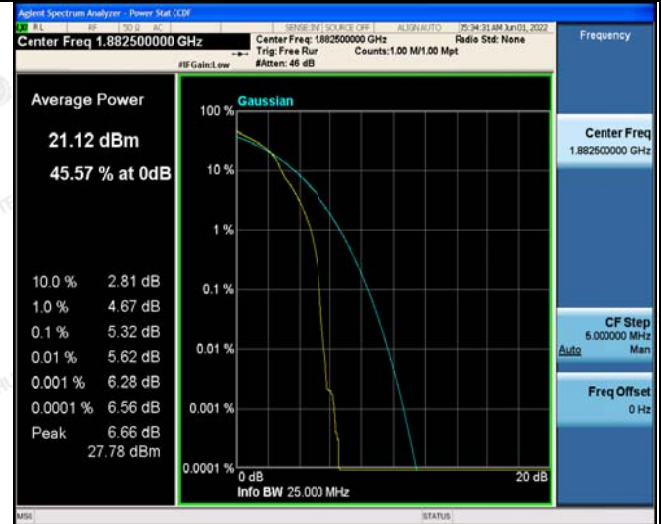

1RB#0

1RB#0

High Channel



1RB#0

1RB#0

The results shown in this test report refer only to the sample(s) tested unless otherwise stated and the sample(s) are retained for 30 days only. The document is issued by HUAJ, this document cannot be reproduced except in full with our prior written permission. The more details and the authenticity of the report will be confirmed at http://www.cer-mark.com.

TEL : +86-755 2302 9901 FAX : +86-755 2302 9901 E-mail : service@cer-mark.com

Add: 1-2F., Building B2, Junfeng Zhongcheng Zhizao Innovation Park, Heping Community, Fuhai Street, Bao'an District, Shenzhen, Guangdong, China

4.3 Occupied Bandwidth and Emission Bandwidth

LIMIT

N/A

TEST CONFIGURATION

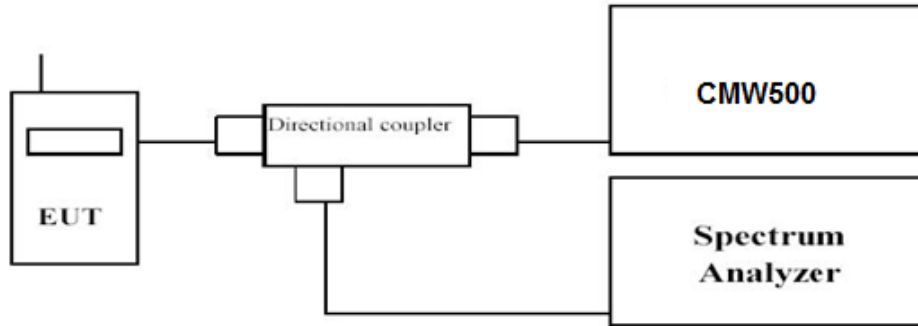

TEST PROCEDURE

The transmitter output was connected to a calibrated coaxial cable and coupler, the other end of which was connected to a spectrum analyzer. The occupied bandwidth was measured with the spectrum analyzer at low, middle and high channel in each band. The -26dBc Emission bandwidth was also measured and recorded. Set RBW was set to about 1% of emission BW, VBW ≥ 3 times RBW. -26dBc display line was placed on the screen (or 99% bandwidth), the occupied bandwidth is the delta frequency between the two points where the display line intersects the signal trace.

TEST RESULTS

Remark:

1. We were tested all RB Configuration refer 3GPP TS136 521 for each Channel Bandwidth of LTE Band 25; recorded worst case for each Channel Bandwidth of LTE Band 25.

LTE Band 25						
TX Channel Bandwidth	RB Size/Offset	Frequency (MHz)	-26dBc Emission bandwidth (MHz)		99% Occupied bandwidth (MHz)	
			QPSK	16QAM	QPSK	16QAM
1.4 MHz	6RB#0	1850.7	1.245	1.250	1.0892	1.1013
		1882.5	1.246	1.247	1.0945	1.0992
		1914.3	1.343	1.730	1.1043	1.1133
3 MHz	15RB#0	1851.5	3.032	3.005	2.7148	2.7055
		1882.5	3.020	3.014	2.7120	2.7009
		1913.5	3.030	3.036	2.7145	2.7028
5 MHz	25RB#0	1852.5	4.986	4.951	4.5024	4.5024
		1882.5	4.975	4.969	4.5044	4.4975
		1912.5	4.995	4.996	4.5166	4.5368
10 MHz	50RB#0	1855.0	9.921	9.943	9.0008	8.9933
		1882.5	9.877	9.886	8.9923	8.9904
		1910	9.841	9.913	9.0069	9.0071
15 MHz	75RB#0	1857.5	14.96	14.95	13.541	13.531
		1882.5	14.92	14.74	13.465	13.443
		1907.5	14.83	14.78	13.435	13.446
20 MHz	100RB#0	1860.0	19.72	19.71	18.097	18.102
		1882.5	19.68	19.38	17.991	17.922
		1905	19.32	19.51	17.866	17.909

The results shown in this test report refer only to the sample(s) tested unless otherwise stated and the sample(s) are retained for 30 days only. The document is issued by HUAKE, this document cannot be reproduced except in full with our prior written permission. The more details and the authenticity of the report will be confirmed at <http://www.cer-mark.com>.



LTE Band 25 – 1.4 MHz Channel Bandwidth Occupied Bandwidth and Emission Bandwidth

QPSK

16QAM

Low Channel

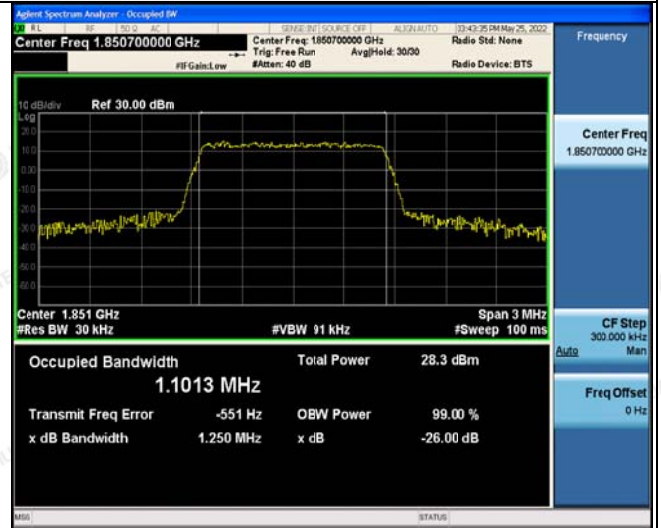

6RB#0

6RB#0

Middle Channel

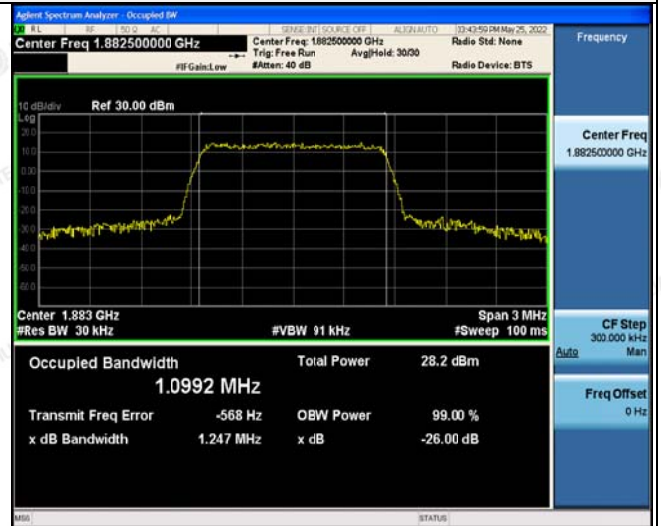
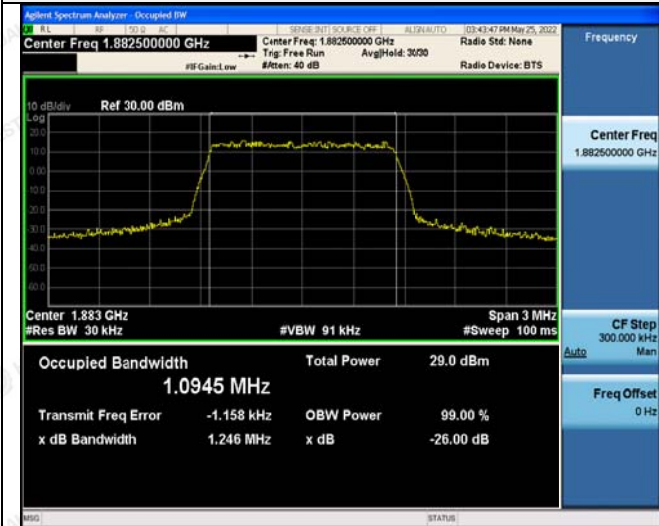

6RB#0

6RB#0

High Channel

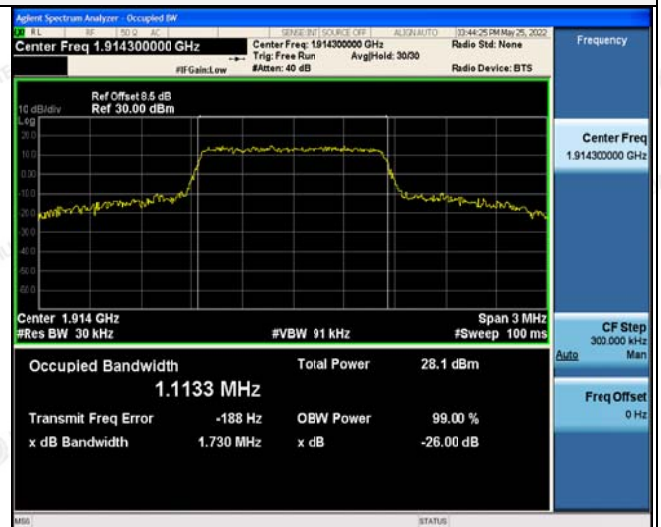
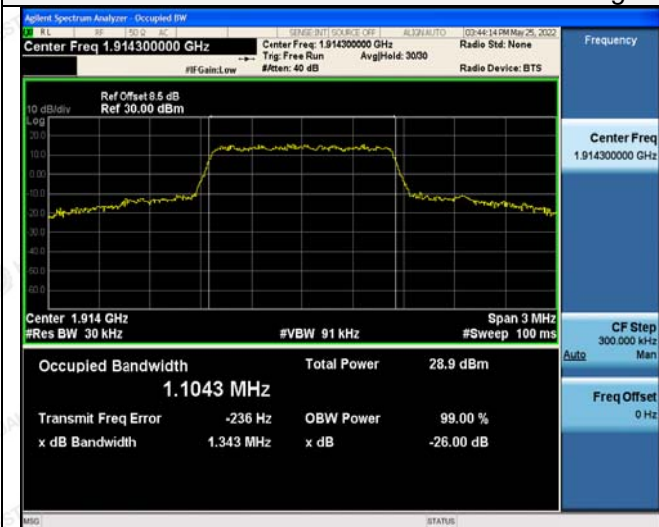

6RB#0

6RB#0

The results shown in this test report refer only to the sample(s) tested unless otherwise stated and the sample(s) are retained for 30 days only. The document is issued by HUAJ, this document cannot be reproduced except in full with our prior written permission. The more details and the authenticity of the report will be confirmed at <http://www.cer-mark.com>.

TEL : +86-755 2302 9901 FAX : +86-755 2302 9901 E-mail : service@cer-mark.com

Add: 1-2F., Building B2, Junfeng Zhongcheng Zhizao Innovation Park, Heping Community, Fuhai Street, Bao'an District, Shenzhen, Guangdong, China



LTE Band 25-3MHz Channel Bandwidth Occupied Bandwidth and Emission Bandwidth

QPSK

16QAM

Low Channel

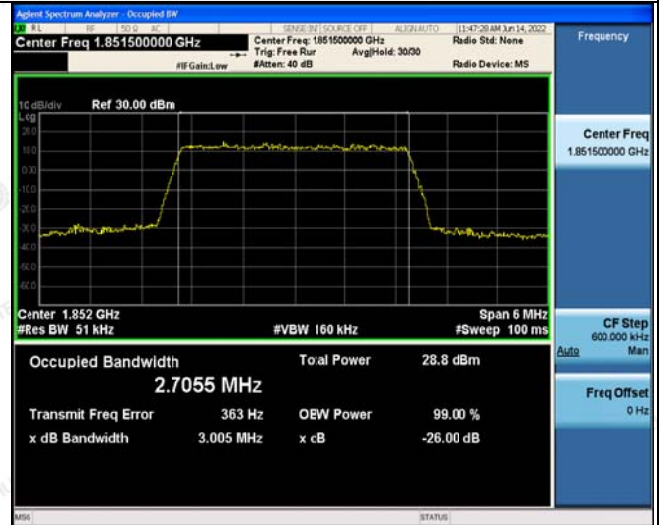
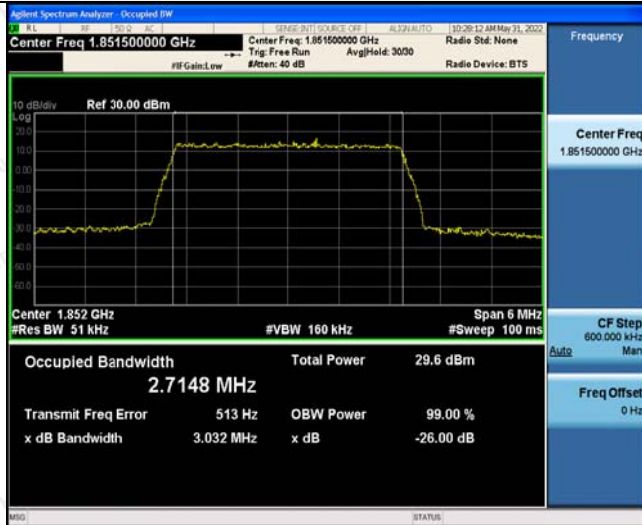

15RB#0

15RB#0

Middle Channel

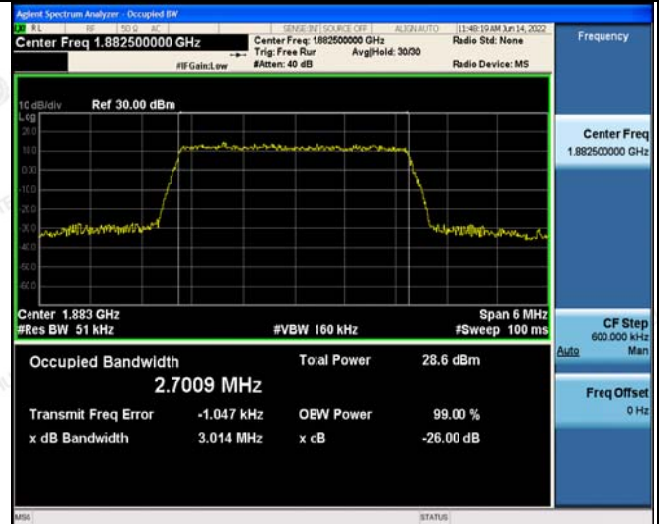
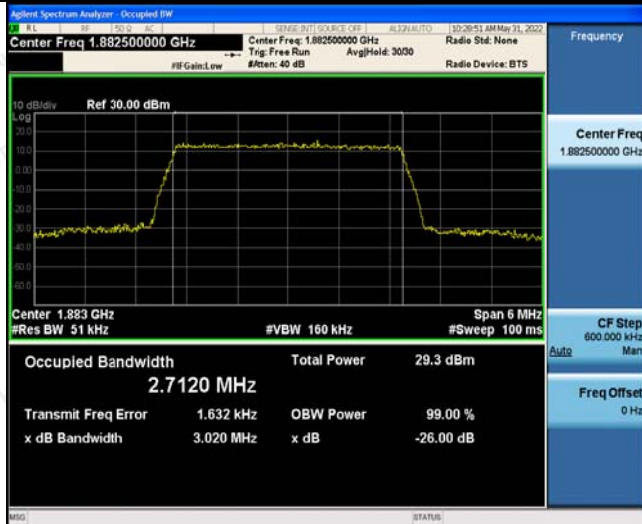

15RB#0

15RB#0

High Channel

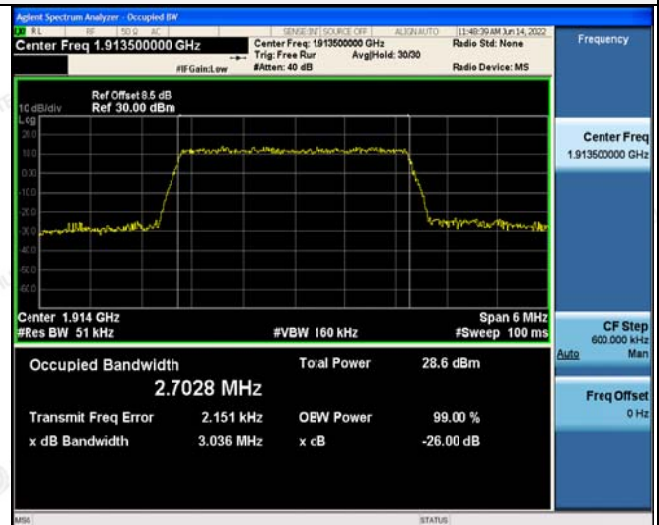
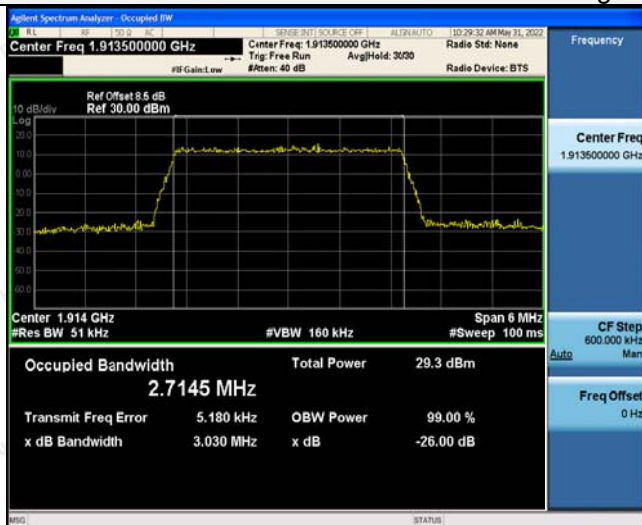

15RB#0

15RB#0

The results shown in this test report refer only to the sample(s) tested unless otherwise stated and the sample(s) are retained for 30 days only. This document is issued by HUAJ, this document cannot be reproduced except in full with our prior written permission. The more details and the authenticity of the report will be confirmed at <http://www.cer-mark.com>.

TEL : +86-755 2302 9901 FAX : +86-755 2302 9901 E-mail : service@cer-mark.com

Add: 1-2F., Building B2, Junfeng Zhongcheng Zhizao Innovation Park, Heping Community, Fuhai Street, Bao'an District, Shenzhen, Guangdong, China



LTE Band 25-5MHz Channel Bandwidth Occupied Bandwidth and Emission Bandwidth

QPSK

16QAM

Low Channel

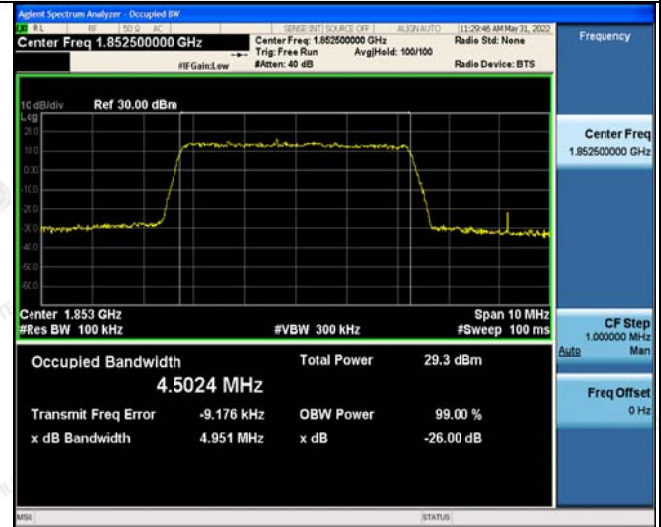

25RB#0

25RB#0

Middle Channel

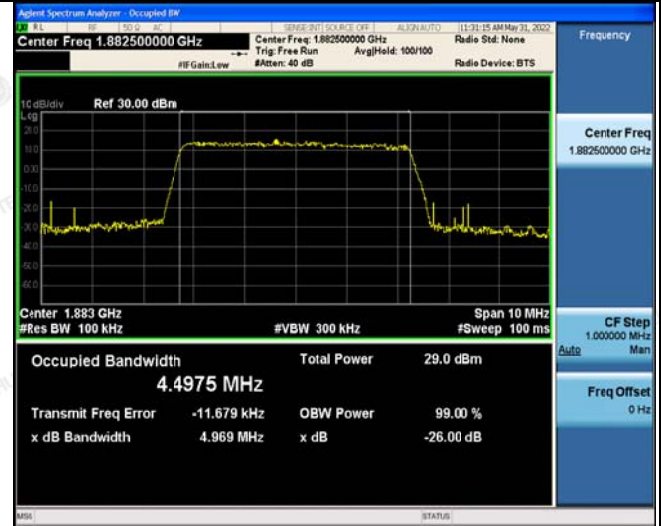
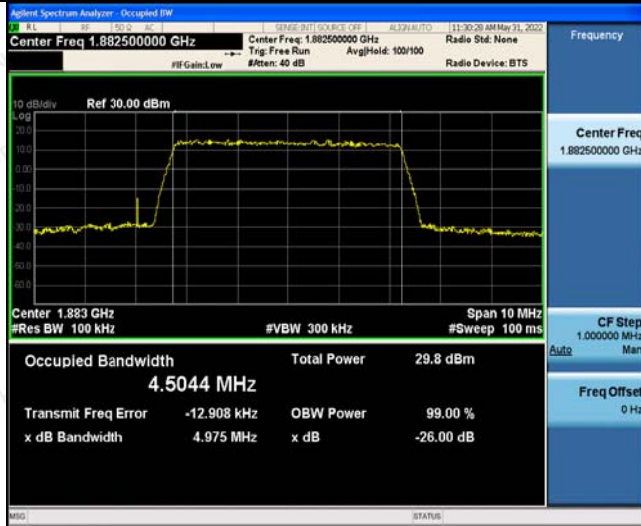

25RB#0

25RB#0

High Channel

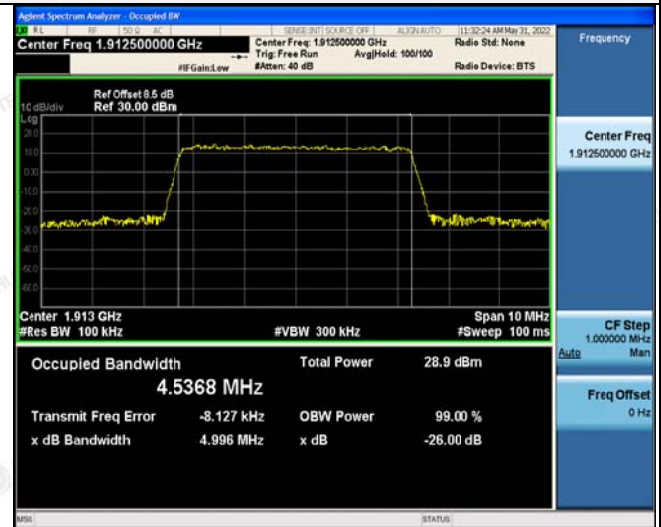
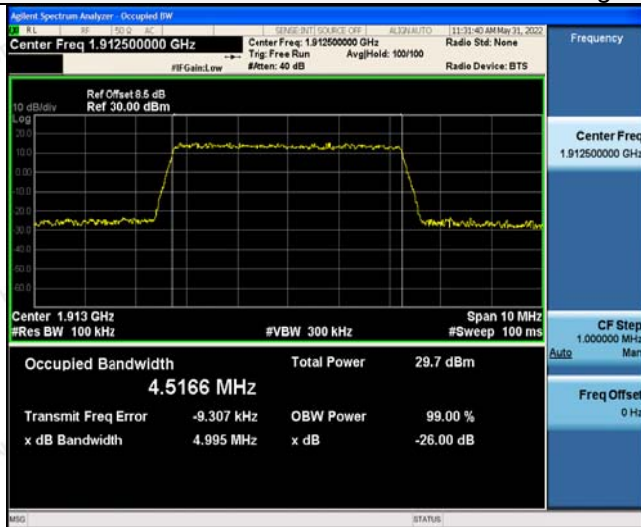

25RB#0

25RB#0

The results shown in this test report refer only to the sample(s) tested unless otherwise stated and the sample(s) are retained for 30 days only. This document is issued by HUAJ, this document cannot be reproduced except in full with our prior written permission. The more details and the authenticity of the report will be confirmed at http://www.cer-mark.com.

TEL : +86-755 2302 9901 FAX : +86-755 2302 9901 E-mail : service@cer-mark.com

Add: 1-2F., Building B2, Junfeng Zhongcheng Zhizao Innovation Park, Heping Community, Fuhai Street, Bao'an District, Shenzhen, Guangdong, China



LTE Band 25-10MHz Channel Bandwidth Occupied Bandwidth and Emission Bandwidth

QPSK

16QAM

Low Channel

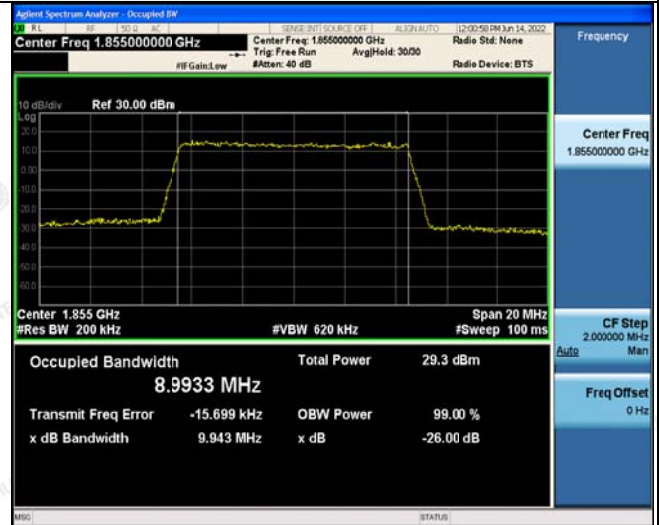
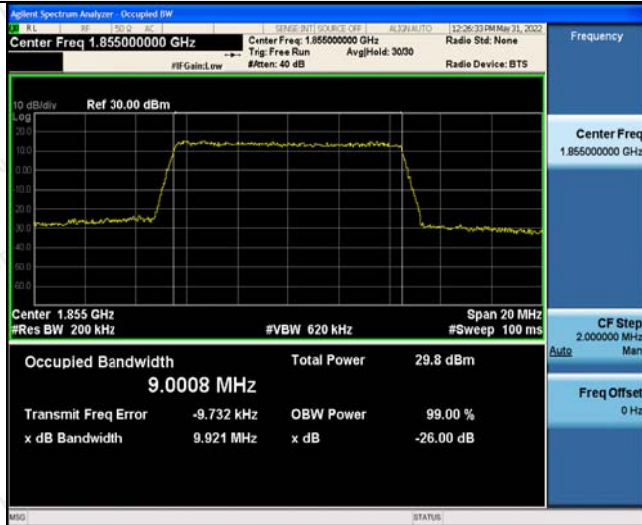

50RB#0

50RB#0

Middle Channel

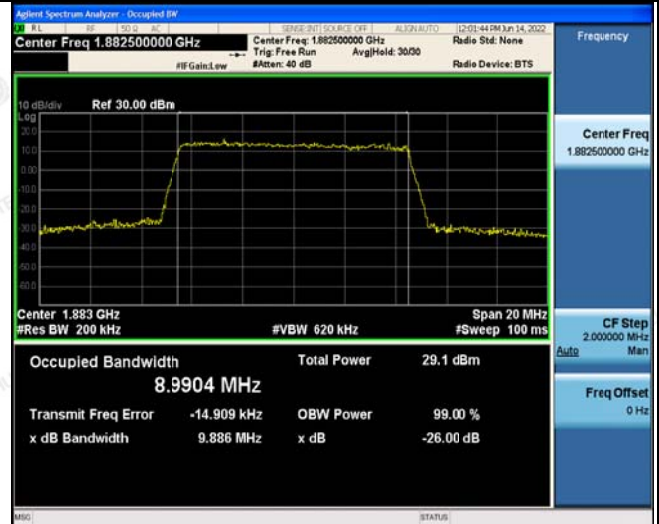

50RB#0

50RB#0

High Channel

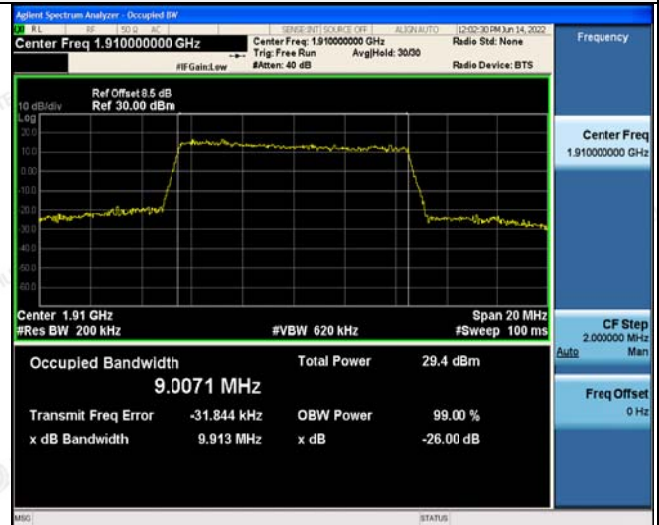
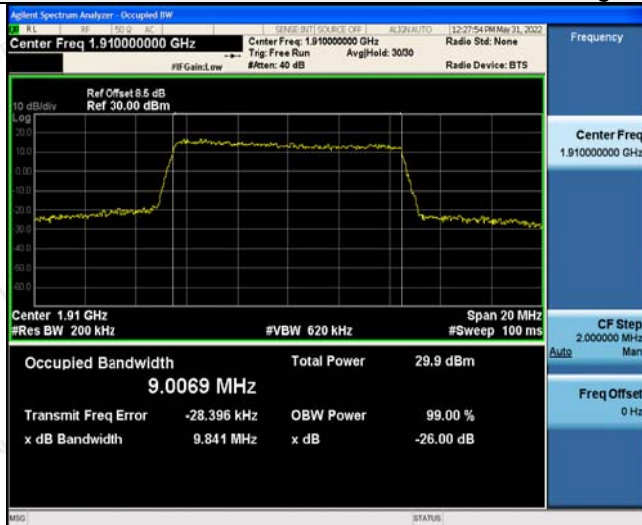

50RB#0

50RB#0

The results shown in this test report refer only to the sample(s) tested unless otherwise stated and the sample(s) are retained for 30 days only. This document is issued by HUAJ, this document cannot be reproduced except in full with our prior written permission. The more details and the authenticity of the report will be confirmed at http://www.cer-mark.com.

TEL : +86-755 2302 9901 FAX : +86-755 2302 9901 E-mail : service@cer-mark.com

Add: 1-2F., Building B2, Junfeng Zhongcheng Zhizao Innovation Park, Heping Community, Fuhai Street, Bao'an District, Shenzhen, Guangdong, China



LTE Band 25-15MHz Channel Bandwidth Occupied Bandwidth and Emission Bandwidth

QPSK

16QAM

Low Channel

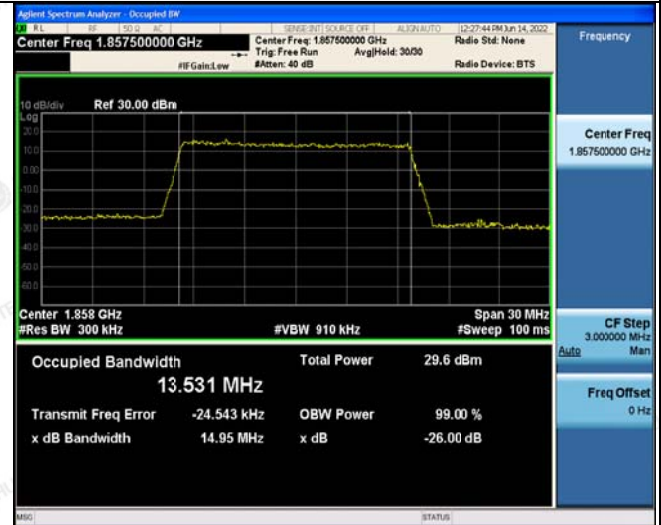
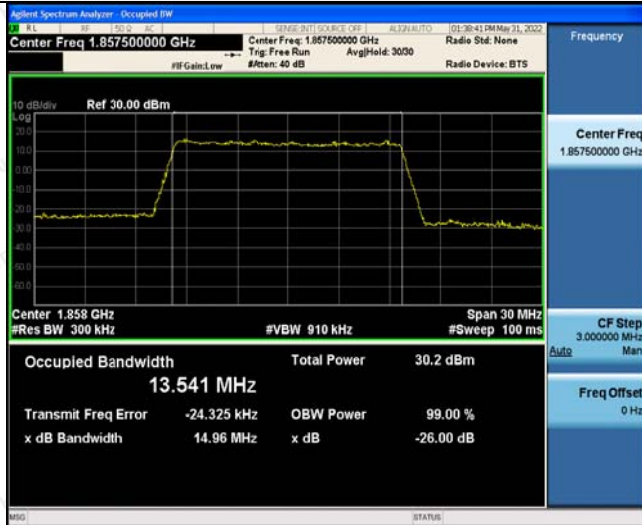

75RB#0

75RB#0

Middle Channel

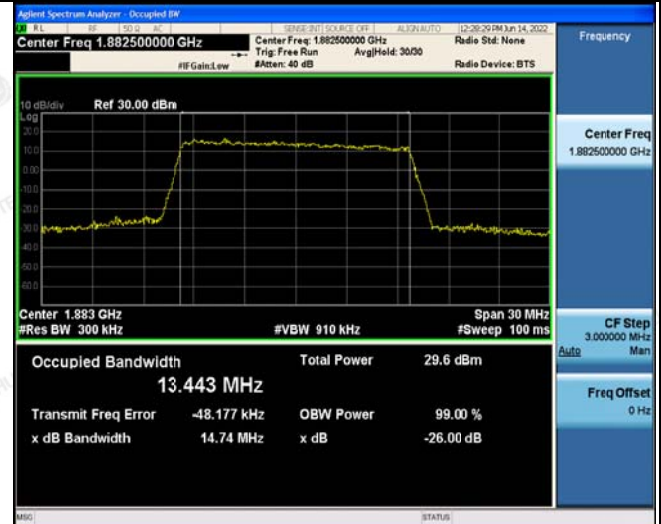
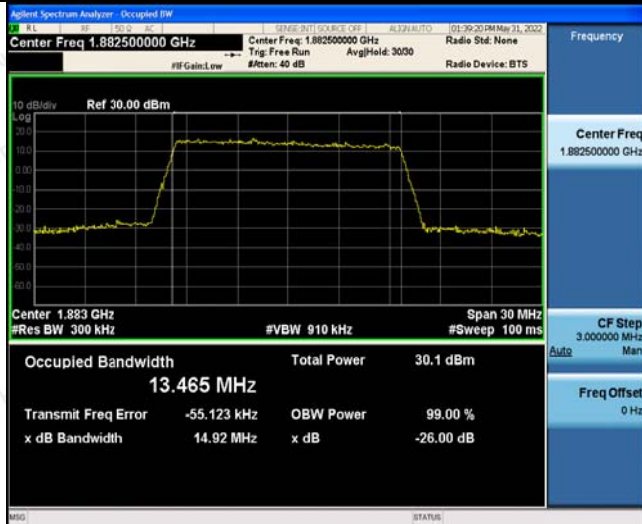

75RB#0

75RB#0

High Channel

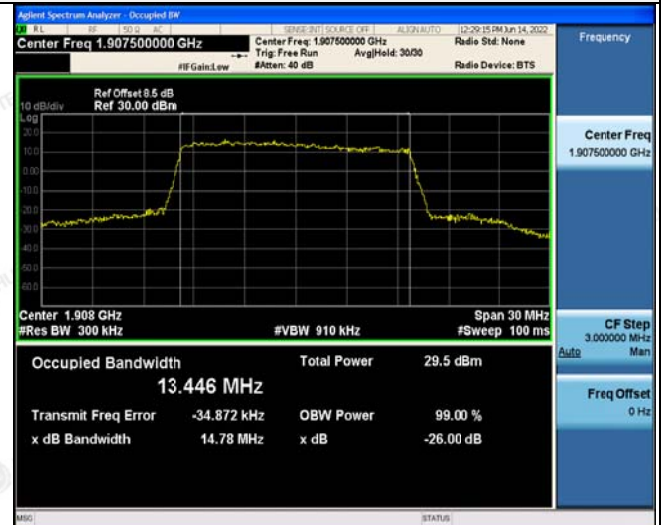
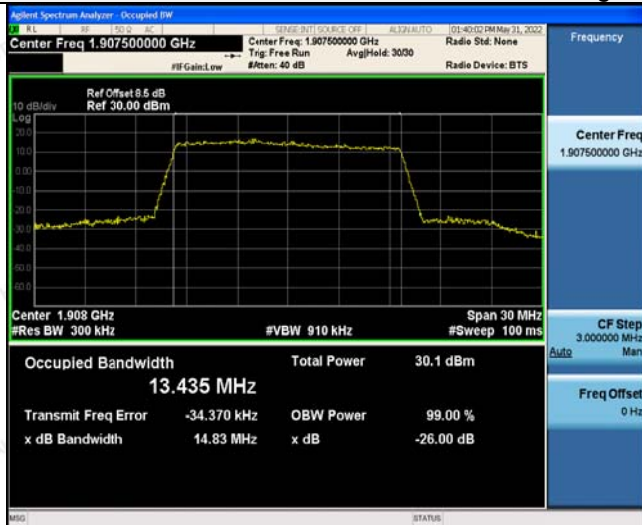

75RB#0

75RB#0

The results shown in this test report refer only to the sample(s) tested unless otherwise stated and the sample(s) are retained for 30 days only. This document is issued by HUAJ, this document cannot be reproduced except in full with our prior written permission. The more details and the authenticity of the report will be confirmed at http://www.cer-mark.com.

TEL : +86-755 2302 9901 FAX : +86-755 2302 9901 E-mail : service@cer-mark.com

Add: 1-2F., Building B2, Junfeng Zhongcheng Zhizao Innovation Park, Heping Community, Fuhai Street, Bao'an District, Shenzhen, Guangdong, China



LTE Band 25-20MHz Channel Bandwidth Occupied Bandwidth and Emission Bandwidth

QPSK

16QAM

Low Channel

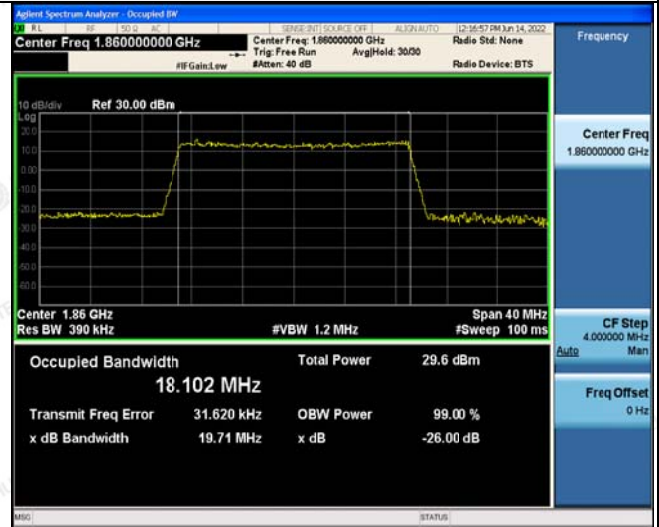
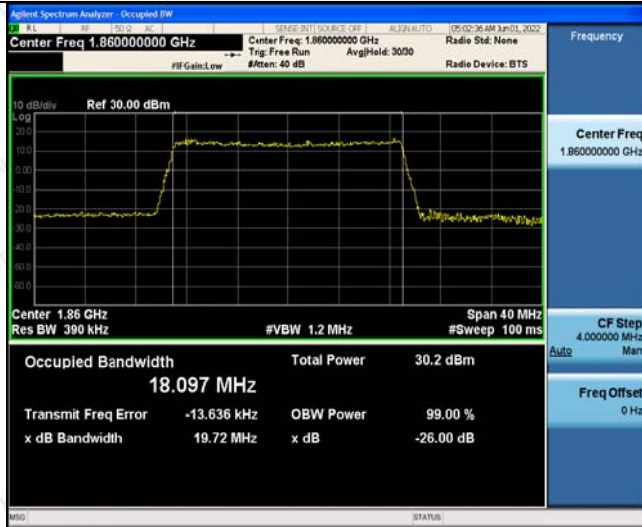

100RB#0

100RB#0

Middle Channel

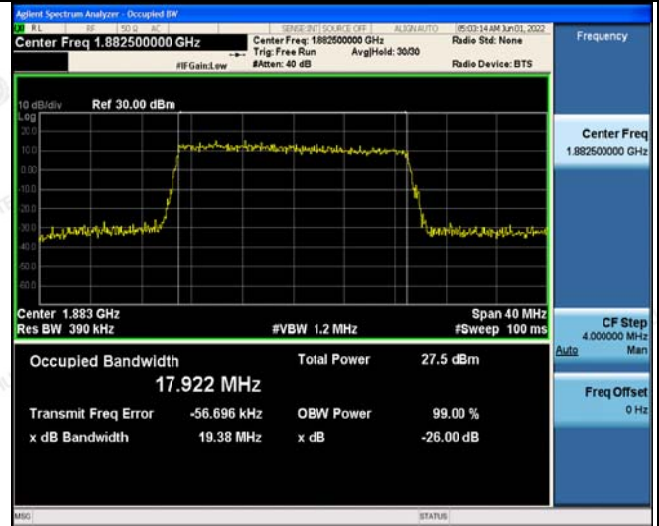
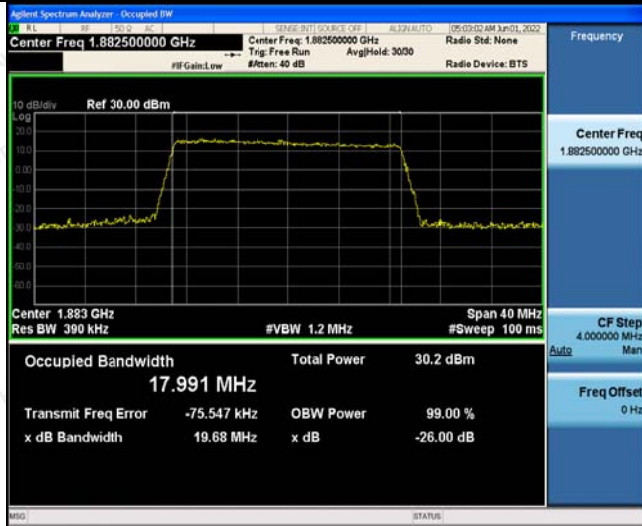

100RB#0

100RB#0

High Channel



100RB#0

100RB#0

The results shown in this test report refer only to the sample(s) tested unless otherwise stated and the sample(s) are retained for 30 days only. This document is issued by HUAJ, this document cannot be reproduced except in full with our prior written permission. The more details and the authenticity of the report will be confirmed at http://www.cer-mark.com.

TEL : +86-755 2302 9901 FAX : +86-755 2302 9901 E-mail : service@cer-mark.com

Add: 1-2F., Building B2, Junfeng Zhongcheng Zhizao Innovation Park, Heping Community, Fuhai Street, Bao'an District, Shenzhen, Guangdong, China