

# HOV-1

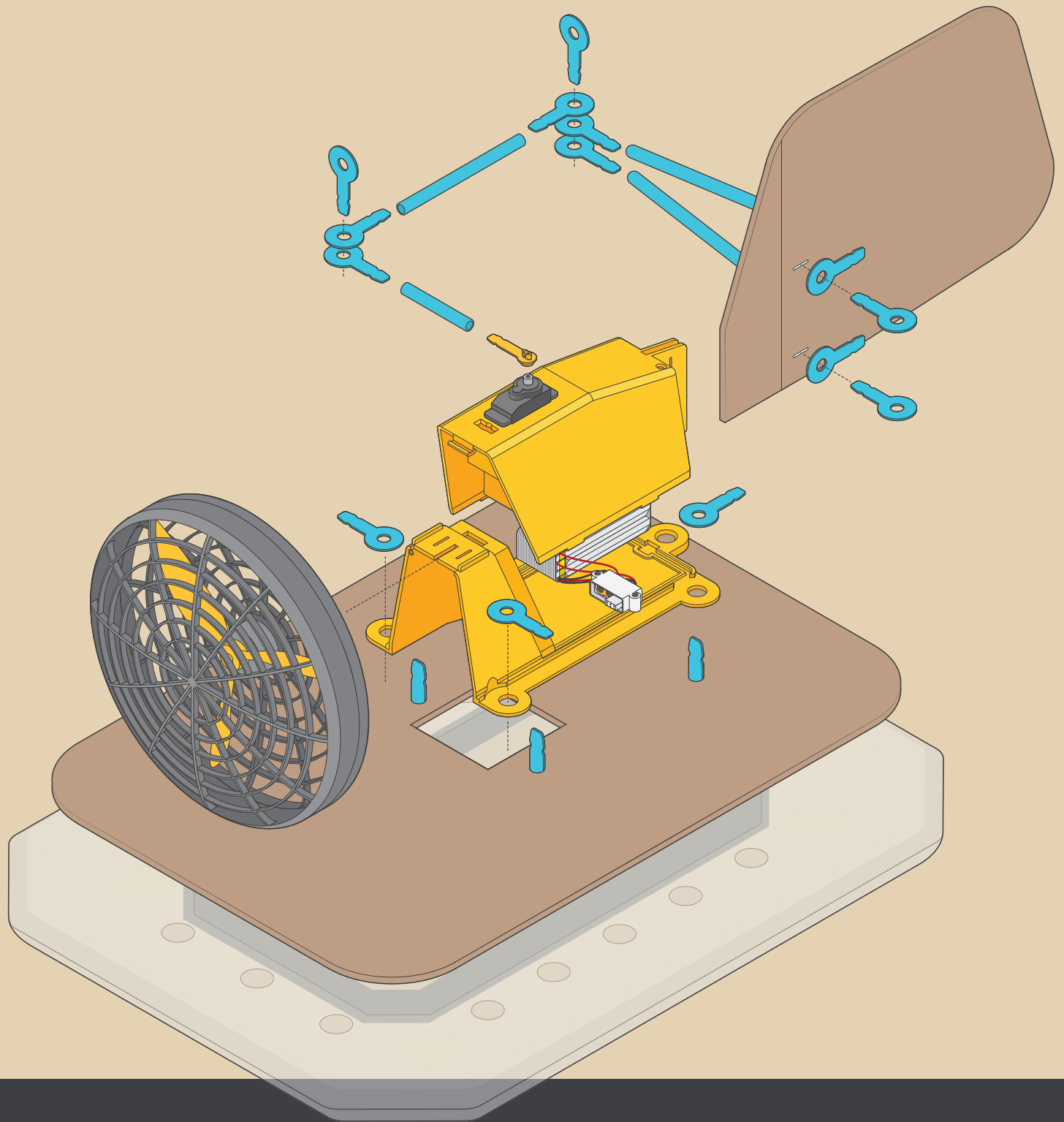

**HOVERCRAFT**



**ASSEMBLY INSTRUCTION BOOKLET**

# ASSEMBLY MATERIAL

## Motor Pod Assembly

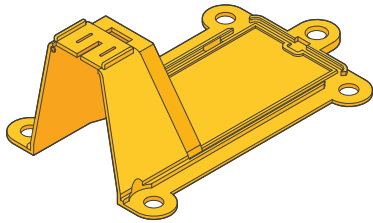

Air Duct

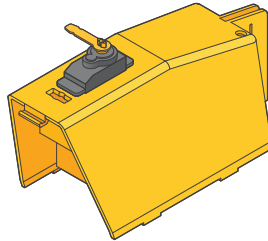

Cover with Electronic Parts

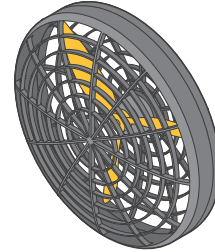

Fan

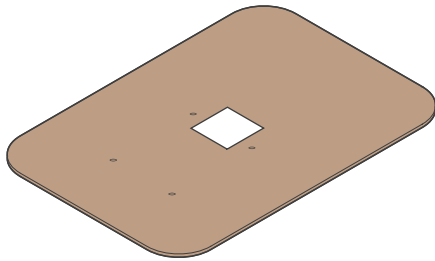

Die Cut Base

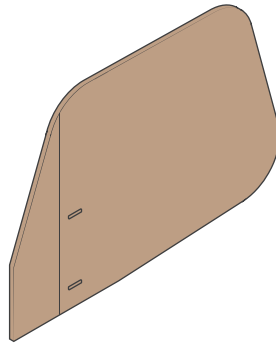

Die Cut Fin

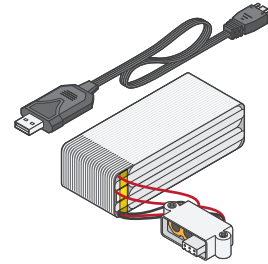

Battery with USB Charging Cable



×40

Strawbees Connectors

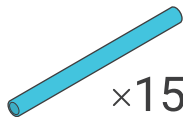

×15

Construction Pipes

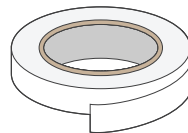

Double Sided Tape

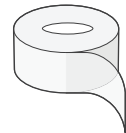

Single Sided Tape

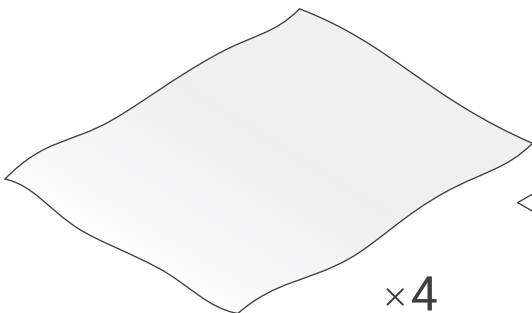

×4

Plastic Sheets

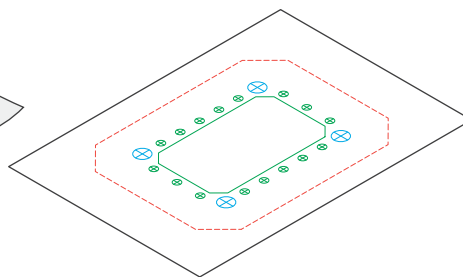

Skirt Template

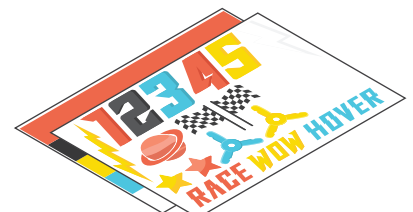

Stickers

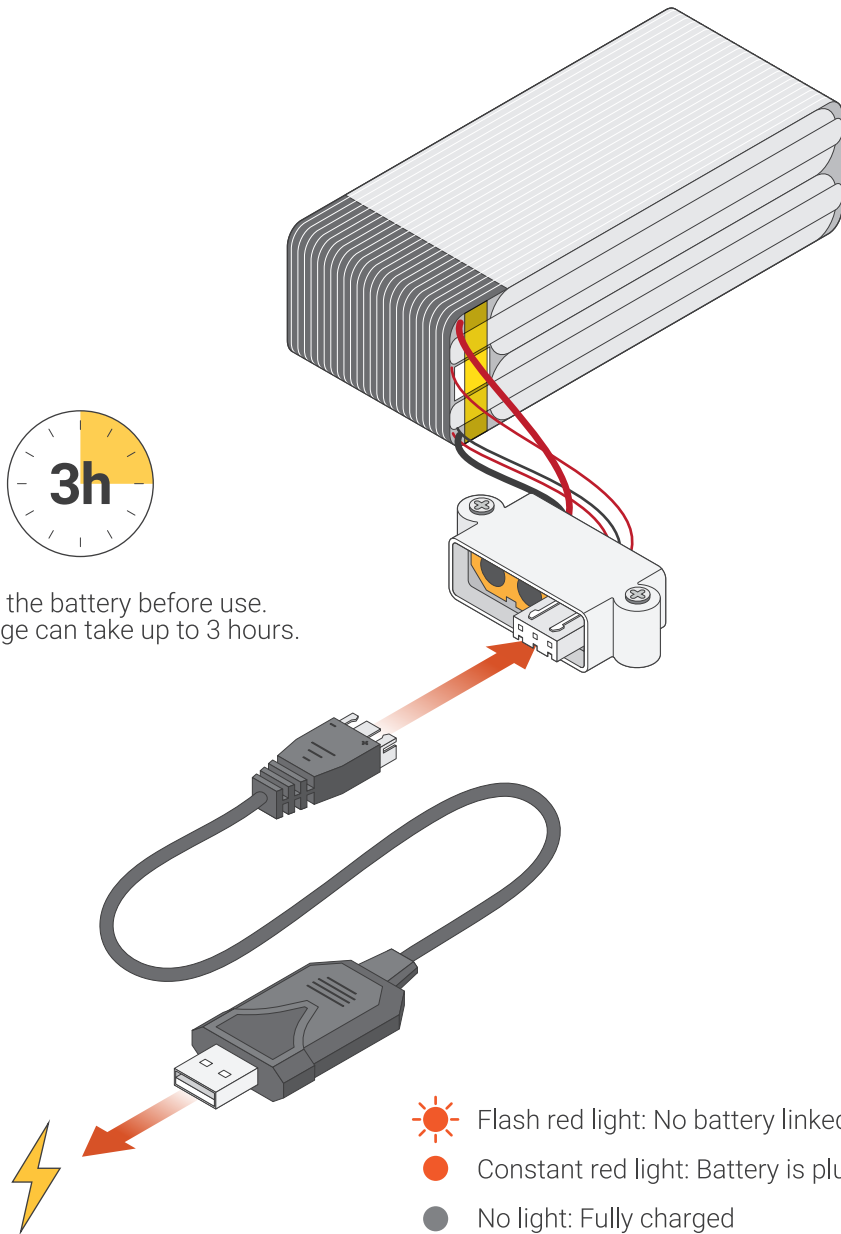

# SKIRT MAKING

- 1 Place the plastic sheet on top of the template.

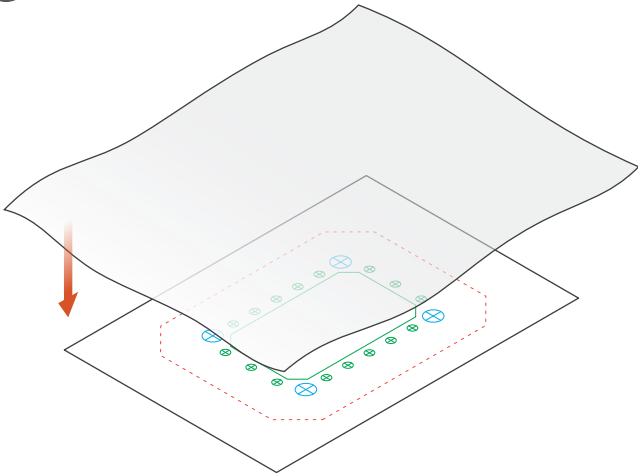

- 2 Trace the green lines(Line 1) and red line(Line 2) on the plastic sheet with a marker.

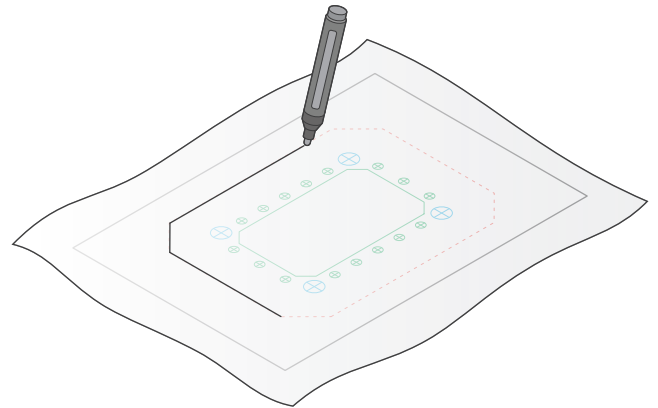

- 3 Remove template and set aside. Cut out the traced green holes and large center hole(Green Line 1).

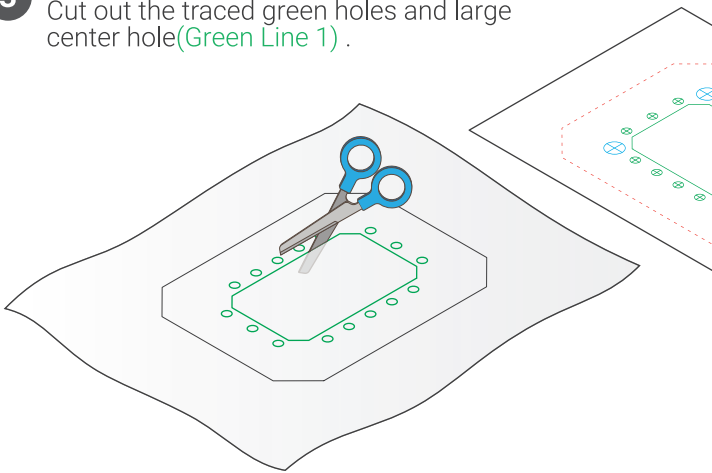

- 4 Stick double sided tape just outside the traced red line(Red Line 2).

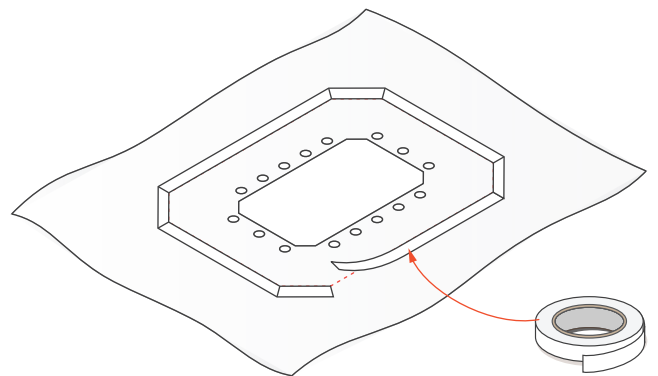

- 5 Peel the protective backing from the double sided tape. Make sure the sheet is flat and carefully place the second plastic sheet on top.

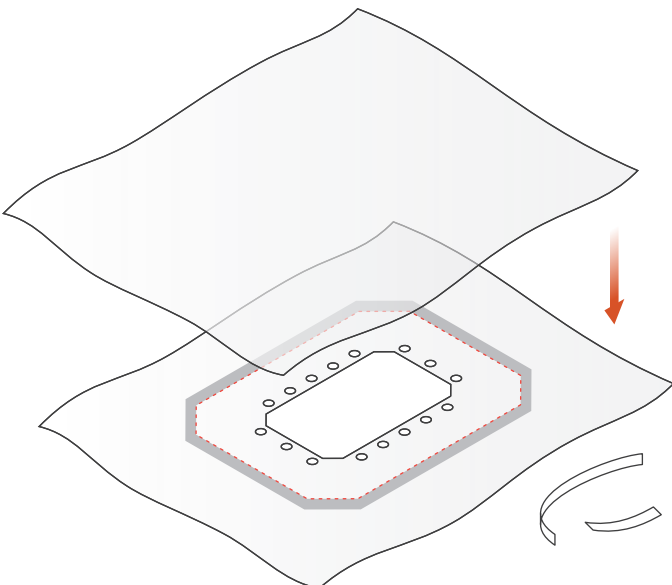

- 6 Cut along the outer edge of the tape and remove edges.

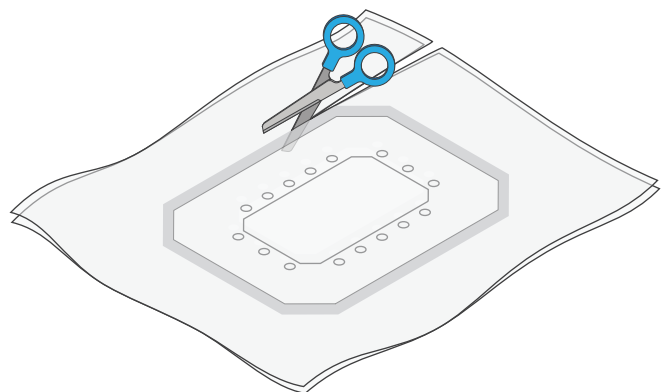

- 7 With the center hole still **facing down** place the taped sheets over the template again.

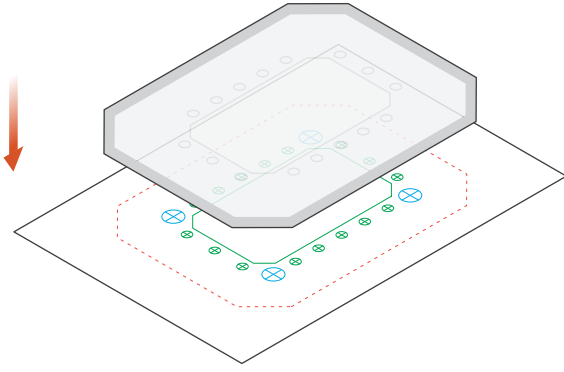

- 8 Trace the **blue holes**(Line 3) and cut them out from the **uncut plastic sheet side**. Be careful **NOT** to cut through both sheets!

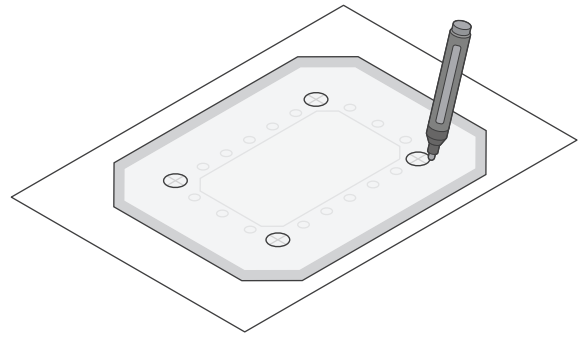

- 9 Turn the skirt inside out.

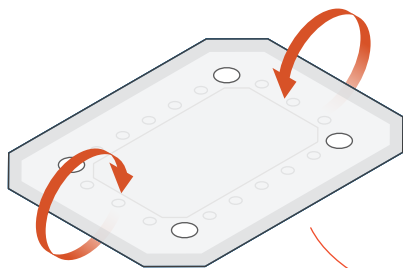

side view

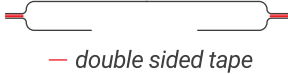

— double sided tape

side view



— double sided tape

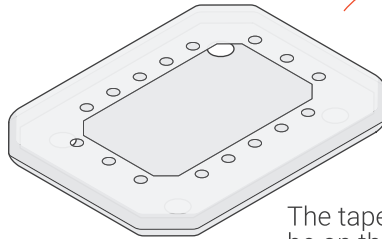

- 10 With the large center hole **facing upwards** place single sided tape around the hole's edge and then you have made a skirt!

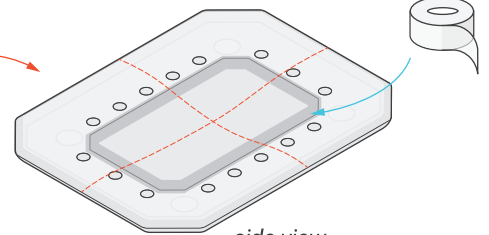

side view



— double sided tape

— Single sided tape

The taped crease will be on the inside.

## BUILDING BASE

- 11 Take 4 Strawbees and fold the head down

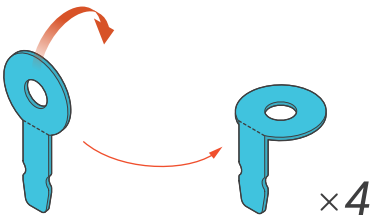

- 12 Insert Strawbees into the holes of the die cut base.

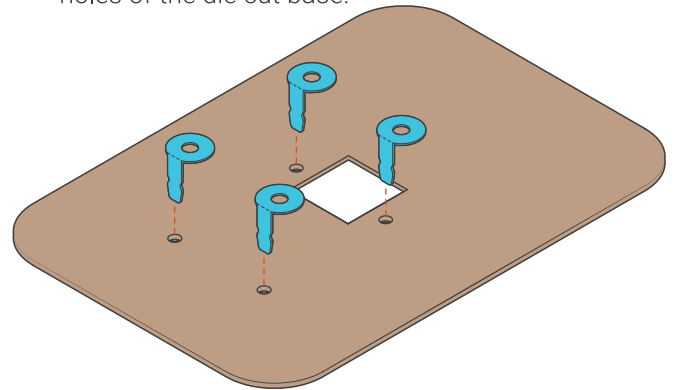

- 13 Use single sided tape to secure the Strawbee heads to the base and make **flat**.

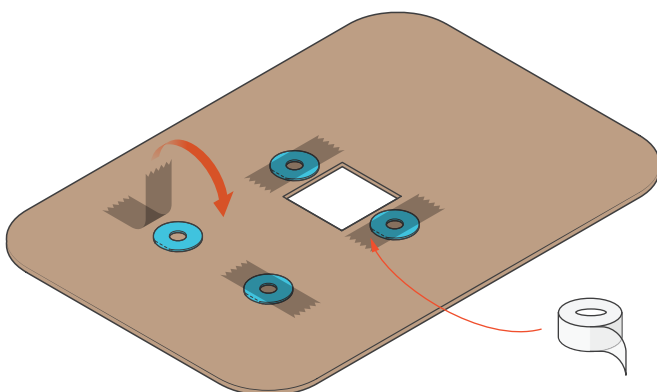

- 14 Stick down double sided tape as close to the base's edge as illustrated.

