

FCC REPORT (BLE)

Applicant: Wings Mobile Telecom SL
Address of Applicant: c/Beethoven 15, piso 4, Barcelona, Spain

Equipment Under Test (EUT)

Product Name: Smart Phone
Model No.: W4
Trade mark: Wings Mobile

FCC ID: 2ATQIW4

Applicable standards: FCC CFR Title 47 Part 15 Subpart C Section 15.247

Date of sample receipt: 24 Jul., 2020

Date of Test: 24 Jul., to 08 Sep., 2020

Date of report issued: 09 Sep., 2020

Test Result: PASS *

* In the configuration tested, the EUT complied with the standards specified above.

Authorized Signature:



Bruce Zhang
Laboratory Manager

This report details the results of the testing carried out on one sample. The results contained in this test report do not relate to other samples of the same product and does not permit the use of the CCIS product certification mark. The manufacturer should ensure that all products in series production are in conformity with the product sample detailed in this report.

This report may only be reproduced and distributed in full. If the product in this report is used in any configuration other than that detailed in the report, the manufacturer must ensure the new system complies with all relevant standards.

This document cannot be reproduced except in full, without prior written approval of the Company. Any unauthorized alteration, forgery or falsification of the content or appearance of this document is unlawful and offenders may be prosecuted to the fullest extent of the law. Unless otherwise stated the results shown in this test report refer only to the sample(s) tested and such sample(s) are retained for 90 days only.

2 Version

Version No.	Date	Description
00	09 Sep., 2020	Original

Tested by: Yoyo Wu **Date:** 09 Sep., 2020
 Test Engineer

Reviewed by: Winner Zhang **Date:** 09 Sep., 2020
 Project Engineer

3 Contents

	Page
1 COVER PAGE.....	1
2 VERSION.....	2
3 CONTENTS.....	3
4 TEST SUMMARY.....	4
5 GENERAL INFORMATION.....	5
5.1 CLIENT INFORMATION.....	5
5.2 GENERAL DESCRIPTION OF E.U.T.....	5
5.3 TEST ENVIRONMENT AND MODE, AND TEST SAMPLES PLANS	6
5.4 DESCRIPTION OF SUPPORT UNITS.....	6
5.5 MEASUREMENT UNCERTAINTY.....	6
5.6 ADDITIONS TO, DEVIATIONS, OR EXCLUSIONS FROM THE METHOD.....	6
5.7 LABORATORY FACILITY.....	6
5.8 LABORATORY LOCATION	7
5.9 TEST INSTRUMENTS LIST.....	7
6 TEST RESULTS AND MEASUREMENT DATA.....	8
6.1 ANTENNA REQUIREMENT:.....	8
6.2 CONDUCTED EMISSION	9
6.3 CONDUCTED OUTPUT POWER	12
6.4 OCCUPY BANDWIDTH.....	14
6.5 POWER SPECTRAL DENSITY	17
6.6 BAND EDGE	19
6.6.1 Conducted Emission Method.....	19
6.6.2 Radiated Emission Method.....	21
6.7 SPURIOUS EMISSION.....	30
6.7.1 Conducted Emission Method.....	30
6.7.2 Radiated Emission Method.....	32
7 TEST SETUP PHOTO	38
8 EUT CONSTRUCTIONAL DETAILS	39

4 Test Summary

Test Items	Section in CFR 47	Result
Antenna requirement	15.203 & 15.247 (b)	Pass
AC Power Line Conducted Emission	15.207	Pass
Conducted Peak Output Power	15.247 (b)(3)	Pass
6dB Emission Bandwidth 99% Occupied Bandwidth	15.247 (a)(2)	Pass
Power Spectral Density	15.247 (e)	Pass
Band Edge	15.247 (d)	Pass
Spurious Emission	15.205 & 15.209	Pass
<p>Remark:</p> <ol style="list-style-type: none"> 1. Pass: The EUT complies with the essential requirements in the standard. 2. N/A: Not Applicable. 3. The cable insertion loss used by "RF Output Power" and other conduction measurement items is 0.5dB (provided by the customer). 		
Test Method:	ANSI C63.10-2013 KDB 558074 D01 15.247 Meas Guidance v05r02	

5 General Information

5.1 Client Information

Applicant:	Wings Mobile Telecom SL
Address:	c/Beethoven 15, piso 4, Barcelona, Spain
Manufacturer/ Factory:	SHENZHEN KOOBEE COMUNICACION CO., LTD
Address:	Block A,18 Floor, No.11 Keyuan Road, Technology Park Community, Yuehai Street, Nanshan District, Shenzhen City, Guangdong Province, China

5.2 General Description of E.U.T.

Product Name:	Smart Phone
Model No.:	W4
Operation Frequency:	2402-2480 MHz
Channel numbers:	40
Channel separation:	2 MHz
Modulation technology:	GFSK
Data speed :	1Mbps & 2Mbps
Antenna Type:	Internal Antenna
Antenna gain:	0.8 dBi
Power supply:	Rechargeable Li-ion polymer Battery model: BL-99CT DC3.85V/3930mAh Rechargeable Li-ion polymer Battery model: BL-A3CT DC3.85V/3900mAh
AC adapter:	Model: HJ-0502000N2-US Input: AC100-240V, 50/60Hz, 0.3A Output: DC 5.0V, 2A
Test Sample Condition:	The test samples were provided in good working order with no visible defects.

Operation Frequency each of channel							
Channel	Frequency	Channel	Frequency	Channel	Frequency	Channel	Frequency
0	2402MHz	10	2422MHz	20	2442MHz	30	2462MHz
1	2404MHz	11	2424MHz	21	2444MHz	31	2464MHz
2	2406MHz	12	2426MHz	22	2446MHz	32	2466MHz
3	2408MHz	13	2428MHz	23	2448MHz	33	2468MHz
4	2410MHz	14	2430MHz	24	2450MHz	34	2470MHz
5	2412MHz	15	2432MHz	25	2452MHz	35	2472MHz
6	2414MHz	16	2434MHz	26	2454MHz	36	2474MHz
7	2416MHz	17	2436MHz	27	2456MHz	37	2476MHz
8	2418MHz	18	2438MHz	28	2458MHz	38	2478MHz
9	2420MHz	19	2440MHz	29	2460MHz	39	2480MHz

Note:
In section 15.31(m), regards to the operating frequency range over 10 MHz, the Lowest frequency, the middle frequency, and the highest frequency of channel were selected to perform the test. Channel No. 0, 20 & 39 were selected as Lowest, Middle and Highest channel.

5.3 Test environment and mode, and test samples plans

Operating Environment:	
Temperature:	24.0 °C
Humidity:	54 % RH
Atmospheric Pressure:	1010 mbar
Test mode:	
Transmitting mode	Keep the EUT in continuous transmitting with modulation
Radiated Emission: The sample was placed 0.8m (below 1GHz)/1.5m (above 1GHz) above the ground plane of 3m chamber. Measurements in both horizontal and vertical polarities were performed. During the test, each emission was maximized by: having the EUT continuously working, investigated all operating modes, rotated about all 3 axis (X, Y & Z) and considered typical configuration to obtain worst position, manipulating interconnecting cables, rotating the turntable, varying antenna height from 1m to 4m in both horizontal and vertical polarizations. The emissions worst-case are shown in Test Results of the following pages. Duty cycle setting during the transmission is 100% with maximum power setting for all modulations.	

5.4 Description of Support Units

The EUT has been tested as an independent unit.

5.5 Measurement Uncertainty

Parameters	Expanded Uncertainty
Conducted Emission (9kHz ~ 30MHz)	±1.60 dB (k=2)
Radiated Emission (9kHz ~ 30MHz)	±3.12 dB (k=2)
Radiated Emission (30MHz ~ 1000MHz)	±4.32 dB (k=2)
Radiated Emission (1GHz ~ 18GHz)	±5.16 dB (k=2)
Radiated Emission (18GHz ~ 40GHz)	±3.20 dB (k=2)

5.6 Additions to, deviations, or exclusions from the method

No

5.7 Laboratory Facility

<p>The test facility is recognized, certified, or accredited by the following organizations:</p> <ul style="list-style-type: none"> ● FCC - Designation No.: CN1211 Shenzhen Zhongjian Nanfang Testing Co., Ltd. has been accredited as a testing laboratory by FCC(Federal Communications Commission). The test firm Registration No. is 727551. ● ISED – CAB identifier.: CN0021 The 3m Semi-anechoic chamber of Shenzhen Zhongjian Nanfang Testing Co., Ltd. has been Registered by Certification and Engineering Bureau of Industry Canada for radio equipment testing with Registration No.: 10106A-1. ● A2LA - Registration No.: 4346.01 This laboratory is accredited in accordance with the recognized International Standard ISO/IEC 17025:2005 General requirements for the competence of testing and calibration laboratories. The test scope can be found as below link: https://portal.a2la.org/scopepdf/4346-01.pdf
--

5.8 Laboratory Location

Shenzhen Zhongjian Nanfang Testing Co., Ltd.
 Address: No.110~116, Building B, Jinyuan Business Building, Xixiang Road,
 Bao'an District, Shenzhen, Guangdong, China
 Tel: +86-755-23118282, Fax: +86-755-23116366
 Email: info@ccis-cb.com, Website: <http://www.ccis-cb.com>

5.9 Test Instruments list

Radiated Emission:					
Test Equipment	Manufacturer	Model No.	Serial No.	Cal. Date (mm-dd-yy)	Cal. Due date (mm-dd-yy)
3m SAC	SAEMC	9m*6m*6m	966	07-22-2020	07-21-2021
Loop Antenna	SCHWARZBECK	FMZB1519B	044	03-07-2020	03-06-2021
BiConiLog Antenna	SCHWARZBECK	VULB9163	497	03-07-2020	03-06-2021
Horn Antenna	SCHWARZBECK	BBHA9120D	916	03-07-2020	03-06-2021
Horn Antenna	SCHWARZBECK	BBHA9120D	1805	06-22-2020	06-21-2021
Horn Antenna	SCHWARZBECK	BBHA 9170	BBHA9170582	11-18-2019	11-17-2020
EMI Test Software	AUDIX	E3	Version: 6.110919b		
Pre-amplifier	HP	8447D	2944A09358	03-07-2020	03-06-2021
Pre-amplifier	CD	PAP-1G18	11804	03-07-2020	03-06-2021
Spectrum analyzer	Rohde & Schwarz	FSP30	101454	03-05-2020	03-04-2021
Spectrum analyzer	Rohde & Schwarz	FSP40	100363	11-18-2019	11-17-2020
EMI Test Receiver	Rohde & Schwarz	ESRP7	101070	03-05-2020	03-04-2021
Cable	ZDECL	Z108-NJ-NJ-81	1608458	03-07-2020	03-06-2021
Cable	MICRO-COAX	MFR64639	K10742-5	03-07-2020	03-06-2021
Cable	SUHNER	SUCOFLEX100	58193/4PE	03-07-2020	03-06-2021
RF Switch Unit	MWRFTTEST	MW200	N/A	N/A	N/A
Test Software	MWRFTTEST	MTS8200	Version: 2.0.0.0		

Conducted Emission:					
Test Equipment	Manufacturer	Model No.	Serial No.	Cal. Date (mm-dd-yy)	Cal. Due date (mm-dd-yy)
EMI Test Receiver	Rohde & Schwarz	ESCI	101189	03-05-2020	03-04-2021
Pulse Limiter	SCHWARZBECK	OSRAM 2306	9731	03-05-2020	03-04-2021
LISN	CHASE	MN2050D	1447	03-05-2020	03-04-2021
LISN	Rohde & Schwarz	ESH3-Z5	8438621/010	07-21-2020	07-20-2021
Cable	HP	10503A	N/A	03-05-2020	03-04-2021
EMI Test Software	AUDIX	E3	Version: 6.110919b		

6 Test results and Measurement Data

6.1 Antenna requirement:

Standard requirement:	FCC Part 15 C Section 15.203 /247(b)
<p>15.203 requirement: An intentional radiator shall be designed to ensure that no antenna other than that furnished by the responsible party shall be used with the device. The use of a permanently attached antenna or of an antenna that uses a unique coupling to the intentional radiator, the manufacturer may design the unit so that a broken antenna can be replaced by the user, but the use of a standard antenna jack or electrical connector is prohibited.</p> <p>15.247(b) (4) requirement: (4) The conducted output power limit specified in paragraph (b) of this section is based on the use of antennas with directional gains that do not exceed 6 dBi. Except as shown in paragraph (c) of this section, if transmitting antennas of directional gain greater than 6 dBi are used, the conducted output power from the intentional radiator shall be reduced below the stated values in paragraphs (b)(1), (b)(2), and (b)(3) of this section, as appropriate, by the amount in dB that the directional gain of the antenna exceeds 6 dBi.</p>	
E.U.T Antenna:	
<p>The BLE antenna is an Internal antenna which cannot replace by end-user, the best-case gain of the antenna is 0.8 dBi.</p>	

6.2 Conducted Emission

Test Requirement:	FCC Part 15 C Section 15.207		
Test Frequency Range:	150 kHz to 30 MHz		
Class / Severity:	Class B		
Receiver setup:	RBW=9kHz, VBW=30kHz		
Limit:	Frequency range (MHz)	Limit (dBuV)	
		Quasi-peak	Average
	0.15-0.5	66 to 56*	56 to 46*
	0.5-5	56	46
	5-30	60	50
* Decreases with the logarithm of the frequency.			
Test procedure:	<ol style="list-style-type: none"> The E.U.T and simulators are connected to the main power through a line impedance stabilization network (L.I.S.N.), which provides a 50ohm/50uH coupling impedance for the measuring equipment. The peripheral devices are also connected to the main power through a LISN that provides a 50ohm/50uH coupling impedance with 50ohm termination. (Please refer to the block diagram of the test setup and photographs). Both sides of A.C. line are checked for maximum conducted interference. In order to find the maximum emission, the relative positions of equipment and all of the interface cables must be changed according to ANSI C63.10(latest version) on conducted measurement. 		
Test setup:	<p><i>Remark:</i> E.U.T: Equipment Under Test LISN: Line Impedance Stabilization Network Test table height=0.8m</p>		
Test Instruments:	Refer to section 5.9 for details		
Test mode:	Refer to section 5.3 for details		
Test results:	Passed		

Measurement Data:

Product name:	Smart Phone	Product model:	W4
Test by:	Yaro	Test mode:	BLE Tx mode
Test frequency:	150 kHz ~ 30 MHz	Phase:	Line
Test voltage:	AC 120 V/60 Hz	Environment:	Temp: 22.5°C Huni: 55%

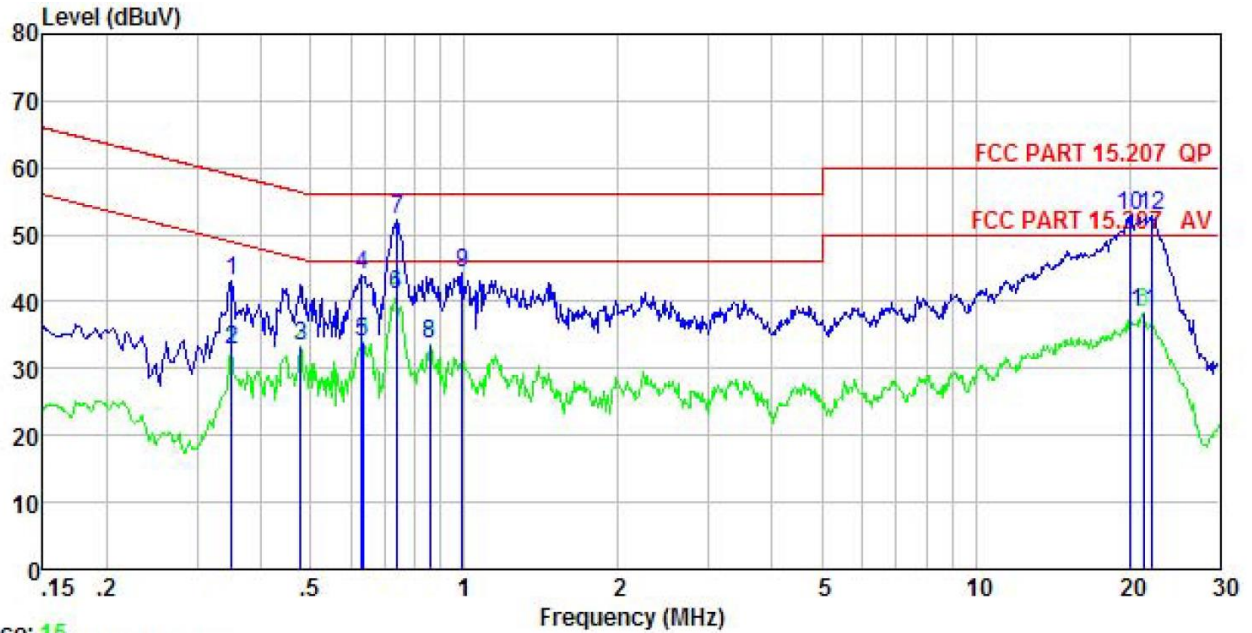

Trace: 15

	Freq	Read Level	LISN Factor	Cable Loss	Aux Factor	Level	Limit Line	Over Limit	Remark
	MHz	dBuV	dB	dB	dB	dBuV	dBuV	dB	
1	0.350	32.88	-0.51	10.73	0.10	43.20	58.96	-15.76	QP
2	0.350	22.46	-0.51	10.73	0.10	32.78	48.96	-16.18	Average
3	0.479	23.39	-0.44	10.75	-0.21	33.49	46.36	-12.87	Average
4	0.630	34.04	-0.50	10.77	-0.38	43.93	56.00	-12.07	QP
5	0.634	23.97	-0.50	10.77	-0.38	33.86	46.00	-12.14	Average
6	0.735	31.13	-0.54	10.79	-0.28	41.10	46.00	-4.90	Average
7	0.739	42.39	-0.54	10.79	-0.28	52.36	56.00	-3.64	QP
8	0.857	23.27	-0.58	10.83	0.09	33.61	46.00	-12.39	Average
9	0.989	33.50	-0.62	10.87	0.42	44.17	56.00	-11.83	QP
10	20.056	41.85	-0.87	10.93	0.89	52.80	60.00	-7.20	QP
11	21.260	27.39	-0.93	10.91	0.92	38.29	50.00	-11.71	Average
12	22.063	42.03	-0.95	10.90	0.93	52.91	60.00	-7.09	QP

Notes:

1. An initial pre-scan was performed on the line and neutral lines with peak detector.
2. Quasi-Peak and Average measurement were performed at the frequencies with maximized peak emission.
3. Final Level = Receiver Read level + LISN Factor + Aux Factor + Cable Loss.

Product name:	Smart Phone	Product model:	W4
Test by:	Yaro	Test mode:	BLE Tx mode
Test frequency:	150 kHz ~ 30 MHz	Phase:	Neutral
Test voltage:	AC 120 V/60 Hz	Environment:	Temp: 22.5°C Humi: 55%

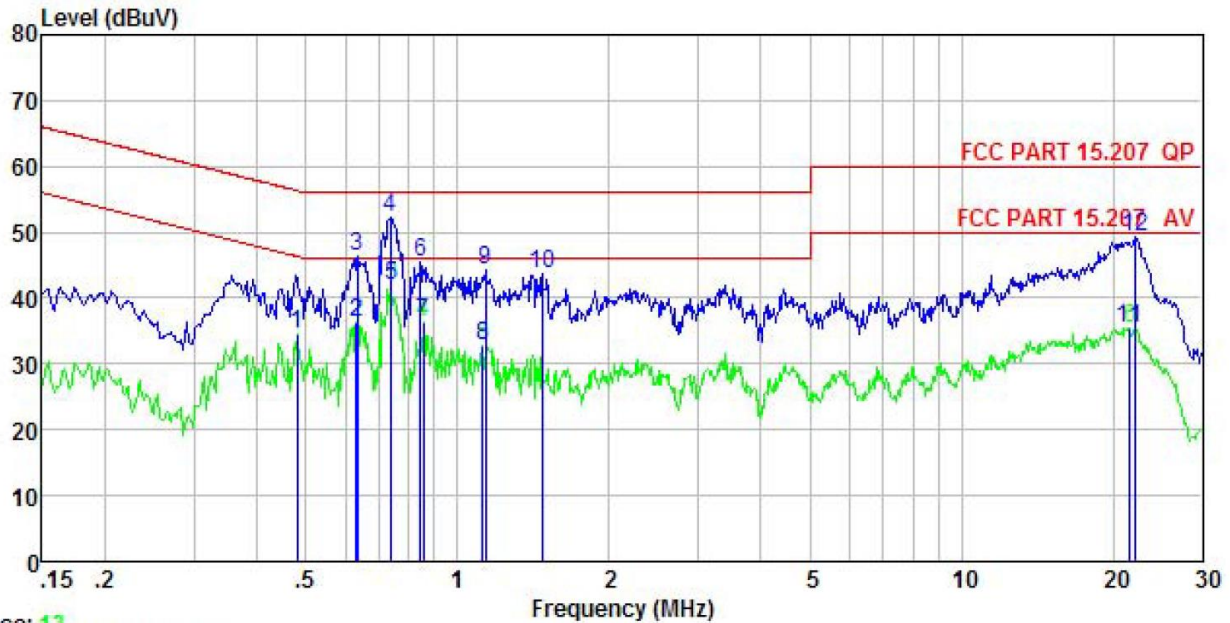

Trace: 13

	Read Freq	Level	LISN Factor	Cable Loss	Aux Factor	Level	Limit	Over	Remark
	MHz	dBuV	dB	dB	dB	dBuV	dBuV	dB	
1	0.481	24.38	-0.65	10.75	0.02	34.50	46.32	-11.82	Average
2	0.630	26.13	-0.64	10.77	0.04	36.30	46.00	-9.70	Average
3	0.634	36.28	-0.64	10.77	0.04	46.45	56.00	-9.55	QP
4	0.735	42.18	-0.65	10.79	0.05	52.37	56.00	-3.63	QP
5	0.739	31.70	-0.65	10.79	0.05	41.89	46.00	-4.11	Average
6	0.844	35.36	-0.66	10.82	0.06	45.58	56.00	-10.42	QP
7	0.857	26.14	-0.66	10.83	0.06	36.37	46.00	-9.63	Average
8	1.123	22.40	-0.68	10.88	0.09	32.69	46.00	-13.31	Average
9	1.135	33.85	-0.69	10.89	0.10	44.15	56.00	-11.85	QP
10	1.472	33.20	-0.70	10.92	0.13	43.55	56.00	-12.45	QP
11	21.600	25.51	-1.30	10.91	0.41	35.53	50.00	-14.47	Average
12	22.063	39.21	-1.30	10.90	0.45	49.26	60.00	-10.74	QP

Notes:

1. An initial pre-scan was performed on the line and neutral lines with peak detector.
2. Quasi-Peak and Average measurement were performed at the frequencies with maximized peak emission.
3. Final Level = Receiver Read level + LISN Factor + Aux Factor + Cable Loss.

6.3 Conducted Output Power

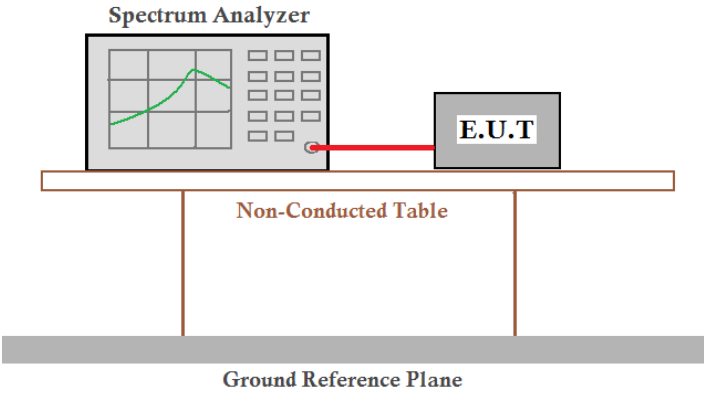
Test Requirement:	FCC Part 15 C Section 15.247 (b)(3)
Limit:	30dBm
Test setup:	 <p>The diagram shows a Spectrum Analyzer on the left and an E.U.T. on the right, connected by a red cable. They are both on a table labeled 'Non-Conducted Table'. Below the table is a grey bar labeled 'Ground Reference Plane'.</p>
Test Instruments:	Refer to section 5.9 for details
Test mode:	Refer to section 5.3 for details
Test results:	Passed

Measurement Data:

Test CH	Maximum Conducted Output Power (dBm)		Limit(dBm)	Result
	1M PHY	2M PHY		
Lowest	-4.44	-4.35	30.00	Pass
Middle	-2.82	-2.73		
Highest	-4.31	-4.25		

Test plot as follows:

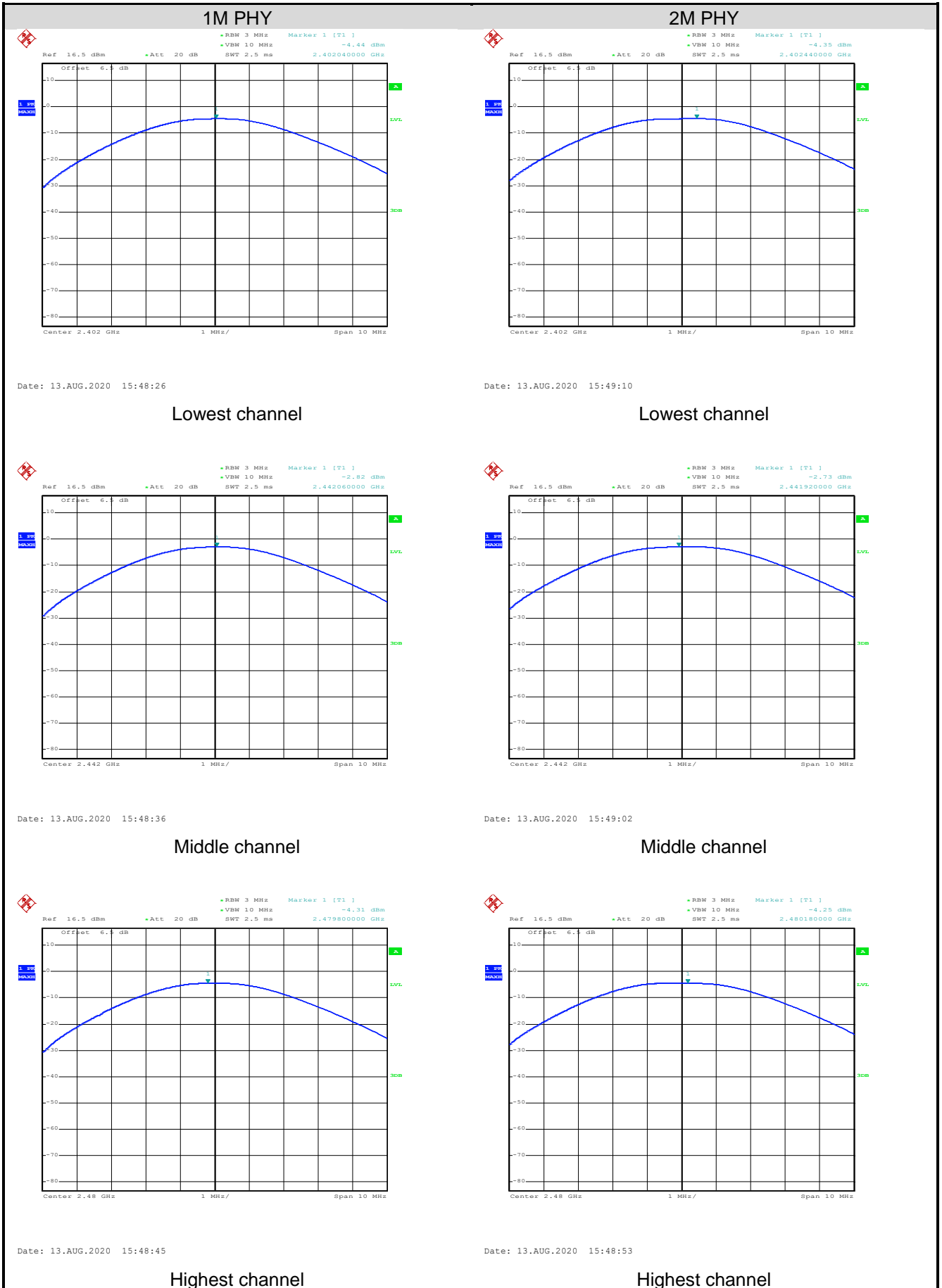

6.4 Occupy Bandwidth

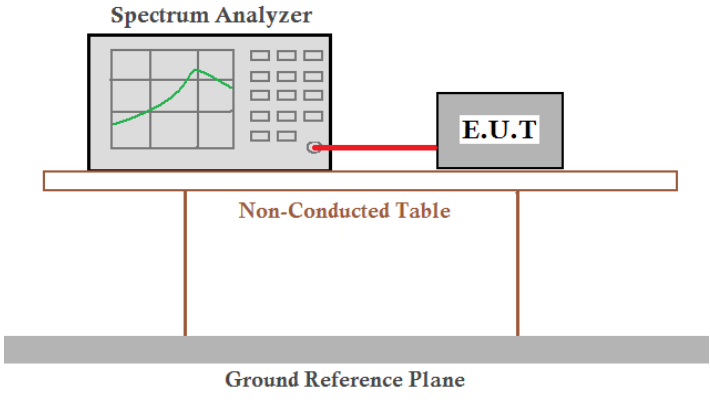
Test Requirement:	FCC Part 15 C Section 15.247 (a)(2)
Limit:	>500kHz
Test setup:	
Test Instruments:	Refer to section 5.9 for details
Test mode:	Refer to section 5.3 for details
Test results:	Passed

Measurement Data:

Test CH	6dB Emission Bandwidth (MHz)		Limit(kHz)	Result
	1M PHY	2M PHY		
Lowest	0.714	1.20	>500	Pass
Middle	0.702	1.18		
Highest	0.702	1.19		
Test CH	99% Occupy Bandwidth (MHz)		Limit(kHz)	Result
	1M PHY	2M PHY		
Lowest	1.044	2.08	N/A	N/A
Middle	1.038	2.08		
Highest	1.044	2.08		

Test plot as follows:

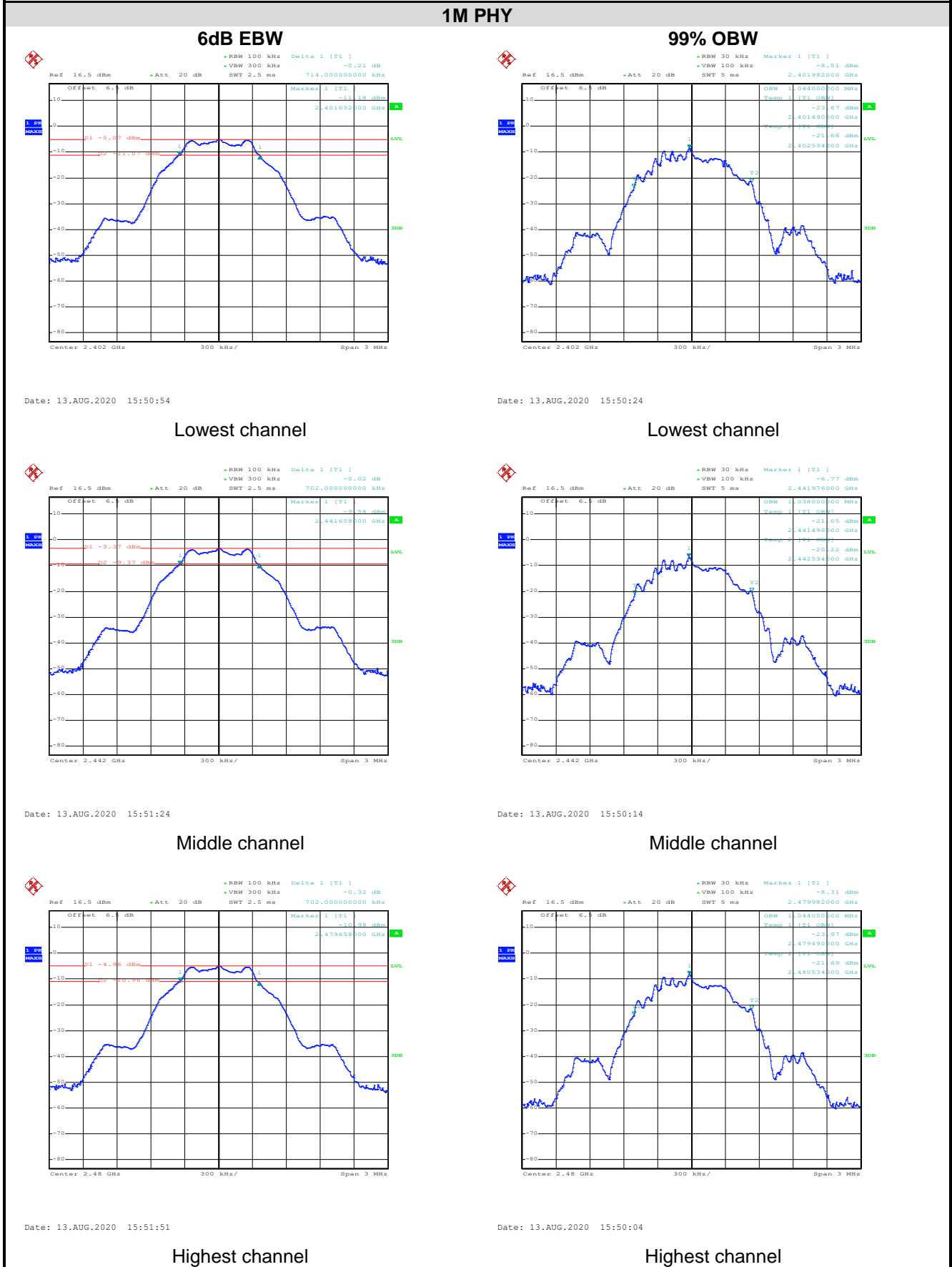

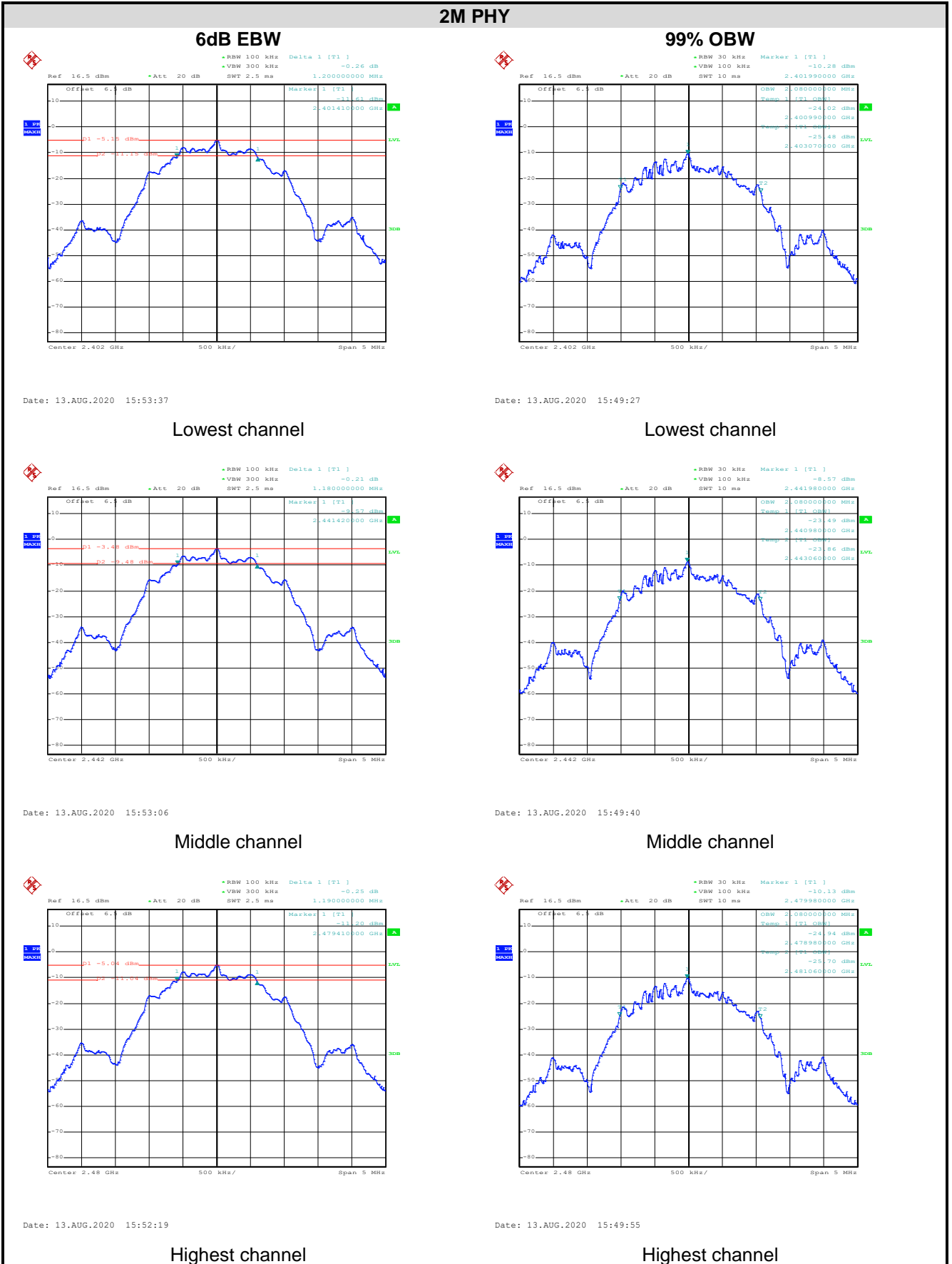

6.5 Power Spectral Density

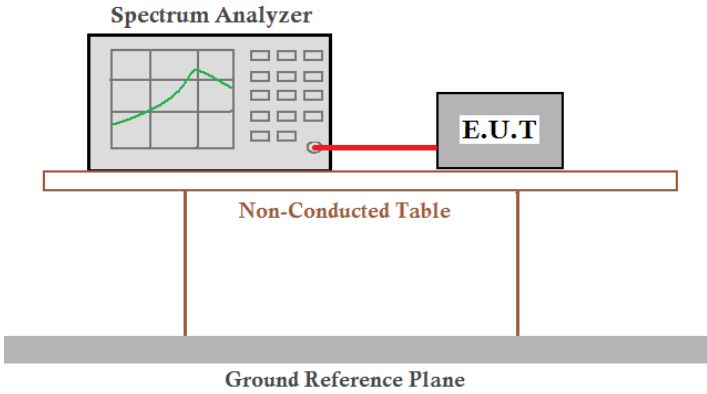
Test Requirement:	FCC Part 15 C Section 15.247 (e)
Limit:	8 dBm/3kHz
Test setup:	
Test Instruments:	Refer to section 5.9 for details
Test mode:	Refer to section 5.3 for details
Test results:	Passed

Measurement Data:

Test CH	Power Spectral Density (dBm/3kHz)		Limit (dBm/3kHz)	Result
	1M PHY	2M PHY		
Lowest	-19.54	-22.25	8.00	Pass
Middle	-18.13	-20.59		
Highest	-19.61	-22.53		

Test plots as follow:

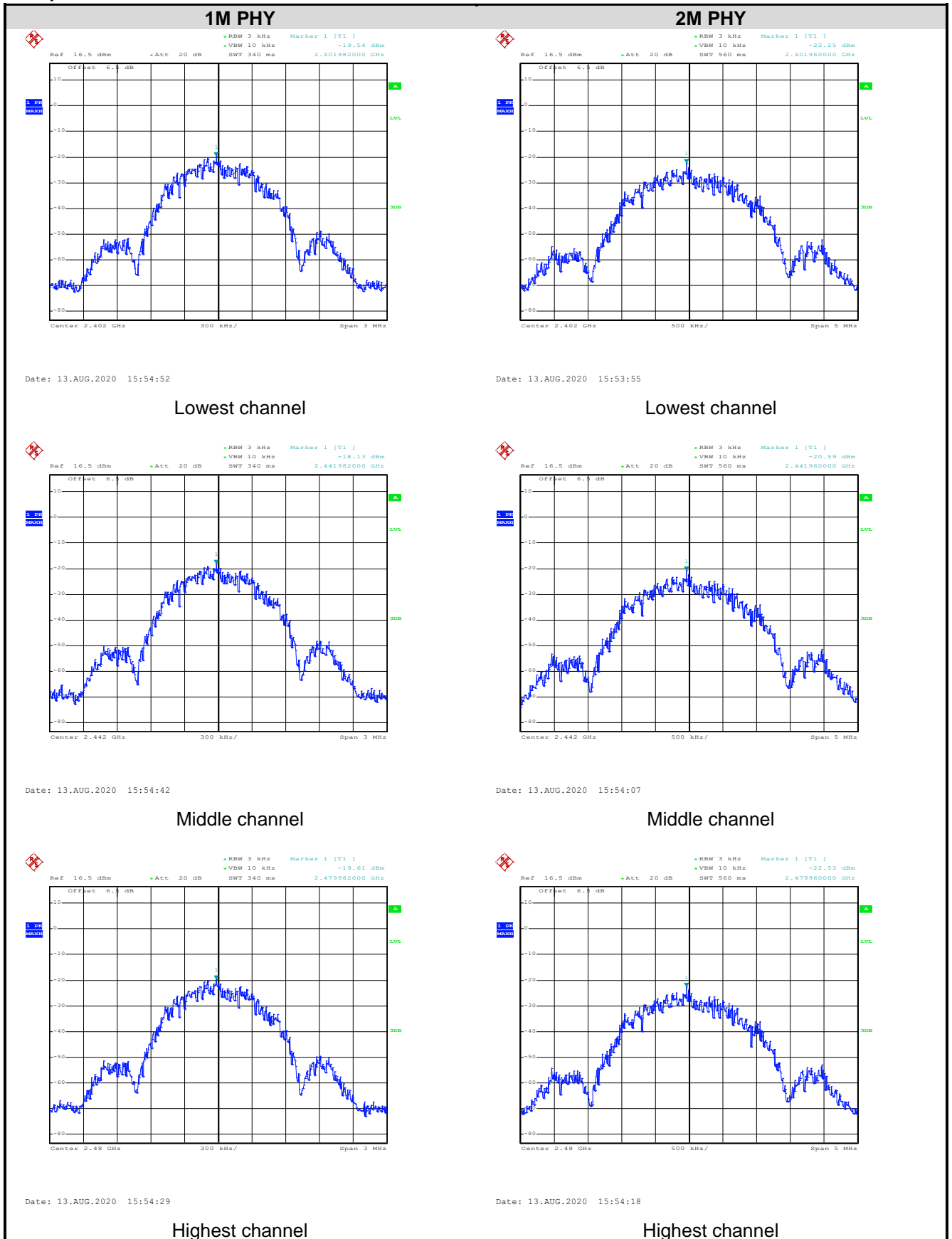

6.6 Band Edge

6.6.1 Conducted Emission Method

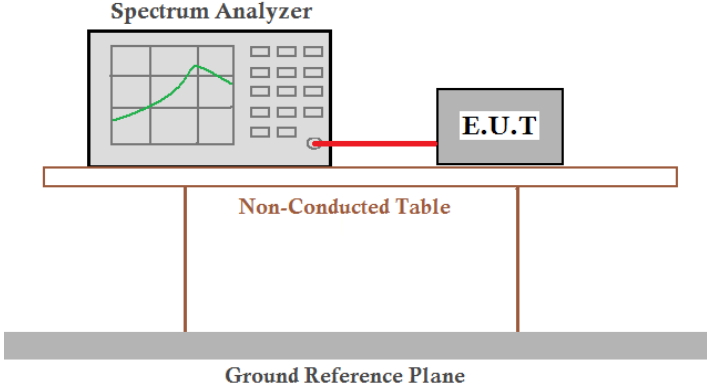
Test Requirement:	FCC Part 15 C Section 15.247 (d)
Limit:	In any 100 kHz bandwidth outside the frequency band in which the spread spectrum intentional radiator is operating, the radio frequency power that is produced by the intentional radiator shall be at least 20 dB below that in the 100 kHz bandwidth within the band that contains the highest level of the desired power, based on either an RF conducted or a radiated measurement.
Test setup:	 <p>The diagram illustrates the test setup. A Spectrum Analyzer is connected to an E.U.T. (Equipment Under Test) via a red cable. Both the Spectrum Analyzer and the E.U.T. are placed on a Non-Conducted Table. Below the table is a Ground Reference Plane.</p>
Test Instruments:	Refer to section 5.9 for details
Test mode:	Refer to section 5.3 for details
Test results:	Passed

Test plots as follow:

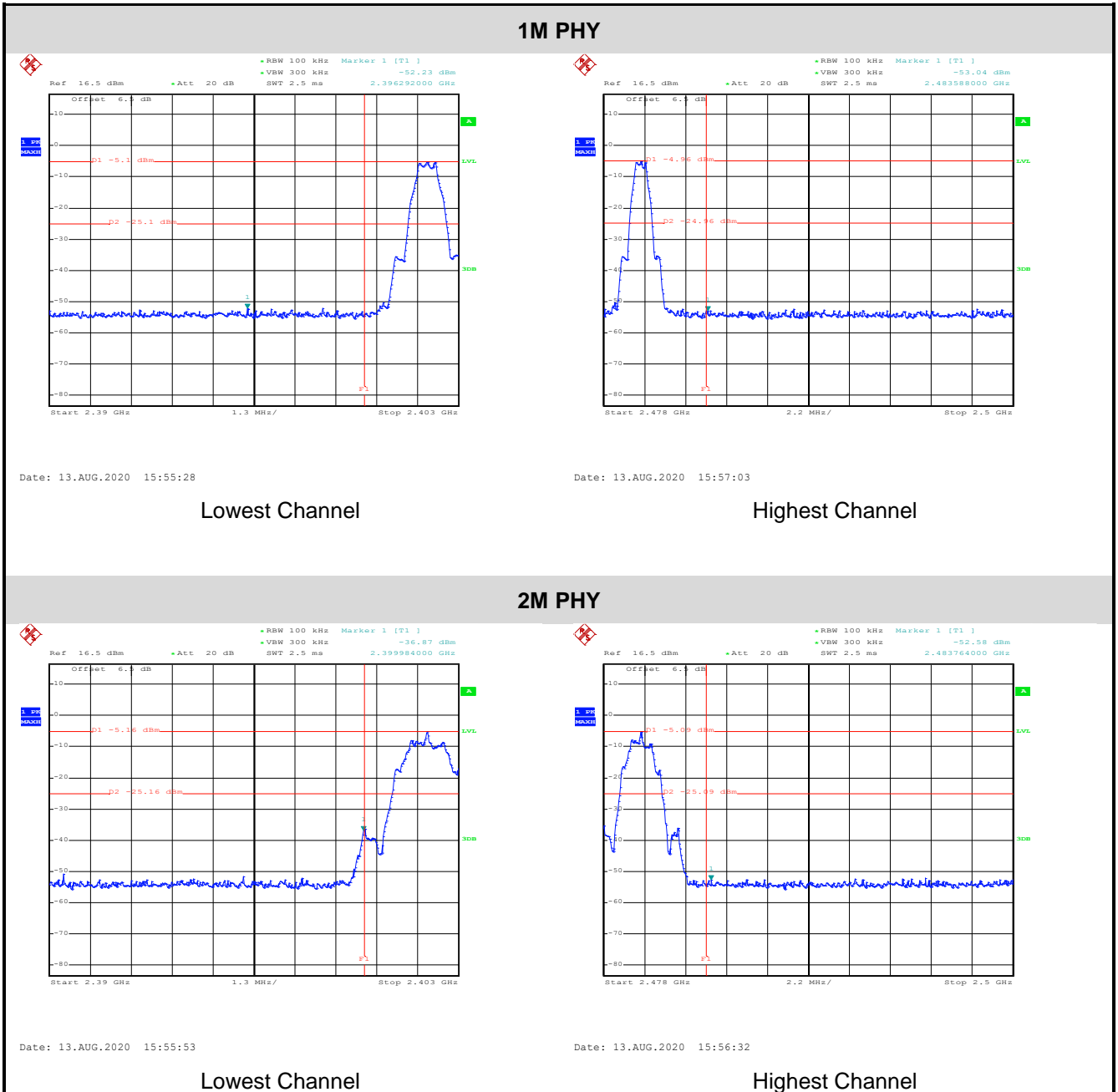

6.6.2 Radiated Emission Method

Test Requirement:	FCC Part 15 C Section 15.205 and 15.209				
Test Frequency Range:	2310 MHz to 2390 MHz and 2483.5MHz to 2500 MHz				
Test Distance:	3m				
Receiver setup:	Frequency	Detector	RBW	VBW	Remark
	Above 1GHz	Peak RMS	1MHz 1MHz	3MHz 3MHz	Peak Value Average Value
Limit:	Frequency	Limit (dBuV/m @3m)		Remark	
	Above 1GHz	54.00 74.00		Average Value Peak Value	
Test Procedure:	<ol style="list-style-type: none"> 1. The EUT was placed on the top of a rotating table 1.5 meters above the ground at a 3 meter camber. The table was rotated 360 degrees to determine the position of the highest radiation. 2. The EUT was set 3 meters away from the interference-receiving antenna, which was mounted on the top of a variable-height antenna tower. 3. The antenna height is varied from one meter to four meters above the ground to determine the maximum value of the field strength. Both horizontal and vertical polarizations of the antenna are set to make the measurement. 4. For each suspected emission, the EUT was arranged to its worst case and then the antenna was tuned to heights from 1 meter to 4 meters and the rota table was turned from 0 degrees to 360 degrees to find the maximum reading. 5. The test-receiver system was set to Peak Detect Function and Specified Bandwidth with Maximum Hold Mode. 6. If the emission level of the EUT in peak mode was 10 dB lower than the limit specified, then testing could be stopped and the peak values of the EUT would be reported. Otherwise the emissions that did not have 10 dB margin would be re-tested one by one using peak, quasi-peak or average method as specified and then reported in a data sheet. 				
Test setup:					
Test Instruments:	Refer to section 5.9 for details				
Test mode:	Refer to section 5.3 for details				
Test results:	Passed				

1M PHY:

Product Name:	Smart Phone	Product Model:	W4
Test By:	Yaro	Test mode:	BLE Tx mode
Test Channel:	Lowest channel	Polarization:	Vertical
Test Voltage:	AC 120/60Hz	Environment:	Temp: 24°C Humi: 57%

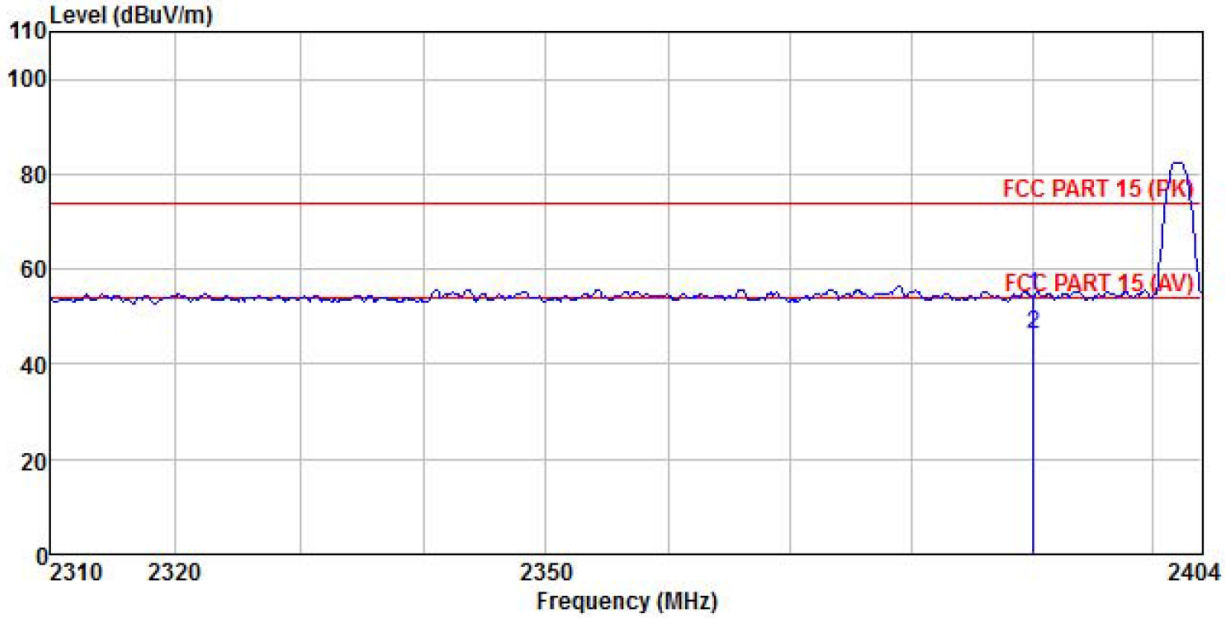

	Freq	Read Level	Antenna Factor	Cable Loss	Aux Factor	Preamp Factor	Level	Limit	Over	Remark
	MHz	dBuV	dB/m	dB	dB	dB	dBuV/m	dBuV/m	dB	
1	2390.000	21.21	27.03	4.28	1.68	0.00	54.20	74.00	-19.80	Peak
2	2390.000	13.14	27.03	4.28	1.68	0.00	46.13	54.00	-7.87	Average

Remark:

1. Final Level = Receiver Read level + Antenna Factor + Cable Loss – Preamplifier Factor.
2. The emission levels of other frequencies are lower than the limit 20dB and not show in test report.

Product Name:	Smart Phone	Product Model:	W4
Test By:	Yaro	Test mode:	BLE Tx mode
Test Channel:	Lowest channel	Polarization:	Horizontal
Test Voltage:	AC 120/60Hz	Environment:	Temp: 24°C Humi: 57%

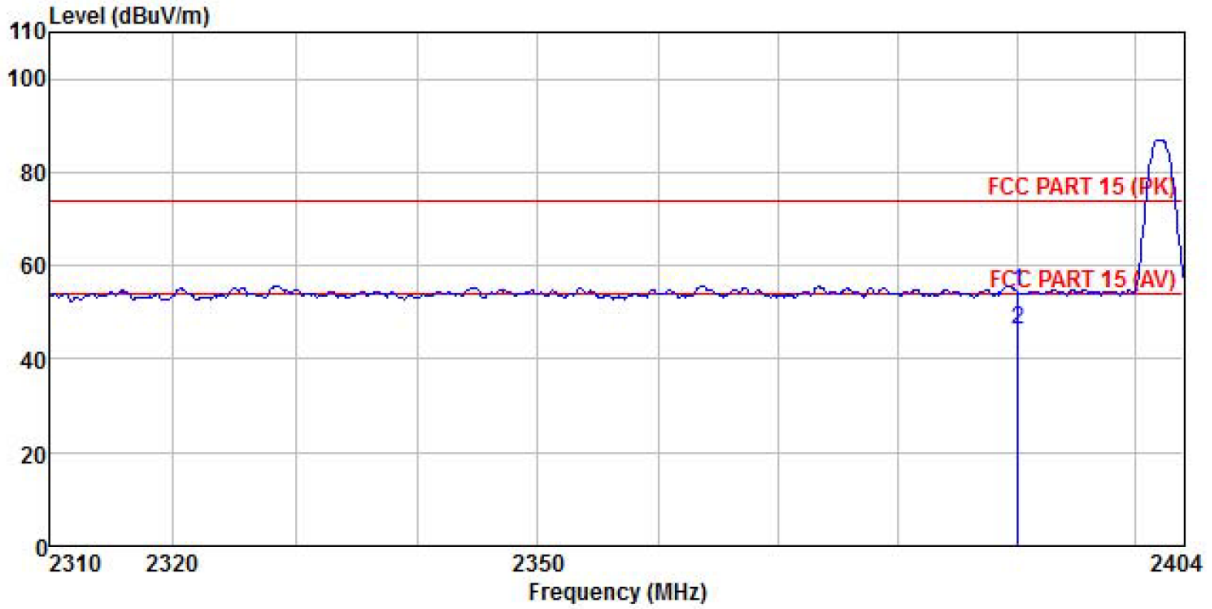

	Read Freq	Antenna Level	Cable Factor	Aux Loss	Preamp Factor	Level	Limit Line	Over Limit	Remark
	MHz	dBuV	dB/m	dB	dB	dBuV/m	dBuV/m	dB	
1	2390.000	21.36	27.03	4.28	1.68	0.00	54.35	74.00	-19.65 Peak
2	2390.000	13.29	27.03	4.28	1.68	0.00	46.28	54.00	-7.72 Average

Remark:

1. Final Level = Receiver Read level + Antenna Factor + Cable Loss – Preamplifier Factor.
2. The emission levels of other frequencies are lower than the limit 20dB and not show in test report.

Product Name:	Smart Phone	Product Model:	W4
Test By:	Yaro	Test mode:	BLE Tx mode
Test Channel:	Highest channel	Polarization:	Vertical
Test Voltage:	AC 120/60Hz	Environment:	Temp: 24°C Huni: 57%

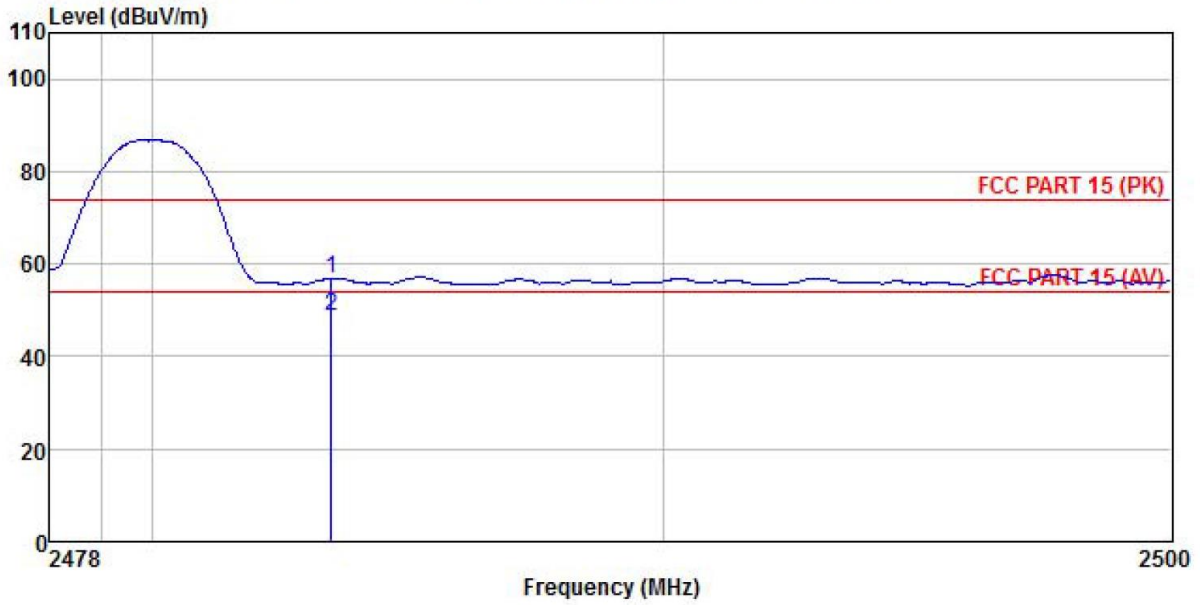

	ReadAntenna	Cable	Aux	Preamp	Limit	Over				
Freq	Level	Factor	Loss	Factor	Level	Line	Limit Remark			
MHz	dBuV	dB/m	dB	dB	dB	dBuV/m	dBuV/m			
1	2483.500	23.51	27.27	4.38	1.70	0.00	56.86	74.00	-17.14	Peak
2	2483.500	15.55	27.27	4.38	1.70	0.00	48.90	54.00	-5.10	Average

Remark:

1. Final Level = Receiver Read level + Antenna Factor + Cable Loss – Pre-amplifier Factor.
2. The emission levels of other frequencies are lower than the limit 20dB and not show in test report.

Product Name:	Smart Phone	Product Model:	W4
Test By:	Yaro	Test mode:	BLE Tx mode
Test Channel:	Highest channel	Polarization:	Horizontal
Test Voltage:	AC 120/60Hz	Environment:	Temp: 24°C Humi: 57%

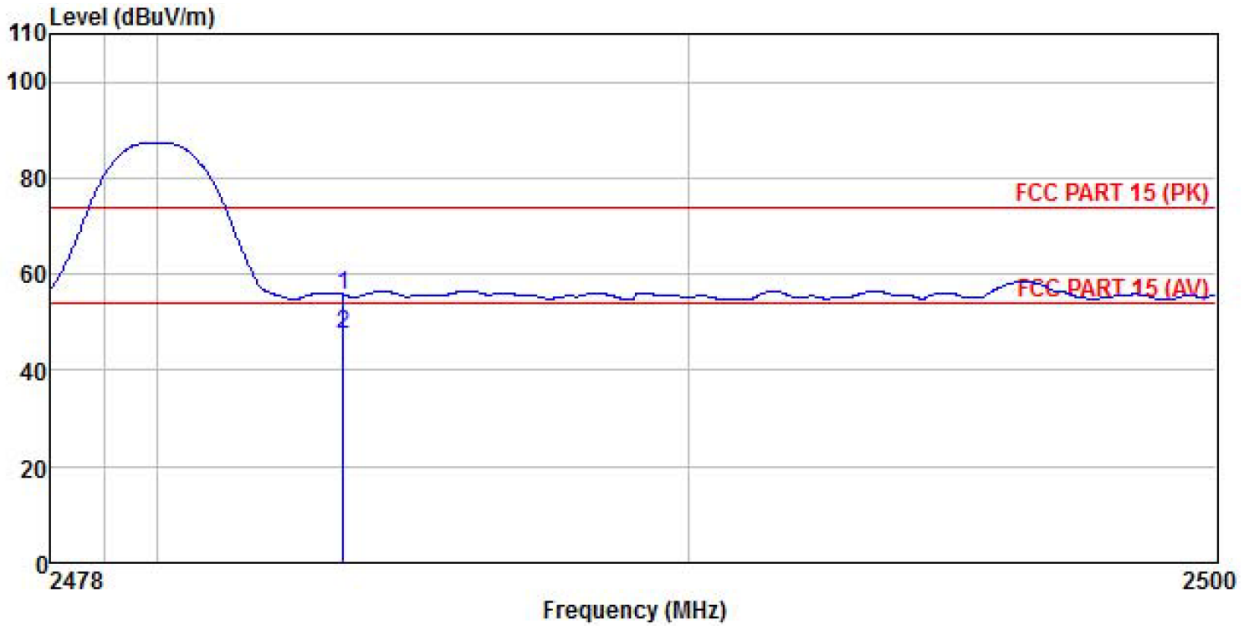

	Read	Antenna	Cable	Aux	Preamp	Level	Limit	Over	
	Freq	Level	Factor	Loss	Factor	Factor	Line	Limit	Remark
	MHz	dBuV	dB/m	dB	dB	dB	dBuV/m	dBuV/m	dB
1	2483.500	22.29	27.27	4.38	1.70	0.00	55.64	74.00	-18.36 Peak
2	2483.500	14.29	27.27	4.38	1.70	0.00	47.64	54.00	-6.36 Average

Remark:

1. Final Level = Receiver Read level + Antenna Factor + Cable Loss – Pre-amplifier Factor.
2. The emission levels of other frequencies are lower than the limit 20dB and not show in test report.

2M PHY:

Product Name:	Smart Phone	Product Model:	W4
Test By:	Yaro	Test mode:	BLE Tx mode
Test Channel:	Lowest channel	Polarization:	Vertical
Test Voltage:	AC 120/60Hz	Environment:	Temp: 24°C Humi: 57%

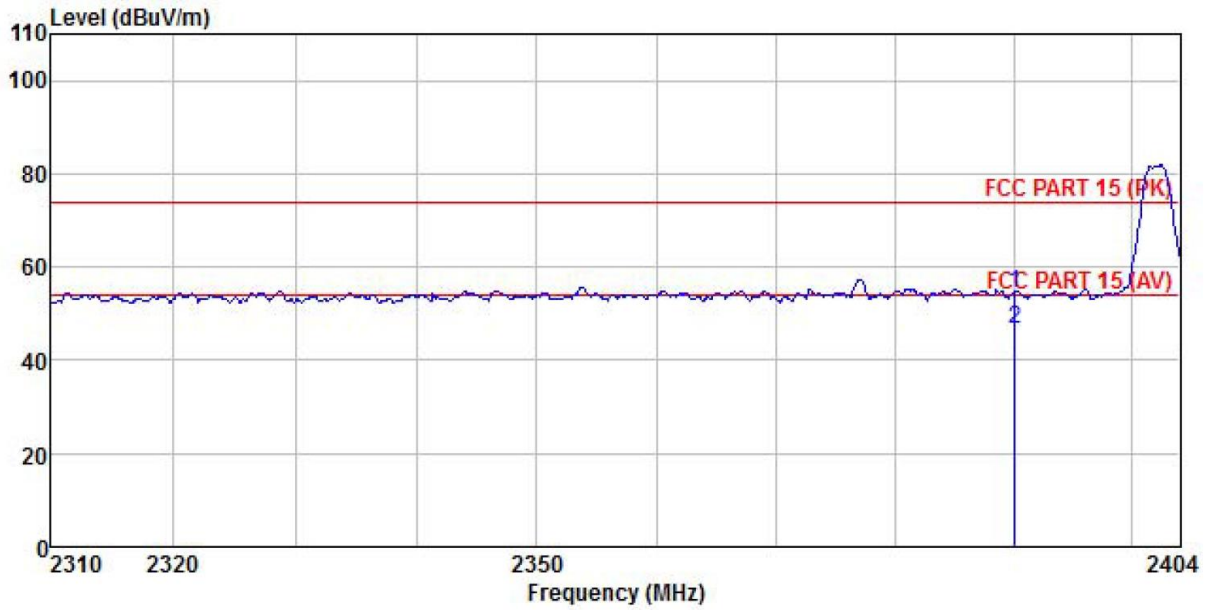

	Read Freq	Antenna Level	Cable Factor	Aux Loss	Preamp Factor	Level	Limit	Over	Remark
	MHz	dBuV	dB/m	dB	dB	dBuV/m	dBuV/m	dB	
1	2390.000	21.55	27.03	4.28	1.68	0.00	54.54	74.00	-19.46 Peak
2	2390.000	13.54	27.03	4.28	1.68	0.00	46.53	54.00	-7.47 Average

Remark:

1. Final Level = Receiver Read level + Antenna Factor + Cable Loss – Pre-amplifier Factor.
2. The emission levels of other frequencies are lower than the limit 20dB and not show in test report.

Product Name:	Smart Phone	Product Model:	W4
Test By:	Yaro	Test mode:	BLE Tx mode
Test Channel:	Lowest channel	Polarization:	Horizontal
Test Voltage:	AC 120/60Hz	Environment:	Temp: 24°C Huni: 57%

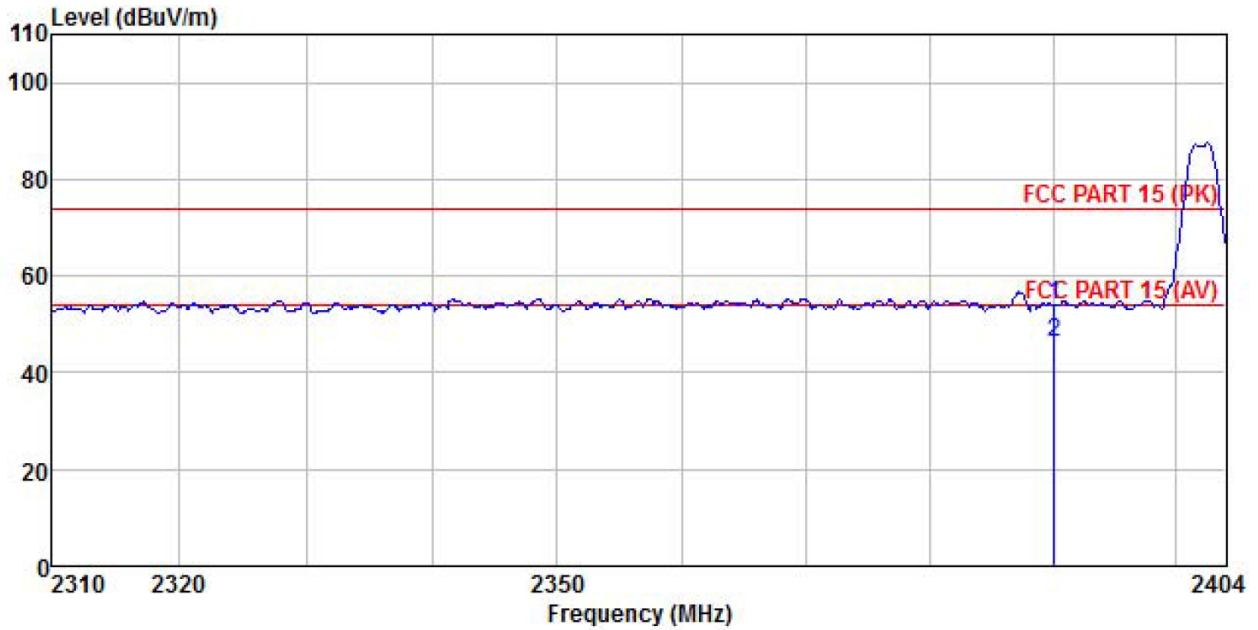

	ReadAntenna	Cable	Aux	Preamp	Limit	Over			
Freq	Level	Factor	Loss	Factor	Factor	Level	Line	Limit	Remark
-----	-----	-----	-----	-----	-----	-----	-----	-----	-----
MHz	dBuV	dB/m	dB	dB	dB	dBuV/m	dBuV/m	dB	
1	2390.000	21.01	27.03	4.28	1.68	0.00	54.00	74.00	-20.00 Peak
2	2390.000	13.12	27.03	4.28	1.68	0.00	46.11	54.00	-7.89 Average

Remark:

1. Final Level = Receiver Read level + Antenna Factor + Cable Loss – Preamplifier Factor.
2. The emission levels of other frequencies are lower than the limit 20dB and not show in test report.

Product Name:	Smart Phone	Product Model:	W4
Test By:	Yaro	Test mode:	BLE Tx mode
Test Channel:	Highest channel	Polarization:	Vertical
Test Voltage:	AC 120/60Hz	Environment:	Temp: 24°C Humi: 57%

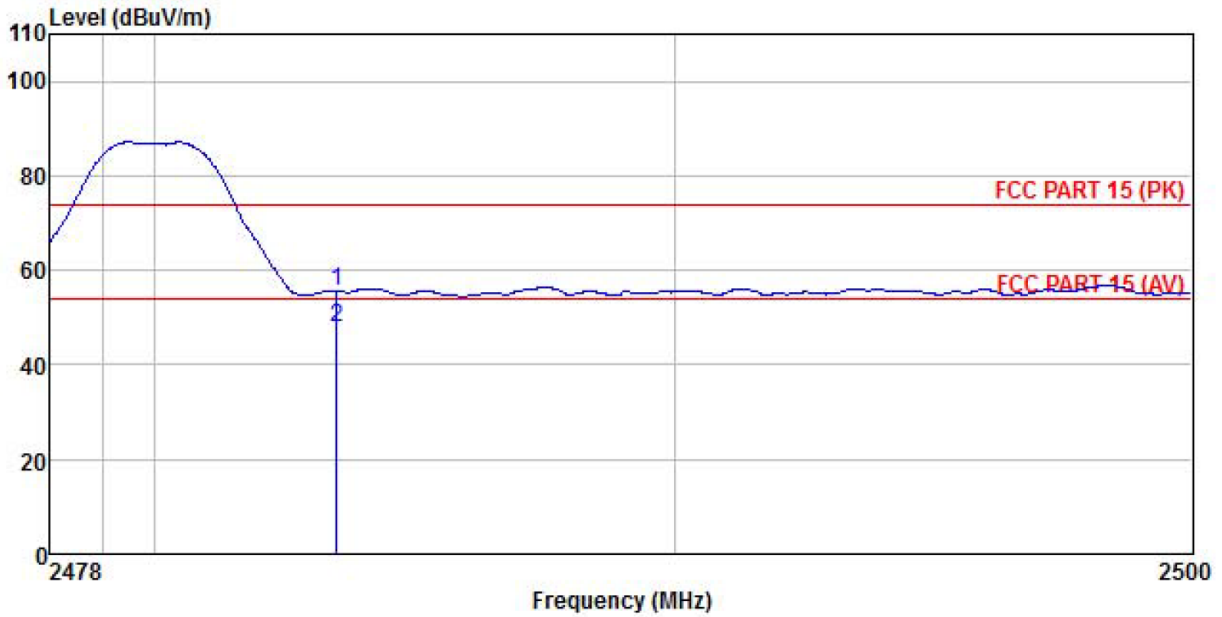

	Read	Antenna	Cable	Aux	Preamp	Limit	Over		
Freq	Level	Factor	Loss	Factor	Factor	Line	Limit	Remark	
MHz	dBuV	dB/m	dB	dB	dB	dBuV/m	dBuV/m	dB	
1	2483.500	22.23	27.27	4.38	1.70	0.00	55.58	74.00	-18.42 Peak
2	2483.500	14.47	27.27	4.38	1.70	0.00	47.82	54.00	-6.18 Average

Remark:

1. Final Level = Receiver Read level + Antenna Factor + Cable Loss – Preamplifier Factor.
2. The emission levels of other frequencies are lower than the limit 20dB and not show in test report.

Product Name:	Smart Phone	Product Model:	W4
Test By:	Yaro	Test mode:	BLE Tx mode
Test Channel:	Highest channel	Polarization:	Horizontal
Test Voltage:	AC 120/60Hz	Environment:	Temp: 24°C Humi: 57%

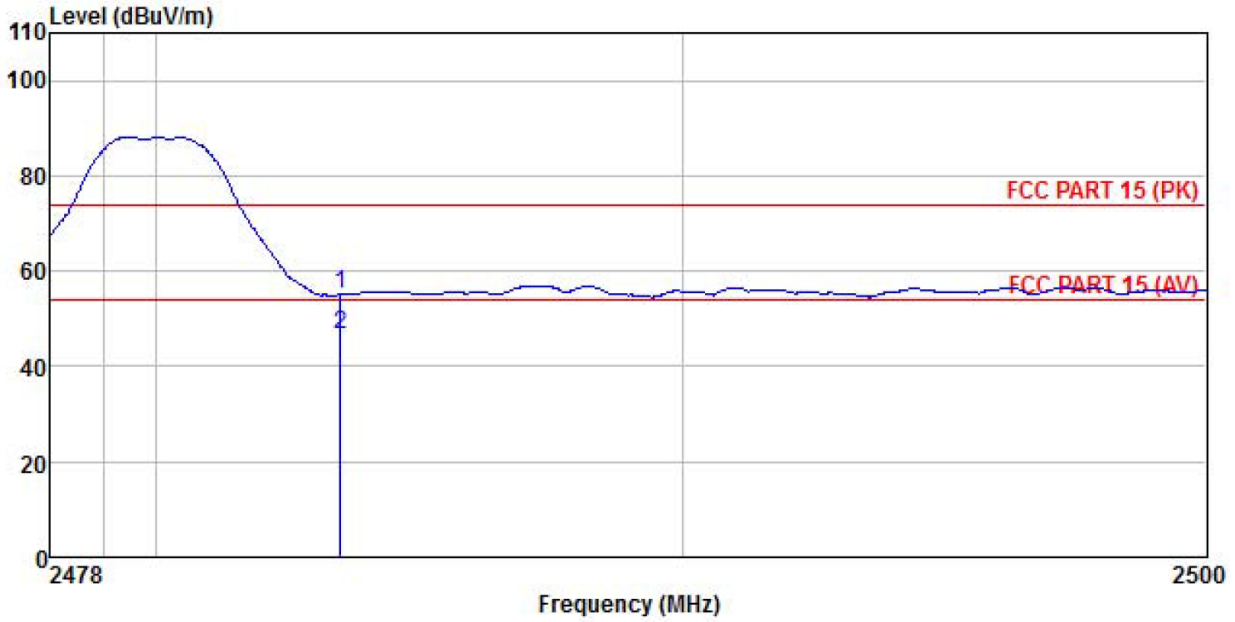

	Read	Antenna	Cable	Aux	Preamp	Level	Limit	Over	
Freq	Level	Factor	Loss	Factor	Factor	Level	Line	Limit	Remark
MHz	dBuV	dB/m	dB	dB	dB	dBuV/m	dBuV/m	dB	
1	2483.500	21.96	27.27	4.38	1.70	0.00	55.31	74.00	-18.69 Peak
2	2483.500	13.29	27.27	4.38	1.70	0.00	46.64	54.00	-7.36 Average

Remark:

1. Final Level = Receiver Read level + Antenna Factor + Cable Loss – Preamplifier Factor.
2. The emission levels of other frequencies are lower than the limit 20dB and not show in test report.

6.7 Spurious Emission

6.7.1 Conducted Emission Method

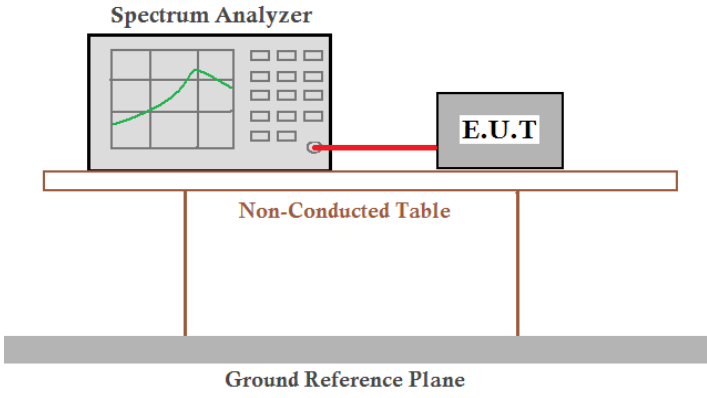
Test Requirement:	FCC Part 15 C Section 15.247 (d)
Limit:	In any 100 kHz bandwidth outside the frequency band in which the spread spectrum intentional radiator is operating, the radio frequency power that is produced by the intentional radiator shall be at least 20 dB below that in the 100 kHz bandwidth within the band that contains the highest level of the desired power, based on either an RF conducted or a radiated measurement.
Test setup:	 <p>The diagram illustrates the test setup. A Spectrum Analyzer is connected to an E.U.T. (Equipment Under Test) via a red cable. Both are placed on a Non-Conducted Table, which sits on a Ground Reference Plane.</p>
Test Instruments:	Refer to section 5.9 for details
Test mode:	Refer to section 5.3 for details
Test results:	Passed

Test plot as follows:

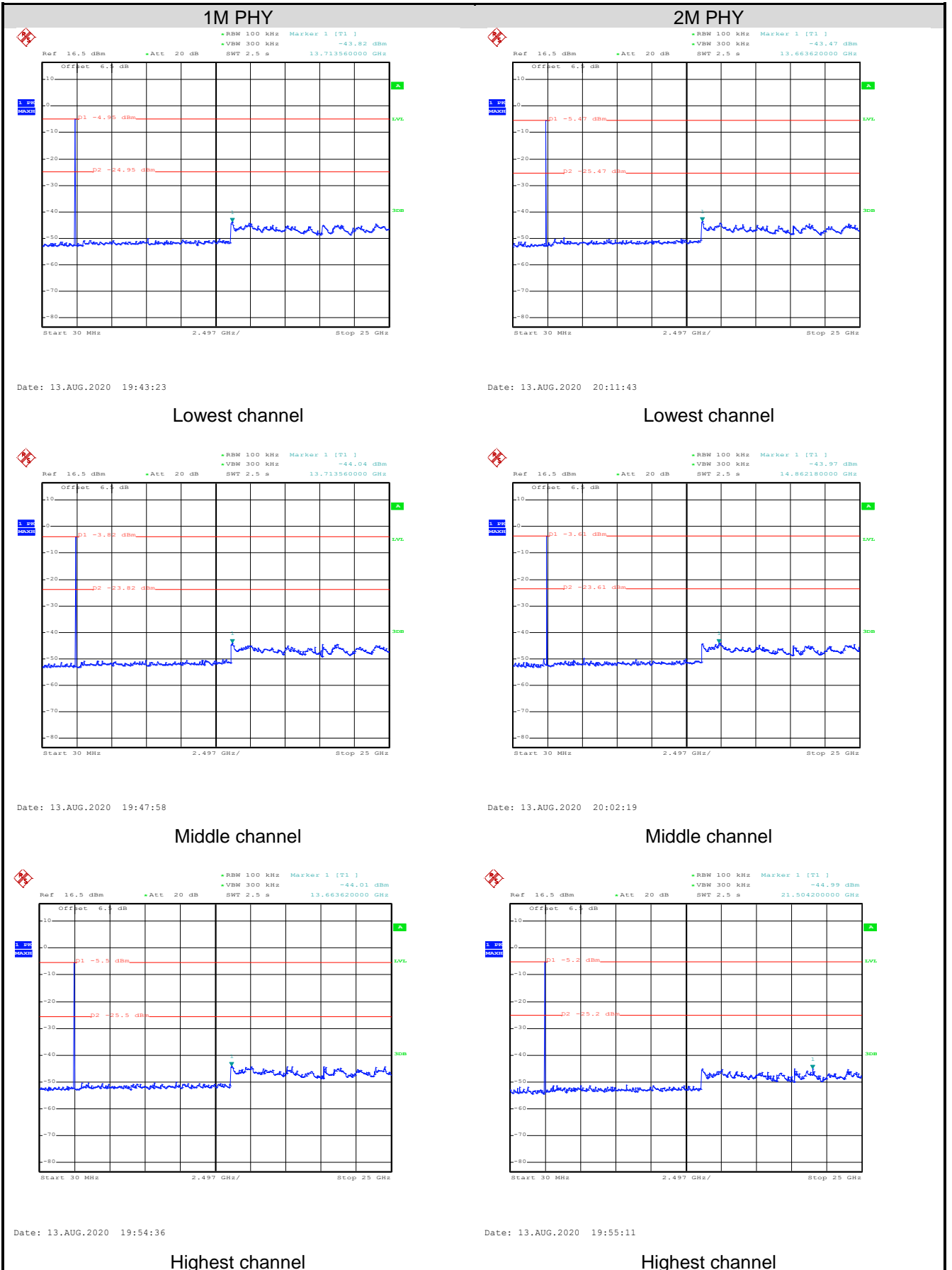

6.7.2 Radiated Emission Method

Test Requirement:	FCC Part 15 C Section 15.205 and 15.209				
Test Frequency Range:	9kHz to 25GHz				
Test Distance:	3m				
Receiver setup:	Frequency	Detector	RBW	VBW	Remark
	30MHz-1GHz	Quasi-peak	120KHz	300KHz	Quasi-peak Value
	Above 1GHz	Peak	1MHz	3MHz	Peak Value
RMS		1MHz	3MHz	Average Value	
Limit:	Frequency	Limit (dBuV/m @3m)		Remark	
	30MHz-88MHz	40.0		Quasi-peak Value	
	88MHz-216MHz	43.5		Quasi-peak Value	
	216MHz-960MHz	46.0		Quasi-peak Value	
	960MHz-1GHz	54.0		Quasi-peak Value	
	Above 1GHz	54.0		Average Value	
74.0		Peak Value			
Test Procedure:	<ol style="list-style-type: none"> 1. The EUT was placed on the top of a rotating table 0.8m(below 1GHz)/1.5m(above 1GHz) above the ground at a 3 meter camber. The table was rotated 360 degrees to determine the position of the highest radiation. 2. The EUT was set 3 meters away from the interference-receiving antenna, which was mounted on the top of a variable-height antenna tower. 3. The antenna height is varied from one meter to four meters above the ground to determine the maximum value of the field strength. Both horizontal and vertical polarizations of the antenna are set to make the measurement. 4. For each suspected emission, the EUT was arranged to its worst case and then the antenna was tuned to heights from 1 meter to 4 meters and the rota table was turned from 0 degrees to 360 degrees to find the maximum reading. 5. The test-receiver system was set to Peak Detect Function and Specified Bandwidth with Maximum Hold Mode. 6. If the emission level of the EUT in peak mode was 10 dB lower than the limit specified, then testing could be stopped and the peak values of the EUT would be reported. Otherwise the emissions that did not have 10 dB margin would be re-tested one by one using peak, quasi-peak or average method as specified and then reported in a data sheet. 				
Test setup:	<p>Below 1GHz</p> <p>Above 1GHz</p>				

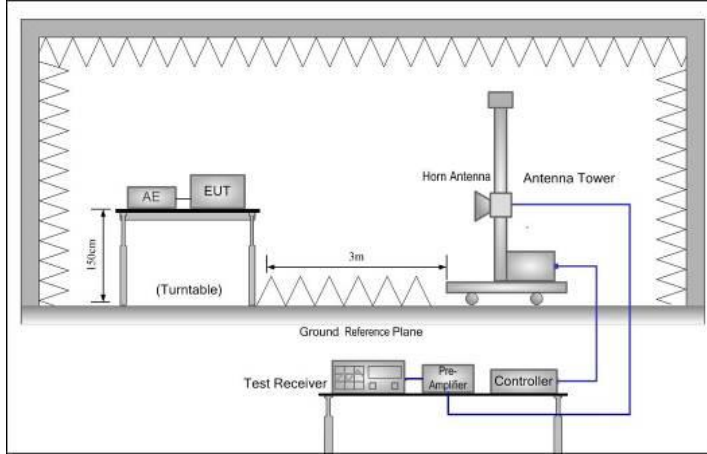

Test Instruments:	Refer to section 5.9 for details
Test mode:	Refer to section 5.3 for details
Test results:	Passed
Remark:	<ol style="list-style-type: none"> 1. Pre-scan all kind of the place mode (X-axis, Y-axis, Z-axis), and found the Y-axis is the worst case. 2. 9 kHz to 30MHz is lower than the limit 20dB, so only shows the data of above 30MHz in this report.

Measurement Data (worst case):

Below 1GHz:

Product Name:	Smart Phone	Product Model:	W4
Test By:	Yaro	Test mode:	BLE Tx mode
Test Frequency:	30 MHz ~ 1 GHz	Polarization:	Vertical
Test Voltage:	AC 120/60Hz	Environment:	Temp: 24°C Humi: 57%

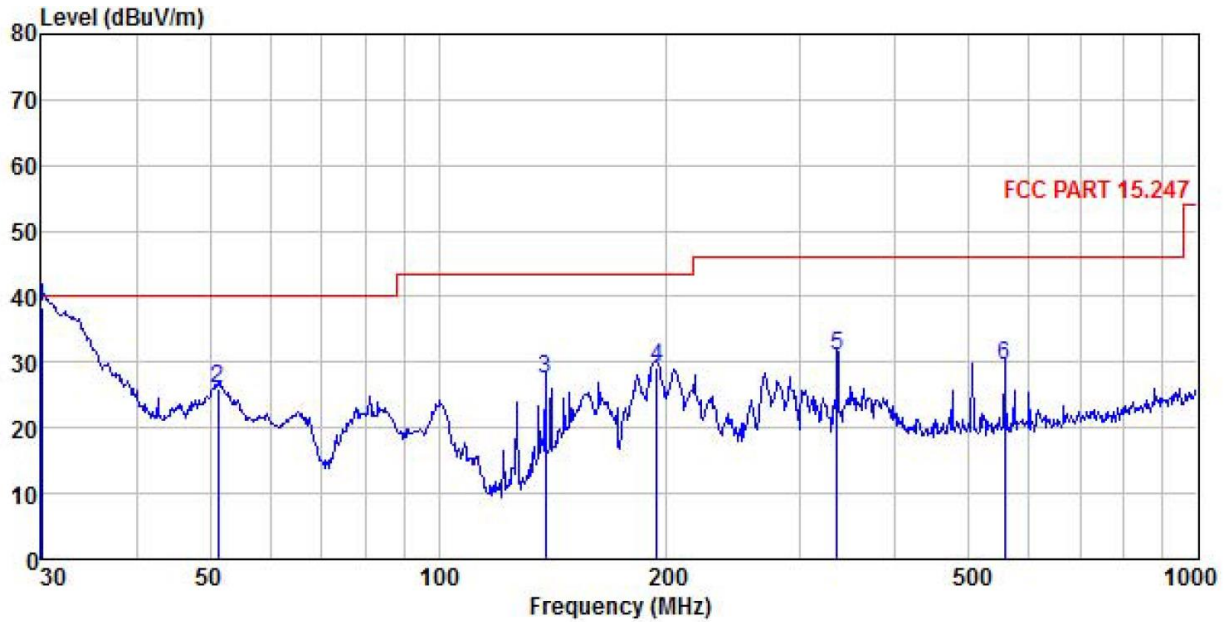

	Read	Antenna	Cable	Aux	Preamp	Limit	Over	
Freq	Level	Factor	Loss	Factor	Factor	Level	Line	Limit Remark
MHz	dBuV	dB/m	dB	dB	dB	dBuV/m	dBuV/m	dB
1	30.000	56.02	11.80	0.40	0.00	29.98	38.24	40.00 -1.76 QP
2	51.301	42.66	12.71	0.39	0.00	29.81	25.95	40.00 -14.05 QP
3	138.387	42.47	13.71	0.60	0.00	29.28	27.50	43.50 -16.00 QP
4	193.773	39.83	17.70	0.71	0.00	28.87	29.37	43.50 -14.13 QP
5	334.859	39.90	18.77	0.91	0.00	28.53	31.05	46.00 -14.95 QP
6	556.774	37.74	19.64	1.17	0.00	29.08	29.47	46.00 -16.53 QP

Remark:

1. Final Level = Receiver Read level + Antenna Factor + Cable Loss – Pre-amplifier Factor.
2. The emission levels of other frequencies are lower than the limit 20dB and not show in test report.
3. The Aux Factor is a notch filter switch box loss, this item is not used.

Product Name:	Smart Phone	Product Model:	W4
Test By:	Yaro	Test mode:	BLE Tx mode
Test Frequency:	30 MHz ~ 1 GHz	Polarization:	Horizontal
Test Voltage:	AC 120/60Hz	Environment:	Temp: 24°C Humi: 57%

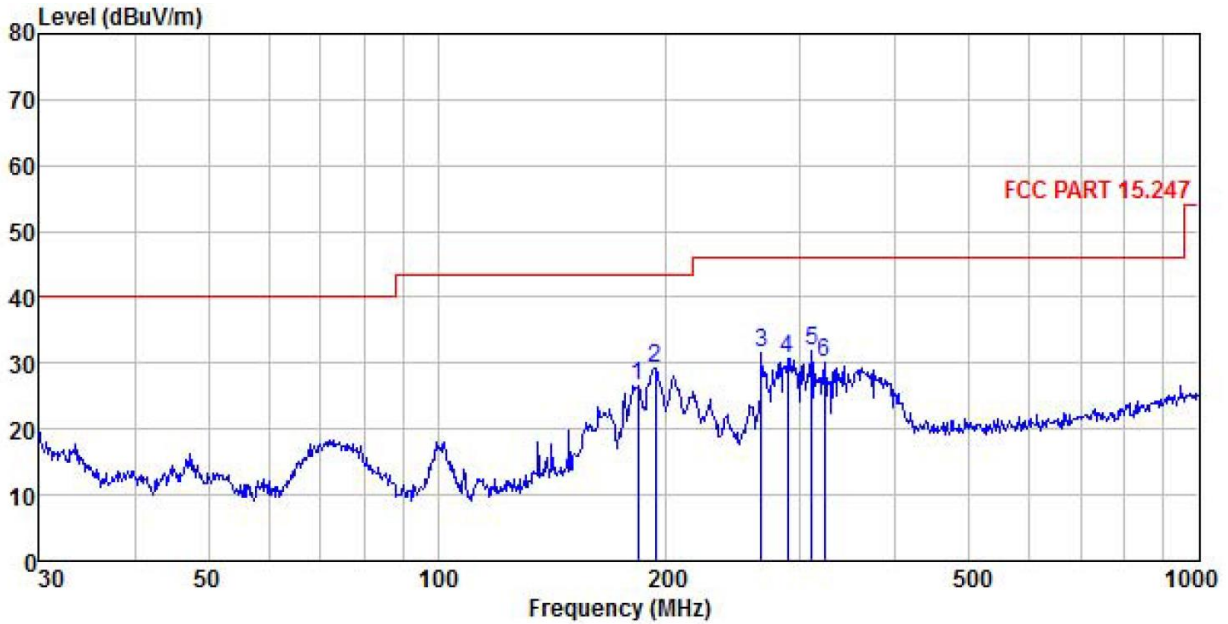

	Read Freq	Antenna Level	Antenna Factor	Cable Loss	Aux Factor	Preamp Factor	Level	Limit Line	Over Limit	Remark
	MHz	dBuV	dB/m	dB	dB	dB	dBuV/m	dBuV/m	dB	
1	183.201	37.71	17.09	0.69	0.00	28.95	26.54	43.50	-16.96	QP
2	193.095	39.85	17.65	0.71	0.00	28.88	29.33	43.50	-14.17	QP
3	266.609	40.67	18.57	0.81	0.00	28.51	31.54	46.00	-14.46	QP
4	287.990	39.59	18.65	0.85	0.00	28.47	30.62	46.00	-15.38	QP
5	309.998	40.75	18.72	0.87	0.00	28.47	31.87	46.00	-14.13	QP
6	322.189	38.96	18.75	0.89	0.00	28.50	30.10	46.00	-15.90	QP

Remark:

1. Final Level = Receiver Read level + Antenna Factor + Cable Loss – Pre-amplifier Factor.
2. The emission levels of other frequencies are lower than the limit 20dB and not show in test report.
3. The Aux Factor is a notch filter switch box loss, this item is not used.

**Above 1GHz
1M PHY:**

Test channel: Lowest channel									
Detector: Peak Value									
Frequency (MHz)	Read Level (dBuV)	Antenna Factor (dB/m)	Cable Loss (dB)	Aux Factor (dB)	Preamp Factor (dB)	Level (dBuV/m)	Limit Line (dBuV/m)	Over Limit (dB)	Polarization
4804.00	47.93	30.78	6.80	2.44	41.81	46.14	74.00	-27.86	Vertical
4804.00	48.35	30.78	6.80	2.44	41.81	46.56	74.00	-27.44	Horizontal
Detector: Average Value									
Frequency (MHz)	Read Level (dBuV)	Antenna Factor (dB/m)	Cable Loss (dB)	Aux Factor (dB)	Preamp Factor (dB)	Level (dBuV/m)	Limit Line (dBuV/m)	Over Limit (dB)	Polarization
4804.00	39.34	30.78	6.80	2.44	41.81	37.55	54.00	-16.45	Vertical
4804.00	40.60	30.78	6.80	2.44	41.81	38.81	54.00	-15.19	Horizontal
Test channel: Middle channel									
Detector: Peak Value									
Frequency (MHz)	Read Level (dBuV)	Antenna Factor (dB/m)	Cable Loss (dB)	Aux Factor (dB)	Preamp Factor (dB)	Level (dBuV/m)	Limit Line (dBuV/m)	Over Limit (dB)	Polarization
4884.00	47.91	30.96	6.86	2.47	41.84	46.36	74.00	-27.64	Vertical
4884.00	48.26	30.96	6.86	2.47	41.84	46.71	74.00	-27.29	Horizontal
Detector: Average Value									
Frequency (MHz)	Read Level (dBuV)	Antenna Factor (dB/m)	Cable Loss (dB)	Aux Factor (dB)	Preamp Factor (dB)	Level (dBuV/m)	Limit Line (dBuV/m)	Over Limit (dB)	Polarization
4884.00	39.29	30.96	6.86	2.47	41.84	37.74	54.00	-16.26	Vertical
4884.00	40.96	30.96	6.86	2.47	41.84	39.41	54.00	-14.59	Horizontal
Test channel: Highest channel									
Detector: Peak Value									
Frequency (MHz)	Read Level (dBuV)	Antenna Factor (dB/m)	Cable Loss (dB)	Aux Factor (dB)	Preamp Factor (dB)	Level (dBuV/m)	Limit Line (dBuV/m)	Over Limit (dB)	Polarization
4960.00	47.94	31.11	6.91	2.49	41.87	46.58	74.00	-27.42	Vertical
4960.00	48.12	31.11	6.91	2.49	41.87	46.76	74.00	-27.24	Horizontal
Detector: Average Value									
Frequency (MHz)	Read Level (dBuV)	Antenna Factor (dB/m)	Cable Loss (dB)	Aux Factor (dB)	Preamp Factor (dB)	Level (dBuV/m)	Limit Line (dBuV/m)	Over Limit (dB)	Polarization
4960.00	39.68	31.11	6.91	2.49	41.87	38.32	54.00	-15.68	Vertical
4960.00	40.57	31.11	6.91	2.49	41.87	39.21	54.00	-14.79	Horizontal
<i>Remark:</i>									
1. <i>Final Level = Receiver Read level + Antenna Factor + Cable Loss + Aux Factor – Pre-amplifier Factor.</i>									
2. <i>The emission levels of other frequencies are lower than the limit 20dB and not show in test report.</i>									

2M PHY:

Test channel: Lowest channel									
Detector: Peak Value									
Frequency (MHz)	Read Level (dBuV)	Antenna Factor (dB/m)	Cable Loss (dB)	Aux Factor (dB)	Preamp Factor (dB)	Level (dBuV/m)	Limit Line (dBuV/m)	Over Limit (dB)	Polarization
4804.00	48.39	30.78	6.80	2.44	41.81	46.60	74.00	-27.40	Vertical
4804.00	48.74	30.78	6.80	2.44	41.81	46.95	74.00	-27.05	Horizontal
Detector: Average Value									
Frequency (MHz)	Read Level (dBuV)	Antenna Factor (dB/m)	Cable Loss (dB)	Aux Factor (dB)	Preamp Factor (dB)	Level (dBuV/m)	Limit Line (dBuV/m)	Over Limit (dB)	Polarization
4804.00	39.51	30.78	6.80	2.44	41.81	37.72	54.00	-16.28	Vertical
4804.00	40.18	30.78	6.80	2.44	41.81	38.39	54.00	-15.61	Horizontal
Test channel: Middle channel									
Detector: Peak Value									
Frequency (MHz)	Read Level (dBuV)	Antenna Factor (dB/m)	Cable Loss (dB)	Aux Factor (dB)	Preamp Factor (dB)	Level (dBuV/m)	Limit Line (dBuV/m)	Over Limit (dB)	Polarization
4884.00	48.36	30.96	6.86	2.47	41.84	46.81	74.00	-27.19	Vertical
4884.00	48.53	30.96	6.86	2.47	41.84	46.98	74.00	-27.02	Horizontal
Detector: Average Value									
Frequency (MHz)	Read Level (dBuV)	Antenna Factor (dB/m)	Cable Loss (dB)	Aux Factor (dB)	Preamp Factor (dB)	Level (dBuV/m)	Limit Line (dBuV/m)	Over Limit (dB)	Polarization
4884.00	39.66	30.96	6.86	2.47	41.84	38.11	54.00	-15.89	Vertical
4884.00	40.53	30.96	6.86	2.47	41.84	38.98	54.00	-15.02	Horizontal
Test channel: Highest channel									
Detector: Peak Value									
Frequency (MHz)	Read Level (dBuV)	Antenna Factor (dB/m)	Cable Loss (dB)	Aux Factor (dB)	Preamp Factor (dB)	Level (dBuV/m)	Limit Line (dBuV/m)	Over Limit (dB)	Polarization
4960.00	48.76	31.11	6.91	2.49	41.87	47.40	74.00	-26.60	Vertical
4960.00	48.92	31.11	6.91	2.49	41.87	47.56	74.00	-26.44	Horizontal
Detector: Average Value									
Frequency (MHz)	Read Level (dBuV)	Antenna Factor (dB/m)	Cable Loss (dB)	Aux Factor (dB)	Preamp Factor (dB)	Level (dBuV/m)	Limit Line (dBuV/m)	Over Limit (dB)	Polarization
4960.00	39.81	31.11	6.91	2.49	41.87	38.45	54.00	-15.55	Vertical
4960.00	40.69	31.11	6.91	2.49	41.87	39.33	54.00	-14.67	Horizontal
<p>Remark:</p> <ol style="list-style-type: none"> Final Level = Receiver Read level + Antenna Factor + Cable Loss + Aux Factor – Preamplifier Factor. The emission levels of other frequencies are lower than the limit 20dB and not show in test report. 									