

# User Manual for T200 Remote Training Collar

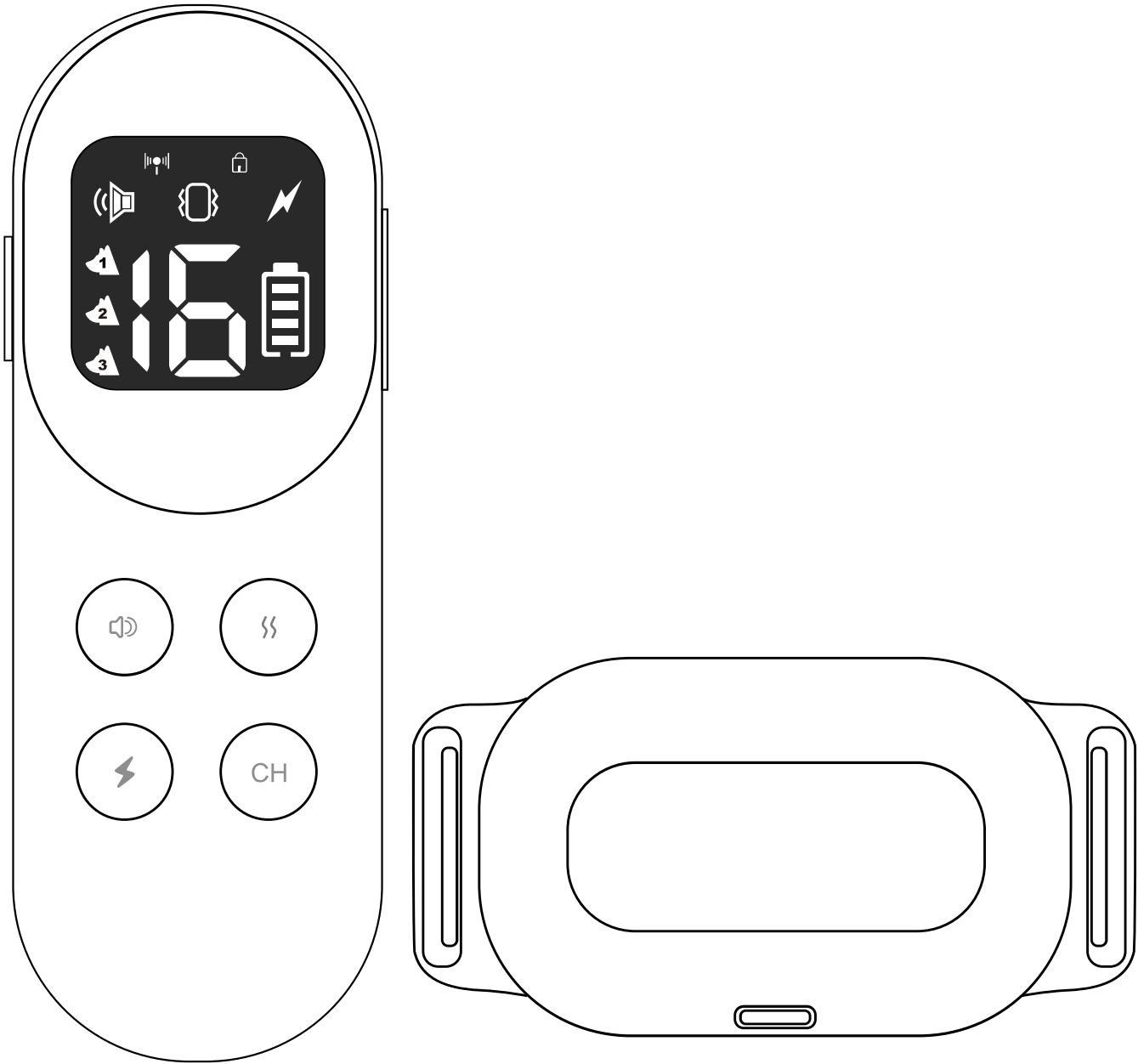

Please read this manual carefully before use

# Contents

<b>How It Works</b> .....	<b>1</b>
<b>Components</b> .....	<b>1</b>
<b>Description</b> .....	<b>2</b>
<b>Operating Instructions</b> .....	<b>3</b>
Charging .....	3
Product test .....	3
Power on/off .....	4
Function operations .....	6
Pairing .....	8
<b>Precautions</b> .....	<b>8</b>
<b>Troubleshooting</b> .....	<b>10</b>
<b>Frequently Asked Questions</b> .....	<b>11</b>
<b>Compliance</b> .....	<b>12</b>

# How It Works

Thanks for choosing our product. T200 dog training collar allows you to control your pet dog from a distance up to 300m without using a leash. It helps you reinforce the behaviors you want from your dog, such as coming when called. They also let you correct chasing, digging, and other unwanted behaviors. When you push a button on the handheld remote, your dog will receive a stimulation (such as tone, vibration and static pulse) from his electronic collar. The stimulation gets his attention and lets you communicate clearly and consistently. T200 is suitable for various dogs sizes from small to large, and has been proved by dog trainers to be safe, reliable and effective.

## Components

- ① Transmitter \* 1
- ② Receiver (including collar) \* 1
- ③ Magnetic charging cable \* 1
- ④ Static stimulation test light \* 1
- ⑤ Long/short static stimulation pulse prong \* 2 pairs
- ⑥ Long/short silicon cap \* 2 pairs
- ⑦ User manual \* 1

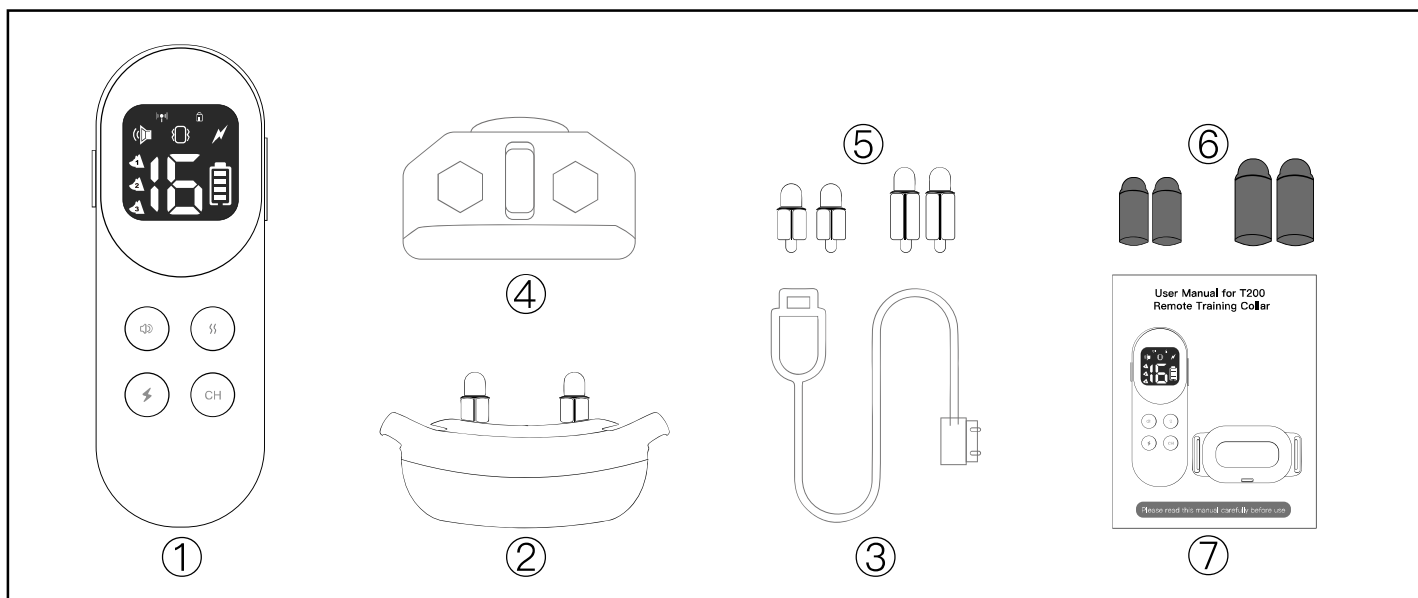

# Description

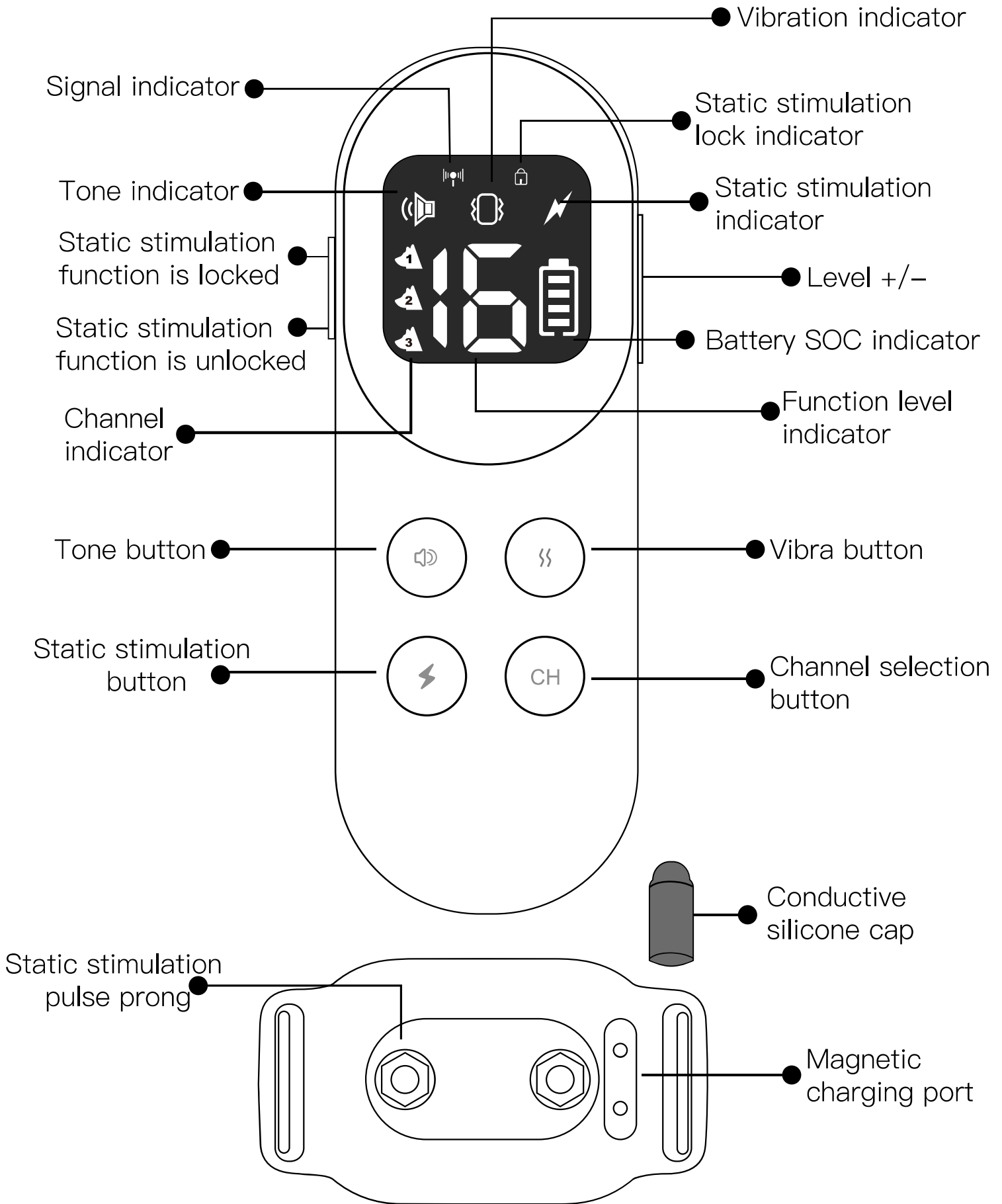

# Operating Instructions

## ① Charging: (Please charge the equipment before use!)

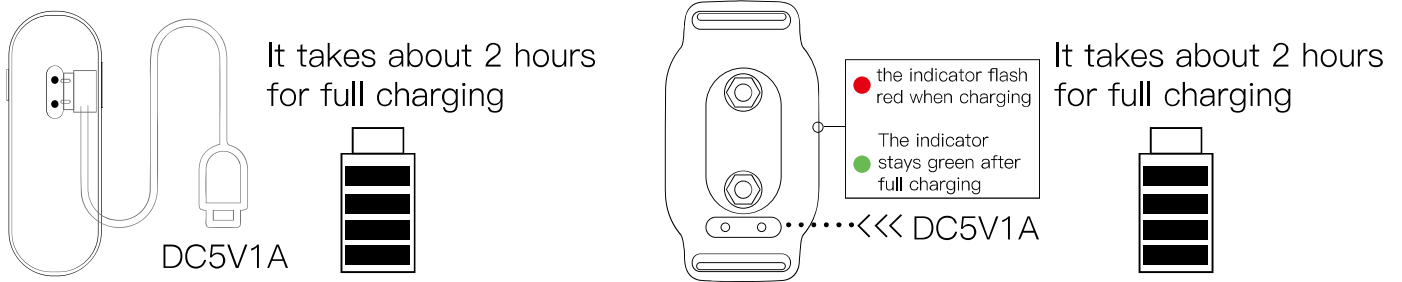

1. Attach the magnetic charging port to the charging jack properly until a good contact is ensured; Plug the charging cable USB to the output end of the 5V1A charger; It takes about 2 hours for full charging. When the transmitter is being charged, the battery SOC indicator scrolls, and when the transmitter is fully charged, the SOC indicator stops scrolling. When the receiver collar is being charged, the indicator flash red, and indicator turns green after fully charged.

## ② How to use and test static stimulation

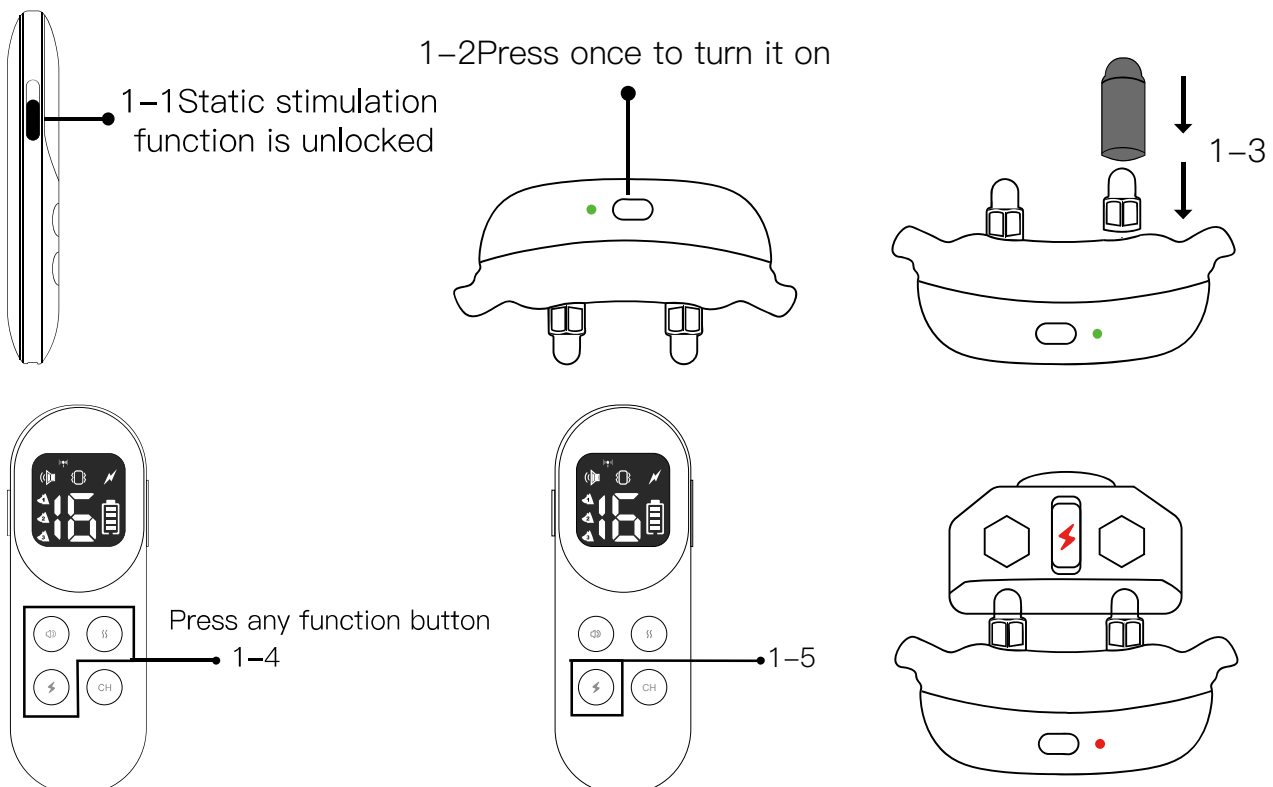

1.1 Press any button will activate the transmitter, adjust the toggle switch on the left side of the transmitter down, make the static stimulation function is unlocked.

1.2 Press the power button once to turn on the receiver (Factory settings default CH1 pairing, if you need to re pairing, please refer to the operating instructions )

1.3 Install the static stimulation pulse prong, and conductive silicone cap to the receiver.

1.4 Press any function button (VIBRA/STATIC STIMULATION/TONE) of the remote control, and the receiver will emit corresponding signal.

1.5 Test static stimulation: when the receiver is successfully pairing, put the test light on the receiver, and press the static stimulation button of the remote control, the test light will display a red current.

### ③ Power on/off:

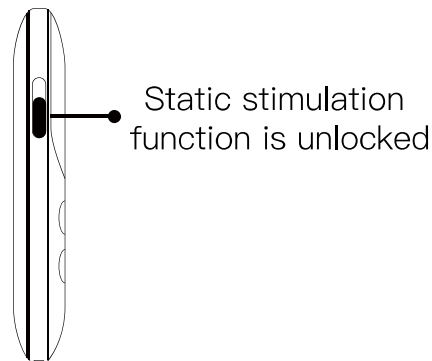
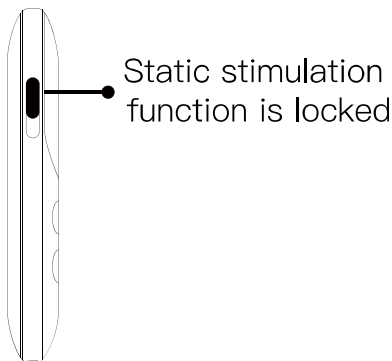

Press any button will activate the transmitter.

A: Located on the left side of the transmitter is a toggle switch

2.1 Up Button : The static stimulation function is locked

2.2 Down Button: The static stimulation function is unlocked (The backlight on the display stays on for approximately 30 seconds after a button press, and will enter standby mode after 60 seconds, which can be activated by press any button)

## Receiver Collar:

1. Press the power button once to turn on the receiver, you will hear a beep, and the indicator flashes green; Press the power button once to turn off the receiver, you will hear two beeps, and the indicator flashes red.

2. When the receiver is low battery, the indicator flashes in red quickly.

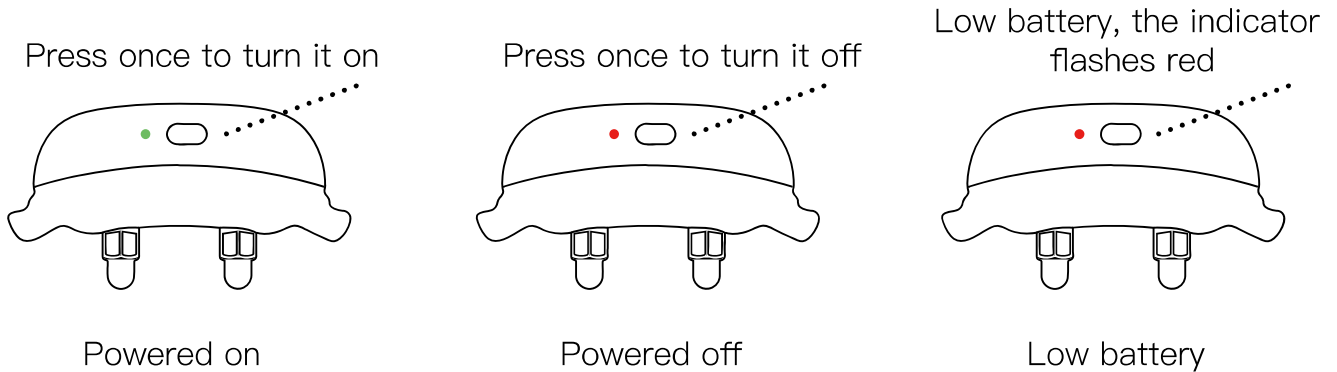

When the receiver collar works normally, the working light flashes in green quickly until the receiver collar stops working.

\* Wake-up function: If the transmitter and receiver collar are on the normal power-on/standby mode, press any function button on the transmitter will wake up the receiver.

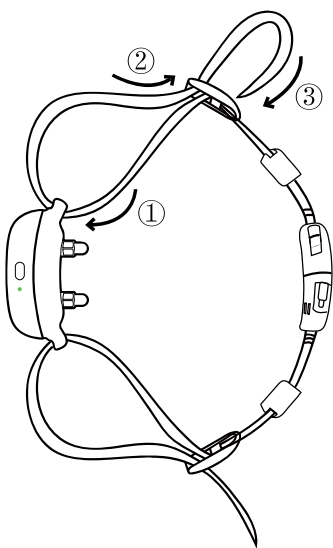

How to wear the strap

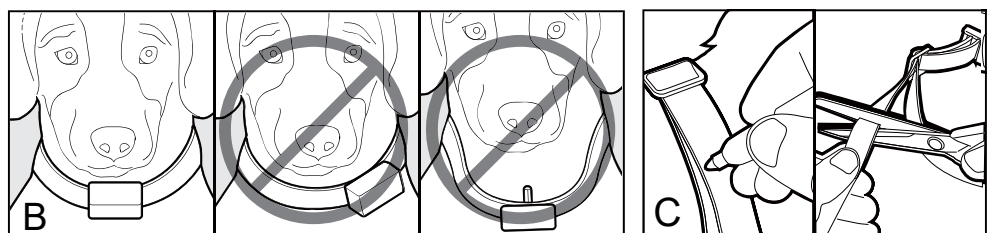
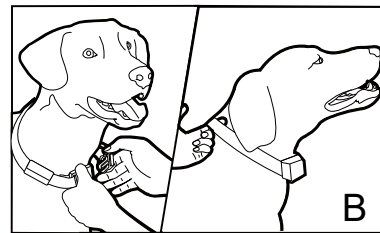
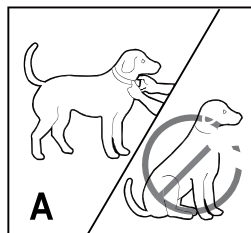

The proper fit and placement of your Receiver Collar is important for effective training, please follow these steps:

A. Make sure that the Receiver Collar is turned off and have your pet standing comfortably .

B. Place the Receiver Collar in the middle of the dog's neck with the switch button facing up. The Receiver Collar should fit snugly, yet loose enough to allow one finger to fit between the strap and your pet's neck.

C. Mark the desired length of the collar with a pen. Remove the Receiver Collar from your pet and cut off the excess.

## ④ Function operations

### 1. Tone function

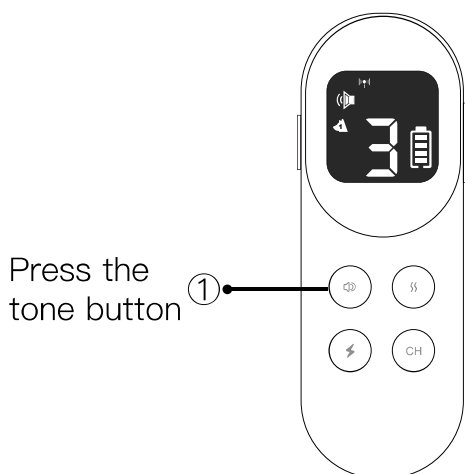

The receiver beeps and the indicator flashes green;  
The tone level is adjustable from 1– 3 levels.

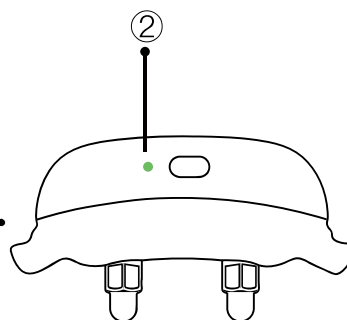

### 2. Vibration function

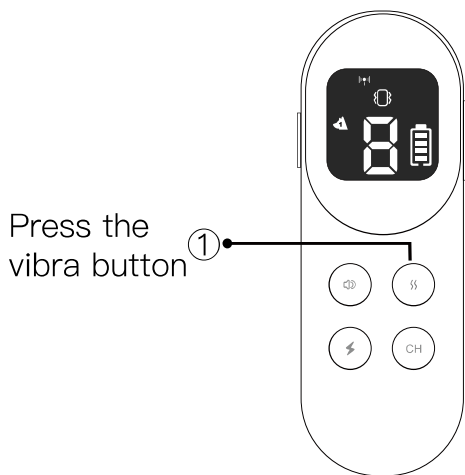

The receiver vibrates and the indicator flashes green;  
The vibration level is adjustable from 0– 8 levels.

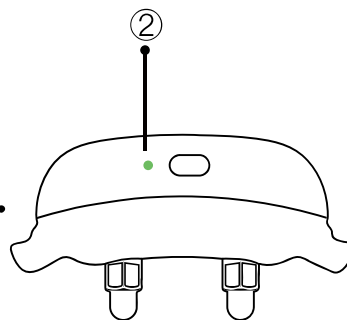



### 3.Static stimulation function

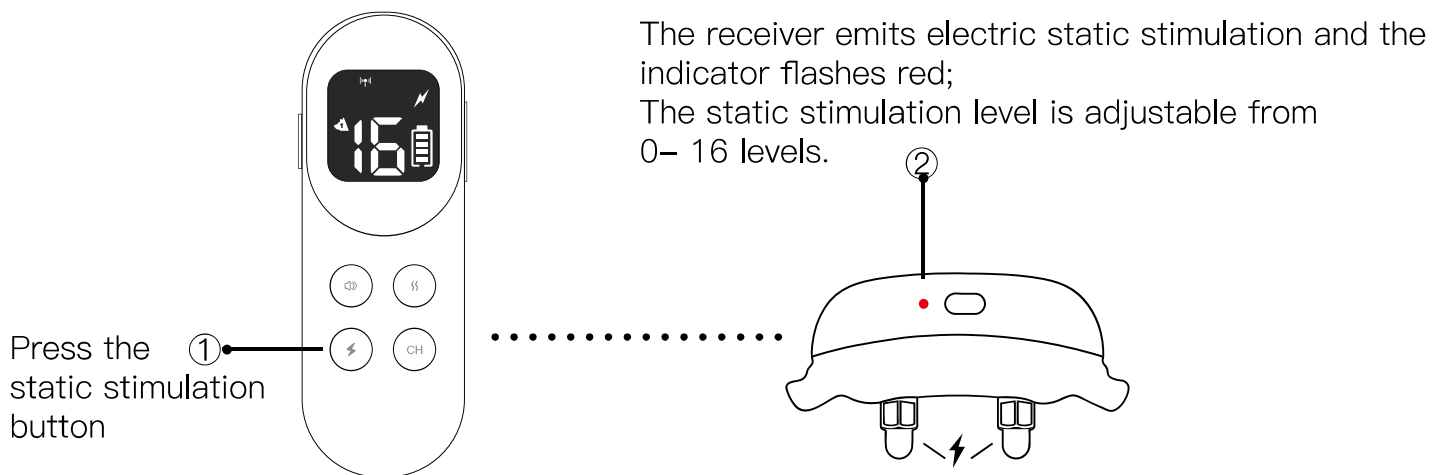

### 4. Channel switching function

Long press the transmitter channel switching (CH) button, the screen displays the current corresponding channel, then press CH button one time to choose the channel and after 3 minutes of no operation, the CH channel will be locked, long press again to open it.

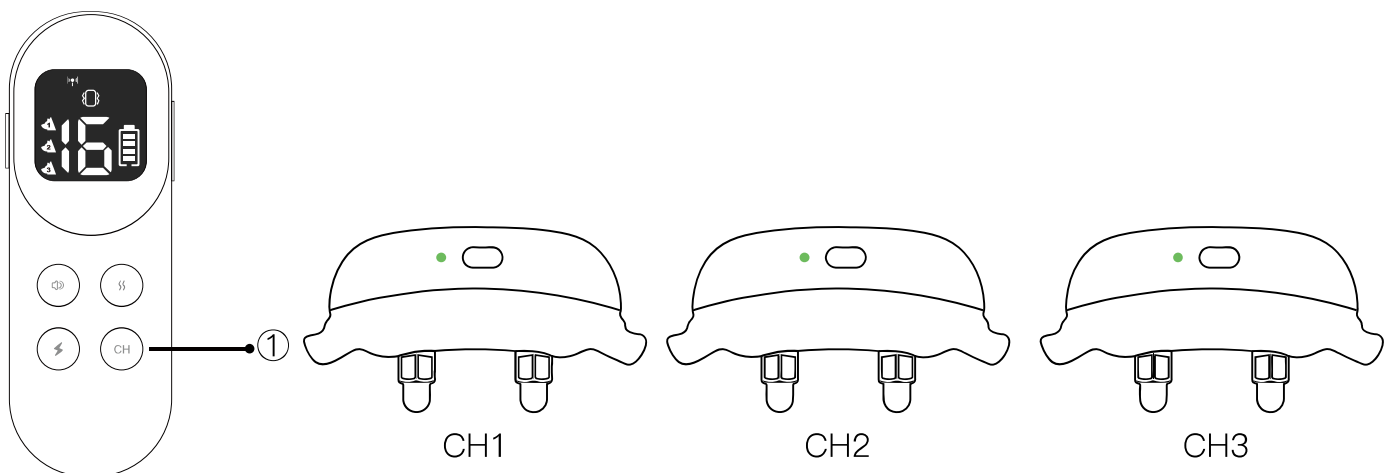

5.Level +/-: Press the level +/- button on the side of transmitter to adjust the level one by one. If the button is pressed without release, the level will increase/decrease automatically.

Note: If the TONE/VIBRA/STATIC STIMULATION button is pressed down without release, the tone/vibration function will work for 15S and the static stimulation function will work for 10S. To resume the tone/vibration/static stimulation function after this, it is required to release the button and press it again.

## 5 Pairing

1. Turn on the remote control, long press the CH button to unlock it, and then press the CH button to select a channel (CH1, CH2 or CH3). (After 3 minutes of no operation, the CH channel will be locked, long press again to open it).

2. Press the power button of the receiver collar for 3S, and then the indicator flashes quickly in red for 10s. Press any function button (VIBRA/STATIC STIMULATION/TONE) of the remote control when the indicator is flashing (within 10s).

3. To test the connection, press the tone button on the remote control, the receiver collar will beep.

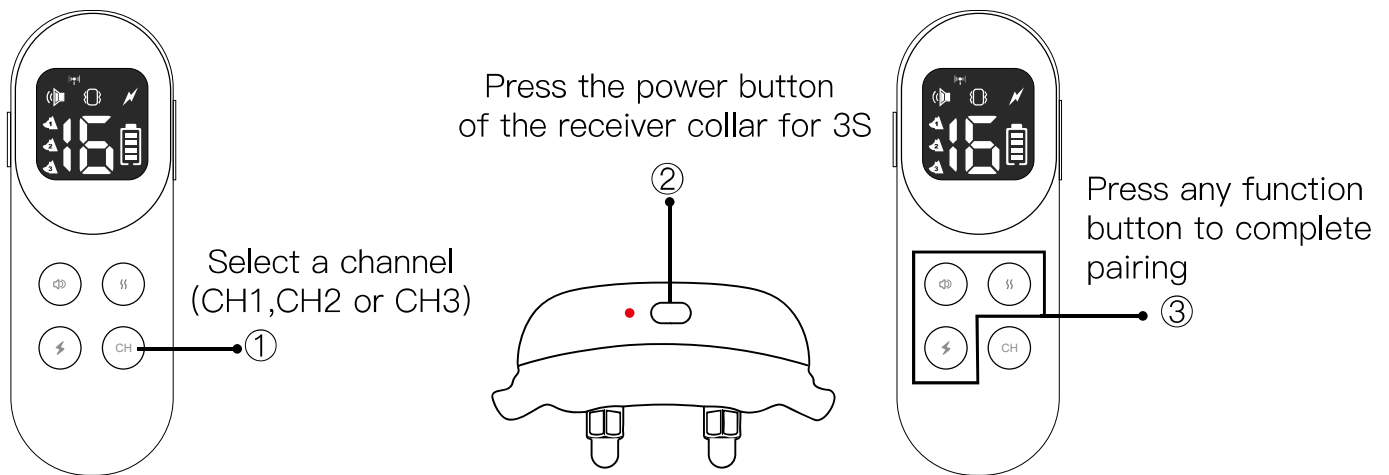

## Precautions

This is the safety alert symbol. It is used to alert you to potential personal injury hazards. Obey all safety messages that follow this symbol to avoid possible injury or death.



**WARNING** indicates a hazardous situation which, if not avoided, could result in death or serious injury.

 **CAUTION**

**CAUTION**, used with the safety alert symbol, indicates a hazardous situation which, if not avoided, could result in minor or moderate injury

 **CAUTION**

**CAUTION**, used without the safety alert symbol, indicates a hazardous situation which, if not avoided, could result in harm to your pet.

 **WARNING**

Do not use this product if your dog is prone to aggressive behavior. Aggressive dogs can cause severe injury and even death to their owner and others. If you are unsure whether this product is appropriate for your dog, please consult your veterinarian or a certified trainer.

This device contains Lithium-Ion (Li-Ion) batteries; never incinerate, puncture, deform, short-circuit, or charge with an inappropriate charger. Fire, explosion, property damage, or bodily harm may occur if this warning is not followed.

 **CAUTION**

- It is vitally important that you and your pet remain safe while learning during on-leash training. Your pet should be on a strong leash, long enough for him to attempt to chase an object, but short enough for him not to reach a road or other hazard. You must also be physically strong enough to restrain your pet when he tries to chase.
- This pet training device is not a toy, keep away from children.

## CAUTION

- Proper fit of the collar is important. A collar worn for too long or made too tight on the pet's neck may cause skin damage ranging from redness to pressure ulcers. This condition is commonly known as bed sores.
- Avoid leaving the collar on the dog for more than 12 hours per day.
- When possible reposition the collar on the pet's neck every 1 to 2 hours.
- Regularly recheck the fit to prevent excessive pressure; follow the instructions in this manual.
- You may need to trim the hair in the area of the contact points. However, never shave the dog's neck; this may lead to a rash or infection.
- Never connect a leash to a collar with contact points. It will cause excessive pressure on the contact points.
- When connecting a leash to a separate collar, do not allow it to put pressure on the training collar.
- Wash the dog's neck area and the contacts of the collar weekly with a damp cloth.
- Examine the contact area daily for signs of a rash or a sore.
- If a rash or sore is found, discontinue use of the collar until the skin has healed.
- If the condition persists beyond 48 hours, see your veterinarian.
- For additional information on bed sores and pressure necrosis, please visit our website.

This product is only for use with healthy pets. If you're not certain that your pet is in good health, we recommend that you take your pet to a veterinarian before using this product.

## Troubleshooting

1.The receiver is not working?

①Check whether the receiver is powered on, check if the indicator shows green

②Check whether the receiver has electricity

2.There is no response when pressing the static stimulation function?

Check whether the static stimulation function is unlocked

3.Can't switch channels?

Long press the transmitter channel switching (CH) button, the screen displays the current corresponding channel, then press CH button one time to choose the channel

## Frequently Asked Questions

Q: Once my pet has been trained and obeying my commands, will it have to continue to wear the receiver?

A: Probably not. You may need to reinforce training with the receiver collar from time to time.

Q: Is the receiver collar waterproof?

A: Yes. The waterproof grade is IP68

Q: How long can I continuously deliver vibration to my pet?

A: Once you press the vibration button, the vibration will last for 15S at maximum. After this, vibration cannot be delivered until you release and press the button again.

Q: How long should a training course be?

A: The training course should be kept active and short, and a duration of about 10–15 minutes is recommended to ensure a better training effect.

Q: Is there any after-sales service provided for the product?

A: Our products are provided with after-sales service. The warranty period is one year, and any problems arising from product quality problem instead of misuse are legible for warranty services.

Q: Is the vibration safe to my pet?

A: Though unpleasant, the vibration is harmless to your pet. The electronic training device requires user interaction and training to achieve the desired results.

Q: How old should my pet be to use the dog training collar?

A: Your pet should be able to recognize basic commands such as "sit" or "no move".

Pets must be at least 6 months old.

## Compliance



This symbol means that the product has been CE certified, and any product with CE mark is proved in compliance with the local regulations of EEAs.



This symbol means that the electromagnetic interference of the equipment is lower than the limit approved by the Federal Communications Commission.



Disposal of package: The package shall be disposed by type.

- Disposed as waste papers for cardboards and cartons
- Recycling for packaging cases



Disposal system: The disposal system shall be applicable to EU and other European countries and capable of collecting recyclable materials by category.

**FCC Caution:**

This device complies with part 15 of the FCC Rules. Operation is subject to the following two conditions: (1) This device may not cause harmful interference, and (2) this device must accept any interference received, including interference that may cause undesired operation.

Any Changes or modifications not expressly approved by the party responsible for compliance could void the user's authority to operate the equipment.

**Note:** This equipment has been tested and found to comply with the limits for a Class B digital device, pursuant to part 15 of the FCC Rules. These limits are designed to provide reasonable protection against harmful interference in a residential installation. This equipment generates uses and can radiate radio frequency energy and, if not installed and used in accordance with the instructions, may cause harmful interference to radio communications. However, there is no guarantee that interference will not occur in a particular installation. If this equipment does cause harmful interference to radio or television reception, which can be determined by turning the equipment off and on, the user is encouraged to try to correct the interference by one or more of the following measures:

- Reorient or relocate the receiving antenna.
- Increase the separation between the equipment and receiver.
- Connect the equipment into an outlet on a circuit different from that to which the receiver is connected.
- Consult the dealer or an experienced radio/TV technician for help.

The device has been evaluated to meet general RF exposure requirement. The device can be used in portable exposure condition without restriction.