

# TEST REPORT

Report No.: BCTC2403947947-2E

---

Applicant: YoSmart Inc.

---

Product Name: Hub 3

---

Test Model: YS1605-UC

---

Tested Date: 2024-03-25 to 2024-04-10

---

Issued Date: 2024-04-10

---

**Shenzhen BCTC Testing Co., Ltd.**



# FCC ID:2ATM71605

Product Name: Hub 3  
Trademark: N/A  
Model/Type reference: YS1605-UC  
YS1605-UA  
Prepared For: YoSmart Inc.  
Address: 15375 Barranca Parkway, Ste G-105 Irvine, CA 92618, USA  
Manufacturer: YoSmart Inc.  
Address: 15375 Barranca Parkway, Ste G-105 Irvine, CA 92618, USA  
Prepared By: Shenzhen BCTC Testing Co., Ltd.  
Address: 1-2/F., Building B, Pengzhou Industrial Park, No.158, Fuyuan 1st Road, Zhancheng, Fuhai Subdistrict, Bao'an District, Shenzhen, Guangdong, China  
Sample Received Date: 2024-03-25  
Sample tested Date: 2024-03-25 to 2024-04-10  
Issue Date: 2024-04-10  
Report No.: BCTC2403947947-2E  
Test Standards: FCC Part15.249  
ANSI C63.10-2013  
Test Results: PASS

Tested by:



Tang Changyu/ Project Handler

Approved by:



Zero Zhou/Reviewer

The test report is effective only with both signature and specialized stamp. This result(s) shown in this report refer only to the sample(s) tested. Without written approval of Shenzhen BCTC Testing Co., Ltd, this report can't be reproduced except in full. The tested sample(s) and the sample information are provided by the client.

## Table Of Content

Test Report Declaration	Page
1. Version .....	4
2. Test Summary .....	5
3. Measurement Uncertainty .....	6
4. Product Information And Test Setup .....	7
4.1 Product Information.....	7
4.2 Test Setup Configuration .....	7
4.3 Support Equipment .....	8
4.4 Channel List.....	8
4.5 Test Mode.....	8
5. Test Facility And Test Instrument Used .....	9
5.1 Test Facility.....	9
5.2 Test Instrument Used.....	9
6. Conducted Emissions.....	11
6.1 Block Diagram Of Test Setup.....	11
6.2 Limit .....	11
6.3 Test Procedure .....	11
6.4 EUT Operating Conditions .....	11
6.5 Test Result.....	12
7. Radiated Emissions.....	14
7.1 Block Diagram Of Test Setup.....	14
7.2 Limit .....	15
7.3 Test Procedure .....	16
7.4 EUT Operating Conditions .....	17
7.5 Test Result.....	18
7.6 Field Strength Calculation .....	22
8. 100 KHz Bandwidth Of Frequency Band Edge.....	23
8.1 Block Diagram Of Test Setup.....	23
8.2 Applicable Standard .....	23
8.3 Test Procedure .....	23
8.4 EUT Operating Conditions .....	23
8.5 Test Result.....	24
9. 20 Db Bandwidth .....	26
9.1 Block Diagram Of Test Setup.....	26
9.2 Limit .....	26
9.3 Test Procedure .....	26
9.4 EUT Operation Conditions .....	26
10. Calculation of Average Factor .....	28
11. Antenna Requirement .....	30
11.1 Limit .....	30
11.2 Test Result.....	30
12. EUT Photographs.....	31
13. EUT Test Setup Photographs.....	32

(Note: N/A means not applicable)

**1. Version**

Report No.	Issue Date	Description	Approved
BCTC2403947947-2E	2024-04-10	Original	Valid

TEC  
TC  
OVB  
t See

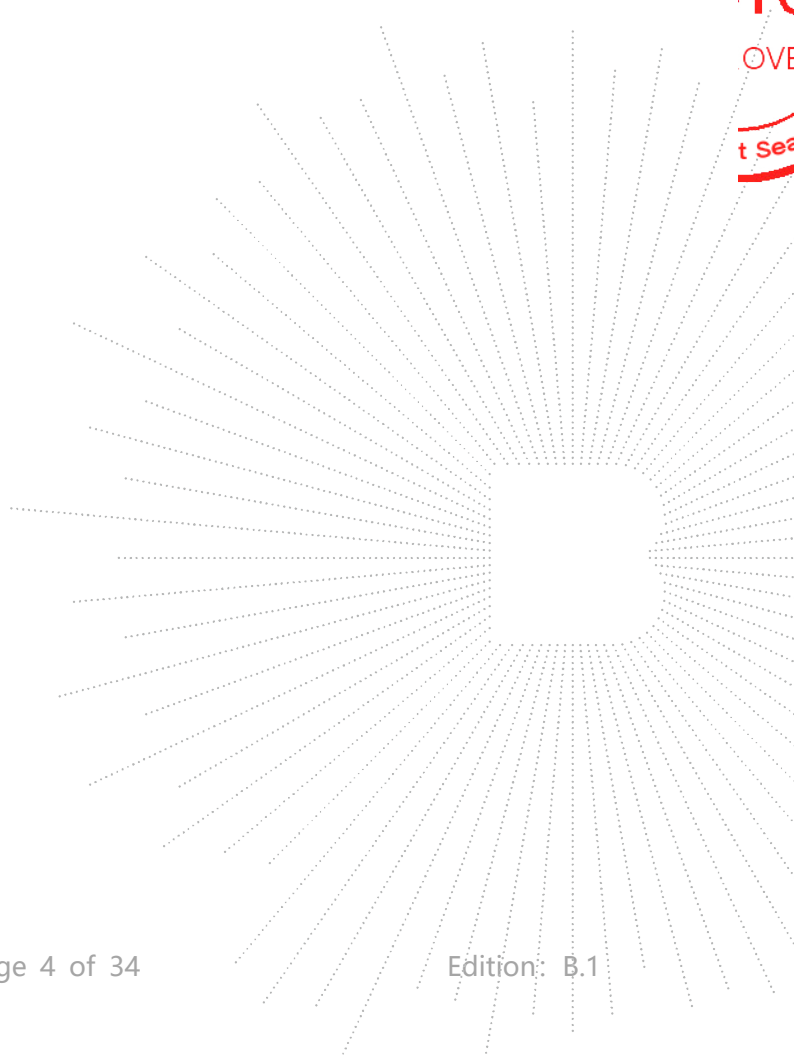

## 2. Test Summary

The Product has been tested according to the following specifications:

No.	Test Parameter	Clause No.	Results
1	Conducted Emission	15.207	PASS
2	20dB Bandwidth	15.215	PASS
3	Fundamental & Radiated Spurious Emission Measurement	15.249	PASS
4	Band Edge Emission	15.205	PASS
5	Antenna Requirement	15.203	PASS

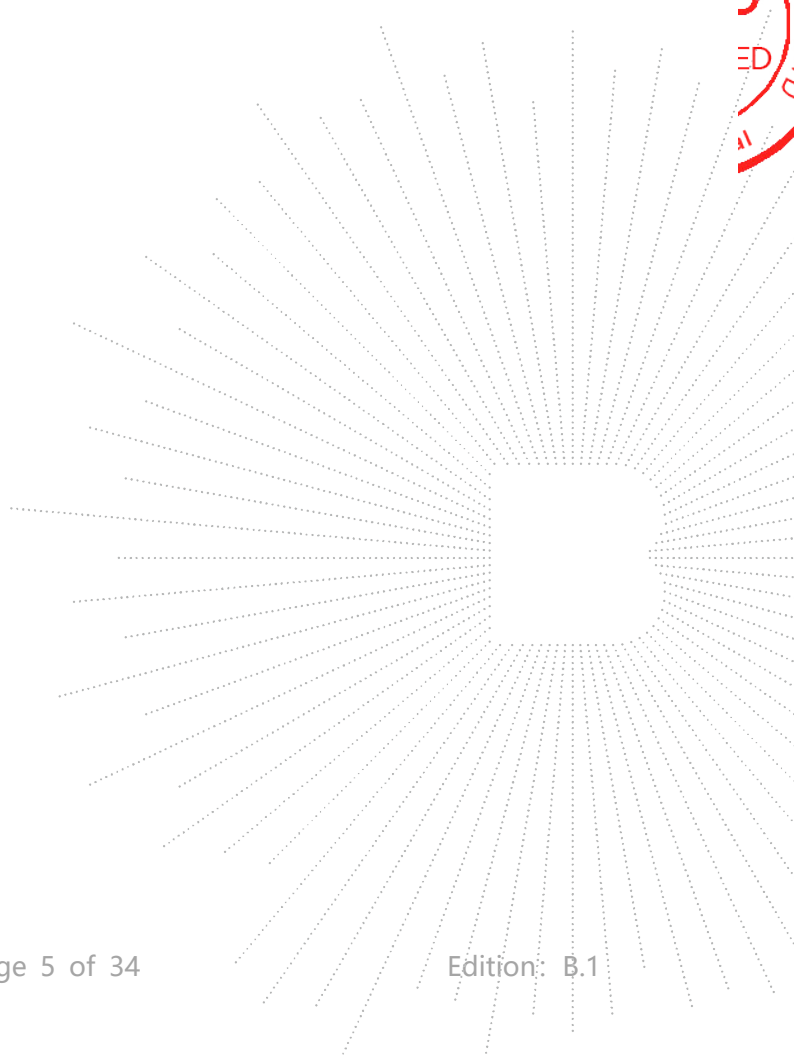

### 3. Measurement Uncertainty

Where relevant, the following measurement uncertainty levels have been estimated for tests performed on the Product as specified in CISPR 16-4-2. This uncertainty represents an expanded uncertainty expressed at approximately the 95% confidence level using a coverage factor of k=2.

No.	Item	Uncertainty
1	3m chamber Radiated spurious emission(9kHz-30MHz)	U=3.7dB
2	3m chamber Radiated spurious emission(30MHz-1GHz)	U=4.3dB
3	3m chamber Radiated spurious emission(1GHz-18GHz)	U=4.5dB
4	3m chamber Radiated spurious emission(18GHz-40GHz)	U=3.34dB
5	Conducted Emission(150kHz-30MHz)	U=3.20dB
6	Conducted Adjacent channel power	U=1.38dB
7	Conducted output power uncertainty Above 1G	U=1.576dB
8	Conducted output power uncertainty below 1G	U=1.28dB
9	humidity uncertainty	U=5.3%
10	Temperature uncertainty	U=0.59°C

 CO. LTD

## 4. Product Information And Test Setup

### 4.1 Product Information

Model/Type reference:	YS1605-JC YS1605-UA
Hardware Version:	All the model are the same circuit and RF module, except model names and appearance of the color.
Software Version:	N/A
Operation Frequency:	923.3MHz
Type of Modulation:	LoRa
Number Of Channel	1CH
Antenna installation:	Internal antenna -1.51 dBi
Antenna Gain:	Remark: <input checked="" type="checkbox"/> The antenna gain of the product comes from the antenna report provided by the customer, and the test data is affected by the customer information.
Rated Voltage:	DC 3.6V From Battery, DC 5V From Adapter
Adapter Information:	Model No.: GA-0502000 Input: AC 100-240V 50/60Hz 0.6A Output: DC 5V 2A

### 4.2 Test Setup Configuration

See test photographs attached in *EUT TEST SETUP PHOTOGRAPHS* for the actual connections between Product and support equipment.

Conducted Emission:

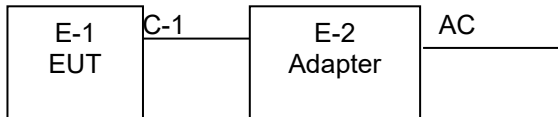

Radiated Spurious Emission

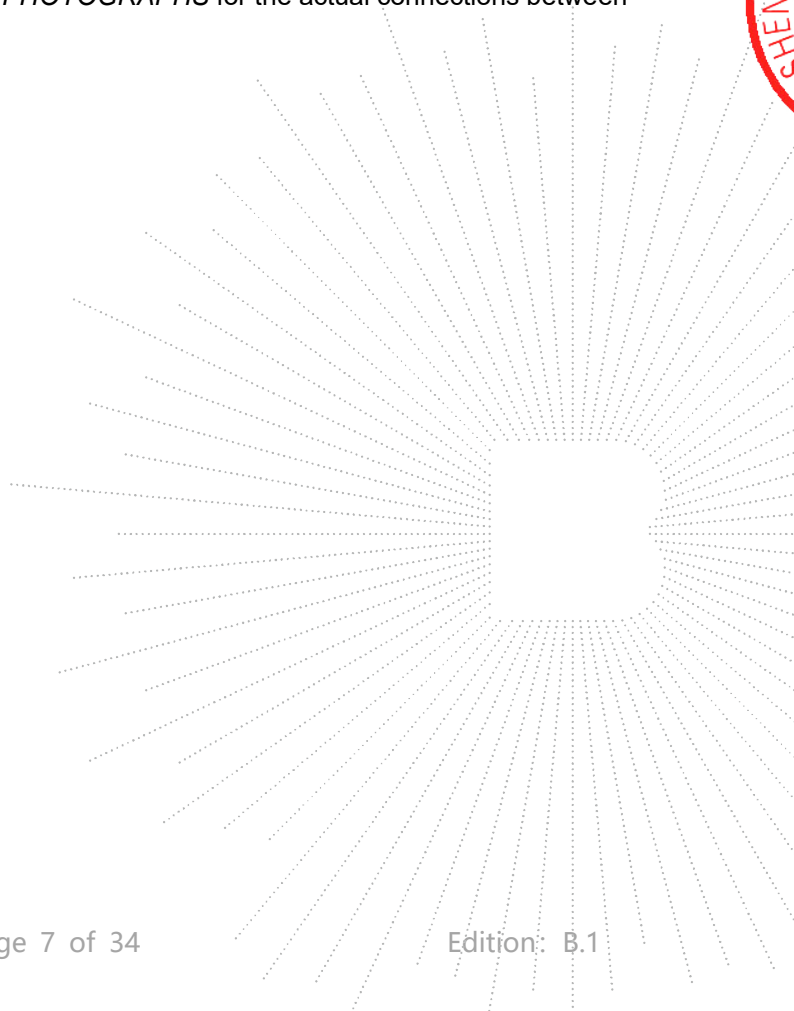
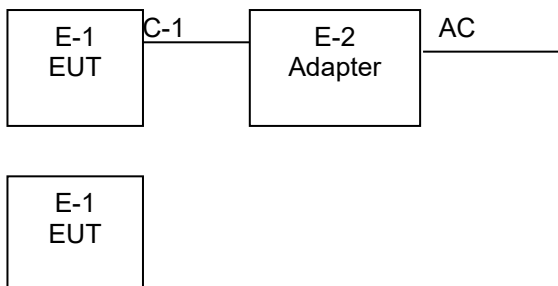

### 4.3 Support Equipment

No.	Device Type	Brand	Model	Series No.	Note
E-1	Hub 3	N/A	YS1605-UC	--	EUT
E-2	Adapter	N/A	GA-0502000	--	Adapter
E-3	Router	N/A	R4A	--	Router

Item	Shielded Type	Ferrite Core	Length	Note
C-1	N/A	N/A	1M	DC cable unshielded

**Notes:**

1. All the equipment/cables were placed in the worst-case configuration to maximize the emission during the test.
2. Grounding was established in accordance with the manufacturer's requirements and conditions for the intended use.

### 4.4 Channel List

CH	Frequency (MHz)
1	923.3

### 4.5 Test Mode

To investigate the maximum EMI emission characteristics generates from EUT, the test system was pre-scanning tested base on the consideration of following EUT operation mode or test configuration mode which possible have effect on EMI emission level. Each of these EUT operation mode(s) or test configuration mode(s) mentioned above was evaluated respectively.

Test Mode	Test mode
1	Transmitting

**Note:**

- (1) Fully-charged battery is used during the test

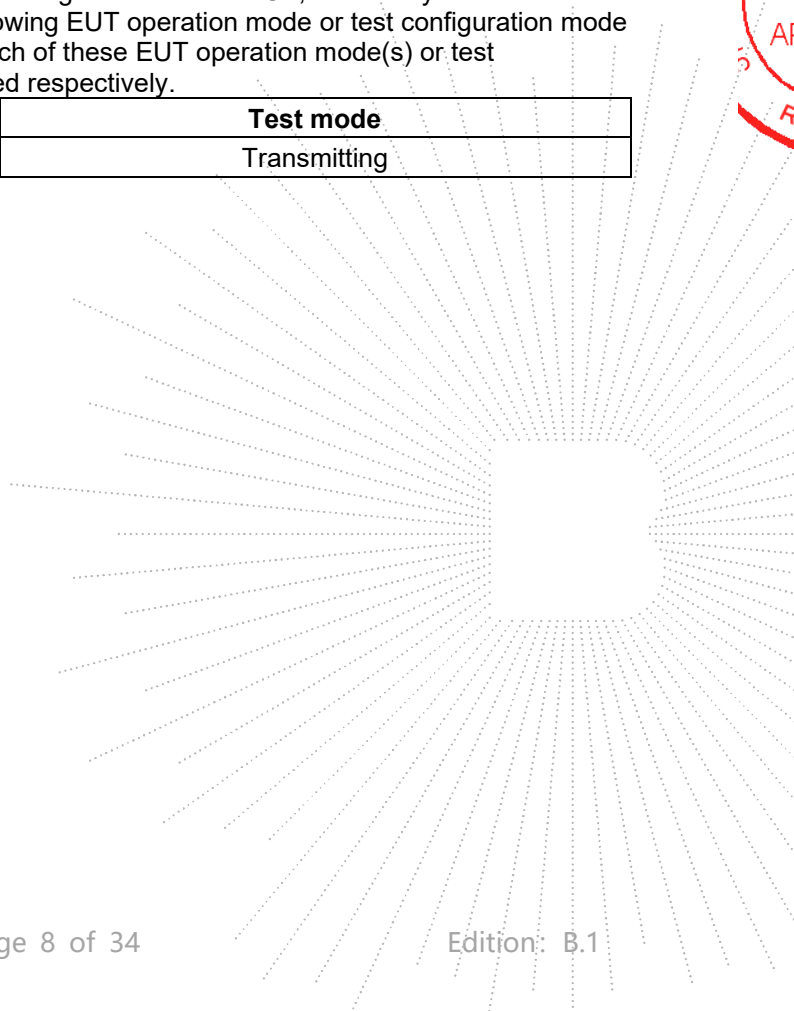



## 5. Test Facility And Test Instrument Used

### 5.1 Test Facility

All measurement facilities used to collect the measurement data are located at Shenzhen BCTC Testing Co., Ltd. Address: 1-2/F., Building B, Pengzhou Industrial Park, No.158, Fuyuan 1st Road, Zhancheng, Fuhai Subdistrict, Bao'an District, Shenzhen, Guangdong, China. The site and apparatus are constructed in conformance with the requirements of ANSI C63.4 and CISPR 16-1-1 other equivalent standards.

FCC Test Firm Registration Number: 712850

A2LA certificate registration number is: CN1212

ISED Registered No.: 23583

ISED CAB identifier: CN0017

### 5.2 Test Instrument Used

Conducted Emissions Test					
Equipment	Manufacturer	Model#	Serial#	Last Cal.	Next Cal.
Receiver	R&S	ESR3	102075	May 15, 2023	May 14, 2024
LISN	R&S	ENV216	101375	May 15, 2023	May 14, 2024
Software	Frad	EZ-EMC	EMC-CON 3A1	\	\
Pulse limiter	Schwarzbeck	VTSD9561-F	01323	Sept. 22, 2023	Sept. 21, 2024

RF Conducted Test					
Equipment	Manufacturer	Model#	Serial#	Last Cal.	Next Cal.
Power meter	Keysight	E4419	\	May 15, 2023	May 14, 2024
Power Sensor (AV)	Keysight	E9300A	\	May 15, 2023	May 14, 2024
Signal Analyzer20kHz-26.5GHz	Keysight	N9020A	MY49100060	May 15, 2023	May 14, 2024
Spectrum Analyzer9kHz-40GHz	R&S	FSP40	100363	May 15, 2023	May 14, 2024
Radio frequency control box	MAIWEI	MW100-RFC B	\	\	\
Software	MAIWEI	MTS 8310	\	\	\

Radiated Emissions Test (966 Chamber01)					
Equipment	Manufacturer	Model#	Serial#	Last Cal.	Next Cal.
966 chamber	ChengYu	966 Room	966	May 15, 2023	May 14, 2026
Receiver	R&S	ESR3	102075	May 15, 2023	May 14, 2024
Receiver	R&S	ESRP	101154	May 15, 2023	May 14, 2024
Amplifier	Schwarzbeck	BBV9744	9744-0037	May 15, 2023	May 14, 2024
TRILOG Broadband Antenna	Schwarzbeck	VULB9163	942	May 29, 2023	May 28, 2024
Loop Antenna(9KHz-30MHz)	Schwarzbeck	FMZB1519B	00014	May 31, 2023	May 30, 2024
Amplifier	SKET	LAPA_01G18 G-45dB	SK2021040901	May 15, 2023	May 14, 2024
Horn Antenna	Schwarzbeck	BBHA9120D	1541	May 31, 2023	May 30, 2024
Amplifier(18G Hz-40GHz)	MITEQ	TTA1840-35-HG	2034381	May 15, 2023	May 14, 2024
Horn Antenna(18G Hz-40GHz)	Schwarzbeck	BBHA9170	00822	May 31, 2023	May 30, 2024
Spectrum Analyzer9kHz-40GHz	R&S	FSP40	100363	May 15, 2023	May 14, 2024
Software	Frad	EZ-EMC	FA-03A2 RE	\	\

TE  
TC  
OV  
t See

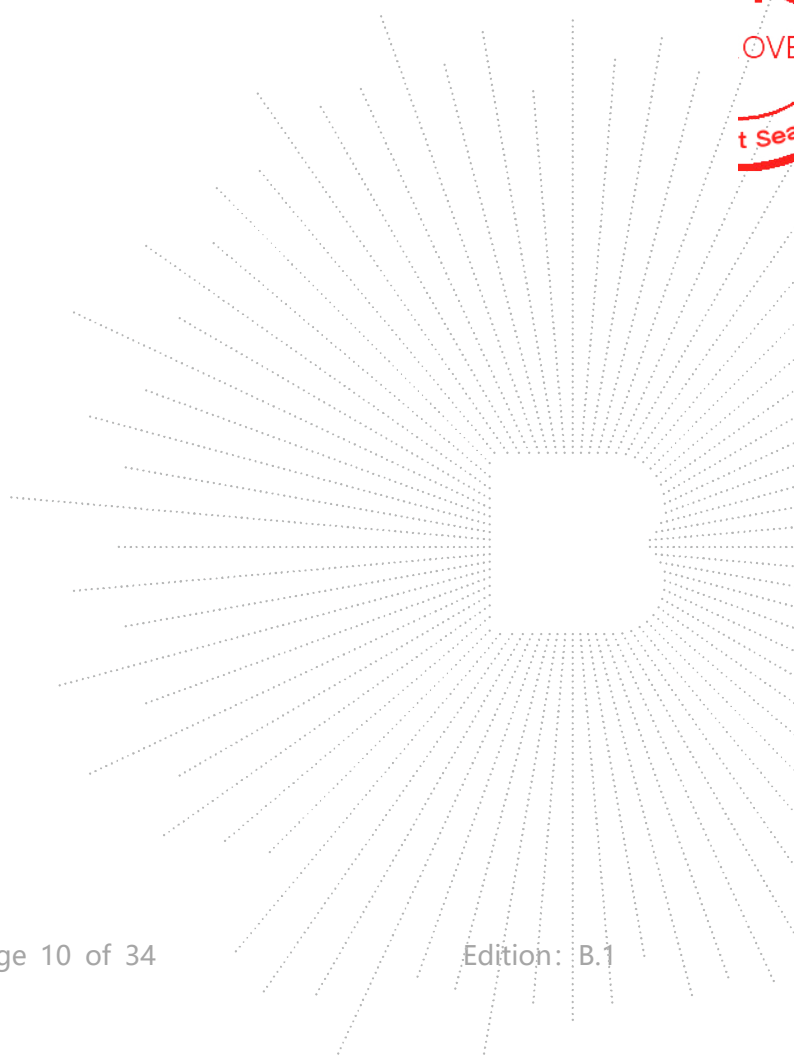

## 6. Conducted Emissions

### 6.1 Block Diagram Of Test Setup

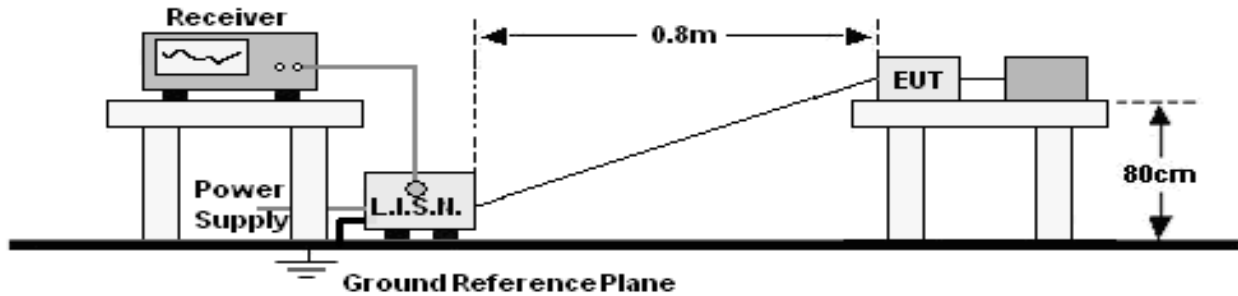

### 6.2 Limit

FREQUENCY (MHz)	Limit (dBuV)	
	Quas-peak	Average
0.15 -0.5	66 - 56 *	56 - 46 *
0.50 -5.0	56.00	46.00
5.0 -30.0	60.00	50.00

Notes:  
 1. \*Decreasing linearly with logarithm of frequency.  
 2. The lower limit shall apply at the transition frequencies.

### 6.3 Test Procedure

Receiver Parameters	Setting
Attenuation	10 dB
Start Frequency	0.15 MHz
Stop Frequency	30 MHz
IF Bandwidth	9 kHz

- The Product was placed on a nonconductive table 0.8 m above the horizontal ground reference plane, and 0.4 m from the vertical ground reference plane, and connected to the main through Line Impedance Stability Network (L.I.S.N).
- The RBW of the receiver was set at 9 kHz in 150 kHz ~ 30MHz with Peak and AVG detector in Max Hold mode. Run the receiver's pre-scan to record the maximum disturbance generated from Product in all power lines in the full band.
- For each frequency whose maximum record was higher or close to limit, measure its QP and AVG values and record.

### 6.4 EUT Operating Conditions

The EUT was configured for testing in a typical fashion (as a customer would normally use it). The EUT has been programmed to continuously transmit during test. This operating condition was tested and used to collect the included data.

### 6.5 Test Result

Temperature:	26 °C	Relative Humidity:	54%
Pressure:	101KPa	Test Voltage:	AC120V/60Hz
Test Mode:	Mode 1	Polarization :	L

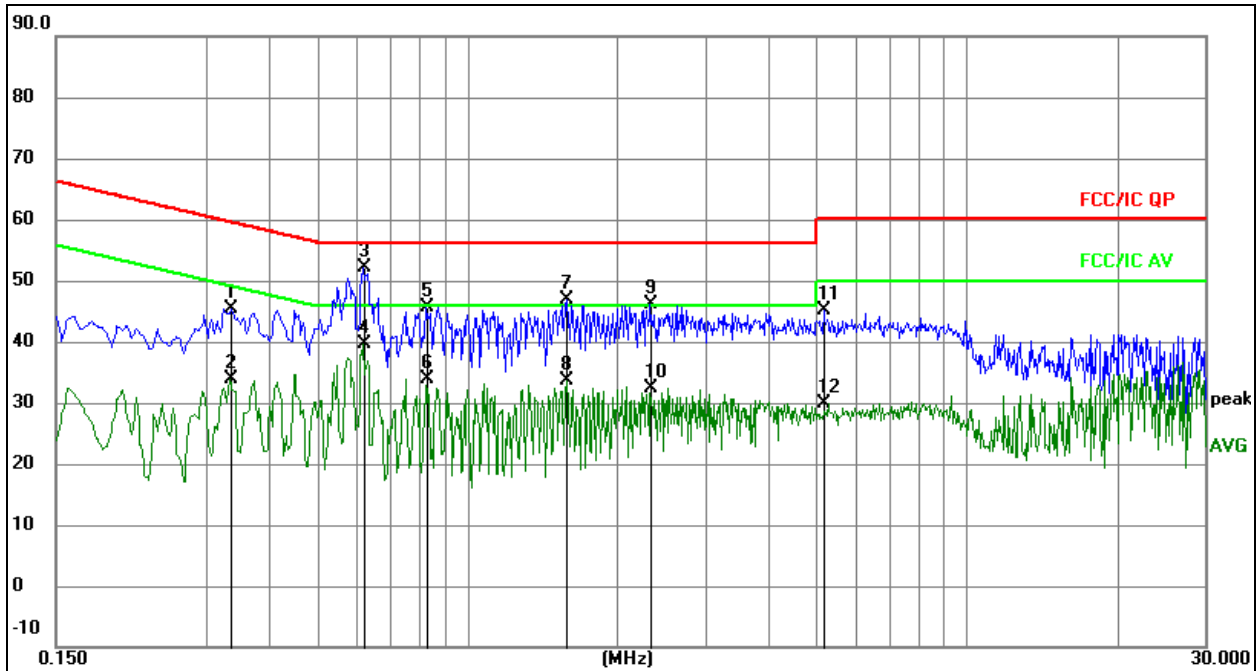

**Remark:**

1. All readings are Quasi-Peak and Average values.
2. Factor = Insertion Loss + Cable Loss.
3. Measurement = Reading Level + Correct Factor
4. Over = Measurement - Limit

No.	Mk.	Freq. MHz	Reading Level	Correct Factor dB	Measure- ment dBuV	Limit dBuV	Over dB	Detector
1		0.3373	25.55	19.83	45.38	59.27	-13.89	QP
2		0.3373	14.12	19.83	33.95	49.27	-15.32	AVG
3	*	0.6173	32.25	19.84	52.09	56.00	-3.91	QP
4		0.6173	19.82	19.84	39.66	46.00	-6.34	AVG
5		0.8261	25.82	19.89	45.71	56.00	-10.29	QP
6		0.8261	13.95	19.89	33.84	46.00	-12.16	AVG
7		1.5766	26.86	19.95	46.81	56.00	-9.19	QP
8		1.5766	13.65	19.95	33.60	46.00	-12.40	AVG
9		2.3213	25.96	20.06	46.02	56.00	-9.98	QP
10		2.3213	12.22	20.06	32.28	46.00	-13.72	AVG
11		5.1663	24.69	20.39	45.08	60.00	-14.92	QP
12		5.1663	9.52	20.39	29.91	50.00	-20.09	AVG

Temperature:	26 °C	Relative Humidity:	54%
Pressure:	101KPa	Test Voltage:	AC120V/60Hz
Test Mode:	Mode 1	Polarization :	N

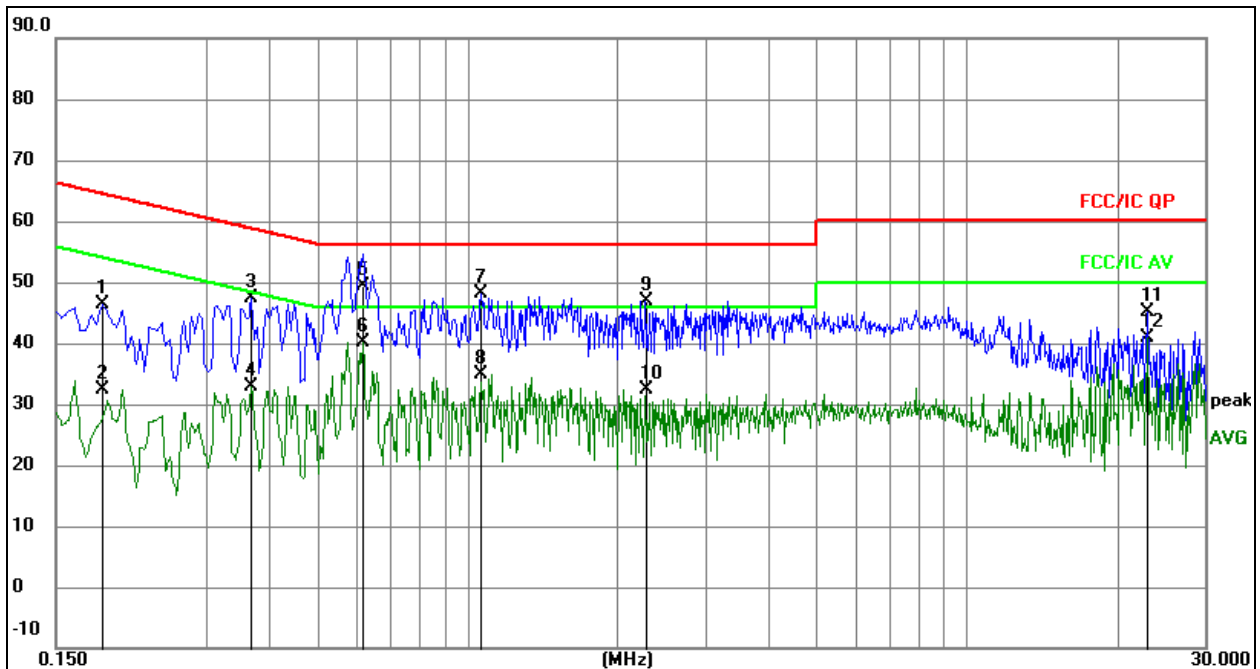
**Remark:**

1. All readings are Quasi-Peak and Average values.
2. Factor = Insertion Loss + Cable Loss.
3. Measurement = Reading Level + Correct Factor
4. Over = Measurement - Limit

No.	Mk.	Freq. MHz	Reading Level dB	Correct Factor dB	Measure- ment dBuV	Limit dBuV	Over dB	Detector
1		0.1853	26.54	19.80	46.34	64.24	-17.90	QP
2		0.1853	12.46	19.80	32.26	54.24	-21.98	AVG
3		0.3692	27.45	19.84	47.29	58.52	-11.23	QP
4		0.3692	12.93	19.84	32.77	48.52	-15.75	AVG
5		0.6170	29.59	19.84	49.43	56.00	-6.57	QP
6	*	0.6170	20.34	19.84	40.18	46.00	-5.82	AVG
7		1.0653	28.06	19.95	48.01	56.00	-7.99	QP
8		1.0653	14.90	19.95	34.85	46.00	-11.15	AVG
9		2.2726	26.81	20.05	46.86	56.00	-9.14	QP
10		2.2726	12.38	20.05	32.43	46.00	-13.57	AVG
11		23.0181	25.10	19.99	45.09	60.00	-14.91	QP
12		23.0181	20.84	19.99	40.83	50.00	-9.17	AVG

## 7. Radiated Emissions

### 7.1 Block Diagram Of Test Setup

(A) Radiated Emission Test-Up Frequency Below 30MHz

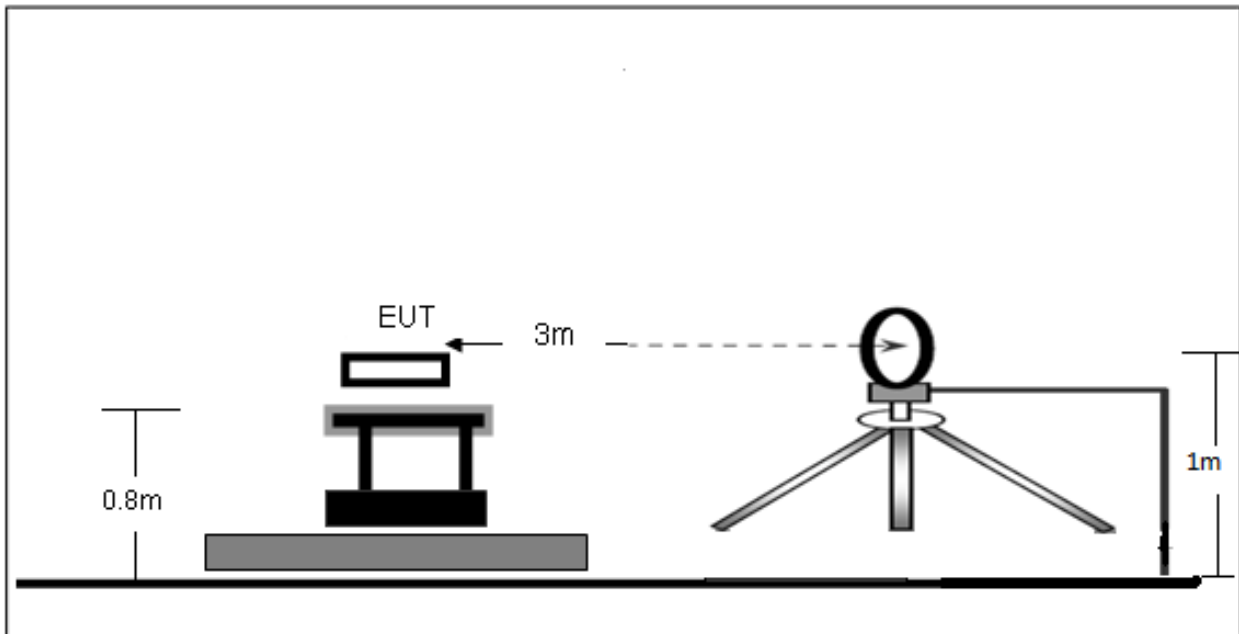

(B) Radiated Emission Test-Up Frequency 30MHz~1GHz

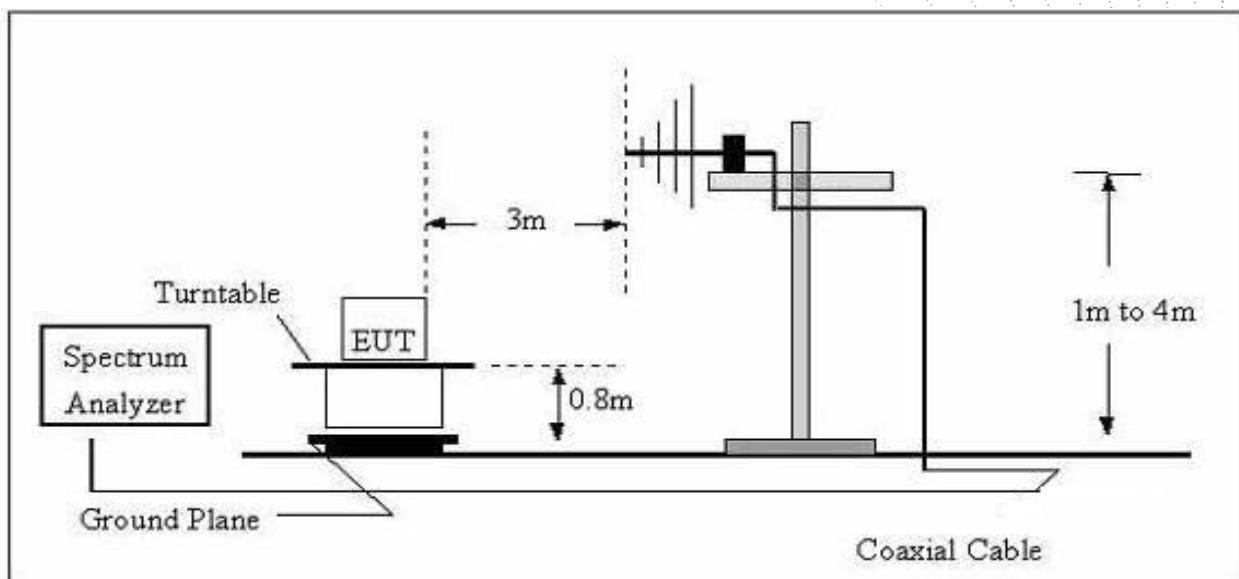

## (C) Radiated Emission Test-Up Frequency Above 1GHz

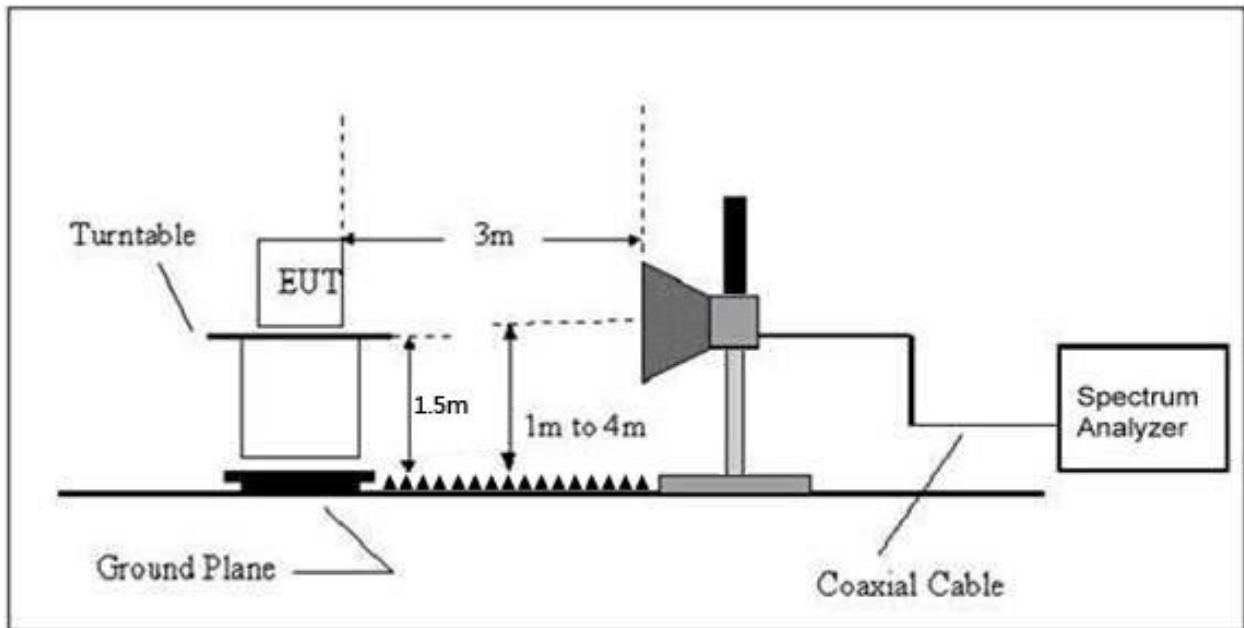

## 7.2 Limit

In case the emission fall within the restricted band specified on 15.205(a), then the 15.209(a) limit in the table below has to be followed.

Frequency (MHz)	Field Strength uV/m	Distance (m)	Field Strength Limit at 3m Distance	
			uV/m	dBuV/m
0.009 ~ 0.490	$2400/F(\text{kHz})$	300	$10000 * 2400/F(\text{kHz})$	$20\log^{(2400/F(\text{kHz}))} + 80$
0.490 ~ 1.705	$24000/F(\text{kHz})$	30	$100 * 24000/F(\text{kHz})$	$20\log^{(24000/F(\text{kHz}))} + 40$
1.705 ~ 30	30	30	$100 * 30$	$20\log^{(30)} + 40$
30 ~ 88	100	3	100	$20\log^{(100)}$
88 ~ 216	150	3	150	$20\log^{(150)}$
216 ~ 960	200	3	200	$20\log^{(200)}$
Above 960	500	3	500	$20\log^{(500)}$

The field strength of emissions from intentional radiators operated within these frequency bands shall comply with the following:

Fundamental frequency	Field strength of fundamental (millivolts/meter)	Field strength of harmonics (microvolts/meter)
902-928 MHz	50	500
2400-2483.5 MHz	50	500
5725-5875 MHz	50	500
24.0-24.25 GHz	250	2500



## LIMITS OF RADIATED EMISSION MEASUREMENT (Above 1000MHz)

FREQUENCY (MHz)	Limit (dBuV/m) (at 3M)	
	PEAK	AVERAGE
Above 1000	74	54

## Notes:

- (1) The limit for radiated test was performed according to FCC PART 15C.
- (2) The tighter limit applies at the band edges.
- (3) Emission level (dBuV/m) = 20log Emission level (uV/m).

## FREQUENCY RANGE OF RADIATED MEASUREMENT (For unintentional radiators)

Highest frequency generated or Upper frequency of measurement used in the device or on which the device operates or tunes (MHz)	Range (MHz)
Below 1.705	30
1.705 – 108	1000
108 – 500	2000
500 – 1000	5000
Above 1000	5 <sup>th</sup> harmonic of the highest frequency or 40 GHz, whichever is lower

## 7.3 Test Procedure

Spectrum Parameter	Setting
Attenuation	Auto
Start Frequency	1000 MHz
Stop Frequency	10th carrier harmonic
RB / VB (emission in restricted band)	1 MHz / 1 MHz for Peak, 1 MHz / 10Hz for Average

Receiver Parameter	Setting
Attenuation	Auto
Start ~ Stop Frequency	9kHz~150kHz / RB 200Hz for QP
Start ~ Stop Frequency	150kHz~30MHz / RB 9kHz for QP
Start ~ Stop Frequency	30MHz~1000MHz / RB 120kHz for QP



Below 1GHz test procedure as below:

- a. The EUT was placed on the top of a rotating table 0.8 meters above the ground at a 3 meter semi-anechoic chamber. The table was rotated 360 degrees to determine the position of the highest radiation.
- b. The EUT was set 3 meters away from the interference-receiving antenna, which was mounted on the top of a variable-height antenna tower.
- c. The antenna height is varied from one meter to four meters above the ground to determine the maximum value of the field strength. Both horizontal and vertical polarizations of the antenna are set to make the measurement.
- d. For each suspected emission, the EUT was arranged to its worst case and then the antenna was tuned to heights from 1 meter to 4 meters (for the test frequency of below 30MHz, the antenna was tuned to heights 1 meter) and the rotatable table was turned from 0 degrees to 360 degrees to find the maximum reading.
- e. The test-receiver system was set to Peak Detect Function and Specified Bandwidth with Maximum Hold Mode.
- f. If the emission level of the EUT in peak mode was 10dB lower than the limit specified, then testing could be stopped and the peak values of the EUT would be reported. Otherwise the emissions that did not have 10dB margin would be re-tested one by one using peak, quasi-peak or average method as specified and then reported in a data sheet.
- g. Different between above is the test site, change from Semi- Anechoic Chamber to fully Anechoic Chamber and change form table 0.8 metre to 1.5 metre( Above 18GHz the distance is 1 meter and table is 1.5 metre).
- h. Test the EUT in the lowest channel ,the middle channel ,the Highest channel.

Note:

Both horizontal and vertical antenna polarities were tested and performed pretest to three orthogonal axis. The worst case emissions were reported.

Above 1GHz test procedure as below:

- a. The EUT was placed on the top of a rotating table 1.5 meters above the ground at a 3 meter chamber. The table was rotated 360 degrees to determine the position of the highest radiation.
- b. The EUT was set 3 meters away from the interference-receiving antenna, which was mounted on the top of a variable-height antenna tower.
- c. The antenna height is varied from one meter to four meters above the ground to determine the maximum value of the field strength. Both horizontal and vertical polarizations of the antenna are set to make the measurement.
- d. For each suspected emission, the EUT was arranged to its worst case and then the antenna was tuned to heights from 1 meter to 4 meters and the rota table was turned from 0 degrees to 360 degrees to find the maximum reading.
- e. The test-receiver system was set to Peak Detect Function and Specified Bandwidth with Maximum Hold Mode.
- f. If the emission level of the EUT in peak mode was 10dB lower than the limit specified, then testing could be stopped and the peak values of the EUT would be reported. Otherwise the emissions that did not have 10dB margin would be re-tested one by one using peak, quasi-peak or average method as specified and then reported in a data sheet.
- g. Test the EUT in the lowest channel, the Highest channel.

Note:

Both horizontal and vertical antenna polarities were tested and performed pretest to three orthogonal axis. The worst case emissions were reported.

## 7.4 EUT Operating Conditions

The EUT was configured for testing in a typical fashion (as a customer would normally use it). The EUT has been programmed to continuously transmit during test. This operating condition was tested and used to collect the included data.

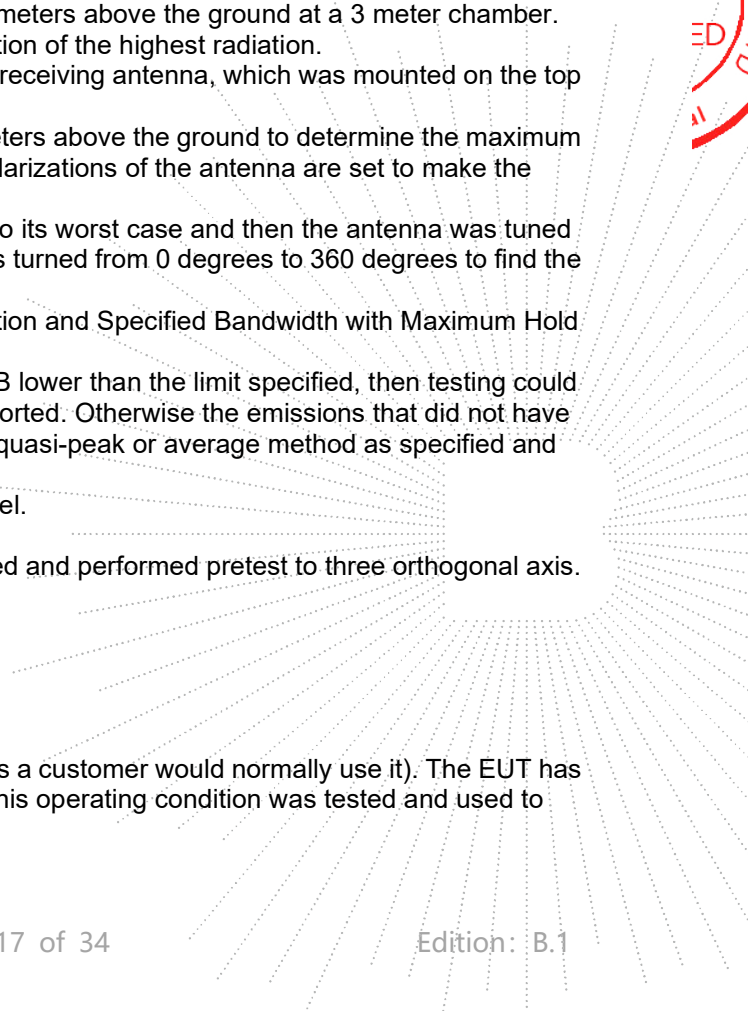

## 7.5 Test Result

Below 30MHz

Temperature:	26°C	Relative Humidity:	54%
Pressure:	101 kPa	Test Voltage:	AC 120V/60Hz, DC 3.6V
Test Mode:	Mode 1	Polarization:	--

Freq. (MHz)	Reading (dBuV/m)	Limit (dBuV/m)	Margin (dB)	State P/F
--	--	--	--	PASS
--	--	--	--	PASS

**Note:**

The amplitude of spurious emissions which are attenuated by more than 20dB below the permissible value has no need to be reported.

Distance extrapolation factor =  $40 \log(\text{specific distance/test distance})(\text{dB})$ ;

Limit line = specific limits(dBuV) + distance extrapolation factor.

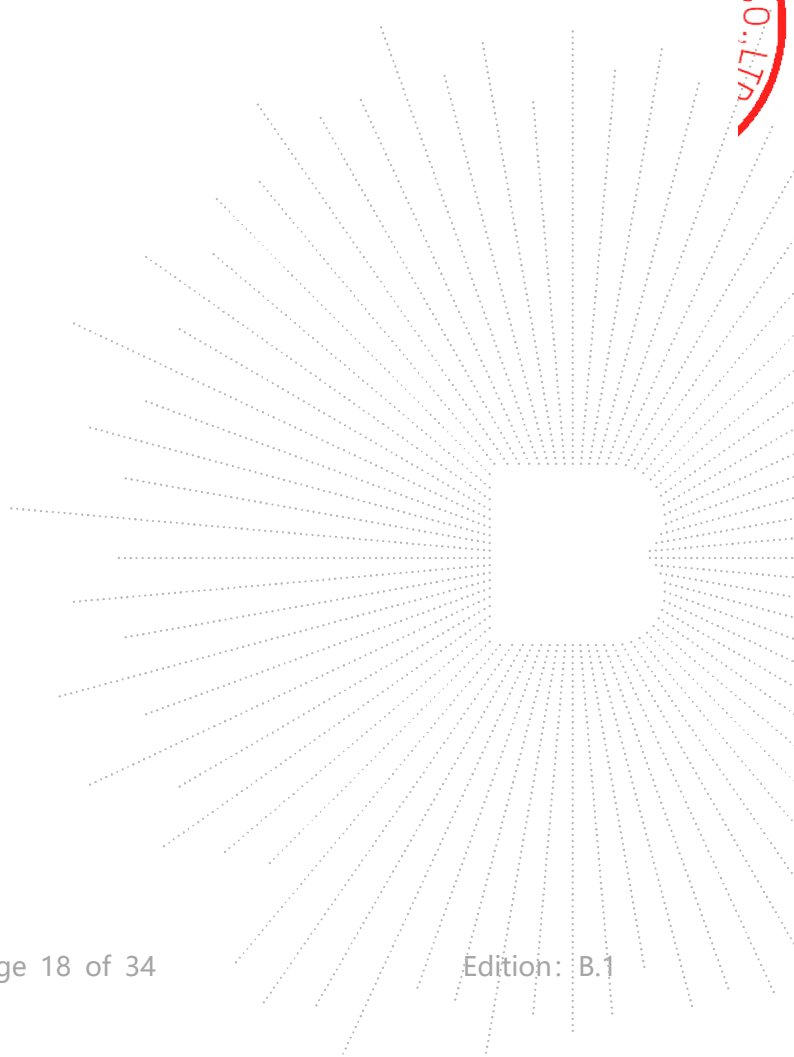
Between 30MHz – 1GHz

Temperature:	26 °C	Relative Humidity:	54%
Pressure:	101KPa	Phase :	Horizontal
Test Mode:	Mode 1(AC 120V/60Hz) (The Worst data)	Remark:	N/A

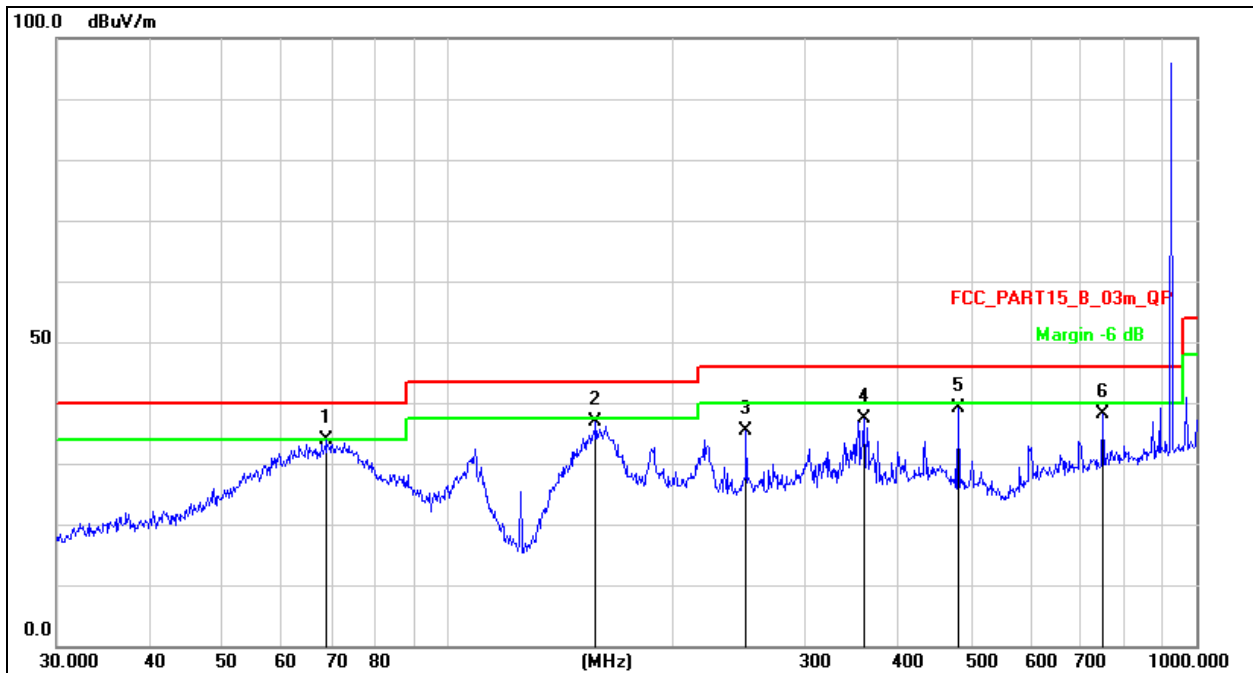

Remark:  
 1. Factor = Antenna Factor + Cable Loss – Pre-amplifier.  
 2. Measurement=Reading Level+ Correct Factor  
 3. Over=Measurement-Limit

No.	Mk.	Freq.	Reading Level	Correct Factor	Measurement	Limit	Over	Detector
		MHz	dBuV	dB	dBuV/m	dB/m	dB	
1	*	68.8721	51.45	-17.69	33.76	40.00	-6.24	QP
2		157.5588	55.74	-18.87	36.87	43.50	-6.63	QP
3		250.3012	49.55	-14.28	35.27	46.00	-10.73	QP
4		359.1860	48.80	-11.36	37.44	46.00	-8.56	QP
5		480.5276	48.30	-9.10	39.20	46.00	-6.80	QP
6		750.1082	43.12	-4.99	38.13	46.00	-7.87	QP

SHENZHEN

Temperature:	26 °C	Relative Humidity:	54%
Pressure:	101KPa	Phase :	Vertical
Test Mode:	Mode 1(AC 120V/60Hz) (The Worst data)	Remark:	N/A

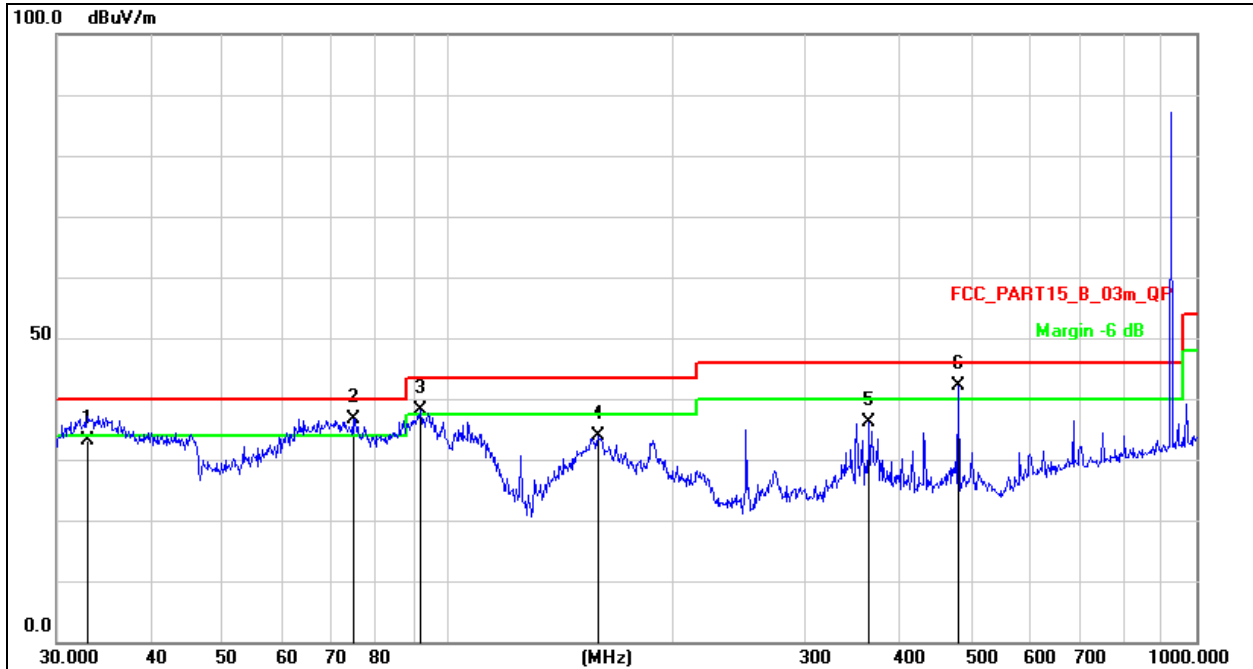
**Remark:**

1. Factor = Antenna Factor + Cable Loss – Pre-amplifier.
2. Measurement=Reading Level+ Correct Factor
3. Over=Measurement-Limit

No.	Mk.	Freq.	Reading Level	Correct Factor	Measurement	Limit	Over	Detector
		MHz	dBuV	dB	dBuV/m	dB/m	dB	
1		32.9791	49.31	-16.07	33.24	40.00	-6.76	QP
2	*	74.6569	55.47	-18.81	36.66	40.00	-3.34	QP
3	!	91.8163	55.15	-17.13	38.02	43.50	-5.48	QP
4		158.6677	52.55	-18.79	33.76	43.50	-9.74	QP
5		365.5391	47.40	-11.28	36.12	46.00	-9.88	QP
6	!	480.5276	51.26	-9.10	42.16	46.00	-3.84	QP

(Above 1000 MHz)

Polar (H/V)	Frequency	Meter Reading	Factor	Emission Level	Limits	Margin	Detector Type
	(MHz)	(dBuV)	(dB)	(dBuV/m)	(dBuV/m)	(dB)	
923.3 MHz							
V	1846.60	87.07	-26.94	60.13	74.00	-13.88	PK
V	1846.60	62.57	-26.94	35.63	54.00	-18.38	AV
V	2769.90	84.32	-24.21	60.11	74.00	-13.89	PK
V	2769.90	59.84	-24.21	35.63	54.00	-18.38	AV
V	3693.20	80.72	-22.21	58.51	74.00	-15.49	PK
V	3693.20	59.97	-22.21	37.76	54.00	-16.24	AV
H	1846.60	86.28	-26.94	59.34	74.00	-14.66	PK
H	1846.60	65.42	-26.94	38.48	54.00	-15.53	AV
H	2769.90	81.06	-24.21	56.85	74.00	-17.15	PK
H	2769.90	59.84	-24.21	35.63	54.00	-18.38	AV
H	3693.20	81.52	-22.21	59.31	74.00	-14.69	PK
H	3693.20	58.55	-22.21	36.34	54.00	-17.66	AV

**Remark:**

Absolute Level= Reading Level+ Factor, Margin= Limit- Absolute Level  
 Other harmonics emissions are lower than 20dB below the allowable limit.

BCTC  
 BCTC  
 PPR  
 Report

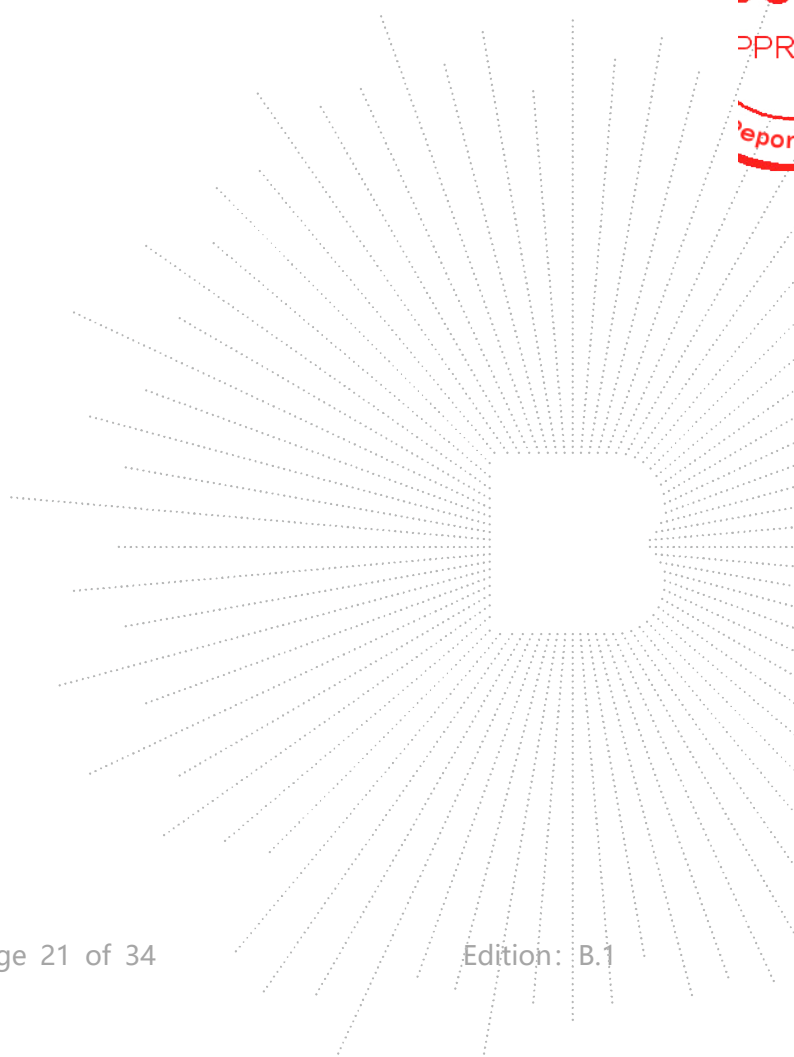

## 7.6 Field Strength Calculation

The field strength is calculated by adding the Antenna Factor and Cable Factor and subtracting the Amplifier Gain and Duty Cycle Correction Factor (if any) from the measured reading. The basic equation with a sample calculation is as follows:

$$FS=RA+AF+CL-AG$$

FS=Field Strength	CL=Cable Attenuation Factor (Cable Loss)
RA=Reading Amplitude	AG=Amplifier Gain
AF=Antenna Factor	

Test Result:

Temperature:	26°C	Relative Humidity:	54%
Pressure:	101kPa	Polarization:	Horizontal
Test Voltage:	AC 120V/60Hz(The Worst data)		
Test Mode:	Mode 1		

Frequency (MHz)	Meter Reading (dBμV)	Factor (dB)	Emission Level (dBμV/m)	Limits (dBμV/m)	Margin (dB)	Detector Type
923.3	100.40	-3.04	97.36	114.00	-16.64	Peak
923.3	97.36	-10.17	87.19	94.00	-6.81	Average

Remark:

Factor = Antenna Factor + Cable Loss – Pre-amplifier.  
All interfaces was connected, and TX mode

Temperature:	26°C	Relative Humidity:	54%
Pressure:	101kPa	Polarization:	Vertical
Test Voltage:	AC 120V/60Hz(The Worst data)		
Test Mode:	Mode 1		

Frequency (MHz)	Meter Reading (dBμV)	Factor (dB)	Emission Level (dBμV/m)	Limits (dBμV/m)	Margin (dB)	Detector Type
923.3	88.35	-3.04	85.31	114.00	-28.69	Peak
923.3	85.31	-10.17	75.14	94.00	-18.86	Average

Remark:

Factor = Antenna Factor + Cable Loss – Pre-amplifier.  
All interfaces was connected, and TX mode

## 8. 100 KHz Bandwidth Of Frequency Band Edge

### 8.1 Block Diagram Of Test Setup

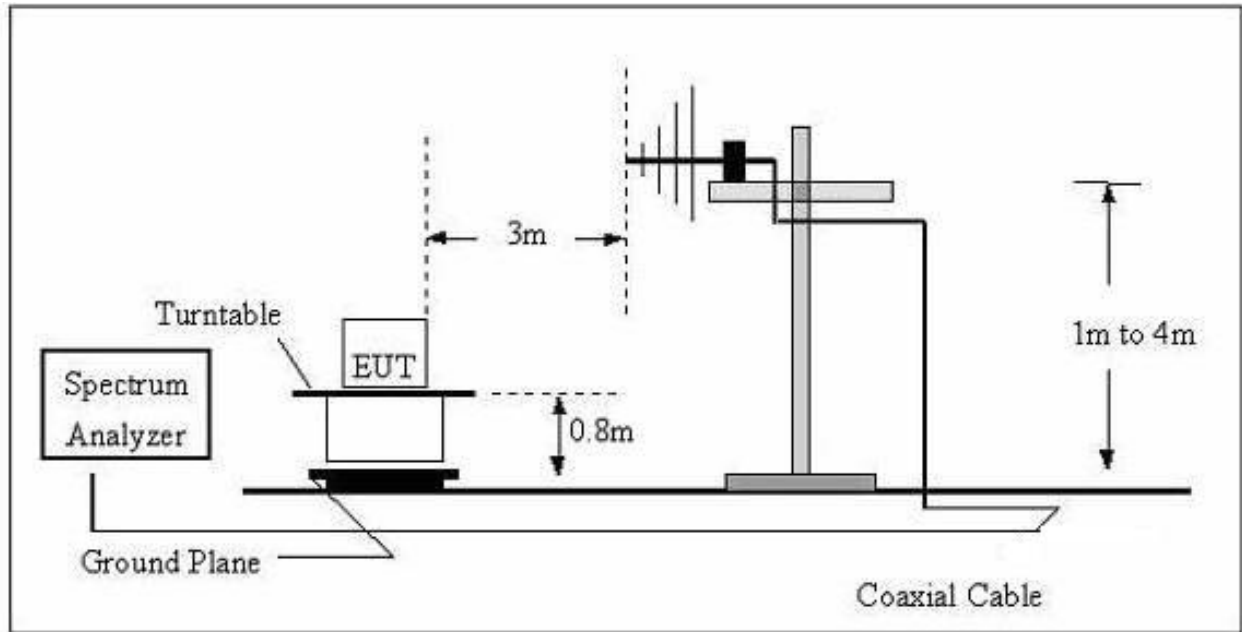

### 8.2 Applicable Standard

Emissions radiated outside of the specified frequency bands, except for harmonics, shall be attenuated by at least 50 dB below the level of the fundamental or to the general radiated emission limits in § 15.209, whichever is the lesser attenuation.

### 8.3 Test Procedure

- Check the calibration of the measuring instrument using either an internal calibrator or a known signal from an external generator.
- Position the EUT without connection to measurement instrument. Turn on the EUT and connect its antenna terminal to measurement instrument via a low loss cable. Then set it to any one measured frequency within its operating range, and make sure the instrument is operated in its linear range.
- VBW for Peak, Quasi-peak, or Average Detector Function:  $3 \times \text{RBW}$
- Repeat above procedures until all measured frequencies were complete.

Note:

Both horizontal and vertical antenna polarities were tested and performed pretest to three orthogonal axis. The worst case emissions were reported.

### 8.4 EUT Operating Conditions

The EUT tested system was configured as the statements of 2.4 Unless otherwise a special operating condition is specified in the follows during the testing.



## 8.5 Test Result

Temperature:	26 °C	Relative Humidity:	54%
Pressure:	101 kPa	Test Voltage:	AC 120V/60Hz (The Worst data)
Test Mode:	Transmitting		

923.3MHz Horizontal

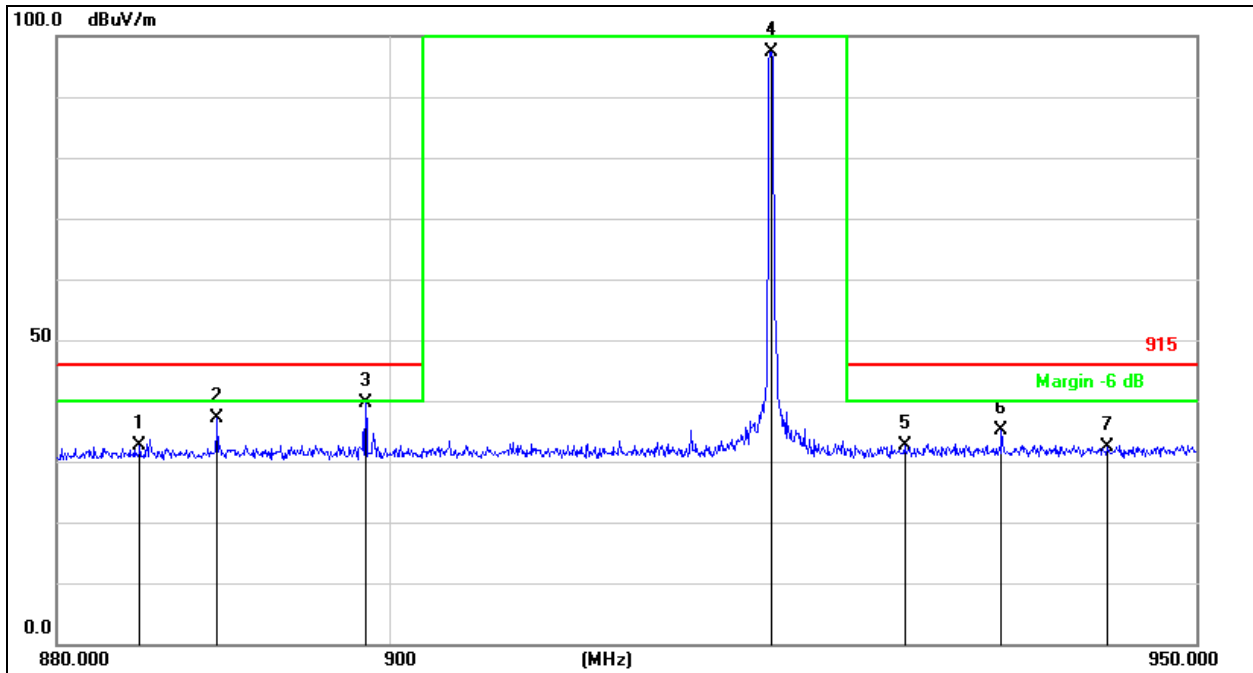

No.	Mk.	Freq. MHz	Reading Level dBuV	Correct Factor dB	Measure- ment dBuV/m	Limit dB/m	Over dB	Detector
1		884.9700	36.03	-3.38	32.65	46.00	-13.35	QP
2		889.5900	40.44	-3.30	37.14	46.00	-8.86	QP
3	*	898.4800	42.72	-3.15	39.57	46.00	-6.43	QP
4		923.3300	100.40	-3.04	97.36	114.0	-16.64	QP
5		931.5900	35.63	-3.01	32.62	46.00	-13.38	QP
6		937.6800	38.05	-2.98	35.07	46.00	-10.93	QP
7		944.3999	35.23	-2.96	32.27	46.00	-13.73	QP



## 923.3MHz Vertical

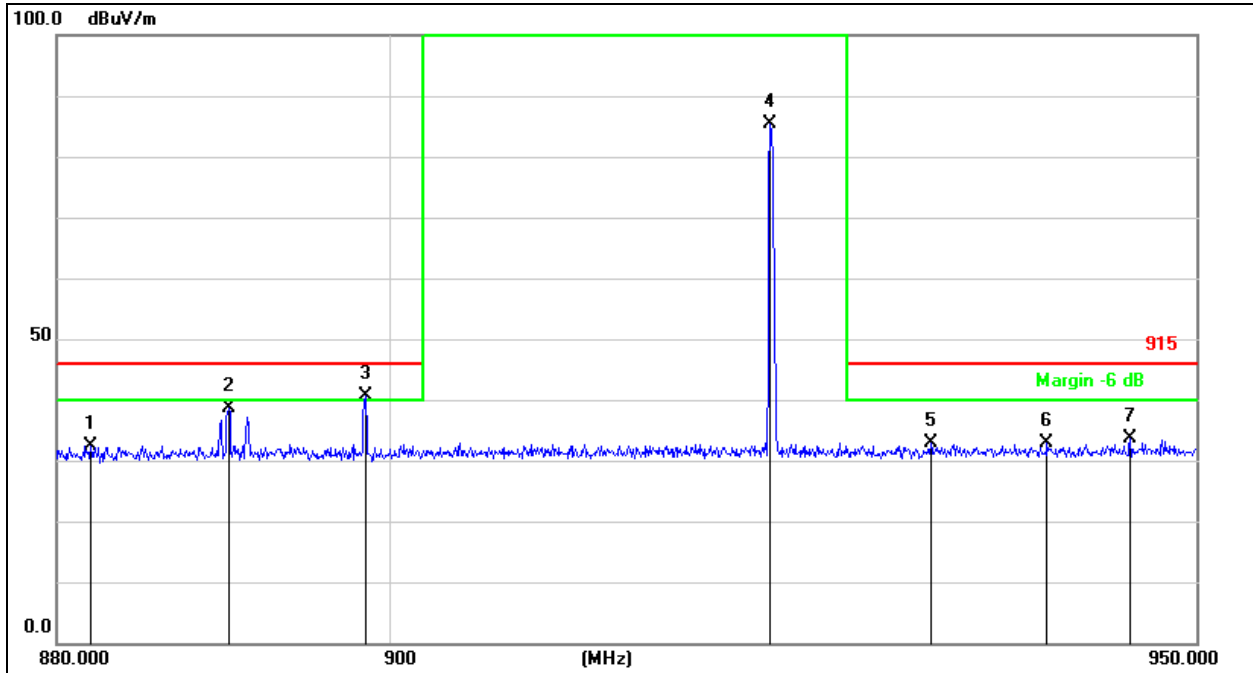

No.	Mk.	Freq. MHz	Reading Level dBuV	Correct Factor dB	Measure- ment dBuV/m	Limit dB/m	Over dB	Detector
1		882.0300	35.93	-3.43	32.50	46.00	-13.50	QP
2		890.2900	41.80	-3.29	38.51	46.00	-7.49	QP
3	*	898.4800	43.83	-3.15	40.68	46.00	-5.32	QP
4		923.2600	88.35	-3.04	85.31	114.0	-28.69	peak
5		933.2700	35.98	-3.00	32.98	46.00	-13.02	QP
6		940.5500	35.74	-2.97	32.77	46.00	-13.23	QP
7		945.8000	36.47	-2.96	33.51	46.00	-12.49	QP

SHENZHEN

## 9. 20 Db Bandwidth

### 9.1 Block Diagram Of Test Setup

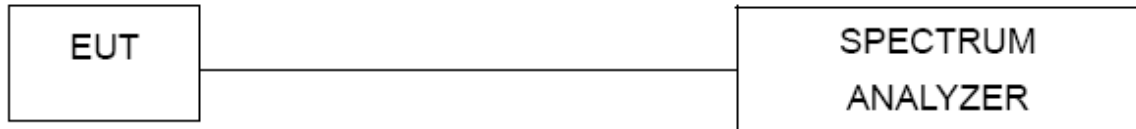

### 9.2 Limit

FCC Part15 (15.249) , Subpart C			
Section	Test Item	Frequency Range (MHz)	Result
15.249	Bandwidth	902~928	PASS

### 9.3 Test Procedure

1. Set resolution bandwidth (RBW) = 1-5% or DTS BW, not to exceed 100 kHz.
2. Set the video bandwidth (VBW)  $\geq 3 \times$  RBW.
3. Detector = Peak.
4. Trace mode = max hold.
5. Sweep = auto couple.
6. Allow the trace to stabilize.
7. Measure the maximum width of the emission that is constrained by the frequencies associated with the two outermost amplitude points (upper and lower) that are attenuated by 20 dB relative to the maximum level measured in the fundamental emission.

### 9.4 EUT Operation Conditions

The EUT tested system was configured as the statements of 2.4 Unless otherwise a special operating condition is specified in the follows during the testing.

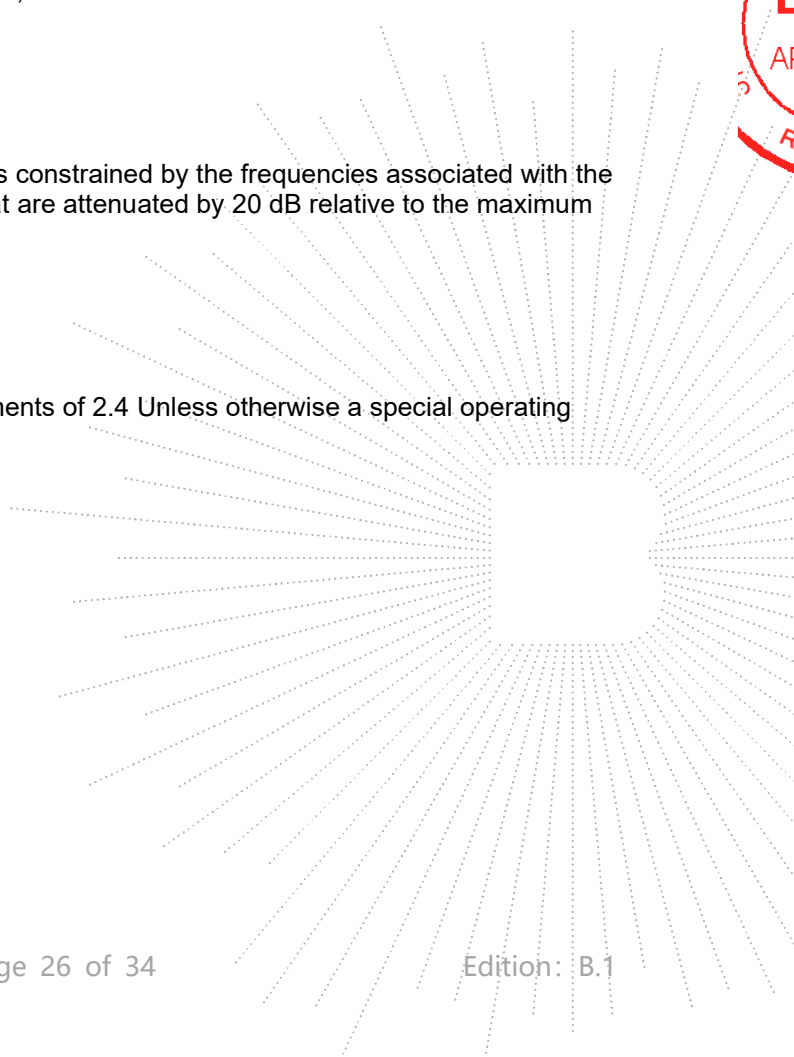

## 9.5 Test Result

Temperature:	26°C	Relative Humidity:	54%
Test Voltage:	DC 3.6V	Remark:	N/A

Channel	Frequency (MHz)	20dB bandwidth (KHz)
01	923.3	143.4

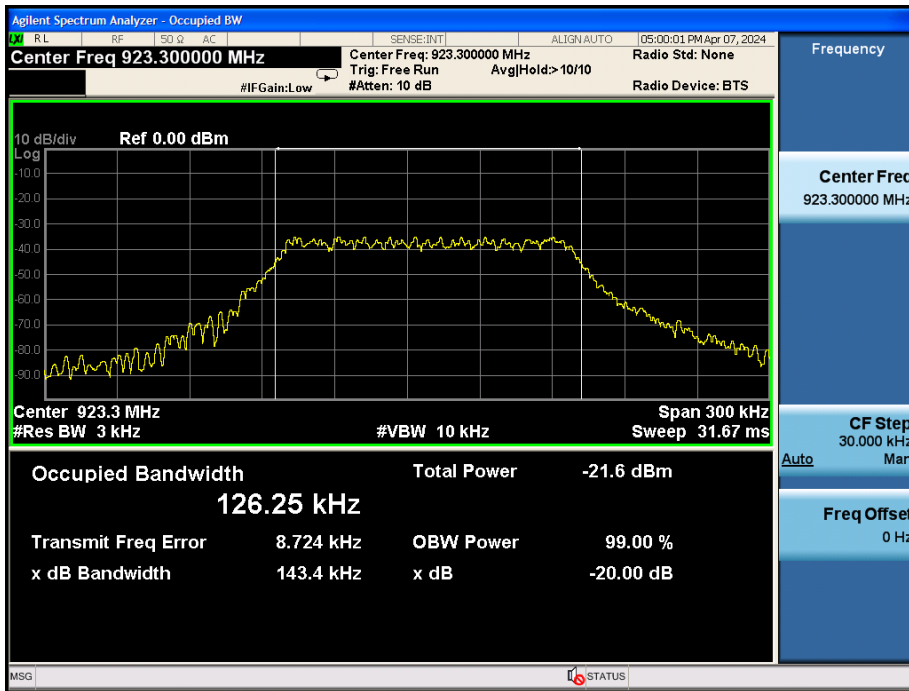
**CH01**

## 10. Calculation of Average Factor

The output field strengths of specification in accordance with the FCC rules specify measurements with an average detector. During the test, a spectrum analyzer incorporating a peak detector was used. Therefore, a reduction factor can be applied to the resultant peak signal level and compared to the limit for measurement instrumentation incorporating an average detector. The duty cycle is measured in 100 ms or the repetition cycle period, whichever is a shorter time frame. The duty cycle is measured by placing the spectrum analyzer to set zero span at 100KHz resolution bandwidth.

923.3MHz

Averaging factor in dB =  $20 \log(\text{duty cycle})$

The duration of one cycle = 100ms

The duty cycle is simply the on-time divided the duration of one cycle

Duty Cycle =  $(31\text{ms} \times 1) / 100\text{ms}$

=  $31\text{ms} / 100\text{ms}$

= 0.31

Therefore, the averaging factor is found by  $20 \log 0.31 = -10.17\text{dB}$

Test plot as follows:

Note: During the 100ms, the amount of pulse and on-time of pulse are the same for every pulse train.

Cycle

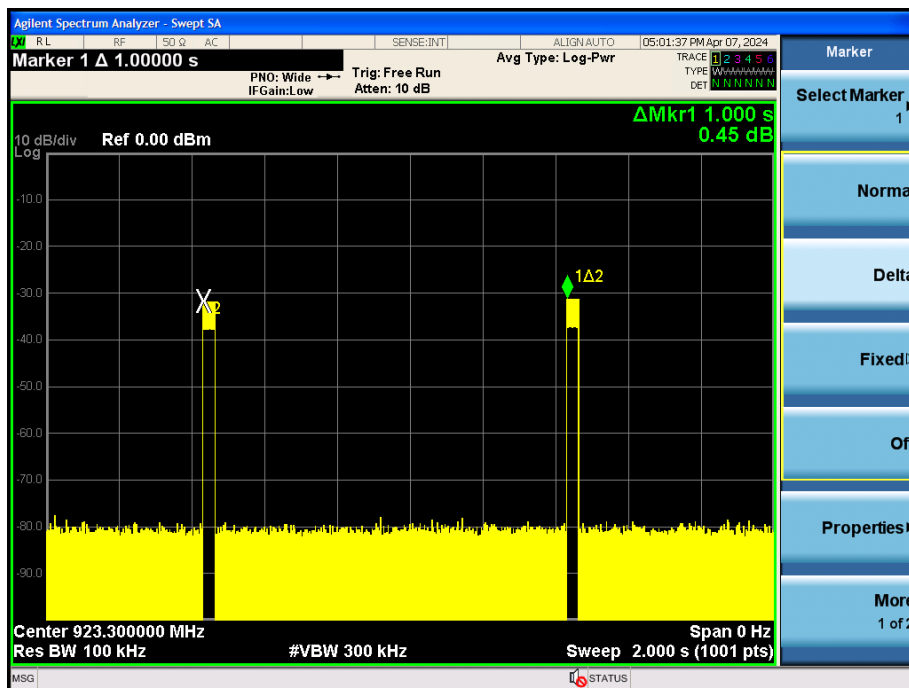

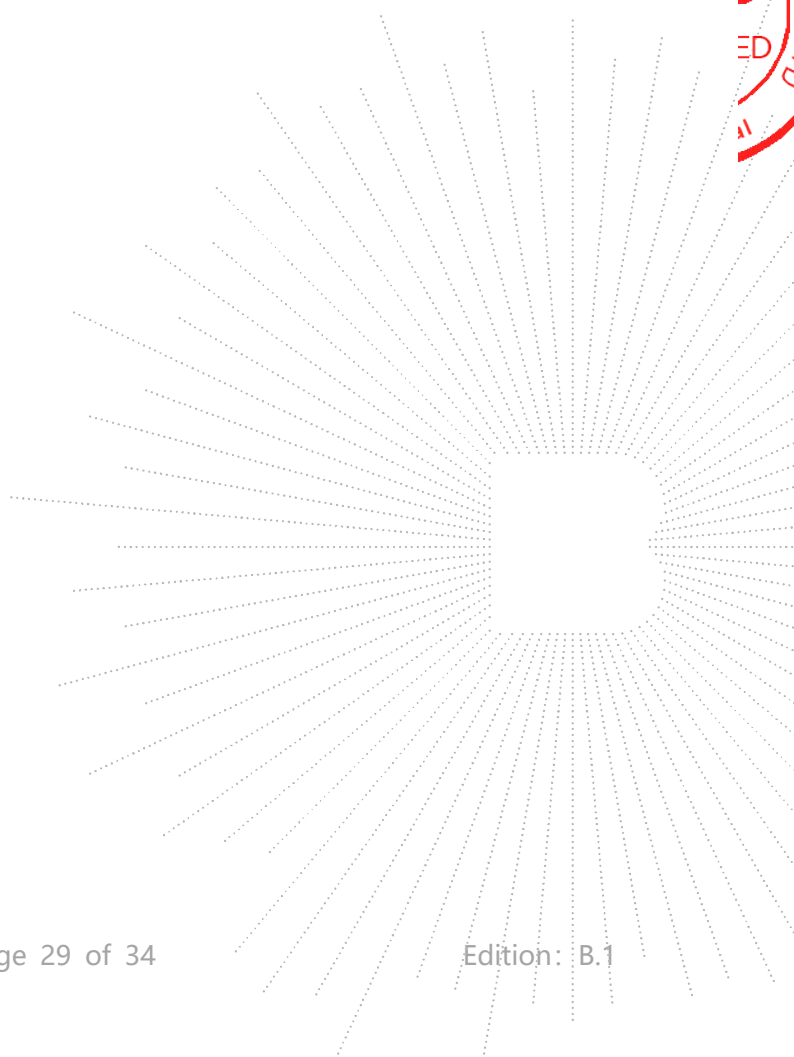
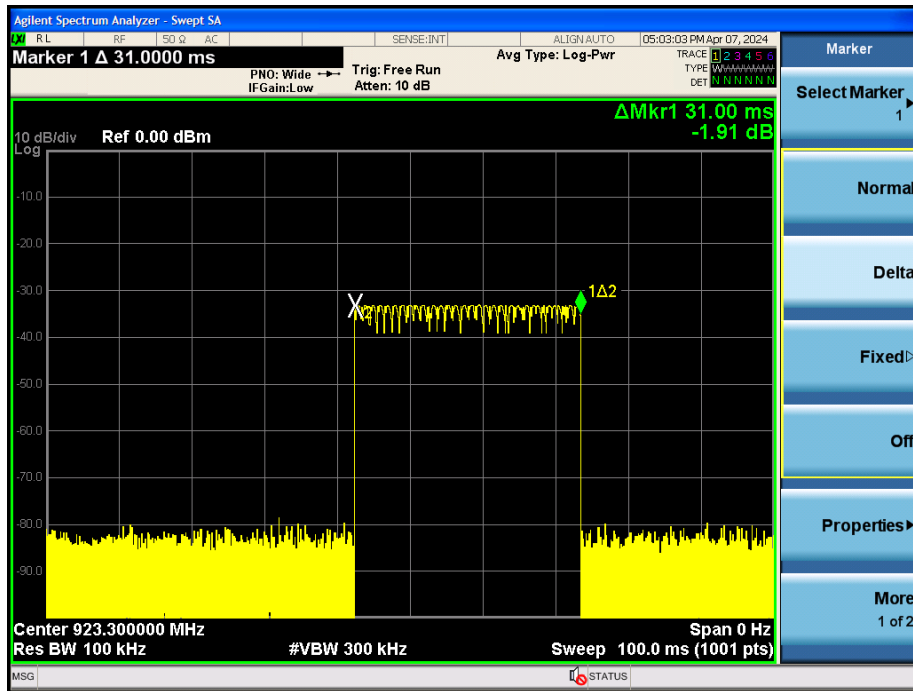
**Pulse and On-time**

## 11. Antenna Requirement

### 11.1 Limit

15.203 requirement: For intentional device, according to 15.203: an intentional radiator shall be designed to ensure that no antenna other than that furnished by the responsible party shall be used with the device.

### 11.2 Test Result

The EUT antenna is Internal antenna, The antenna gain is -1.51 dBi, fulfill the requirement of this section.

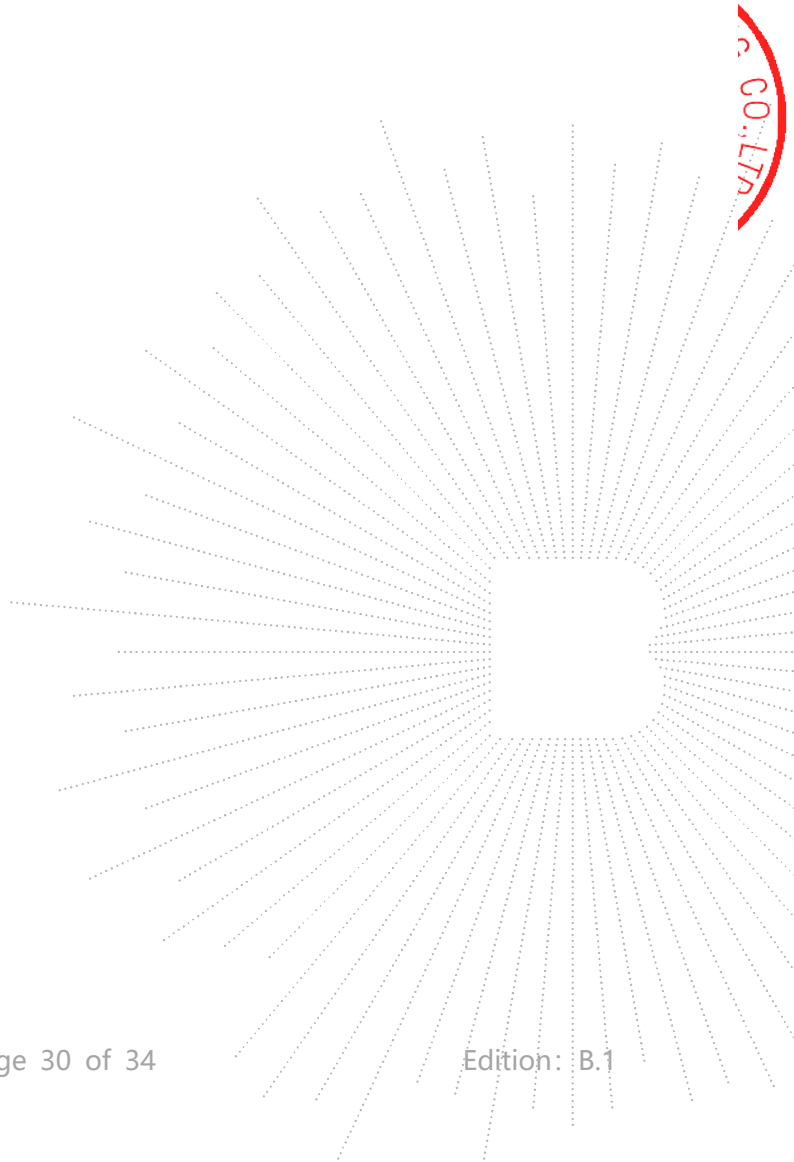

## 12. EUT Photographs

EUT Photo 1



EUT Photo 2





### 13. EUT Test Setup Photographs

#### Conducted Measurement Photo



#### Radiated Measurement Photos

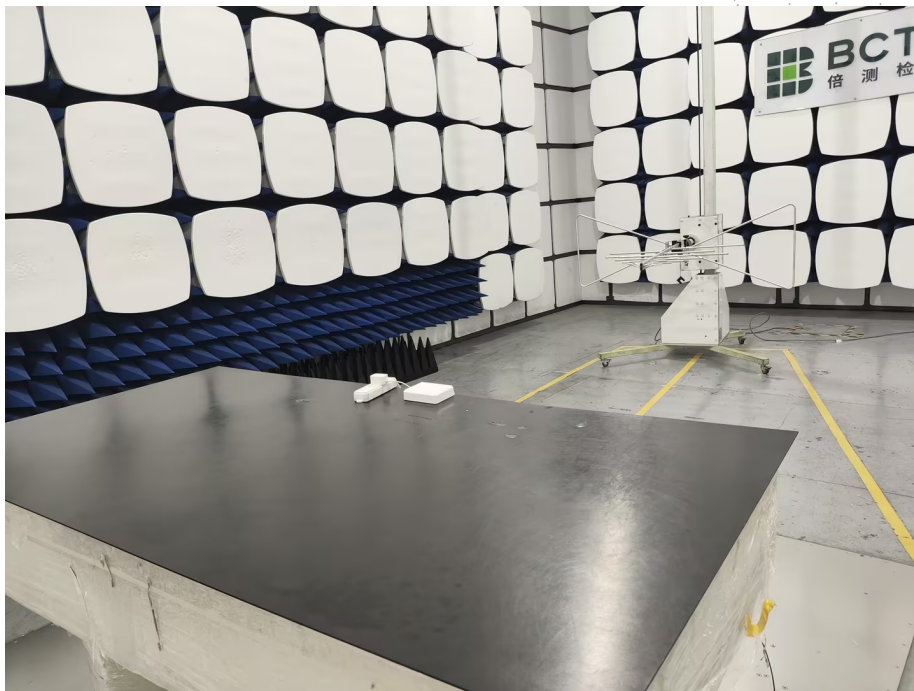

BCTC  
BC  
APPR  
Report



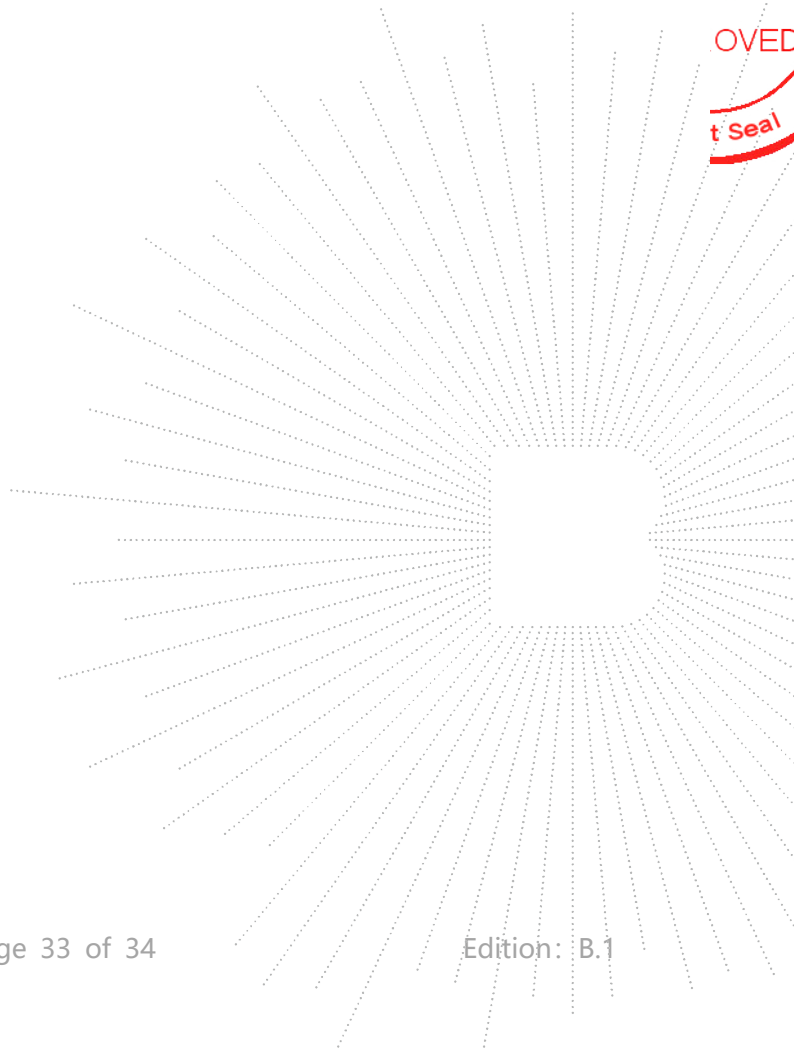

**STATEMENT**

1. The equipment lists are traceable to the national reference standards.
2. The test report can not be partially copied unless prior written approval is issued from our lab.
3. The test report is invalid without the "special seal for inspection and testing".
4. The test report is invalid without the signature of the approver.
5. The test process and test result is only related to the Unit Under Test.
6. Sample information is provided by the client and the laboratory is not responsible for its authenticity.
7. The quality system of our laboratory is in accordance with ISO/IEC17025.
8. If there is any objection to this test report, the client should inform issuing laboratory within 15 days from the date of receiving test report.

**Address:**

1-2/F., Building B, Pengzhou Industrial Park, No.158, Fuyuan 1st Road, Zhancheng, Fuhai Subdistrict, Bao'an District, Shenzhen, Guangdong, China

TEL: 400-788-9558

P.C.: 518103

FAX: 0755-33229357

Website: <http://www.chnbctc.com>E-Mail: [bctc@bctc-lab.com.cn](mailto:bctc@bctc-lab.com.cn)

\*\*\*\*\* END \*\*\*\*\*

