

SAR TEST REPORT

FCC ID: 2AT3DCOSMASV

Product: MOBILE PHONES

Model No.: COSMAS V

Additional Model: N/A

Trade Mark: CELLUTION

Report No.: TCT200403E013

Issued Date: Apr. 17, 2020

Issued for:

CT Cellutions, Inc

5705 Commerce Blvd, Alpharetta, Georgia 30004, United States

Issued By:

Shenzhen Tongce Testing Lab.

**1B/F., Building 1, Yibaolai Industrial Park, Qiaotou, Fuyong, Baoan District,
Shenzhen, Guangdong, China**

TEL: +86-755-27673339

FAX: +86-755-27673332

Note: *This report shall not be reproduced except in full, without the written approval of Shenzhen Tongce Testing Lab..*

This document may be altered or revised by Shenzhen Tongce Testing Lab. personnel only, and shall be noted in the revision section of the document. The test results in the report only apply to the tested sample.

TABLE OF CONTENTS

1.	Test Certification	3
2.	Facilities and Accreditations	4
2.1.	Facilities.....	4
2.2.	Location	4
2.3.	Environment Condition:	4
3.	Test Result Summary	5
4.	EUT Description.....	6
5.	RF Exposure Limit.....	7
6.	SAR Measurement System Configuration	8
6.1.	SAR Measurement Set-up	8
6.2.	E-field Probe	9
6.3.	Phantom.....	9
6.4.	Device Holder	10
6.5.	Data Storage and Evaluation.....	11
6.6.	Position of the wireless device in relation to the phantom	12
6.7.	Tissue Dielectric Parameters	15
6.8.	Tissue-equivalent Liquid Properties	16
6.9.	System Check.....	17
7.	Measurement Procedure.....	18
8.	Conducted Output Power	21
9.	Exposure Position Consideration	26
9.1.	EUT Antenna Location.....	26
9.2.	Test Position Consideration.....	26
10.	SAR Test Results Summary	27
10.1.	Head 1g SAR Data.....	27
10.2.	Body-Worn 1g SAR Data	28
10.3.	Hotspot 1g SAR Data	29
10.4.	Simultaneous Transmission Conclusion.....	31
10.5.	SAR Simultaneous Transmission Analysis	33
10.6.	Measurement Uncertainty (450MHz-3GHz)	36
10.7.	Test Equipment List.....	38
11.	System Check Results	39
12.	SAR Test Data.....	51
	Appendix A: EUT Photos.....	85
	Appendix B: Test Setup Photos.....	88
	Appendix C: Probe Calibration Certificate.....	90
	Appendix D: Dipole Calibration Report.....	107
	Appendix E: SAR SYSTEM VALIDATION	140
	Appendix F: The Check Data of Impedance and Return Loss	141

1. Test Certification

Product:	MOBILE PHONES
Model No.:	COSMAS V
Additional Model No.	N/A
Trade Mark:	CELLUTION
Applicant:	CT Cellutions, Inc
Address:	5705 Commerce Blvd, Alpharetta, Georgia 30004, United States
Manufacturer:	Z-TECH COMMUNICATION(SZ) Co., Ltd
Address:	7/F BLK D BAO'AN ZHI'GU YIN'TIAN RD. NO.4 XI'XIANG ST' BAO'AN SEHNZHEN, CHINA
Date of Test:	Apr. 06, 2020 – Apr. 16, 2020
SAR Max. Values:	0.28 W/Kg (1g) for head; 0.72W/Kg (1g) for Body-worn; 0.76 W/Kg (1g) for Hotspot;
Applicable Standards:	FCC 47 CFR § 2.1093 IEEE1528-2013:Recommended Practice for Determining the Peak Spatial-Average Specific Absorption Rate in the Human Head from Wireless Communications Devices: Measurement Techniques KDB447498 D01:General RF Exposure Guidance v06 KDB865664 D01:SAR measurement 100MHz to 6GHz v01r04 KDB865664 D02:RF Exposure Reporting v01r02. KDB941225 D01:3G SAR Procedures v03r01 KDB248227 D01:802.11 wi-fi SAR v02r02 KDB941225 D06:Hotspot Mode v02r01 KDB941225 D07:UMPC Mini Tablet v01r02 KDB690783 D01:SAR Listings on Grant v01r03

The above equipment has been tested by Shenzhen Tongce Testing Lab. and found compliance with the requirements set forth in the technical standards mentioned above. The results of testing in this report apply only to the product/system, which was tested. Other similar equipment will not necessarily produce the same results due to production tolerance and measurement uncertainties.

Tested By:

Aaron Mo

Aaron Mo

Date:

Apr. 16, 2020

Reviewed By:

Beryl Zhao

Beryl Zhao

Date:

Apr. 17, 2020

Approved By:

Tomsin

Date:

Apr. 17, 2020

2. Facilities and Accreditations

2.1. Facilities

The test facility is recognized, certified, or accredited by the following organizations:

- FCC - Registration No.: 645098

Shenzhen Tongce Testing Lab

The 3m Semi-anechoic chamber has been registered and fully described in a report with the (FCC) Federal Communications Commission. The acceptance letter from the FCC is maintained in our files.

- IC - Registration No.: 10668A-1

The 3m Semi-anechoic chamber of Shenzhen Tongce Testing Lab.. has been registered by Certification and Engineering Bureau of Industry Canada for radio equipment testing

2.2. Location

Shenzhen Tongce Testing Lab

Address: 1B/F., Building 1, Yibaolai Industrial Park, Qiaotou, Fuyong, Baoan District, Shenzhen, Guangdong, China

2.3. Environment Condition:

Temperature:	18°C ~25°C
Humidity:	35%~75% RH
Atmospheric Pressure:	1011 mbar

3. Test Result Summary

The maximum results of Specific Absorption Rate (SAR) found during test as bellows:
<Highest Reported standalone SAR Summary>

Exposure Position	Frequency Band	Reported SAR (W/kg)	Equipment Class	Highest Reported SAR (W/kg)
Head 1-g SAR	GSM 850	0.16	PCE	0.28
	GSM 1900	0.28		
	WCDMA Band II	0.05		
	WCDMA Band V	0.15		
	WLAN 2.4 GHz	0.04	DTS	
Body-worn 1-g SAR (10 mm Gap)	GSM 850	0.36	PCE	0.72
	GSM 1900	0.72		
	WCDMA Band II	0.09		
	WCDMA Band V	0.16		
	WLAN 2.4 GHz	0.07	DTS	
Hotspot 1-g SAR (10 mm Gap)	GSM 850	0.38	PCE	0.76
	GSM 1900	0.76		
	WCDMA Band II	0.11		
	WCDMA Band V	0.17		
	WLAN 2.4 GHz	0.09	DTS	

<Highest Reported simultaneous SAR Summary>

Exposure Position	Frequency Band	Highest Reported Simultaneous Transmission SAR (W/kg)
Head 1-g SAR	GSM 1900 + BT	0.35
Body 1-g SAR (10 mm Gap)	GSM 1900 + WIFI2.4G	0.79
Hotspot 1-g SAR (10 mm Gap)	GSM 1900 + WIFI2.4G	0.85

Note:

1. The highest simultaneous transmission is scalar summation of Reported standalone SAR per FCC KDB 690783 D01 v01r03, and scalar SAR summation of all possible simultaneous transmission scenarios are < 1.6W/kg.
2. This device is compliance with Specific Absorption Rate (SAR) for general population/uncontrolled exposure limits specified in FCC 47 CFR part 2 (2.1093) and ANSI/IEEE C95.1-2005, and had been tested in accordance with the measurement methods and procedures specified in IEEE 1528-2013.
3. This EUT owns two SIM cards, after we perform the pretest for these two SIM card; we found the SIM 1 is the worst case, so its result is recorded in this report.

4. EUT Description

Product Name:	MOBILE PHONES
Model :	COSMAS V
Additional Model:	N/A
Trade Mark:	CELLUTION
Power Supply:	Rechargeable Li-ion Battery DC3.7V
2G	
Operation Band:	GSM850, GSM1900
Supported type:	GSM/GPRS/EGPRS
Power Class:	GSM850:Power Class 5; GSM1900:Power Class 0
Modulation Type:	GMSK for GSM/GPRS; 8PSK for EGPRS
GSM Release Version:	R99
GPRS Multislot Class:	12
EGPRS Multislot Class:	12
3G	
Operation Band:	FDD Band II & FDD Band V
Power Class:	Power Class 3
Modulation Type:	QPSK for WCDMA/HSDPA/HSUPA
WCDMA Release Version:	R99
HSDPA Release Version:	Release 5
HSUPA Release Version:	Release 6
DC-HSUPA Release Version:	Not Supported
Wi-Fi 2.4G	
Supported type:	802.11b/802.11g/802.11n
Modulation:	802.11b: DSSS 802.11g/802.11n:OFDM
Operation frequency:	802.11b/802.11g/802.11n(HT20):2412MHz~2462MHz; 802.11n(HT40):2422MHz~2452MHz
Channel number:	802.11b/802.11g/802.11n(HT20):11; 802.11n(HT40):7
Channel separation:	5MHz
Bluetooth	
Bluetooth Version:	Supported 4.0
Modulation:	GFSK(1Mbps) , $\pi/4$ -DQPSK(2Mbps) , 8-DPSK(3Mbps)
Operation frequency:	2402MHz~2480MHz
Channel number:	79/40
Channel separation:	1MHz/2MHz

5. RF Exposure Limit

Type Exposure	SAR (W/kg)
	Uncontrolled Exposure Limit
Spatial Peak SAR (averaged over any 1 g of tissue)	1.60
Spatial Peak SAR (hands/wrists/feet/ankles averaged over 10g)	4.00
Spatial Peak SAR (averaged over the whole body)	0.08

Note:

1. The Spatial Peak value of the SAR averaged over any 1 gram of tissue (defined as a tissue volume in the shape of a cube) and over the appropriate averaging time.
2. The Spatial Average value of the SAR averaged over the whole body.
3. The Spatial Peak value of the SAR averaged over any 10 grams of tissue (defined as a tissue volume in the shape of a cube) and over the appropriate averaging time.

6. SAR Measurement System Configuration

6.1. SAR Measurement Set-up

The OPENSAR system for performing compliance tests consist of the following items:

A standard high precision 6-axis robot (KUKA) with controller and software.

KUKA Control Panel (KCP)

A dosimetric probe, i.e., an isotropic E-field probe optimized and calibrated for usage in tissue simulating liquid. The probe is equipped with a Video Positioning System (VPS).

The stress sensor is composed with mechanical and electronic when the electronic part detects a change on the electro-mechanical switch; it sends an "Emergency signal" to the robot controller that to stop robot's moves A computer operating Windows XP.

OPENSAR software Remote control with teaches pendant and additional circuitry for robot safety such as warning lamps, etc.

The SAM phantom enabling testing left-hand right-hand and body usage.

The Position device for handheld EUT

Tissue simulating liquid mixed according to the given recipes.

System validation dipoles to validate the proper functioning of the system.

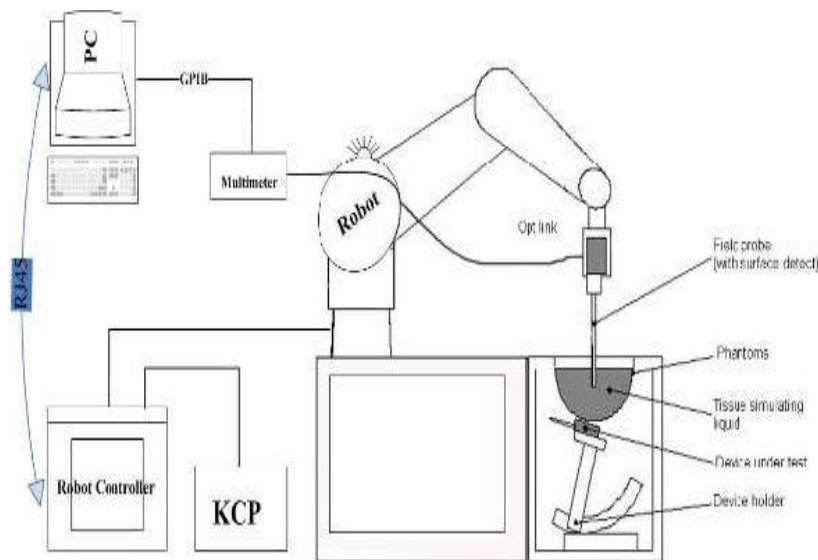

KUKA SAR Test System Configuration

6.2. E-field Probe

The SAR measurement is conducted with the dosimetric probe (manufactured by MVG). The probe is specially designed and calibrated for use in liquid with high permittivity. The dosimetric probe has special calibration in liquid at different frequency. This probe has a built in optical surface detection system to prevent from collision with phantom.

Probe Specification

Construction Symmetrical design with triangular core
Interleaved sensors
Built-in shielding against static charges
PEEK enclosure material (resistant to organic solvents, e.g., DGBE)
Calibration ISO/IEC 17025 calibration service available.

Device Type	COMOSAR DOSIMETRIC E FIELD PROBE
Manufacturer	MVG
Model	SSE2
Serial Number	SN 41/18 EP331
Frequency Range of Probe	0.40 GHz-6GHz
Resistance of Three Dipoles at Connector	Dipole 1:R1=0.184MΩ Dipole 2:R3=0.191MΩ Dipole 3:R3=0.192MΩ

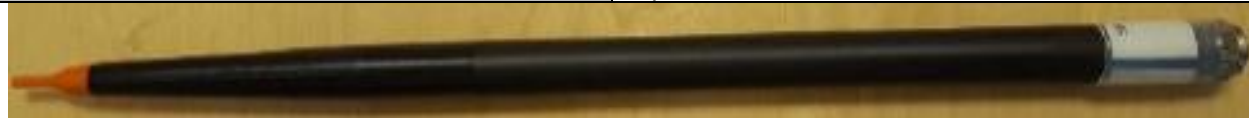

Photo of E-Field Probe

6.3. Phantom

The SAM Phantom SAM120 is constructed of a fiberglass shell integrated in a wooden table. The shape of the shell is in compliance with the specification set in IEEE P1528 and CENELEC IEC 62209-1, IEC 62209-2:2010.

The phantom enables the dosimetric evaluation of left and right hand phone usage as well as body mounted usage at the flat phantom region.

A cover prevents the evaporation of the liquid.

Reference markings on the Phantom allow the complete setup of all predefined phantom positions and measurement grids by manually teaching three points in the robot

System checking was performed using the flat section, whilst Head SAR tests used the left and right head profile sections.

Body SAR testing also used the flat section between the head profiles.

Name: COMOSAR IEEE SAM PHANTOM

S/N: SN 19/15 SAM 120

Manufacture: MVG

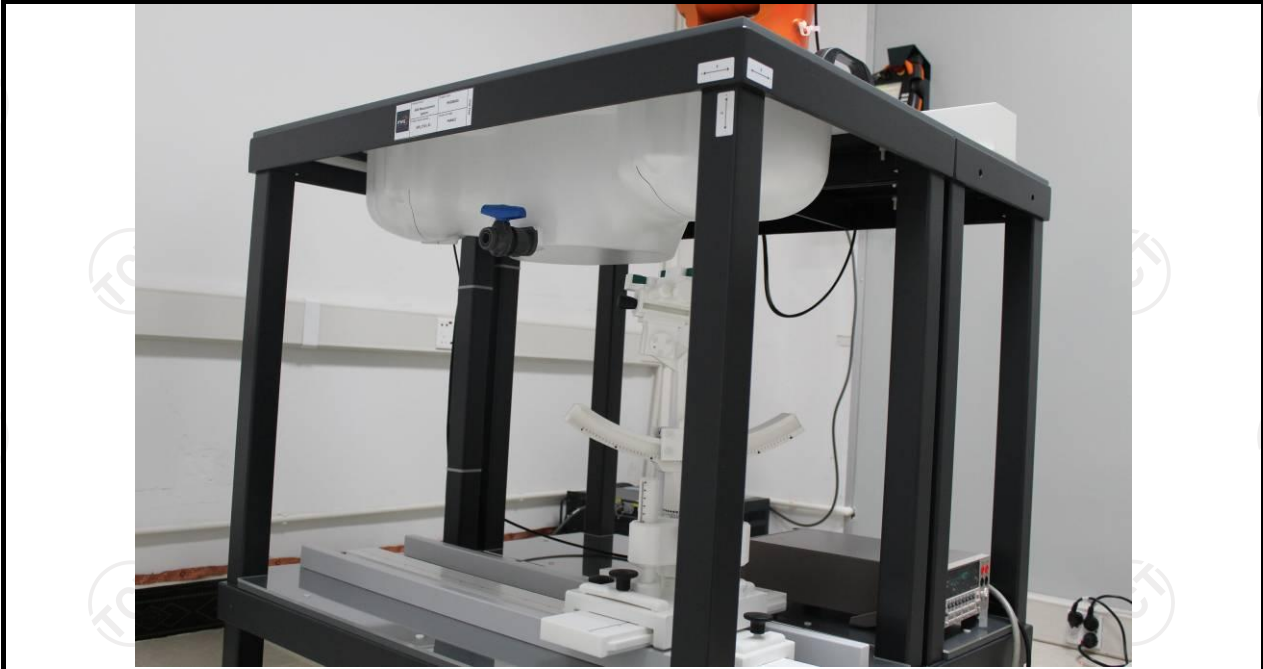

SAM Twin Phantom

6.4. Device Holder

In combination with the Generic Twin Phantom SAM120, the Mounting Device enables the rotation of the mounted transmitter in spherical coordinates whereby the rotation points is the ear opening. The devices can be easily, accurately, and repeatedly positioned according to the FCC and CENELEC specifications. The device holder can be locked at different phantom locations (left head, right head, flat phantom).

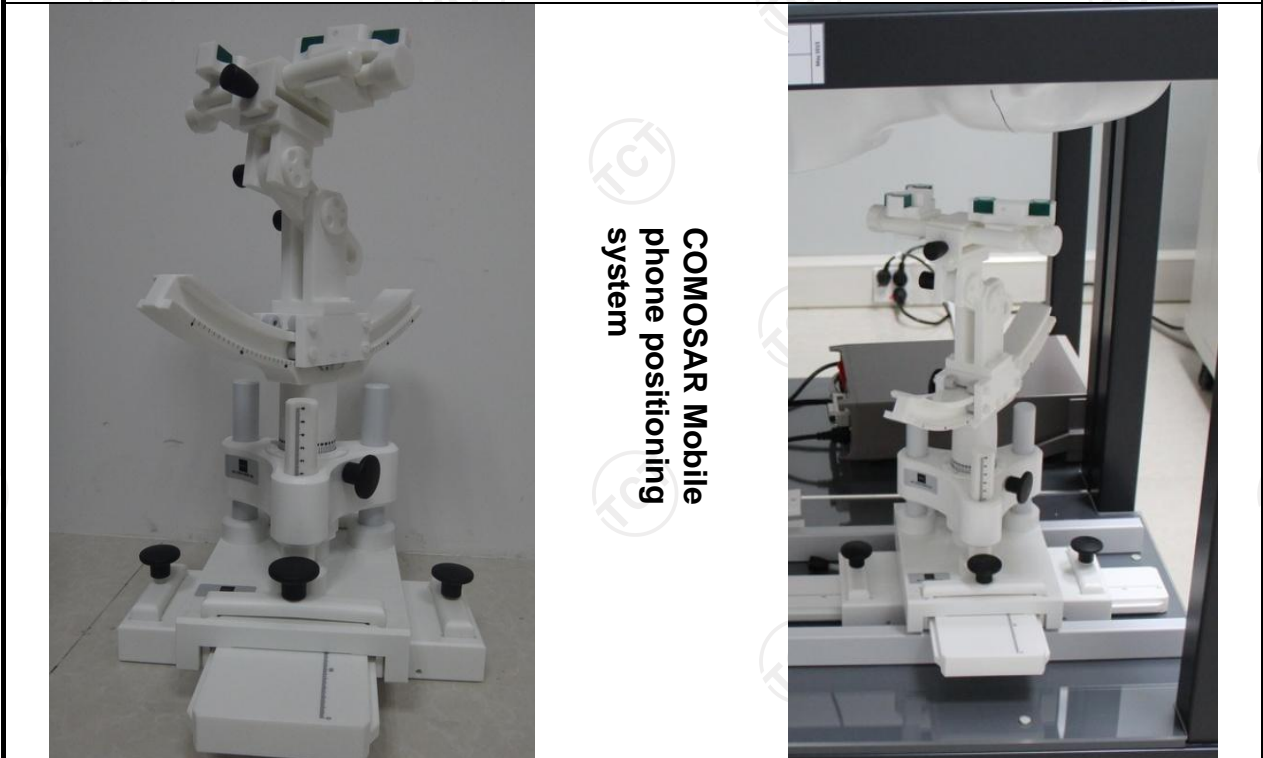

COMOSAR Mobile
phone positioning
system

6.5. Data Storage and Evaluation

Data Storage

The OPENSAR software stores the acquired data from the data acquisition electronics as raw data (in microvolt readings from the probe sensors), together with all necessary software parameters for the data evaluation (probe calibration data, liquid parameters and device frequency and modulation data) in measurement files. The software evaluates the desired unit and format for output each time the data is visualized or exported. This allows verification of the complete software setup even after the measurement and allows correction of incorrect parameter settings. For example, if a measurement has been performed with a wrong crest factor parameter in the device setup, the parameter can be corrected afterwards and the data can be re-evaluated.

The measured data can be visualized or exported in different units or formats, depending on the selected probe type ([V/m], [A/m], [°C], [mW/g], [mW/cm²], [dBre], etc.). Some of these units are not available in certain situations or show meaningless results, e.g., a SAR output in a lossless media will always be zero. Raw data can also be exported to perform the evaluation with other software packages.

Data Evaluation

The OPENSAR software automatically executes the following procedures to calculate the field units from the microvolt readings at the probe connector. The parameters used in the evaluation are stored in the configuration modules of the software:

Probe parameters:	- Sensitivity	Normi, ai0, ai1, ai2
	- Conversion factor	ConvFi
	- Diode compression point	Dcpi
Device parameters:	- Frequency	f
	- Crest factor	cf
Media parameters:	- Conductivity	σ
	- Density	ρ

These parameters must be set correctly in the software. They can be found in the component documents or they can be imported into the software from the configuration files issued for the OPENSAR components. In the direct measuring mode of the millimeter option, the parameters of the actual system setup are used. In the scan visualization and export modes, the parameters stored in the corresponding document files are used.

The first step of the evaluation is a linearization of the filtered input signal to account for the compression characteristics of the detector diode. The compensation depends on the input signal, the diode type and the DC-transmission factor from the diode to the evaluation electronics. If the exciting field is pulsed, the crest factor of the signal must be known to correctly compensate for peak power. The formula for each channel can be given as:

$$V_i = U_i + U_i^2 \cdot c f / d c p_i$$

With	V_i	= compensated signal of channel i	(i = x, y, z)
	U_i	= input signal of channel i	(i = x, y, z)
	cf	= crest factor of exciting field	(MVG parameter)
	dcpi	= diode compression point	(MVG parameter)

From the compensated input signals the primary field data for each channel can be evaluated:

$$\text{E-field probes: } E_i = (V_i / \text{Normi} \cdot \text{ConvF})^{1/2}$$

$$\text{H-field probes: } H_i = (V_i)^{1/2} \cdot (a_{i0} + a_{i1} f + a_{i2} f^2) / f$$

With	V_i	= compensated signal of channel i	(i = x, y, z)
	Normi	= sensor sensitivity of channel i	(i = x, y, z)
	ConvF	= sensitivity enhancement in solution	[mV/(V/m) ²] for E-field Probes
	a _{ij}	= sensor sensitivity factors for H-field probes	
	f	= carrier frequency [GHz]	
	E_i	= electric field strength of channel i in V/m	
	H_i	= magnetic field strength of channel i in A/m	

The RSS value of the field components gives the total field strength (Hermitian magnitude):

$$E_{tot} = (E_x^2 + E_y^2 + E_z^2)^{1/2}$$

The primary field data are used to calculate the derived field units.

$$SAR = (E_{tot})^2 \cdot \sigma / (\rho \cdot 1000)$$

- with SAR = local specific absorption rate in mW/g
- E_{tot} = total field strength in V/m
- σ = conductivity in [mho/m] or [Siemens/m]
- ρ = equivalent tissue density in g/cm³

Note that the density is normally set to 1 (or 1.06), to account for actual brain density rather than the density of the simulation liquid. The power flow density is calculated assuming the excitation field to be a free space field.

6.6. Position of the wireless device in relation to the phantom

Handset Reference Points

$$P_{pwe} = E_{tot}^2 / 3770 \text{ or } P_{pwe} = H_{tot}^2 \cdot 37.7$$

- With P_{pwe} = equivalent power density of a plane wave in mW/cm²
- E_{tot} = total electric field strength in V/m
- H_{tot} = total magnetic field strength in A/m

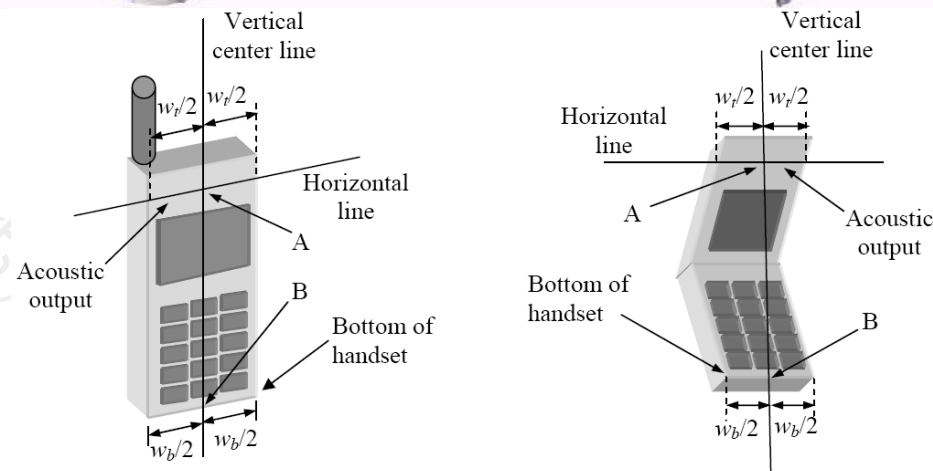

- W_t Width of the handset at the level of the acoustic
- W_b Width of the bottom of the handset
- A Midpoint of the width w_t of the handset at the level of the acoustic output
- B Midpoint of the width w_b of the bottom of the handset

Positioning for Cheek / Touch

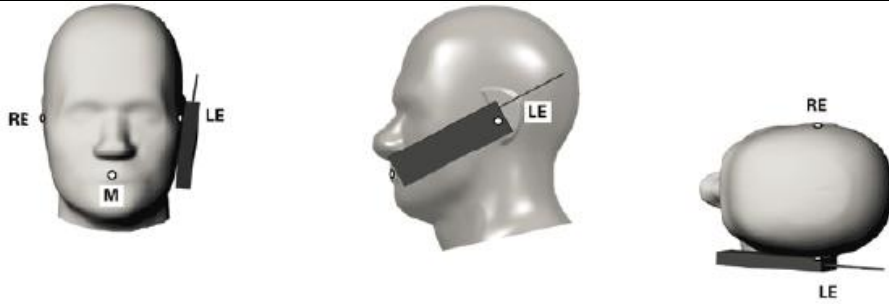

Positioning for Ear / 15° Tilt

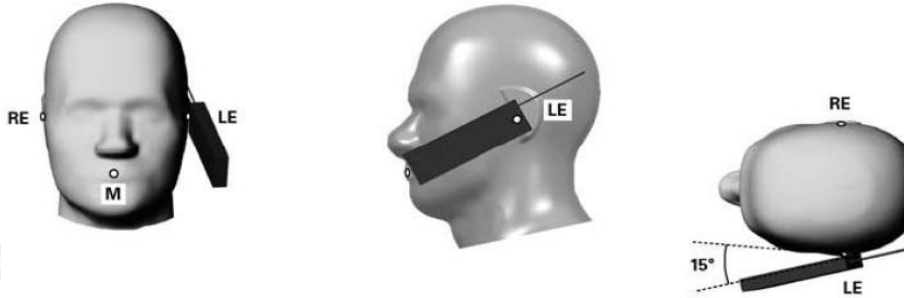

Body Worn Accessory Configurations

To position the device parallel to the phantom surface with either keypad up or down.

To adjust the device parallel to the flat phantom.

To adjust the distance between the device surface and the flat phantom to 15mm or holster surface and the flat phantom to 0 mm.

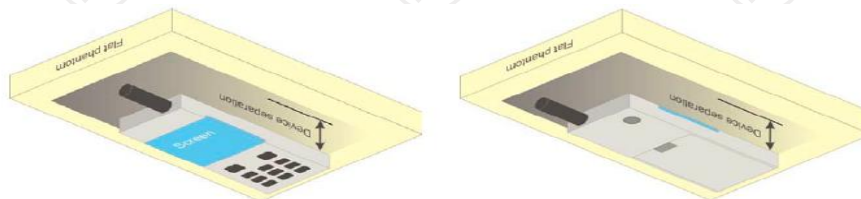

Illustration for Body Worn Position

Wireless Router (Hotspot) Configurations

Some battery-operated handsets have the capability to transmit and receive internet connectivity through simultaneous transmission of WIFI in conjunction with a separate licensed transmitter. The FCC has provided guidance in KDB Publication 941225 D06 where SAR test considerations for handsets (L x W ≥

9 cm x 5 cm) are based on a composite test separation distance of 10 mm from the front, back and edges of the device with antennas 2.5 cm or closer to the edge of the device, determined from general mixed use conditions for this type of devices. Since the hotspot SAR results may overlap with the body-worn accessory SAR requirements, the more conservative configurations can be considered, thus excluding some body-worn accessory SAR tests.

When the user enables the personal wireless router functions for the handset, actual operations include simultaneous transmission of both the WIFI transmitter and another licensed transmitter. Both transmitters often do not transmit at the same transmitting frequency and thus cannot be evaluated for SAR under actual use conditions. Therefore, SAR must be evaluated for each frequency transmission and mode separately and summed with the WIFI transmitter according to KDB 648474 publication procedures. The "Portable Hotspot" feature on the handset was NOT activated, to ensure the SAR measurements were evaluated for a single transmission frequency RF signal.

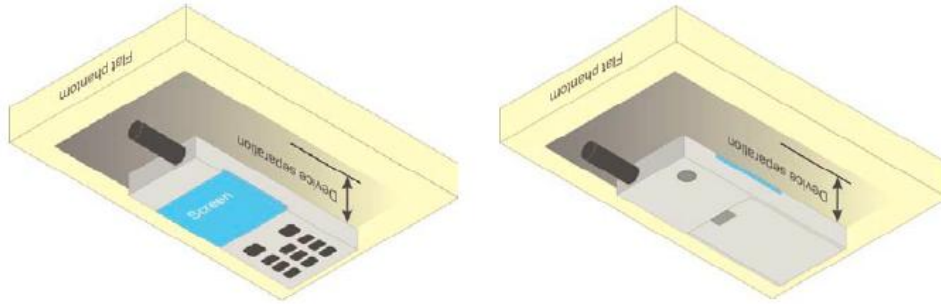
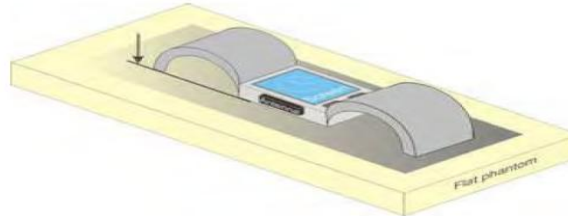

Illustration for Hotspot Position

Limb-worn device

A limb-worn device is a unit whose intended use includes being strapped to the arm or leg of the user while transmitting (except in idle mode). It is similar to a body-worn device. Therefore, the test positions of 6.1.4.4 also apply. The strap shall be opened so that it is divided into two parts as shown in Figure 9. The device shall be positioned directly against the phantom surface with the strap straightened as much as possible and the back of the device towards the phantom.

If the strap cannot normally be opened to allow placing in direct contact with the phantom surface, it may be necessary to break the strap of the device but ensuring to not damage the antenna.



Test position for limb-worn devices

6.7. Tissue Dielectric Parameters

The liquid used for the frequency range of 100MHz-6G consisted of water, sugar, salt and Cellulose. The liquid has been previously proven to be suited for worst-case. The following Table shows the detail solution. It's satisfying the latest tissue dielectric parameters requirements proposed by the IEEE 1528 and IEC 62209. The simulating liquids should be checked at the beginning of a series of SAR measurements to determine of the determine of the dielectric parameter are within the tolerances of the specified target values. The measured conductivity and relative permittivity should be within $\pm 5\%$ of the target values.

The following materials are used for producing the tissue-equivalent materials

Targets for tissue simulating liquid

Frequency (MHz)	Liquid Type	Liquid Type (σ)	$\pm 5\%$ Range	Permittivity (ϵ)	$\pm 5\%$ Range
300	Head	0.87	0.83~0.91	45.3	43.04~47.57
450	Head	0.87	0.83~0.91	43.5	41.33~45.68
835	Head	0.90	0.86~0.95	41.5	39.43~43.58
900	Head	0.97	0.92~1.02	41.5	39.43~43.58
1800-2000	Head	1.40	1.33~1.47	40.0	38.00~42.00
2450	Head	1.80	1.71~1.89	39.2	37.24~41.16
2600	Head	1.96	1.86~2.06	39.0	37.05~40.95
3000	Head	2.40	2.28~2.52	38.5	36.58~40.43
5800	Head	5.27	5.01~5.53	35.3	33.54~37.07
300	Body	0.92	0.87~0.97	58.2	55.29~61.11
450	Body	0.94	0.89~0.99	56.7	53.87~59.54
835	Body	0.97	0.92~1.02	55.2	52.44~57.96
900	Body	1.05	1.00~1.10	55.0	52.25~57.75
1800-2000	Body	1.52	1.44~1.60	53.3	50.64~55.97
2450	Body	1.95	1.85~2.05	52.7	50.07~55.34
2600	Body	2.16	2.05~2.27	52.5	49.88~55.13
3000	Body	2.73	2.60~2.87	52.0	49.40~54.60
5800	Body	6.00	5.70~6.30	48.2	45.79~50.61

(ϵ_r = relative permittivity, σ = conductivity and $\rho = 1000 \text{ kg/m}^3$)

6.8. Tissue-equivalent Liquid Properties

Test Date dd/mm/yy	Temp °C	Tissue Type	Measured Frequency (MHz)	ϵ_r	σ (s/m)	Dev ϵ_r (%)	Dev σ (%)
03/06/2020	22°C	835H	825	41.43	0.86	-0.17	-4.44
			835	41.42	0.87	-0.19	-3.33
			850	40.39	0.88	-2.67	-2.22
03/10/2020	22°C	1900H	1850	39.11	1.34	-2.23	-4.29
			1880	39.10	1.35	-2.25	-3.57
			1900	39.08	1.37	-2.30	-2.14
			1910	39.07	1.38	-2.33	-1.43
03/15/2020	22°C	2450H	2410	37.84	1.79	-3.47	-0.56
			2435	37.85	1.81	-3.44	0.56
			2450	37.82	1.83	-3.52	1.67
			2460	37.80	1.84	-3.57	2.22
03/06/2020	22°C	835B	825	55.26	0.93	0.11	-4.12
			835	55.24	0.94	0.07	-3.09
			850	55.21	0.97	0.02	0.00
03/10/2020	22°C	1900B	1850	53.34	1.49	0.08	-1.97
			1880	53.32	1.50	0.04	-1.32
			1900	53.31	1.51	0.02	-0.66
			1910	53.29	1.53	-0.02	0.66
03/15/2020	22°C	2450B	2410	54.65	1.97	3.70	1.03
			2435	54.63	1.98	3.66	1.54
			2450	54.62	2.01	3.64	3.08
			2460	54.59	2.03	3.59	4.10

6.9. System Check

The SAR system must be validated against its performance specifications before it is deployed. When SAR probe and system component or software are changed, upgraded or recalibrated, these must be validated with the SAR system(s) that operates with such component. Reference dipoles are used with the required tissue-equivalent media for system validation.

System check results have to be equal or near the values determined during dipole calibration with the relevant liquids and test system ($\pm 10\%$).

System check is performed regularly on all frequency bands where tests are performed with the OPENSAR system.

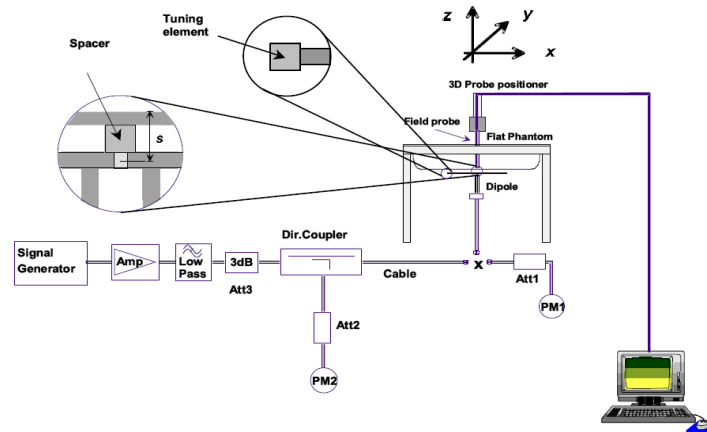

System Check Set-up

Verification Results

Frequency (MHz)	Liquid Type	Measured Value in 100mW (W/kg)		Normalized to 1W (W/kg)		Target Value (W/kg)		Deviation (%)	
		1 g Average	10 g Average	1 g Average	10 g Average	1 g Average	10 g Average	1 g Average	10 g Average
835	Head	0.89	0.57	8.90	5.70	9.53	6.12	-6.61	-6.86
1900	Head	3.58	1.90	35.80	19.00	39.26	20.49	-8.81	-7.27
2450	Head	4.99	2.36	49.90	23.60	53.26	24.15	-6.31	-2.28
835	Body	0.95	0.63	9.50	6.30	9.62	6.44	-1.25	-2.17
1900	Body	3.77	1.99	37.70	19.90	38.71	20.53	-2.61	-3.07
2450	Body	5.07	2.42	50.70	24.16	50.63	23.40	0.14	3.25

Comparing to the original SAR value provided by MVG, the verification data should be within its specification of 10%. Below table shows the target SAR and measured SAR after normalized to 1W input power. The table as below indicates the system performance check can meet the variation criterion and the plots can be referred to Section 10 of this report.

7. Measurement Procedure

Conducted power measurement

For WWAN power measurement, use base station simulator to configure EUT WWAN transition in conducted connection with RF cable, at maximum power in each supported wireless interface and frequency band.

Read the WWAN RF power level from the base station simulator.

For WLAN/BT power measurement, use engineering software to configure EUT WLAN/BT continuously transmission, at maximum RF power in each supported wireless interface and frequency band.

Connect EUT RF port through RF cable to the power meter or spectrum analyser, and measure WLAN/BT output power.

Conducted power measurement

Use base station simulator to configure EUT WWAN transmission in radiated connection, and engineering software to configure EUT WLAN/BT continuously transmission, at maximum RF power, in the highest power channel.

Place the EUT in positions as Appendix B demonstrates.

Set scan area, grid size and other setting on the MVG software.

Measure SAR results for the highest power channel on each testing position.

Find out the largest SAR result on these testing positions of each band.

Measure SAR results for other channels in worst SAR testing position if the Reported SAR or highest power channel is larger than 0.8 W/kg.

According to the test standard, the recommended procedure for assessing the peak spatial-average SAR value consists of the following steps:

Power reference measurement

Area scan

Zoom scan

Power drift measurement

Spatial Peak SAR Evaluation

The procedure for spatial peak SAR evaluation has been implemented according to the test standard. It can be conducted for 1g and 10g, as well as for user-specific masses. The MVG software includes all numerical procedures necessary to evaluate the spatial peak SAR value.

The base for the evaluation is a "cube" measurement. The measured volume must include the 1g and 10g cubes with the highest averaged SAR values. For that purpose, the center of the measured volume is aligned to the interpolated peak SAR value of a previously performed area scan.

The entire evaluation of the spatial peak values is performed within the post-processing engine (SEMCAD). The system always gives the maximum values for 1g and 10g cubes. The algorithm to find the cube with highest averaged SAR is divided into the following stages:

Extraction of the measured data (grid and values) from the Zoom Scan.

Calculation of the SAR value at every measurement point based on all stored data (A/D values and measurement parameters).

Generation of a high-resolution mesh within the measured volume.

Interpolation of all measured values from the measurement grid to the high-resolution grid

Extrapolation of the entire 3-D field distribution to the phantom surface over the distance from sensor to surface

Calculation of the averaged SAR within masses of 1g and 10g.

Power Reference Measurement

The Power Reference Measurement and Power Drift Measurement are for monitoring the power drift of the device under test in the batch process. The minimum distance of probe sensors to surface determines the closest measurement point to phantom surface. This distance cannot be smaller than the distance of sensor calibration points to probe tip as defined in the probe properties

Area & Zoom Scan Procedures

First Area Scan is used to locate the approximate location(s) of the local peak SAR value(s). The measurement grid within an Area Scan is defined by the grid extent, grid step size and grid offset. Next, in order to determine the EM field distribution in a three-dimensional spatial extension, Zoom Scan is required. The Zoom Scan is performed around the highest E-field value to determine the averaged SAR-distribution over 10g. Area scan and zoom scan resolution setting follows KDB 865664 D01v01r03 quoted below.

		≤ 3 GHz	> 3 GHz	
Maximum distance from closest measurement point (geometric center of probe sensors) to phantom surface		5 mm ± 1 mm	$\frac{1}{2} \cdot \delta \cdot \ln(2)$ mm ± 0.5 mm	
Maximum probe angle from probe axis to phantom surface normal at the measurement location		30° ± 1°	20° ± 1°	
Maximum area scan spatial resolution: Δx_{Area} , Δy_{Area}		≤ 2 GHz: ≤ 15 mm 2 – 3 GHz: ≤ 12 mm	3 – 4 GHz: ≤ 12 mm 4 – 6 GHz: ≤ 10 mm	
		When the x or y dimension of the test device, in the measurement plane orientation, is smaller than the above, the measurement resolution must be ≤ the corresponding x or y dimension of the test device with at least one measurement point on the test device.		
Maximum zoom scan spatial resolution: Δx_{Zoom} , Δy_{Zoom}		≤ 2 GHz: ≤ 8 mm 2 – 3 GHz: ≤ 5 mm*	3 – 4 GHz: ≤ 5 mm* 4 – 6 GHz: ≤ 4 mm*	
Maximum zoom scan spatial resolution, normal to phantom surface	uniform grid: $\Delta z_{Zoom}(n)$	≤ 5 mm	3 – 4 GHz: ≤ 4 mm 4 – 5 GHz: ≤ 3 mm 5 – 6 GHz: ≤ 2 mm	
	graded grid	$\Delta z_{Zoom}(1)$: between 1 st two points closest to phantom surface	≤ 4 mm	3 – 4 GHz: ≤ 3 mm 4 – 5 GHz: ≤ 2.5 mm 5 – 6 GHz: ≤ 2 mm
		$\Delta z_{Zoom}(n>1)$: between subsequent points	≤ 1.5 · $\Delta z_{Zoom}(n-1)$ mm	
Minimum zoom scan volume	x, y, z	≥ 30 mm	3 – 4 GHz: ≥ 28 mm 4 – 5 GHz: ≥ 25 mm 5 – 6 GHz: ≥ 22 mm	
Note: δ is the penetration depth of a plane-wave at normal incidence to the tissue medium; see IEEE Std 1528-2013 for details.				
* When zoom scan is required and the <i>reported</i> SAR from the <i>area scan based 1-g SAR estimation</i> procedures of KDB Publication 447498 is ≤ 1.4 W/kg, ≤ 8 mm, ≤ 7 mm and ≤ 5 mm zoom scan resolution may be applied, respectively, for 2 GHz to 3 GHz, 3 GHz to 4 GHz and 4 GHz to 6 GHz.				

Volume Scan Procedures

The volume scan is used for assess overlapping SAR distributions for antennas transmitting in different frequency bands. It is equivalent to an oversized zoom scan used in standalone measurements. The measurement volume will be used to enclose all the simultaneous transmitting antennas. For antennas transmitting simultaneously in different frequency bands, the volume scan is measured separately in each frequency band. In order to sum correctly to compute the 1g aggregate SAR, the EUT remain in the same test position for all measurements and all volume scan use the same spatial resolution and grid spacing. When all volume scan were completed, the software, SEMCAD post-processor scan combine and subsequently superpose these measurement data to calculating the multiband SAR.

SAR Averaged Methods

In MVG, the interpolation and extrapolation are both based on the modified Quadratic Shepard's method. The interpolation scheme combines a least-square fitted function method and a weighted average method which are the two basic types of computational interpolation and approximation.

Extrapolation routines are used to obtain SAR values between the lowest measurement points and the inner phantom surface. The extrapolation distance is determined by the surface detection distance and the probe sensor offset. The uncertainty increases with the extrapolation distance. To keep the uncertainty within 1% for the 1g and 10g cubes, the extrapolation distance should not be larger than 5 mm.

Power Drift Monitoring

All SAR testing is under the EUT install full charged battery and transmit maximum output power. In MVG measurement software, the power reference measurement and power drift measurement procedures are used for monitoring the power drift of EUT during SAR test. Both these procedures measure the field at a specified reference position before and after the SAR testing. The software will calculate the field difference in dB. If the power drifts more than 5%, the SAR will be retested.

Power Drift measurement

The drift job measures the field at the same location as the most recent reference job within the same procedure, and with the same settings. The drift measurement gives the field difference in dB from the reading conducted within the last reference measurement. Several drift measurements are possible for

Measurement Uncertainty

Per KDB 865664 D01 SAR Measurement 100KHz to 6GHz ,when the highest measurement 1-g SAR within a frequency band is $<1.5\text{W/kg}$, the extensive SAR measurement uncertainty analysis described IEEE Std 1528-2013 is not required in SAR report submitted for equipment approval.

8. Conducted Output Power

Band: GSM 850	Measured Power (dBm)			Calculation (dB)	Averaged Power (dBm)		
	Channel	128	190		251	128	190
Frequency	824.2	836.6	848.8		824.2	836.6	848.8
GSM (GMSK, Voice)	33.42	33.36	33.48	-9.03	24.39	24.33	24.45
GPRS (GMSK, 1-slot)	32.84	32.51	32.09	-9.03	23.81	23.48	23.06
GPRS (GMSK, 2-slot)	31.39	31.28	31.44	-6.02	25.37	25.26	25.42
GPRS (GMSK, 3-slot)	30.14	30.41	30.82	-4.26	25.88	26.15	26.56
GPRS (GMSK, 4-slot)	29.84	29.63	29.48	-3.01	26.83	26.62	26.47
EGPRS (GMSK, 1-slot)	31.44	31.46	31.37	-9.03	22.41	22.43	22.34
EGPRS (GMSK, 2-slot)	30.53	30.58	30.82	-6.02	24.51	24.56	24.8
EGPRS (GMSK, 3-slot)	29.49	29.69	29.46	-4.26	25.23	25.43	25.2
EGPRS (GMSK, 4-slot)	28.62	28.46	28.34	-3.01	25.61	25.45	25.33

Note:

- Division Factors
To average the power, the division factor is as follows:
1TX-slot = 1 transmit time slot out of 8 time slots=> conducted power divided by (8/1) => -9.03dB
2TX-slots = 2 transmit time slots out of 8 time slots=> conducted power divided by (8/2) => -6.02dB
3TX-slots = 3 transmit time slots out of 8 time slots=> conducted power divided by (8/3) => -4.26dB
4TX-slots = 4 transmit time slots out of 8 time slots=> conducted power divided by (8/4) => -3.01dB
- According to the conducted power as above, the body measurements are performed with 4Tx slots for 850MHz for GPRS.
- The device do not support power reduction, so power of hotspot activated as the same as hotspot disabled

Band: GSM 1900 Channel Frequency	Measured Power (dBm)			Calculation (dB)	Averaged Power (dBm)		
	512	661	810		512	661	810
	1850.2	1880.0	1909.8		1850.2	1880.0	1909.8
GSM (GMSK, Voice)	30.41	30.39	30.21	-9.03	21.38	21.36	21.18
GPRS (GMSK, 1-slot)	29.45	29.58	29.78	-9.03	20.42	20.55	20.75
GPRS (GMSK, 2-slot)	28.48	28.46	28.36	-6.02	22.46	22.44	22.34
GPRS (GMSK, 3-slot)	27.62	27.19	27.08	-4.26	23.36	22.93	22.82
GPRS (GMSK, 4-slot)	26.09	26.37	26.12	-3.01	23.08	23.36	23.11
EGPRS (GMSK, 1-slot)	29.84	29.46	29.33	-9.03	20.81	20.43	20.3
EGPRS (GMSK, 2-slot)	28.49	28.32	28.46	-6.02	22.47	22.3	22.44
EGPRS (GMSK, 3-slot)	27.31	27.28	27.31	-4.26	23.05	23.02	23.05
EGPRS (GMSK, 4-slot)	26.08	26.42	26.24	-3.01	23.07	23.41	23.23

Note:

- Division Factors
To average the power, the division factor is as follows:
1TX-slot = 1 transmit time slot out of 8 time slots=> conducted power divided by (8/1) => -9.03dB
2TX-slots = 2 transmit time slots out of 8 time slots=> conducted power divided by (8/2) => -6.02dB
3TX-slots = 3 transmit time slots out of 8 time slots=> conducted power divided by (8/3) => -4.26dB
4TX-slots = 4 transmit time slots out of 8 time slots=> conducted power divided by (8/4) => -3.01dB
- According to the conducted power as above, the body measurements are performed with 4Tx slots for 1900MHz for GPRS.
- The device do not support power reduction, so power of hotspot activated as the same as hotspot disabled

Band	WCDMA Band II			WCDMA Band V		
Channel	9262	9400	9538	4132	4182	4233
Frequency	1852.40	1880.00	1907.60	826.40	836.40	846.60
RMC 12.2Kbps	21.86	22.36	21.91	21.34	22.24	21.59
HSDPA Subtest-1	21.85	21.30	21.47	21.14	22.50	22.82
HSDPA Subtest-2	22.98	22.17	22.79	21.43	22.44	21.82
HSDPA Subtest-3	21.80	22.04	21.24	21.75	21.52	21.40
HSDPA Subtest-4	21.19	21.73	21.55	21.85	21.13	22.77
HSUPA Subtest-1	21.74	22.31	21.55	21.33	21.79	22.48
HSUPA Subtest-2	21.77	21.85	21.13	22.39	21.83	22.60
HSUPA Subtest-3	22.70	22.58	22.13	22.81	22.92	22.34
HSUPA Subtest-4	21.47	21.84	22.09	21.77	21.77	21.42
HSUPA Subtest-5	21.29	22.45	22.09	21.90	22.49	21.35

Note:

1. According to the power listed above, the HSDPA and HSUPA were not determined for SAR testing.
2. The default test configuration is to measure SAR with an established radio link between the EUT and a communication test set using a 12.2kbps RMC(reference measurement channel) configuration in test loop mode
3. The device do not support power reduction, so power of hotspot activated as the same as hotspot disabled

WLAN 2.4G						
Mode	802.11b			802.11g		
Channel	1	6	11	1	6	11
Frequency	2412	2437	2462	2412	2437	2462
Average Power (dBm)	15.46	16.21	16.12	13.04	15.09	15.27
Mode	802.11n(HT20)			802.11n(HT40)		
Channel	1	6	11	3	6	9
Frequency	2412	2437	2462	2422	2437	2452
Average Power (dBm)	13.77	15.10	15.39	14.67	14.77	15.36

Note

1. Per KDB 248227 D01 v02r02, choose the highest output power channel to test SAR and determine further SAR exclusion.
2. The output power of all data rate were prescan , just the worst case (the lowest data rate) of all mode were shown in report

Bluetooth						
Mode	GFSK			Pi/4DQPSK		
Channel	0	39	78	0	39	78
Frequency	2402	2441	2480	2402	2441	2480
Average Power (dBm)	1.95	0.69	-0.28	1.52	0.29	-0.74
Mode	8DPSK			BLE		
Channel	0	39	78	0	20	39
Frequency	2402	2441	2480	2402	2440	2480
Average Power (dBm)	1.77	0.32	-0.72	1.86	0.74	-0.28

Channel	Frequency (GHz)	Max. Tune-up Power (dBm)	Max. Power (mW)	Test distance (mm)	Result	Exclusion thresholds for 1-g SAR	Exclusion thresholds for 10-g SAR
0	2.402	2.00	1.58	5	0.49	3.0	7.5

Note

- Per KDB 447498 D01v06, the 1-g SAR test exclusion thresholds for 100 MHz to 6 GHz at *test separation distances* ≤ 50 mm are determined by:

$$[(\text{max. power of channel, including tune-up tolerance, mW}) / (\text{min. test separation distance, mm})] \cdot [\sqrt{f(\text{GHz})}] \leq 3.0$$
 for 1-g SAR, where
 ·f(GHz) is the RF channel transmit frequency in GHz
 ·Power and distance are rounded to the nearest mW and mm before calculation
 ·The result is rounded to one decimal place for comparison
- Base on the result of note1, RF exposure evaluation of BT is not required.
- Per KDB 248227 D01 v02r02, choose the highest output power channel to test SAR and determine further SAR exclusion.
- The output power of all data rate were prescan, just the worst case (the lowest data rate) of all mode were shown in report.

9. Exposure Position Consideration

9.1. EUT Antenna Location

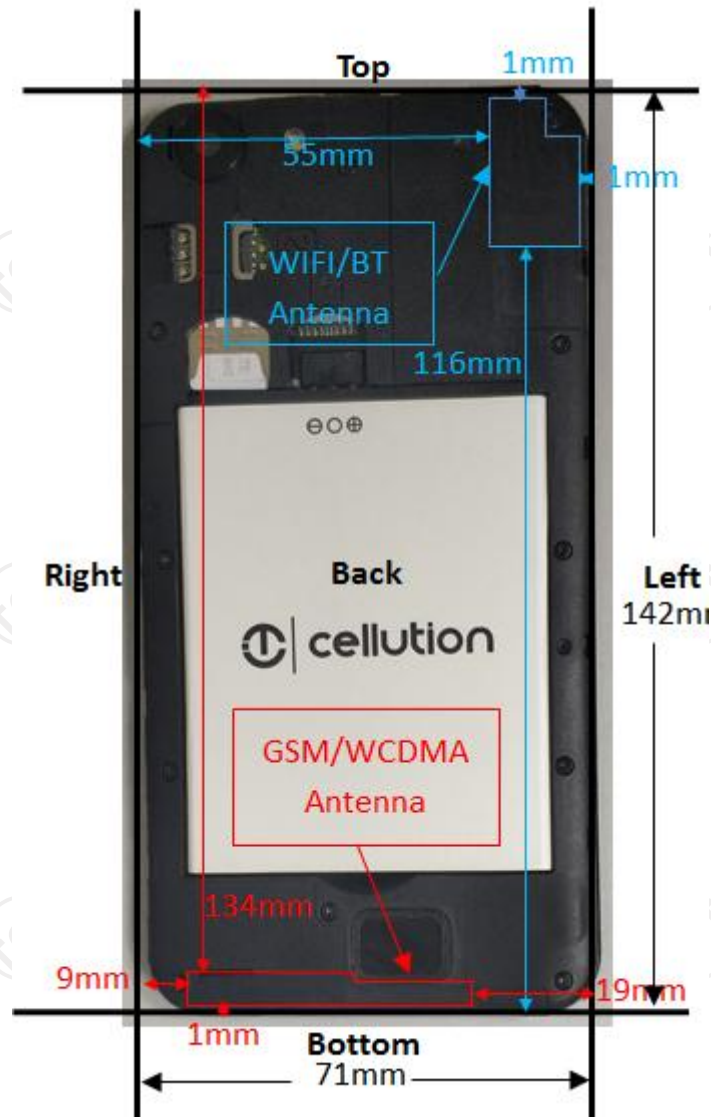

9.2. Test Position Consideration

Test Positions						
Mode	Back	Front	Top Side	Bottom Side	Right Side	Left Side
GSM/WCDMA/CDMA /LTE	Yes	Yes	No	Yes	Yes	Yes
WIFI/BT	Yes	Yes	Yes	No	No	Yes

Note:

1. KDB 447498 D01v06, particular DUT edges were not required to be evaluated for SAR if the antenna-to-edge distance is greater than 2.5cm.

10. SAR Test Results Summary

10.1. Head 1g SAR Data

Band	Mode	Test Position	CH.	Freq. (MHz)	Ave. Power (dBm)	Tune-Up Limit (dBm)	Power Drift (%)	Meas. SAR1g (W/kg)	Scaling Factor	Reported SAR1g (W/kg)	Limit (W/Kg)
GSM850	voice	Left Cheek	251	848.8	33.48	33.50	1.12	0.16	1.005	0.16	1.60
		Left Tilt	251	848.8	33.48	33.50	-1.27	0.05	1.005	0.05	
		Right Cheek	251	848.8	33.48	33.50	-3.27	0.13	1.005	0.13	
		Right Tilt	251	848.8	33.48	33.50	-1.08	0.04	1.005	0.04	
GSM1900	voice	Left Cheek	512	1850.2	30.41	30.50	1.96	0.27	1.021	0.28	
		Left Tilt	512	1850.2	30.41	30.50	0.37	0.10	1.021	0.10	
		Right Cheek	512	1850.2	30.41	30.50	-1.05	0.23	1.021	0.23	
		Right Tilt	512	1850.2	30.41	30.50	-1.56	0.08	1.021	0.08	
WCDMA Band II	RMC	Left Cheek	9400	1880	22.36	22.50	0.18	0.05	1.033	0.05	
		Left Tilt	9400	1880	22.36	22.50	0.99	0.02	1.033	0.02	
		Right Cheek	9400	1880	22.36	22.50	0.38	0.04	1.033	0.04	
		Right Tilt	9400	1880	22.36	22.50	-0.76	0.01	1.033	0.01	
WCDMA Band V	RMC	Left Cheek	4182	836.4	22.24	22.50	-1.09	0.14	1.062	0.15	
		Left Tilt	4182	836.4	22.24	22.50	-1.63	0.08	1.062	0.08	
		Right Cheek	4182	836.4	22.24	22.50	1.89	0.09	1.062	0.10	
		Right Tilt	4182	836.4	22.24	22.50	1.80	0.05	1.062	0.05	
2.4G	802.11b	Left Cheek	6	2437	16.21	16.50	-1.62	0.03	1.069	0.03	
		Left Tilt	6	2437	16.21	16.50	0.38	0.02	1.069	0.02	
		Right Cheek	6	2437	16.21	16.50	0.35	0.04	1.069	0.04	
		Right Tilt	6	2437	16.21	16.50	0.72	0.03	1.069	0.03	

10.2. Body-Worn 1g SAR Data

Band	Mode	Test Position with 10mm	CH.	Freq. (MHz)	Ave. Power (dBm)	Tune-Up Limit (dBm)	Power Drift (%)	Meas. SAR1g (W/kg)	Scaling Factor	Reported SAR1g (W/kg)	Limit (W/Kg)
GSM850	voice	Front	251	848.8	33.48	33.50	1.62	0.13	1.005	0.13	1.60
		Back	251	848.8	33.48	33.50	4.28	0.21	1.005	0.21	
	GPRS 4 slots	Front	128	824.2	30.14	30.50	-1.83	0.20	1.086	0.22	
		Back	128	824.2	30.14	30.50	-1.00	0.33	1.086	0.36	
GSM1900	voice	Front	512	1850.2	30.41	30.50	3.26	0.28	1.021	0.29	
		Back	512	1850.2	30.41	30.50	4.70	0.36	1.021	0.37	
	GPRS 4 slots	Front	661	1880	26.37	26.50	-1.82	0.45	1.030	0.46	
		Back	661	1880	26.37	26.50	-1.60	0.70	1.030	0.72	
WCDMA Band II	RMC	Front	9400	1880	22.36	22.50	-1.45	0.07	1.033	0.07	
		Back	9400	1880	22.36	22.50	1.05	0.09	1.033	0.09	
WCDMA Band V	RMC	Front	4182	836.4	22.24	22.50	-0.72	0.08	1.062	0.08	
		Back	4182	836.4	22.24	22.50	-0.12	0.15	1.062	0.16	
2.4G	802.11b	Front	6	2437	16.21	16.50	0.92	0.04	1.069	0.04	
		Back	6	2437	16.21	16.50	-2.58	0.07	1.069	0.07	

Note:

- Per KDB 447498 D01 v06, for each exposure position, if the highest output power channel Reported SAR $\leq 0.8W/kg$, other channels SAR testing is not necessary.
- Per KDB 447498 D01 v06, body-worn use is evaluated with the device positioned at 10 mm from a flat phantom filled with head tissue-equivalent medium.
- Per KDB 447498 D01 v06, the report SAR is measured SAR value adjusted for maximum tune-up tolerance. Scaling Factor = $10^{[(\text{tune-up limit power (dBm)} - \text{Ave. power power (dBm)})/10]}$, where tune-up limit is the maximum rated power among all production units.
Reported SAR(W/kg) = Measured SAR (W/kg) * Scaling Factor.
- Per KDB865664D01 v01r04 perform a second repeated measurement only the ratio of largest to smallest SAR for the original and first repeated measurement is >1.20 or when the original or repeated measurement is $\geq 1.45W/kg$.
- Perform a second measurement only if the original, first and second repeated measurement is $\geq 1.5w/kg$ and the ratio of largest to smallest SAR for the original, first and second repeated measurement is >1.20 .

10.3. Hotspot 1g SAR Data

Band	Mode	Test Position with10mm	CH.	Freq. (MHz)	Ave. Power (dBm)	Tune-Up Limit (dBm)	Power Drift (%)	Meas. SAR1g (W/kg)	Scaling Factor	Reported SAR1g (W/kg)	Limit (W/Kg)
GSM850	GPRS 4 slots	Front	128	824.2	30.14	30.50	-1.08	0.22	1.086	0.24	1.60
		Back	128	824.2	30.14	30.50	-4.82	0.35	1.086	0.38	
		Right	128	824.2	30.14	30.50	-1.82	0.05	1.086	0.05	
		Left	128	824.2	30.14	30.50	0.95	0.07	1.086	0.08	
		Bottom	128	824.2	30.14	30.50	0.49	0.08	1.086	0.09	
GSM1900	GPRS 4 slots	Front	661	1880	26.37	26.50	-0.18	0.48	1.030	0.49	
		Back	661	1880	26.37	26.50	-2.12	0.74	1.030	0.76	
		Right	661	1880	26.37	26.50	-3.07	0.13	1.030	0.13	
		Left	661	1880	26.37	26.50	0.36	0.20	1.030	0.21	
		Bottom	661	1880	26.37	26.50	-2.79	0.42	1.030	0.43	
UMTS Band II	RMC	Front	9400	1880	22.36	22.50	-4.60	0.09	1.033	0.09	
		Back	9400	1880	22.36	22.50	-4.05	0.11	1.033	0.11	
		Right	9400	1880	22.36	22.50	-2.56	0.03	1.033	0.03	
		Left	9400	1880	22.36	22.50	3.97	0.01	1.033	0.01	
		Bottom	9400	1880	22.36	22.50	-2.21	0.09	1.033	0.09	
UMTS Band V	RMC	Front	4182	836.4	22.24	22.50	-3.26	0.09	1.062	0.10	
		Back	4182	836.4	22.24	22.50	0.04	0.16	1.062	0.17	
		Right	4182	836.4	22.24	22.50	0.17	0.04	1.062	0.04	
		Left	4182	836.4	22.24	22.50	-2.00	0.06	1.062	0.06	
		Bottom	4182	836.4	22.24	22.50	-1.32	0.05	1.062	0.05	

2.4G	802.11b	Front	6	2437	16.21	16.50	-3.82	0.05	1.069	0.05
		Back	6	2437	16.21	16.50	-3.33	0.08	1.069	0.09
		Left	6	2437	16.21	16.50	0.62	0.03	1.069	0.03
		Top	6	2437	16.21	16.50	1.15	0.02	1.069	0.02

Note:

- Per KDB 447498 D01 v06, for each exposure position, if the highest output power channel Reported SAR $\leq 0.8W/kg$, other channels SAR testing is not necessary.
- Per KDB 447498 D01 v06, body-worn with hotspot use is evaluated with the device positioned at 10 mm from a flat phantom filled with head tissue-equivalent medium.
- Per KDB 447498 D01 v06, the report SAR is measured SAR value adjusted for maximum tune-up tolerance. Scaling Factor = $10^{[(\text{tune-up limit power(dBm)} - \text{Ave. power (dBm)})/10]}$, where tune-up limit is the maximum rated power among all production units.
Reported SAR(W/kg) = Measured SAR (W/kg) * Scaling Factor.
- Per KDB865664D01 v01r04 perform a second repeated measurement only the ratio of largest to smallest SAR for the original and first repeated measurement is >1.20 or when the original or repeated measurement is $\geq 1.45W/kg$.
- Perform a second measurement only if the original, first and second repeated measurement is $\geq 1.5w/kg$ and the ratio of largest to smallest SAR for the original, first and second repeated measurement is >1.20 .

10.4. Simultaneous Transmission Conclusion

Multi-Band Simultaneous Transmission Considerations

According to FCC KDB Publication 447498 D01v05r02, transmitters are considered to be transmitting simultaneously when there is overlapping transmission, with the exception of transmissions during network hand-offs with maximum hand-off duration less than 30 seconds. Possible transmission paths for the EUT are shown in below Figure and are color-coded to indicate communication modes which share the same path. Modes which share the same transmission path cannot transmit simultaneously with one another.



Simultaneous Transmission Procedures

This device contains transmitters that may operate simultaneously. Therefore simultaneous transmission analysis is required. Per FCC KDB 447498 D01v05r02, simultaneous transmission SAR test exclusion may be applied when the sum of the 1-g SAR for all the simultaneous transmitting antennas in a specific a physical test configuration is ≤ 1.6 W/kg. When standalone SAR is not required to be measured, per FCC KDB 447498 D01v05r02 4.3.2.2), the following equation must be used to estimate the standalone 1g SAR and 10g extremity SAR for simultaneous transmission assessment involving that transmitter.

$$\text{Estimated SAR} = \frac{\sqrt{f(\text{GHz})}}{7.5(18.75)} \cdot \frac{\text{Max. power of channel, mW}}{\text{Min. Separation Distance, mm}}$$

Mode	Max. tune-up Power (dBm)	Exposure Position	Head	Body -worn
		Test Distance (mm)	5	5
BT	2	Estimated SAR (W/kg)	0.07	0.07

Note:

1. When the minimum *test separation distance* is < 5 mm, a distance of 5 mm according is applied to determine estimated SAR.
2. $(\text{max. power of channel, including tune-up tolerance, mW}) / (\text{min. test separation distance, mm}) \cdot [\sqrt{f(\text{GHz})} / x]$ W/kg for test separation distances ≤ 50 mm; where $x = 7.5$ for 1-g SAR, and $x = 18.75$ for 10-g SAR.
3. Next to the mouth exposure requires 1-g SAR, and the wrist-worn condition requires 10-g extremity SAR.

Simultaneous Transmission Possibilities

The Simultaneous Transmission Possibilities of this device are as below:

NO.	Configuration	Head	Body-Worn	Hotspot
1	GSM850/1900(Voice)+WIFI(2.4)	YES	YES	NO
2	GPRS 850/1900(DATA)+WIFI(2.4)	NO	YES	YES
3	WCDMA+ WIFI(2.4)	YES	YES	YES
4.	GSM850/1900(Voice)+BT	YES	YES	NO
5.	GPRS/EDGE 850/1900(DATA)+BT	YES	YES	NO
6	WCDMA+ BT	YES	YES	NO

10.5. SAR Simultaneous Transmission Analysis

Band	Test Position	Scaled SAR			Σ SAR (W/kg)	SPLSR	Remark
		Head	WIFI 2.4G	BT			
GSM850 (voice)	Left Cheek	0.16	0.03	0.07	0.23	N/A	N/A
	Left Tilt	0.05	0.02	0.07	0.12	N/A	N/A
	Right Cheek	0.13	0.04	0.07	0.20	N/A	N/A
	Right Tilt	0.04	0.03	0.07	0.11	N/A	N/A
GSM1900 (voice)	Left Cheek	0.28	0.03	0.07	0.35	N/A	N/A
	Left Tilt	0.1	0.02	0.07	0.17	N/A	N/A
	Right Cheek	0.23	0.04	0.07	0.30	N/A	N/A
	Right Tilt	0.08	0.03	0.07	0.15	N/A	N/A
WCDMA Band II	Left Cheek	0.05	0.03	0.07	0.12	N/A	N/A
	Left Tilt	0.02	0.02	0.07	0.09	N/A	N/A
	Right Cheek	0.04	0.04	0.07	0.11	N/A	N/A
	Right Tilt	0.01	0.03	0.07	0.08	N/A	N/A
WCDMA Band V	Left Cheek	0.15	0.03	0.07	0.22	N/A	N/A
	Left Tilt	0.08	0.02	0.07	0.15	N/A	N/A
	Right Cheek	0.1	0.04	0.07	0.17	N/A	N/A
	Right Tilt	0.05	0.03	0.07	0.12	N/A	N/A

Band	Test Position	Scaled SAR			Σ SAR (W/kg)	SPLSR	Remark
		Body-Worn	WIFI 2.4G	BT			
GSM850 (voice)	Front	0.13	0.04	0.07	0.20	N/A	N/A
	Back	0.21	0.07	0.07	0.28	N/A	N/A
GSM850 (GPRS 4slot)	Front	0.22	0.04	0.07	0.29	N/A	N/A
	Back	0.36	0.07	0.07	0.43	N/A	N/A
GSM1900 (voice)	Front	0.29	0.04	0.07	0.36	N/A	N/A
	Back	0.37	0.07	0.07	0.44	N/A	N/A
GSM1900 (GPRS 4slot)	Front	0.46	0.04	0.07	0.53	N/A	N/A
	Back	0.72	0.07	0.07	0.79	N/A	N/A
WCDMA Band II	Front	0.07	0.04	0.07	0.14	N/A	N/A
	Back	0.09	0.07	0.07	0.16	N/A	N/A
WCDMA Band V	Front	0.08	0.04	0.07	0.15	N/A	N/A
	Back	0.16	0.07	0.07	0.23	N/A	N/A

Band	Test Position	Scaled SAR		Σ SAR (W/kg)	SPLSR	Remark
		Hotspot	WIFI 2.4G			
GSM850 (GPRS)	Front	0.24	0.05	0.29	N/A	N/A
	Back	0.38	0.09	0.47	N/A	N/A
	Right	0.05	/	0.05	N/A	N/A
	Left	0.08	0.03	0.11	N/A	N/A
	Bottom	0.09	/	0.09	N/A	N/A
	Top	/	0.02	0.02	N/A	N/A
GSM1900(GPRS)	Front	0.49	0.05	0.54	N/A	N/A
	Back	0.76	0.09	0.85	N/A	N/A
	Right	0.13	/	0.13	N/A	N/A
	Left	0.21	0.03	0.24	N/A	N/A
	Bottom	0.43	/	0.43	N/A	N/A
	Top	/	0.02	0.02	N/A	N/A
WCDMA Band II	Front	0.09	0.05	0.14	N/A	N/A
	Back	0.11	0.09	0.20	N/A	N/A
	Right	0.03	/	0.03	N/A	N/A
	Left	0.01	0.03	0.04	N/A	N/A
	Bottom	0.09	/	0.09	N/A	N/A
	Top	/	0.02	0.02	N/A	N/A
WCDMA Band V	Front	0.1	0.05	0.15	N/A	N/A
	Back	0.17	0.09	0.26	N/A	N/A
	Right	0.04	/	0.04	N/A	N/A
	Left	0.06	0.03	0.09	N/A	N/A
	Bottom	0.05	/	0.05	N/A	N/A
	Top	/	0.02	0.02	N/A	N/A

Simultaneous Transmission Conclusion

The above numerical summed SAR results for all the case simultaneous transmission conditions were below the SAR limit. Therefore, the above analysis is sufficient to determine that simultaneous transmission cases will not exceed the SAR limit and therefore measured volumetric simultaneous SAR summation is not required per FCC KDB Publication 447498 D01v05r02.

10.6. Measurement Uncertainty (450MHz-3GHz)

UNCERTAINTY EVALUATION FOR HEADSET SAR

Uncertainty Component	Description	Uncertainty Value(%)	Probably Distribution	Div.	(Ci) 1g	(Ci) 10g	Std. Unc. 1g(%)	Std. Unc. 10g(%)	v
Measurement system									
Probe calibration	7.2.1	5.8	N	1	1	1	5.8	5.8	∞
Axial isotropy	7.2.1.1	3.5	R	$\sqrt{3}$	$(1-C_p)^{1/2}$	$(1-C_p)^{1/2}$	1.43	1.43	∞
Hemispherical isotropy	7.2.1.1	5.9	R	$\sqrt{3}$	$\sqrt{C_p}$	$\sqrt{C_p}$	2.41	2.41	∞
Boundary Effects	7.2.1.4	1.00	R	$\sqrt{3}$	1	1	0.58	0.58	∞
Linearity	7.2.1.2	4.70	R	$\sqrt{3}$	1	1	2.71	2.71	∞
System detection limits	7.2.1.2	1	R	$\sqrt{3}$	1	1	0.58	0.58	∞
Modulation Response	7.2.1.3	3	N	1	1	1	3.00	3.00	∞
Readout Electronics	7.2.1.5	0.5	N	1	1	1	0.50	0.50	∞
Response Time	7.2.1.6	0	R	$\sqrt{3}$	1	1	0.00	0.00	∞
Integration Time	7.2.1.7	1.4	R	$\sqrt{3}$	1	1	0.81	0.81	∞
RF Ambient Conditions-Noise	7.2.3.7	3	R	$\sqrt{3}$	1	1	1.73	1.73	∞
RF Ambient Conditions-Reflection	7.2.3.7	3	R	$\sqrt{3}$	1	1	1.73	1.73	∞
Probe positioned mechanical Tolerance	7.2.2.1	1.4	R	$\sqrt{3}$	1	1	0.81	0.81	∞
Probe positioning with respect to phantom shell	7.2.2.3	1.4	R	$\sqrt{3}$	1	1	0.81	0.81	∞
Extrapolation interpolation and integration algorithms for Max.SAR evaluation	7.2.4	2.3	R	1	1	1	1.33	1.33	∞
Test sample related									
Test sample positioning	7.2.2.4.4	2.6	N	1	1	1	2.60	2.60	∞
Device holder uncertainty	7.2.2.4.2 7.2.2.4.3	3	N	1	1	1	3.00	3.00	∞
output power variation-SAR drift measurement	7.2.3.6	5	R	$\sqrt{3}$	1	1	2.89	2.89	∞
SAR scaling	7.2.5	2	R	$\sqrt{3}$	1	1	1.15	1.15	∞
Phantom and tissue parameters									
Phantom uncertainty (shape and thickness tolerances)	7.2.2.2	4	R	$\sqrt{3}$	1	1	2.31	2.31	∞
uncertainty in SAR correction for deviation (in permittivity and conductivity)	7.2.6	2	N	1	1	0.84	2.00	1.68	∞
Liquid conductivity (temperature uncertainty)	7.2.3.5	2.5	N	1	0.78	0.71	1.95	1.78	∞
Liquid conductivity -measurement uncertainty	7.2.3.3	4	N	1	0.23	0.26	0.92	1.04	∞
Liquid permittivity (temperature uncertainty)	7.2.3.5	2.5	N	1	0.78	0.71	1.95	1.78	∞
Liquid permittivity measurement uncertainty	7.2.3.4	5	N	1	0.23	0.26	1.15	1.30	∞
Combined standard uncertainty			RSS				10.83	10.54	
Expanded uncertainty (95%CONFIDENCEINTERVAL)			k				21.26	21.08	

UNCERTAINTY FOR PERFORMANCE CHECK

Uncertainty Component	Description	Uncertainty Value(%)	Probably Distribution	Div.	(Ci) 1g	(Ci) 10g	Std. Unc. 1g(%)	Std. Unc. 10g(%)	v
Measurement system									
Probe calibration	7.2.1	5.8	N	1	1	1	5.8	5.8	∞
Axial isotropy	7.2.1.1	3.5	R	$\sqrt{3}$	$(1-C_p)^{1/2}$	$(1-C_p)^{1/2}$	1.43	1.43	∞
Hemispherical isotropy	7.2.1.1	5.9	R	$\sqrt{3}$	$\sqrt{C_p}$	$\sqrt{C_p}$	2.41	2.41	∞
Boundary Effects	7.2.1.4	1.00	R	$\sqrt{3}$	1	1	0.58	0.58	∞
Linearity	7.2.1.2	4.70	R	$\sqrt{3}$	1	1	2.71	2.71	∞
System detection limits	7.2.1.2	1	R	$\sqrt{3}$	1	1	0.58	0.58	∞
Modulation Response	7.2.1.3	3	N	1	1	1	0.00	0.00	∞
Readout Electronics	7.2.1.5	0.5	N	1	1	1	0.50	0.50	∞
Response Time	7.2.1.6	0	R	$\sqrt{3}$	1	1	0.00	0.00	∞
Integration Time	7.2.1.7	1.4	R	$\sqrt{3}$	1	1	0.81	0.81	∞
RF Ambient Conditions-Noise	7.2.3.7	3	R	$\sqrt{3}$	1	1	1.73	1.73	∞
RF Ambient Conditions-Reflection	7.2.3.7	3	R	$\sqrt{3}$	1	1	1.73	1.73	∞
Probe positioned mechanical Tolerance	7.2.2.1	1.4	R	$\sqrt{3}$	1	1	0.81	0.81	∞
Probe positioning with respect to phantom shell	7.2.2.3	1.4	R	$\sqrt{3}$	1	1	0.81	0.81	∞
Extrapolation interpolation and integration algorithms for Max.SAR evaluation	7.2.4	2.3	R	1	1	1	1.33	1.33	∞
Dipole									
Deviation of experimental source from numerical source		4	N	1	1	1	4.00	4.00	∞
Input power and SAR drift measurement	7.2.3.6	5	R	$\sqrt{3}$	1	1	2.89	2.89	∞
Dipole axis to liquid distance		2	R	$\sqrt{3}$	1	1			∞
Phantom and tissue parameters									
Phantom uncertainty (shape and thickness tolerances)	7.2.2.2	4	R	$\sqrt{3}$	1	1	2.31	2.31	∞
uncertainty in SAR correction for deviation (in permittivity and conductivity)	7.2.6	2	N	1	1	0.84	2.00	1.68	∞
Liquid conductivity (temperature uncertainty)	7.2.3.5	2.5	N	1	0.78	0.71	1.95	1.78	∞
Liquid conductivity -measurement uncertainty	7.2.3.3	4	N	1	0.23	0.26	0.92	1.04	∞
Liquid permittivity (temperature uncertainty)	7.2.3.5	2.5	N	1	0.78	0.71	1.95	1.78	∞
Liquid permittivity measurement uncertainty	7.2.3.4	5	N	1	0.23	0.26	1.15	1.30	∞
Combined standard uncertainty			RSS				10.15	10.05	
Expanded uncertainty (95%CONFIDENCEINTERVAL)			k				20.29	20.10	

10.7. Test Equipment List

Test Equipment	Manufacturer	Model	Serial Number	Calibration	
				Calibration Date (D.M.Y)	Calibration Due (D.M.Y)
PC	Lenovo	H3050	N/A	N/A	N/A
Signal Generator	Angilent	N5182A	MY47070282	Sep. 28, 2019	Sep. 27, 2020
Multimeter	Keithley	Multimeter 2000	4078275	Sep. 28, 2019	Sep. 27, 2020
Network Analyzer	Agilent	8753E	US38432457	Sep. 28, 2019	Sep. 27, 2020
Wireless Communication Test Set	R & S	CMU200	111382	Sep. 28, 2019	Sep. 27, 2020
Wideband Radio Communication Tester	R&S	CMW500	114220	Sep. 28, 2019	Sep. 27, 2020
Power Meter	Agilent	E4418B	GB43312526	Sep. 28, 2019	Sep. 27, 2020
Power Meter	Agilent	E4416A	MY45101555	Sep. 28, 2019	Sep. 27, 2020
Power Meter	Agilent	N1912A	MY50001018	Sep. 28, 2019	Sep. 27, 2020
Power Sensor	Agilent	E9301A	MY41497725	Sep. 28, 2019	Sep. 27, 2020
Power Sensor	Agilent	E9327A	MY44421198	Sep. 28, 2019	Sep. 27, 2020
Power Sensor	Agilent	E9323A	MY53070005	Sep. 28, 2019	Sep. 27, 2020
Power Amplifier	PE	PE15A4019	112342	N/A	N/A
Directional Coupler	Agilent	722D	MY52180104	N/A	N/A
Attenuator	Chensheng	FF779	134251	N/A	N/A
E-Field PROBE	MVG	SSE2	SN 41/18 EP248	Aug. 29, 2019	Aug. 28, 2020
DIPOLE 835	MVG	SID835	SN 16/15 DIP 0G835-369	Jun. 05, 2018	Jun. 04, 2021
DIPOLE 1800	MVG	SID 1800	SN 16/15 DIP 1G800-371	Jun. 05, 2018	Jun. 04, 2021
DIPOLE 1900	MVG	SID1900	SN 16/15 DIP 1G900-372	Jun. 05, 2018	Jun. 04, 2021
DIPOLE 2450	MVG	SID 2450	SN 16/15 DIP 2G450-374	Jun. 05, 2018	Jun. 04, 2021
Limesar Dielectric Probe	MVG	SCLMP	SN 19/15 OCPG71	Jun. 05, 2018	Jun. 04, 2021
Communication Antenna	MVG	ANTA59	SN 39/14 ANTA59	N/A	N/A
Mobile Phone Position Device	MVG	MSH101	SN 19/15 MSH101	N/A	N/A
Dummy Probe	MVG	DP66	SN 13/15 DP66	N/A	N/A
SAM PHANTOM	MVG	SAM120	SN 19/15 SAM120	N/A	N/A
PHANTOM TABLE	MVG	TABP101	SN 19/15 TABP101	N/A	N/A
Robot TABLE	MVG	TABP61	SN 19/15 TABP61	N/A	N/A
6 AXIS ROBOT	KUKA	KR6-R900	501822	N/A	N/A

- Note:**
1. N/A means this equipment no need to calibrate
 2. Each Time means this device need to calibrate every use time
 3. The dipole was not damaged properly repaired.
 4. The measured SAR deviates from the calibrated SAR value by less than 10%
 5. The most recent return-loss result meets the required 20 dB minimum return-loss requirement
 6. The most recent measurement of the real or imaginary parts of the impedance deviates by less than 5 Ω from the previous measurement.

11. System Check Results

Date of measurement: 03/06/2020 Test mode: 835 (Head)
 Product Description: Validation
 Dipole Model: SID835
 E-Field Probe: SSE2 (SN 41/18 EP331)

Phantom	Validation plane
Input Power	100mW
Crest Factor	1.0
Probe Conversion factor	5.50
Frequency (MHz)	835.000000
Relative permittivity (real part)	41.417760
Relative permittivity (imaginary part)	18.129852
Conductivity (S/m)	0.874923
Variation (%)	-0.090000
SAR 10g (W/Kg)	0.570250
SAR 1g (W/Kg)	0.886135

SURFACE SAR

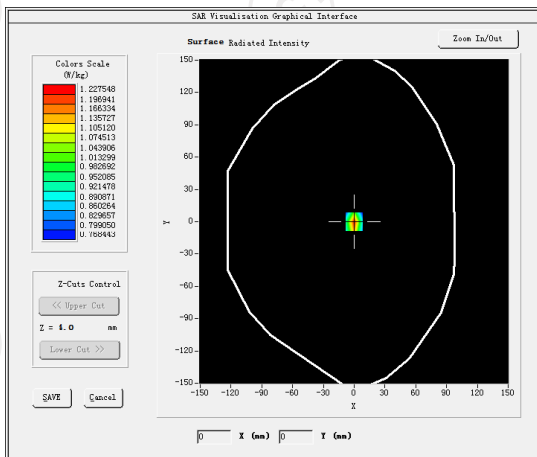

VOLUME SAR

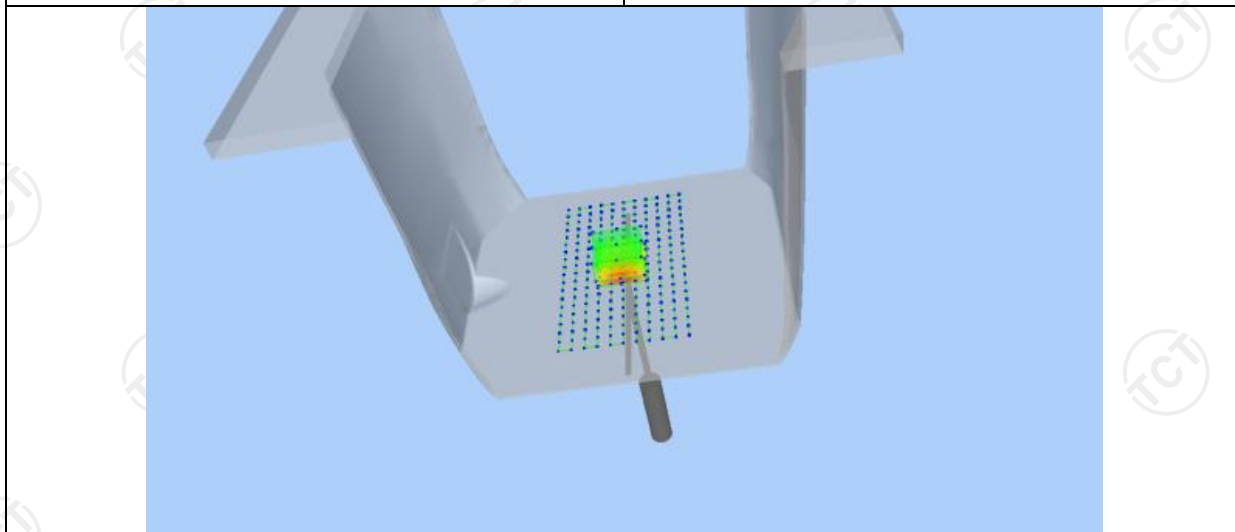
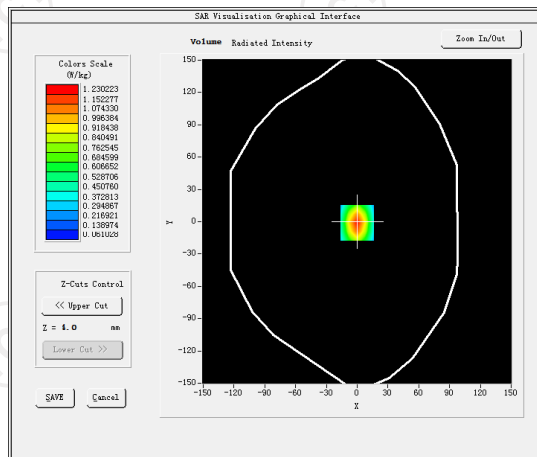

Z (mm)	0.00	4.00	9.00	14.00	19.00
SAR (W/Kg)	0.8625	0.5302	0.2594	0.1302	0.1025

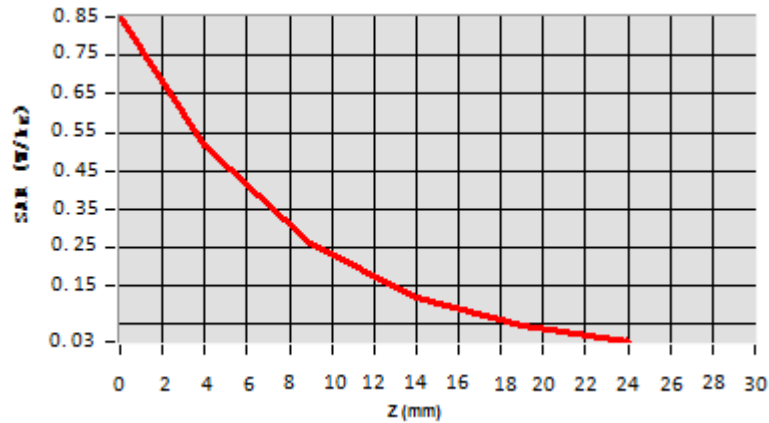

Hot spot position



Date of measurement: 03/06/2020 Test mode: 835 (Body)

Product Description: Validation

Dipole Model: SID835

E-Field Probe: SSE2 (SN 41/18 EP331)

Phantom	Validation plane
Input Power	100mW
Crest Factor	1.0
Probe Conversion factor	5.65
Frequency (MHz)	835.000000
Relative permittivity (real part)	55.242077
Relative permittivity (imaginary part)	21.378187
Conductivity (S/m)	0.938883
Variation (%)	-0.150000
SAR 10g (W/Kg)	0.633123
SAR 1g (W/Kg)	0.949446

SURFACE SAR

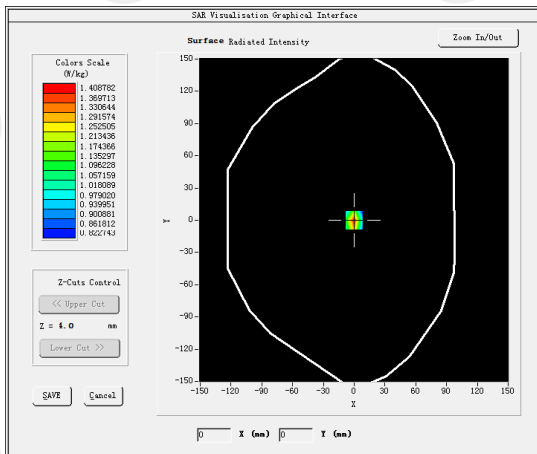

VOLUME SAR

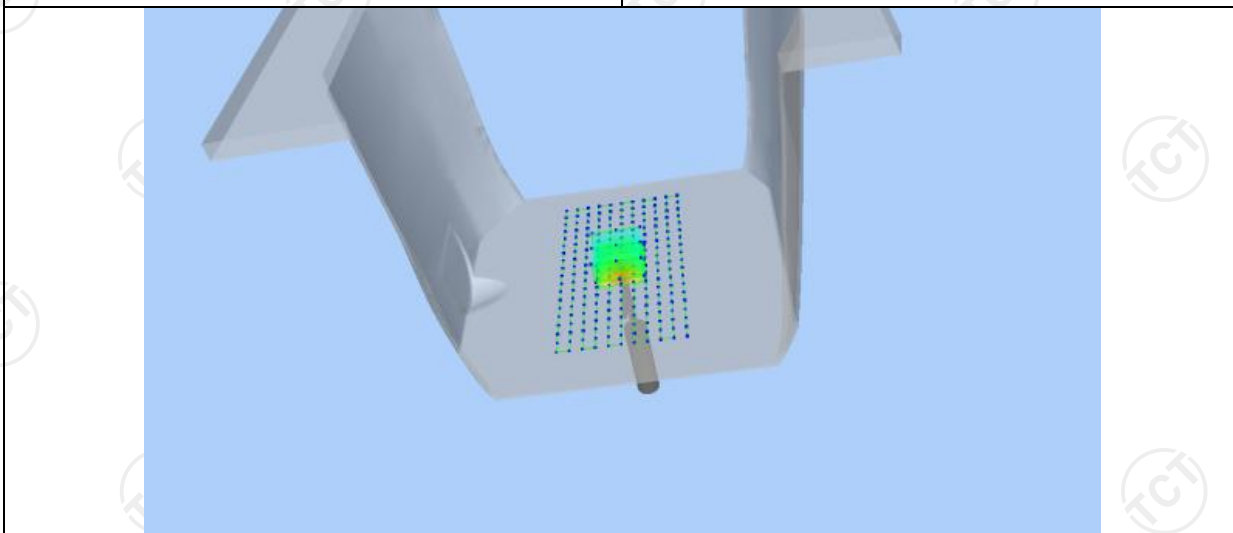
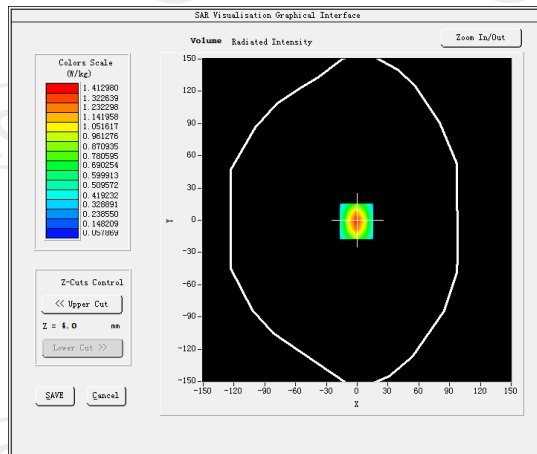

Z (mm)	0.00	4.00	9.00	14.00	19.00
SAR (W/Kg)	0.9625	0.6022	0.3594	0.2202	0.0725

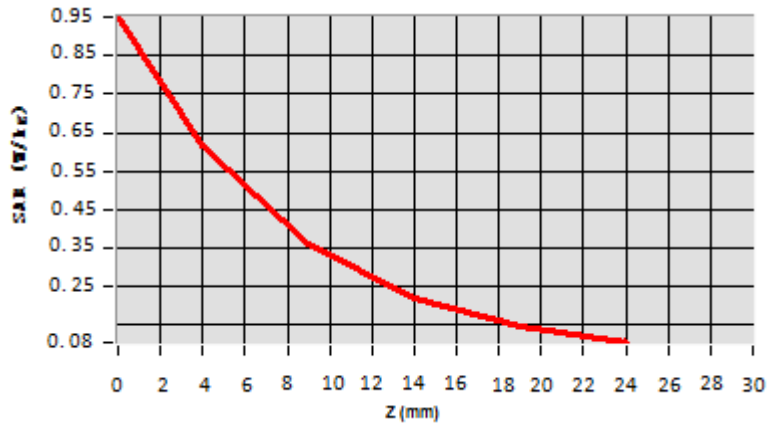

Hot spot position



Date of measurement: 03/10/2020 Test mode: 1900MHz (Head)
Product Description: Validation
Dipole Model: SID1900
E-Field Probe: SSE2 (SN 41/18 EP331)

Phantom	Validation plane
Input Power	100mW
Crest Factor	1.0
Probe Conversion factor	4.85
Frequency (MHz)	1900.000000
Relative permittivity (real part)	39.076721
Relative permittivity (imaginary part)	12.607061
Conductivity (S/m)	1.367609
Variation (%)	-0.910000
SAR 10g (W/Kg)	1.899324
SAR 1g (W/Kg)	3.576354

SURFACE SAR

VOLUME SAR

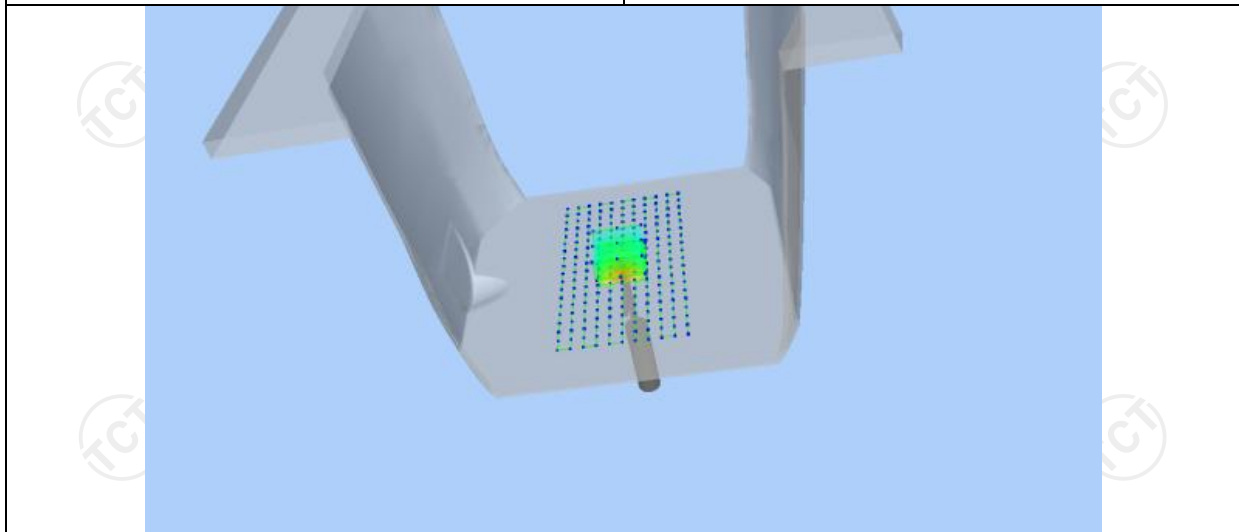
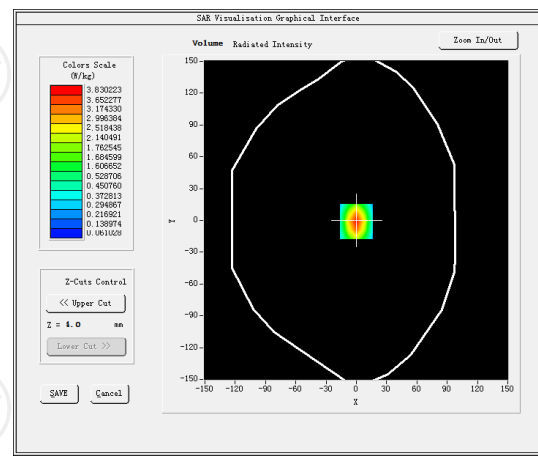
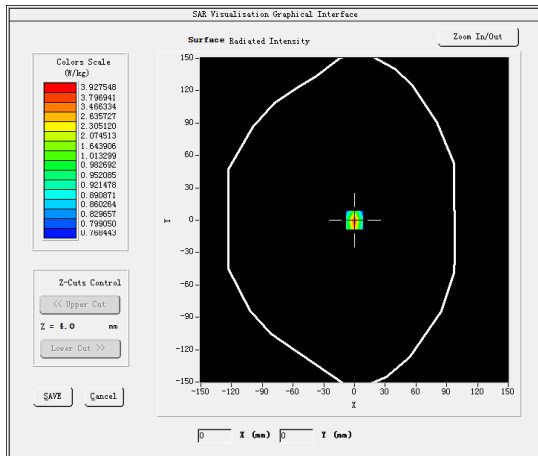

Z (mm)	0.00	4.00	9.00	14.00	19.00
SAR (W/Kg)	3.5325	2.5687	1.7025	1.3025	0.1125

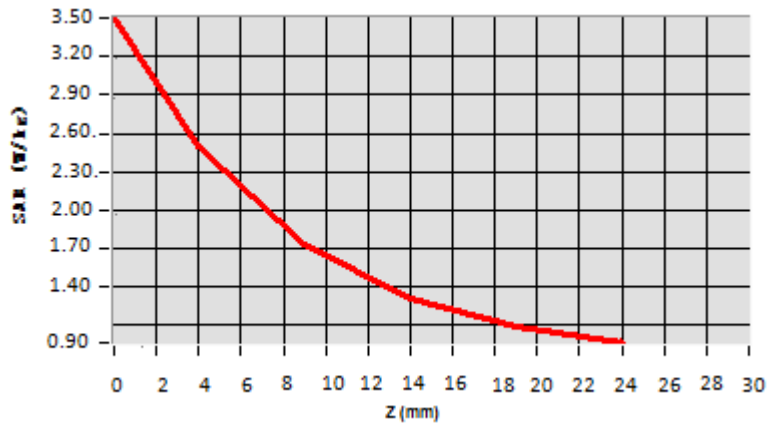

Hot spot position



Date of measurement: 03/10/2020 Test mode: 1900MHz (Body)
Product Description: Validation
Dipole Model: SID1900
E-Field Probe: SSE2 (SN 41/18 EP331)

Phantom	Validation plane
Input Power	100mW
Crest Factor	1.0
Probe Conversion factor	5.01
Frequency (MHz)	1900.000000
Relative permittivity (real part)	53.309999
Relative permittivity (imaginary part)	14.329440
Conductivity (S/m)	1.510354
Variation (%)	1.250000
SAR 10g (W/Kg)	1.994255
SAR 1g (W/Kg)	3.766112

SURFACE SAR

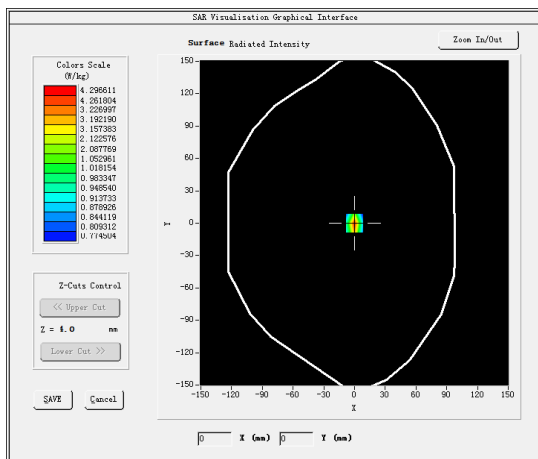

VOLUME SAR

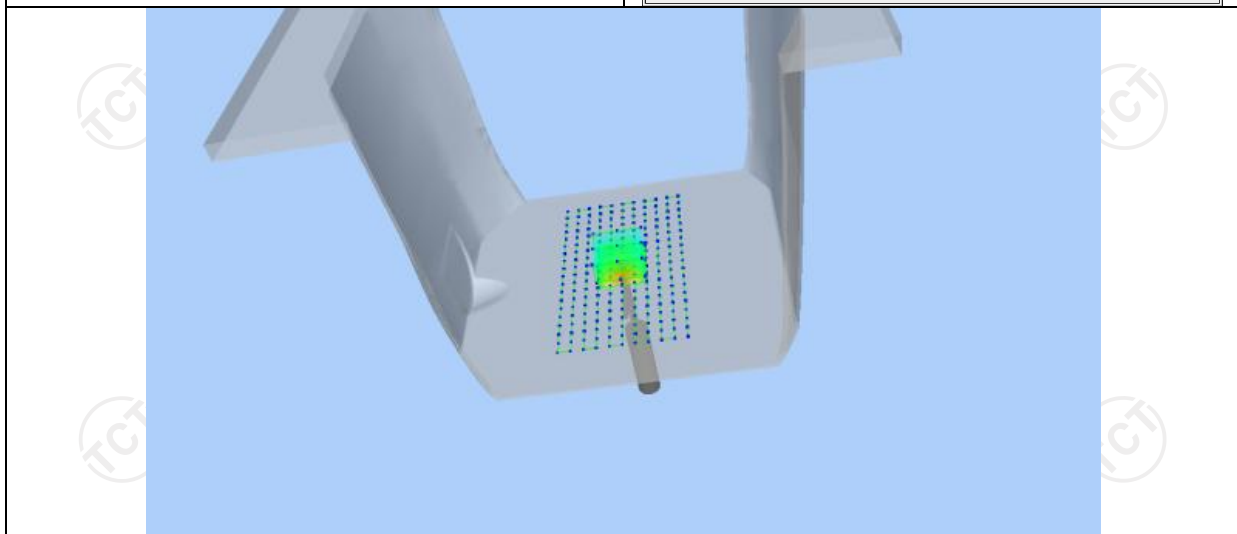
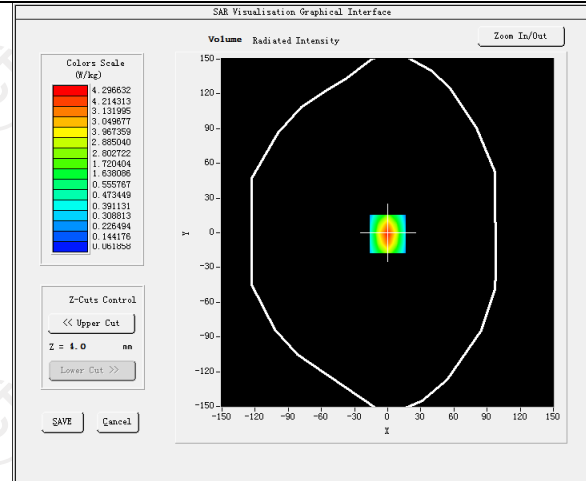

Z (mm)	0.00	4.00	9.00	14.00	19.00
SAR (W/Kg)	3.7752	2.7154	1.9525	1.5694	0.9014

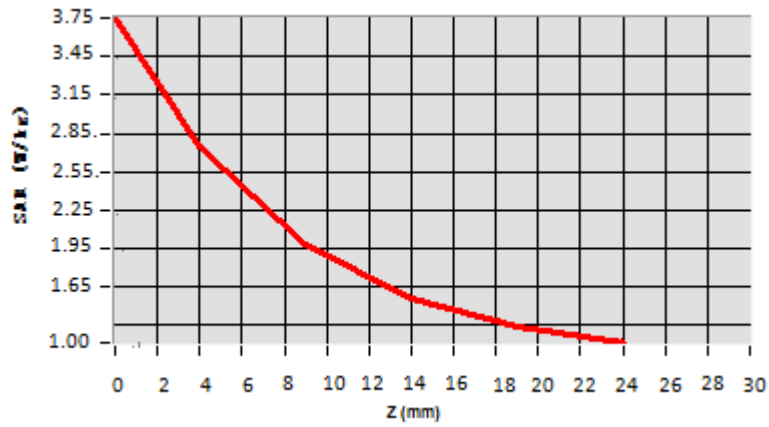

Hot spot position



Date of measurement: 03/15/2020 Test mode: 2450MHz (Head)
 Product Description: Validation
 Dipole Model: SID2450
 E-Field Probe: SSE2 (SN 41/18 EP331)

Phantom	Validation plane
Input Power	100mW
Crest Factor	1.0
Probe Conversion factor	4.58
Frequency (MHz)	2450.000000
Relative permittivity (real part)	37.821613
Relative permittivity (imaginary part)	13.546980
Conductivity (S/m)	1.834111
Variation (%)	-0.470000
SAR 10g (W/Kg)	2.364445
SAR 1g (W/Kg)	4.994244

SURFACE SAR

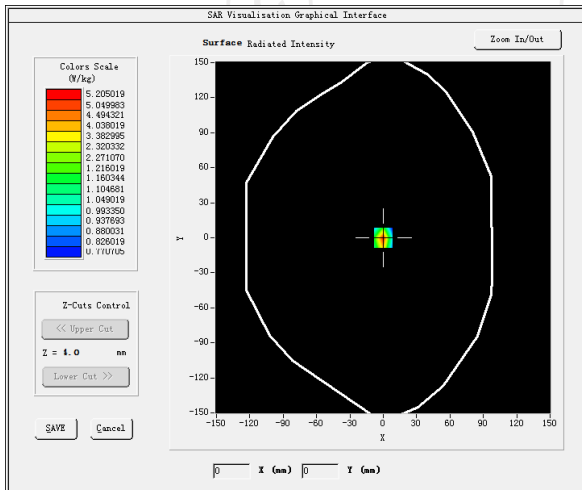

VOLUME SAR

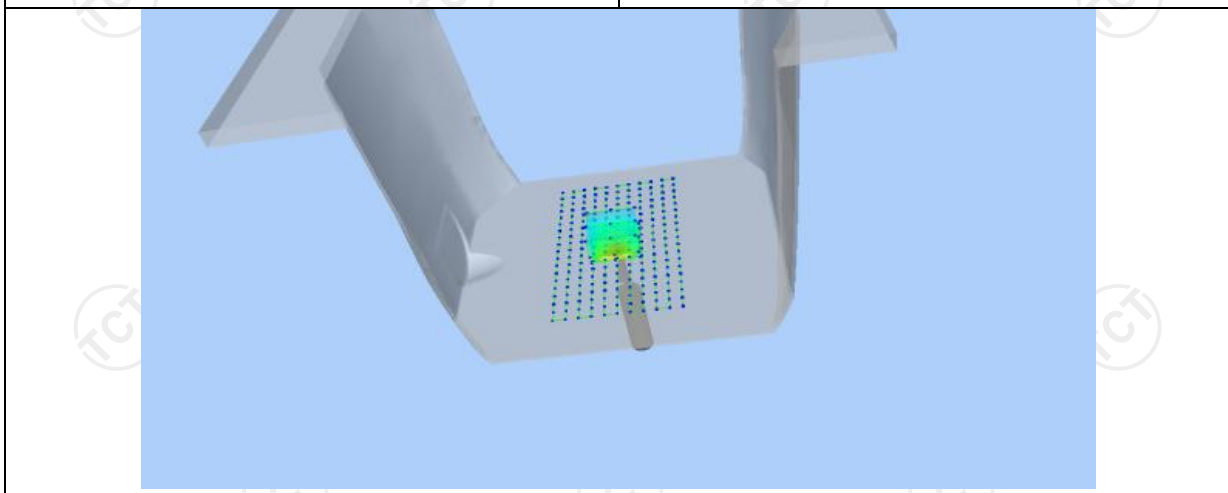
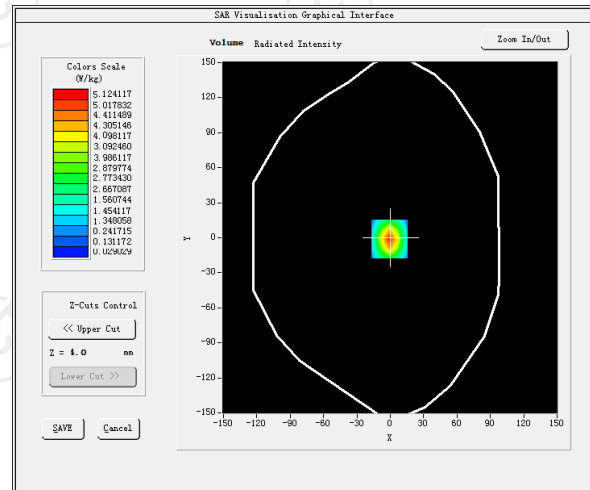

Z (mm)	0.00	4.00	9.00	14.00	19.00
SAR (W/Kg)	5.0262	2.7584	1.5026	0.8252	0.4125

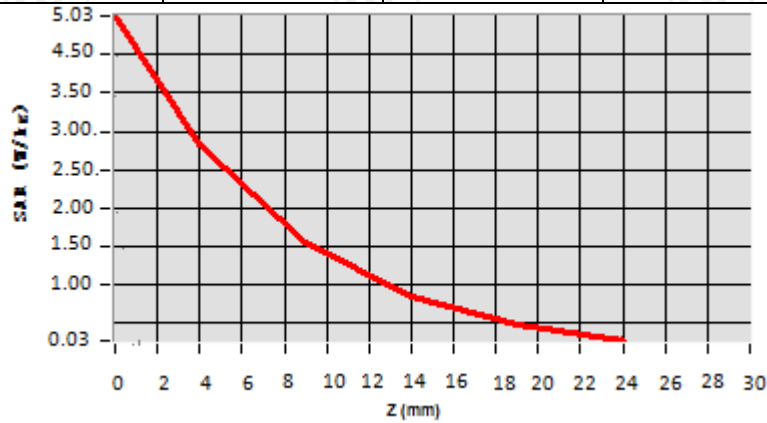

Hot spot position



Date of measurement: 03/15/2020 Test mode: 2450MHz (Body)
 Product Description: Validation
 Dipole Model: SID2450
 E-Field Probe: SSE2 (SN 41/18 EP331)

Phantom	Validation plane
Input Power	100mW
Crest Factor	1.0
Probe Conversion factor	4.70
Frequency (MHz)	2450.000000
Relative permittivity (real part)	54.616199
Relative permittivity (imaginary part)	14.930150
Conductivity (S/m)	2.012159
Variation (%)	-0.230000
SAR 10g (W/Kg)	2.416669
SAR 1g (W/Kg)	5.066368

SURFACE SAR

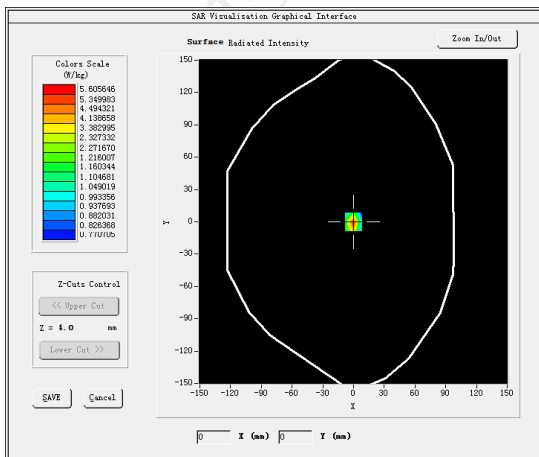

VOLUME SAR

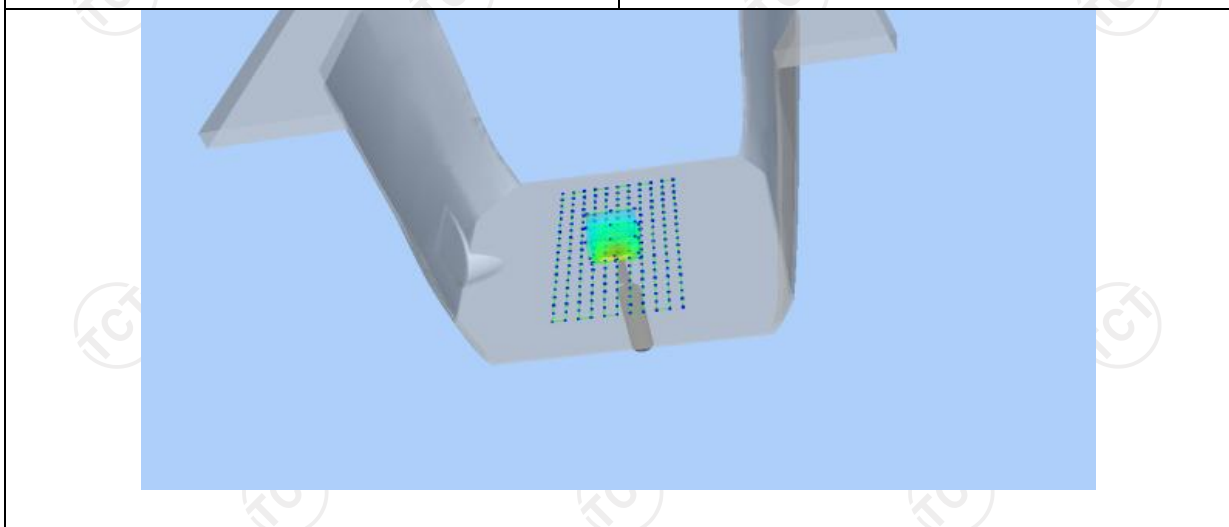
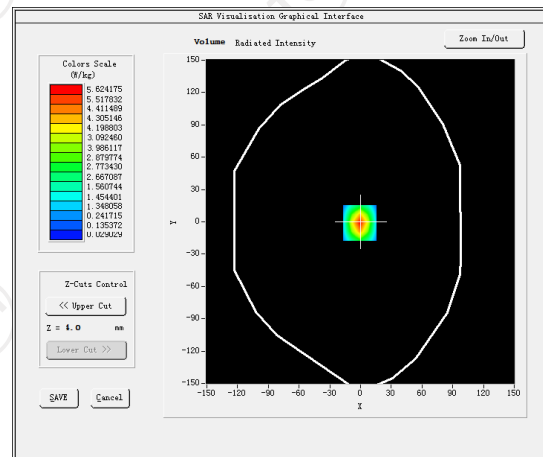

Z (mm)	0.00	4.00	9.00	14.00	19.00
SAR (W/Kg)	5.0622	2.7984	1.5251	0.8352	0.4200

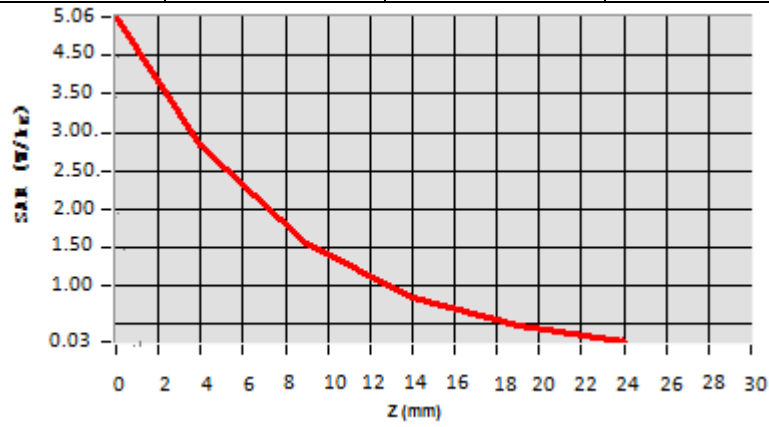

Hot spot position



12. SAR Test Data

GSM850

MEASUREMENT 1

Middle Band SAR (Channel 190)

Date: 03/06/2020

Frequency (MHz)	836.600000
Relative permittivity (real part)	41.422883
Relative permittivity (imaginary part)	18.129634
Conductivity (S/m)	0.867241
Variation (%)	1.120000
Crest Factor:	8.3
Probe Conversion factor	5.50
E-Field Probe:	SSE2 (SN 41/18 EP331)
Area Scan	<u>dx=8mm dy=8mm, h= 5.00 mm</u>
ZoomScan	<u>5x5x7, dx=8mm dy=8mm</u> <u>dz=5mm, Complete/ndx=8mm dy=8mm, h=</u> <u>5.00 mm</u>
Phantom	<u>Left head</u>
Device Position	<u>Cheek</u>
Band	<u>GSM850(voice)</u>

SURFACE SAR

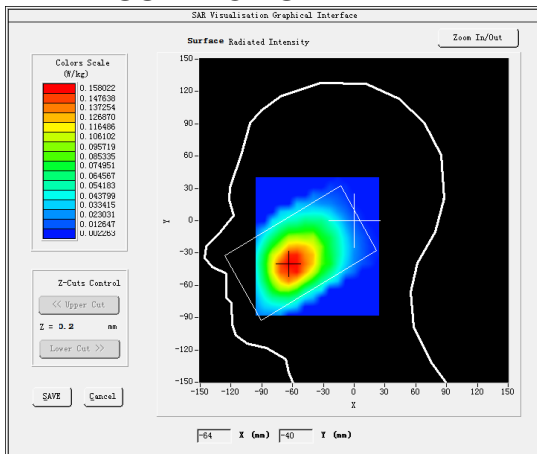

VOLUME SAR

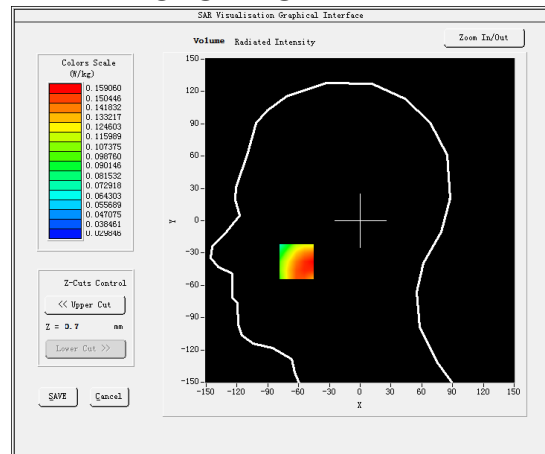

Maximum location: X=-62.00, Y=-38.00 SAR Peak: 0.23 W/kg

SAR 10g (W/Kg)

0.114147

SAR 1g (W/Kg)

0.158403

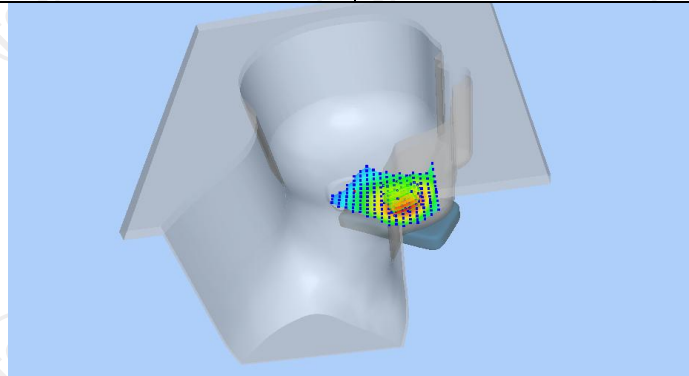

Z (mm)	0.00	4.00	9.00	14.00	19.00
SAR (W/Kg)	0.4107	0.1591	0.0809	0.0739	0.0510

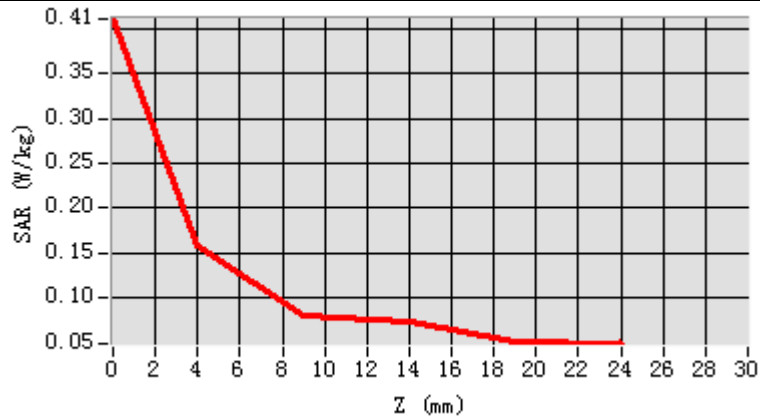

Hot spot position

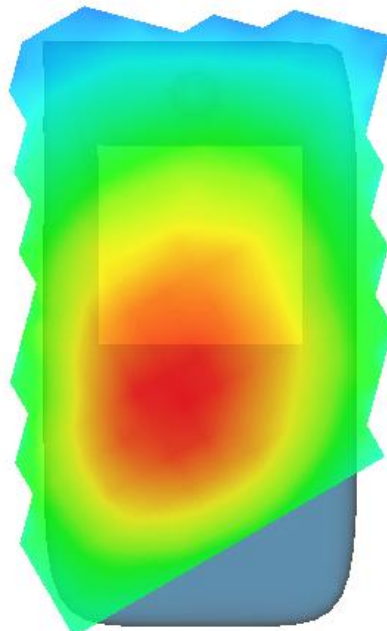

MEASUREMENT 2

Middle Band SAR (Channel 190):

Date: 03/06/2020

Frequency (MHz)	836.600000
Relative permittivity (real part)	55.242927
Relative permittivity (imaginary part)	21.378266
Conductivity (S/m)	0.941230
Variation (%)	4.280000
Crest Factor:	8.3
Probe Conversion factor	5.65
E-Field Probe:	SSE2 (SN 41/18 EP331)
Area Scan	<u>dx=8mm dy=8mm, h= 5.00 mm</u>
ZoomScan	<u>5x5x7, dx=8mm dy=8mm</u> <u>dz=5mm, Complete/ndx=8mm dy=8mm, h=</u> <u>5.00 mm</u>
Phantom	<u>Validation plane</u>
Device Position	<u>Body back(10mm)</u>
Band	<u>GSM850(Voice)</u>

SURFACE SAR

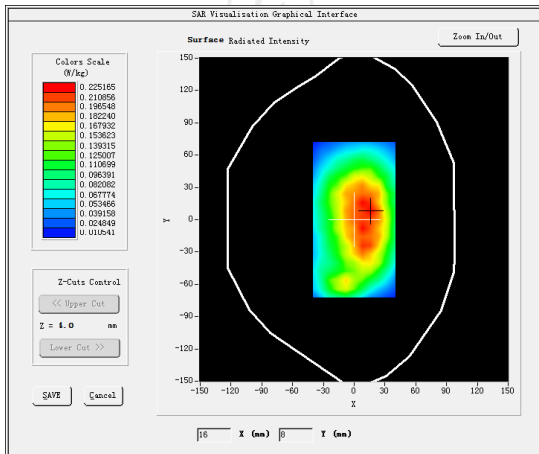

VOLUME SAR

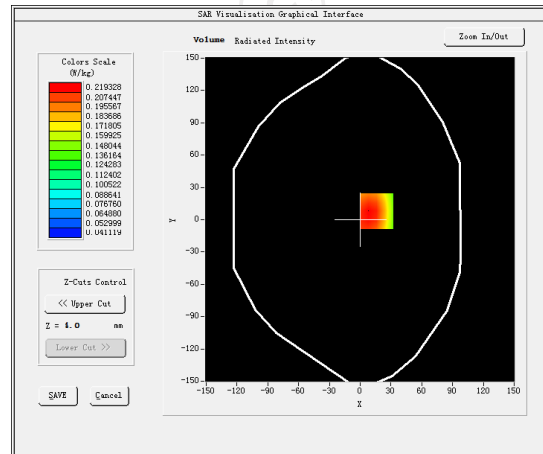

Maximum location: X=16.00, Y=8.00 SAR Peak: 0.28 W/kg

SAR 10g (W/Kg)

0.154734

SAR 1g (W/Kg)

0.212236

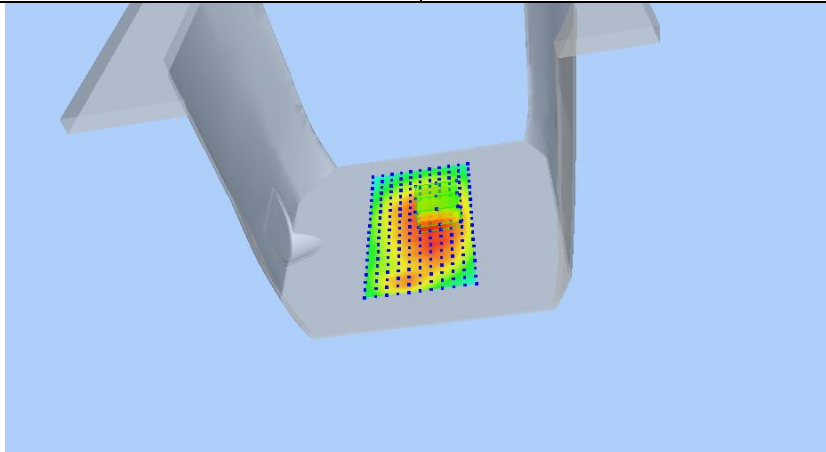

Z (mm)	0.00	4.00	9.00	14.00	19.00
SAR (W/Kg)	0.5080	0.2193	0.1382	0.1248	0.0795

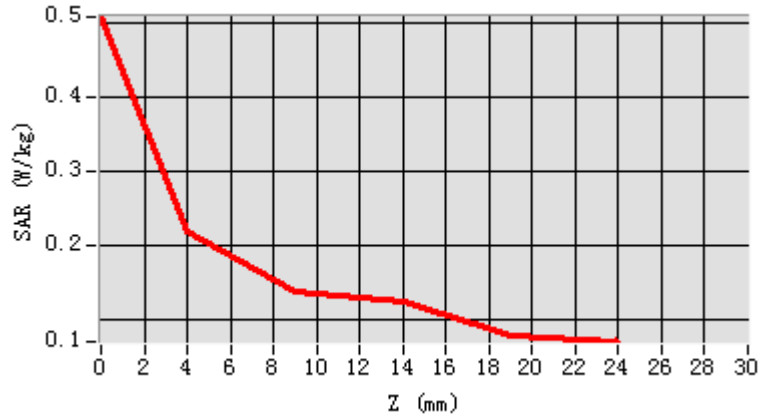

Hot spot position

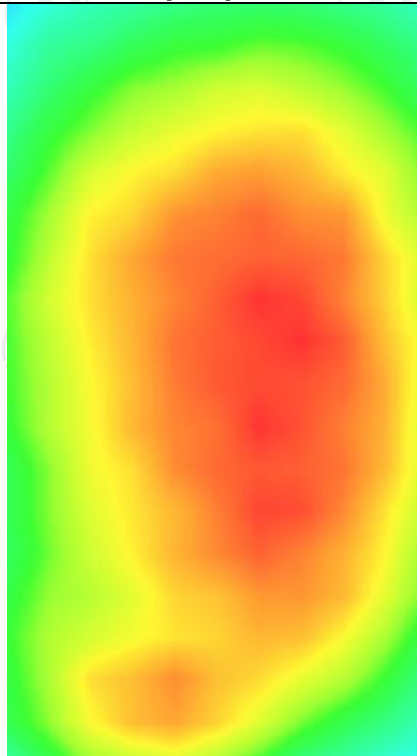

MEASUREMENT 3

Middle Band SAR (Channel 190):

Date: 03/06/2020

Frequency (MHz)	836.600000
Relative permittivity (real part)	55.242927
Relative permittivity (imaginary part)	21.378266
Conductivity (S/m)	0.941230
Variation (%)	-1.000000
Crest Factor:	2.0
Probe Conversion factor	5.65
E-Field Probe:	SSE2 (SN 41/18 EP331)
Area Scan	<u>dx=8mm dy=8mm, h= 5.00 mm</u>
ZoomScan	<u>5x5x7, dx=8mm dy=8mm</u> <u>dz=5mm, Complete/ndx=8mm dy=8mm, h=</u> <u>5.00 mm</u>
Phantom	<u>Validation plane</u>
Device Position	<u>Body back(10mm)</u>
Band	<u>GSM850(GPRS 4slot)</u>

SURFACE SAR

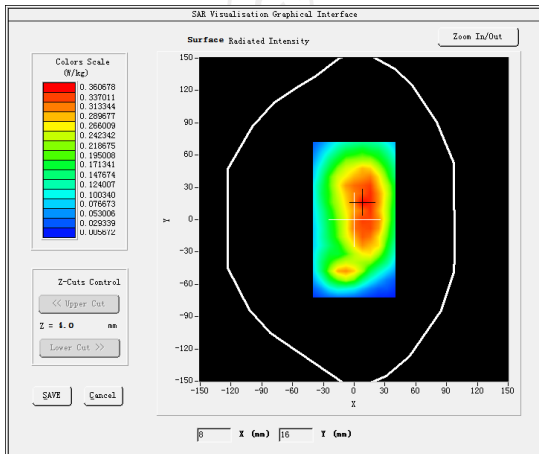

VOLUME SAR

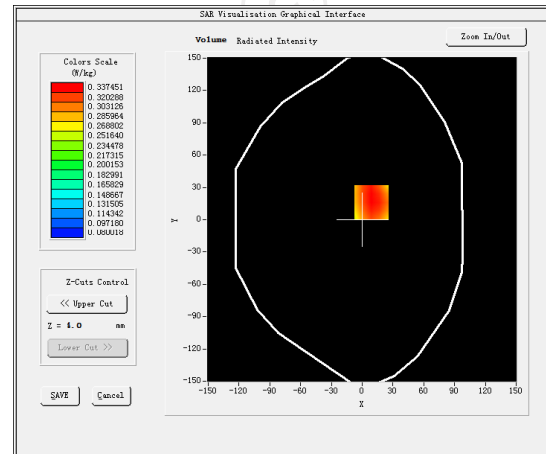

Maximum location: X=9.00, Y=16.00 SAR Peak: 0.43 W/kg

SAR 10g (W/Kg)

0.238369

SAR 1g (W/Kg)

0.327164

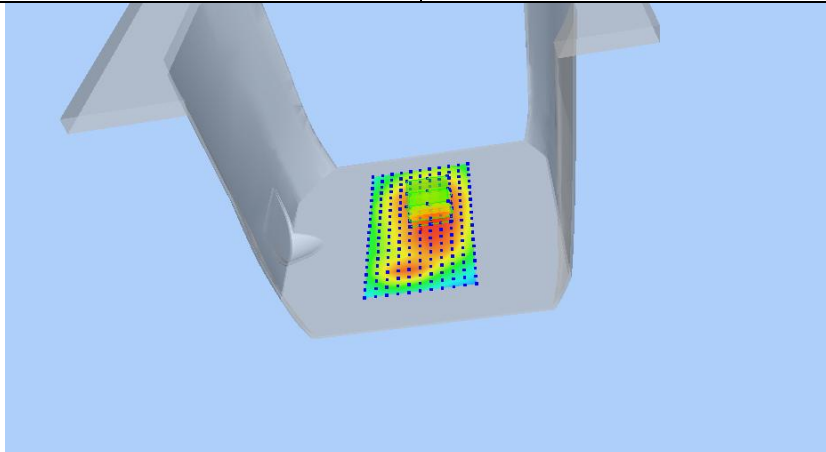

Z (mm)	0.00	4.00	9.00	14.00	19.00
SAR (W/Kg)	0.4264	0.3375	0.2531	0.1930	0.1502

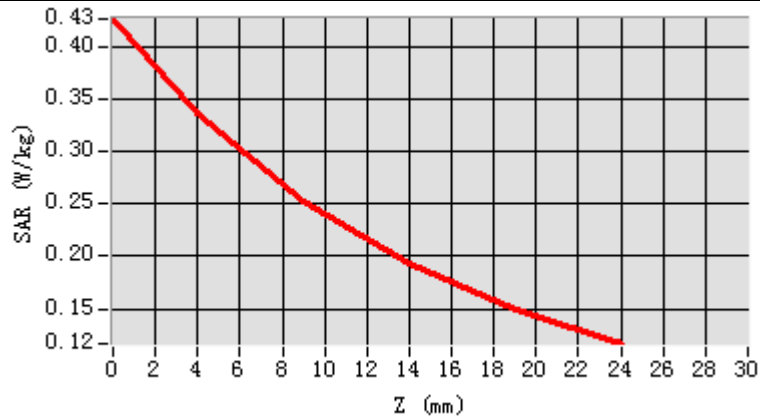

Hot spot position

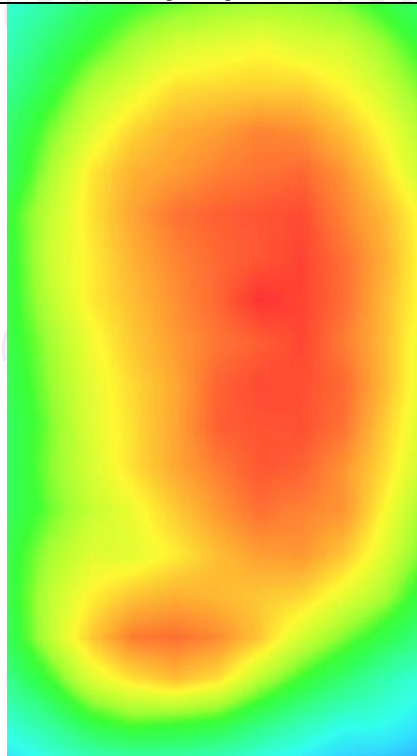

MEASUREMENT 4

Middle Band SAR (Channel 661):

Date: 03/06/2020

Frequency (MHz)	1880.000000
Relative permittivity (real part)	55.242927
Relative permittivity (imaginary part)	21.378266
Conductivity (S/m)	0.941230
Variation (%)	-4.820000
Crest Factor:	2.0
Probe Conversion factor	5.65
E-Field Probe:	SSE2 (SN 41/18 EP331)
Area Scan	<u>dx=8mm dy=8mm, h= 5.00 mm</u>
ZoomScan	<u>5x5x7, dx=8mm dy=8mm</u> <u>dz=5mm, Complete/ndx=8mm dy=8mm, h=</u> <u>5.00 mm</u>
Phantom	<u>Validation plane</u>
Device Position	<u>Body back(10mm)</u>
Band	<u>GSM850(GPRS 4slot hotspot)</u>

SURFACE SAR

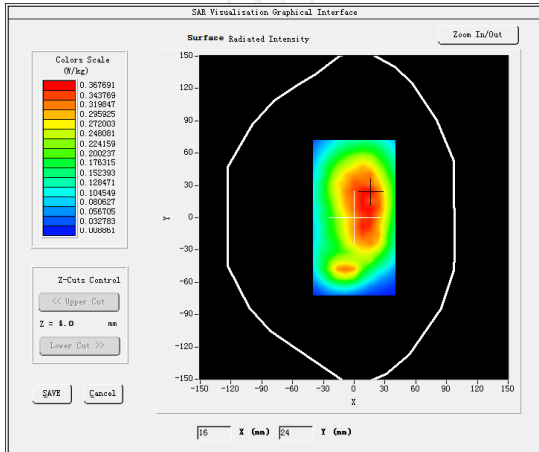

VOLUME SAR

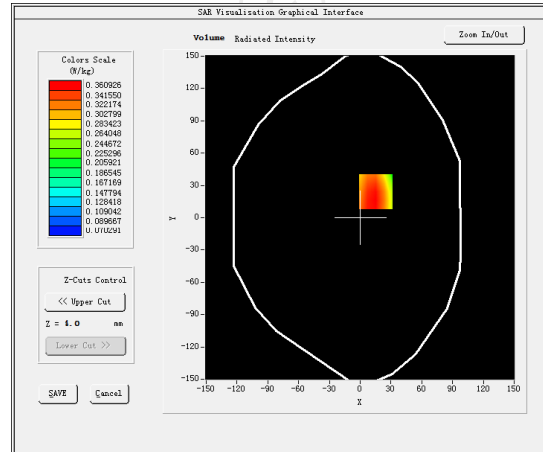

Maximum location: X=15.00, Y=24.00 SAR Peak: 0.46 W/kg

SAR 10g (W/Kg)

0.253113

SAR 1g (W/Kg)

0.350207

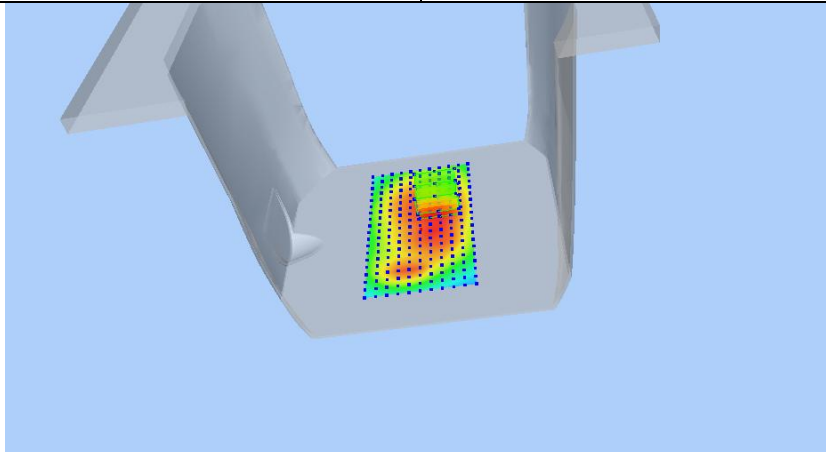

Z (mm)	0.00	4.00	9.00	14.00	19.00
SAR (W/Kg)	0.6426	0.3609	0.2465	0.1983	0.1352

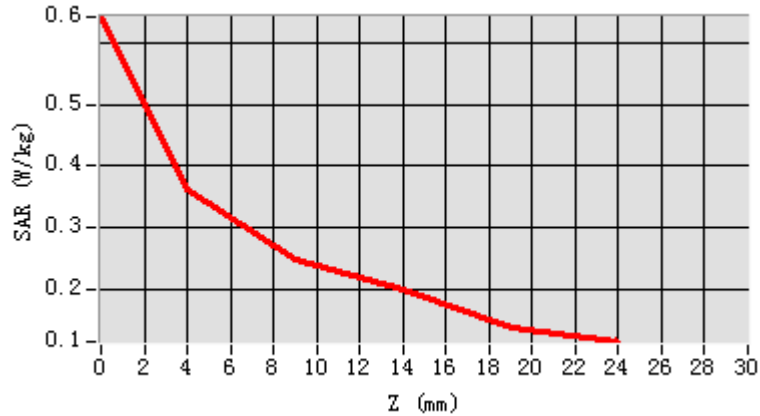

Hot spot position

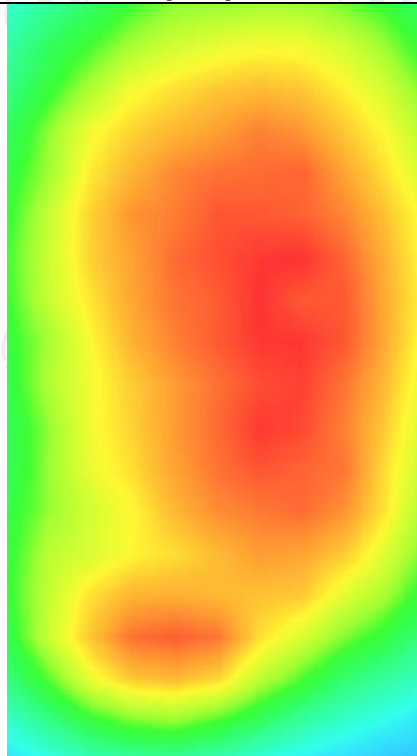

GPRS 1900

MEASUREMENT 1

Lower Band SAR (Channel 512):

Date: 03/08/2020

Frequency (MHz)	1850.200000
Relative permittivity (real part)	39.105208
Relative permittivity (imaginary part)	12.607628
Conductivity (S/m)	1.342108
Variation (%)	1.960000
Crest Factor	8.3
Probe Conversion factor	4.85
E-Field Probe:	SSE2 (SN 41/18 EP331)
Area Scan	<u>dx=8mm dy=8mm, h= 5.00 mm</u>
ZoomScan	<u>5x5x7, dx=8mm dy=8mm</u> <u>dz=5mm, Complete/ndx=8mm dy=8mm, h=</u> <u>5.00 mm</u>
Phantom	<u>Right head</u>
Device Position	<u>Cheek</u>
Band	<u>GSM1900(voice)</u>

SURFACE SAR

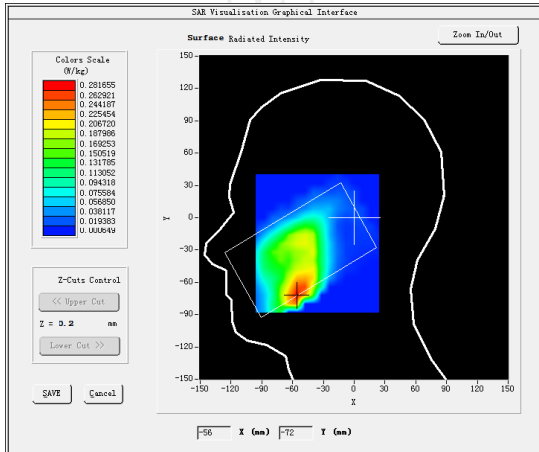

VOLUME SAR

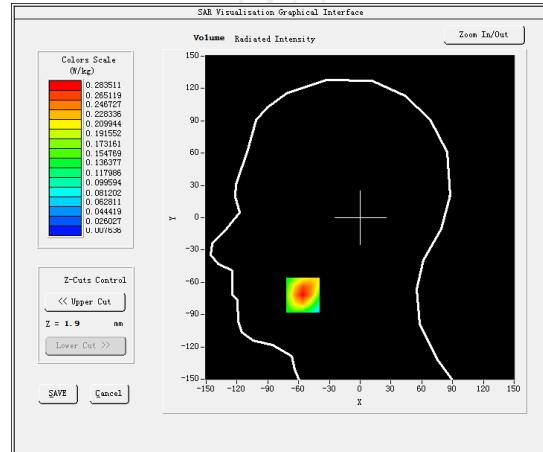

Maximum location: X=-56.00, Y=-72.00 SAR Peak: 0.46 W/kg

SAR 10g (W/Kg)

0.150447

SAR 1g (W/Kg)

0.267977

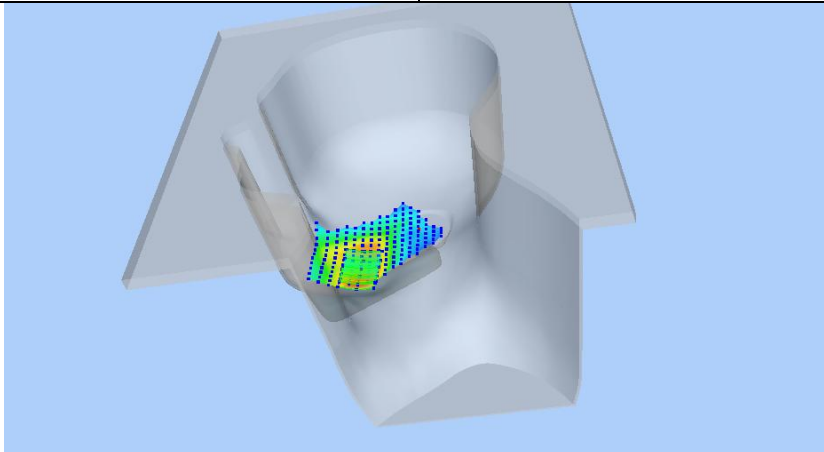

Z (mm)	0.00	4.00	9.00	14.00	19.00
SAR (W/Kg)	0.4576	0.2835	0.1539	0.0884	0.0581

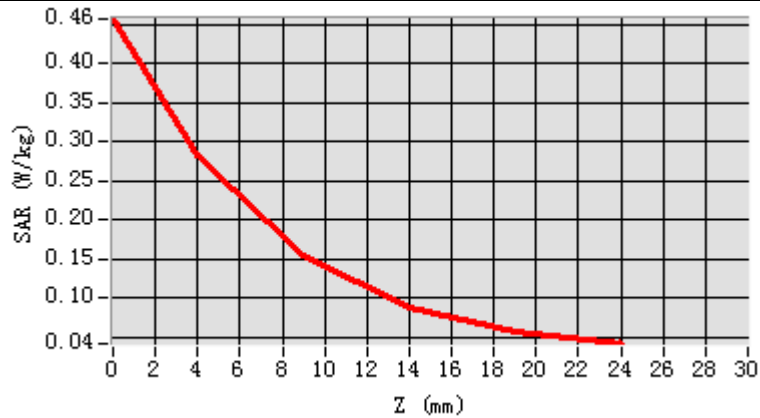

Hot spot position

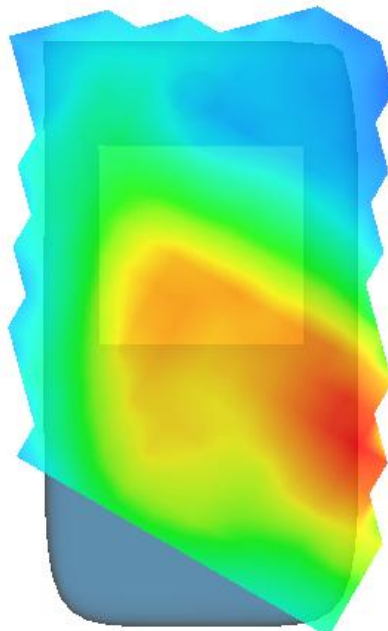

MEASUREMENT 2

Lower Band SAR (Channel 512):

Date: 03/08/2020

Frequency (MHz)	1850.200000
Relative permittivity (real part)	53.341337
Relative permittivity (imaginary part)	14.232400
Conductivity (S/m)	1.491736
Variation (%)	4.700000
Crest Factor	8.3
Probe Conversion factor	5.01
E-Field Probe:	SSE2 (SN 41/18 EP331)
Area Scan	<u>dx=8mm dy=8mm, h= 5.00 mm</u>
ZoomScan	<u>5x5x7, dx=8mm dy=8mm</u> <u>dz=5mm, Complete/ndx=8mm dy=8mm, h=</u> <u>5.00 mm</u>
Phantom	<u>Validation plane</u>
Device Position	<u>Body back(10mm)</u>
Band	<u>GSM1900(voice)</u>

SURFACE SAR

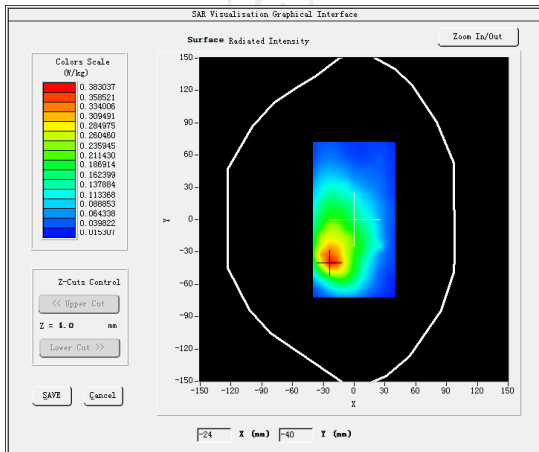

VOLUME SAR

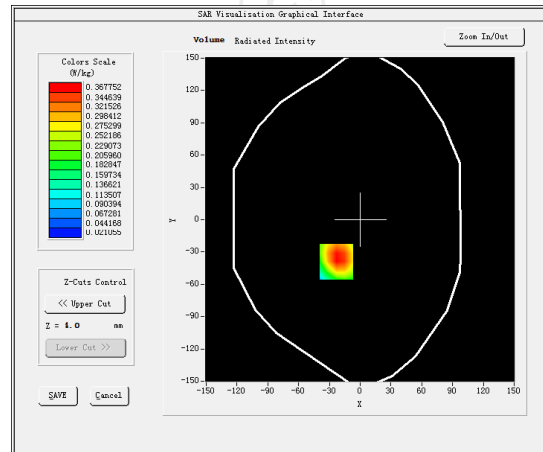

Maximum location: X=-23.00, Y=-39.00 SAR Peak: 0.58 W/kg

SAR 10g (W/Kg)

0.204047

SAR 1g (W/Kg)

0.355266

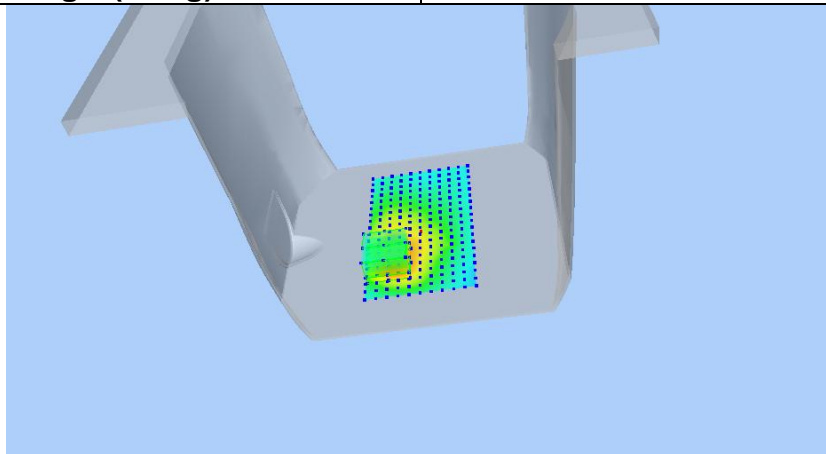

Z (mm)	0.00	4.00	9.00	14.00	19.00
SAR (W/Kg)	0.5708	0.3678	0.2083	0.1202	0.0737

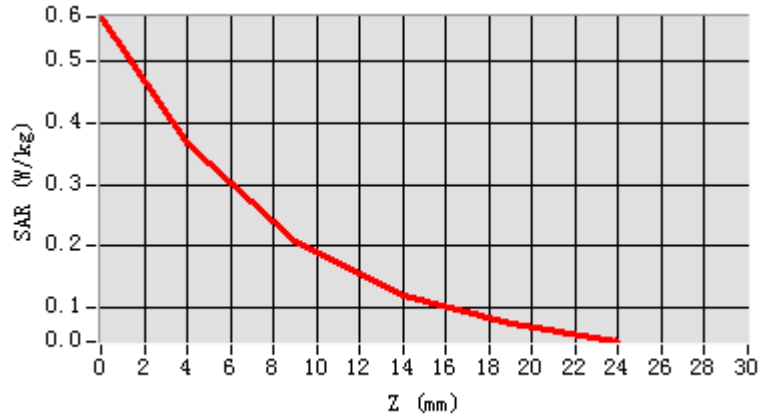

Hot spot position

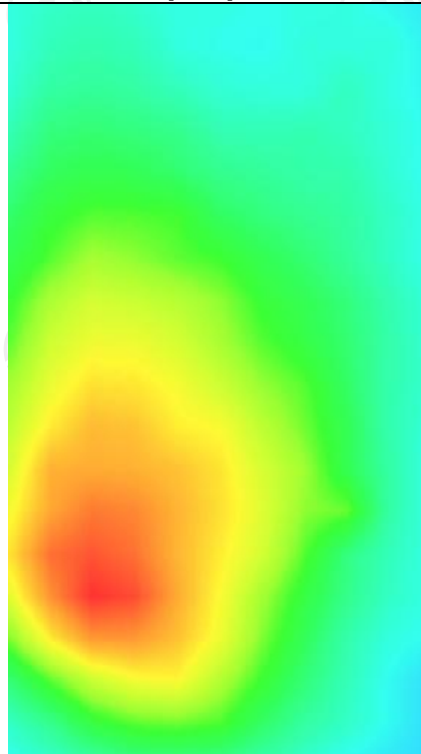

MEASUREMENT 3

Lower Band SAR (Channel 512):

Date: 03/08/2020

Frequency (MHz)	1850.200000
Relative permittivity (real part)	53.341337
Relative permittivity (imaginary part)	14.232400
Conductivity (S/m)	1.491736
Variation (%)	-1.600000
Crest Factor	2.0
Probe Conversion factor	5.01
E-Field Probe:	SSE2 (SN 41/18 EP331)
Area Scan	<u>dx=8mm dy=8mm, h= 5.00 mm</u>
ZoomScan	<u>5x5x7, dx=8mm dy=8mm</u> <u>dz=5mm, Complete/ndx=8mm dy=8mm, h=</u> <u>5.00 mm</u>
Phantom	<u>Validation plane</u>
Device Position	<u>Body back(10mm)</u>
Band	<u>GSM1900(GPRS 4slot)</u>

SURFACE SAR

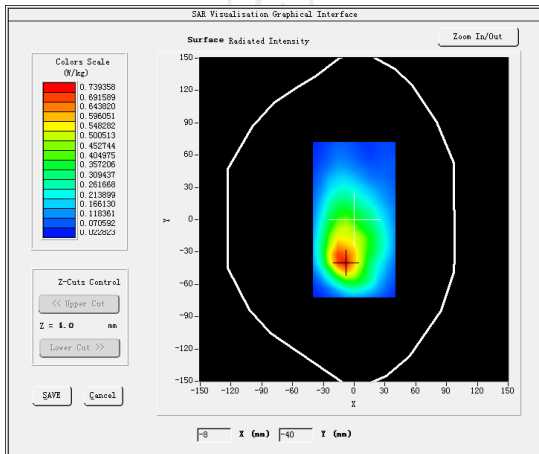

VOLUME SAR

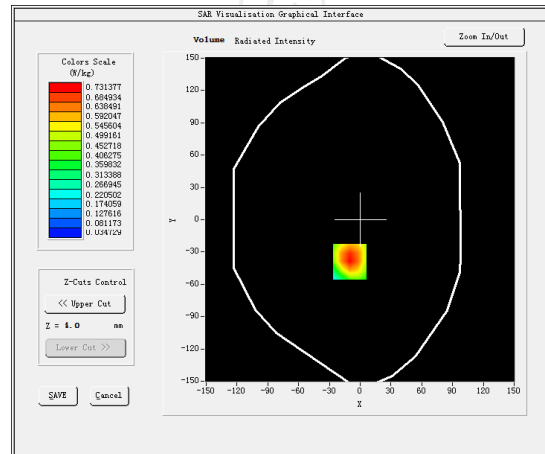

Maximum location: X=-10.00, Y=-39.00 SAR Peak: 1.16 W/kg

SAR 10g (W/Kg)

0.392715

SAR 1g (W/Kg)

0.695442

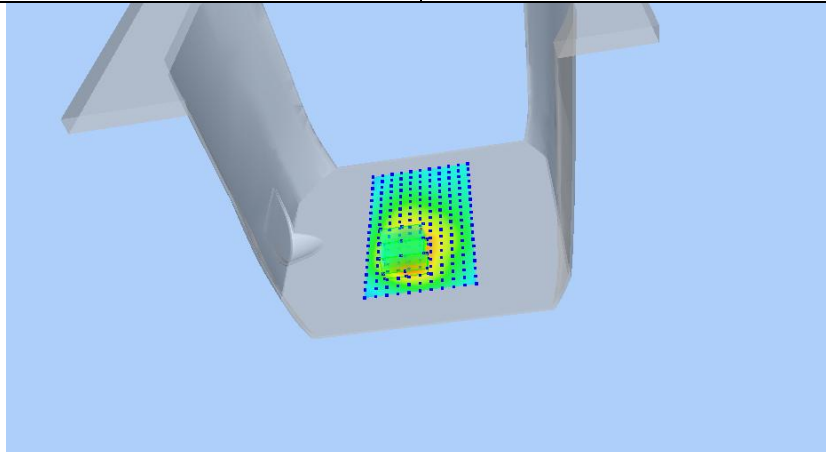

Z (mm)	0.00	4.00	9.00	14.00	19.00
SAR (W/Kg)	1.1478	0.7314	0.4069	0.2295	0.1372

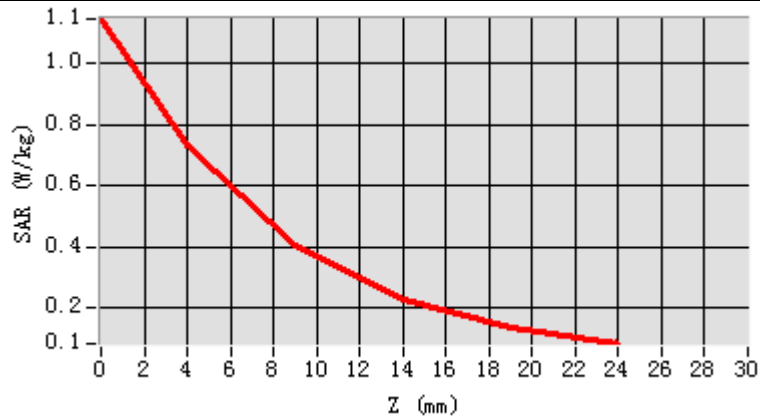

Hot spot position

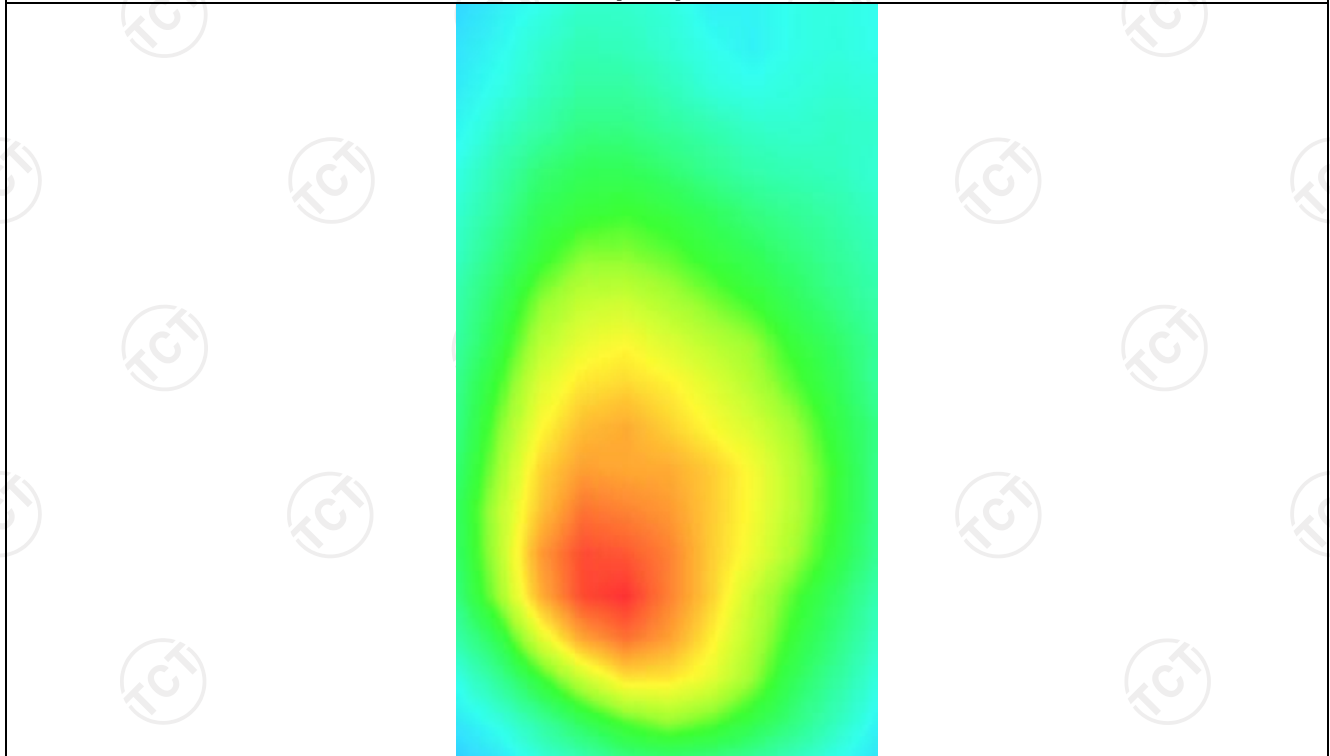

MEASUREMENT 4

Lower Band SAR (Channel 512):

Date: 03/08/2020

Frequency (MHz)	1850.200000
Relative permittivity (real part)	53.341337
Relative permittivity (imaginary part)	14.232400
Conductivity (S/m)	1.491736
Variation (%)	-2.120000
Crest Factor	2.0
Probe Conversion factor	5.01
E-Field Probe:	SSE2 (SN 41/18 EP331)
Area Scan	<u>dx=8mm dy=8mm, h= 5.00 mm</u>
ZoomScan	<u>5x5x7, dx=8mm dy=8mm</u> <u>dz=5mm, Complete/ndx=8mm dy=8mm, h=</u> <u>5.00 mm</u>
Phantom	<u>Validation plane</u>
Device Position	<u>Body back(10mm)</u>
Band	<u>GSM1900(GPRS 4slot hotspot)</u>

SURFACE SAR

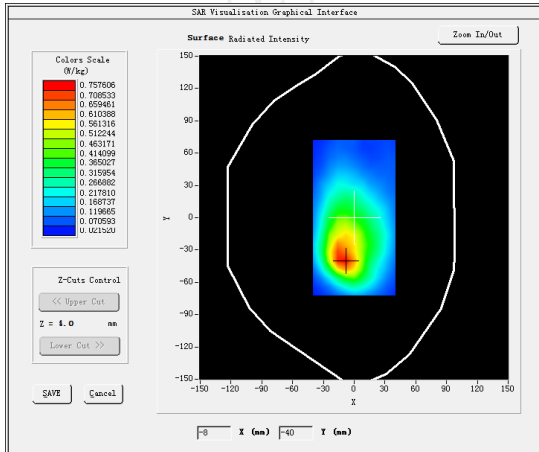

VOLUME SAR

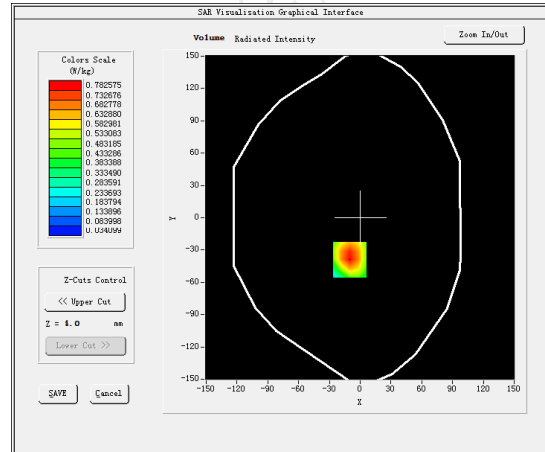

Maximum location: X=-10.00, Y=-39.00 SAR Peak: 1.28 W/kg

SAR 10g (W/Kg)

0.412461

SAR 1g (W/Kg)

0.744447

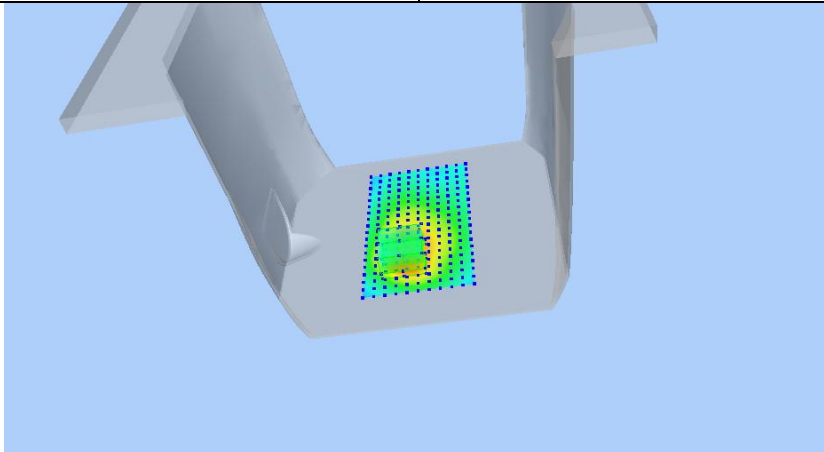

Z (mm)	0.00	4.00	9.00	14.00	19.00
SAR (W/Kg)	1.2656	0.7826	0.4190	0.2309	0.1401

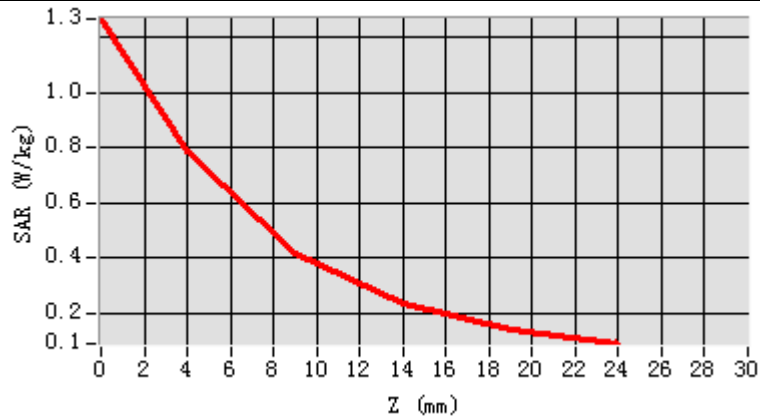

Hot spot position

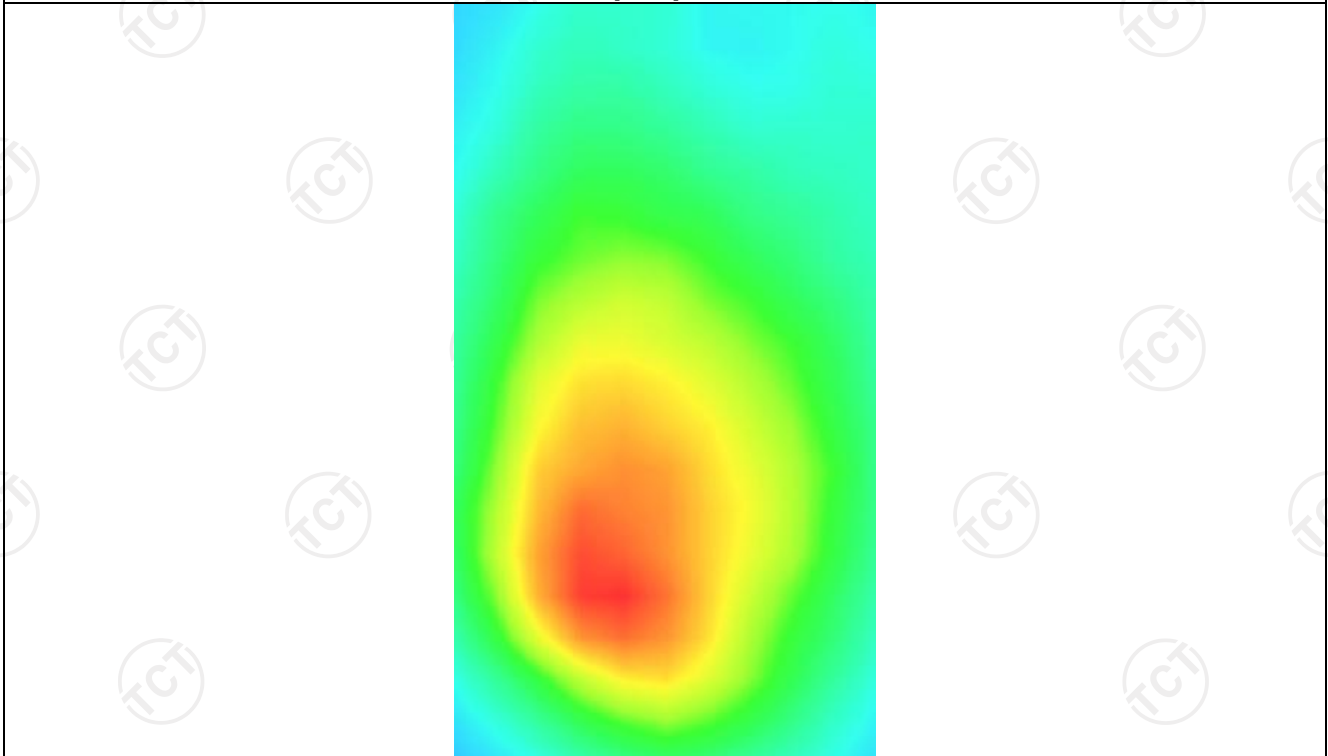

WCDMA Band II
MEASUREMENT 1

Middle Band SAR (Channel 9400):

Date: 03/08/2020

Frequency (MHz)	1880.000000
Relative permittivity (real part)	39.102437
Relative permittivity (imaginary part)	12.607241
Conductivity (S/m)	1.347279
Variation (%)	0.180000
Crest Factor	1.0
Probe Conversion factor	4.85
E-Field Probe:	SSE2 (SN 41/18 EP331)
Area Scan	<u>dx=8mm dy=8mm, h= 5.00 mm</u>
ZoomScan	<u>5x5x7, dx=8mm dy=8mm</u> <u>dz=5mm, Complete/ndx=8mm dy=8mm, h=</u> <u>5.00 mm</u>
Phantom	<u>Left head</u>
Device Position	<u>Cheek</u>
Band	<u>BAND2_WCDMA1900</u>

SURFACE SAR

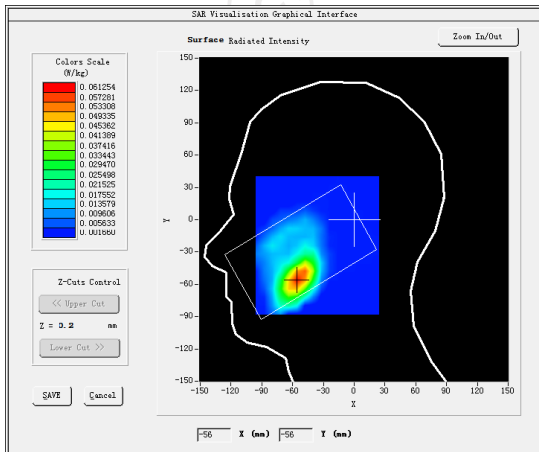

VOLUME SAR

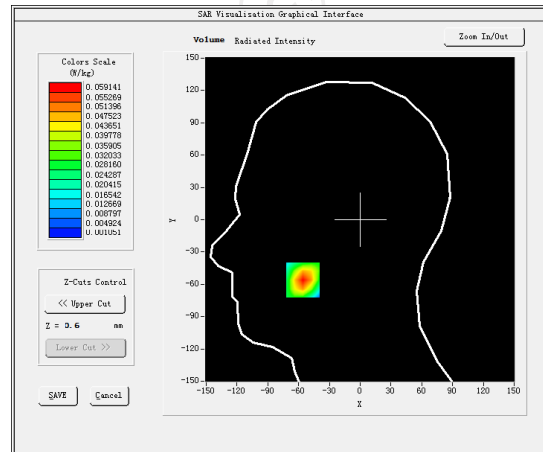

Maximum location: X=-56.00, Y=-56.00 SAR Peak: 0.09 W/kg

SAR 10g (W/Kg)

0.027800

SAR 1g (W/Kg)

0.054606

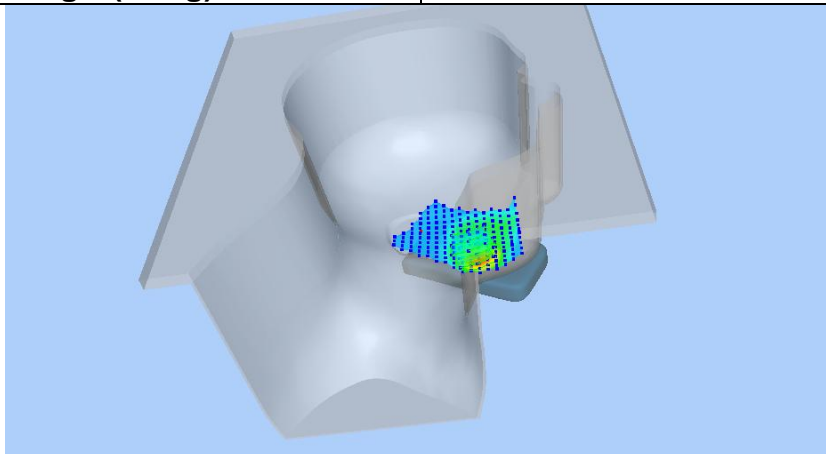

Z (mm)	0.00	4.00	9.00	14.00	19.00
SAR (W/Kg)	0.0923	0.0591	0.0325	0.0173	0.0089

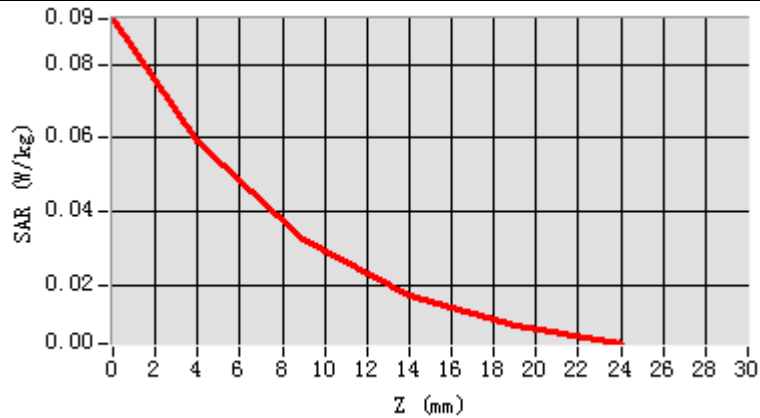

Hot spot position

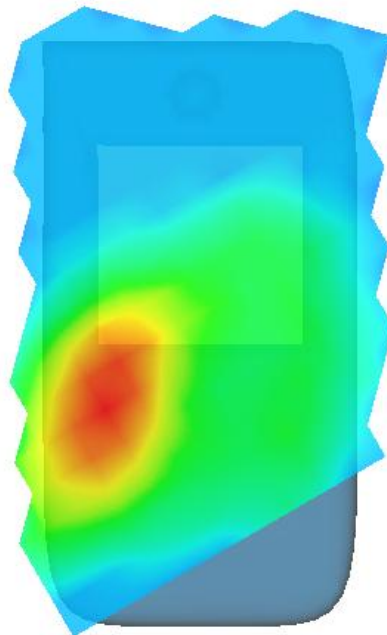

MEASUREMENT 2

Middle Band SAR (Channel 9400):

Date: 03/08/2020

Frequency (MHz)	1880.000000
Relative permittivity (real part)	53.321337
Relative permittivity (imaginary part)	14.232400
Conductivity (S/m)	1.496736
Variation (%)	1.050000
Crest Factor	1.0
Probe Conversion factor	5.01
E-Field Probe:	SSE2 (SN 41/18 EP331)
Area Scan	<u>dx=8mm dy=8mm, h= 5.00 mm</u>
ZoomScan	<u>5x5x7, dx=8mm dy=8mm</u> <u>dz=5mm, Complete/ndx=8mm dy=8mm, h=</u> <u>5.00 mm</u>
Phantom	<u>Validation plane</u>
Device Position	<u>Body back(10mm)</u>
Band	<u>BAND2_WCDMA1900</u>

SURFACE SAR

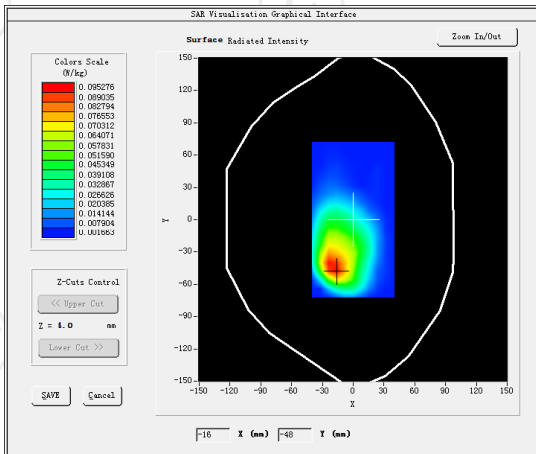

VOLUME SAR

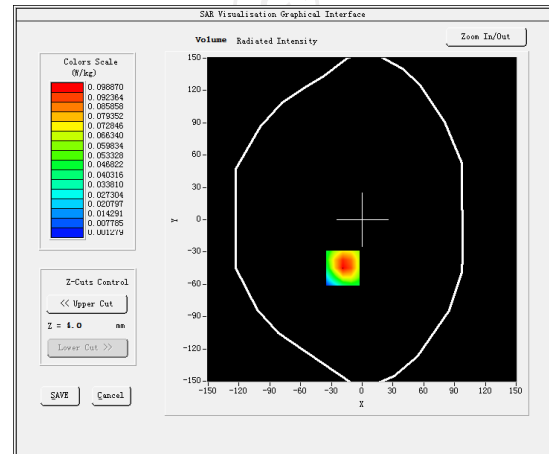

Maximum location: X=-19.00, Y=-45.00 SAR Peak: 0.18 W/kg

SAR 10g (W/Kg)

0.045974

SAR 1g (W/Kg)

0.094773

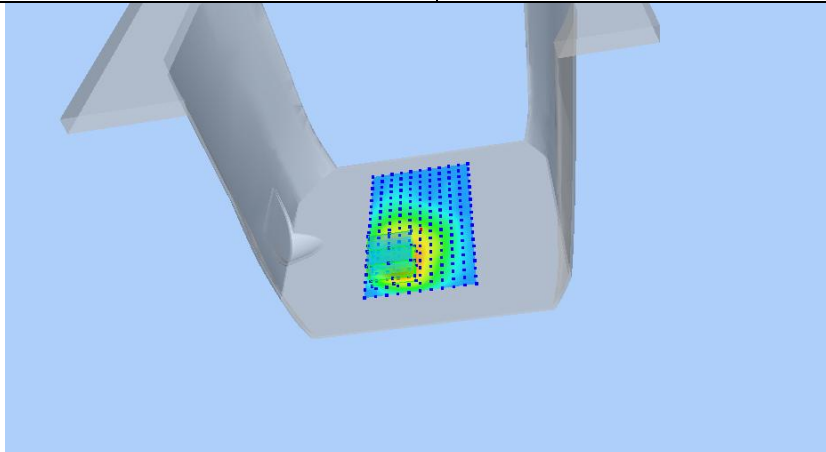

Z (mm)	0.00	4.00	9.00	14.00	19.00
SAR (W/Kg)	0.1745	0.0989	0.0445	0.0183	0.0069

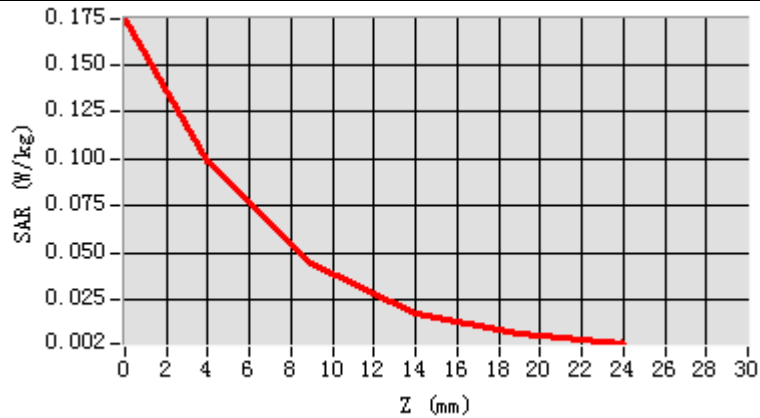

Hot spot position

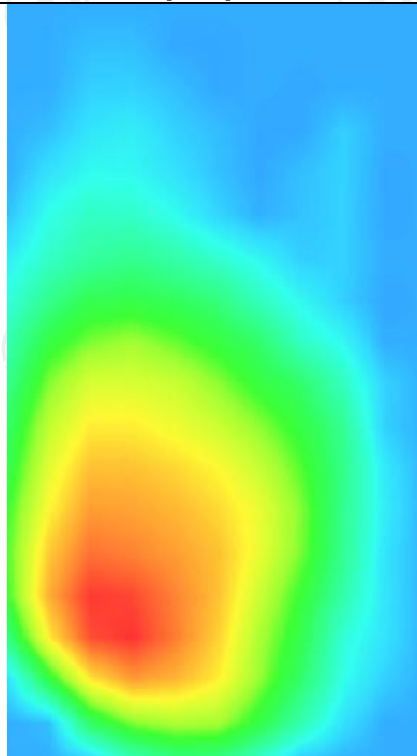

MEASUREMENT 3

Middle Band SAR (Channel 9400):

Date: 03/08/2020

Frequency (MHz)	1880.000000
Relative permittivity (real part)	53.321337
Relative permittivity (imaginary part)	14.232400
Conductivity (S/m)	1.496736
Variation (%)	-4.050000
Crest Factor	1.0
Probe Conversion factor	5.01
E-Field Probe:	SSE2 (SN 41/18 EP331)
Area Scan	<u>dx=8mm dy=8mm, h= 5.00 mm</u>
ZoomScan	<u>5x5x7, dx=8mm dy=8mm</u> <u>dz=5mm, Complete/ndx=8mm dy=8mm, h=</u> <u>5.00 mm</u>
Phantom	<u>Validation plane</u>
Device Position	<u>Body bottom(10mm)</u>
Band	<u>BAND2_WCDMA1900</u>

SURFACE SAR

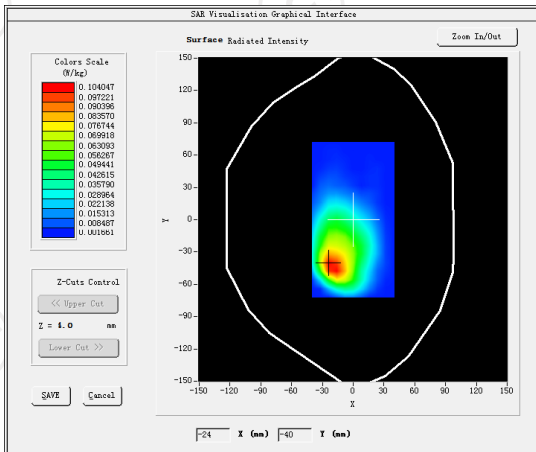

VOLUME SAR

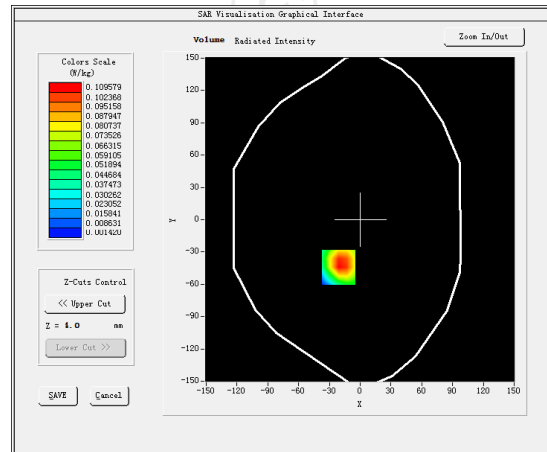

Maximum location: X=-21.00, Y=-44.00 SAR Peak: 0.20 W/kg

SAR 10g (W/Kg)

0.051449

SAR 1g (W/Kg)

0.105744

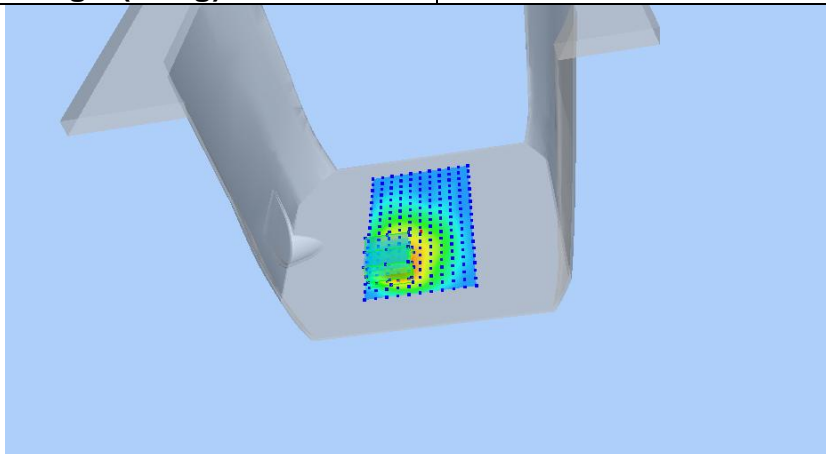

Z (mm)	0.00	4.00	9.00	14.00	19.00
SAR (W/Kg)	0.1910	0.1096	0.0501	0.0208	0.0077

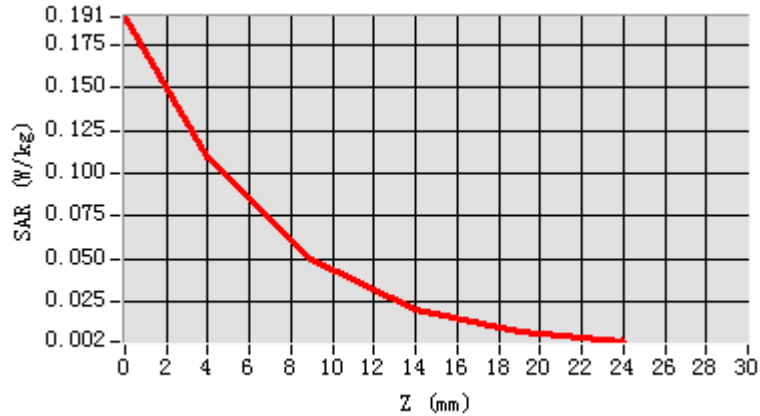

Hot spot position

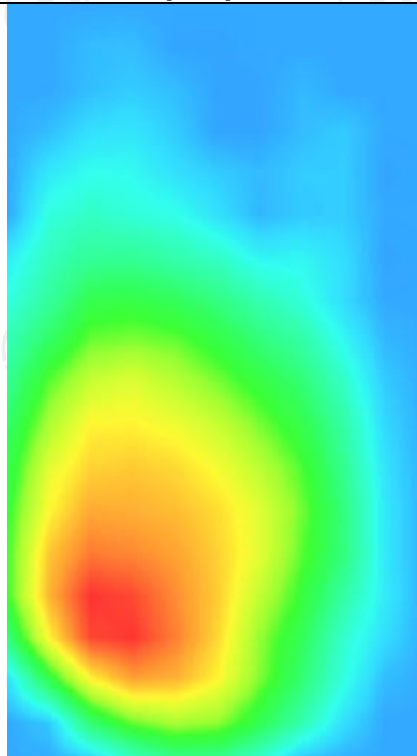

WCDMA Band V
MEASUREMENT 1

Middle Band SAR (Channel 9182):

Date: 03/06/2020

Frequency (MHz)	836.400000
Relative permittivity (real part)	41.422883
Relative permittivity (imaginary part)	18.129634
Conductivity (S/m)	0.867241
Variation (%)	-1.090000
Crest Factor:	1.0
Probe Conversion factor	5.50
E-Field Probe:	SSE2 (SN 41/18 EP331)
Area Scan	<u>dx=8mm dy=8mm, h= 5.00 mm</u>
ZoomScan	<u>5x5x7, dx=8mm dy=8mm</u> <u>dz=5mm, Complete/ndx=8mm dy=8mm, h=</u> <u>5.00 mm</u>
Phantom	<u>Left head</u>
Device Position	<u>Cheek</u>
Band	<u>BAND5_WCDMA850</u>

SURFACE SAR

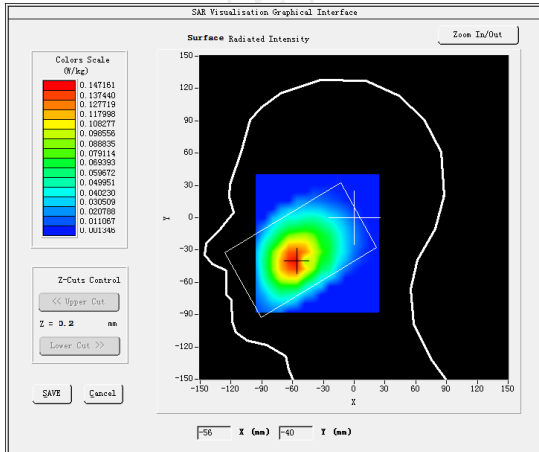

VOLUME SAR

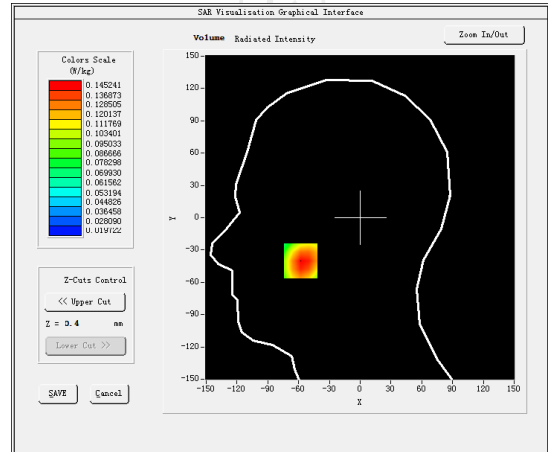

Maximum location: X=-58.00, Y=-40.00 SAR Peak: 0.19 W/kg

SAR 10g (W/Kg)

0.095798

SAR 1g (W/Kg)

0.140104

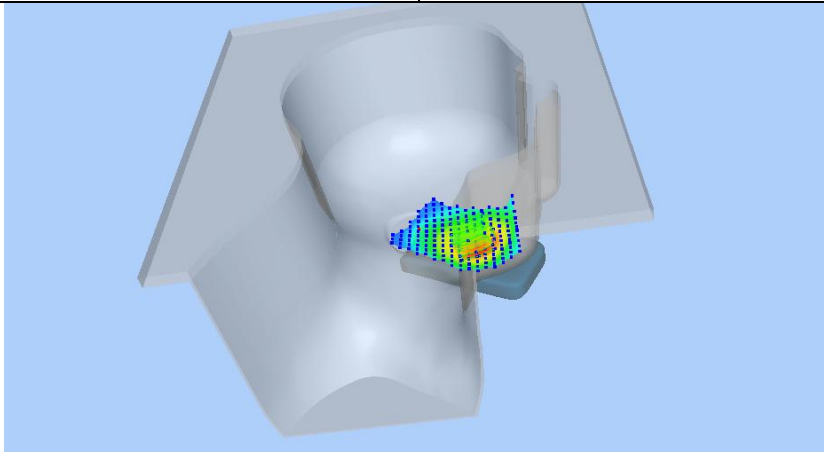

Z (mm)	0.00	4.00	9.00	14.00	19.00
SAR (W/Kg)	0.1865	0.1452	0.1059	0.0776	0.0572

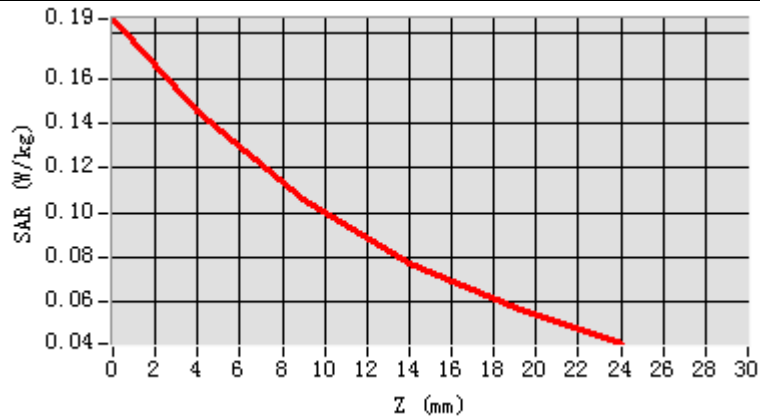

Hot spot position

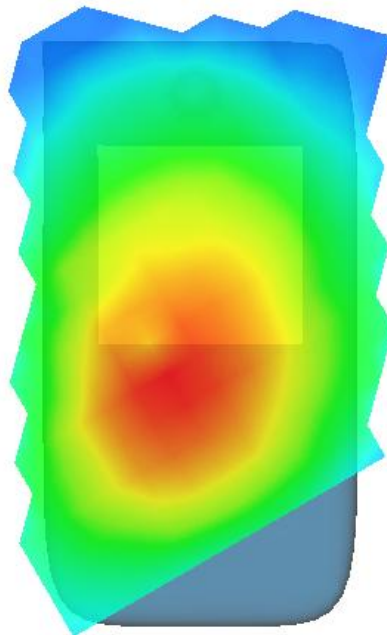

MEASUREMENT 2

Middle Band SAR (Channel 9182):

Date: 03/06/2020

Frequency (MHz)	836.400000
Relative permittivity (real part)	55.242927
Relative permittivity (imaginary part)	21.378266
Conductivity (S/m)	0.941230
Variation (%)	-0.120000
Crest Factor:	1.0
Probe Conversion factor	5.65
E-Field Probe:	SSE2 (SN 41/18 EP331)
Area Scan	<u>dx=8mm dy=8mm, h= 5.00 mm</u>
ZoomScan	<u>5x5x7, dx=8mm dy=8mm</u> <u>dz=5mm, Complete/ndx=8mm dy=8mm, h=</u> <u>5.00 mm</u>
Phantom	<u>Validation plane</u>
Device Position	<u>Body back(10mm)</u>
Band	<u>BAND5_WCDMA850</u>

SURFACE SAR

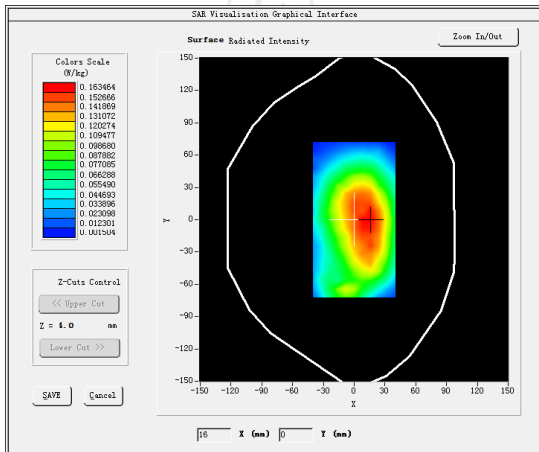

VOLUME SAR

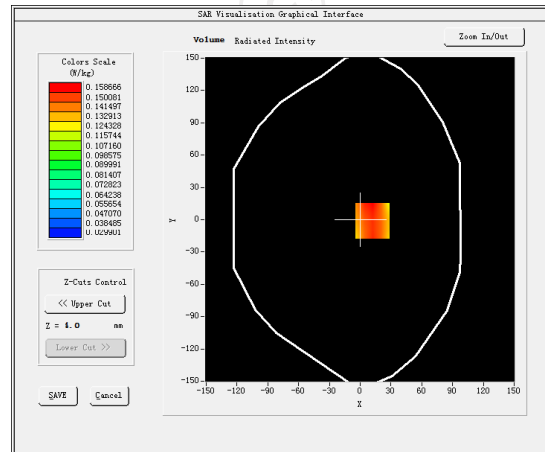

Maximum location: X=12.00, Y=-1.00 SAR Peak: 0.20 W/kg

SAR 10g (W/Kg)

0.109928

SAR 1g (W/Kg)

0.151547

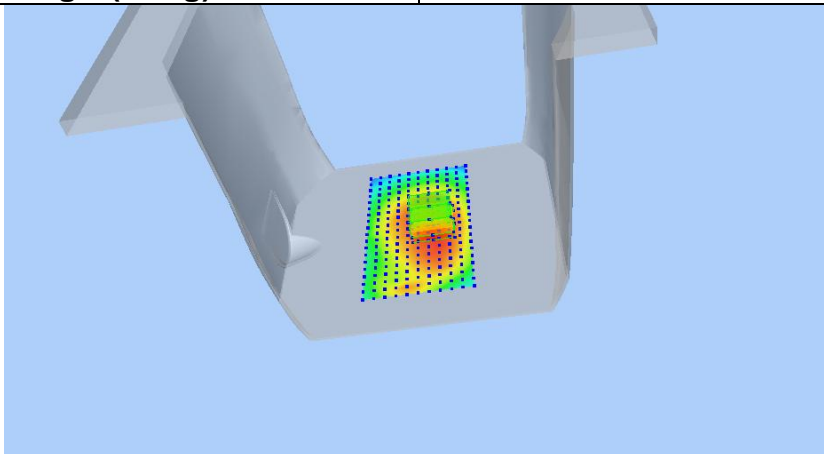

Z (mm)	0.00	4.00	9.00	14.00	19.00
SAR (W/Kg)	0.2173	0.1587	0.1169	0.0888	0.0637

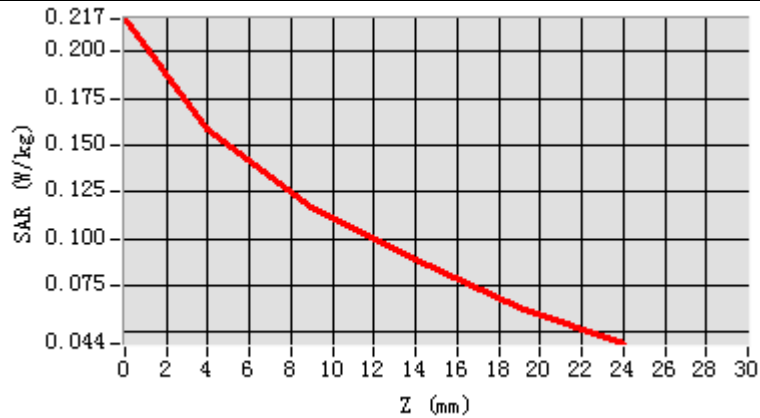

Hot spot position

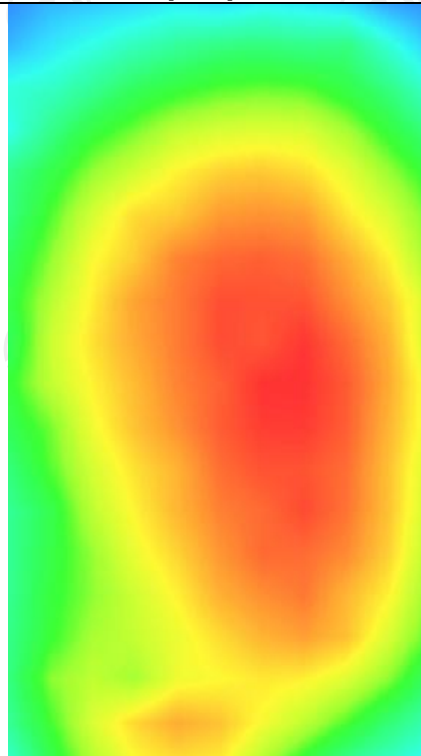

MEASUREMENT 3

Middle Band SAR (Channel 9182):

Date: 03/06/2020

Frequency (MHz)	836.400000
Relative permittivity (real part)	55.242927
Relative permittivity (imaginary part)	21.378266
Conductivity (S/m)	0.941230
Variation (%)	0.040000
Crest Factor:	1.0
Probe Conversion factor	5.65
E-Field Probe:	SSE2 (SN 41/18 EP331)
Area Scan	<u>dx=8mm dy=8mm, h= 5.00 mm</u>
ZoomScan	<u>5x5x7, dx=8mm dy=8mm</u> <u>dz=5mm, Complete/ndx=8mm dy=8mm,</u> <u>h= 5.00 mm</u>
Phantom	<u>Validation plane</u>
Device Position	<u>Body back(10mm)</u>
Band	<u>BAND5_WCDMA850(hotspot)</u>

SURFACE SAR

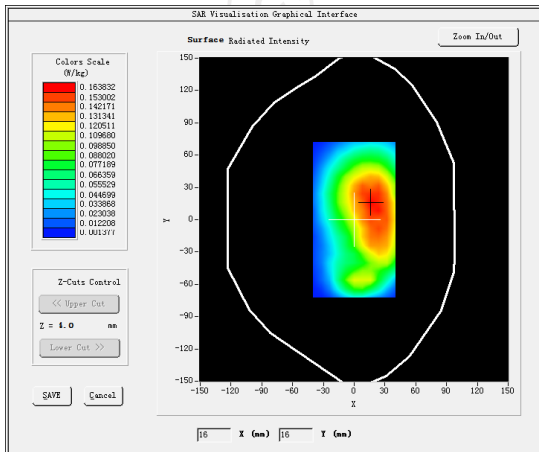

VOLUME SAR

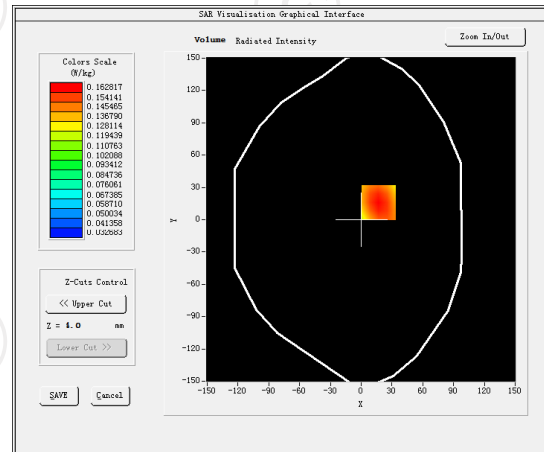

Maximum location: X=17.00, Y=16.00 SAR Peak: 0.21 W/kg

SAR 10g (W/Kg)

0.112464

SAR 1g (W/Kg)

0.156827

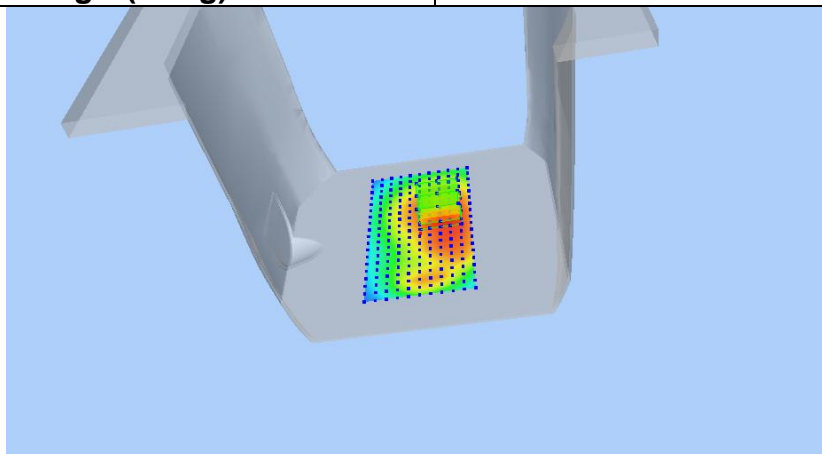

Z (mm)	0.00	4.00	9.00	14.00	19.00
SAR (W/Kg)	0.2082	0.1628	0.1199	0.0892	0.0674

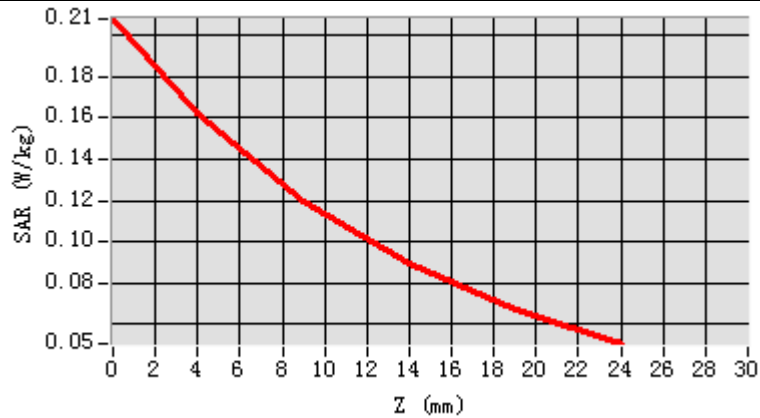

Hot spot position

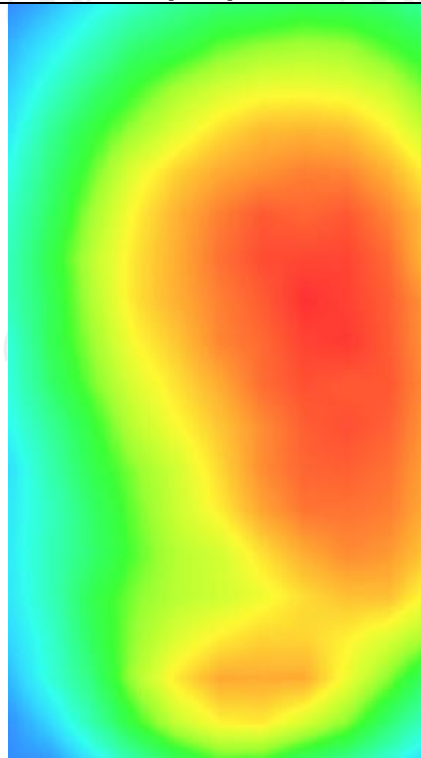

WIFI 2.4G

MEASUREMENT 1

Higher Band SAR (Channel 11):

Date: 03/27/2020

Frequency (MHz)	2462.000000
Relative permittivity (real part)	37.802831
Relative permittivity (imaginary part)	13.546209
Conductivity (S/m)	1.842611
Variation (%)	0.350000
Crest Factor	1.0
Probe Conversion factor	4.58
E-Field Probe:	SSE2 (SN 41/18 EP331)
Area Scan	<u>dx=8mm dy=8mm, h= 5.00 mm</u>
ZoomScan	<u>5x5x7, dx=8mm dy=8mm</u> <u>dz=5mm, Complete/ndx=8mm dy=8mm, h=</u> <u>5.00 mm</u>
Phantom	<u>Right head</u>
Device Position	<u>Cheek</u>
Band	<u>IEEE 802.11b ISM</u>

SURFACE SAR

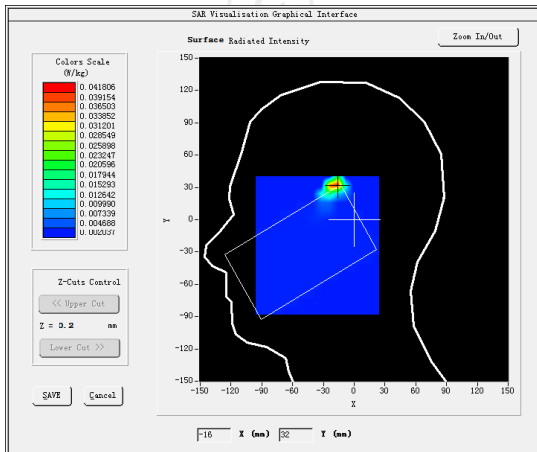

VOLUME SAR

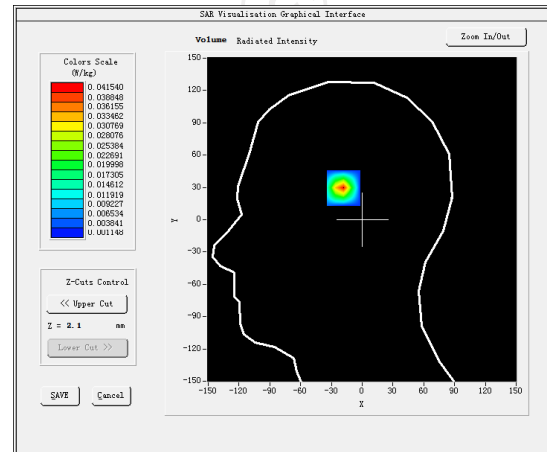

Maximum location: X=-18.00, Y=33.00 SAR Peak: 0.11 W/kg

SAR 10g (W/Kg)

0.013470

SAR 1g (W/Kg)

0.039065

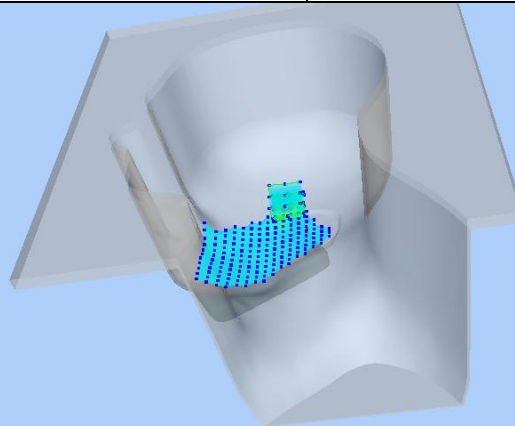

Z (mm)	0.00	4.00	9.00	14.00	19.00
SAR (W/Kg)	0.1051	0.0415	0.0093	0.0018	0.0011

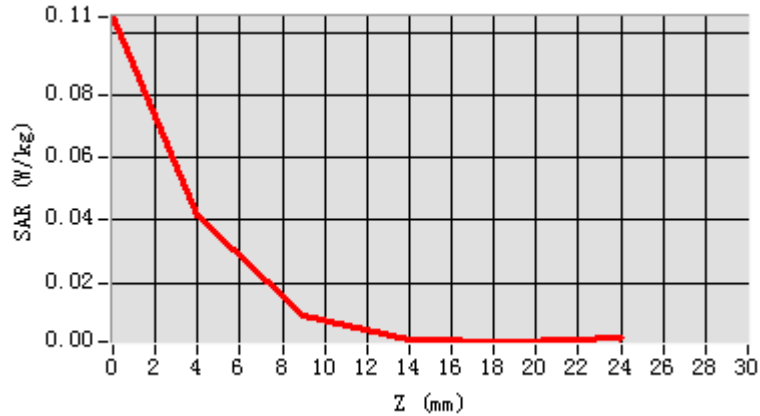

Hot spot position

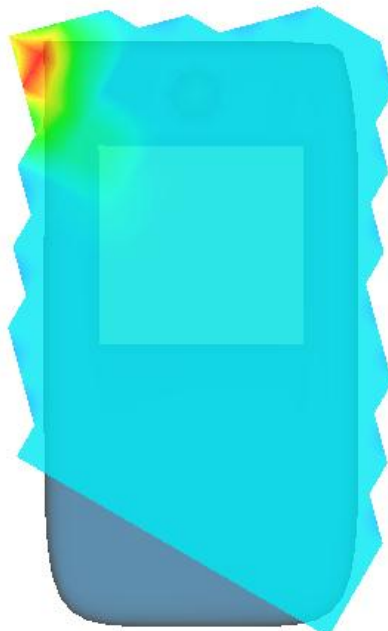

MEASUREMENT 2

Higher Band SAR (Channel 11):

Date: 03/27/2020

Frequency (MHz)	2462.000000
Relative permittivity (real part)	54.590667
Relative permittivity (imaginary part)	14.318428
Conductivity (S/m)	2.032536
Variation (%)	-2.580000
Crest Factor	1.0
Probe Conversion factor	4.70
E-Field Probe:	SSE2 (SN 41/18 EP331)
Area Scan	<u>dx=8mm dy=8mm, h= 5.00 mm</u>
ZoomScan	<u>5x5x7, dx=8mm dy=8mm</u> <u>dz=5mm, Complete/ndx=8mm dy=8mm, h=</u> <u>5.00 mm</u>
Phantom	Validation plane
Device Position	Body back(10mm)
Band	<u>IEEE 802.11b ISM</u>

SURFACE SAR

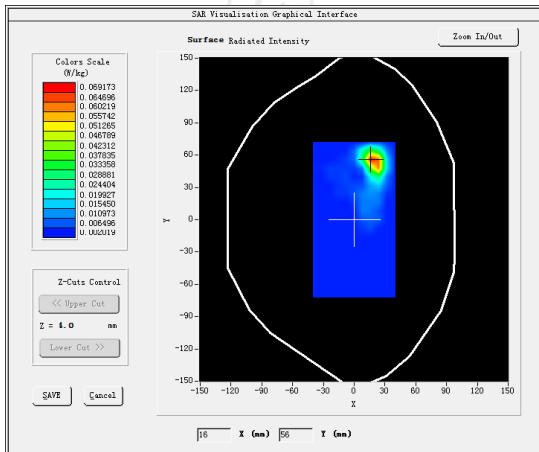

VOLUME SAR

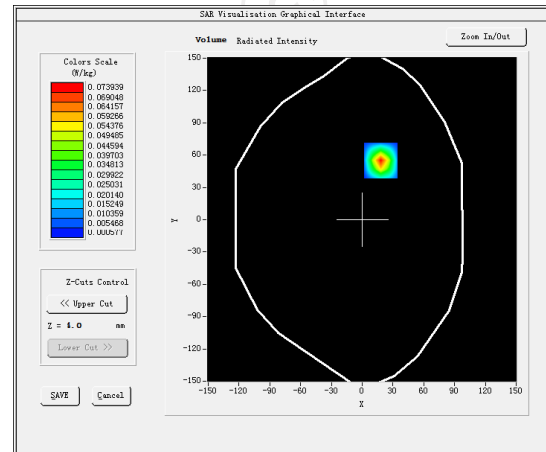

Maximum location: X=18.00, Y=55.00 SAR Peak: 0.16 W/kg

SAR 10g (W/Kg)

0.024744

SAR 1g (W/Kg)

0.067991

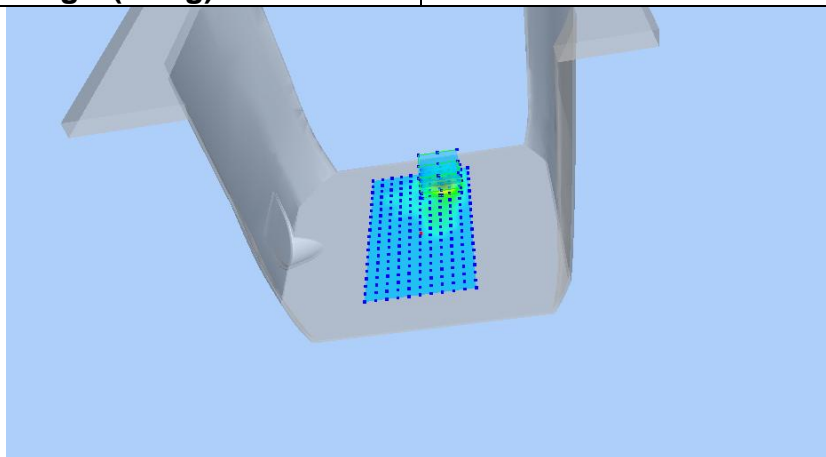

Z (mm)	0.00	4.00	9.00	14.00	19.00
SAR (W/Kg)	0.1637	0.0739	0.0225	0.0063	0.0028

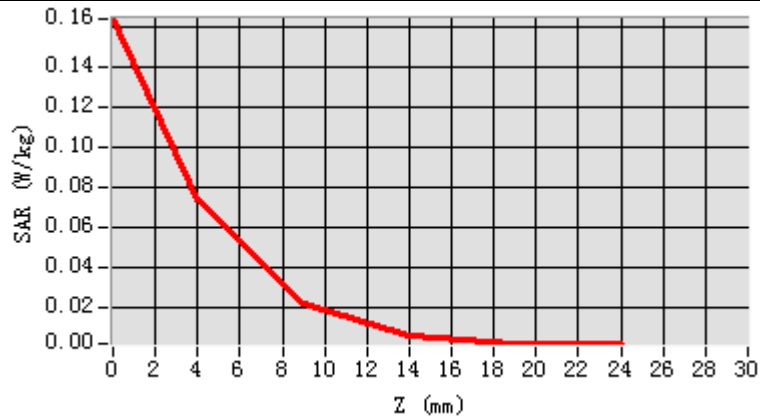

Hot spot position

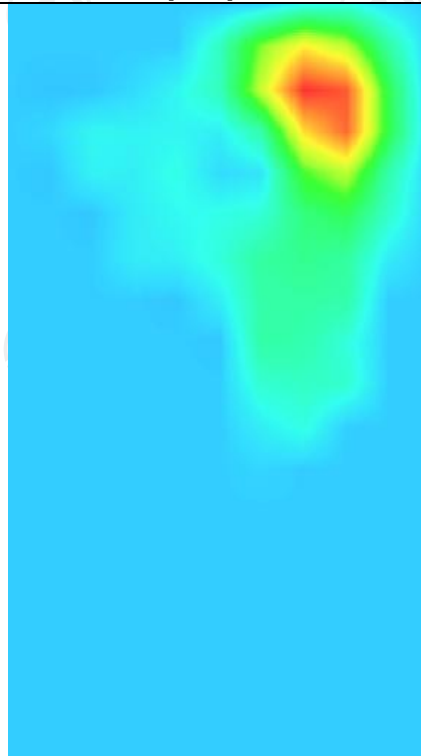

MEASUREMENT 3

Higher Band SAR (Channel 11):

Date: 03/27/2020

Frequency (MHz)	2462.000000
Relative permittivity (real part)	54.590667
Relative permittivity (imaginary part)	14.318428
Conductivity (S/m)	2.032536
Variation (%)	-3.330000
Crest Factor	1.0
Probe Conversion factor	4.70
E-Field Probe:	SSE2 (SN 41/18 EP331)
Area Scan	<u>dx=8mm dy=8mm, h= 5.00 mm</u>
ZoomScan	<u>5x5x7, dx=8mm dy=8mm</u> <u>dz=5mm, Complete/ndx=8mm dy=8mm, h=</u> <u>5.00 mm</u>
Phantom	Validation plane
Device Position	Body back(10mm)
Band	<u>IEEE 802.11b ISM(hotspot)</u>

SURFACE SAR

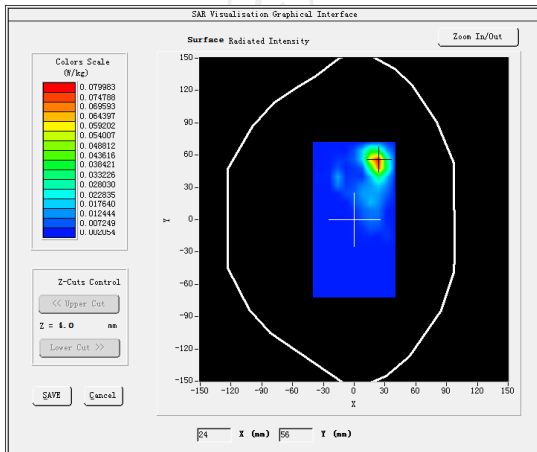

VOLUME SAR

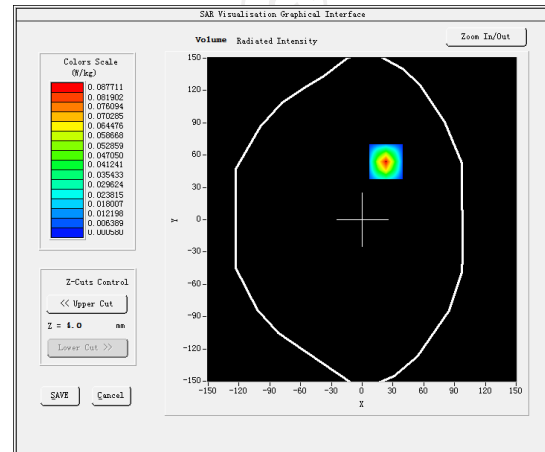

Maximum location: X=23.00, Y=54.00 SAR Peak: 0.19 W/kg

SAR 10g (W/Kg)

0.029234

SAR 1g (W/Kg)

0.080552

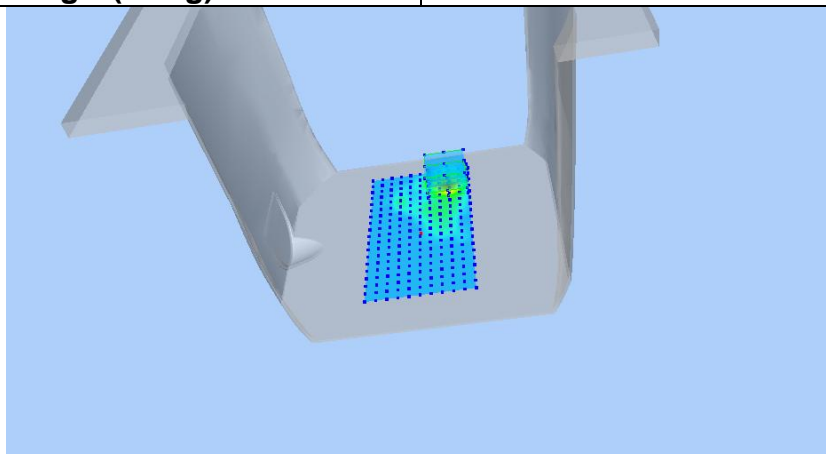

Z (mm)	0.00	4.00	9.00	14.00	19.00
SAR (W/Kg)	0.1922	0.0877	0.0272	0.0077	0.0032

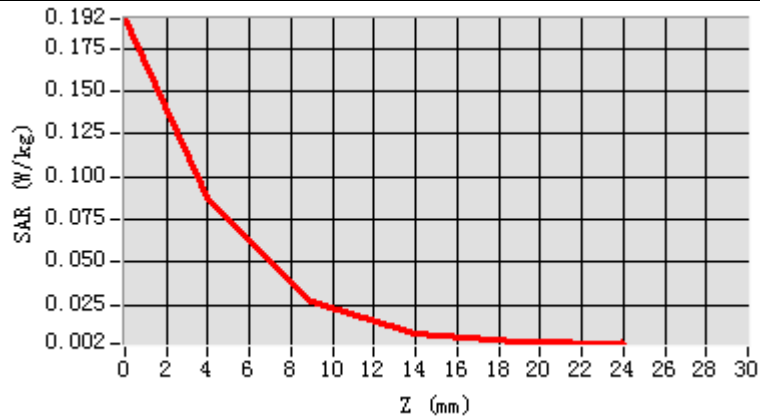

Hot spot position

