

<b>时间：</b>	2023-6-07	<b>产品型号：</b>	F4
<b>尺寸：</b>	105*145mm		
<b>材质：</b>	105g铜版纸		
<b>工艺：</b>	胶装		

# User Manual

## MAKE LIFE DIFFERENCE

---

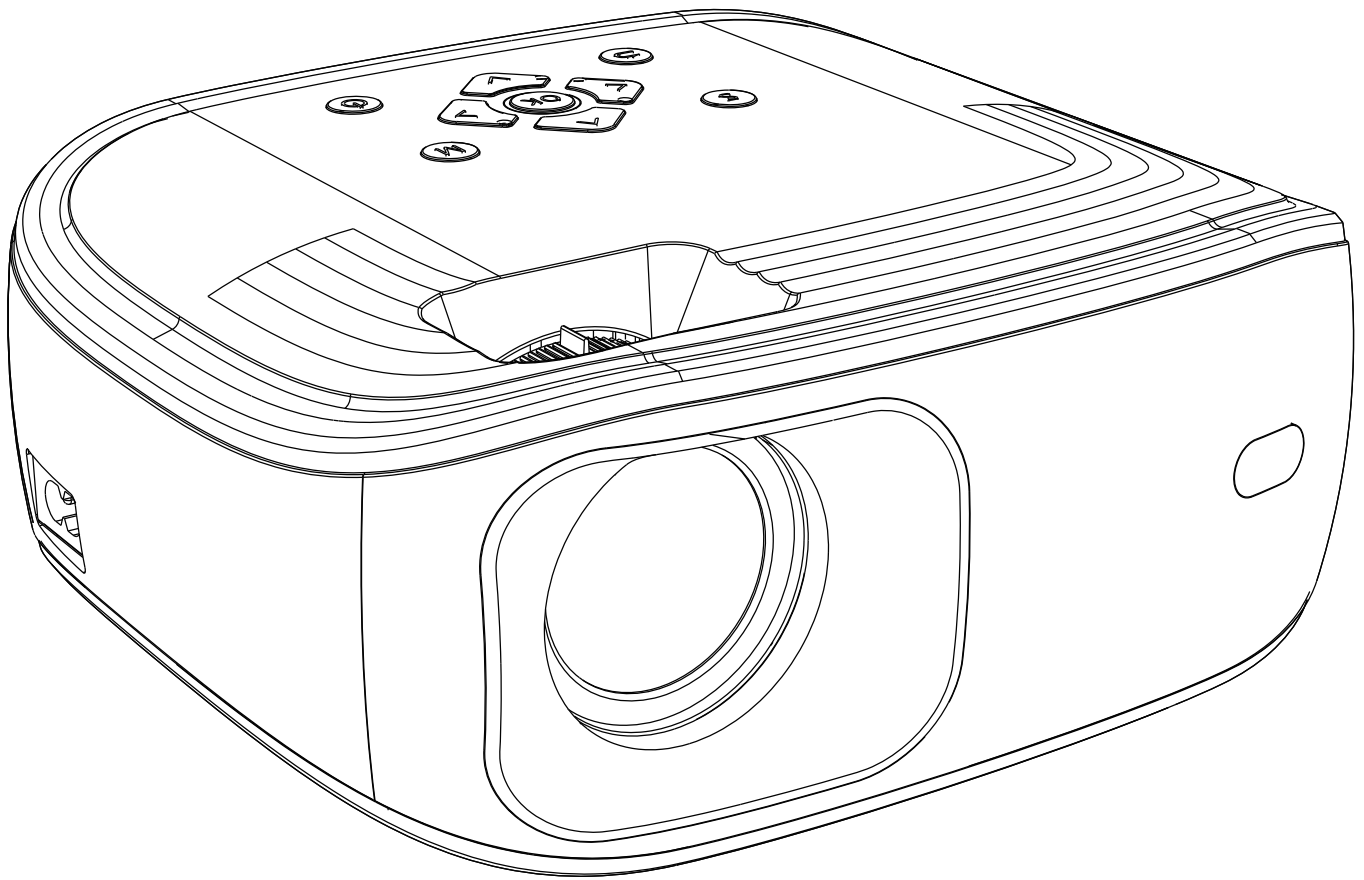

Model: F4

Please read this manual carefully  
before using the projector.

## **WARNINGS**

1. Do not look directly into the projector light.
2. Don't touch the projecting lens.
3. Mains adapter is used as a disconnect device and it should remain readily operable during intended use. In order to disconnect the apparatus from the mains completely, the mains plug should be disconnected from the mains socket outlet completely.
4. Use of controls or adjustments or performance of procedures other than those specified may result in hazardous radiation exposure.
5. Changes or modifications to this unit not expressly approved by the party responsible for compliance could void the user's authority to operate the equipment.
6. Use of this unit near fluorescent lighting may cause interference regarding the use of the remote. If the unit is displaying erratic behavior move away from any fluorescent lighting, as it may be the cause.
7. Shock hazard - Do Not Open.
8. Caution and marking information is located at the rear or bottom of the apparatus.
9. **WARNING:** To reduce the risk of fire or electric shock, do not expose this apparatus to rain, moisture, dripping, or splashing.
10. Objects filled with liquids, such as vases, shall not be placed on the apparatus.

# PRODUCT OVERVIEW

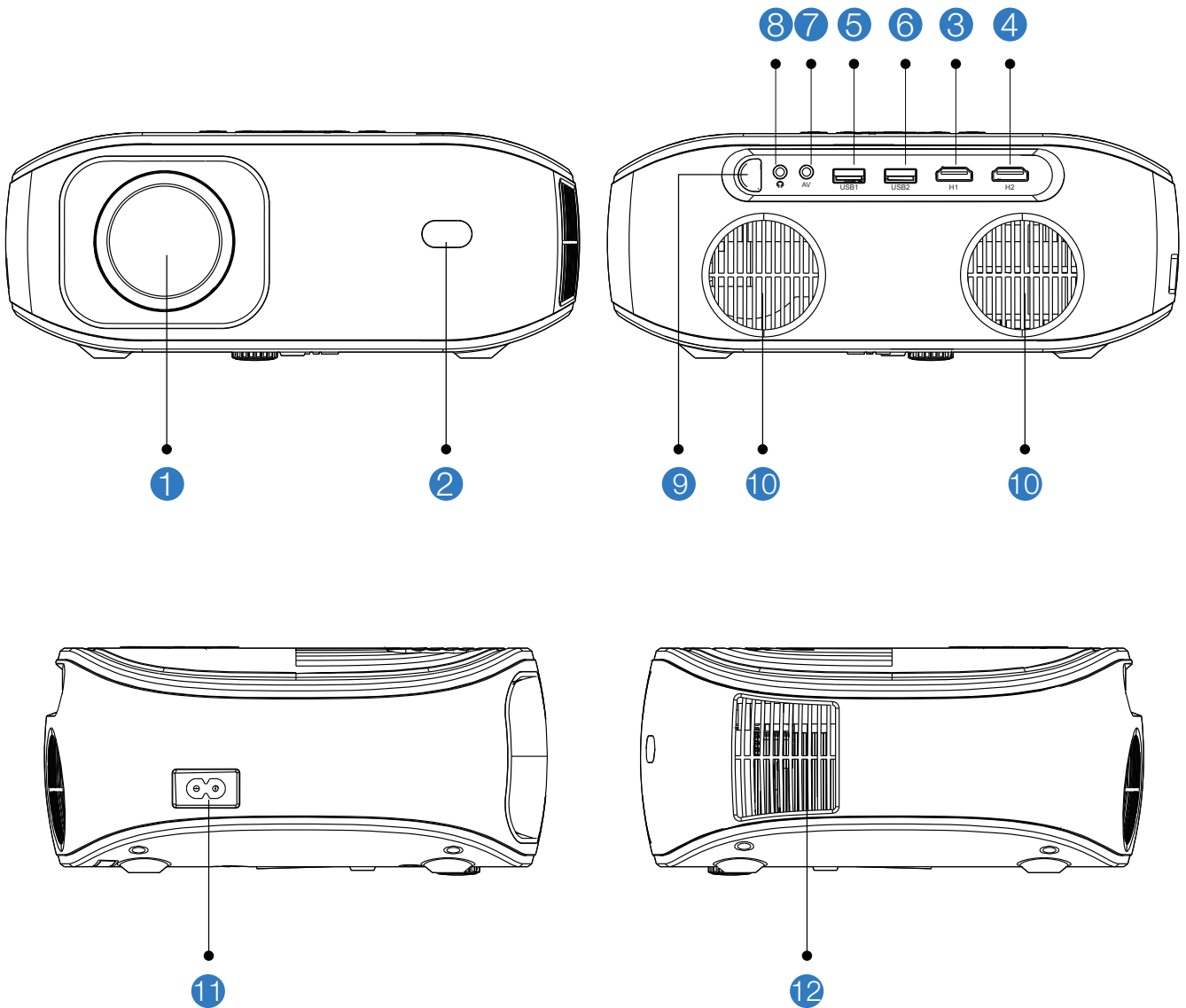

1 Focus Lens

2 IR Receiver

3 HDMI 1

4 HDMI 2

5 USB 1

6 USB 2

7 AV Port

8 3.5mm Port for Audio Output

9 IR Receiver

10 Speaker

11 Power Port

12 Cooling Window

# PRODUCT OVERVIEW

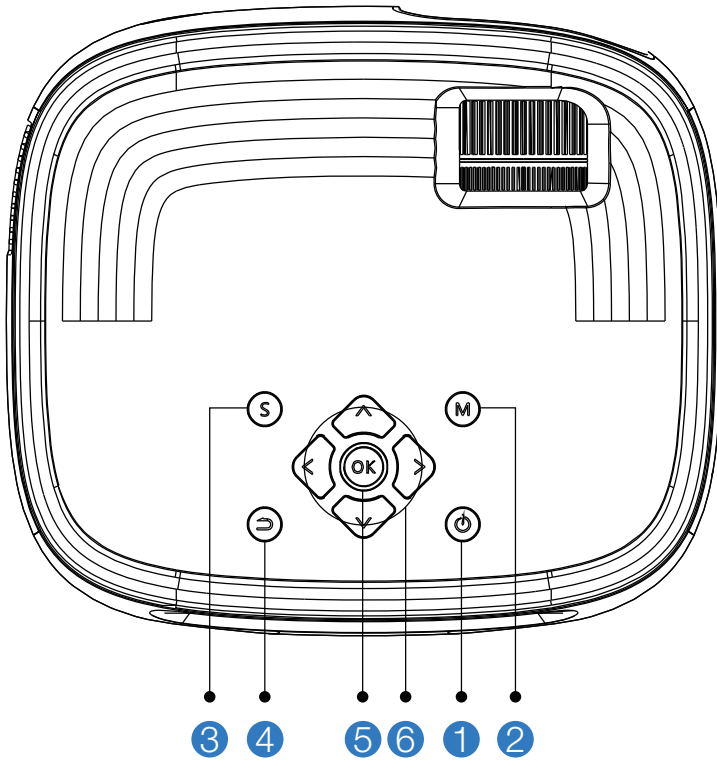

- 1 Power
- 2 Menu
- 3 Input Source
- 4 Return
- 5 Ok Key
- 6 Arrow Keys

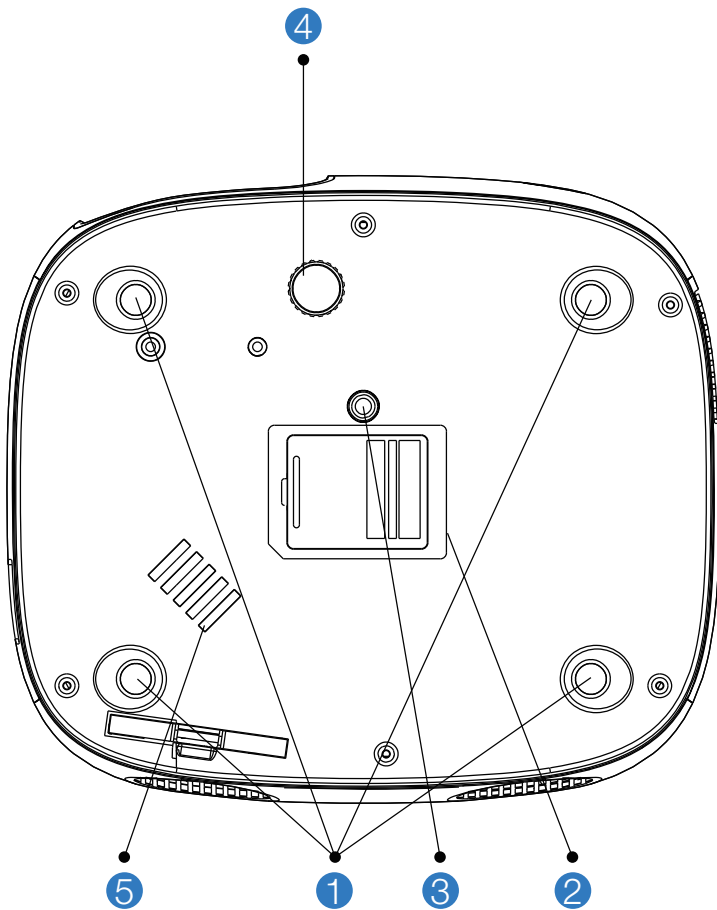

- 1 Rubber Foot Mats
- 2 Lens Cleaning Window
- 3 Ceiling Mounting Holes for the projector ( the size of the ceiling mounting holes is M6)
- 4 Height Adjustment Machine Feet
- 5 Cooling Window

# REMOTE CONTROL

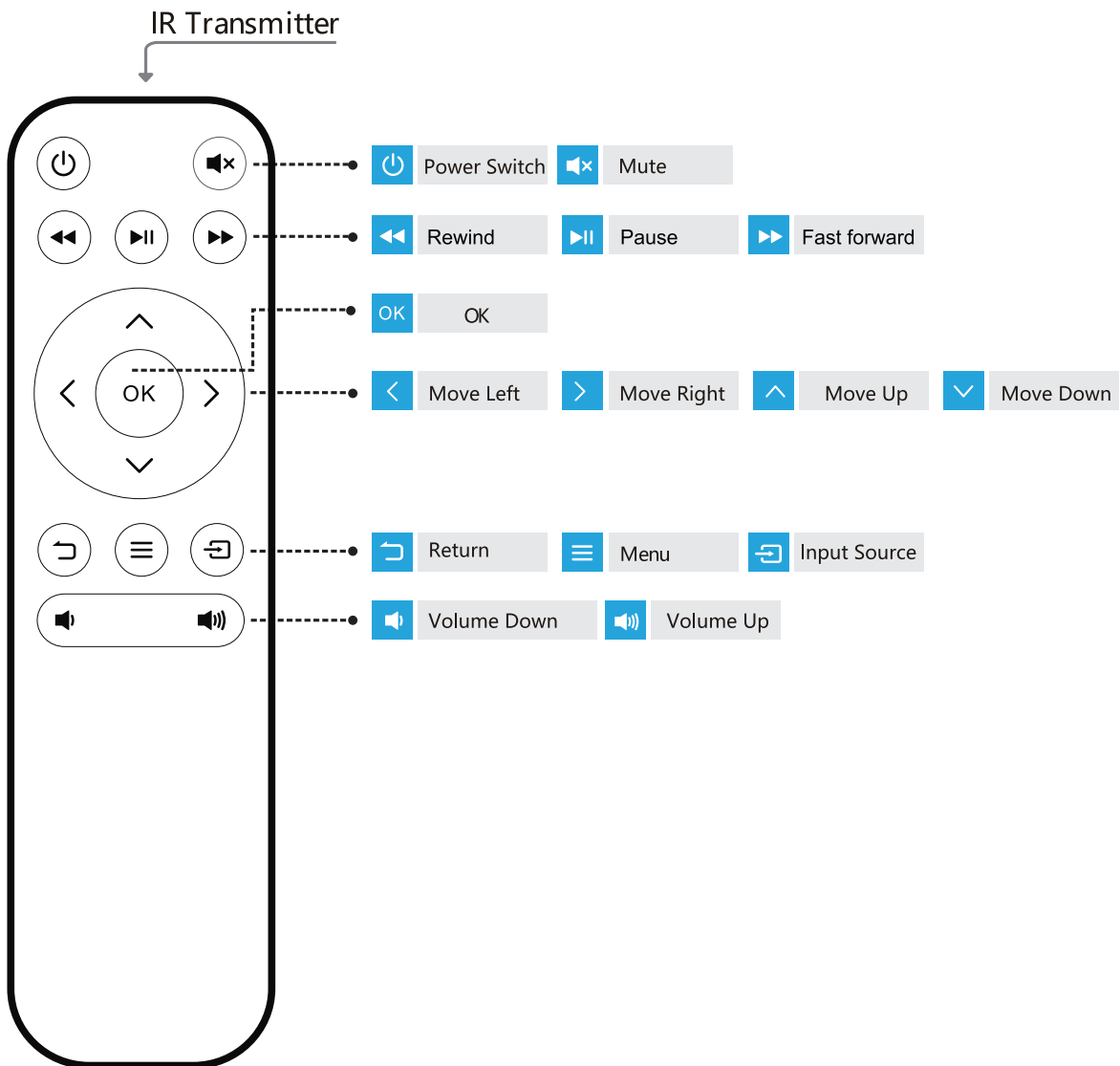

## Note:

Before using the remote control, put two AAA batteries into the back cover of the remote control.

## PRODUCT SPECIFICATIONS

Display Technology	4" LCD Screen
Native Resolution	1920*1080P
Flip	360°
Projection mode	Desktop Front Projection / Desktop Rear Projection/ Ceiling Mounted Front Projection/ Ceiling Mounted Rear Projection
Projection Lens	6 Slices Glass Lens
Aspect Ratio	16:9/4:3
Lamp	LED, 100000 Hours
Power Supply	AC100V-240V~50/60Hz

## MULTIMEDIA SUPPORTED FILES

①Audio Format	MP3/AAC/FLAC/OGG/MAV/WMA /M4A
②Image Format	BMP/JPGIJPEG/PNG
③Video Format	3GP/AVI/FLVI/MKV/MP4/MPG/WMV /RMVB/RM/TRP/VOB/DIVX/TP/TS/ DAT

# STARTING PROJECTOR

## 1. Power on/Power off

5 seconds after power-on, then press the power key  on the projector panel or the remote controller to turn on the device. Press the power key on the projector control panel or the remote control to turn off the device.

When the machine is turned off, unplug the power line in time to save energy.

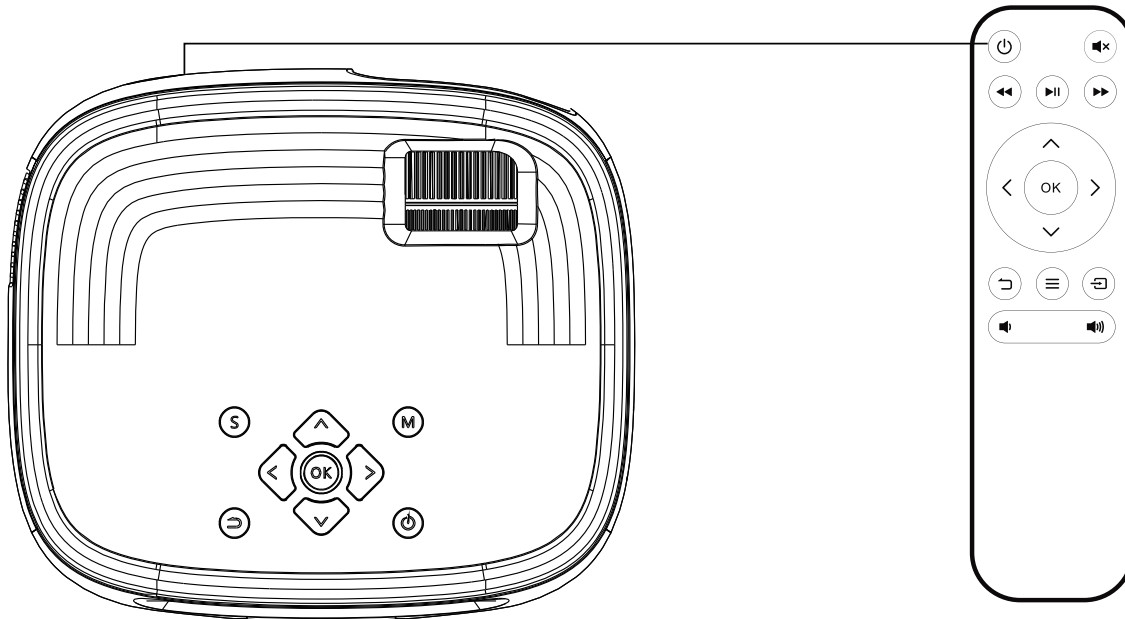

## 2. Focus and Keystone Correction

Focus (P1): Let the projector be perpendicular to the wall, and adjust the Focusing ring to make the picture clear.

Keystone Correction(P2): In different angel, you put the projector, the the projection will Deformation like a trapezoid, use the keystone correction to make it correct.

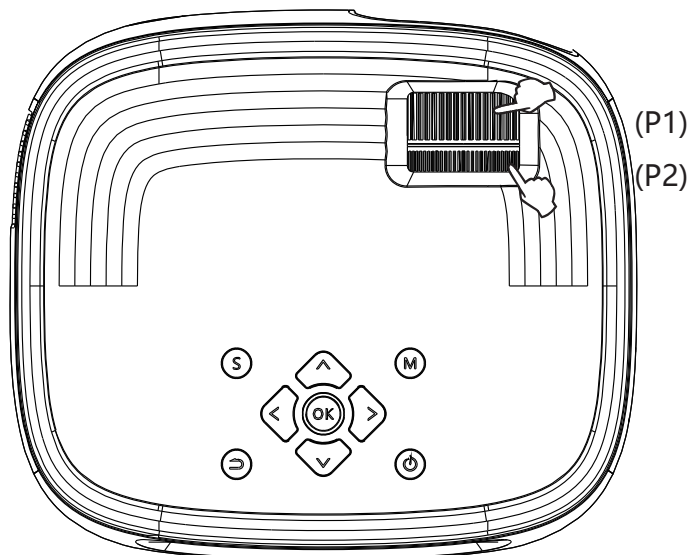





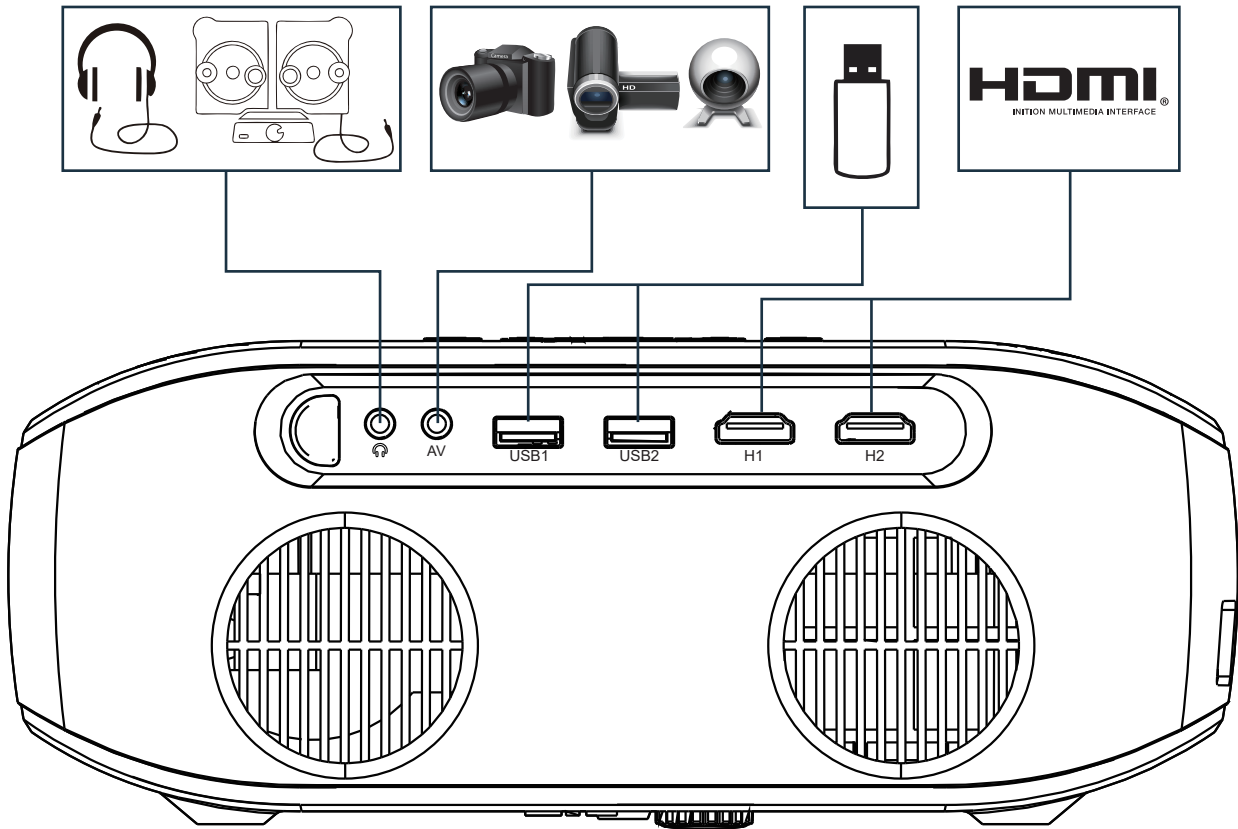

# CONNECTING



## 1. Select Signal Source

Press “**S**” of the projector or  of the remote control, enter the signal source menu. Use the arrow keys     and the “OK” to select the signal source.



# CONNECTING

## 2. Wireless Screen Mirroring

### (1) Connect Smartphone

For iPhone

① Select "Miracast" in the signal source menu of the projector and then select "IOS & Android phone".

② Swipe down from the top of the iPhone interface to enter the control center, then click "Screen Mirroring", select CLcast-\*\*\*\*, and enter PIN code: 9999 to complete the connection.

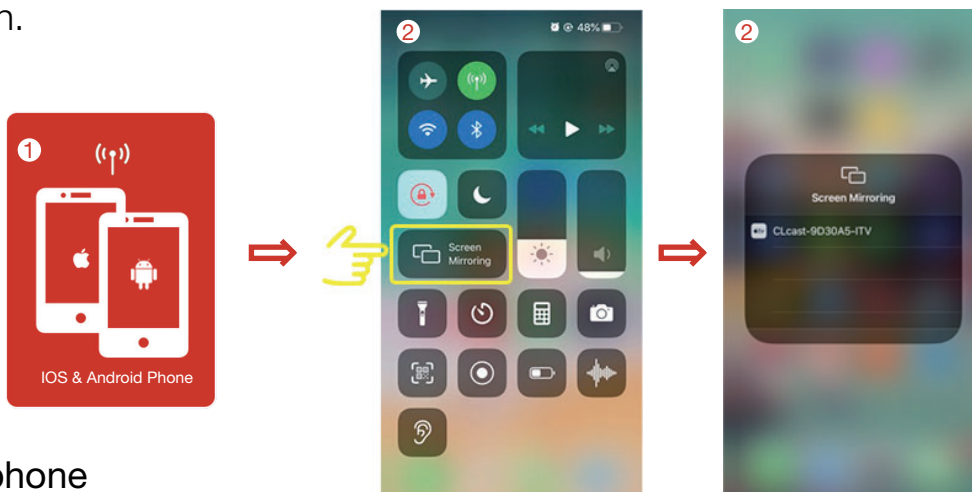

For Android phone

① Select "Miracast" in the signal source menu of the projector, and then select "IOS & Android phone".

② Slide up from the bottom of the Android phone interface to enter the control center, then click "Screen Mirroring" and select CLcast-\*\*\*\* and enter PIN code: 9999 to complete the connection.

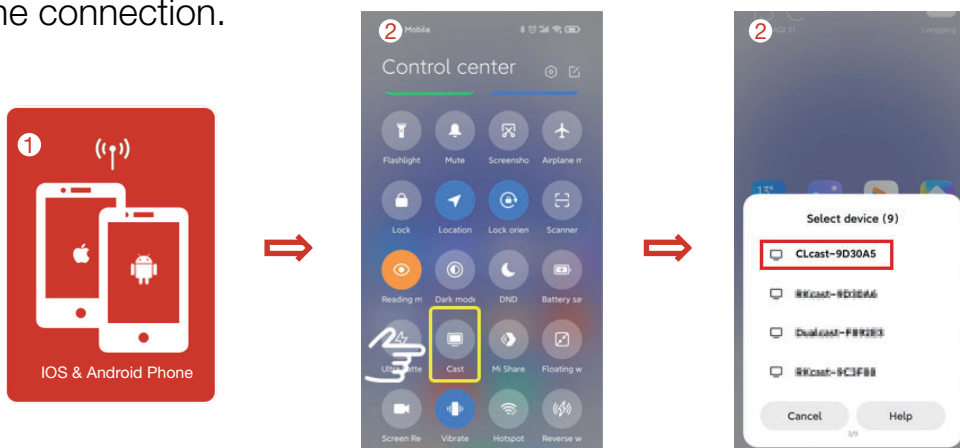

## For Google Phone

- ① Select "Miracast" in the projector's source menu, then select "Google phone"
- ② Select "next" to connect the projector to your WiFi
- ③ Connect your mobile phone to your WiFi (PS: The projector is required to be connected to the same LAN as your Google mobile phone)
- ④ Swipe down from the top of the Google phone interface to enter the control center, then click "Screen cast", select CLcast-\*\*\*\* to complete connect

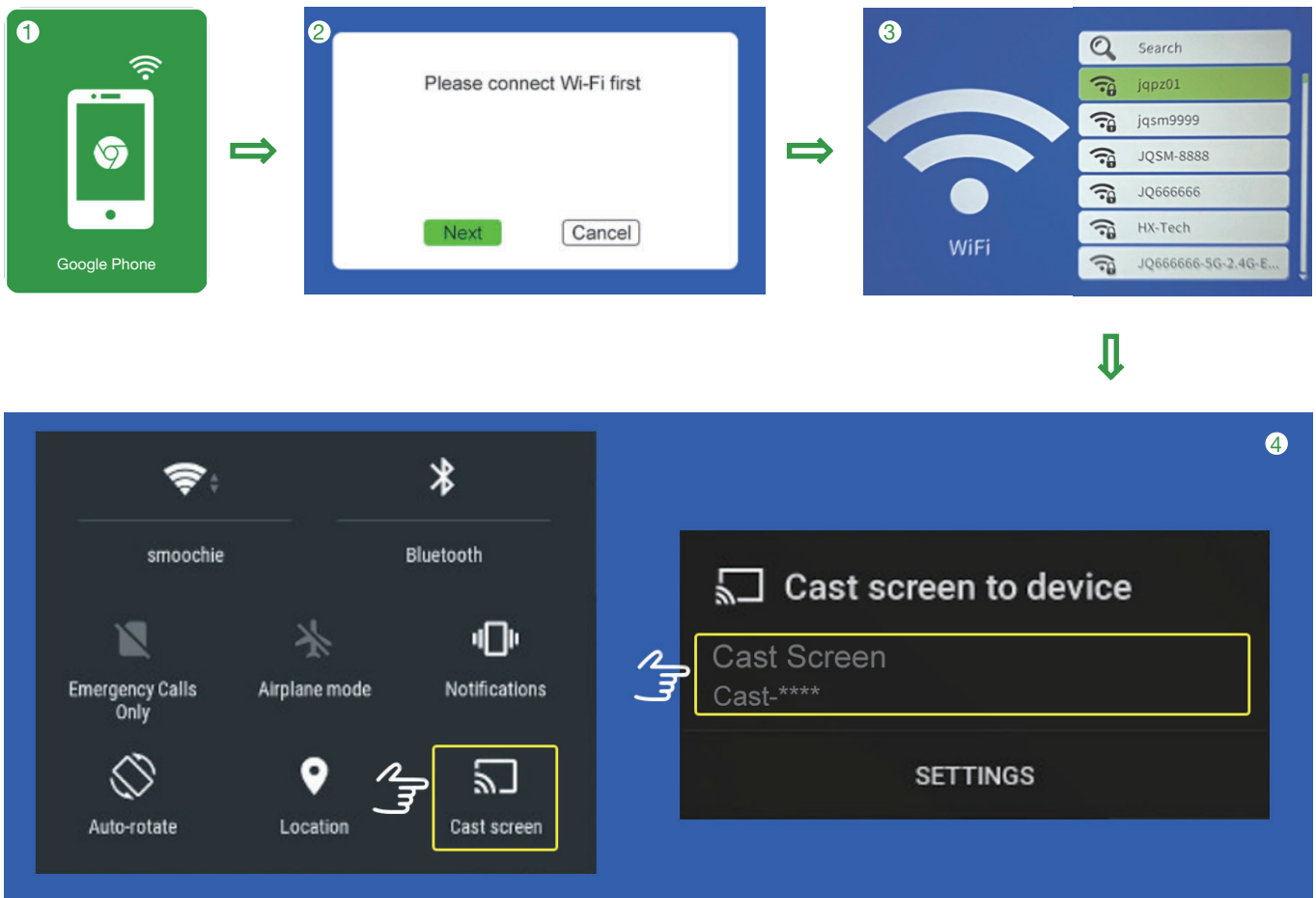

**NOTE:** If you are unable to mirror your Google phone, it may be due to Google releasing a new network connection protocol. Please contact the customer service team of your projector and request an upgrade of the system version.

# CONNECTING

## (2) For Windows devices

- ① Select "Miracast" in the source menu of the projector, and then select "Laptop".
- ② Press "Windows Key" + "P" on your Windows device,
- ③ Select "Connect to Wireless Display"
- ④ Click "CLcast-\*\*\*\*" and enter "9999" to start screen sharing.

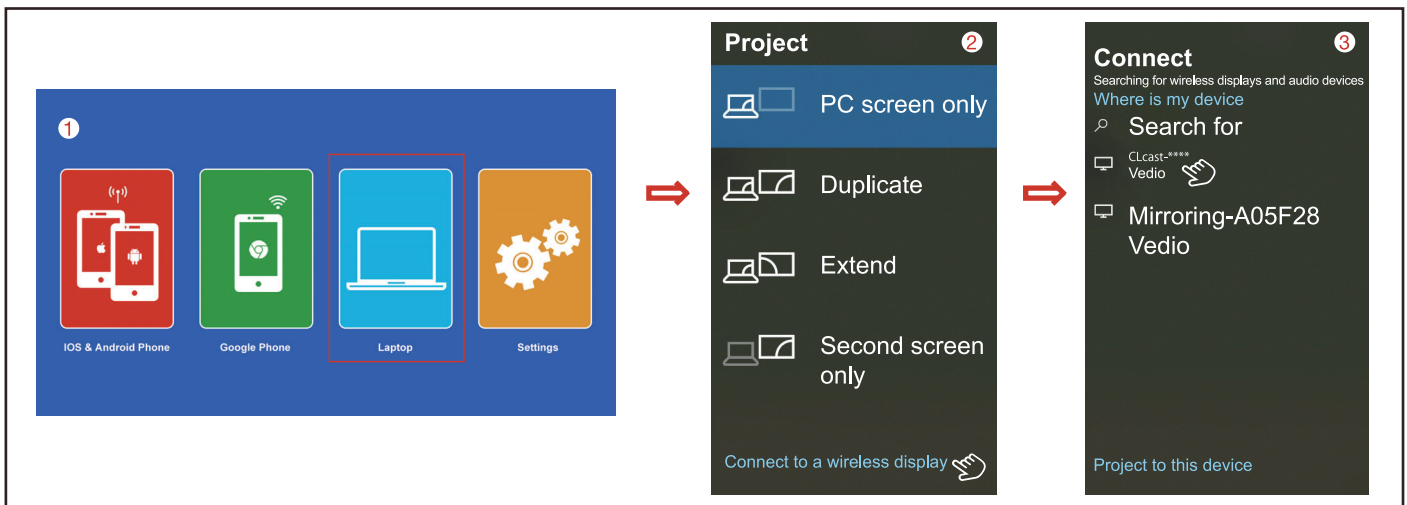

Add: Different brand laptop output keys are as follows:

Lenovo	Fn+F3
Dell	Fn+F8
HP	Fn+F4
ThinkPad	Fn+F7
Asus	Fn+F8

Acer	Fn+F5
Samsung	Fn+F4
Sony	Fn+F7
Fujitsu	Fn+F10
Haier	Fn+F3

NEC	Fn+F3
Panasonic	Fn+F3
Sharp	Fn+F5
Hitachi	Fn+F7
TOSHIBA	Fn+F5

### (3)For MacBook

- ① Select "Miracast" in the source menu of the projector, and then select "Laptop". Click the "AirPlay icon" in your Mac Dock.
- ②Click on "CLcast-\*\*\*\*" and enter "9999" to finish casting

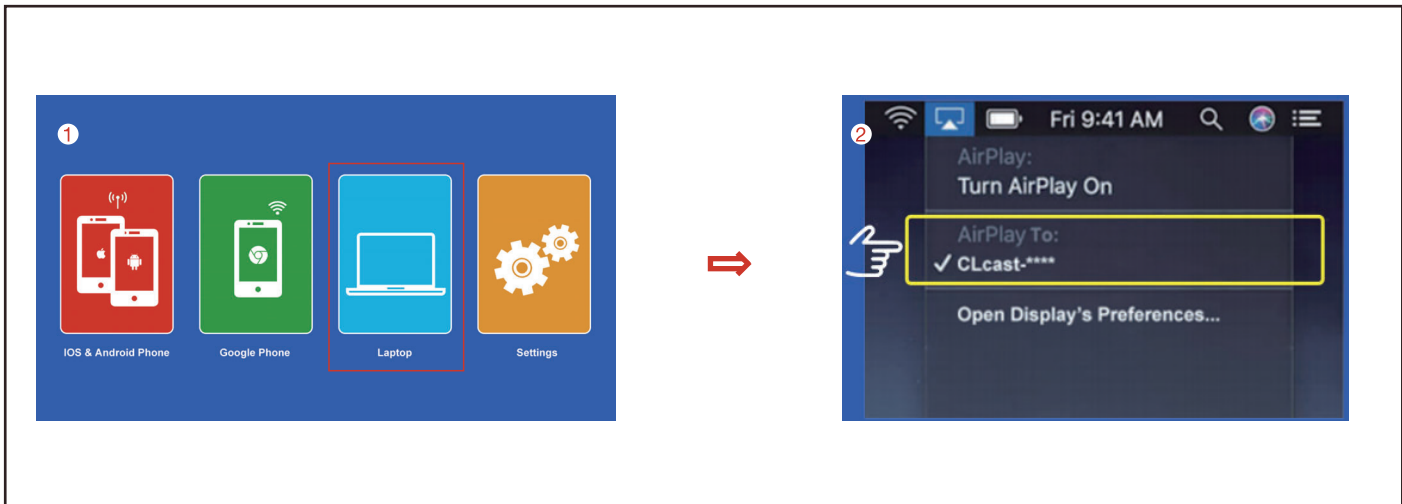

PS: If the airplay icon is not in your Mac Dock, you can enable it by selecting "Settings" (Apple menu icons) -> Show," then select "Show mirroring options in the menu bar when available"

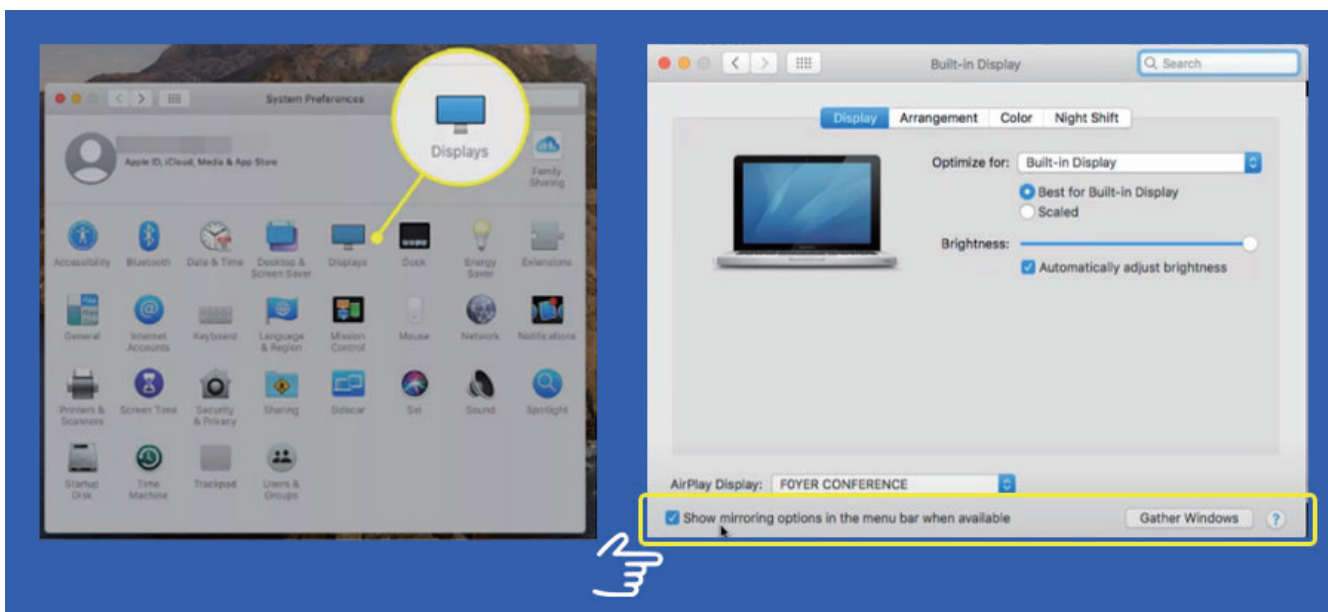

# CONNECTING

## (4) Connecting a tablet or other WiFi device

- ① Select "Miracast" in the signal source menu of the projector and then select WI-FI CONNECTION;
- ② Click next to connect the projector to your WIFI.
- ③ Connect your device to WIFI. (the same wifi as the projector)
- ④ Open Control Center on your device, select Screen Mirroring, search, and click CLcast-\*\*\*\* to complete the connection.

## 3. Connecting to HDMI Devices

The projector can connect to devices with the HDMI output function. Compatible with Laptop, DVD players, Blu-ray players, Chromecast, TV Stick, etc. (HDMI cable is included).

- ① Use the HDMI cable (included in the package) to connect the HDMI device to the projector
- ② Select media signal channel: "HDMI".

**Add: Different brand laptop output keys are as follows:**

Lenovo	Fn+F3
Dell	Fn+F8
HP	Fn+F4
ThinkPad	Fn+F7
Asus	Fn+F8

Acer	Fn+F5
Samsung	Fn+F4
Sony	Fn+F7
Fujitsu	Fn+F10
Haier	Fn+F3

NEC	Fn+F3
Panasonic	Fn+F3
Sharp	Fn+F5
Hitachi	Fn+F7
TOSHIBA	Fn+F5

The user of Windows 7 or over Windows 7. Simply press the  + P, and select duplicate to connect. If the operation above is invalid, please update the computer graphics driver.

## CONNECTING

### 4. Connect the USB drive

- ① Plug a USB drive into the USB port of the projector, and when "USB" is in the upper right corner of the projector, connect successfully.
- ② To play a video, picture, music, or text stored in a USB drive, select "Movie"/ "Photo"/ "Music"/"Text" on the main menu, and press "OK".

#### Note:

The chip of this projector is not compatible with files (Microsoft Office, PDF, and text) on the USB stick (If you want to play files, please keep the files on your laptop or DVD player, then connect this projector to them.)

### 5. Connect AV video devices

- ① Use the 3 in 1 video cable (Included in the package) to connect with AV.
- ② Choose the media signal channel: "AV".

### 6. Connect 3.5mm audio devices

Support 3.5mm earphones and other cable sound devices.

### 7. Connect Bluetooth audio

#### Warm Tips:

Bluetooth projector can only be used to connect sound devices such as speakers, headphones, sound bar, etc, not to computers or smartphone.



# CONNECTING

## How to Connect the Bluetooth Device:

When you are trying to connect to a Bluetooth device, please make sure the Bluetooth device is on and in Bluetooth pair mode before connecting.

1. Start the Projector and click on “Setting” - “OPTION” - “Bluetooth Setting” (as shown above), turn on the Bluetooth- then press “Search Bluetooth” , Bluetooth devices name will be shown below, select the right device and press the “OK key” to connect it.

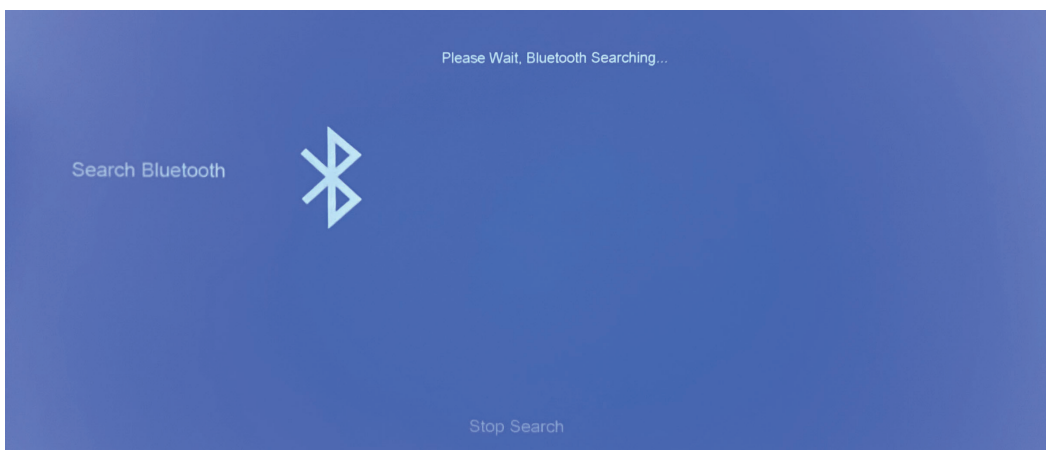
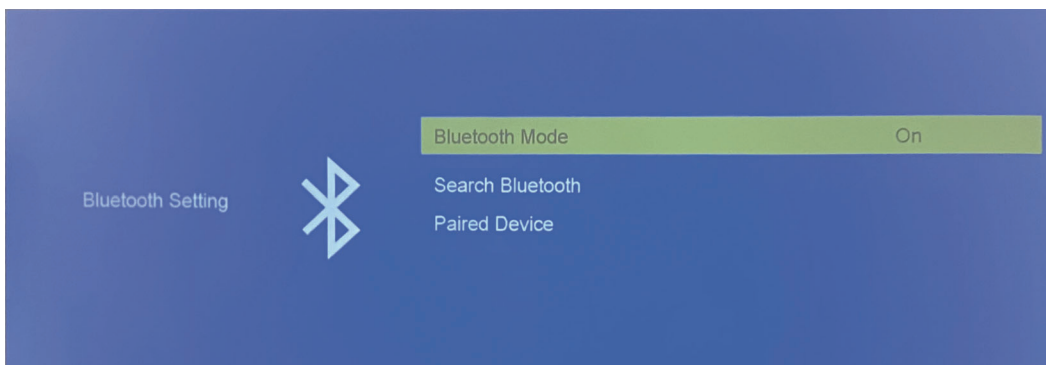
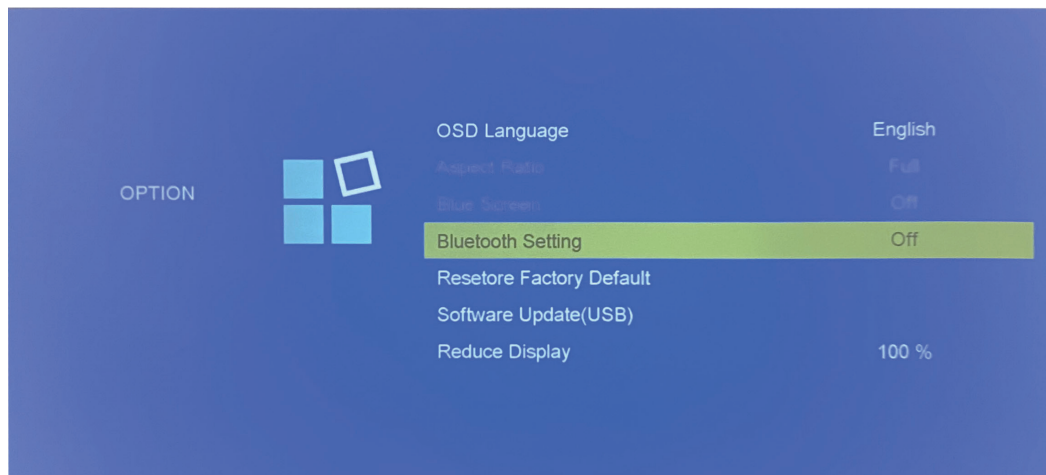



# PROJECTOR SETTING

## PICTURE MENU:

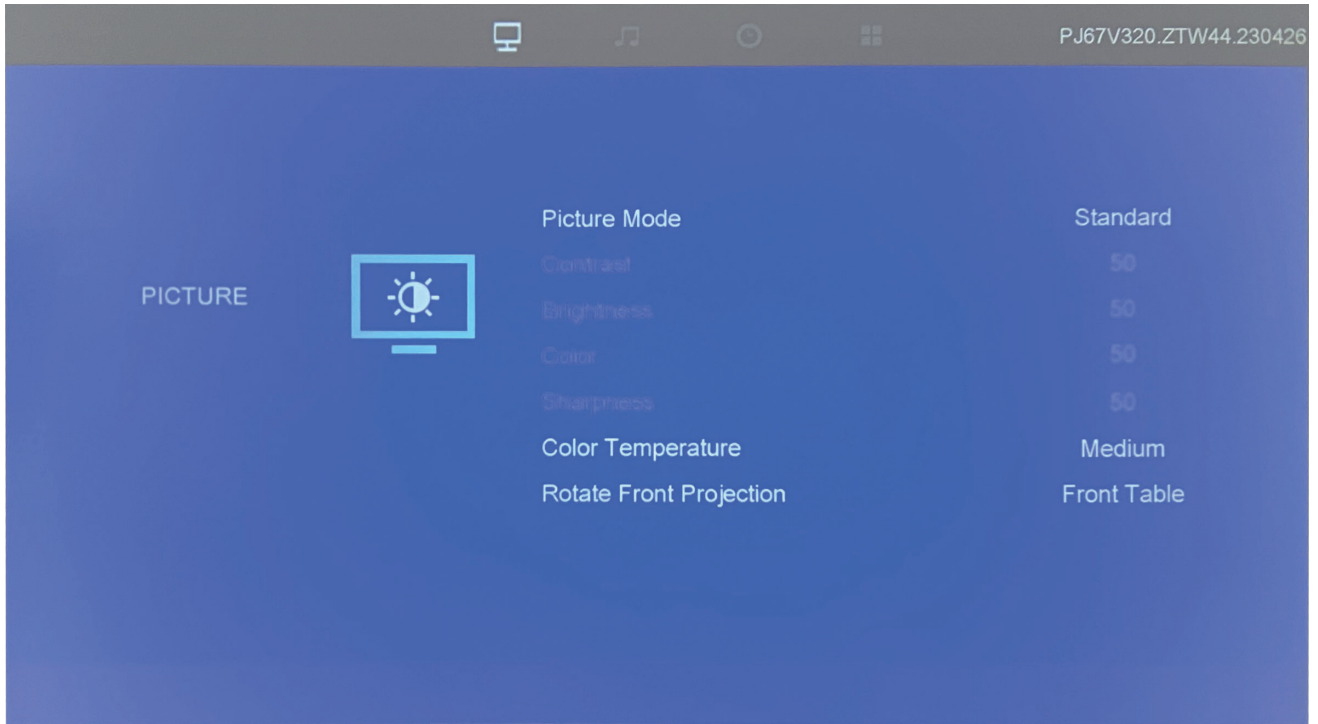

When "Picture Mode" is "User", the Contrast / Brightness / Color / Sharpness can be adjusted.

PICTURE MENU	MODE	FUNZIONE
Picture Mode	Standard,Soft,User, Vivid	Switch among the image mode
Contrast	0-100	Adjust contrast
Brightness	0-100	Adjust brightness
Color	0-100	Adjust color
Sharpness	0-100	Adjust sharpness
Color Temperature	Medium/Cool/User/warm	Switch among the color temperature mode
Rotate Front Projection	Front on Desk/Rear on Desk/ Front on Ceiling/ Rear on Ceiling	Set up the projection mode

# PROJECTOR SETTING

## SOUND MENU:

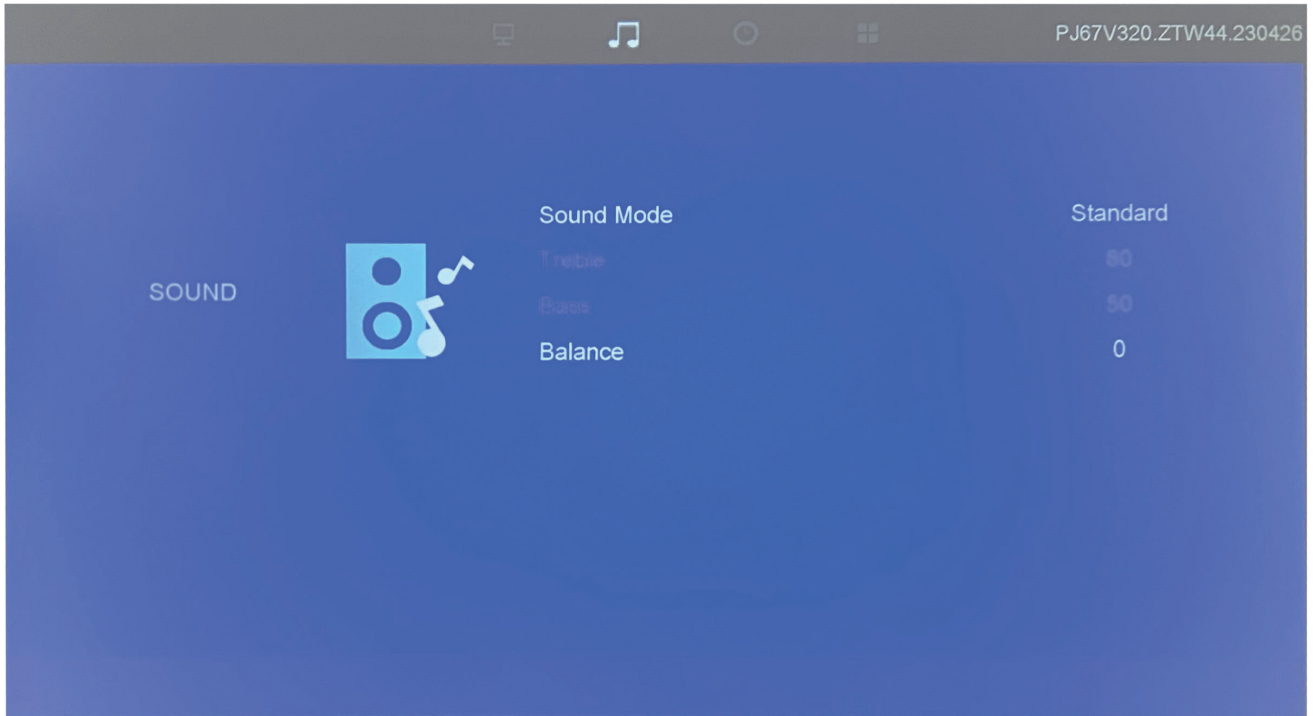

When "Sound Mode" is "User", the Treble /Bass can be adjusted.

SOUND MENU	MODE	FUNCTION
Sound Mode	Standard/Movie/Music/Sport/User	Set up the sound mode
Treble	0-100	Adjust treble
Bass	0-100	Adjust Bass
Balance	-50~50	Balance the sound of the left and right channel of the speaker

# PROJECTOR SETTING

## TIME MENU:

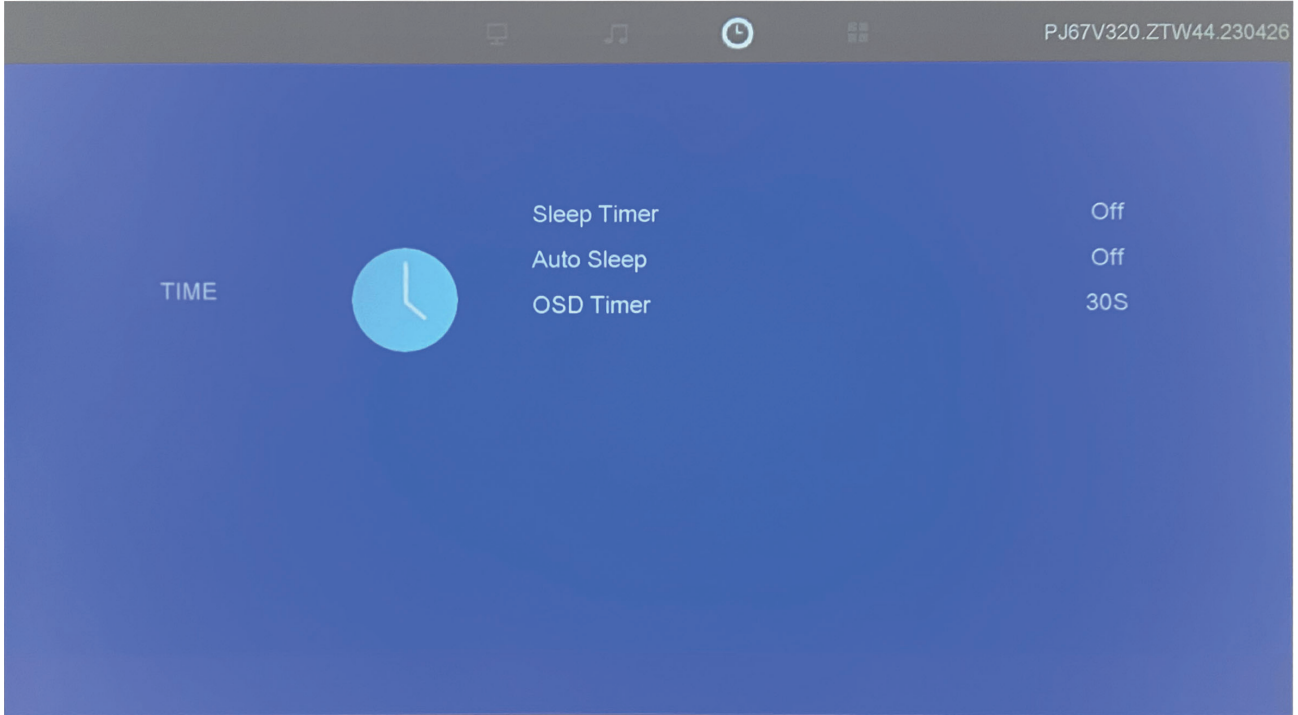

TIME MENU	MODE	FUNZIONE
Sleep Timer	Off/10/20/30/60/120/180/240min	Shut off the projector after a set amount of time
Auto Sleep	Off/3/4/5H	Set automatic sleep timer
OSD Timer	Never/5/10/15/20/25/30s	Set OSD timing

# PROJECTOR SETTING

## OPTION MENU:

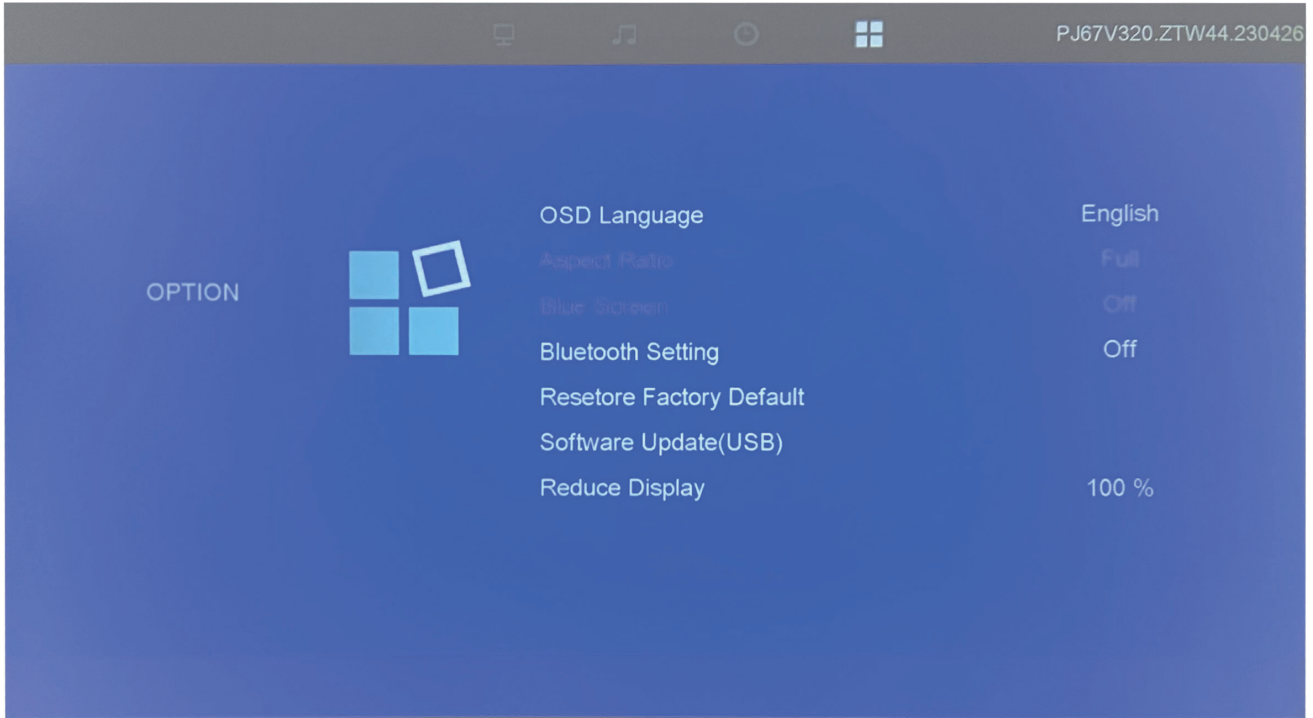

OPTION MENU	MODE	FUNZIONE
OSD Language	English/France/Italian/Spanish/etc.	Set up the language displayed in the operation
Aspect Ratio	4:3 / 16:9	
Blue Screen		No signal blue screen operation
Bluetooth Setting	ON / OFF	Connect your bluetooth device
Restore Factory Default		Reset
Software Update(USB)		Update software via usb
Reduce Display	50-100%	Reduce the projection size

# **TROUBLESHOOTING**

## **1. Why is the display of the projector available but without audio?**

- \* The Projector or the connected device (PC, DVD, etc.) is muted.
- \* Due to Dolby's copyright issues, the current regular projectors selling on Amazon do not support Dolby sound, So there will be no sound when you play Dolby sound videos, (Amazon fire stick, Netflix, Blue-ray movies, and so on) In this case, please kindly turn off the Dolby sound on your device or apps.  
(Settings > Display & Sounds > Audio > Dolby Digital Output > and then turn Dolby Digital (OFF))
- \* The audio format is not supported by the projector.
- \* Encryption applied to the videos or media player which holds the video. Try more videos to define this possibility.

## **2. Why is the audio of the projector available but without a display?**

- \* The video format is not supported by the projector.
- \* Encryption applied to the videos or media player which holds the video.
- \* If the lamp of the projector is off with only audio playing, the lamp is defective. Please contact the Customer Service Team for a replacement.
- \* Try another HDMI cable if you select the HDMI input source.

## **3. Why does the projection screen show no signal?**

- \* Make sure all cables are plugged correctly and firmly.
- \* Make sure you select the right input source. For example, if you insert a USB drive, please select USB in the interface of Input Source.

## **4. How can I do if the image is blurry or out of shape?**

- \* Adjust the focus and keystone ring by moving it leftward/rightward till it shows the best images.

- \* Place the projector on a flat surface horizontally or vertically. An inclination of any angle may result in blurry displays or uneven colors.
- \* Projecting wall or screen be clean white if possible.

### **5. How can I do if the image is upside down?**

- \* Enter Menu-Picture-Projection Direction to flip the projection image accordingly.

### **6. How can I do if the projection screen is not square or allied horizontally?**

- \* Make sure the projector is placed on a flat surface with a projector light in the middle of the screen.
- \* Make sure the projector screen is placed horizontally.

### **7. How can I do if there is color distortion?**

- \* Make sure the video source has a fine resolution.
- \* Adjust the colors: enter Menu-Picture-Color Temperature, then select different modes and adjust the value accordingly.
- \* Reset the projector to manufacturer setting: enter Menu-Option Restore Factory Default to reset.

### **8. How can I do if the remote is unresponsive?**

- \* Make sure the batteries are installed correctly and the power is enough.
- \* The remote works with the projector through the IR receiver. The remote works only when the IR receiver is within the direct reaction distance and will be unresponsive if the IR receiver is blocked or covered.

### **9. How should I do if there are small dots on display?**

- \* It may be caused during installing or shipping, please contact HONPOW to get the video about how to clean it.

## **10. Why do some lag/ jerky appear when playing video or play games?**

\* Due to the technical bottleneck of the current 1080p projectors, most of the 1080p projectors on the market cannot smoothly play 1080p/60fps videos. Hope you could understand.

Please change the 1080p/60fps to 1080p/30fps.

## **11.How to Connect and Watch Netflix?**

All projector with mirror display doesn't support playing protected video when you connect it to your smartphone directly. (Netflix, Prime Video, Hulu, etc)

Because these videos have an encryption protocol, the projector has no right to recognize when it is connected directly to the phone via the USB interface. Hope you understand. (Projector without mirror display, need an HDMI adapter if you want to connect it to your smartphone)

### **Please follow the ways below to watch Netflix**

#### **First Solution:**

You can watch Netflix via Chromecast/laptop/lv stick/Roku on our projector.

#### **Second Solution:**

You can connect the computer/ Smart TV to the projector through HDMI when playing movies from Netflix

#### **Third Solution:**

You can buy a Wireless HDMI Dongle to mirror your phone.

The reason why the fire stick or other HDMI device can play Netflix is that the HDMI interface encryption protocol includes Netflix's.

It works with youtube, chrome, safari, and Facetime when you connect it to a smartphone directly.

## 12. How to stream video from iPhone to the projector (IOS only)

Note: The projector defaults to screen mirroring mode, if you need to use Airplay, please set Airplay mode manually.

- ① Select "Miracast" in the source menu of the projector.
- ② Select "Settings".
- ③ Select and click "Mirror Setting".
- ④ Press the right button on the remote control to select Airplay.
- ⑤ Press the back button on the remote control to return to the "Miracast" menu (press the back button directly, you cannot select the cancel window), then Select "google phone".
- ⑥ Tap the airplay icon in the streaming APP, then select CLcast-\*\*\*\* in the list to complete the video streaming.

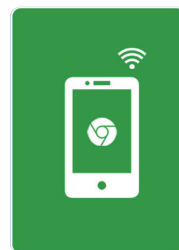
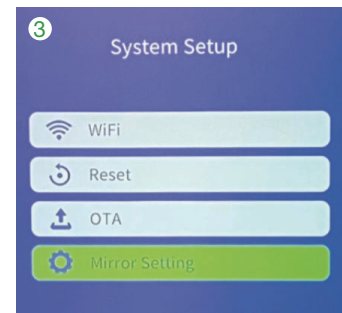
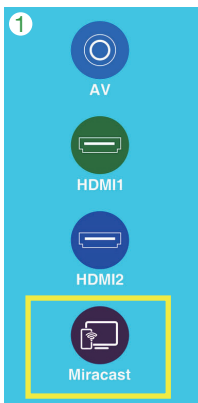

⑥ Stream the video of the streaming APP

⑤ Google Phone

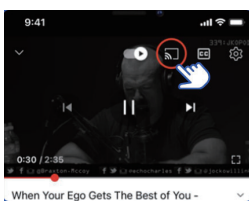

⑥ Tap the airplay window on the streaming app

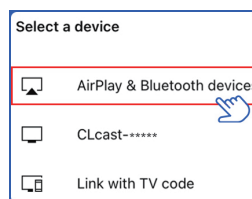

⑥ Select Airplay & Bluetooth devices in the list

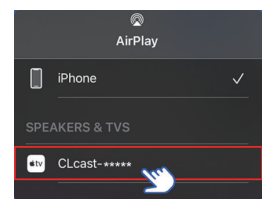

⑥ Select CLcast-\*\*\*\* in the list



## FCC WARNING

This device complies with part 15 of the FCC Rules. Operation is subject to the following two conditions: (1) this device may not cause harmful interference, and (2) this device must accept any interference received, including interference that may cause undesired operation.

Any changes or modifications not expressly approved by the party responsible for compliance could void the user's authority to operate the equipment.

NOTE: This equipment has been tested and found to comply with the limits for a Class B digital device, pursuant to Part 15 of the FCC Rules. These limits are designed to provide reasonable protection against harmful interference in a residential installation. This equipment generates, uses and can radiate radio frequency energy and, if not installed and used in accordance with the instructions, may cause harmful interference to radio communications.

However, there is no guarantee that interference will not occur in a particular installation. If this equipment does cause harmful interference to radio or television reception, which can be determined by turning the equipment off and on, the user is encouraged to try to correct the interference by one or more of the following measures:

- Reorient or relocate the receiving antenna.
- Increase the separation between the equipment and receiver.
- Connect the equipment into an outlet on a circuit different from that to which the receiver is connected.
- Consult the dealer or an experienced radio/TV technician for help.

To maintain compliance with FCC's RF Exposure guidelines, This equipment should be installed and operated with minimum 20cm distance between the radiator and your body: Use only the supplied antenna.