

TEST REPORT

KOSTEC CO., Ltd. 28(175-20, Annyeong-dong) 406-gil sejaro, Hwaseong-si, Gyeonggi-do, Korea Tel:031-222-4251, Fax:031-222-4252	Report No.: KST-FCR-180022(1)	 KOSTEC Co., Ltd. http://www.kostec.org
---	-------------------------------	--

1. Applicant

- Name : SMARTCORE Inc.
- Address : #801, KRANZ TECHNO, 388, Dunchon-daero, Jungwon-gu, Seongnam-si, South Korea

2. Test Item

- Product Name: e-Passport Reader
- Model Name: FASTpass P1U
- Family Model: FASTpass P1R, TDK 900, TDR 900
- Brand: None
- FCC ID: 2ARUNFASTPASS1U

3. Manufacturer

- Name : SMARTCORE Inc.
- Address : #801, KRANZ TECHNO, 388, Dunchon-daero, Jungwon-gu, Seongnam-si, South Korea

4. Date of Test : 2018. 11. 23. ~ 2018. 11. 26.

5. Test Method Used : FCC CFR 47, Part 15. Subpart C-15.225

6. Test Result : Compliance

7. Note: -

Supplementary Information

The device bearing the brand name and FCC ID specified above has been shown to comply with the applicable technical standards as indicated in the measurement report and was tested in accordance with measurement procedures specified in ANSI C 63.10-2013.

We attest to the accuracy of data and all measurements reported herein were performed by KOSTEC Co., Ltd. and were made under Chief Engineer's supervision. We assume full responsibility for the completeness of these measurements and vouch for the qualifications of all persons taking them.

The results shown in this test report refer only to the sample(s) tested unless otherwise stated.

This test report is not related to KOLAS accreditation.

Affirmation	Tested by Name : Choo, Kwang-Yeol (Signature)	Technical Manager Name : Park, Gyeong-Hyeon (Signature)
-------------	--	--

2018. 11. 29.

KOSTEC Co., Ltd.



Table of Contents

1. GENERAL INFORMATION	3
1.1 Test Facility	3
1.2 Location	3
1.3 Revision History of test report	4
2. EQUIPMENT DESCRIPTION	5
3. SYSTEM CONFIGURATION FOR TEST	6
3.1 Characteristics of equipment	6
3.2 Used peripherals list	6
3.3 Product Modification	6
3.4 Operating Mode	6
3.5 Test Setup of EUT	6
3.6 Used Test Equipment List	7
4. SUMMARY TEST RESULTS	9
5. MEASUREMENT RESULTS	10
5.1 Carrier Frequency tolerance	10
5.2 Field strength of radiated emissions	11
5.3 Antenna requirement	17
5.4 AC Power Conducted emissions	18
5.5 20 dB bandwidth measurement	23

1. GENERAL INFORMATION

1.1 Test Facility

Test laboratory and address

KOSTEC Co., Ltd.
128(175-20,Annyeong-dong)406-gil sejaro, Hwaseong-si Gyeonggi-do, Korea

Registration information

KOLAS No. : 232
FCC Designation No. : KR0041
IC Registration Site No. : 8305A-1

1.2 Location

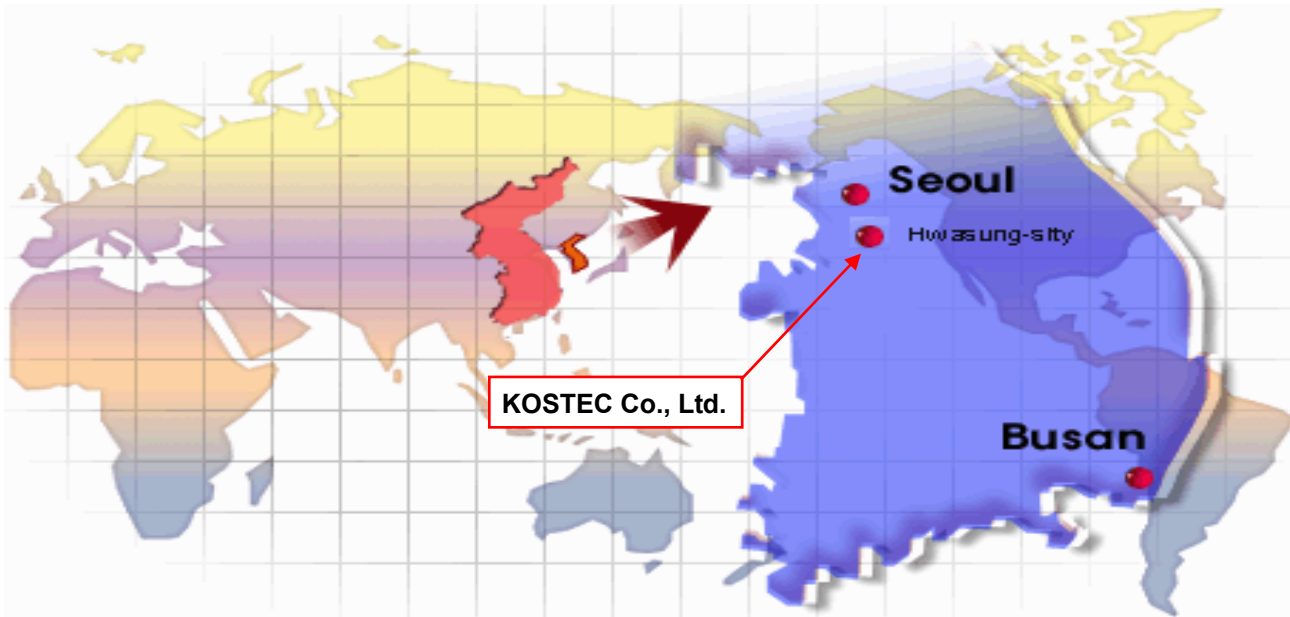



1.3 Revision History of test report

Rev.	Revisions	Effect page	Reviewed	Date
-	Initial issue	All	Gyeong Hyeon, Park	2018. 11. 27.
1	Added the calibration dates and calibration expiration dates	7, 8	Gyeong Hyeon, Park	2018. 11. 29.

2. EQUIPMENT DESCRIPTION

The product specification described herein was declared by manufacturer. And refer to user's manual for the details.

Equipment Name	e-Passport Reader
Model No	FASTpass P1U
Family Model	FASTpass P1R, TDK 900
Usage	e-Passport Reader
Serial Number	Proto type
Modulation type	ASK
Oscillation Type	X-tal
Maximum output power	26.74 dB μ W/m @ 30 meter
Operated Frequency	13.56 MHz
Channel Number	1
Operation temperature	-20 °C - + 50 °C
Power Source	AC/DC Adaptor, output: DC 12 V
Antenna Description	Internal PCB antenna
Remark	<ol style="list-style-type: none"> 1. The device was operating at its maximum output power for all measurements. 2. The radiation measurements are performed in X, Y, Z axis positioning. Only the worst case (Y) is shown in the report. 3. The above DUT's information was declared by manufacturer. Please refer to the specifications or user manual for more detailed description.
FCC ID	2ARUNFASTPASSP1U

3. SYSTEM CONFIGURATION FOR TEST

3.1 Characteristics of equipment

The Equipment Under Test (EUT) contains the following capabilities: This equipment is e-Passport Reader. The detailed explanation is refer as user manual.

3.2 Used peripherals list

Description	Model No.	Serial No.	Manufacture	Remark
Notebook	BCM-1063	2Z7S1Z1	Dell Inc	-
Adapter	DA65NM111-00	None	Dell Inc	-
Notebook	NT300E4S	0T4391JJ800909K	Samsung Electronics	-

3.3 Product Modification

N/A

3.4 Operating Mode

Constantly transmitting with a modulated carrier at maximum power.

3.5 Test Setup of EUT

The measurements were taken in continuous transmit mode using the test mode which controlled by FASTpass.exe. The test program and the cables were provided by the applicant.

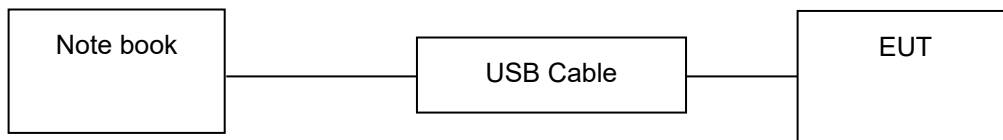

3.6 Used Test Equipment List

No.	Instrument	Model	S/N	Manufacturer	Due to cal date	Cal interval	used
1	T & H Chamber	RCT-V-THC-403-1(H)	20030210	R.C.T	2019.09.03	1 year	<input type="checkbox"/>
2	T & H Chamber	SH-641	92006831	ESPEC CORP	2019.02.14	1 year	<input checked="" type="checkbox"/>
3	Spectrum Analyzer	8593E	3710A02859	Agilent Technology	2019.02.01	1 year	<input type="checkbox"/>
4	Spectrum Analyzer	8563EC	3046A00527	Agilent Technology	2019.02.01	1 year	<input type="checkbox"/>
5	Signal Analyzer	FSV13	101247	Rohde & Schwarz	2019.02.01	1 year	<input type="checkbox"/>
6	Spectrum Analyzer	FSV30	20-353063	Rohde& Schwarz	2019.02.01	1 year	<input checked="" type="checkbox"/>
7	Signal Analyzer	N9010A	MY56070441	Agilent Technologies	2019.05.25	1 year	<input type="checkbox"/>
8	EMI Test Receiver	ESCI7	100823	Rohde& Schwarz	2019.01.29	1 year	<input type="checkbox"/>
9	EMI Test Receiver	ESI	837514/004	Rohde& Schwarz	2019.09.03	1 year	<input type="checkbox"/>
10	Vector Signal Analyzer	89441A	3416A02620	Agilent Technology	2019.02.01	1 year	<input type="checkbox"/>
11	Network Analyzer	8753ES	US39172348	AGILENT	2019.09.03	1 year	<input type="checkbox"/>
12	EPM Series Power meter	E4418B	GB39512547	Agilent Technology	2019.01.31	1 year	<input type="checkbox"/>
13	RF Power Sensor	E9300A	MY41496631	Agilent Technology	2019.01.31	1 year	<input type="checkbox"/>
14	Microwave Frequency Counter	5352B	2908A00480	Agilent Technology	2019.01.30	1 year	<input type="checkbox"/>
15	Audio Analyzer	8903B	3514A16919	Agilent Technology	2019.01.30	1 year	<input type="checkbox"/>
16	Audio Telephone Analyzer	DD-5601CID	520010281	CREDIX	2019.01.30	1 year	<input type="checkbox"/>
17	Modulation Analyzer	8901A	3041A0576	H.P	2019.01.31	1 year	<input type="checkbox"/>
18	Digital storage Oscilloscope	TDS3052	B015962	Tektronix	2019.09.04	1 year	<input type="checkbox"/>
19	ESG-D Series Signal Generator	E4436B	US39260458	Agilent Technology	2019.01.31	1 year	<input type="checkbox"/>
20	Vector Signal Generator	SMBV100A	257557	Rohde & Schwarz	2019.01.31	1 year	<input type="checkbox"/>
21	GNSS Signal Generator	TC-2800A	2800A000494	TESCOM CO., LTD.	2019.02.01	1 year	<input type="checkbox"/>
22	Signal Generator	SMB100A	179628	Rohde & Schwarz	2019.05.09	1 year	<input type="checkbox"/>
23	Tracking Source	85645A	070521-A1	Agilent Technology	2019.02.01	1 year	<input type="checkbox"/>
24	SLIDAC	None	0207-4	Myoung sung Ele.	2019.01.29	1 year	<input type="checkbox"/>
25	DC Power supply	DRP-5030	9028029	Digital Electronic Co.,Ltd	2019.01.29	1 year	<input type="checkbox"/>
26	DC Power supply	6038A	3440A12674	Agilent Technology	2019.01.29	1 year	<input type="checkbox"/>
27	DC Power supply	E3610A	KR24104505	Agilent Technology	2019.01.29	1 year	<input type="checkbox"/>
28	DC Power supply	UP-3005T	68	Unicon Co.,Ltd	2019.01.29	1 year	<input type="checkbox"/>
29	DC Power Supply	SM 3400-D	114701000117	DELTAELEKTRONIKA	2019.01.29	1 year	<input type="checkbox"/>
30	DC Power supply	6632B	MY43004005	Agilent Technology	2019.01.31	1 year	<input type="checkbox"/>
31	DC Power Supply	6632B	MY43004137	Agilent Technology	2019.01.31	1 year	<input checked="" type="checkbox"/>
32	Termination	1433-3	LM718	WEINSCHEL	2019.07.09	1 year	<input type="checkbox"/>
33	Termination	1432-3	QR946	AEROFLEX/WEINSCHEL	2019.07.09	1 year	<input checked="" type="checkbox"/>
34	Attenuator	24-30-34	BX5630	Aeroflex / Weinschel	2018.12.15	1 year	<input type="checkbox"/>
35	Attenuator	8498A	3318A09485	HP	2019.01.31	1 year	<input type="checkbox"/>
36	Step Attenuator	8494B	3308A32809	HP	2019.01.31	1 year	<input type="checkbox"/>
37	Attenuator	18B50W-20F	64671	INMET	2019.01.31	1 year	<input type="checkbox"/>
38	Attenuator	10 dB	1	Rohde & Schwarz	2019.05.04	1 year	<input type="checkbox"/>
39	Attenuator	10 dB	2	Rohde & Schwarz	2019.05.04	1 year	<input type="checkbox"/>
40	Attenuator	10 dB	3	Rohde & Schwarz	2019.05.04	1 year	<input type="checkbox"/>
41	Attenuator	10 dB	4	Rohde & Schwarz	2019.05.04	1 year	<input type="checkbox"/>
42	Attenuator	54A-10	74564	WEINSCHEL	2019.09.04	1 year	<input type="checkbox"/>
43	Attenuator	56-10	66920	WEINSCHEL	2019.05.09	1 year	<input type="checkbox"/>
44	Attenuator	48-20-11	BV2658	Aeroflex/Weinschel	2019.08.06	1 year	<input type="checkbox"/>
45	Attenuator	48-30-33-LIM	BL5350	Weinschel Corp.	2019.07.09	1 year	<input type="checkbox"/>
46	Power divider	11636B	51212	HP	2019.02.01	1 year	<input type="checkbox"/>
47	3Way Power divider	KPDSU3W	00070365	KMW	2019.09.03	1 year	<input type="checkbox"/>
48	4Way Power divider	70052651	173834	KRYTAR	2019.02.01	1 year	<input type="checkbox"/>
49	3Way Power divider	1580	SQ361	WEINSCHEL	2019.05.09	1 year	<input type="checkbox"/>

No.	Instrument	Model	S/N	Manufacturer	Due to cal date	Cal interval	used
50	OSP	OSP120	101577	Rohde & Schwarz	2019.05.04	1 year	<input type="checkbox"/>
51	White noise audio filter	ST31EQ	101902	SoundTech	2019.09.04	1 year	<input type="checkbox"/>
52	Dual directional coupler	778D	17693	HEWLETT PACKARD	2019.01.31	1 year	<input type="checkbox"/>
53	Dual directional coupler	772D	2839A00924	HEWLETT PACKARD	2019.01.31	1 year	<input type="checkbox"/>
54	Band rejection filter	3TNF-0006	26	DOVER Tech	2019.02.01	1 year	<input type="checkbox"/>
55	Band rejection filter	3TNF-0007	311	DOVER Tech	2019.02.01	1 year	<input type="checkbox"/>
56	Band rejection filter	WTR-BRF2442-84NN	09020001	WAVE TECH Co.,LTD	2019.01.31	1 year	<input type="checkbox"/>
57	Band rejection filter	WRCJV12-5695-5725-5825-5855-50SS	1	Wainwright Instruments GmbH	2019.05.04	1 year	<input type="checkbox"/>
58	Band rejection filter	WRCJV12-5120-5150-5350-5380-40SS	4	Wainwright Instruments GmbH	2019.05.04	1 year	<input type="checkbox"/>
59	Band rejection filter	WRCGV10-2360-2400-2500-2540-50SS	2	Wainwright Instruments GmbH	2019.05.04	1 year	<input type="checkbox"/>
60	Band rejection filter	CTF-155M-S1	001	RF One Electronics	2019.09.06	1 year	<input type="checkbox"/>
61	Band rejection filter	CTF-435M-S1	001	RF One Electronics	2019.09.06	1 year	<input type="checkbox"/>
62	Highpass Filter	WHJS1100-10EF	1	WAINWRIGHT	2019.01.31	1 year	<input type="checkbox"/>
63	Highpass Filter	WHJS3000-10EF	1	WAINWRIGHT	2019.01.31	1 year	<input type="checkbox"/>
64	Highpass Filter	WHNX6-5530-7000-26500-40CC	2	Wainwright Instruments GmbH	2019.05.09	1 year	<input type="checkbox"/>
65	Highpass Filter	WHNX6-2370-3000-26500-40CC	4	Wainwright Instruments GmbH	2019.05.09	1 year	<input type="checkbox"/>
66	WideBand Radio Communication Tester	CMW500	102276	Rohde & Schwarz	2019.02.01	1 year	<input type="checkbox"/>
67	Radio Communication Tester	CMU 200	112026	Rohde & Schwarz	2019.01.31	1 year	<input type="checkbox"/>
68	Bluetooth Tester	TC-3000B	3000B6A0166	TESCOM CO., LTD.	2019.01.31	1 year	<input type="checkbox"/>
69	Loop Antenna	6502	9203-0493	EMCO	2019.05.29	2 year	<input checked="" type="checkbox"/>
70	BiconiLog Antenna	3142B	1745	EMCO	2020.05.10	2 year	<input checked="" type="checkbox"/>
71	Biconical Antenna	VUBA9117	9117-342	Schwarz beck	2020.03.12	2 year	<input type="checkbox"/>
72	Trilog-Broadband Antenna	VULB 9168	9168-606	SCHWARZBECK	2020.09.14	2 year	<input type="checkbox"/>
73	Horn Antenna	3115	2996	EMCO	2020.02.14	2 year	<input type="checkbox"/>
74	Horn Antenna	3115	9605-4834	EMCO	2020.03.12	2 year	<input type="checkbox"/>
75	Horn Antenna	BBHA9170	743	SCHWARZBECK	2019.04.25	2 year	<input type="checkbox"/>
76	Antenna Master(3)	AT13	None	AUDIX	N/A	N/A	<input type="checkbox"/>
77	Turn Table(3)	None	None	AUDIX	N/A	N/A	<input type="checkbox"/>
78	PREAMPLIFIER(3)	8449B	3008A02577	Agilent	2019.02.02	1 year	<input type="checkbox"/>
79	Antenna Master(10)	MA4000-EP	None	innco systems GmbH	N/A	N/A	<input checked="" type="checkbox"/>
80	Turn Table(10)	None	None	innco systems GmbH	N/A	N/A	<input checked="" type="checkbox"/>
81	AMPLIFIER(10)	TK-PA6S	120009	TESTEK	2019.01.29	1 year	<input checked="" type="checkbox"/>
82	AMPLIFIER	TK-PA18	150003	TESTEK	2019.05.04	1 year	<input type="checkbox"/>
83	AMPLIFIER	TK-PA1840H	160010-L	TESTEK	2019.04.27	1 year	<input type="checkbox"/>
84	AMPLIFIER	8447D	2944A07881	H.P	2019.01.29	1 year	<input type="checkbox"/>
85	Antenna Mast	MA2000-EP	None	innco systems GmbH	N/A	N/A	<input type="checkbox"/>
86	Turn Device	DE3700-RH	None	innco systems GmbH	N/A	N/A	<input type="checkbox"/>

4. SUMMARY TEST RESULTS

Description of Test	FCC Rule	Reference Clause	Used	Test Result
Carrier frequency tolerance	15.225(e)	Clause 5.1	<input checked="" type="checkbox"/>	Compliance
Field strength of radiated emission	15.225(a) ~ (d)	Clause 5.2	<input checked="" type="checkbox"/>	Compliance
AC Conducted emission	15.207	Clause 5.3	<input checked="" type="checkbox"/>	Compliance
Antenna requirement	15.203, 15.247	Clause 5.4	<input checked="" type="checkbox"/>	Compliance
20 dB bandwidth measurement	2.1049	Clause 5.5	<input checked="" type="checkbox"/>	Compliance
<p>Compliance/pass : The EUT complies with the essential requirements in the standard. Not Compliance : The EUT does not comply with the essential requirements in the standard. N/A : The test was not applicable in the standard.</p>				

Procedure Reference

FCC CFR 47, Part 15. Subpart C-15.225

ANSI C 63.10-2013

5. MEASUREMENT RESULTS

5.1 Carrier Frequency tolerance

5.1.1 Standard Applicable [FCC §15.225(e)]

The frequency tolerance of the carrier signal shall be maintained within +/- 0.01% of the operating frequency Over a temperature variation of - 20 degrees to + 50 degrees C at normal supply voltage, and for a variation In the primary supply from 85 % to 115 % of the rated supply voltage at a temperature of 20 degrees C. For battery operated equipment, the equipment tests shall be performed using a new battery.

5.1.2 Test Environment conditions

- Ambient temperature : (22 - 23) °C
- Relative Humidity : (50 - 52) % R.H.

5.1.3 Measurement Procedure

Before measurements are made the equipment shall have reached thermal balance in the Test chamber period. and then it is normal operating for about 15 minutes after thermal balance has been reached. For tests at the extreme temperature, the equipment shall be left in the test chamber until thermal balance is attained, then the standby or receive condition for a period of a few minute after which the equipment shall meet the specified requirements. The test data sheet recorded measured value by frequency counter.

5.1.4 Test setup

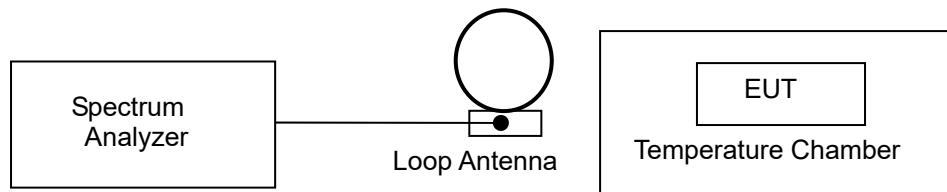

5.1.5 Measurement Result

Frequency (13.56 MHz)		Measured frequency [Hz]	Frequency Tolerance	
			%	Hz
T _{NOM} + 22 °C	V _{NOM} 12.0 Vdc	13.560 406	0.0030	406
	V _{MIN} 10.2 Vdc	13.560 411	0.0030	411
	V _{MAX} 13.8 Vdc	13.560 409	0.0030	409
T _{MIN} -20 °C	V _{NOM} 12.0 Vdc	13.560 435	0.0032	435
T _{MAX} +55 °C	V _{NOM} 12.0 Vdc	13.560 401	0.0030	401
Limit		Within in (±) 0.01 % or (±) 1 356 Hz		
Max. Tolerance		0.0032 %, (±)435 Hz		
Result		Compliance		

5.2 Field strength of radiated emissions

5.2.1 Standard Applicable [FCC §15.225 (a) ~ (d)]

(a) The Field strength of any emissions within the band 13.553-13.567 MHz shall not exceed 15,848 $\mu\text{V}/\text{m}$ at 30 meter

(b) Within the bands 13.410-13.553 MHz and 13.567-13.710 MHz, the field strength of any emissions shall not exceed 334 micro volts/meter at 30 meter

(c) Within the bands 13.110-13.410 MHz and 13.710-14.010 MHz, the field strength of any emissions shall not exceed 106 micro volts/meter at 30 meter

(d) The Field strength of any emissions appearing outside of the 13.110-14.010 MHz band shall not exceed The general radiated emission limits in §15.209

Above required standard (a ~ c) and (d) is brief describe table as follows

§ 15.225 [(a) ~(c)] : Limit for in-band field strength

Frequency Band (MHz)	Limit		Measurement distance (meter)
	($\mu\text{V}/\text{m}$)	(dB $\mu\text{V}/\text{m}$)	
13.553 – 13.567	15,848	84.00	30
13.410 – 13.553 13.567 – 13.710	334	50.47	30
13.110 – 13.410 13.710 – 14.010	106	40.50	30

§15.209. limits for radiated emissions measurements

Frequency Band	Limit [$\mu\text{V}/\text{m}$]	Limit [dB $\mu\text{V}/\text{m}$]	Measurement distance (meter)	Detector
0.009 – 0.490	2 400/F (kHz)	-	300	
0.490 – 1.705	2 4000/F (kHz)	-	30	
1.705 – 30.0	30	29.54	30	Quasi peak
30 - 88	100 **	40.0	3	Quasi peak
88 - 216	150 **	43.5	3	Quasi peak
216 - 960	200 **	46.0	3	Quasi peak
Above 960	500	54.0	3	Peak & Average

** fundamental emissions from intentional radiators operation under this Section shall not be located in the frequency bands 54-72 MHz, 76-88 MHz, 174-216 MHz, or 470-806 MHz. However, operation within these Frequency bands is permitted under other sections of this Part Section 15.231 and 15.241

§15.205. Restrict Band of Operation

Only spurious emissions are permitted in any of the frequency bands listed below ;

[Mhz]	[Mhz]	[Mhz]	[GHz]
0.090 - 0.110	16.42 - 16.423	399.9 - 410	4.5 - 5.15
0.495 - 0.505**	16.69475 - 16.69525	608 - 614	5.35 - 5.46
2.1735 - 2.1905	16.80425 - 16.80475	960 - 1240	7.25 - 7.75
4.125 - 4.128	25.5 - 25.67	1300 - 1427	8.025 - 8.
4.17725 - 4.17775	37.5 - 38.25	1435 - 1626.5	9.0 - 9.2
4.20725 - 4.20775	73 - 74.6	1645.5 - 1646.5	9.3 - 9.5
6.215 - 6.218	74.8 - 75.2	1660 - 1710	10.6 - 12.7
6.26775 - 6.26825	108 - 121.94	1718.8 - 1722.2	13.25 - 13.
6.31175 - 6.31225	123 - 138	2200 - 2300	14.47 - 14.5
8.291 - 8.294	149.9 - 150.05	2310 - 2390	15.35 - 16.2
8.362 - 8.366	156.52475 - 156.52525	2483.5 - 2500	17.7 - 21.4
8.37625 - 8.38675	156.7 - 156.9	2690 - 2900	22.01 - 23.12
8.41425 - 8.41475	162.0125 - 167.17	3260 - 3267	23.6 - 24.0
12.29 - 12.293	167.72 - 173.2	3332 - 3339	31.2 - 31.8
12.51975 - 12.52025	240 - 285	3345.8 - 3358	36.43 - 36.5
12.57675 - 12.57725	322 - 335.4	3600 - 4400	Above 38.6

** Until February 1, 1999, this restricted band shall be 0.490-0.510

5.2.2 Test Environment conditions

- Ambient temperature : (19 - 21) °C
- Relative Humidity : (36 - 37) % R.H.

5.2.3 Measurement Procedure

The measurements procedure of the transmitter radiated E-field is as following describe method.

The test is performed in a Shield chamber to determine the accurate frequencies, after maximum emissions level will be checked on a test chamber and measuring distance is 3 m from EUT to test antenna.

(The chamber is ensured that comply with at least 6 dB above the ambient noise level)

- ① The EUT was powered ON with continuously operating mode and placed on a 0.8 meter high non-conductive table on the reference ground plane.
- ② The test antenna was used on Horn antenna for above 1 GHz, and if the below 1 GHz, broad-band antenna and Loop antenna were used for below 30 MHz and it's antenna positioned in both the horizontal and vertical plane was location at EUT during the test for maximized the emission measurement.
- ③ The output of the test antenna will be connected to a measuring receiver, and it is set to tuned over the frequency range according to required standard
- ④ The measuring detector type of the measurement receiver is based on average value of measurement instrumentation employing a CISPR Quasi Peak detector according to required standard and for above 1 GHz, set the spectrum analyzer on a average and peak detector for the provisions in §15.35 and investigated frequency range is set the spectrum analyzer according to §15.33.
- ⑤ The fundamental frequency at which a relevant radiated signal component is detected, the test antenna will be raised and lowered through the specified range of heights in horizontal and vertical polarized orientation, until an maximum signal level is detected on the measuring receiver.
- ⑥ The transmitter is position x, y, z axis on rotating through 360 degrees, until the maximum signal level is detected by the measuring receiver.

⑦ The receiver is scanned from requested measuring frequency band and then the maximum meter reading is recorded. The radiated emissions were measured with required standard.

- The measurement results are obtained as described below:
 $\text{Result}(\text{dB}\mu\text{V}/\text{m}) = \text{Reading}(\text{dB}\mu\text{V}) + \text{Antenna factor}(\text{dB}/\text{m}) + \text{CL}(\text{dB}) + \text{other applicable factor}(\text{dB})$
- According to §15.33 (a)(1), Frequency range of radiated measurement is performed the tenth harmonic.
- ※ if necessary, additionally receiver is adopted high-pass filter and preamp because lower radiated signal
- ※ The transmitter radiated spectrum was investigated from 9 kHz to 1 GHz

5.2.4 Measurement Uncertainty

All measurements involve certain levels of uncertainties. The factors contributing to uncertainties are test receiver, Cable loss, Antenna factor calibration, antenna directivity, antenna factor variation with height, antenna phase center variation, Antenna frequency interpolation, measurement distance variation, Site imperfection, mismatch, and system repeatability based on NIS 80,81.

Radiated Emission measurement: 30 - 1000 MHz: 4.4 dB (CL: Approx 95 %, $k=2$)
 Above 1 GHz: 4.88 dB (CL: Approx 95 %, $k=2$)

5.2.5 Test Configuration

Radiated emission setup, Below 30 MHz

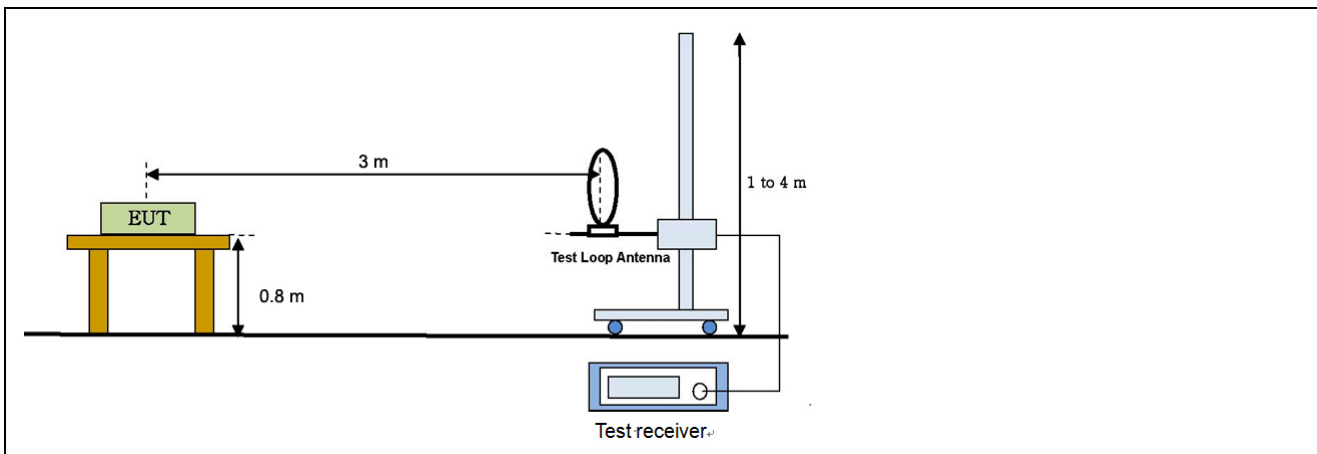

Radiated emission setup, Below 1 000 MHz

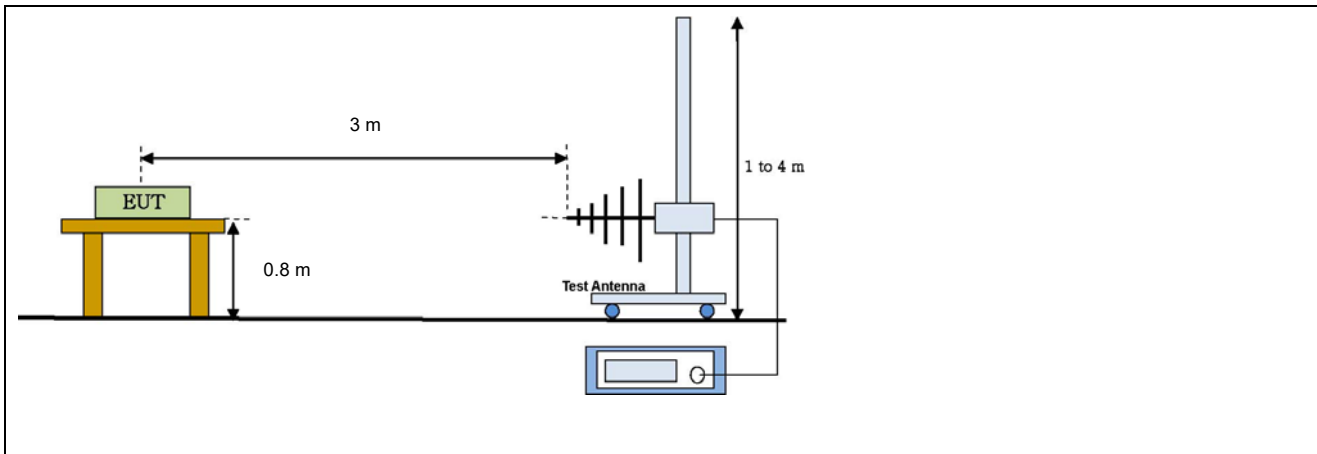

5.2.6 Measurement Result

■ IN-BAND

Freq. (MHz)	Reading (dB μ V/m)	Table (Deg)	Pstn (axis)	Antenna			CL (dB)	Pre AMP (dB)	Distn factor (dB)	Meas Result (dB μ V/m)	Limit (dB μ V/m)	Mgn (dB)	Result
				Height (m)	Pol. (H/V)	Fctr. (dB/m)							
13.560*	56.92	180	Y	1	-	9.38	0.44	-	-40	26.74	84.00	57.26	Compliance
13.350	39.86	180	Y	1	-	9.40	0.43	-	-40	9.69	40.50	30.81	Compliance
13.492	36.59	180	Y	1	-	9.39	0.43	-	-40	6.41	50.47	44.06	Compliance
13.642	39.61	180	Y	1	-	9.37	0.44	-	-40	9.41	50.47	41.06	Compliance
13.774	33.71	180	Y	1	-	9.36	0.45	-	-40	3.52	40.50	36.98	Compliance

*It is fundamental frequency

Note1. above measured frequency have been done at 3 m distance and corrected according to required FCC 15.209. e)

\therefore Extrapolation distance factor : $40\log(3/30) = -40$ dB If Measurement distance is 3 m and Mandatory requirement distance is 30 m at 30 MHz or less, extrapolation distance factor(dB) is $40 / \text{decade} = 40 \log_{10}^{(MRD/MD)}$

MRD is Mandatory requirement distance and MD is Measured distance

Note2. above measured frequencies is apply required standard FCC Part 15.225

Note3. All measurements were performed using a loop antenna. The antenna was positioned in three orthogonal positions (X front, Y side, Z top) and the position with the highest emission level was recorded.

Note4. All measurements were recorded using a quasi-peak detector.

Freq.(MHz) : Measurement frequency, Reading(dB μ V/m) : Indicated value for test receiver,

Table (Deg) : Directional degree of Turn table, Pstn(axis) : Location axis of EUT

Antenna (Height, Pol, Fctr) : Antenna Height, Polarization and Factor

Cbl(dB) : Cable loss, Distn factor(dB) : distance correction factor [40 dB/decade as per § 15.31f (2)]

Meas Result (dB μ V/m) : Reading(dB μ V/m) + Antenna factor.(dB/m) + CL(dB) + Distn factor(dB)

Limit(dB μ V/m): Limit value specified with FCC Rule, Mgn(dB) : FCC Limit (dB μ V/m) – Meas Result(dB μ V/m)

■ OUT- BAND

Freq. (MHz)	Reading (dB μ V/m)	Table (Deg)	Antenna			CL (dB)	Pre AMP (dB)	Meas Result (dB μ V/m)	Limit (dB μ V/m)	Mgn (dB)	Result
			Height (m)	Pol. (H/V)	Fctr. (dB/m)						
67.68	62.35	160	1.5	V	6.92	1.11	-42.34	28.04	40.00	11.96	Compliance
135.51	59.42	80	1.5	H	8.01	1.61	-41.88	27.16	43.50	16.34	Compliance
162.61	63.66	160	1.0	H	9.40	1.73	-41.70	33.09	43.50	10.41	Compliance
207.85	59.60	230	1.5	V	10.54	2.00	-41.48	30.66	43.50	12.84	Compliance
258.33	60.12	230	1.0	V	12.95	2.20	-41.40	33.87	46.00	12.13	Compliance
284.98	59.75	80	1.0	V	13.11	2.38	-41.37	33.88	46.00	12.12	Compliance
821.71	44.92	160	2.0	H	22.80	4.06	-38.61	33.18	46.00	12.82	Compliance

Freq.(MHz) : Measurement frequency, Reading(dB μ V/m) : Indicated value for test receiver,
 Table (Deg) : Directional degree of Turn table,
 Antenna (Height, Pol, Fctr) : Antenna Height, Polarization and Factor
 Cbl(dB) : Cable loss, Pre AMP(dB) : Preamplifier gain(dB)
 Meas Result (dB μ V/m) : Reading(dB μ V/m)+ Antenna factor.(dB/m)+ CL(dB) - Pre AMP(dB)
 Limit(dB μ V/m): Limit value specified with FCC Rule, Mgn(dB) : FCC Limit (dB μ V/m) – Meas Result(dB μ V/m)

5.2.7 Test plot

Fundamental frequency level & ≤ 30 MHz spectrum mask

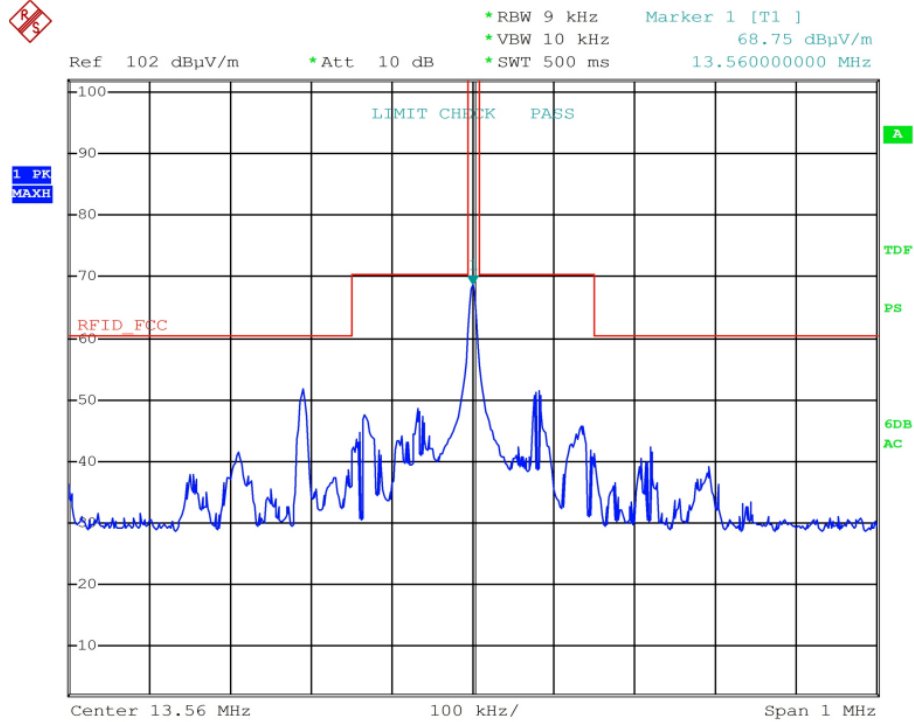

OUT- BAND Spurious

Horizontal

Vertical

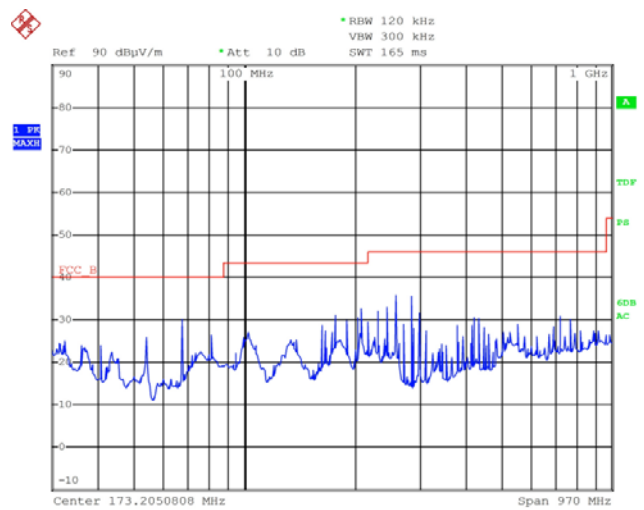
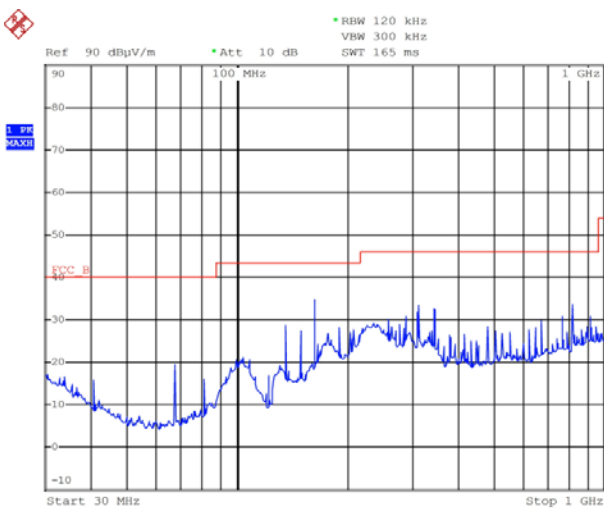

* Worst case only

5.3 Antenna requirement

5.3.1 Standard applicable [FCC §15.203]

For intentional device, according to §15.203, an intentional radiator shall be designed to ensure that no antenna other than furnished by responsible party shall be used with the device.

The use of a permanently attached antenna or of an antenna that user a unique coupling to the intentional radiator shall be considered sufficient to comply with the provisions of this section.

The manufacturer may design the unit so that broken antenna can be replaced by the user, but the use of a standard antenna jack or electrical connector is prohibited.

5.3.2 Antenna details

Frequency Band	Antenna Type	Gain [dBi]	Results
13.56 MHz	Internal PCB antenna	N/A	Compliance

5.4 AC Power Conducted emissions

5.4.1 Standard Applicable [FCC §15.207(a)]

For intentional radiator that is designed to be connected to the public utility(AC)power line, the radio frequency. Voltage that is conducted back onto the AC power line on any frequencies hopping mode within the band 150 kHz to 30 MHz shall not exceed the limits in the following table, as measured using a 50 μ H/50 ohms line Impedance stabilization network(LISN). Compliance with the provisions of this paragraph shall be based on the measurement of the radio frequency voltage between each power line and ground at the power terminal. The lower limit applies at the boundary between the frequency ranges.

§15.207 limits for AC line conducted emissions;

Frequency of Emission(MHz)	Conducted Limit (dB μ V)	
	Quasi-peak	Average
0.15 ~ 0.5	66 to 56 *	56 to 46 *
0.5 ~ 5	56	46
5 ~ 30	60	50

* Decreases with the logarithm of the frequency

5.4.2 Test Environment conditions

• Ambient temperature : (24 ~ 25) °C • Relative Humidity : (49 ~ 55) % R.H.

5.4.3 Measurement Procedure

EUT was placed on a non- metallic table height of 0.8 m above the reference ground plane. Cables connected to EUT were fixed to cause maximum emission. Test was made with the antenna positioned in both the horizontal and vertical planes of polarization. The measurement antenna was varied in height above the conducting ground plane to obtain the Maximum signal strength.

5.4.4 Used equipment

Equipment	Model No.	Serial No.	Manufacturer	Next cal date	Cal interval	Used
Test receiver	ESCS30	100111	Rohde & Schwarz	2019. 01. 29	1 year	<input checked="" type="checkbox"/>
LISN	ESH2-Z5	100044	R&S	2019. 01. 29	1 year	<input checked="" type="checkbox"/>
	ESH3-Z5	100147	R&S	2019. 01. 29	1 year	<input checked="" type="checkbox"/>

*Test Program: " ESXS-K1 V2.2"

Measurement uncertainty

Conducted Emission measurement: 4.48 dB (CL: Approx 95 %, k=2)

5.4.5 Measurement Result

☐ Unterminated the antenna

Freq. [MHz]	Factor [dB]		POL	QP			CISPR AV		
	LISN	CABLE +P/L		Limit [dB μ V]	Reading [dB μ V]	Result [dB μ V]	Limit [dB μ V]	Reading [dB μ V]	Result [dB μ V]
0.318	0.12	9.98	L	59.76	49.92	50.04	49.76	38.22	38.34
0.412	0.13	9.98	L	57.61	49.37	49.50	47.61	34.87	35.00
0.611	0.13	10.00	L	56.00	46.17	46.30	46.00	31.56	31.69
0.740	0.14	10.01	L	56.00	44.23	44.37	46.00	29.72	29.86
1.119	0.15	10.03	L	56.00	44.15	44.30	46.00	31.21	31.36
2.279	0.18	10.07	L	56.00	42.14	42.32	46.00	34.89	35.07
0.181	0.11	9.97	N	64.43	43.42	43.53	54.43	32.23	32.34
0.322	0.12	9.98	N	59.66	46.44	46.56	49.66	32.42	32.54
0.420	0.12	9.98	N	57.46	46.65	46.77	47.46	33.15	33.27
0.603	0.13	10.00	N	56.00	43.16	43.29	46.00	27.91	28.04
1.205	0.16	10.04	N	56.00	40.87	41.03	46.00	29.80	29.96
2.279	0.18	10.07	N	56.00	40.12	40.30	46.00	32.11	32.29

- * LISN: LISN insertion Loss, Cable: Cable Loss, P/L:pulse limiter factor
- * L: Line. Live, N: Line. Neutral
- * Reading: test receiver reading value (with cable loss & pulse limiter factor)
- * Result = LISN + Reading

Line. Live

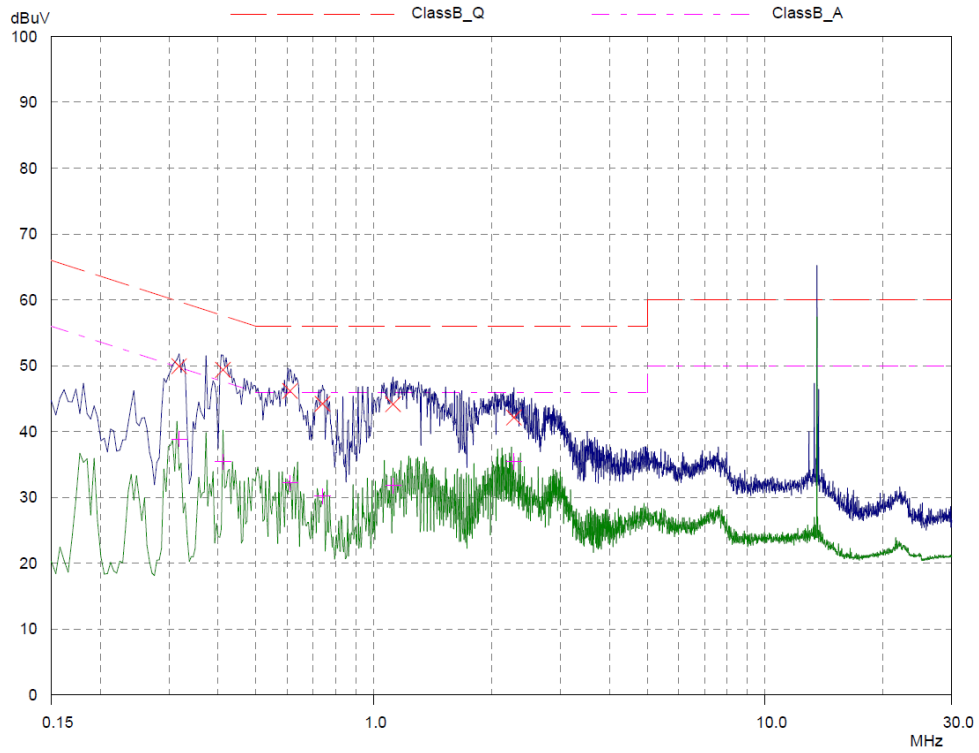

Line. Neutral

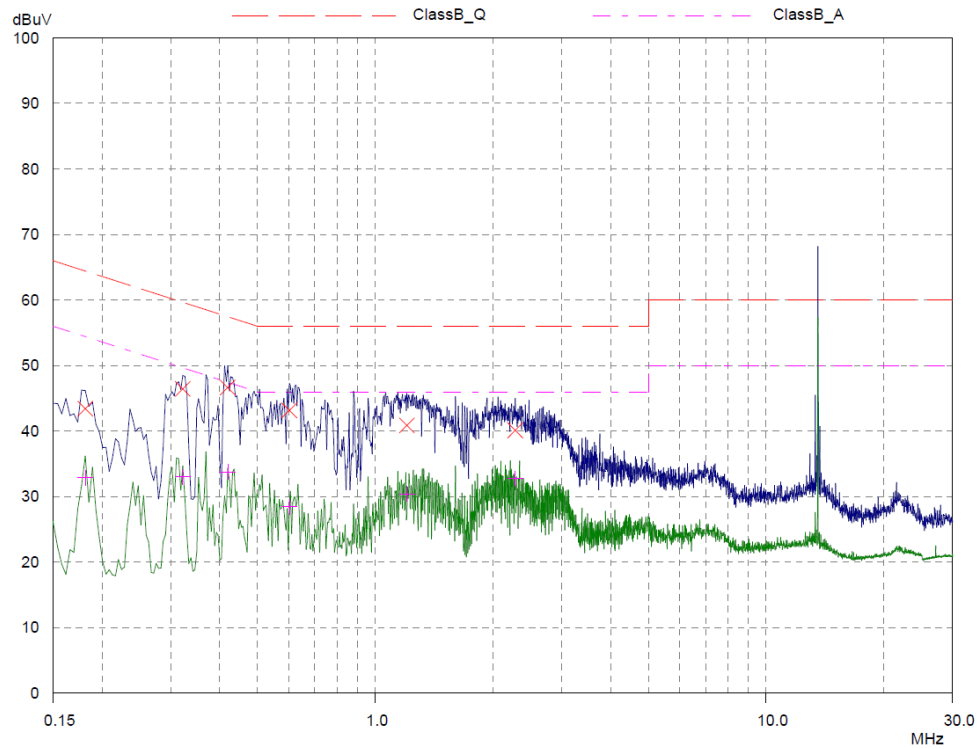



☐ Terminated the antenna

Freq. [MHz]	Factor [dB]		POL	QP			CISPR AV		
	LISN	CABLE +P/L		Limit [dB/μV]	Reading [dB/μV]	Result [dB/μV]	Limit [dB/μV]	Reading [dB/μV]	Result [dB/μV]
0.326	0.12	9.98	L	59.56	48.46	48.58	49.56	31.25	31.37
0.416	0.13	9.98	L	57.54	48.03	48.16	47.54	35.01	35.14
0.619	0.13	10.00	L	56.00	44.89	45.02	46.00	30.25	30.38
1.205	0.16	10.04	L	56.00	42.53	42.69	46.00	31.48	31.64
2.170	0.18	10.07	L	56.00	40.68	40.86	46.00	32.91	33.09
27.123	0.24	10.59	L	60.00	28.11	28.35	50.00	17.95	18.19
0.326	0.12	9.98	N	59.56	50.21	50.33	49.56	33.41	33.53
0.392	0.12	9.98	N	58.02	47.45	47.57	48.02	29.21	29.33
0.412	0.12	9.98	N	57.61	49.82	49.94	47.61	35.01	35.13
0.607	0.13	10.00	N	56.00	46.84	46.97	46.00	31.92	32.05
0.963	0.15	10.03	N	56.00	43.36	43.51	46.00	28.25	28.40
1.236	0.16	10.04	N	56.00	43.84	44.00	46.00	33.81	33.97
2.111	0.18	10.06	N	56.00	41.18	41.36	46.00	33.42	33.60

- * LISN: LISN insertion Loss, Cable: Cable Loss, P/L:pulse limiter factor
- * L: Line. Live, N: Line. Neutral
- * Reading: test receiver reading value (with cable loss & pulse limiter factor)
- * Result = LISN + Reading

Line. Live

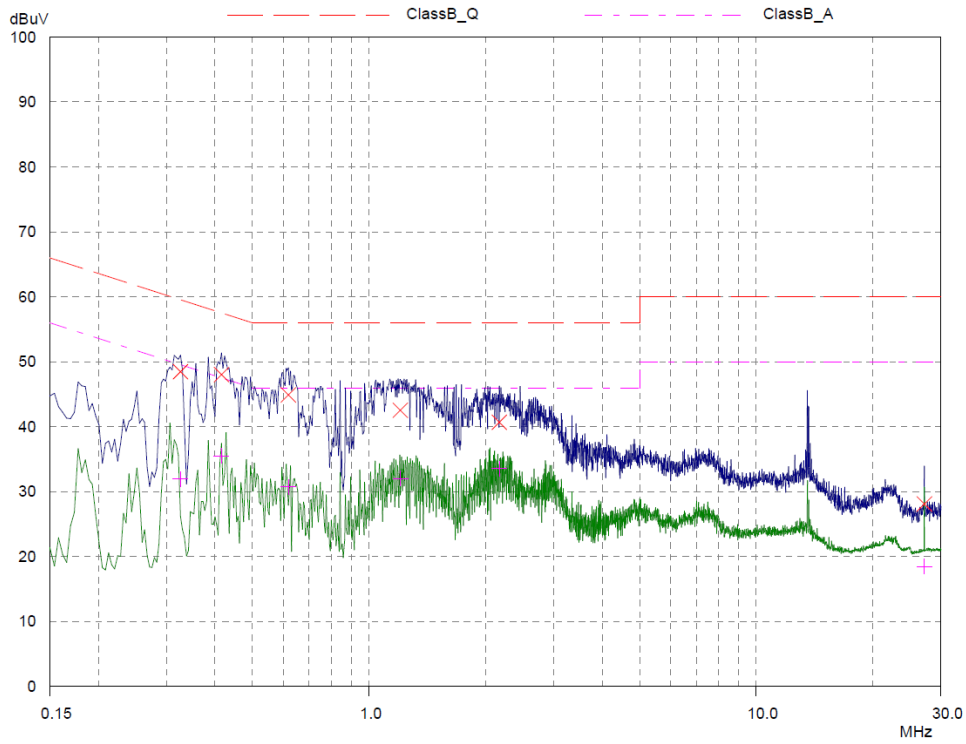

Line. Neutral

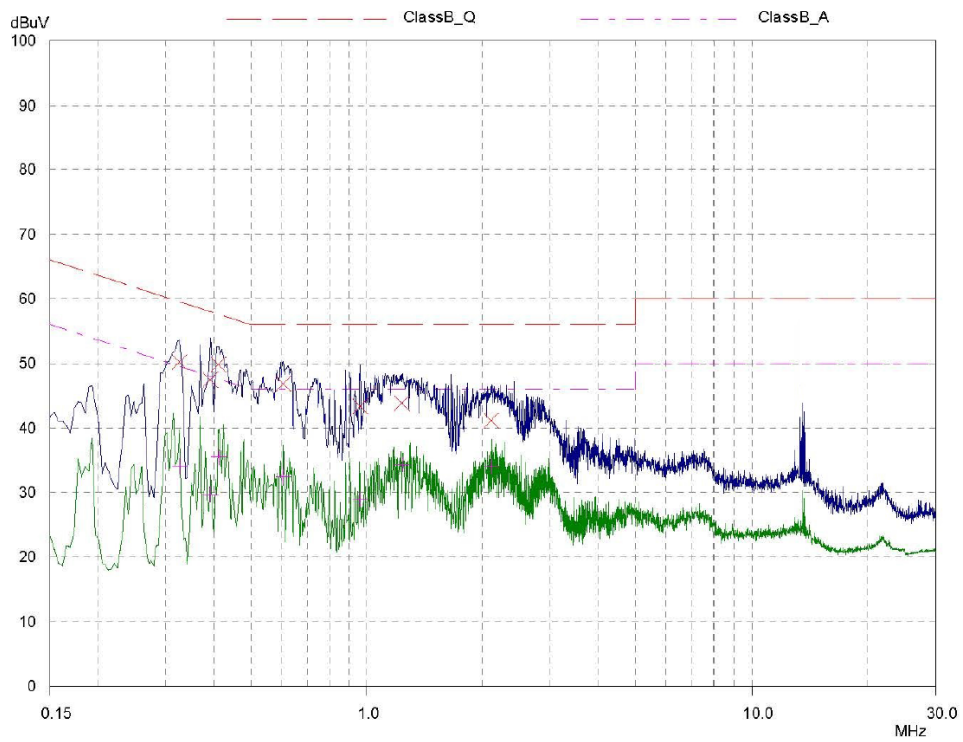

5.5 20 dB bandwidth measurement

5.5.1 Standard applicable [FCC §2.1049]

The 20 dB bandwidth is measured with a spectrum analyzer connected via a receive antenna placed near the EUT while the EUT is operating in transmission mode.

5.5.2 Test Environment conditions

- Ambient Temperature : (22 - 23) °C
- Relative Humidity : (50 - 52) % R.H.

5.5.3 Measurement Procedure

Please refer 5.5.1

5.5.4 Test setup

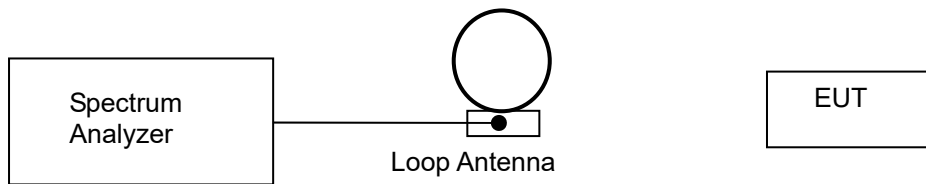

5.5.5 Measurement Result

Frequency	20 dB bandwidth
13.56 MHz	5.18 kHz

5.5.6 Test plot

