



■ Report No.: DDT-R21042026-2E01

■ Issued Date: Sep. 20, 2021

FCC CERTIFICATION TEST REPORT

FOR

Applicant	:	Pokit Innovations PTY. LTD.
Address	:	Unit 2.01, 56 Delhi Road, Macquarie Park 2113, NSW, Australia
Equipment under Test	:	Pokit PRO
Model No.	:	POK-PRO
Trade Mark	:	N/A
FCC ID	:	2ARUE-POKPRO
Manufacturer	:	Dongguan MediDiagno Biotech Co., Ltd.
Address	:	Rm 801, Rongyi Building, No.5 Xinxi Road, High-tech Industrial Development Zone, Songshan Lake, Dongguan, Guang Dong, China, 523808

Issued By: Dongguan Dongdian Testing Service Co., Ltd.

Add.: No. 17, Zongbu Road 2, Songshan Lake Sci&Tech, Industry Park, Dongguan City, Guangdong Province, China, 523808

Tel.: +86-0769-38826678, **E-mail:** ddt@dgddt.com, <http://www.dgddt.com>

REPORT

Table of Contents

Test report declares.....	4
1. Summary of Test Results.....	6
2. General Test Information	7
2.1. Description of EUT.....	7
2.2. Accessories of EUT	8
2.3. Assistant equipment used for test	8
2.4. Block diagram of EUT configuration for test.....	8
2.5. Deviations of test standard	8
2.6. Test environment conditions	8
2.7. Test laboratory	9
2.8. Measurement uncertainty	9
3. Equipment Used During Test.....	10
4. 6 dB Bandwidth and 99% Bandwidth	12
4.1. Block diagram of test setup	12
4.2. Limits.....	12
4.3. Test procedure	12
4.4. Test result	13
5. Maximum Peak Output Power.....	16
5.1. Block diagram of test setup	16
5.2. Limits.....	16
5.3. Test procedure	16
5.4. Test result	16
5.5. Test graphs	17
6. Power Spectral Density	19
6.1. Block diagram of test setup	19
6.2. Limits.....	19
6.3. Test procedure	19
6.4. Test result	19
6.5. Test graphs	20
7. Band Edge Compliance (Conducted Method).....	22
7.1. Block diagram of test setup	22
7.2. Limits.....	22
7.3. Test procedure	22
7.4. Test result	23
7.5. Test graphs	23
8. RF Conducted Spurious Emissions.....	24

8.1.	Block diagram of test setup	24
8.2.	Limits.....	24
8.3.	Test procedure	24
8.4.	Test result	25
8.5.	Test graphs	25
9.	Duty cycle	30
9.1.	Block diagram of test setup	30
9.2.	Test procedure	30
9.3.	Test Result.....	31
9.4.	Test graphs	31
10.	Radiated Emission.....	33
10.1.	Block diagram of test setup	33
10.2.	Limit	34
10.3.	Test procedure	35
10.4.	Test result	37
11.	Emissions in Restricted Frequency Bands.....	42
11.1.	Block diagram of test setup	42
11.2.	Limit	42
11.3.	Test procedure	42
11.4.	Test result	42
12.	Power Line Conducted Emission	47
12.1.	Block diagram of test setup	47
12.2.	Power line conducted emission limits.....	47
12.3.	Test procedure	47
12.4.	Test result	48
13.	Antenna Requirements.....	51
13.1.	Limit	51
13.2.	Result.....	51
14.	Test Setup Photograph	52
15.	Photos of the EUT	54

Test Report Declare

Applicant	:	Pokit Innovations PTY. LTD.
Address	:	Unit 2.01, 56 Delhi Road, Macquarie Park 2113, NSW, Australia
Equipment under Test	:	Pokit PRO
Model No.	:	POK-PRO
Trade Mark	:	N/A
Manufacturer	:	Dongguan MediDiagno Biotech Co., Ltd.
Address	:	Rm 801, Rongyi Building, No.5 Xinxi Road, High-tech Industrial Development Zone, SongShan Lake, Dongguan, Guang Dong, China, 523808

Test Standard Used:

FCC Rules and Regulations Part 15 Subpart C.

Test procedure used:

ANSI C63.10:2013

We Declare:

The equipment described above is tested by Dongguan Dongdian Testing Service Co., Ltd. and in the configuration tested the equipment complied with the standards specified above. The test results are contained in this test report and Dongguan Dongdian Testing Service Co., Ltd. is assumed of full responsibility for the accuracy and completeness of these tests.

After test and evaluation, our opinion is that the equipment provided for test compliance with the requirement of the above FCC standards.

Report No.:	DDT-R21042026-2E01		
Date of Receipt:	Apr. 21, 2021	Date of Test:	Aug. 21, 2021 ~ Sep. 15, 2021

Prepared By:

Jacky Huang

Jacky Huang/Engineer

Approved By:



Damon Hu/EMC Manager

Note: This report applies to above tested sample only. This report shall not be reproduced in parts without written approval of Dongguan Dongdian Testing Service Co., Ltd.

Revision History

Rev.	Revisions	Issue Date	Revised By
---	Initial issue	Sep. 20, 2021	

1. Summary of Test Results

The EUT have been tested according to the applicable standards as referenced below.		
Description of Test Item	Standard	Verdict
6 dB Bandwidth and 99% Bandwidth	FCC Part 15: 15.247 ANSI C63.10:2013	Pass
Peak Output Power	FCC Part 15: 15.247 ANSI C63.10:2013	Pass
Power Spectral Density	FCC Part 15:15.247 ANSI C63.10:2013	Pass
Band Edge Compliance (conducted method)	FCC Part 15: 15.209 FCC Part 15: 15.247 ANSI C63.10: 2013	Pass
Radiation Emission	FCC Part 15: 15.247 ANSI C63.10:2013	Pass
RF Conducted Spurious Emissions	FCC Part 15: 15.209 FCC Part 15: 15.247 ANSI C63.10: 2013	Pass
Emission in Restricted Frequency Bands	FCC Part 15: 15.209 FCC Part 15: 15.247 ANSI C63.10: 2013	Pass
Power Line Conducted Emission	FCC Part 15: 15.207 ANSI C63.10: 2013	Pass
Antenna Requirement	FCC Part 15: 15.203	Pass

2. General Test Information

2.1. Description of EUT

EUT* Name	: Pokit PRO
Model Number	: POK-PRO
EUT Function Description	: Please reference user manual of this device
Power Supply	: DC 5V by external AC Adapter or 3.7V built-in lithium battery
Radio Specification	: Bluetooth V5.0
Operation Frequency	: 2402 MHz - 2480 MHz
Modulation	: GFSK
Data Rate	: 1 Mbps
Antenna Gain	: Max:0.5dBi
Sample Type	: Series production
Serial Number	N/A

Note: EUT is the ab. of equipment under test.

Channel information					
Channel	Frequency (MHz)	Channel	Frequency (MHz)	Channel	Frequency (MHz)
0	2402	14	2430	28	2458
1	2404	15	2432	29	2460
2	2406	16	2434	30	2462
3	2408	17	2436	31	2464
4	2410	18	2438	32	2466
5	2412	19	2440	33	2468
6	2414	20	2442	34	2470
7	2416	21	2444	35	2472
8	2418	22	2446	36	2474
9	2420	23	2448	37	2476
10	2422	24	2450	38	2478
11	2424	25	2452	39	2480
12	2426	26	2454		
13	2428	27	2456		

2.2. Accessories of EUT

Description of Accessories	Manufacturer	Model number	Serial No.	Other
Type-C cable	N/A	N/A	N/A	Length:0.8m, Unshielded

2.3. Assistant equipment used for test

Assistant equipment	Manufacturer	Model number	EMC Compliance	Serial No.
iPhone 7	Apple	MN9H2LL/A	N/A	DNRSDN11HG7K
Adapter	HUAWEI	HW-050450C00	N/A	N/A

2.4. Block diagram of EUT configuration for test

EUT

Test software: EFR Connect.exe

The test software was used to control EUT work in Continuous Tx mode, and select test channel, wireless mode as below table.

Tested mode, channel, information			
Mode	Channel	Frequency (MHz)	Setting Tx Power
GFSK	CH0	2402	/
	CH19	2440	/
	CH39	2480	/

2.5. Deviations of test standard

No deviation.

2.6. Test environment conditions

During the measurement the environmental conditions were within the listed ranges:

Temperature range:	21-25 °C
Humidity range:	40-75%
Pressure range:	86-106 kPa

2.7. Test laboratory

Dongguan Dongdian Testing Service Co., Ltd.

Add.: No. 17, Zongbu Road 2, Songshan Lake Sci&Tech, Industry Park, Dongguan City, Guangdong Province, China, 523808.

Tel.: +86-0769-38826678, <http://www.dgddt.com>, Email: ddt@dgddt.com.

CNAS Accreditation No. L6451; A2LA Accreditation Number: 3870.01

FCC Designation Number: CN1182, Test Firm Registration Number: 540522

Innovation, Science and Economic Development Canada Site Registration Number: 10288A

Conformity Assessment Body identifier: CN0048

VCCI facility registration number: C-20087, T-20088, R-20123, G-20118

2.8. Measurement uncertainty

Test Item	Uncertainty
Bandwidth	1.1%
Peak Output Power (Conducted) (Spectrum analyzer)	0.86 dB (10 MHz ≤ f < 3.6 GHz);
	1.38 dB (3.6 GHz ≤ f < 8 GHz)
Peak Output Power (Conducted) (Power Sensor)	0.74 dB
Power Spectral Density	0.74 dB (10 MHz ≤ f < 3.6 GHz);
	1.38 dB (3.6 GHz ≤ f < 8 GHz)
Frequencies Stability	6.7 x 10 ⁻⁸ (Antenna couple method)
	5.5 x 10 ⁻⁸ (Conducted method)
Conducted spurious emissions	0.86 dB (10 MHz ≤ f < 3.6 GHz);
	1.40 dB (3.6 GHz ≤ f < 8 GHz)
	1.66 dB (8 GHz ≤ f < 22 GHz)
Uncertainty for radio frequency (RBW < 20 kHz)	3x10 ⁻⁸
Temperature	0.4 °C
Humidity	2 %
Uncertainty for Radiation Emission test (30 MHz - 1 GHz)	4.70 dB (Antenna Polarize: V)
	4.84 dB (Antenna Polarize: H)
Uncertainty for Radiation Emission test (1 GHz - 40 GHz)	4.10 dB (1 - 6 GHz)
	4.40 dB (6 GHz - 18 GHz)
	3.54 dB (18 GHz - 26 GHz)
	4.30 dB (26 GHz - 40 GHz)
Uncertainty for Power line conduction emission test	3.32 dB (150 kHz - 30 MHz)
Note: This uncertainty represents an expanded uncertainty expressed at approximately the 95% confidence level using a coverage factor of k=2.	

3. Equipment Used During Test

Equipment	Manufacturer	Model No.	Serial No.	Last Cal.	Cal. Interval
<input type="checkbox"/> RF Connected Test (Tonscend RF Measurement System 1#)					
Spectrum analyzer	R&S	FSU26	200071	Sep. 02, 2021	1 Year
Wideband Radio Communication tester	R&S	CMW500	120259	Sep. 02, 2021	1 Year
Vector Signal Generator	Agilent	E8267D	US49060192	Sep. 18, 2021	1 Year
Vector Signal Generator	Agilent	N5182A	MY48180737	Jun. 01, 2021	1 Year
RF Control Unit	Tonsend	JS0806-2	DDT-ZC0290	Jun. 01, 2021	1 Year
Temp&Humi Programmable	ZHIXIANG	ZXGDJS-150L	ZX170110-A	Jun. 01, 2021	1 Year
Test Software	JS Tonscend	JS1120-3	Ver.2.6.77.0518	N/A	N/A
<input checked="" type="checkbox"/> RF Connected Test (Tonscend RF Measurement System 2#)					
Spectrum analyzer	R&S	FSQ26	101272	Jun. 01, 2021	1 Year
Wideband Radio Communication tester	R&S	CMW500	117491	Jun. 01, 2021	1 Year
Vector Signal Generator	Agilent	N5182A	MY19060405	Jun. 01, 2021	1 Year
Vector Signal Generator	Agilent	N5182A	MY48180912	Jun. 01, 2021	1 Year
RF Control Unit	Tonsend	JS0806-2	DDT-ZC01449	Jun. 01, 2021	1 Year
Temp&Humi Programmable	ZHIXIANG	ZXGDJS-150L	ZX170110-A	Jun. 01, 2021	1 Year
Test Software	JS Tonscend	JS1120-3	Ver.2.6.77.0518	N/A	N/A
<input type="checkbox"/> Radiation 1#chamber					
EMI Test Receiver	R&S	ESU8	100316	Sep. 24, 2020	1 Year
Spectrum analyzer	Agilent	E4447A	MY50180031	Jun. 01, 2021	1 Year
Trilog Broadband Antenna	Schwarzbeck	VULB9163	9163-462	Nov. 13, 2020	1 Year
Active Loop antenna	Schwarzbeck	FMZB-1519	1519-038	Nov. 18, 2020	1 Year
Double Ridged Horn Antenna	R&S	HF907	100276	Nov. 13, 2020	1 Year
Broad Band Horn Antenna	Schwarzbeck	BBHA 9170	790	May 08, 2021	1 Year
Pre-amplifier	A.H.	PAM-0118	360	Sep. 28, 2020	1 Year
MI Cable	HUBSER	C10-01-01-1M	1091629	Sep. 30, 2020	1 Year
Test software	Audix	E3	V 6.11111b	N/A	N/A
<input type="checkbox"/> Radiation 2#chamber					

EMI Test Receiver	R&S	ESCI	101364	Sep. 28, 2020	1 Year
Spectrum analyzer	Agilent	E4447A	MY50180031	Jun. 01, 2021	1 Year
Trilog Broadband Antenna	Schwarzbeck	VULB 9163	9163-994	Nov. 13, 2020	1 Year
Active Loop antenna	Schwarzbeck	FMZB-1519	1519-038	Nov. 18, 2020	1 Year
Double Ridged Horn Antenna	Schwarzbeck	BBHA9120	02108	Jul. 17, 2021	1 Year
Broad Band Horn Antenna	Schwarzbeck	BBHA 9170	790	May 08, 2021	1 Year
Pre-amplifier	TERA-MW	TRLA-0040G35	101303	Sep. 28, 2020	1 Year
RF Cable	N/A	14+1.5m	06270619	Sep. 28, 2020	1 Year
Test software	Audix	E3	V 6.11111b	N/A	N/A
<input checked="" type="checkbox"/> Radiation 3#chamber					
EMI Test Receiver	R&S	ESU	100472	Jun. 01, 2021	1 Year
Spectrum analyzer	Agilent	E4447A	MY50180031	Jun. 01, 2021	1 Year
Active Loop antenna	Schwarzbeck	FMZB-1519	1519-038	Nov. 18, 2020	1 Year
Trilog Broadband Antenna	Schwarzbeck	VULB 9163	01429	Aug. 07, 2021	1 Year
Double Ridged Horn Antenna	Schwarzbeck	BBHA9120	02108	Jul. 17, 2021	1 Year
Broad Band Horn Antenna	Schwarzbeck	BBHA 9170	790	May 08, 2021	1 Year
Pre-amplifier	COM-POWER	PAM-118A	18040084	Sep. 02, 2021	1 Year
Pre-amplifier	COM-POWER	PAM-840A	461369	Mar. 15, 2021	1 Year
Test software	Audix	E3	V 6.1.1.1	N/A	N/A
<input type="checkbox"/> Power Line Conducted Emissions Test 1#					
EMI Test Receiver	R&S	ESU8	100316	Sep. 24, 2020	1 Year
LISN 1	R&S	ENV216	101109	Sep. 28, 2020	1 Year
LISN 2	R&S	ESH2-Z5	100309	Sep. 28, 2020	1 Year
Pulse Limiter	R&S	ESH3-Z2	101242	Sep. 24, 2020	1 Year
CE Cable 1	HUBSER	N/A	W10.01	Sep. 24, 2020	1 Year
Test software	Audix	E3	V 6.11111b	N/A	N/A
<input checked="" type="checkbox"/> Power Line Conducted Emissions Test 2#					
Test Receiver	R&S	ESCI	101028	Sep. 02, 2021	1 Year
LISN 1	R&S	ENV216	101170	Sep. 02, 2021	1 Year
Pulse Limiter	R&S	KH43101	431011801568-12#	Jun. 01, 2021	1 Year
CE Cable 2	HUBSER	RG214-5	N/A	Jun. 01, 2021	1 Year
Test software	Audix	E3	V 6.11111b	N/A	N/A

4. 6 dB Bandwidth and 99% Bandwidth

4.1. Block diagram of test setup

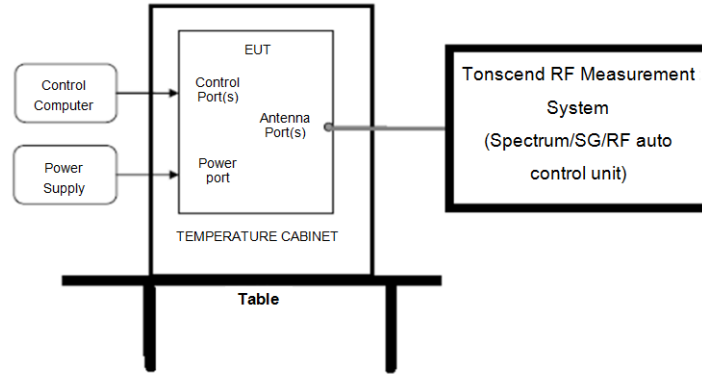

4.2. Limits

For direct sequence systems, the minimum 6 dB bandwidth shall be at least 500 kHz

4.3. Test procedure

(1) Connect EUT's antenna output to spectrum analyzer by RF cable.

(2) 99% Bandwidth set the spectrum analyzer as follows:

RBW:	30 kHz
VBW:	100 kHz
Detector Mode:	Peak
Sweep time:	auto
Trace mode	Max hold

(3) 6 dB Bandwidth set the spectrum analyzer as follows:

RBW:	100 kHz
VBW:	300 kHz
Detector Mode:	Peak
Sweep time:	auto
Trace mode	Max hold

(4) Allow the trace to stabilize, measure the 6 dB and 99% bandwidth of signal.

4.4. Test result

DTS Bandwidth Test Result

Test Mode	Antenna	Channel	DTS BW [MHz]	Limit [MHz]	Verdict
BLE 1M	Ant1	2402	0.656	≥ 0.5	Pass
		2440	0.656	≥ 0.5	Pass
		2480	0.656	≥ 0.5	Pass

Test Graphs

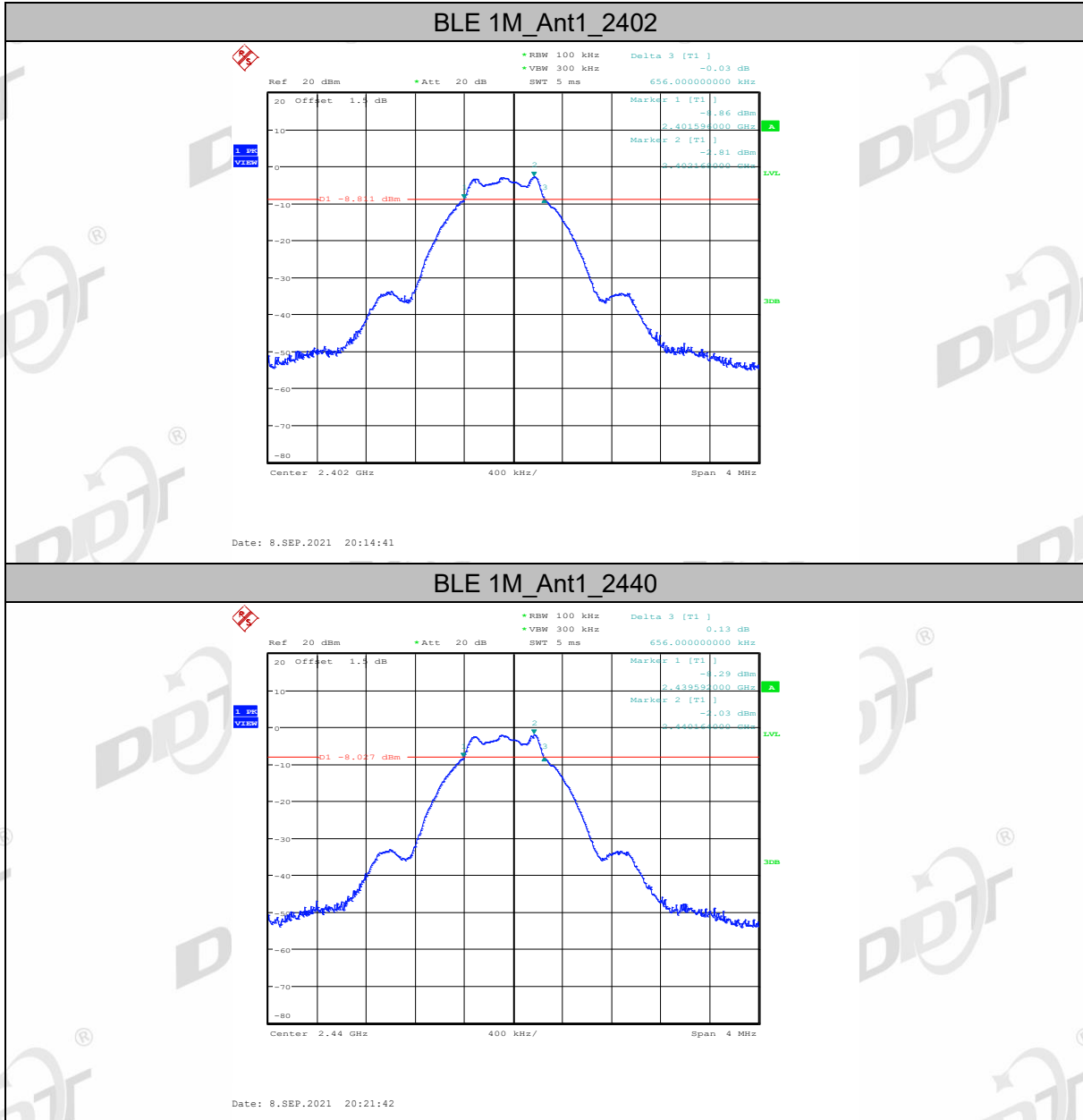

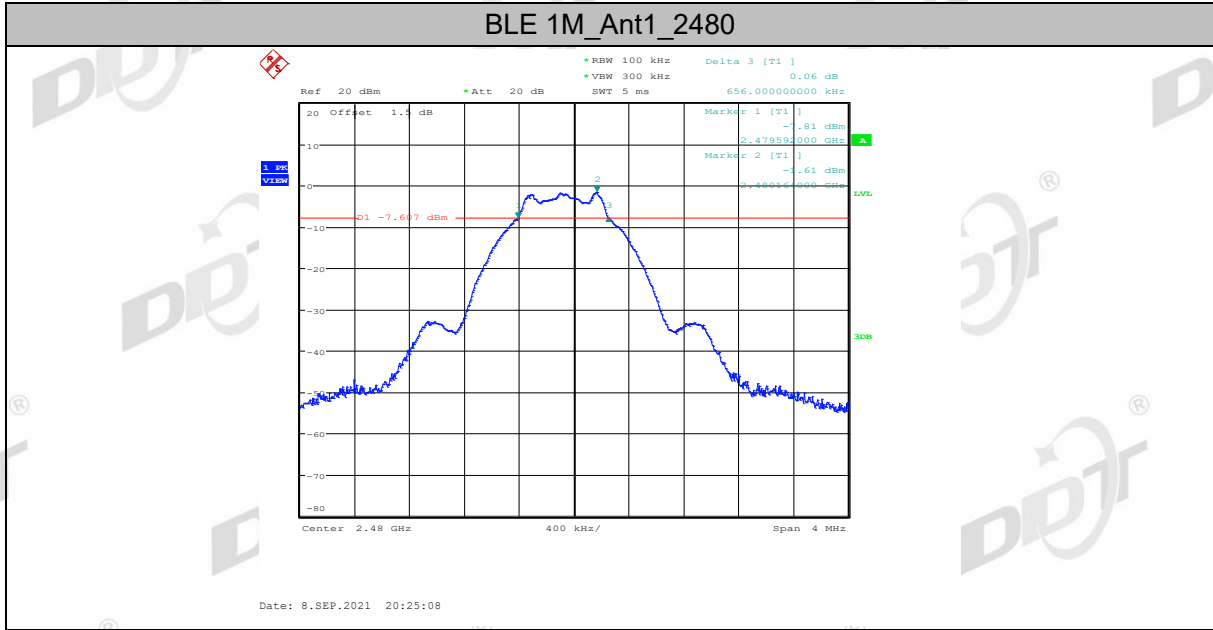

Occupied Channel Bandwidth Test Result

Test Mode	Antenna	Channel	OCB [MHz]	FL[MHz]	FH[MHz]	Limit [MHz]	Verdict
BLE 1M	Ant1	2402	1.028	2401.416	2402.444	---	Pass
		2440	1.032	2439.408	2440.440	---	Pass
		2480	1.032	2479.408	2480.440	---	Pass

Test Graphs

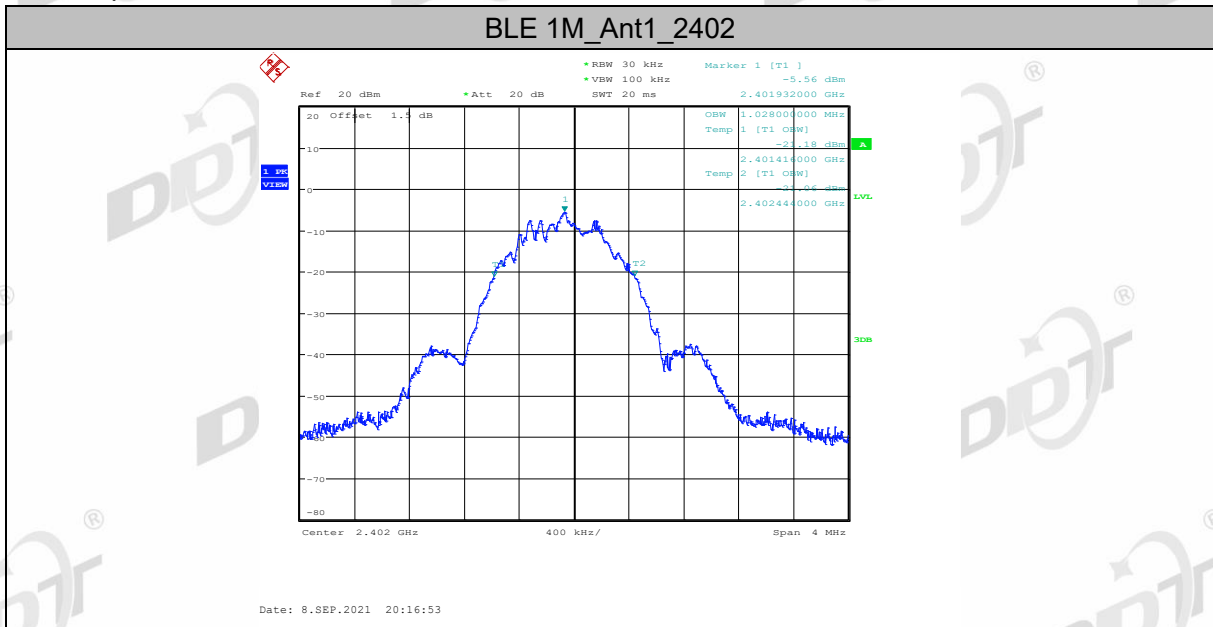

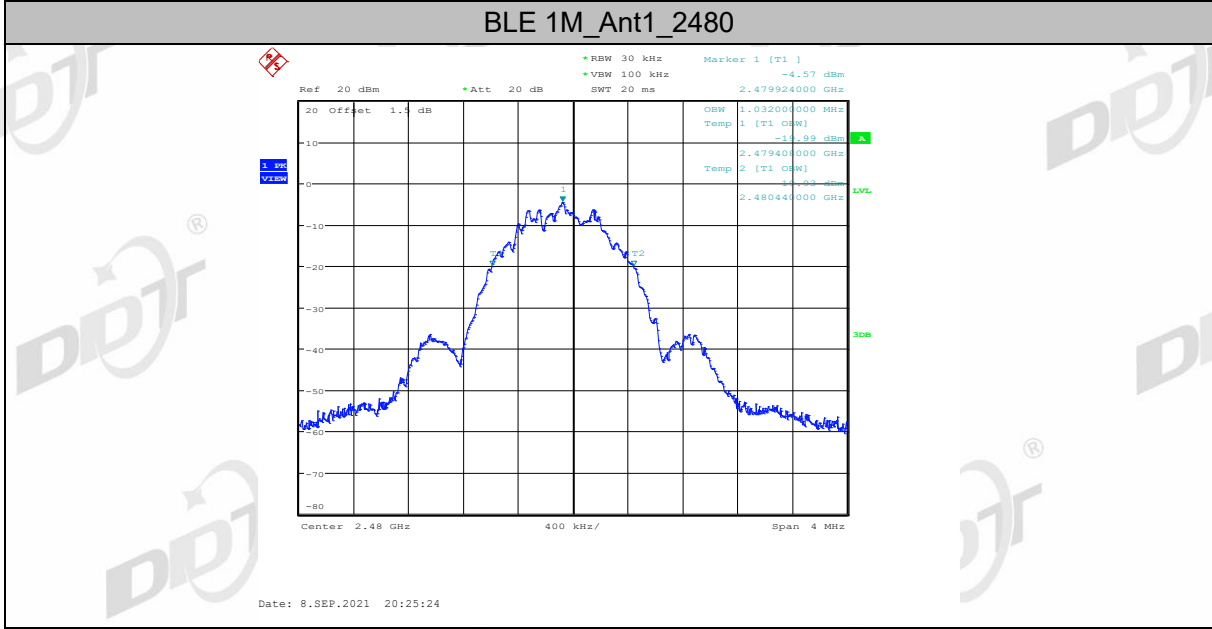
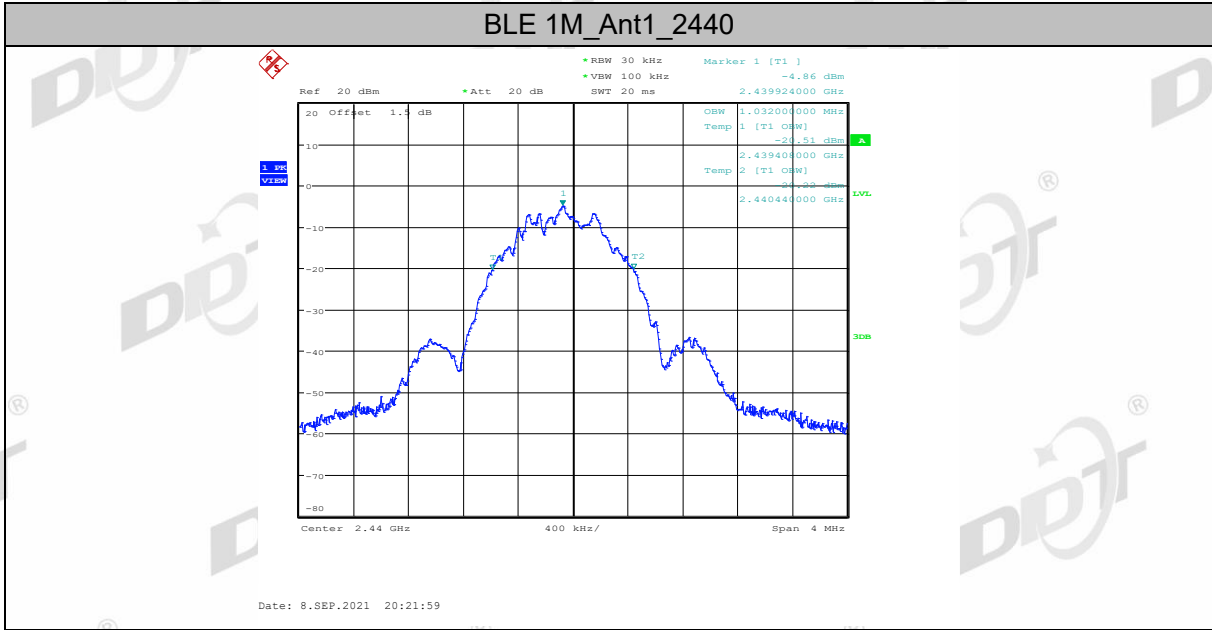

5. Maximum Peak Output Power

5.1. Block diagram of test setup

Same with 4.1

5.2. Limits

For systems using digital modulation in the 902-928 MHz, 2400-2483.5 MHz, and 5725-5850 MHz bands: 1 Watt. If transmitting antennas of directional gain greater than 6dBi are used, the conducted output power from the intentional radiator shall be reduced below the stated values as appropriate, by the amount in dB that the directional gain of the antenna exceeds 6 dBi.

5.3. Test procedure

(1) Connect EUT's antenna output to spectrum analyzer by RF cable.

(2) Set the spectrum analyzer as follows:

RBW:	≥DTS bandwidth
VBW:	≥3 x RBW
Span	≥3 x RBW
Detector Mode:	Peak
Sweep time:	auto
Trace mode	Max hold

(3) Allow the trace to stabilize, Use the instrument's band/channel power measurement function with the band limits set equal to the DTS bandwidth edges measure out the PK output power.

5.4. Test result

Test Mode	Antenna	Channel	Result [dBm]	Limit [dBm]	Verdict
BLE 1M	Ant1	2402	-2.65	≤30	Pass
		2440	-1.83	≤30	Pass
		2480	-1.40	≤30	Pass

5.5. Test graphs



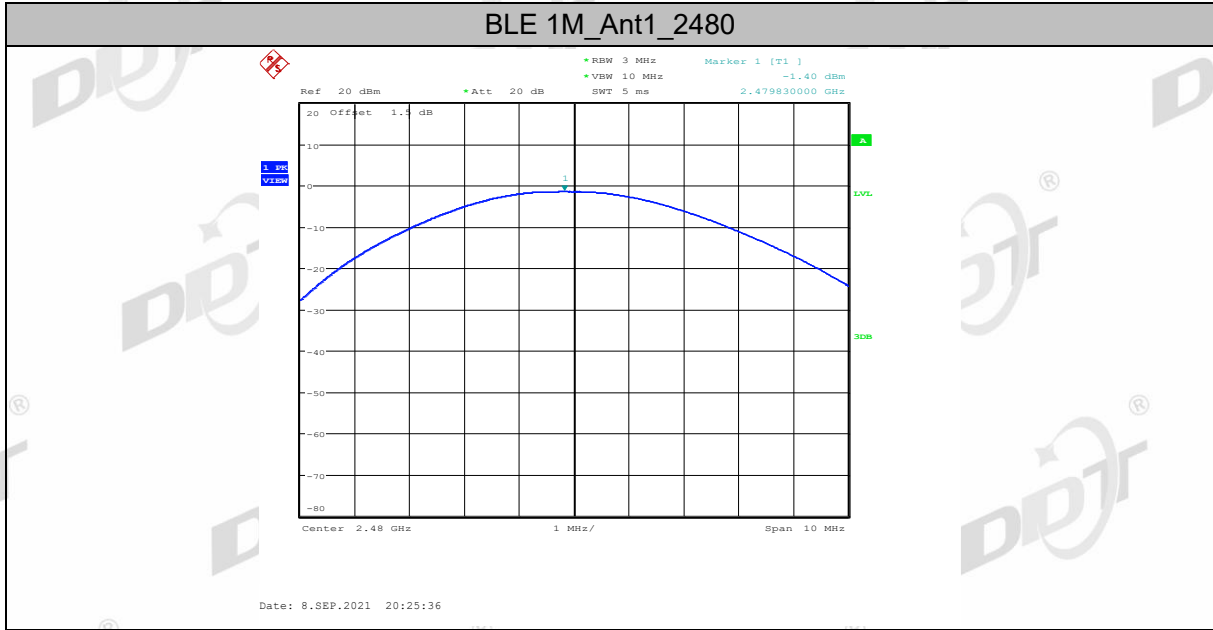

6. Power Spectral Density

6.1. Block diagram of test setup

Same with 4.1

6.2. Limits

For digitally modulated systems, the power spectral density conducted from the intentional radiator to the antenna shall not be greater than 8 dBm in any 3 kHz band during any time interval of continuous transmission.

6.3. Test procedure

(1) Connect EUT's antenna output to spectrum analyzer by RF cable.

(2) Set the spectrum analyzer as follows:

Center frequency	DTS Channel center frequency
RBW:	$3 \text{ kHz} \leq \text{RBW} \leq 100 \text{ kHz}$
VBW:	$\geq 3\text{RBW}$
Span	1.5 times the DTS bandwidth
Detector Mode:	Peak
Sweep time:	auto
Trace mode	Max hold

(3) Allow the trace to stabilize, use the peak marker function to determine the maximum amplitude level within the RBW.

(4) If measured value exceeds limit, reduce RBW (no less than 3 kHz) and repeat.

6.4. Test result

Test Mode	Antenna	Channel	Result [dBm/3kHz]	Limit [dBm/3kHz]	Verdict
BLE 1M	Ant1	2402	-18.26	≤ 8	Pass
		2440	-17.49	≤ 8	Pass
		2480	-17.09	≤ 8	Pass

6.5. Test graphs



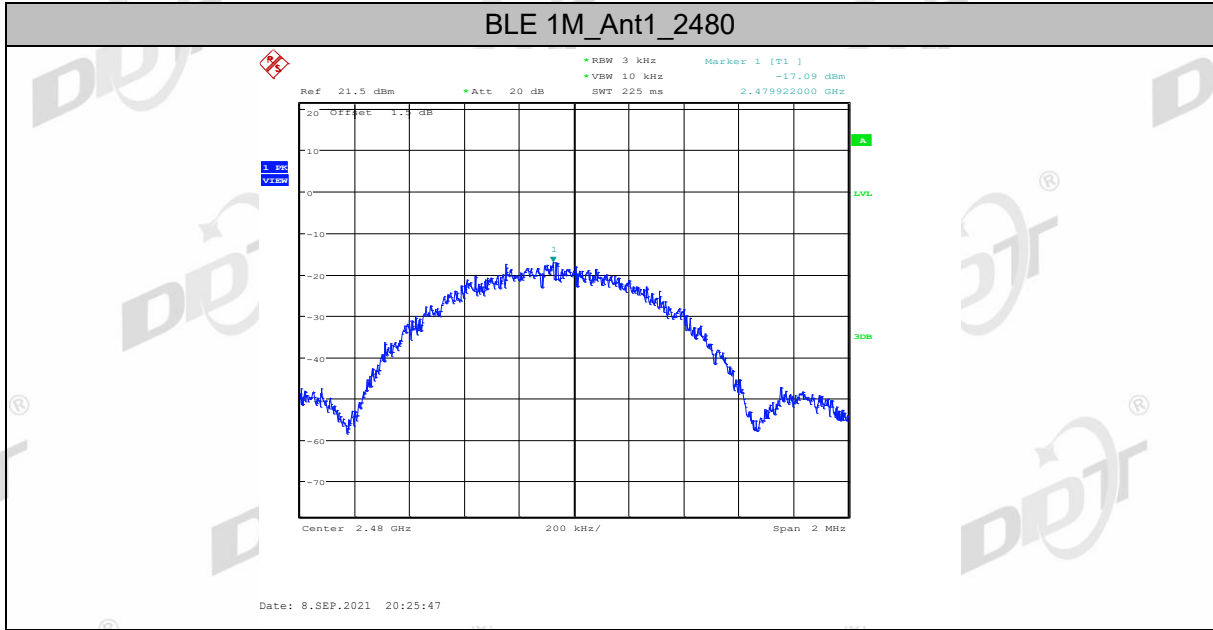

7. Band Edge Compliance (Conducted Method)

7.1. Block diagram of test setup

Same with 4.1

7.2. Limits

In any 100 kHz bandwidth outside the frequency bands in which the spread spectrum intentional radiator is operating, the radio frequency power that is produced by the intentional radiator shall be at least 20 dB below that in the 100 kHz bandwidth within the band that contains the highest level of the desired power.

7.3. Test procedure

(1) Connect EUT's antenna output to spectrum analyzer by RF cable.

(2) Establish a reference level by using the following procedure:

Center frequency	DTS Channel center frequency
RBW:	100 kHz
VBW:	300 kHz
Span	1.5 times the DTS bandwidth
Detector Mode:	Peak
Sweep time:	auto
Trace mode	Max hold

(3) Allow the trace to stabilize, use the peak marker function to determine the maximum peak power level to establish the reference level.

(4) Set the spectrum analyzer as follows:

RBW:	100 kHz
VBW:	300 kHz
Span	Encompass frequency range to be measured
Number of measurement points	$\geq \text{span/RBW}$
Detector Mode:	Peak
Sweep time:	auto
Trace mode	Max hold

(5) Allow the trace to stabilize, use the peak marker function to determine the maximum amplitude of all unwanted emissions outside of the authorized frequency band

7.4. Test result

Test Mode	Antenna	Channel Name	Channel	RefLevel [dBm]	Result [dBm]	Limit [dBm]	Verdict
BLE 1M	Ant1	Low	2402	-2.89	-52.21	<=-22.89	Pass
		High	2480	-1.48	-54.74	<=-21.48	Pass

7.5. Test graphs



8. RF Conducted Spurious Emissions

8.1. Block diagram of test setup

Same as section 4.1

8.2. Limits

In any 100 kHz bandwidth outside the frequency bands in which the spread spectrum intentional radiator is operating, the radio frequency power that is produced by the intentional radiator shall be at least 20 dB below that in the 100 kHz bandwidth within the band that contains the highest level of the desired power.

8.3. Test procedure

- (1) Connect EUT's antenna output to spectrum analyzer by RF cable.
- (2) Establish a reference level by using the following procedure:

Center frequency	Test frequency
RBW:	100 kHz
VBW:	300 kHz
Span	Wide enough to capture the peak level of the in-band emission
Detector Mode:	Peak
Sweep time:	auto
Trace mode	Max hold

- (3) Allow the trace to stabilize, use the peak marker function to determine the maximum peak power level to establish the reference level.

- (4) Set the spectrum analyzer as follows:

RBW:	100 kHz
VBW:	300 kHz
Span	Encompass frequency range to be measured
Number of measurement points	$\geq \text{span}/\text{RBW}$
Detector Mode:	Peak
Sweep time:	auto
Trace mode	Max hold

- (5) Allow the trace to stabilize, use the peak marker function to determine the maximum amplitude of all unwanted emissions outside of the authorized frequency band

8.4. Test result

Test Mode	Antenna	Channel	FreqRange [MHz]	RefLevel [dBm]	Result [dBm]	Limit [dBm]	Verdict
BLE 1M	Ant1	2402	Reference	-3.03	-3.03	---	Pass
			30~1000	30~1000	-43.97	<=-23.03	Pass
			1000~26500	1000~26500	-53.07	<=-23.03	Pass
		2440	Reference	-2.13	-2.13	---	Pass
			30~1000	30~1000	-43.87	<=-22.13	Pass
			1000~26500	1000~26500	-53.34	<=-22.13	Pass
		2480	Reference	-1.51	-1.51	---	Pass
			30~1000	30~1000	-43.97	<=-21.51	Pass
			1000~26500	1000~26500	-52.46	<=-21.51	Pass

8.5. Test graphs

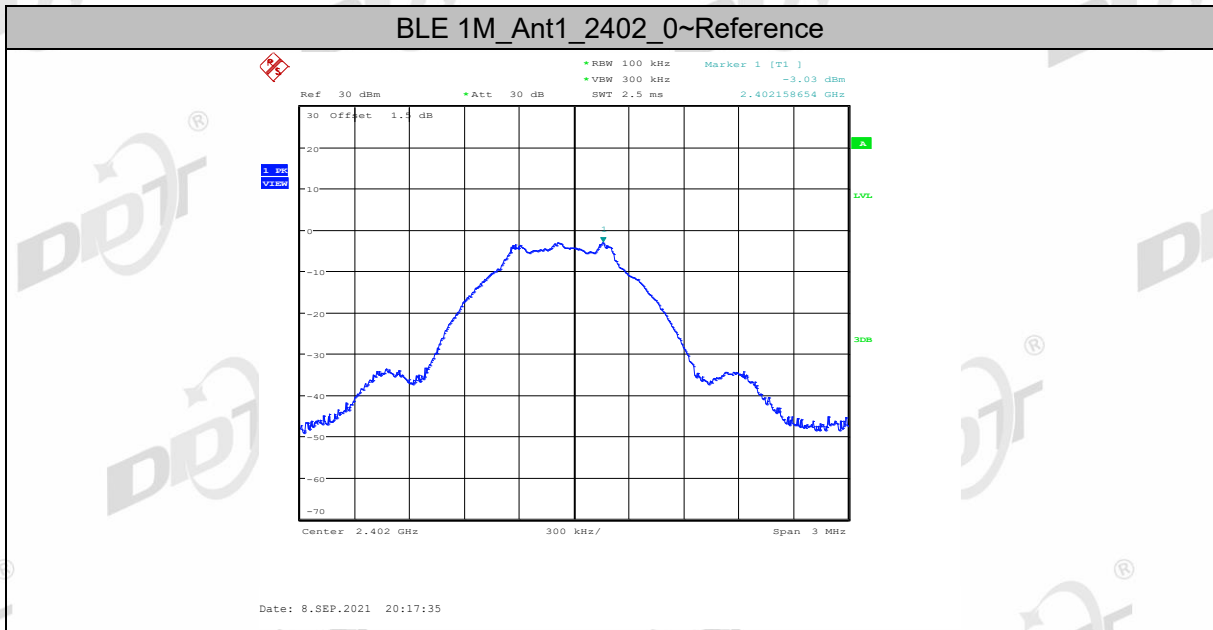

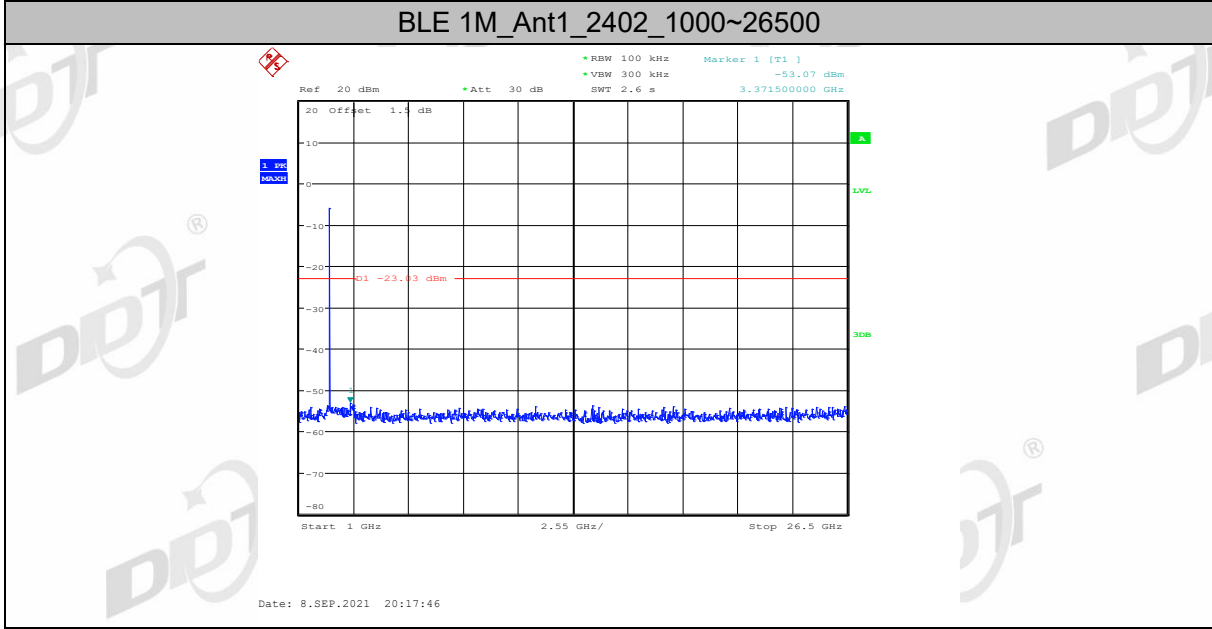
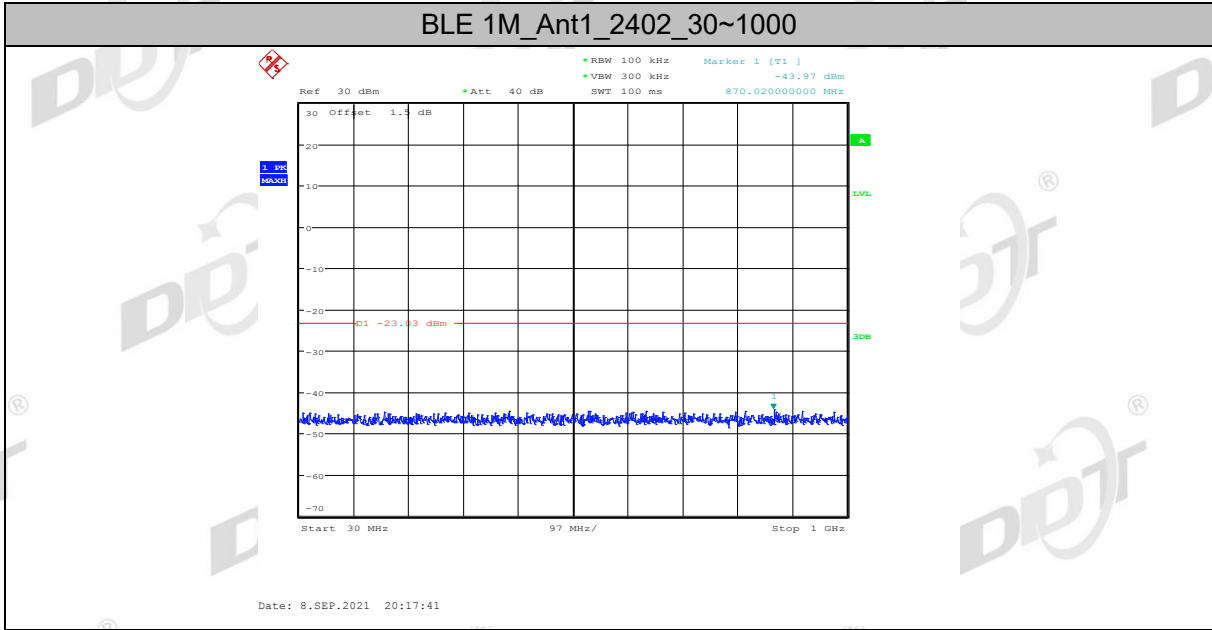

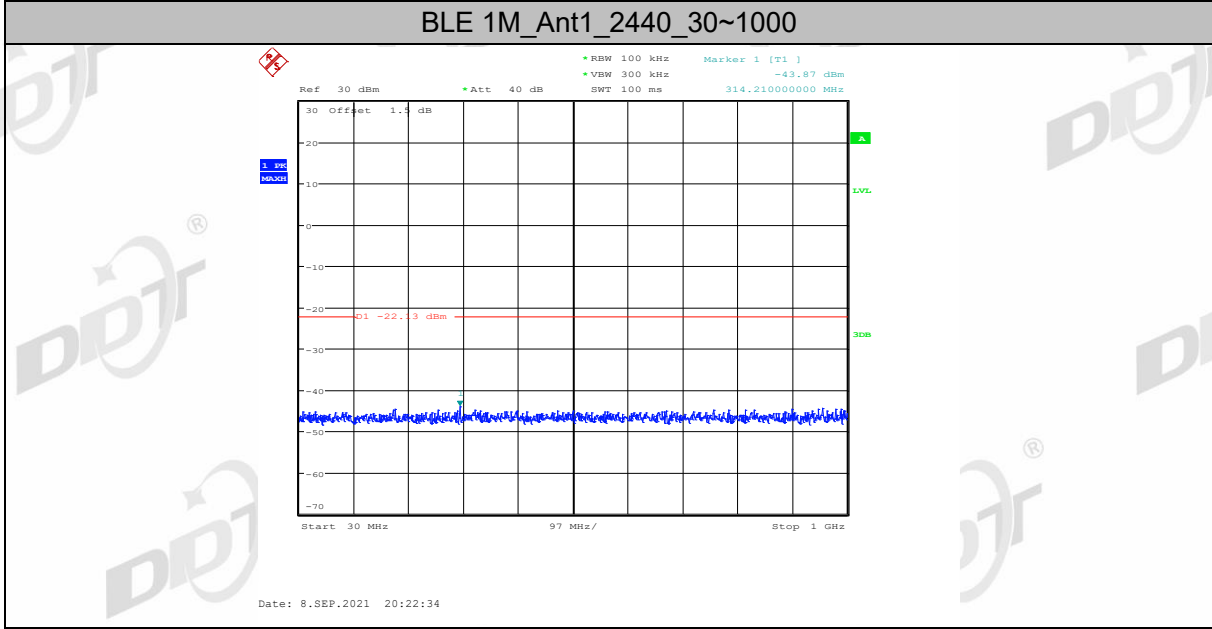
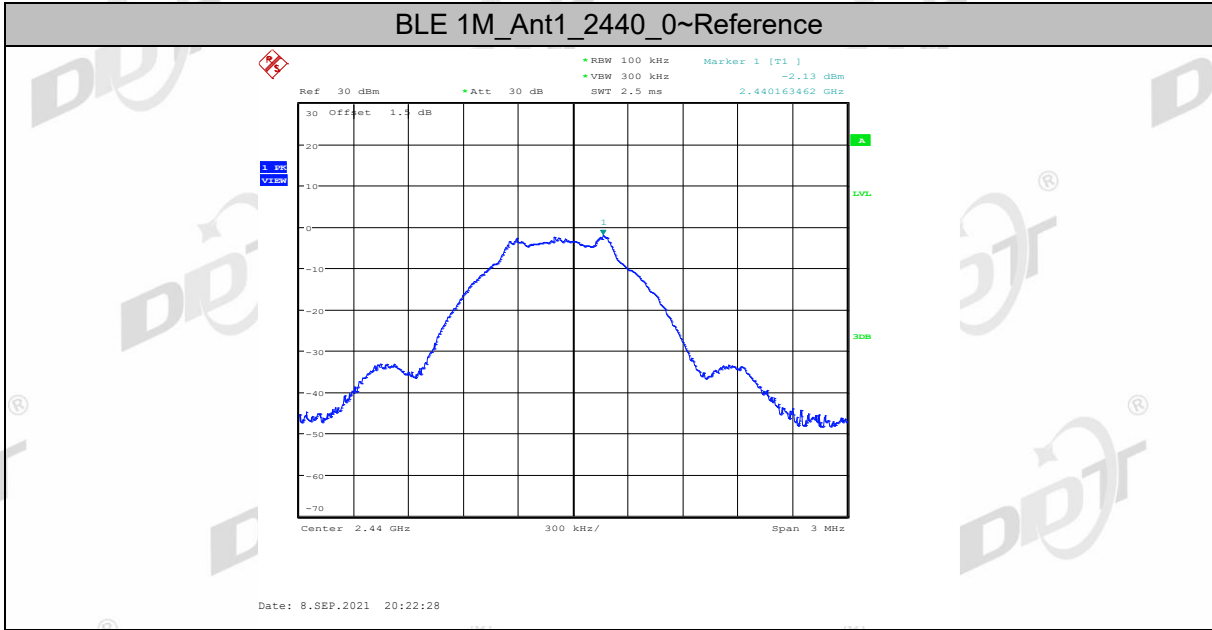

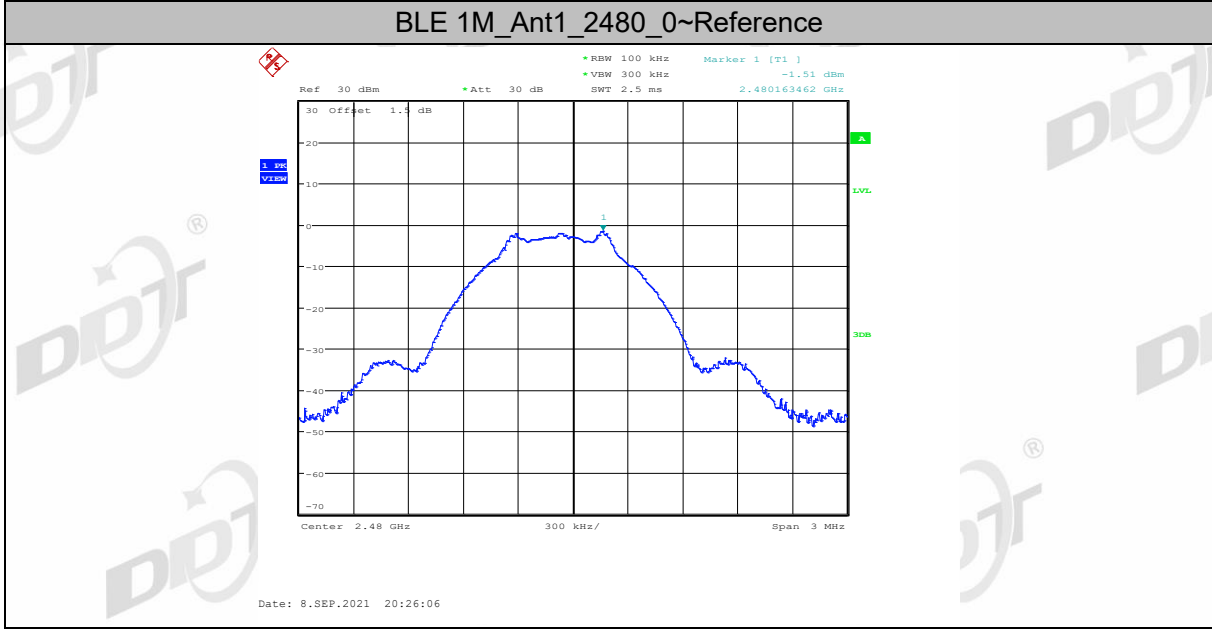
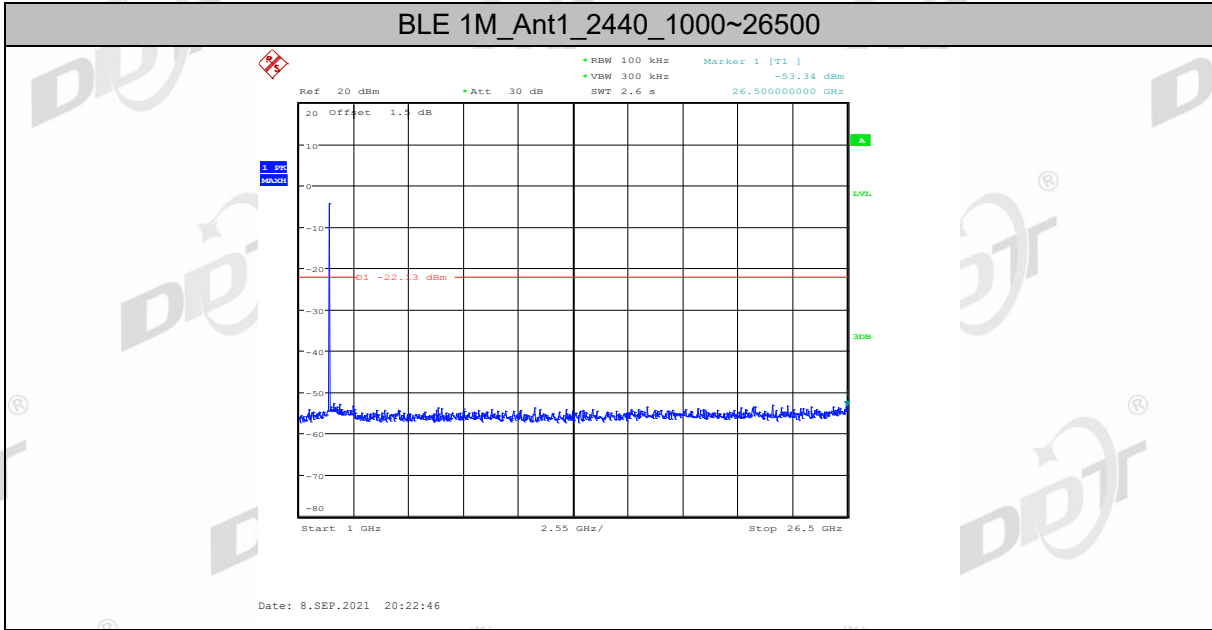

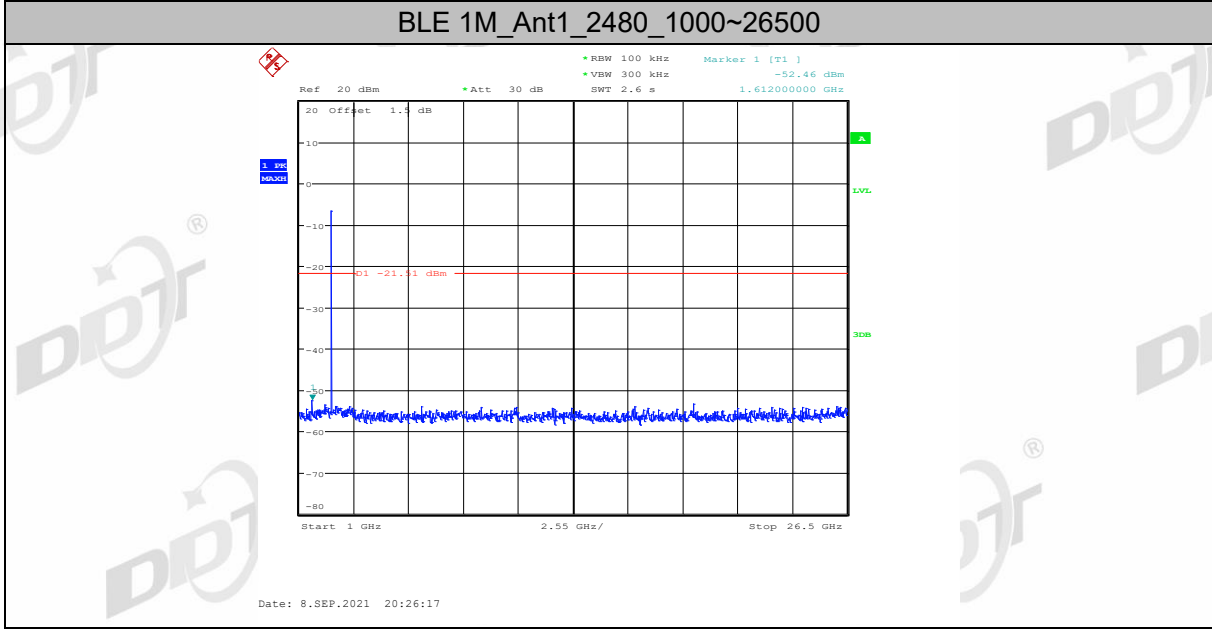
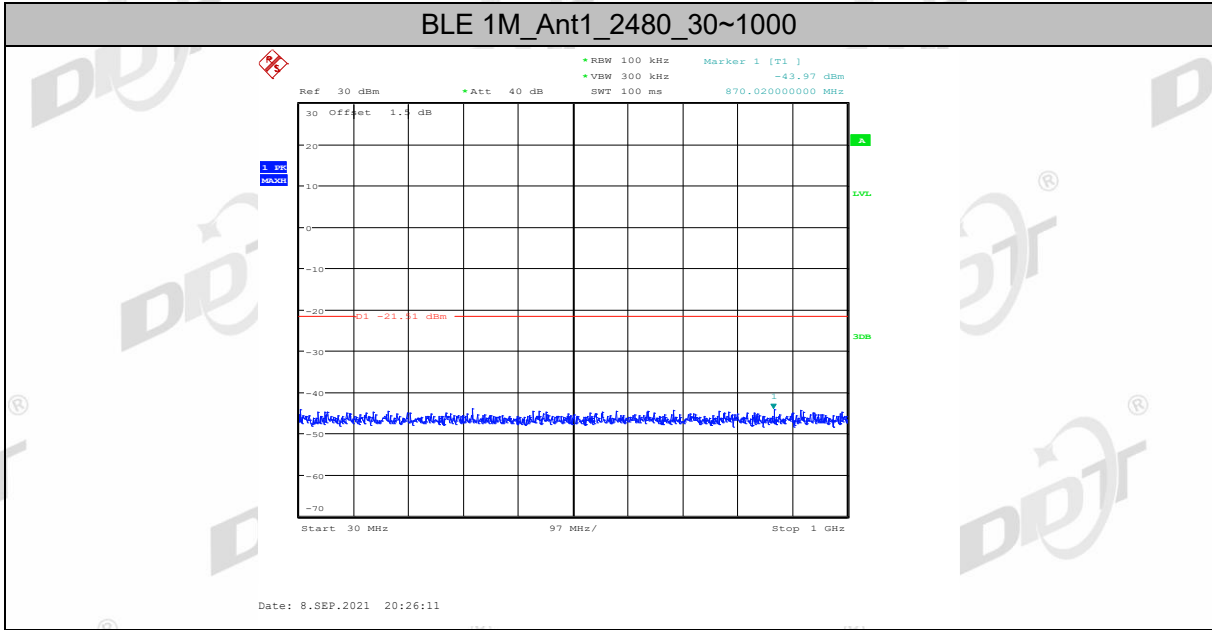

9. Duty cycle

9.1. Block diagram of test setup

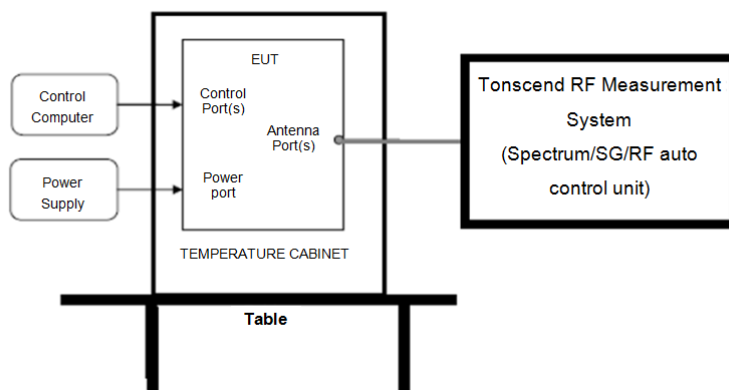

9.2. Test procedure

- (1) Connect each EUT's antenna output to power sensor by RF cable and attenuator.
- (2) For adaptive equipment, the measurement duration shall be long enough to ensure a minimum number of bursts (at least 10) is captured.

Note: The cable loss and attenuator loss have been put into spectrum analyzer as amplitude offset.

- (1) Connected the EUT's antenna port to the Spectrum Analyzer by suitable attenuator, set the Spectrum Analyzer as below:

Centre Frequency: The centre frequency of the middle hopping channel.

Resolution BW: 10 MHz.

Video BW: 10 MHz.

Span: Zero span.

Detector: Peak.

Trace Mode: Max Hold.

Sweep: Video Trigger

- (2) When the trace is complete, measure the sending time of 1 burst and the duty cycle of 1 burst cycle.
- (3) Calculate dwell time follow below formula:

Duty cycle= Pulse's on time / Burst cycle

9.3. Test Result

Test Mode	Antenna	Channel	Transmission Duration [ms]	Transmission Period [ms]	Duty Cycle [%]	Limit	Verdict
BLE 1M	Ant1	2402	2.13	2.50	85.20	---	N/A
		2440	2.13	2.50	85.25	---	N/A
		2480	2.13	2.50	85.38	---	N/A

9.4. Test graphs

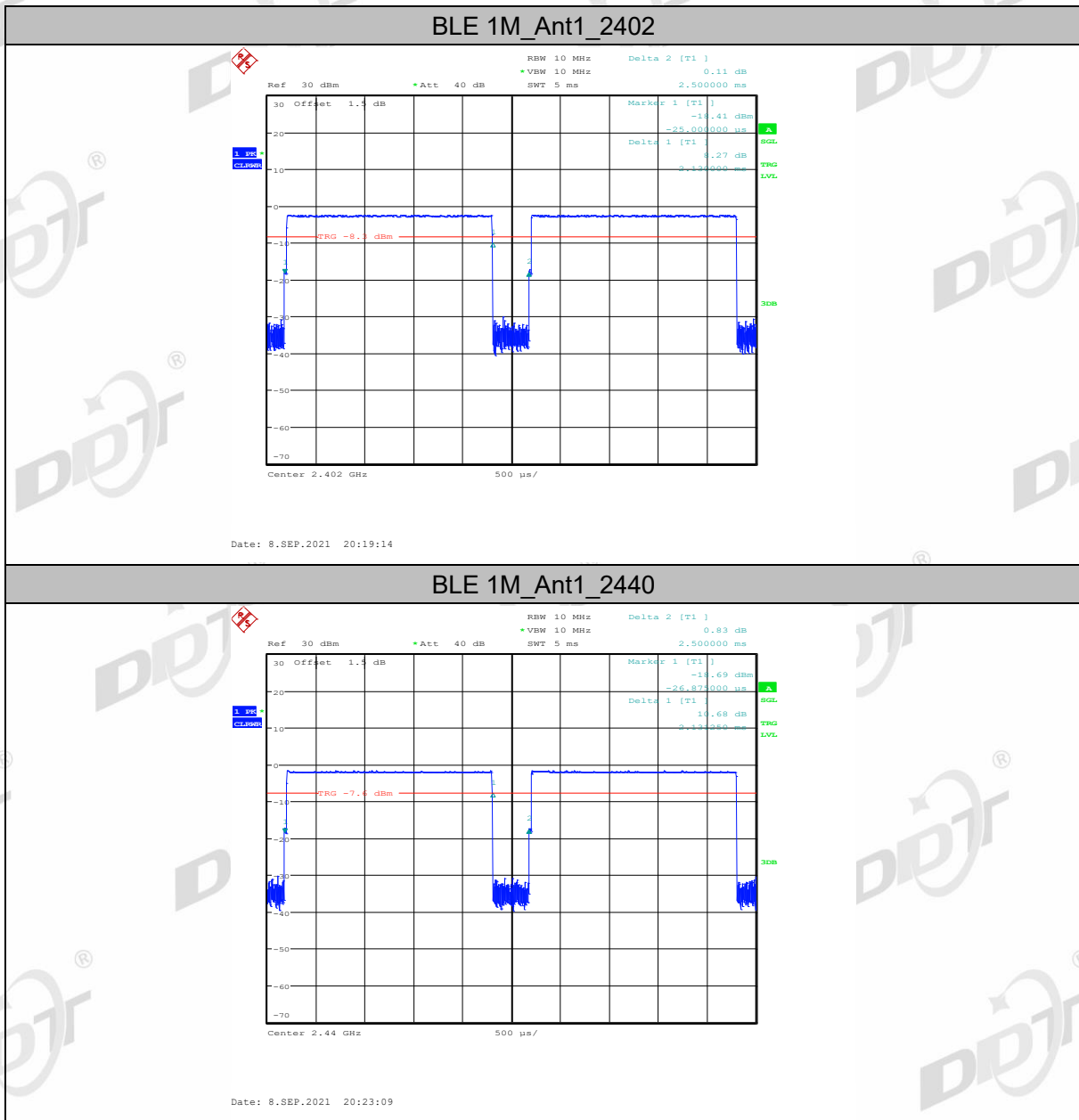

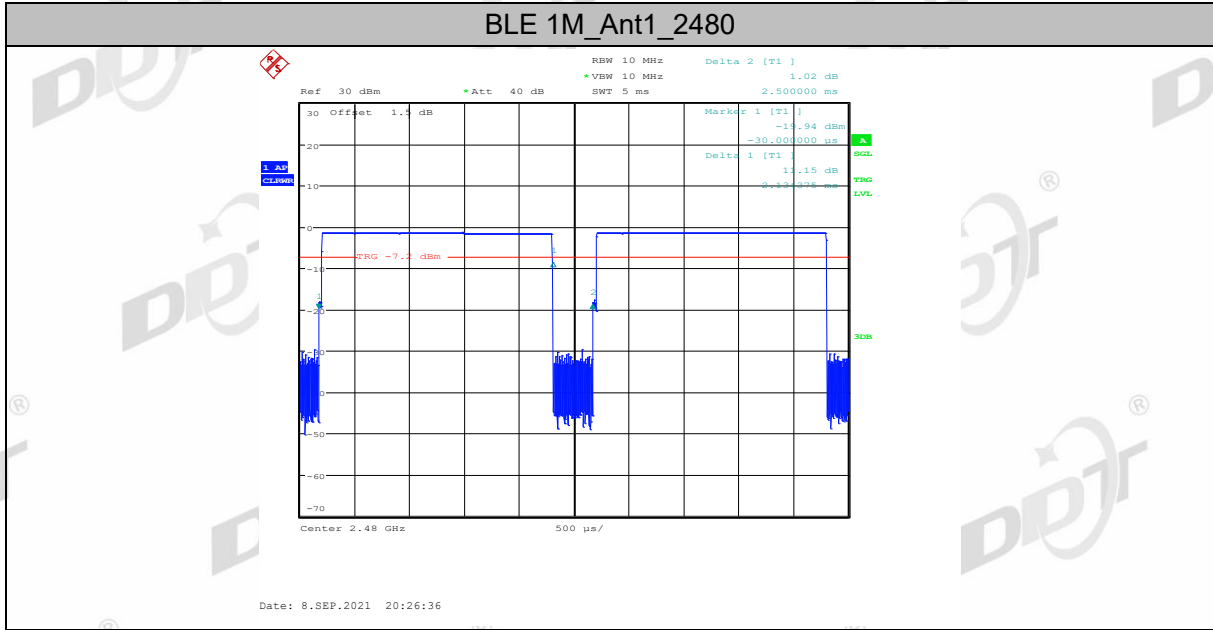

10. Radiated Emission

10.1. Block diagram of test setup

In 3 m Anechoic Chamber, test setup diagram for 9 kHz - 30 MHz:

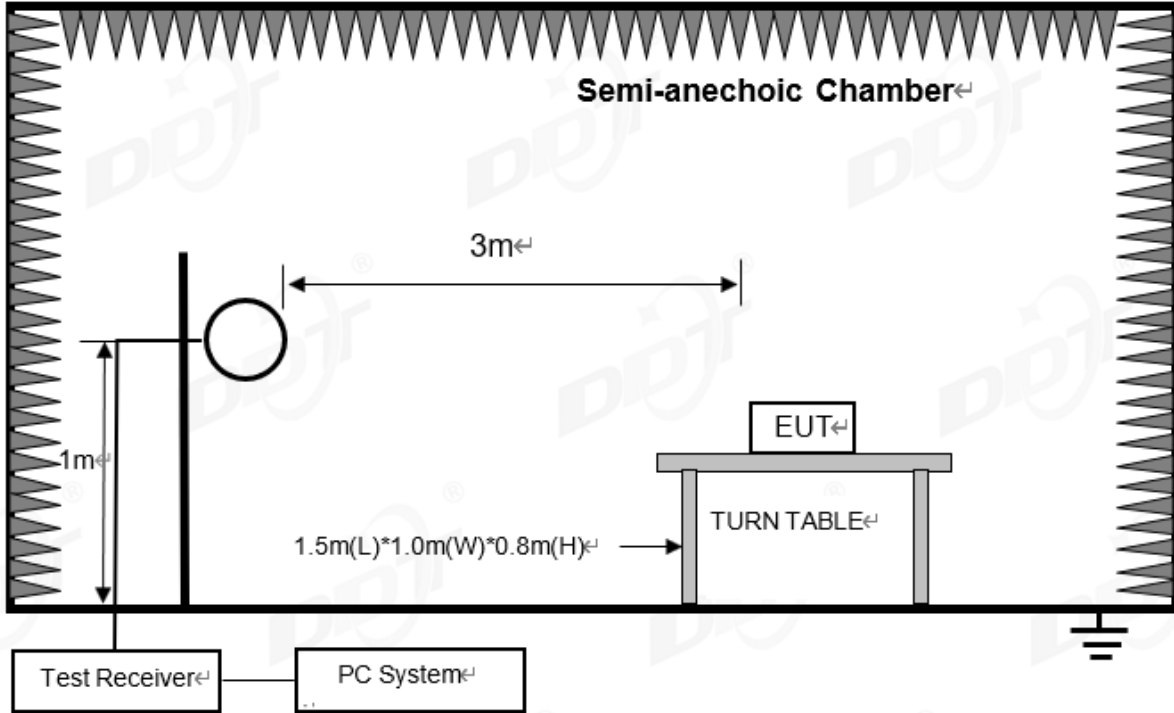

In 3 m Anechoic Chamber, test setup diagram for 30 MHz - 1 GHz:

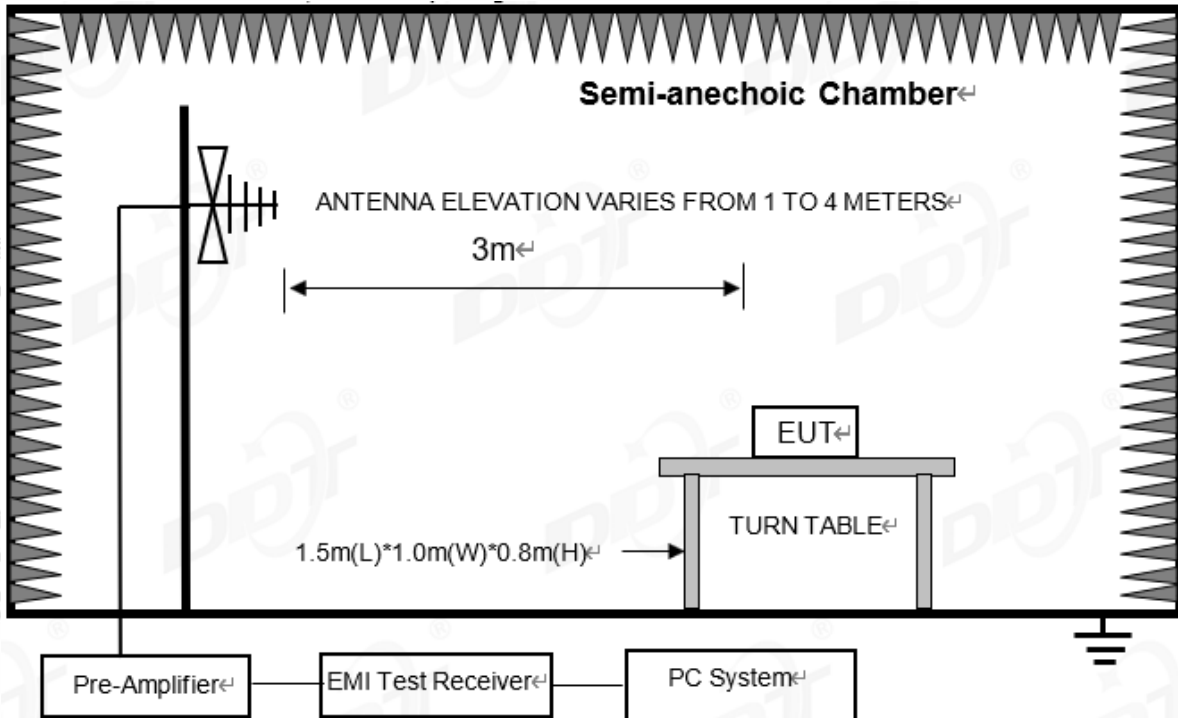

In 3 m Anechoic Chamber, test setup diagram for frequency above 1 GHz:

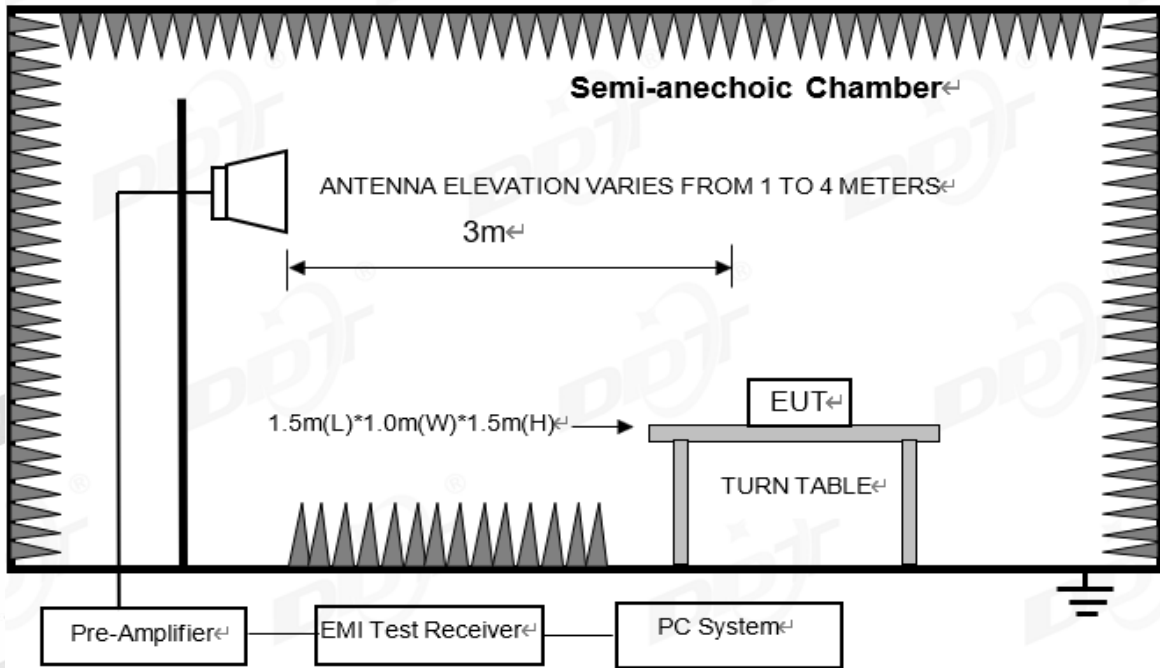

Note: For harmonic emissions test an appropriate high pass filter was inserted in the input port of AMP.

10.2. Limit

(1)FCC 15.205 Restricted frequency band

MHz	MHz	MHz	GHz
0.090-0.110	16.42-16.423	399.9-410	4.5-5.15
¹ 0.495-0.505	16.69475-16.69525	608-614	5.35-5.46
2.1735-2.1905	16.80425-16.80475	960-1240	7.25-7.75
4.125-4.128	25.5-25.67	1300-1427	8.025-8.5
4.1772&4.17775	37.5-38.25	1435-1626.5	9.0-9.2
4.2072&4.20775	73-74.6	1645.5-1646.5	9.3-9.5
6.215-6.218	74.8-75.2	1660-1710	10.6-12.7
6.26775-6.26825	108-121.94	1718.8-1722.2	13.25-13.4
6.31175-6.31225	123-138	2200-2300	14.47-14.5
8.291-8.294	149.9-150.05	2310-2390	15.35-16.2
8.362-8.366	156.52475-156.52525	2483.5-2500	17.7-21.4
8.37625-8.38675	156.7-156.9	2690-2900	22.01-23.12
8.41425-8.41475	162.0125-167.17	3260-3267	23.6-24.0
12.29-12.293	167.72-173.2	3332-3339	31.2-31.8
12.51975-12.52025	240-285	3345.8-3358	36.43-36.5
12.57675-12.57725	322-335.4	3600-4400	(²)
13.36-13.41			

¹Until February 1, 1999, this restricted band shall be 0.490-0.510 MHz.

²Above 38.6

(2) FCC 15.209 Limit.

FREQUENCY MHz	DISTANCE Meters	FIELD STRENGTHS LIMIT	
		$\mu\text{V}/\text{m}$	$\text{dB}(\mu\text{V})/\text{m}$
0.009 ~ 0.490	300	2400/F(kHz)	67.6-20log(F)
0.490 ~ 1.705	30	24000/F(kHz)	87.6-20log(F)
1.705 ~ 30.0	30	30	29.54
30 ~ 88	3	100	40.0
88 ~ 216	3	150	43.5
216 ~ 960	3	200	46.0
960 ~ 1000	3	500	54.0
Above 1000	3	74.0 dB(μV)/m (Peak) 54.0 dB(μV)/m (Average)	

Note: (1) The emission limits shown in the above table are based on measurements employing a CISPR QP detector except for the frequency bands 9 - 90 kHz, 110 - 490 kHz and above 1000 MHz. Radiated emissions limits in these three bands are based on measurements employing an average detector.

(2) At frequencies below 30 MHz, measurement may be performed at a distance closer than that specified, and the limit at closer measurement distance can be extrapolated by this formula: $\text{Limit}_{3\text{m}}(\text{dB}\mu\text{V}/\text{m}) = \text{Limit}_{30\text{m}}(\text{dB}\mu\text{V}/\text{m}) + 40\text{Log}(30\text{m}/3\text{m})$

(3) Limit for this EUT

All the emissions appearing within 15.205 restricted frequency bands shall not exceed the limits shown in 15.209, all the other emissions shall be at least 20 dB below the fundamental emissions or comply with 15.209 limits.

10.3. Test procedure

(1) EUT was placed on a non-metallic table, 80 cm above the ground plane inside a semi-anechoic chamber for below 1 G and 150 cm above the ground plane inside a semi-anechoic chamber for above 1 G.

(2) Test antenna was located 3 m from the EUT on an adjustable mast, and the antenna used as below table.

Test frequency range	Test antenna used	Test antenna distance
9 kHz - 30 MHz	Active Loop antenna	3 m
30 MHz - 1 GHz	Trilog Broadband Antenna	3 m
1 GHz - 18 GHz	Double Ridged Horn Antenna (1 GHz - 18 GHz)	3 m
18 GHz - 40 GHz	Horn Antenna (18 GHz - 40 GHz)	1 m

According to ANSI C63.10:2013 clause 6.4.4.2 and 6.5.3, for measurements below 30 MHz, the loop antenna was positioned with its plane vertical from the EUT and rotated about its vertical axis for maximum response at each azimuth position around the EUT. And the loop antenna also is positioned with its plane horizontal at the specified distance from the EUT. The center of the loop is 1 m above the ground. For measurement above 30 MHz, the Trilog Broadband Antenna or Horn Antenna was located 3 m from EUT, Measurements were made with the antenna positioned in both the horizontal and vertical planes of Polarization, and the measurement antenna was varied from 1 m to 4 m. in height above the reference ground plane to obtain the maximum signal strength.

(3) Below pre-scan procedure was first performed in order to find prominent frequency spectrum radiated emissions from 9 kHz to 25 GHz:

(a) Scanning the peak frequency spectrum with the antenna specified in step (3), and the EUT was rotated 360 degree, the antenna height was varied from 1 m to 4 m (Except loop antenna, it's fixed 1 m above ground.)

(b) Change work frequency or channel of device if practicable.

(c) Change modulation type of device if practicable.

(d) Change power supply range from 85% to 115% of the rated supply voltage

(e) Rotated EUT through three orthogonal axes to determine the attitude of EUT arrangement produces highest emissions.

Spectrum frequency from 9 kHz to 25 GHz (tenth harmonic of fundamental frequency) was investigated, and no any obvious emission were detected from 9 kHz to 30 MHz and 18 GHz to 25 GHz, so below final test was performed with frequency range from 30 MHz to 18 GHz.

(4) For final emissions measurements at each frequency of interest, the EUT was rotated and the antenna height was varied between 1 m and 4 m in order to maximize the emission. Measurements in both horizontal and vertical polarities were made and the data was recorded. In order to find the maximum emission, the relative positions of equipments and all of the interface cables were changed according to ANSI C63.10:2013 on Radiated Emission test.

(5) The emissions from 9 kHz to 1 GHz were measured based on CISPR QP detector except for the frequency bands 9 - 90 kHz, 110 - 490 kHz, for emissions from 9 kHz - 90 kHz, 110 kHz - 490 kHz and above 1 GHz were measured based on average detector, for emissions above 1 GHz, peak emissions also be measured and need comply with Peak limit.

(6) The emissions from 9 kHz to 1 GHz, QP or average values were measured with EMI receiver with below RBW

Frequency band	RBW
9 kHz - 150 kHz	200 Hz
150 kHz - 30 MHz	9 kHz
30 MHz - 1 GHz	120 kHz

(7) For emissions above 1 GHz, both Peak and Average level were measured with Spectrum Analyzer, and the RBW is set at 1 MHz, VBW is set at 3 MHz for Peak measure; According ANSI C63.10:2013 clause 4.1.4.2.2 procedure for average measure.

(8) X axis, Y axis, Z axis are tested, and worse setup X axis is reported.

10.4. Test result

Pass. (See below detailed test result)

All the emissions except fundamental emission from 9 kHz to 25 GHz were comply with 15.209 limit.

Note1: According exploratory test, the emission levels are 20 dB below the limit detected from 9 kHz to 30 MHz and 18 GHz to 25 GHz, so the final test was performed with frequency range from 30 MHz to 18 GHz and recorded in below.

Note2: For emissions below 1 GHz, according exploratory explorer test, when change Tx mode and channel, have no distinct influence on emissions level, so for emissions below 1 GHz, the final test was only performed with EUT working in right side GFSK, Tx 2480 MHz mode.

Note3: For emissions above 1 GHz. If peak results comply with AV limit, AV Result is deemed to comply with AV limit.

Radiated Emission test (below 1 GHz)

TR-4-E-009 Radiated Emission Test Result

Test Site : DDT 3m Chamber 3#	D:\2021 report data\Q21042026-2E Pokit PRO\FCC BELOW 1G\FCC BELOW 1G_00001.EMI
Test Date : 2021-09-13	Tested By : Kennys Zhang
EUT : Pokit PRO	Model Number : Pokit PRO
Power Supply : Battery	Test Mode : TX Mode
Condition : Temp:24.7°,Humi:51.2%,Press:100.1kPa Antenna/Distance : VLUB 9163 3#/3m/VERTICAL	

Memo :

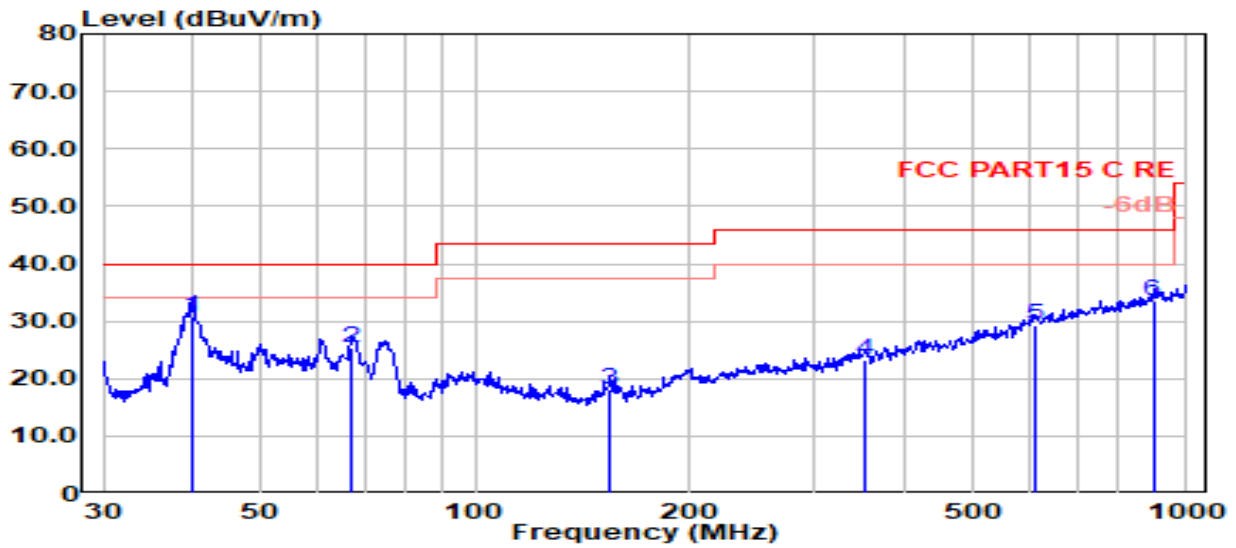

Item (Mark)	Freq. (MHz)	Read Level (dBμV)	Antenna Factor (dB/m)	Cable Loss (dB)	Result Level (dBμV/m)	Limit Line (dBμV/m)	Over Limit (dB)	Detector	Polarization
1	39.85	14.61	12.50	3.62	30.73	40.00	-9.27	QP	VERTICAL
2	67.20	12.47	9.18	3.69	25.34	40.00	-14.66	QP	VERTICAL
3	154.28	5.77	8.23	4.08	18.08	43.50	-25.42	QP	VERTICAL
4	354.18	3.21	15.02	4.89	23.12	46.00	-22.88	QP	VERTICAL
5	614.21	4.38	19.12	5.65	29.14	46.00	-16.86	QP	VERTICAL
6	897.00	5.26	21.98	6.36	33.61	46.00	-12.39	QP	VERTICAL

Note: 1. Result Level = Read Level + Antenna Factor + Cable loss.
 2. If Peak Result complies with QP limit, QP Result is deemed to comply with QP limit.
 3. Test setup: RBW: 120 kHz, VBW: 300 kHz, Sweep time: auto

TR-4-E-009 Radiated Emission Test Result

Test Site : DDT 3m Chamber 3# **D:\2021 report data\Q21042026-2E Pokit PRO\FCC BELOW 1G\FCC BELOW 1G_00002.EMI**
Test Date : 2021-09-13 **Tested By** : Kennys Zhang
EUT : Pokit PRO **Model Number** : Pokit PRO
Power Supply : Battery **Test Mode** : TX Mode
Condition : Temp:24.7°,Humi:51.2%,Press:100.1kPa **Antenna/Distance** : VLUB 9163 3#/3m/HORIZONTAL
Memo :

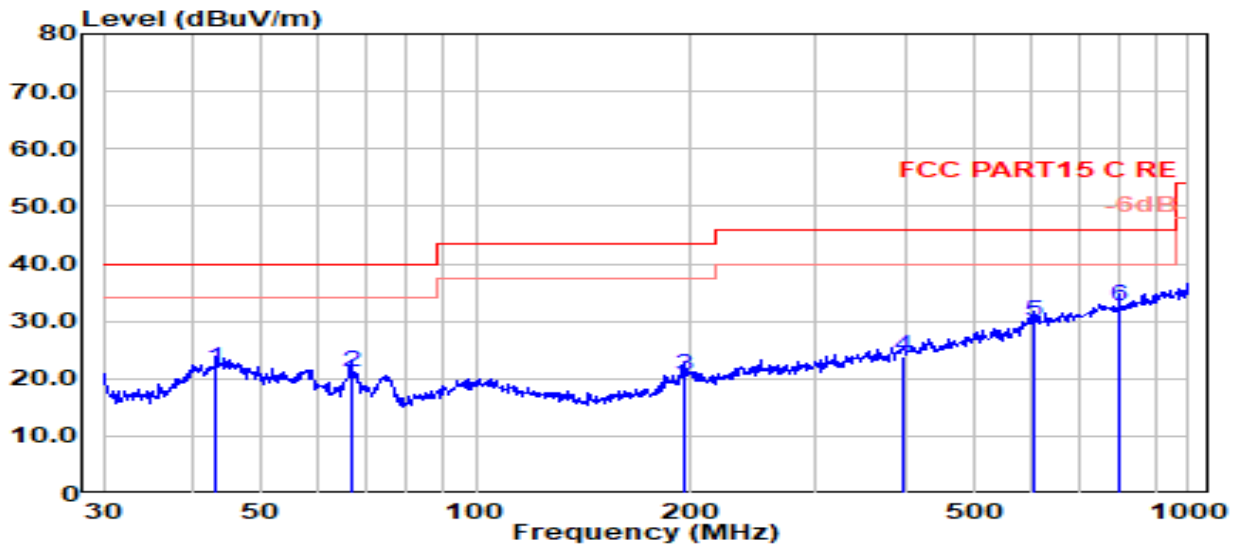

Item (Mark)	Freq. (MHz)	Read Level (dBuV)	Antenna Factor (dB/m)	Cable Loss (dB)	Result Level (dBuV/m)	Limit Line (dBuV/m)	Over Limit (dB)	Detector	Polarization
1	43.20	3.68	14.52	3.65	21.85	40.00	-18.15	QP	HORIZONTAL
2	66.73	8.19	9.23	3.69	21.11	40.00	-18.89	QP	HORIZONTAL
3	196.51	4.38	11.80	4.33	20.51	43.50	-22.99	QP	HORIZONTAL
4	399.03	3.18	15.50	5.05	23.72	46.00	-22.28	QP	HORIZONTAL
5	605.66	4.94	19.20	5.62	29.76	46.00	-16.24	QP	HORIZONTAL
6	798.98	5.88	20.70	6.17	32.75	46.00	-13.25	QP	HORIZONTAL

Note: 1. Result Level = Read Level + Antenna Factor + Cable loss.
 2. If Peak Result complies with QP limit, QP Result is deemed to comply with QP limit.
 3. Test setup: RBW: 120 kHz, VBW: 300 kHz, Sweep time: auto

Radiated Emission test (above 1 GHz)

Freq. (MHz)	Read level (dBμV)	Antenna Factor (dB/m)	PRM Factor (dB)	Cable Loss (dB)	Result Level (dBμV/m)	Limit (dBμV/m)	Margin (dB)	Detector type	Polarization
Tx mode 2402 MHz									
4808.00	42.94	31.34	6.79	43.35	37.72	74.00	-36.28	Peak	HORIZONTAL
6406.00	44.53	33.80	7.73	43.30	42.76	74.00	-31.24	Peak	HORIZONTAL
9704.00	42.76	38.74	9.91	42.08	49.34	74.00	-24.66	Peak	HORIZONTAL
14039.00	40.71	40.97	12.27	42.47	51.48	74.00	-22.52	Peak	HORIZONTAL
16963.00	38.01	40.38	13.85	42.20	50.03	74.00	-23.97	Peak	HORIZONTAL
17949.00	28.62	48.51	13.76	42.48	48.41	54.00	-5.59	Average	HORIZONTAL
17949.00	35.62	48.51	13.76	42.48	55.41	74.00	-18.59	Peak	HORIZONTAL
5182.00	44.96	31.80	7.07	43.25	40.57	74.00	-33.43	Peak	VERTICAL
7732.00	43.76	37.04	8.74	42.49	47.05	74.00	-26.95	Peak	VERTICAL
9891.00	42.76	38.78	10.14	42.16	49.52	74.00	-24.48	Peak	VERTICAL
12611.00	42.20	38.74	11.89	42.38	50.45	74.00	-23.55	Peak	VERTICAL
14617.00	40.37	41.52	12.29	42.01	52.17	74.00	-21.83	Peak	VERTICAL
17983.00	28.06	48.97	13.79	42.49	48.32	54.00	-5.68	Average	VERTICAL
17983.00	36.06	48.97	13.79	42.49	56.32	74.00	-17.68	Peak	VERTICAL

Tx mode 2440 MHz									
4723.00	46.22	31.14	6.69	43.42	40.61	74.00	-33.39	Peak	HORIZONTAL
7494.00	43.93	36.88	8.83	42.65	46.99	74.00	-27.01	Peak	HORIZONTAL
10775.00	42.02	39.96	10.48	42.74	49.71	74.00	-24.29	Peak	HORIZONTAL
14430.00	40.69	41.67	12.08	42.16	52.29	74.00	-21.71	Peak	HORIZONTAL
16266.00	40.02	38.34	12.93	42.27	49.01	74.00	-24.99	Peak	HORIZONTAL
17881.00	30.07	47.58	13.71	42.46	48.90	54.00	-5.10	Average	HORIZONTAL
17881.00	37.07	47.58	13.71	42.46	55.90	74.00	-18.10	Peak	HORIZONTAL
5352.00	44.82	31.80	7.10	43.31	40.41	74.00	-33.59	Peak	VERTICAL
7494.00	44.93	36.88	8.83	42.65	47.99	74.00	-26.01	Peak	VERTICAL
10452.00	41.91	39.79	10.35	42.52	49.54	74.00	-24.46	Peak	VERTICAL
13767.00	40.95	40.48	11.95	42.62	50.77	74.00	-23.23	Peak	VERTICAL
16453.00	38.20	38.79	13.12	42.25	47.86	74.00	-26.14	Peak	VERTICAL
17949.00	28.71	48.51	13.76	42.48	48.50	54.00	-5.50	Average	VERTICAL
17949.00	37.71	48.51	13.76	42.48	57.50	74.00	-16.50	Peak	VERTICAL

Tx mode 2480 MHz									
4196.00	47.45	29.99	6.18	43.84	39.78	74.00	-34.22	Peak	HORIZONTAL
7460.00	43.75	36.79	8.77	42.68	46.63	74.00	-27.37	Peak	HORIZONTAL
10537.00	41.93	39.91	10.38	42.58	49.63	74.00	-24.37	Peak	HORIZONTAL
13189.00	41.36	39.32	11.31	42.91	49.08	74.00	-24.92	Peak	HORIZONTAL
16164.00	38.86	38.09	12.82	42.28	47.49	74.00	-26.51	Peak	HORIZONTAL
18000.00	27.93	49.20	13.80	42.50	48.43	54.00	-5.57	Average	HORIZONTAL
18000.00	36.93	49.20	13.80	42.50	57.43	74.00	-16.57	Peak	HORIZONTAL
4281.00	45.37	30.16	6.24	43.78	38.00	74.00	-36.00	Peak	VERTICAL
6508.00	43.43	34.12	7.81	43.25	42.12	74.00	-31.88	Peak	VERTICAL
9058.00	42.06	37.90	9.54	41.82	47.68	74.00	-26.32	Peak	VERTICAL
11897.00	42.45	39.42	11.08	41.55	51.40	74.00	-22.60	Peak	VERTICAL
14107.00	41.13	41.09	12.24	42.41	52.05	74.00	-21.95	Peak	VERTICAL
17966.00	28.96	48.74	13.77	42.49	48.99	54.00	-5.01	Average	VERTICAL
17966.00	36.96	48.74	13.77	42.49	56.99	74.00	-17.01	Peak	VERTICAL
Verdict: Pass									

Note:

1. Result Level = Read Level + Antenna Factor + Cable loss - PRM Factor.
2. For emissions above 1GHz. If peak results comply with AV limit, AV Result is deemed to comply with AV limit.

11. Emissions in Restricted Frequency Bands

11.1. Block diagram of test setup

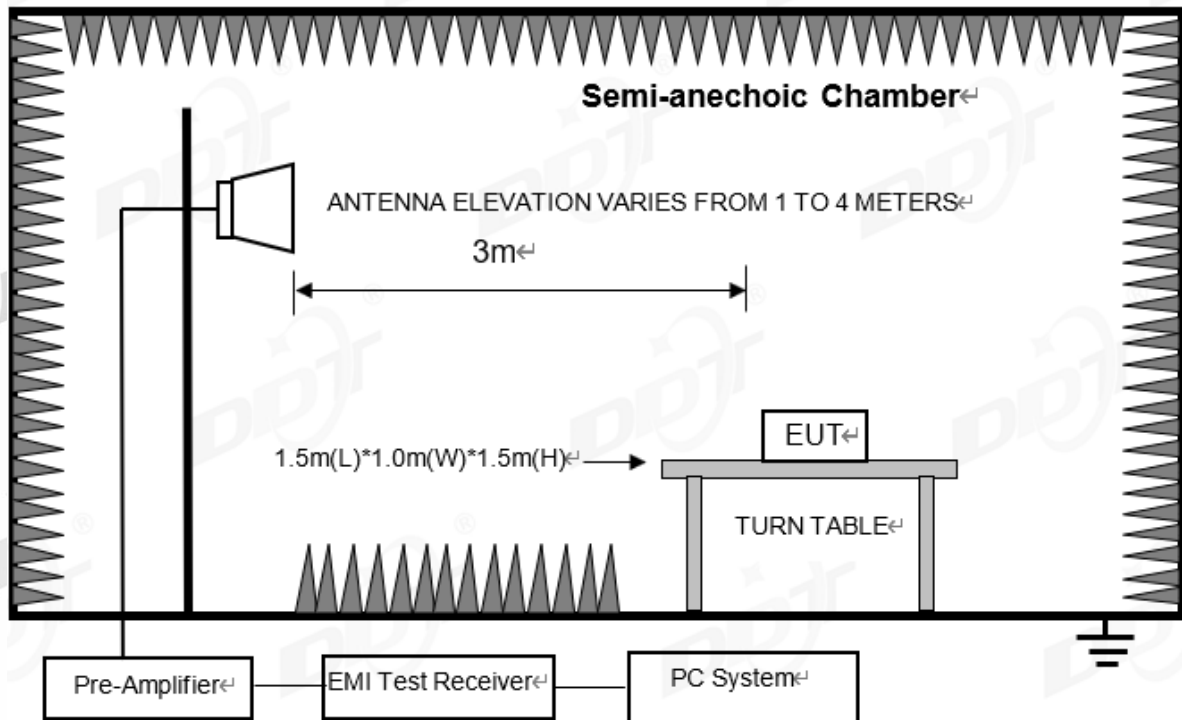

11.2. Limit

All restriction band should comply with 15.209, other emission should be at least 20 dB below the fundamental.

11.3. Test procedure

Same with clause 10.3 except change investigated frequency range from 2310 MHz to 2410 MHz and 2470 MHz to 2500 MHz.

Remark: All restriction band have been tested, and only the worst case is shown in report.

11.4. Test result

Pass. (See below detailed test result)

TR-4-E-009 Radiated Emission Test Result

Test Site : DDT 3m Chamber 3#
Test Date : 2021-09-13
EUT : Pokit PRO
Power Supply : Battery
Condition : Temp:24.7°,Humi:51.2%,Press:100.1kPa
Memo : BLE 2402
Tested By : Kennys Zhang
Model Number : POK-PRO
Test Mode : TX Mode
Antenna/Distance : 2020 BBHA
 9120D/3m/HORIZONTAL
 D:\2021 report data\Q21042026-2E Pokit PRO\FCC ABOVE 1G\FCC ABOVE 1G_00003.EMI

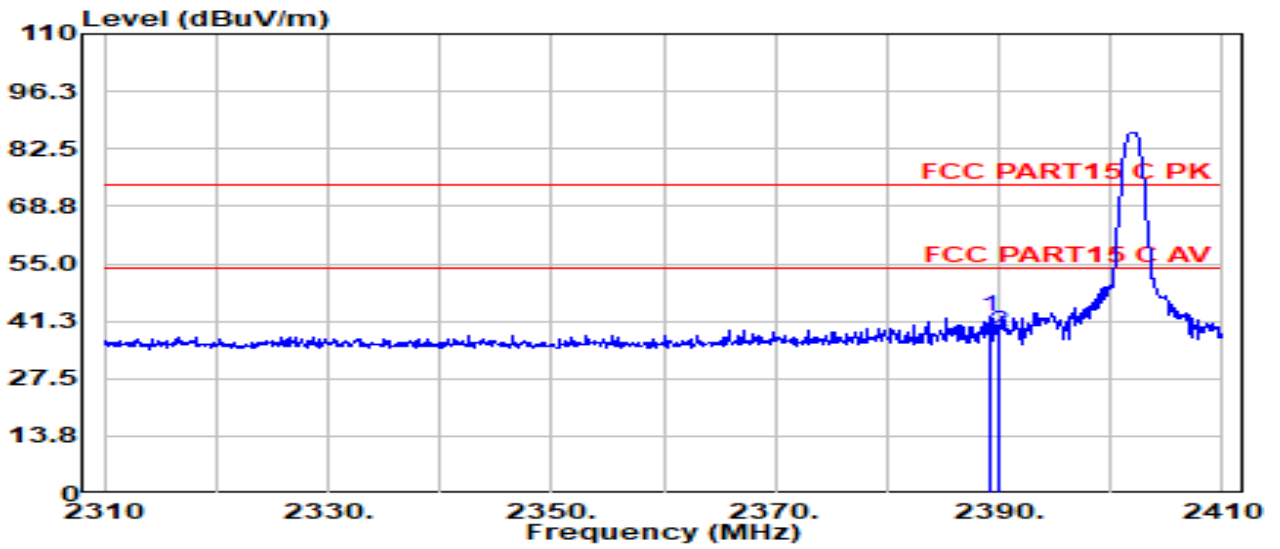

Item (Mark)	Freq. (MHz)	Read Level (dBμV)	Antenna Factor (dB/m)	Cable Loss (dB)	PRM Factor (dB)	Result Level (dBUV/m)	Limit Line (dBUV/m)	Over Limit (dB)	Detector	Polarization
1	2389.20	52.99	27.57	4.79	43.09	42.27	74.00	-31.73	Peak	HORIZONTAL
2	2390.00	49.19	27.57	4.80	43.09	38.46	74.00	-35.54	Peak	HORIZONTAL

Note:

1. Result Level = Read Level + Antenna Factor + Cable loss - PRM Factor.
2. If Peak Result complies with AV limit, AV Result is deemed to comply with AV limit.
3. Test setup: RBW: 1 MHz, VBW: 3 MHz, Sweep time: auto.

TR-4-E-009 Radiated Emission Test Result

Test Site : DDT 3m Chamber 3#
Test Date : 2021-09-13
EUT : Pokit PRO
Power Supply : Battery
Condition : Temp:24.7°,Humi:51.2%,Press:100.1kPa
Memo : BLE 2402
Tested By : Kennys Zhang
Model Number : POK-PRO
Test Mode : TX Mode
Antenna/Distance : 2020 BBHA 9120D/3m/VERTICAL

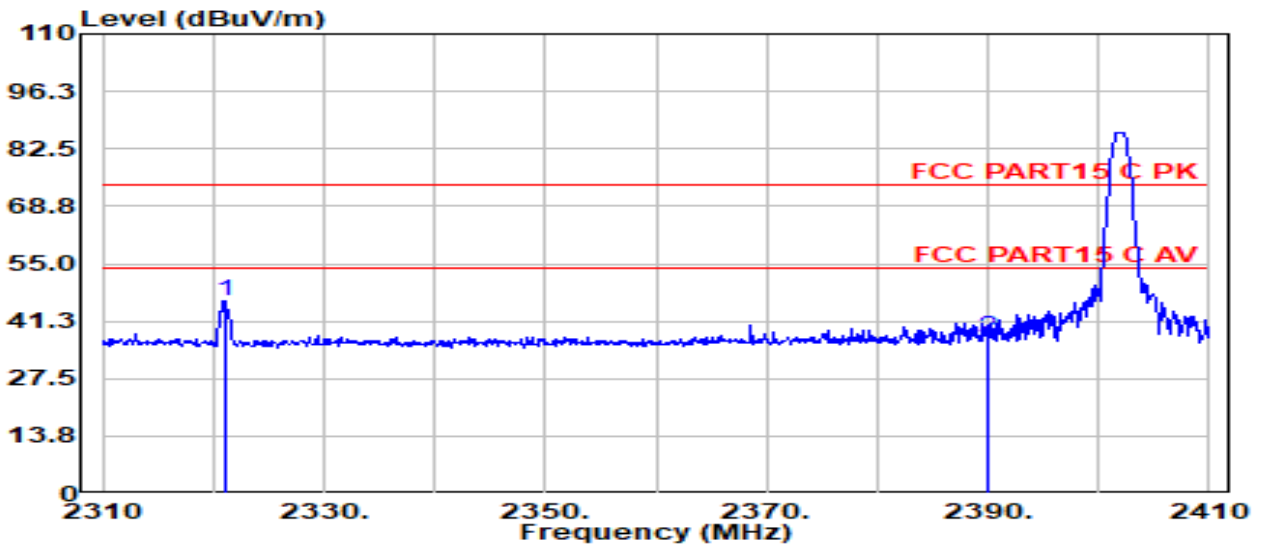

Item (Mark)	Freq. (MHz)	Read Level (dBμV)	Antenna Factor (dB/m)	Cable Loss (dB)	PRM Factor (dB)	Result Level (dBμV/m)	Limit Line (dBμV/m)	Over Limit (dB)	Detector	Polarization
1	2321.10	57.02	27.36	4.71	43.02	46.07	74.00	-27.93	Peak	VERTICAL
2	2390.00	48.01	27.57	4.80	43.09	37.29	74.00	-36.71	Peak	VERTICAL

Note:

1. Result Level = Read Level + Antenna Factor + Cable loss - PRM Factor.
2. If Peak Result complies with AV limit, AV Result is deemed to comply with AV limit.
3. Test setup: RBW: 1 MHz, VBW: 3 MHz, Sweep time: auto.

TR-4-E-009 Radiated Emission Test Result

Test Site : DDT 3m Chamber 3#
Test Date : 2021-09-13
EUT : Pokit PRO
Power Supply : Battery
Condition : Temp:24.7°,Humi:51.2%,Press:100.1kPa
Memo : BLE 2480

Tested By : Kennys Zhang
Model Number : POK-PRO
Test Mode : TX Mode
Antenna/Distance : 2020 BBHA 9120D/3m/VERTICAL

D:\2021 report data\Q21042026-2E Pokit PRO\FCC ABOVE 1G\FCC ABOVE 1G_00005.EMI

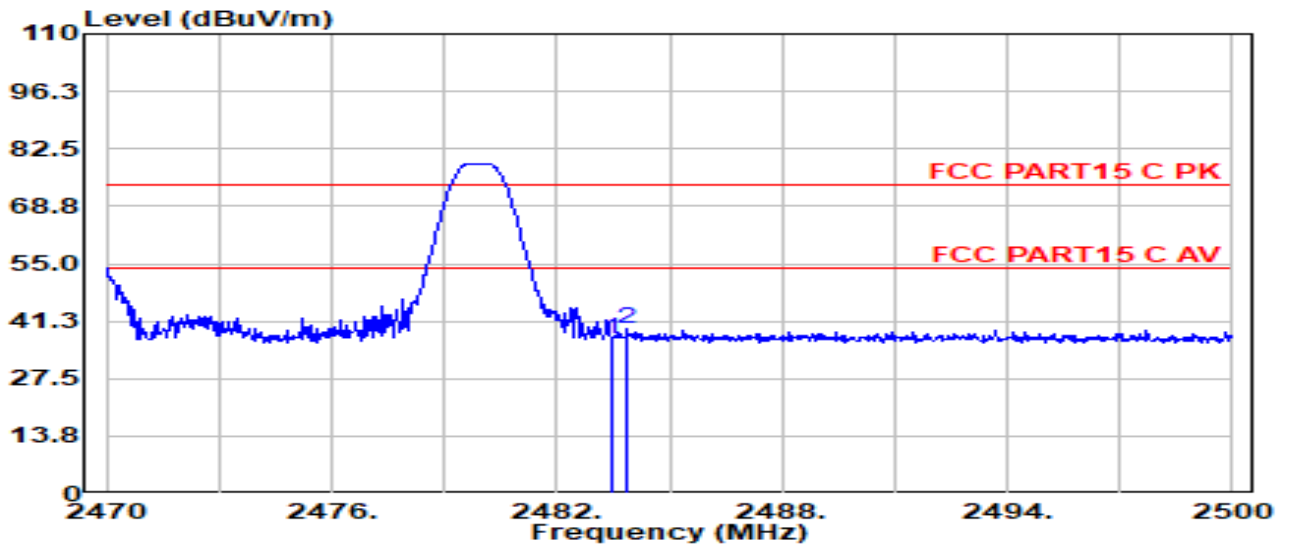

Item (Mark)	Freq. (MHz)	Read Level (dBμV)	Antenna Factor (dB/m)	Cable Loss (dB)	PRM Factor (dB)	Result Level (dBμV/m)	Limit Line (dBμV/m)	Over Limit (dB)	Detector	Polarization
1	2483.50	47.20	27.85	4.91	43.18	36.77	74.00	-37.23	Peak	VERTICAL
2	2483.89	49.69	27.85	4.91	43.18	39.27	74.00	-34.73	Peak	VERTICAL

Note:

1. Result Level = Read Level + Antenna Factor + Cable loss - PRM Factor.
2. If Peak Result complies with AV limit, AV Result is deemed to comply with AV limit.
3. Test setup: RBW: 1 MHz, VBW: 3 MHz, Sweep time: auto.

TR-4-E-009 Radiated Emission Test Result

Test Site : DDT 3m Chamber 3#
Test Date : 2021-09-13
EUT : Pokit PRO
Power Supply : Battery
Condition : Temp:24.7°,Humi:51.2%,Press:100.1kPa
Memo : BLE 2480
D:\2021 report data\Q21042026-2E Pokit PRO\FCC ABOVE 1G\FCC ABOVE 1G_00006.EMI
Tested By : Kennys Zhang
Model Number : POK-PRO
Test Mode : TX Mode
Antenna/Distance : 2020 BBHA
 9120D/3m/HORIZONTAL

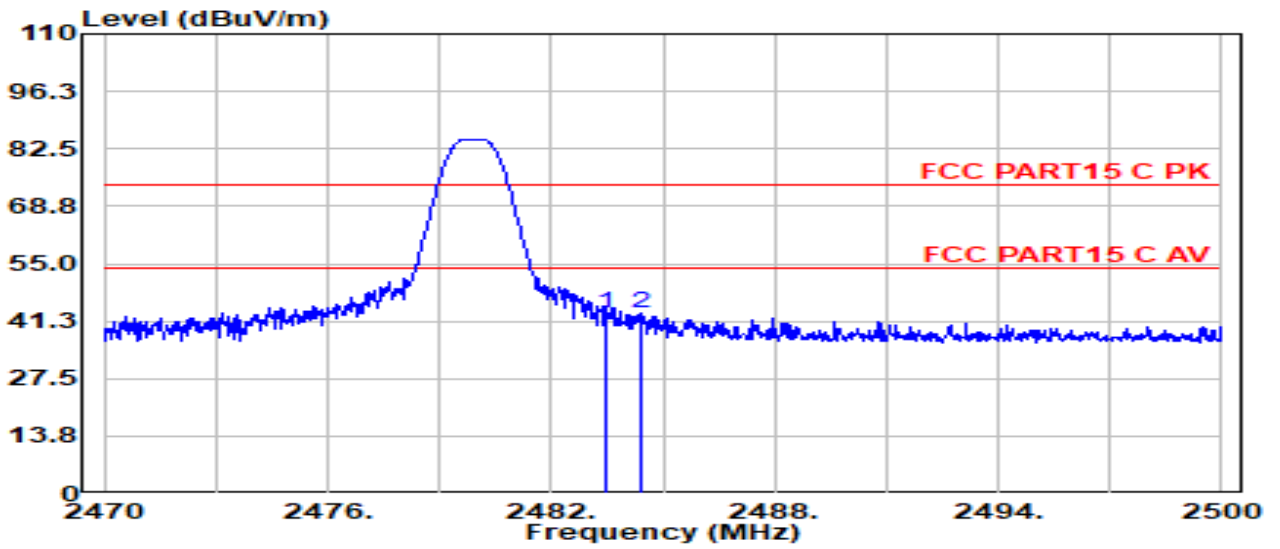

Item (Mark)	Freq. (MHz)	Read Level (dBμV)	Antenna Factor (dB/m)	Cable Loss (dB)	PRM Factor (dB)	Result Level (dBμV/m)	Limit Line (dBμV/m)	Over Limit (dB)	Detector	Polarization
1	2483.50	53.47	27.85	4.91	43.18	43.04	74.00	-30.96	Peak	HORIZONTAL
2	2484.43	53.69	27.85	4.91	43.18	43.27	74.00	-30.73	Peak	HORIZONTAL

Note:

1. Result Level = Read Level + Antenna Factor + Cable loss - PRM Factor.
2. If Peak Result complies with AV limit, AV Result is deemed to comply with AV limit.
3. Test setup: RBW: 1 MHz, VBW: 3 MHz, Sweep time: auto.

12. Power Line Conducted Emission

12.1. Block diagram of test setup

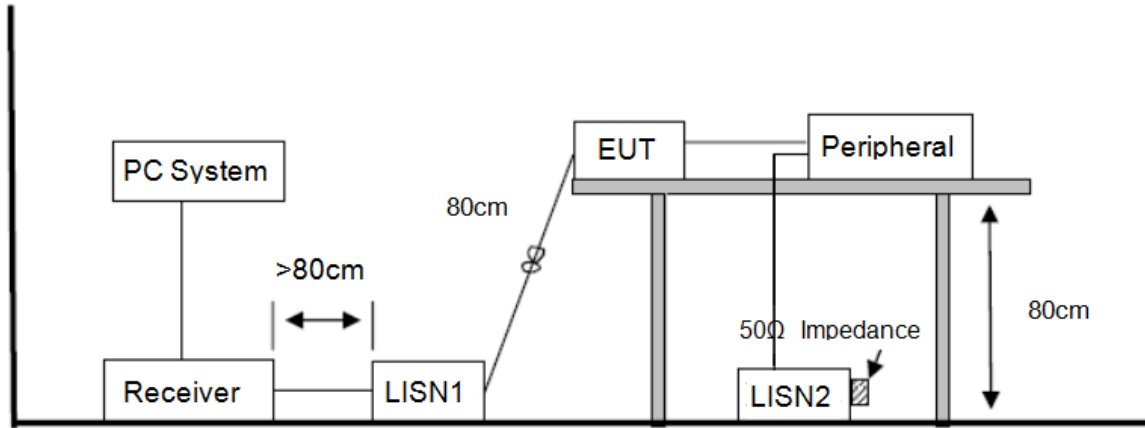

12.2. Power line conducted emission limits

Frequency	Quasi-Peak Level dB(μV)	Average Level dB(μV)
150 kHz ~ 500 kHz	66 ~ 56*	56 ~ 46*
500 kHz ~ 5 MHz	56	46
5 MHz ~ 30 MHz	60	50

Note 1: * Decreasing linearly with logarithm of frequency.

Note 2: The lower limit shall apply at the transition frequencies.

12.3. Test procedure

The EUT and Support equipment, if needed, were put placed on a non-metallic table, 80cm above the ground plane.

Configuration EUT to simulate typical usage as described in clause 2.4 and test equipment as described in clause 10.2 of this report.

All I/O cables were positioned to simulate typical actual usage as per ANSI C63.10.

All support equipment power received from a second LISN.

Emissions were measured on each current carrying line of the EUT using an EMI Test Receiver connected to the LISN powering the EUT.

The Receiver scanned from 150 kHz to 30 MHz for emissions in each of the test modes.

During the above scans, the emissions were maximized by cable manipulation.

The test mode(s) described in clause 2.4 were scanned during the preliminary test.

After the preliminary scan, we found the test mode producing the highest emission level.

The EUT configuration and worse cable configuration of the above highest emission levels were recorded for reference of the final test.

EUT and support equipment were set up on the test bench as per the configuration with highest emission level in the preliminary test.

A scan was taken on both power lines, Neutral and Line, recording at least the six highest emissions.

Emission frequency and amplitude were recorded into a computer in which correction factors were used to calculate the emission level and compare reading to the applicable limit.

The test data of the worst-case condition(s) was recorded.

The bandwidth of test receiver is set at 9 kHz.

12.4. Test result

Pass. (See below detailed test result)

Note1: All emissions not reported below are too low against the prescribed limits.

Note2: “----” means Peak detection; “----” means Average detection.

Note3: Pre-test AC conducted emission at both voltage AC 120V/60Hz and AC 240V/50Hz, recorded worse case.

TR-4-E-010 Conducted Emission Test Result

Test Site : DDT 5# Shield Room **D:\2021 report data\Q21042026-2E\CE.EM6**
Test Date : 2021-09-13 **Tested By** : Ziqin
EUT : Pokit PRO **Model Number** : POK-PRO
Power Supply : AC 120V/60Hz **Test Mode** : Tx mode
Condition : Temp:23.2°C,Humi:54.1%,Press:101.4kPa **LISN** : 2020 ENV 216 2#/NEUTRAL
Memo :

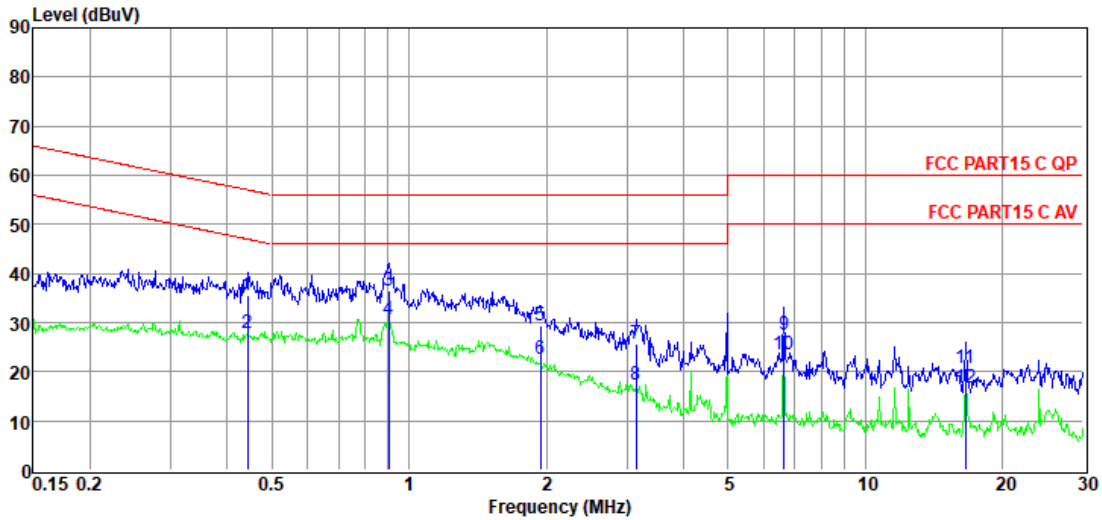

Item (Mark)	Freq. (MHz)	Read Level (dBμV)	LISN Factor (dB)	Cable Loss (dB)	Pulse Limiter Factor (dB)	Result Level (dBμV)	Limit Line (dBμV)	Over Limit (dB)	Detector	Phase
1	0.44	16.15	9.40	0.05	10.01	35.61	57.02	-21.41	QP	NEUTRAL
2	0.44	8.47	9.40	0.05	10.01	27.93	47.02	-19.09	Average	NEUTRAL
3	0.90	17.15	9.41	0.08	10.01	36.65	56.00	-19.35	QP	NEUTRAL
4	0.90	11.02	9.41	0.08	10.01	30.52	46.00	-15.48	Average	NEUTRAL
5	1.94	10.01	9.41	0.08	10.01	29.51	56.00	-26.49	QP	NEUTRAL
6	1.94	3.03	9.41	0.08	10.01	22.53	46.00	-23.47	Average	NEUTRAL
7	3.14	6.03	9.43	0.09	10.01	25.56	56.00	-30.44	QP	NEUTRAL
8	3.14	-2.10	9.43	0.09	10.01	17.43	46.00	-28.57	Average	NEUTRAL
9	6.63	8.02	9.52	0.10	10.01	27.65	60.00	-32.35	QP	NEUTRAL
10	6.63	3.79	9.52	0.10	10.01	23.42	50.00	-26.58	Average	NEUTRAL
11	16.57	1.06	9.60	0.12	10.02	20.80	60.00	-39.20	QP	NEUTRAL
12	16.57	-2.94	9.60	0.12	10.02	16.80	50.00	-33.20	Average	NEUTRAL

- Note:
1. Result Level = Read Level + LISN Factor + Pulse Limiter Factor + Cable loss.
 2. If QP Result complies with AV limit, AV Result is deemed to comply with AV limit.
 3. Test setup: RBW: 200 Hz (9 kHz—150 kHz), 9 kHz (150 kHz—30 MHz).
 4. Step size: 80Hz (0.009MHz-0.15MHz), 4 kHz (0.15MHz-30MHz), Scan time: auto.

TR-4-E-010 Conducted Emission Test Result

Test Site : DDT 5# Shield Room D:\2021 report data\Q21042026-2E\CE.EM6
Test Date : 2021-09-13 **Tested By** : Ziqin
EUT : Pokit PRO **Model Number** : POK-PRO
Power Supply : AC 120V/60Hz **Test Mode** : Tx mode
Condition : Temp:23.2°C,Humi:54.1%,Press:101.4kPa **LISN** : 2020 ENV 216 2#/LINE
Memo :

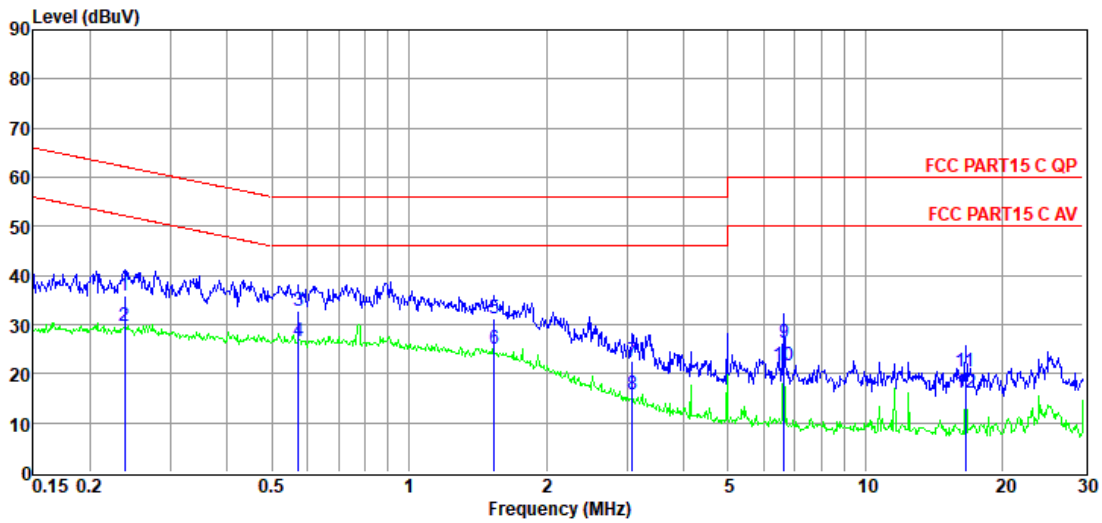

Item (Mark)	Freq. (MHz)	Read Level (dBμV)	LISN Factor (dB)	Cable Loss (dB)	Pulse Limiter Factor (dB)	Result Level (dBμV)	Limit Line (dBμV)	Over Limit (dB)	Detector	Phase
1	0.24	16.49	9.43	0.04	10.01	35.97	62.17	-26.20	QP	LINE
2	0.24	10.19	9.43	0.04	10.01	29.67	52.17	-22.50	Average	LINE
3	0.57	13.16	9.45	0.06	10.01	32.68	56.00	-23.32	QP	LINE
4	0.57	7.10	9.45	0.06	10.01	26.62	46.00	-19.38	Average	LINE
5	1.54	11.75	9.43	0.08	10.01	31.27	56.00	-24.73	QP	LINE
6	1.54	5.46	9.43	0.08	10.01	24.98	46.00	-21.02	Average	LINE
7	3.09	3.06	9.45	0.09	10.01	22.61	56.00	-33.39	QP	LINE
8	3.09	-3.84	9.45	0.09	10.01	15.71	46.00	-30.29	Average	LINE
9	6.63	6.49	9.54	0.10	10.01	26.14	60.00	-33.86	QP	LINE
10	6.63	2.02	9.54	0.10	10.01	21.67	50.00	-28.33	Average	LINE
11	16.57	0.79	9.55	0.12	10.02	20.48	60.00	-39.52	QP	LINE
12	16.57	-3.51	9.55	0.12	10.02	16.18	50.00	-33.82	Average	LINE

Note:

1. Result Level = Read Level + LISN Factor + Pulse Limiter Factor + Cable loss.
2. If QP Result complies with AV limit, AV Result is deemed to comply with AV limit.
3. Test setup: RBW: 200 Hz (9 kHz—150 kHz), 9 kHz (150 kHz—30 MHz).
4. Step size: 80Hz (0.009MHz-0.15MHz), 4 kHz (0.15MHz-30MHz), Scan time: auto.

13. Antenna Requirements

13.1. Limit

For intentional device, according to FCC 47 CFR Section 15.203, an intentional radiator shall be designed to ensure that no antenna other than that furnished by the responsible party shall be used with the device. And according to FCC 47 CFR Section 15.247 (b), if transmitting antennas of directional gain greater than 6dBi are used, the power shall be reduced by the amount in dB that the directional gain of the antenna exceeds 6dBi.

13.2. Result

There is no other antenna other than that furnished by the responsible party shall be used with the device; the maximum peak gain is 0.5 dBi.