

## FCC TEST REPORT

For

Shenzhen Jiayz photo industrial., Ltd

Wireless Handheld Microphone

Test Model: BY-WHM8 PRO

Additional Model No.: WMX-20 TH

Prepared for : Shenzhen Jiayz photo industrial., Ltd  
Address : A16 Building, Intelligent Terminal Industrial Park of Silicon Valley  
Power, Guanlan, Longhua District, Shenzhen, China

Prepared by : Shenzhen LCS Compliance Testing Laboratory Ltd.  
Address : 101, 201 Bldg A & 301 Bldg C, Juji Industrial Park Yabianxueziwei,  
Shajing Street, Baoan District, Shenzhen, 518000, China

Tel : (+86)755-82591330  
Fax : (+86)755-82591332  
Web : www.LCS-cert.com  
Mail : webmaster@LCS-cert.com

Date of receipt of test sample : April 22, 2021  
Number of tested samples : 1  
Sample No : 210414102A  
Serial number : Prototype  
Date of Test : April 22, 2021 ~ May 21, 2021  
Date of Report : May 21, 2021

**FCC TEST REPORT  
FCC CFR 47 PART 74**

**Report Reference No.** ..... : **LCS210414102AEA**

**Date of Issue** ..... : May 21, 2021

**Testing Laboratory Name** ..... : **Shenzhen LCS Compliance Testing Laboratory Ltd.**

**Address** ..... : 101, 201 Bldg A & 301 Bldg C, Juji Industrial Park Yabianxueziwei,  
Shajing Street, Baoan District, Shenzhen, 518000, China

**Testing Location/ Procedure** ..... : Full application of Harmonised standards   
Partial application of Harmonised standards   
Other standard testing method

**Applicant's Name** ..... : **Shenzhen Jiayz photo industrial., Ltd**

**Address** ..... : A16 Building, Intelligent Terminal Industrial Park of Silicon Valley  
Power, Guanlan, Longhua District, Shenzhen, China

**Test Specification**

**Standard**..... : FCC CFR 47 PART 74

**Test Report Form No.**..... : LCSEMC-1.0

**TRF Originator** ..... : Shenzhen LCS Compliance Testing Laboratory Ltd.

**Master TRF** ..... : Dated 2011-03

**Shenzhen LCS Compliance Testing Laboratory Ltd. All rights reserved.**

This publication may be reproduced in whole or in part for non-commercial purposes as long as the Shenzhen LCS Compliance Testing Laboratory Ltd. is acknowledged as copyright owner and source of the material. Shenzhen LCS Compliance Testing Laboratory Ltd. takes no responsibility for and will not assume liability for damages resulting from the reader's interpretation of the reproduced material due to its placement and context.

**EUT Description.** ..... : Wireless Handheld Microphone

**Trade Mark**..... : BOYA, MOVO

**Test Model** ..... : BY-WHM8 PRO

**Ratings**..... : Input: DC 3V by 2\*AA battery

**Result** ..... : **Positive**

**Compiled by:**

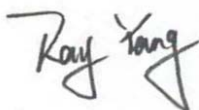

Ray Yang/ File administrators

**Supervised by:**

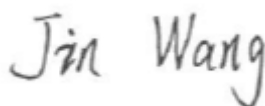

Jin Wang/ Technique principal

**Approved by:**



Gavin Liang/ Manager

## FCC -- TEST REPORT

<b>Test Report No. :</b> LCS210414102AEA	<u>May 21, 2021</u> Date of issue
--	--------------------------------------

Test Model..... : BY-WHM8 PRO

EUT..... : Wireless Handheld Microphone

**Applicant..... : Shenzhen Jiayz photo industrial., Ltd**

Address..... : A16 Building, Intelligent Terminal Industrial Park of Silicon Valley  
 Power, Guanlan, Longhua District, Shenzhen, China

Telephone..... : /

Fax..... : /

**Manufacturer..... : Shenzhen Jiayz photo industrial., Ltd**

Address..... : A16 Building, Intelligent Terminal Industrial Park of Silicon Valley  
 Power, Guanlan, Longhua District, Shenzhen, China

Telephone..... : /

Fax..... : /

**Factory..... : /**

Address..... : /

Telephone..... : /

Fax..... : /

<b>Test Result</b>	<b>Positive</b>
--------------------	-----------------

The test report merely corresponds to the test sample.  
 It is not permitted to copy extracts of these test result without the written permission of the test laboratory.

**Revision History**

Revision	Issue Date	Revisions	Revised By
000	May 21, 2021	Initial Issue	Gavin Liang

## TABLE OF CONTENTS

<b>1. GENERAL INFORMATION .....</b>	<b>6</b>
1.1. DESCRIPTION OF DEVICE (EUT) .....	6
1.2. HOST SYSTEM CONFIGURATION LIST AND DETAILS .....	7
1.3. EXTERNAL I/O CABLE .....	7
1.4. DESCRIPTION OF TEST FACILITY .....	7
1.5. STATEMENT OF THE MEASUREMENT UNCERTAINTY .....	8
1.6. MEASUREMENT UNCERTAINTY .....	8
1.7. DESCRIPTION OF TEST MODES .....	8
1.8. FREQUENCY OF CHANNELS .....	9
<b>2. TEST METHODOLOGY .....</b>	<b>10</b>
2.1. EUT CONFIGURATION.....	10
2.2. EUT EXERCISE .....	10
2.3. GENERAL TEST PROCEDURES .....	10
<b>3. SYSTEM TEST CONFIGURATION.....</b>	<b>11</b>
3.1. JUSTIFICATION.....	11
3.2. EUT EXERCISE SOFTWARE.....	11
3.3. SPECIAL ACCESSORIES .....	11
3.4. BLOCK DIAGRAM/SCHEMATICS.....	11
3.5. EQUIPMENT MODIFICATIONS .....	11
3.6. TEST SETUP .....	11
<b>4. SUMMARY OF TEST RESULTS.....</b>	<b>12</b>
<b>5. TEST RESULT .....</b>	<b>13</b>
5.1. TRANSMITTER OUTPUT POWER.....	13
5.2. OCCUPIED BANDWIDTH AND EMISSION MASK.....	15
5.3. TRANSMITTER UNWANTED EMISSIONS(RADIATED).....	17
5.5.FREQUENCY STABILITY.....	31
5.6.MODULATION CHARACTERISTICS .....	35
5.7.NECESSARY BANDWIDTH (BN) .....	37
<b>6. LIST OF MEASURING EQUIPMENTS .....</b>	<b>39</b>
<b>7. TEST SETUP PHOTOGRAPHS OF EUT.....</b>	<b>40</b>
<b>8. EXTERIOR PHOTOGRAPHS OF THE EUT.....</b>	<b>40</b>
<b>9. INTERIOR PHOTOGRAPHS OF THE EUT .....</b>	<b>40</b>

## 1. GENERAL INFORMATION

### 1.1. Description of Device (EUT)

EUT	: Wireless Handheld Microphone
Test Model	: BY-WHM8 PRO
Additional Models No.	: WMX-20 TH
Models Declaration	: PCB board, structure and internal of these model(s) are the same, So no additional models were tested
Hardware Version	: /
Software Version	: /
Power Supply	: Input: DC 3V by 2*AA battery
Operation Frequency	: 556.710MHz~595.660MHz
Modulation Type	: GFSK
Channel Number	: 96 Channels
Antenna Type	: Internal antenna
Antenna Gain	: 0dBi
Extreme temp. Tolerance	: -30°C to +50°C

### 1.2. Host System Configuration List and Details

Manufacturer	Description	Model	Serial Number	Certificate
--	--	--	--	--

### 1.3. External I/O Cable

I/O Port Description	Quantity	Cable
Micro USB Port	1	N/A

### 1.4. Description of Test Facility

NVLAP Accreditation Code is 600167-0.

FCC Designation Number is CN5024.

Test Firm Registration Number: 254912

CAB identifier is CN0071.

CNAS Registration Number is L4595.

The 3m-Semi anechoic test site fulfils CISPR 16-1-4 according to ANSI C63.4:2014 and CISPR 16-1-4:2010 SVSWR requirement for radiated emission above 1GHz.

### 1.5. Statement of the Measurement Uncertainty

The data and results referenced in this document are true and accurate. The reader is cautioned that there may be errors within the calibration limits of the equipment and facilities. The measurement uncertainty was calculated for all measurements listed in this test report acc. To CISPR 16 – 4 “Specification for radio disturbance and immunity measuring apparatus and methods – Part 4: Uncertainty in EMC Measurements” and is documented in the LCS quality system acc. To DIN EN ISO/IEC 17025. Furthermore, component and process variability of devices similar to that tested may result in additional deviation. The manufacturer has the sole responsibility of continued compliance of the device.

### 1.6. Measurement Uncertainty

Test Item	Frequency Range	Uncertainty	Note
Radiation Uncertainty	9KHz~30MHz	±3.10dB	(1)
	30MHz~200MHz	±2.96dB	(1)
	200MHz~1000MHz	±3.10dB	(1)
	1GHz~26.5GHz	±3.80dB	(1)
	26.5GHz~40GHz	±3.90dB	(1)
Conduction Uncertainty	150kHz~30MHz	±1.63dB	(1)
Power disturbance	30MHz~300MHz	±1.60dB	(1)

(1). This uncertainty represents an expanded uncertainty expressed at approximately the 95% confidence level using a coverage factor of k=2.

### 1.7. Description of Test Modes

The EUT has been tested under operating condition.

This test was performed with EUT in X, Y, Z position and the worst case was found when EUT in Y position.

The following operating modes were applied for the related test items. All test modes were tested, only the result of the worst case was recorded in the report.

Modulation Type	Test Channel	Test Frequency (MHz)
GFSK(A)	01	556.710
	24	566.140
	48	575.980
GFSK(B)	01	576.390
	24	585.820
	48	595.660



## 1.8. Frequency of Channels

### Channel A

Channel	Frequency (MHz)	Channel	Frequency (MHz)	Channel	Frequency (MHz)	Channel	Frequency (MHz)
1	556.71	13	561.63	25	566.55	37	571.47
2	557.12	14	562.04	26	566.96	38	571.88
3	557.53	15	562.45	27	567.37	39	572.29
4	557.94	16	562.86	28	567.78	40	572.70
5	558.35	17	563.27	29	568.19	41	573.11
6	558.76	18	563.68	30	568.60	42	573.52
7	559.17	19	564.09	31	569.01	43	573.93
8	559.58	20	564.50	32	569.42	44	574.34
9	559.99	21	564.91	33	569.83	45	574.75
10	560.40	22	565.32	34	570.24	46	575.16
11	560.81	23	565.73	35	570.65	47	575.57
12	561.22	24	566.14	36	571.06	48	575.98

### Channel B

Channel	Frequency (MHz)	Channel	Frequency (MHz)	Channel	Frequency (MHz)	Channel	Frequency (MHz)
1	576.39	13	581.31	25	586.23	37	591.15
2	576.80	14	581.72	26	586.64	38	591.56
3	577.21	15	582.13	27	587.05	39	591.97
4	577.62	16	582.54	28	587.46	40	592.38
5	578.03	17	582.95	29	587.87	41	592.79
6	578.44	18	583.36	30	588.28	42	593.20
7	578.85	19	583.77	31	588.69	43	593.61
8	579.26	20	584.18	32	589.10	44	594.02
9	579.67	21	584.59	33	589.51	45	594.43
10	580.08	22	585.00	34	589.92	46	594.84
11	580.49	23	585.41	35	590.33	47	595.25
12	580.90	24	585.82	36	590.74	48	595.66

## 2. TEST METHODOLOGY

All measurements contained in this report were conducted with ANSI C63.26-2015:American National Standard for Compliance Testing of Transmitters Used in Licensed Radio Services

The radiated testing was performed at an antenna-to-EUT distance of 3 meters. All radiated and conducted emissions measurement was performed at Shenzhen LCS Compliance Testing Laboratory Ltd.

### 2.1. EUT Configuration

The EUT configuration for testing is installed on RF field strength measurement to meet the Commissions requirement and operating in a manner that intends to maximize its emission characteristics in a continuous normal application.

### 2.2. EUT Exercise

The EUT was operated in the engineering mode to fix the TX frequency that was for the purpose of the measurements.

According to its specifications, the EUT must comply with the requirements of the Section FCC Rules Part 74.

### 2.3. General Test Procedures

#### 2.3.1 Power Line Conducted Emissions(N/A)

The EUT is placed on the turntable, which is 0.8 m above ground plane. According to the requirements in Section 6.2.1 of ANSI C63.4-2014 Conducted emissions from the EUT measured in the frequency range between 0.15 MHz and 30MHz using Quasi-peak and average detector modes.

#### 2.3.2 Radiated Emissions

Please refer to radiated spurious emission.

### **3. SYSTEM TEST CONFIGURATION**

#### **3.1. Justification**

The system was configured for testing in a continuous transmits condition.

#### **3.2. EUT Exercise Software**

The system was configured for testing in a continuous transmits condition and transmission frequency by switch button control.

#### **3.3. Special Accessories**

N/A

#### **3.4. Block Diagram/Schematics**

Please refer to the related document

#### **3.5. Equipment Modifications**

Shenzhen LCS Compliance Testing Laboratory Ltd. has not done any modification on the EUT.

#### **3.6. Test Setup**

Please refer to the test setup photo.

#### 4. SUMMARY OF TEST RESULTS

Applied Standard: FCC Part 74		
FCC Rules	Description of Test	Result
FCC Part 74.861(e)(1)(ii) FCC Part 2.1046	Maximum Conducted Output Power	Compliant
FCC Part 74.861 (e)(5) FCC Part 2.1049	Occupied Bandwidth	Compliant
FCC Part 74.861 (e)(4) FCC Part 2.1055	Frequency error	Compliant
FCC Part 74.861(e)(6) 2.1053	Transmitter unwanted emissions(radiated or conducted)	Compliant
FCC Part 2.1047	Modulation characteristic	N/A
FCC Part 74.861 (e)(7) FCC Part 2.1049	Necessary bandwidth (BN)	Compliant

## 5. TEST RESULT

### 5.1. Transmitter output power

#### 5.1.1. Description:

The power may not exceed the following values.

- (i) 54-72, 76-88, and 174-216 MHz bands: 50 mW EIRP
- (ii) 470-608 and 614-698: 250 mW conducted power
- (iii) 600 MHz duplex gap: 20 mW EIRP

#### 5.1.2. Measurement:

Measurement parameter	
Detector:	Peak (worst case) / Average (RMS)
Sweep time:	Auto / 20s
Resolution bandwidth:	> emission bandwidth
Video bandwidth:	> resolution bandwidth
Span:	> 2 times emissions bandwidth
Trace mode:	Max. hold
EUT configuration:	Peak: Unmodulated carrier  RMS: Modulate the transmitter with a 2.5 kHz tone at a level 16 dB higher than that required to produce a frequency deviation of $\pm 75$ kHz, or to produce 50% of the manufacturer's rated deviation, whichever is less.

#### 5.1.3. Limits:

FCC
470 MHz to 608 MHz 250 mW (average) / 24 dBm (average)

#### 5.1.4. Test result:

The EUT was programmed to be in continuously transmitting mode.

#### 5.1.5. Test result

Test Mode	Channel	Frequency (MHz)	Measured Maximum Peak Power(dBm)	Measured Maximum Average Power(dBm)	Limits Average (dBm)	Verdict
GFSK(A)	01	556.710	9.147	/	24	PASS
	24	566.140	8.679	/		
	48	575.980	8.732	/		
GFSK(B)	01	576.390	8.724	/	24	PASS
	24	585.820	8.885	/		
	48	595.660	8.911	/		

Maximum Peak Output Power

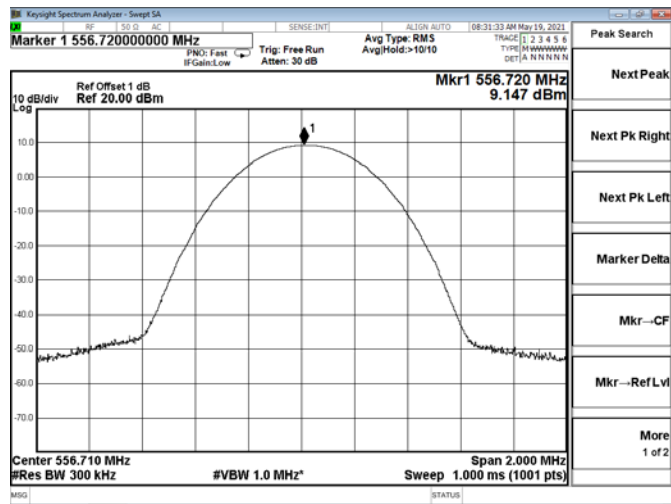

Maximum Peak Output Power

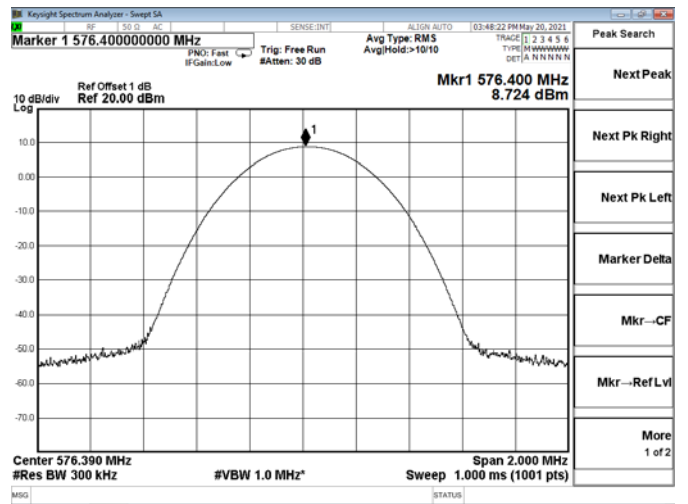

Channel 01 / 556.710 MHz

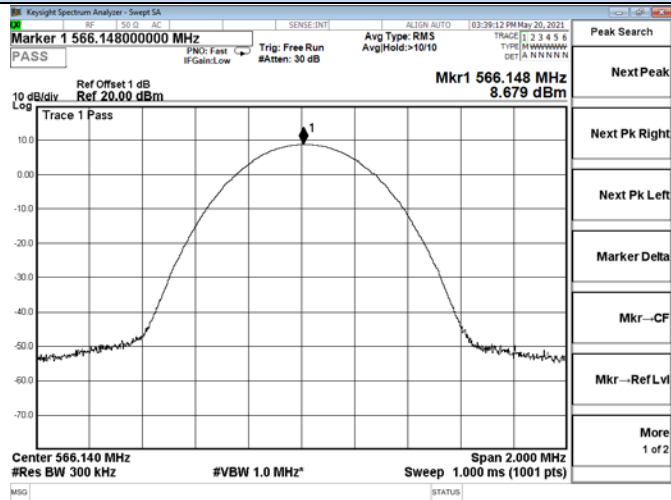

Channel 01 / 576.390 MHz

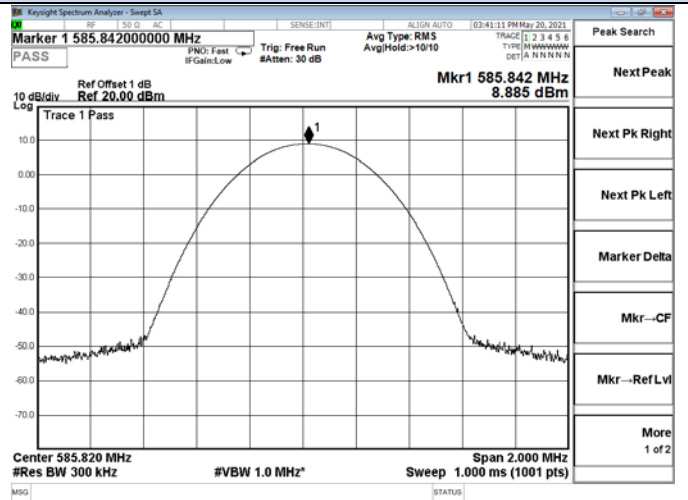

Channel 24 / 566.140 MHz

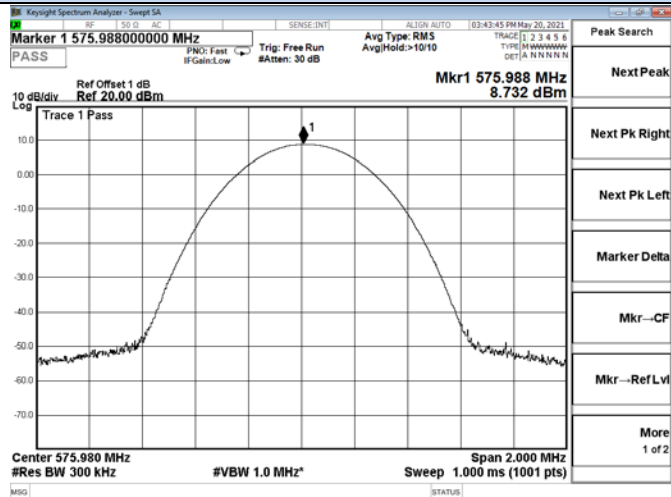

Channel 24 / 585.820 MHz

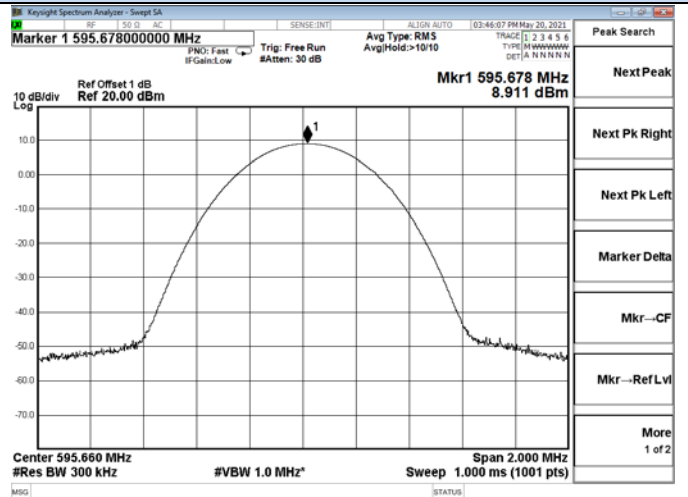

Channel 48 / 575.980 MHz

Channel 48 / 595.660 MHz

## 5.2. Occupied bandwidth and Emission Mask

### 5.2.1. Description:

The operating bandwidth shall not exceed 200 kHz.

The mean power of emissions shall be attenuated below the mean output power of the transmitter in accordance with the following schedule:

- (i) On any frequency removed from the operating frequency by more than 50 percent up to and including 100 percent of the authorized bandwidth: at least 25 dB;
- (ii) On any frequency removed from the operating frequency by more than 100 percent up to and including 250 percent of the authorized bandwidth: at least 35 dB;
- (iii) On any frequency removed from the operating frequency by more than 250 percent of the authorized bandwidth: at least  $43 + 10\log_{10}$  (mean output power in watts) dB.

### 5.2.2. Measurement:

Measurement parameter	
Detector:	Peak
Sweep time:	Auto
Resolution bandwidth:	1 % to 5 % of the occupied bandwidth
Video bandwidth:	3 x resolution bandwidth
Span:	2 x emission bandwidth
Trace mode:	Max. hold
Analyzer function:	99% power occupied bandwidth function
EUT:	Modulated signal with max. frequency deviation

### 5.2.3. Result:

Test Mode	Channel	Frequency (MHz)	99% Bandwidth (KHz)	Limits (KHz)	Verdict
GFSK(A)	01	556.710	62.643	200	PASS
	24	566.140	60.878		
	48	575.980	62.378		
GFSK(B)	01	576.390	62.161		
	24	585.820	62.380		
	48	595.660	61.065		

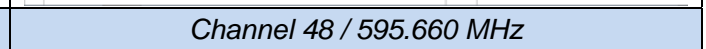
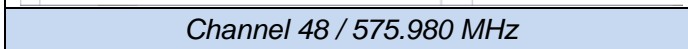
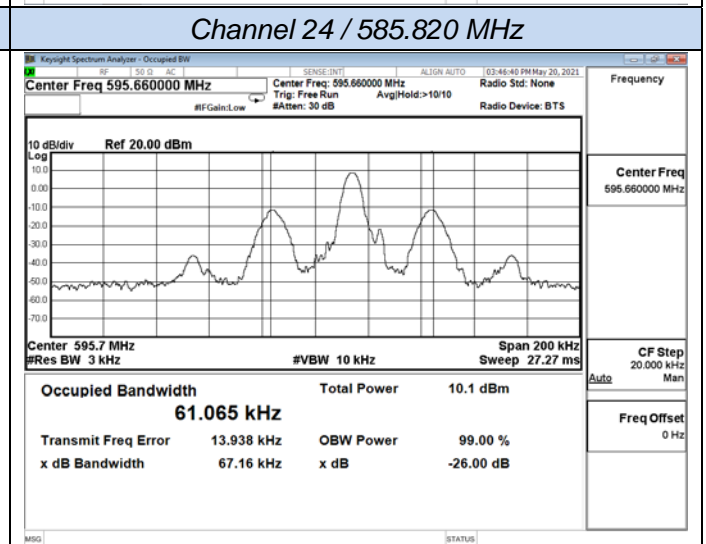
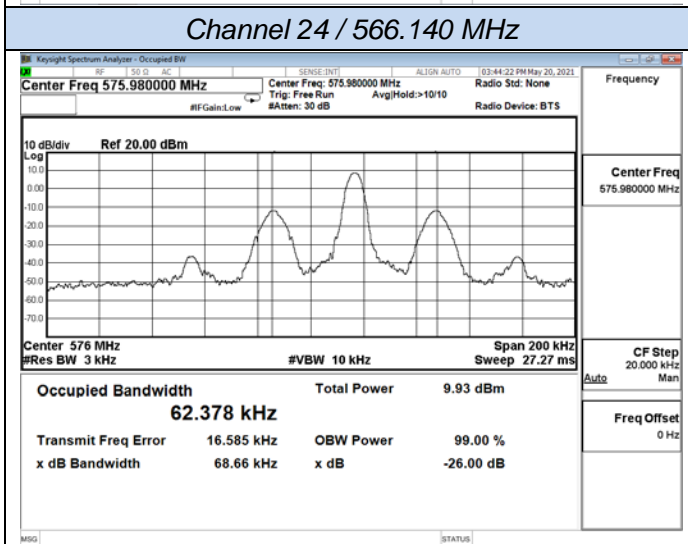
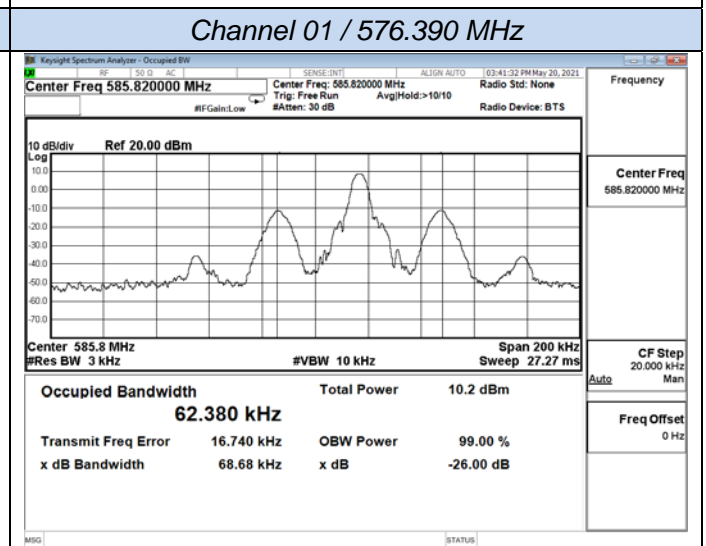
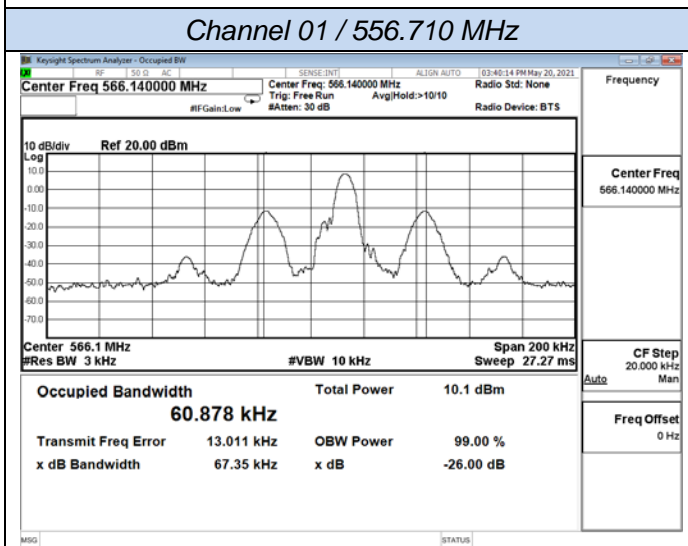
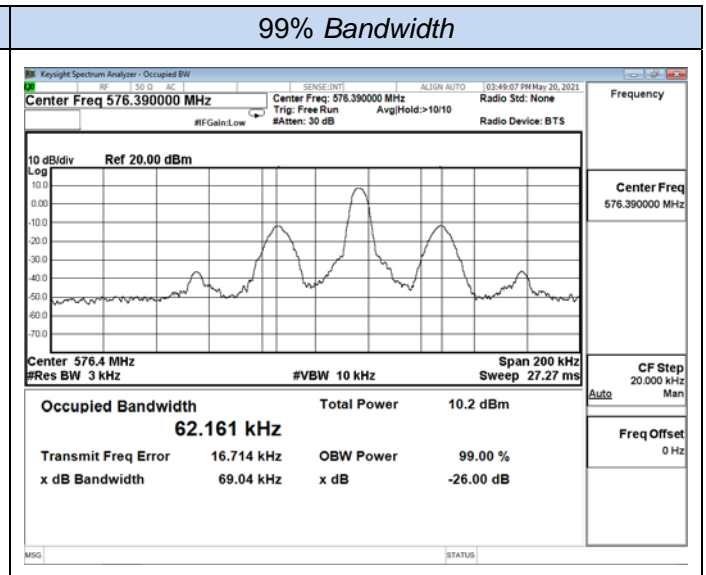
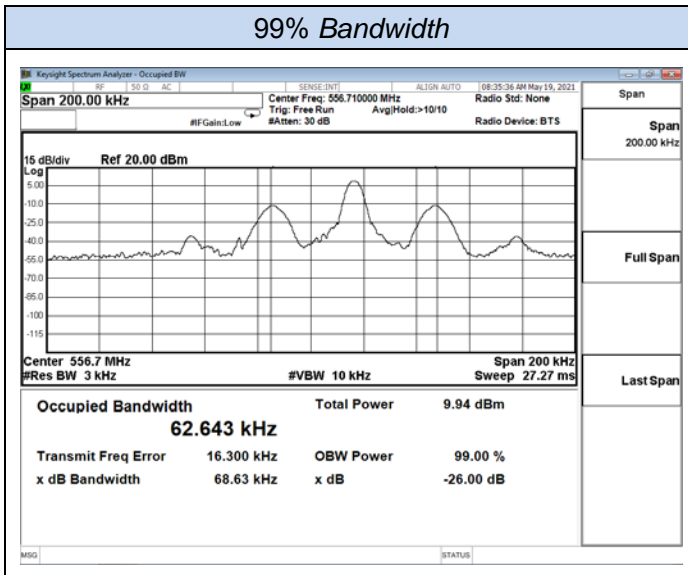



### 5.3. Transmitter unwanted emissions(radiated)

#### 5.3.1. Measurement description:

##### TEST CONFIGURATION

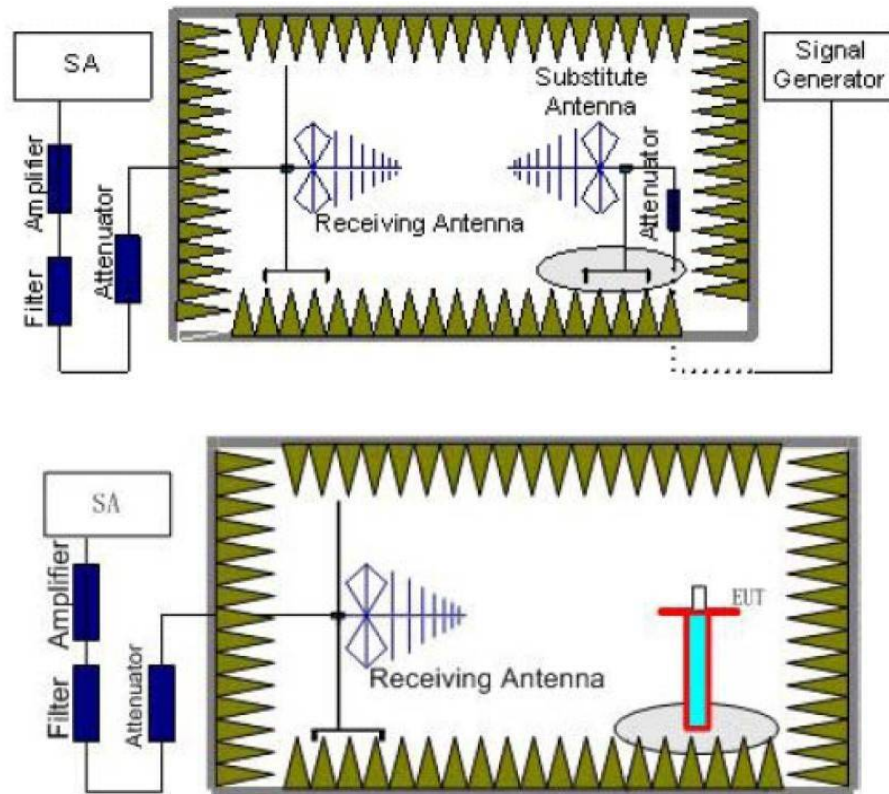

#### TEST PROCEDURE

1. EUT was placed on a 1.50 meter high non-conductive stand at a 3 meter test distance from the receive antenna. A receiving antenna was placed on the antenna mast 3 meters from the EUT for emission measurements. The height of receiving antenna is 1.50 m. Detected emissions were maximized at each frequency by rotating the EUT through 360° and adjusting the receiving antenna polarization. The radiated emission measurements of all transmit frequencies in three channels (High, Middle, Low) were measured with peak detector.
2. A log-periodic antenna or double-ridged waveguide horn antenna shall be substituted in place of the EUT. The log-periodic antenna will be driven by a signal generator and the level will be adjusted till the same power value on the spectrum analyzer or receiver. The level of the spurious emissions can be calculated through the level of the signal generator, cable loss, the gain of the substitution antenna and the reading of the spectrum analyzer or receiver.
3. The EUT is then put into continuously transmitting mode at its maximum power level during the test. Set Test Receiver or Spectrum RBW=1MHz, VBW=3MHz, And the maximum value of the receiver should be recorded as ( $P_r$ ).
4. The EUT shall be replaced by a substitution antenna. In the chamber, an substitution antenna for the frequency band of interest is placed at the reference point of the chamber. An RF Signal source for the frequency band of interest is connected to the substitution antenna with a cable that has been constructed to not interfere with the radiation pattern of the antenna. A power ( $P_{Mea}$ ) is applied to the input of the substitution antenna, and adjust the level of the signal generator output until the value of the receiver reach the previously recorded ( $P_r$ ). The

power of signal source ( $P_{Mea}$ ) is recorded. The test should be performed by rotating the test item and adjusting the receiving antenna polarization.

5. A amplifier should be connected to the Signal Source output port. And the cable should be connect between the Amplifier and the Substitution Antenna. The cable loss ( $P_{cl}$ ), the Substitution Antenna Gain ( $G_a$ ) and the Amplifier Gain ( $P_{Ag}$ ) should be recorded after test.  
The measurement results are obtained as described below:  
 $Power(EIRP) = P_{Mea} - P_{Ag} - P_{cl} + G_a$
6. This value is EIRP since the measurement is calibrated using an antenna of known gain (2.15 dBi) and known input power.
7. ERP can be calculated from EIRP by subtracting the gain of the dipole,  $ERP = EIRP - 2.15dBi$ .
8. In order to make sure test results more clearly, we set frequency range and sweep time for difference frequency range as follows table:

**TEST LIMITS**

FCC & IC (according to ETSI EN 300 422-1 V2.1.2 (2017-01))			
State	Max. spurious level		
	47 MHz to 74 MHz 87.5 MHz to 118 MHz 174 MHz to 230 MHz	Other frequencies ≤ 1000 MHz	All frequencies > 1000 MHz
Operating	4.0 nW	250 nW	1.00 μW
Standby	2.0 nW	2.0 nW	20.0 nW

FCC & IC	
The mean power of emissions shall be attenuated below the mean output power of the transmitter in accordance with the following schedule:	
On any frequency removed from the operating frequency by more than 50 percent up to and including 100 percent of the	25 dB
On any frequency removed from the operating frequency by more than 100 percent up to and including 250 percent of	35 dB
On any frequency removed from the operating frequency by more than 250 percent of the authorized bandwidth: at least	$43 + 10\log_{10}$ (mean output power in watts) dB

$$P = 10 \cdot \log_{10} \left( \frac{P}{P_0} \right) \qquad P_0 = 1mW$$

$$U = 20 \cdot \log_{10} \left( \frac{u}{u_0} \right) \qquad u_0 = 1\mu V$$

$$P = \frac{u^2}{Z_c} \qquad Z_c = 50$$

5.3.2. Results for Radiated Emissions

A

Channel 01 / 556.710MHz

Horizontal

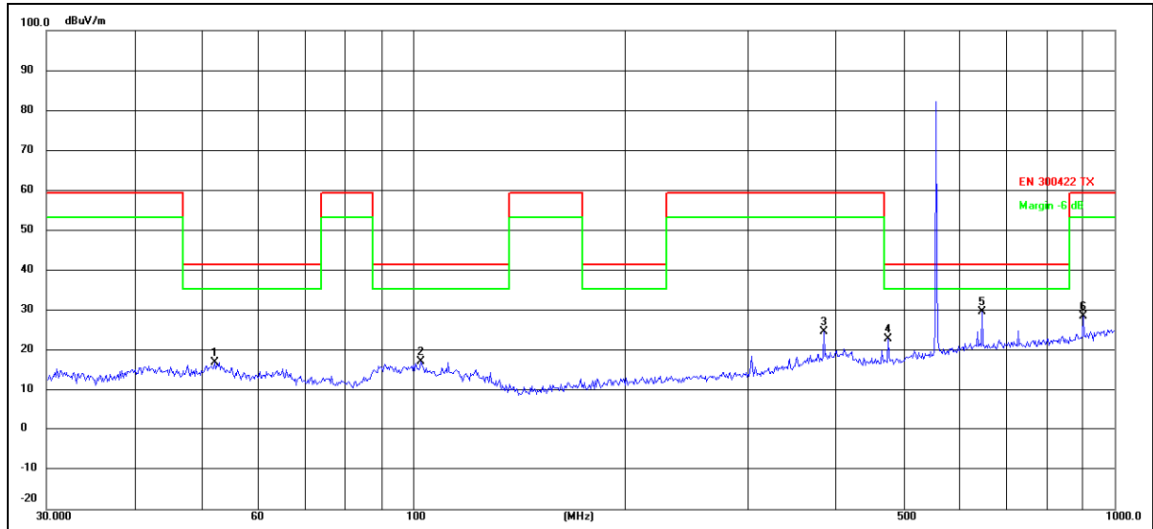

No.	Frequency (MHz)	Reading (dBuV)	Factor (dB/m)	Level (dBuV/m)	Limit (dBuV/m)	Margin (dB)	Det.
1	52.2078	46.06	-29.08	16.98	41.28	-24.30	QP
2	102.7192	44.79	-27.48	17.31	41.28	-23.97	QP
3	385.2804	50.93	-26.20	24.73	59.24	-34.51	QP
4	475.4991	47.35	-24.45	22.90	41.28	-18.38	QP
5 *	647.3856	51.02	-21.33	29.69	41.28	-11.59	QP
6	903.3093	46.78	-18.25	28.53	59.24	-30.71	QP

Horizontal

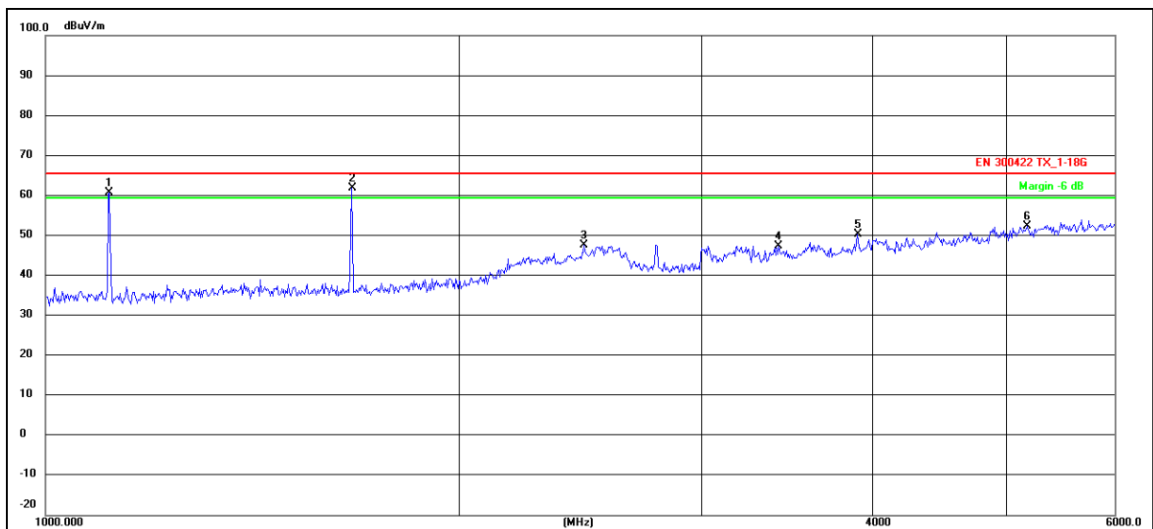

No.	Frequency (MHz)	Reading (dBuV)	Factor (dB/m)	Level (dBuV/m)	Limit (dBuV/m)	Margin (dB)	Det.
1 !	1113.497	76.46	-15.63	60.83	65.25	-4.42	QP
2 *	1669.365	76.00	-14.05	61.95	65.25	-3.30	QP
3	2467.108	52.69	-5.02	47.67	65.25	-17.58	QP
4	3418.312	56.13	-8.70	47.43	65.25	-17.82	QP
5	3895.981	57.42	-7.09	50.33	65.25	-14.92	QP
6	5180.156	54.86	-2.52	52.34	65.25	-12.91	QP

Channel 01 / 556.710MHz

Vertical

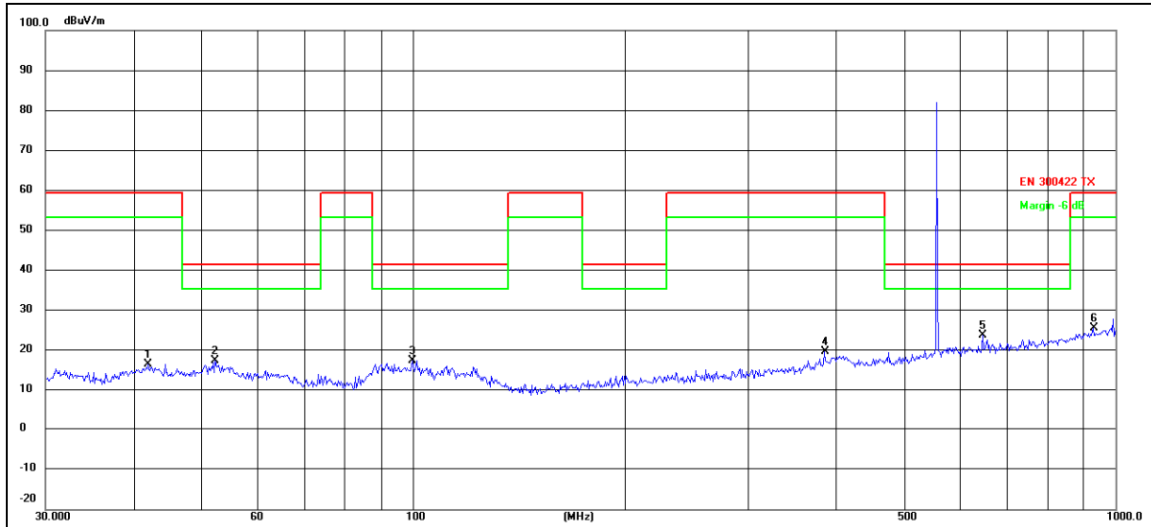

No.	Frequency (MHz)	Reading (dBuV)	Factor (dB/m)	Level (dBuV/m)	Limit (dBuV/m)	Margin (dB)	Det.
1	42.0066	45.97	-29.49	16.48	59.24	-42.76	QP
2	52.3912	46.50	-29.11	17.39	41.28	-23.89	QP
3	99.8777	44.93	-27.43	17.50	41.28	-23.78	QP
4	385.2805	45.84	-26.20	19.64	59.24	-39.60	QP
5 *	647.3856	45.03	-21.33	23.70	41.28	-17.58	QP
6	929.0082	43.64	-18.00	25.64	59.24	-33.60	QP

Vertical

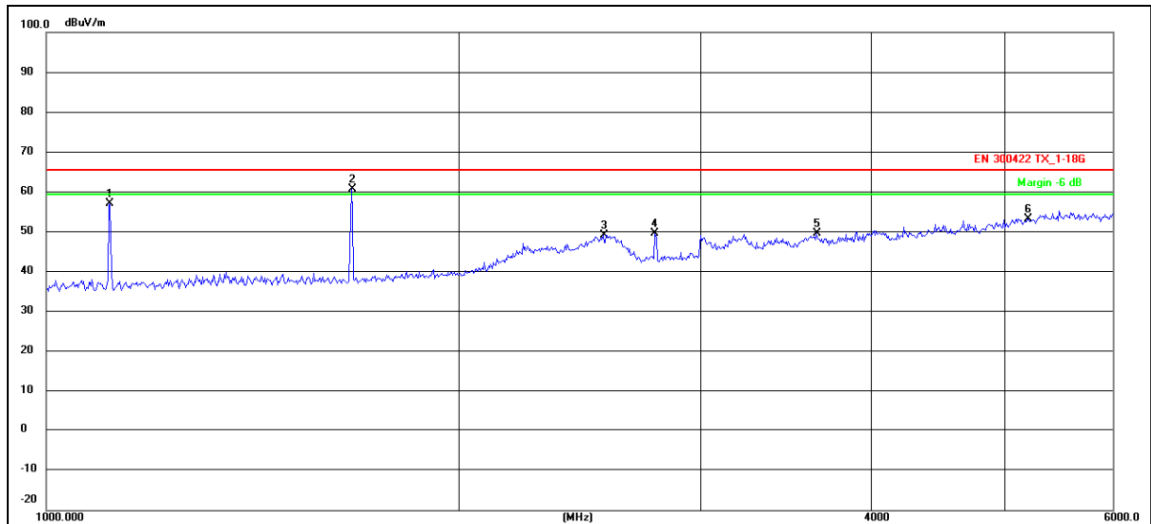

No.	Frequency (MHz)	Reading (dBuV)	Factor (dB/m)	Level (dBuV/m)	Limit (dBuV/m)	Margin (dB)	Det.
1	1113.497	72.75	-15.63	57.12	65.25	-8.13	QP
2 *	1669.365	74.77	-14.05	60.72	65.25	-4.53	QP
3	2547.974	53.53	-4.31	49.22	65.25	-16.03	QP
4	2781.790	58.75	-9.20	49.55	65.25	-15.70	QP
5	3646.072	57.39	-7.74	49.65	65.25	-15.60	QP
6	5198.753	55.78	-2.43	53.35	65.25	-11.90	QP

Channel 24/ 566.140MHz

Horizontal

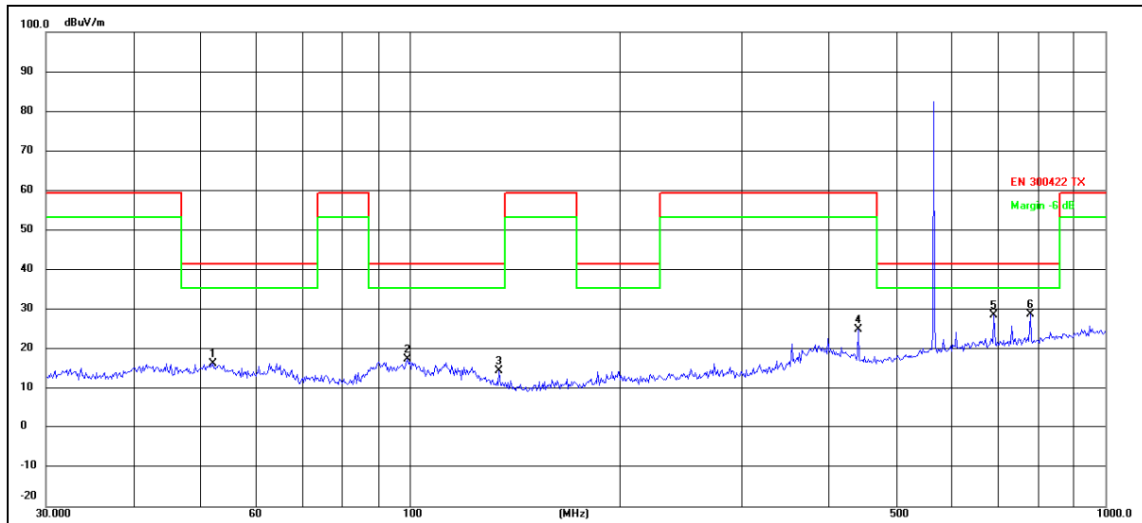

No.	Frequency (MHz)	Reading (dBuV)	Factor (dB/m)	Level (dBuV/m)	Limit (dBuV/m)	Margin (dB)	Det.
1	52.2078	45.38	-29.08	16.30	41.28	-24.98	QP
2	99.1797	45.11	-27.53	17.58	41.28	-23.70	QP
3	134.5591	47.01	-32.43	14.58	41.28	-26.70	QP
4	441.7425	50.00	-25.09	24.91	59.24	-34.33	QP
5	691.9865	49.56	-20.91	28.65	41.28	-12.63	QP
6 *	779.6067	48.59	-19.82	28.77	41.28	-12.51	QP

Horizontal

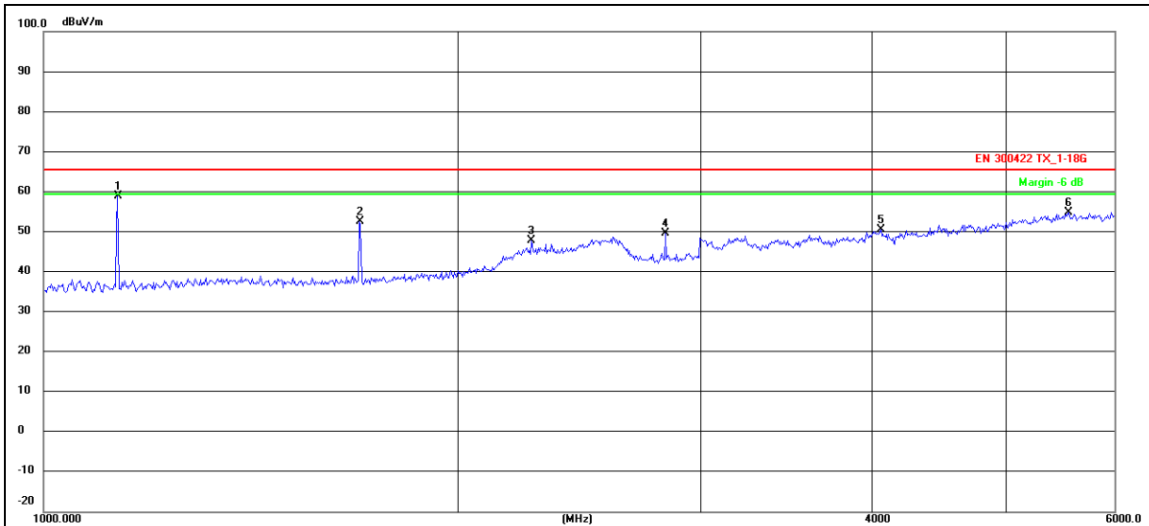

No.	Frequency (MHz)	Reading (dBuV)	Factor (dB/m)	Level (dBuV/m)	Limit (dBuV/m)	Margin (dB)	Det.
1 *	1131.599	74.42	-15.55	58.87	65.25	-6.38	QP
2	1696.503	66.61	-14.05	52.56	65.25	-12.69	QP
3	2263.794	54.87	-7.00	47.87	65.25	-17.38	QP
4	2832.082	58.70	-9.11	49.59	65.25	-15.66	QP
5	4059.890	57.17	-6.56	50.61	65.25	-14.64	QP
6	5555.085	55.59	-0.82	54.77	65.25	-10.48	QP

Channel 24/ 566.140MHz

Vertical

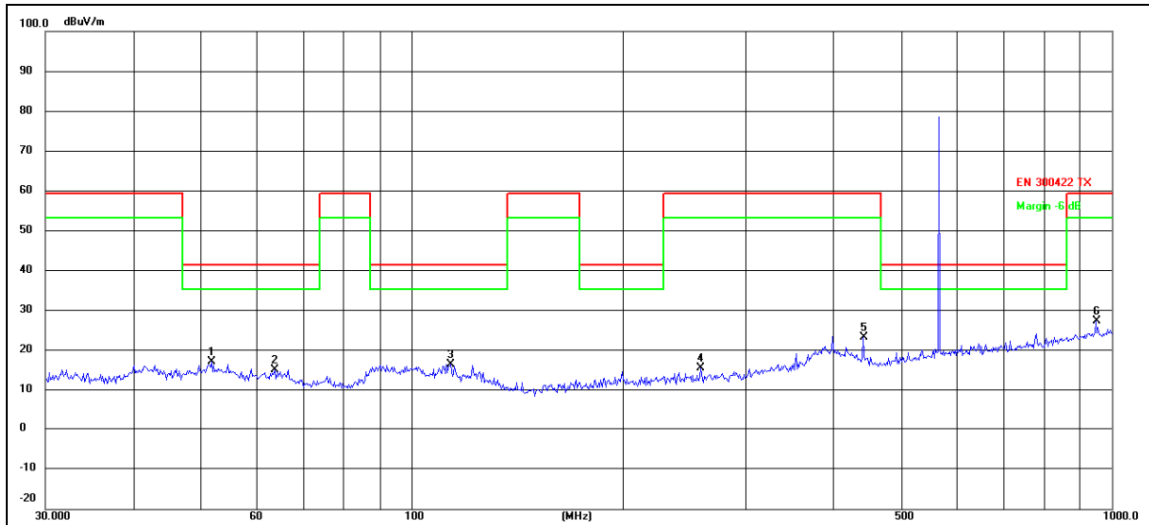

No.	Frequency (MHz)	Reading (dBuV)	Factor (dB/m)	Level (dBuV/m)	Limit (dBuV/m)	Margin (dB)	Det.
1 *	51.8430	46.29	-29.03	17.26	41.28	-24.02	QP
2	63.7588	46.22	-30.90	15.32	41.28	-25.96	QP
3	113.7143	44.88	-28.34	16.54	41.28	-24.74	QP
4	259.2338	44.81	-29.12	15.69	59.24	-43.55	QP
5	441.7426	48.42	-25.09	23.33	59.24	-35.91	QP
6	948.7610	45.24	-17.81	27.43	59.24	-31.81	QP

Vertical

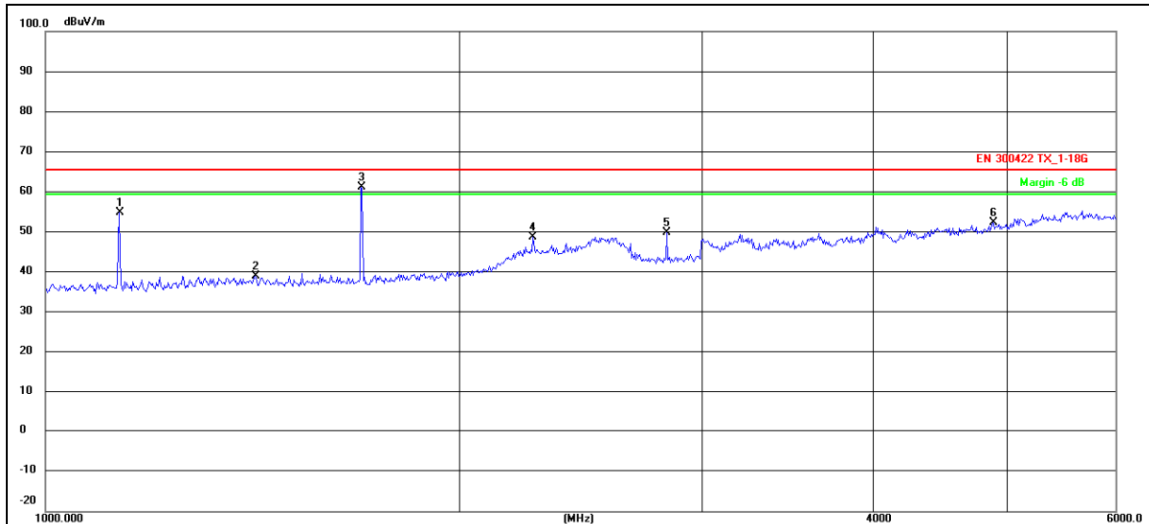

No.	Frequency (MHz)	Reading (dBuV)	Factor (dB/m)	Level (dBuV/m)	Limit (dBuV/m)	Margin (dB)	Det.
1	1131.599	70.31	-15.55	54.76	65.25	-10.49	QP
2	1420.750	53.01	-14.05	38.96	65.25	-26.29	QP
3 *	1696.503	75.20	-14.05	61.15	65.25	-4.10	QP
4	2263.794	55.62	-7.00	48.62	65.25	-16.63	QP
5	2832.082	59.02	-9.11	49.91	65.25	-15.34	QP
6	4882.743	56.32	-3.94	52.38	65.25	-12.87	QP

Channel 48 / 575.980MHz

Horizontal

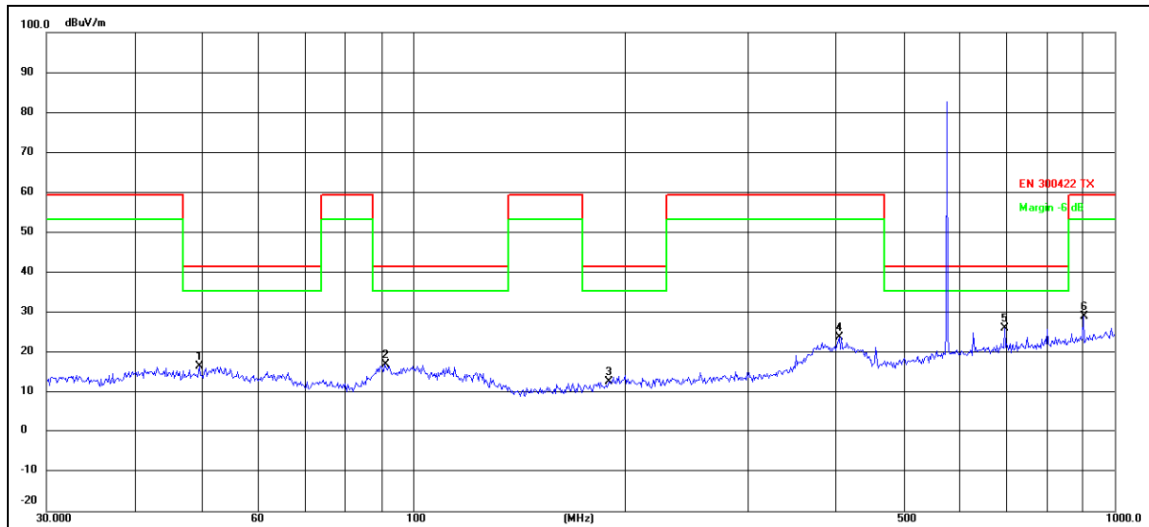

No.	Frequency (MHz)	Reading (dBuV)	Factor (dB/m)	Level (dBuV/m)	Limit (dBuV/m)	Margin (dB)	Det.
1	49.5328	45.30	-28.80	16.50	41.28	-24.78	QP
2	91.1746	45.86	-28.81	17.05	41.28	-24.23	QP
3	190.4050	44.14	-31.34	12.80	41.28	-28.48	QP
4	404.6665	49.59	-25.77	23.82	59.24	-35.42	QP
5 *	696.8567	46.93	-20.88	26.05	41.28	-15.23	QP
6	903.3094	47.19	-18.25	28.94	59.24	-30.30	QP

Horizontal

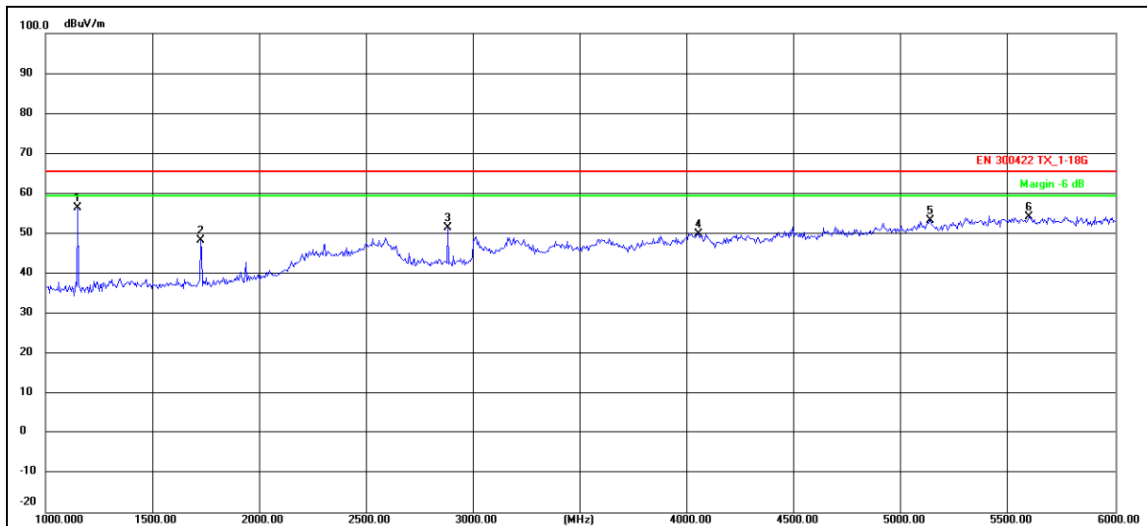

No.	Frequency (MHz)	Reading (dBuV)	Factor (dB/m)	Level (dBuV/m)	Limit (dBuV/m)	Margin (dB)	Det.
1 *	1150.000	71.79	-15.47	56.32	65.25	-8.93	QP
2	1725.000	62.18	-13.94	48.24	65.25	-17.01	QP
3	2880.000	60.43	-9.03	51.40	65.25	-13.85	QP
4	4050.000	56.54	-6.59	49.95	65.25	-15.30	QP
5	5135.000	56.00	-2.71	53.29	65.25	-11.96	QP
6	5595.000	54.97	-0.83	54.14	65.25	-11.11	QP

Channel 48 / 575.980MHz

Vertical

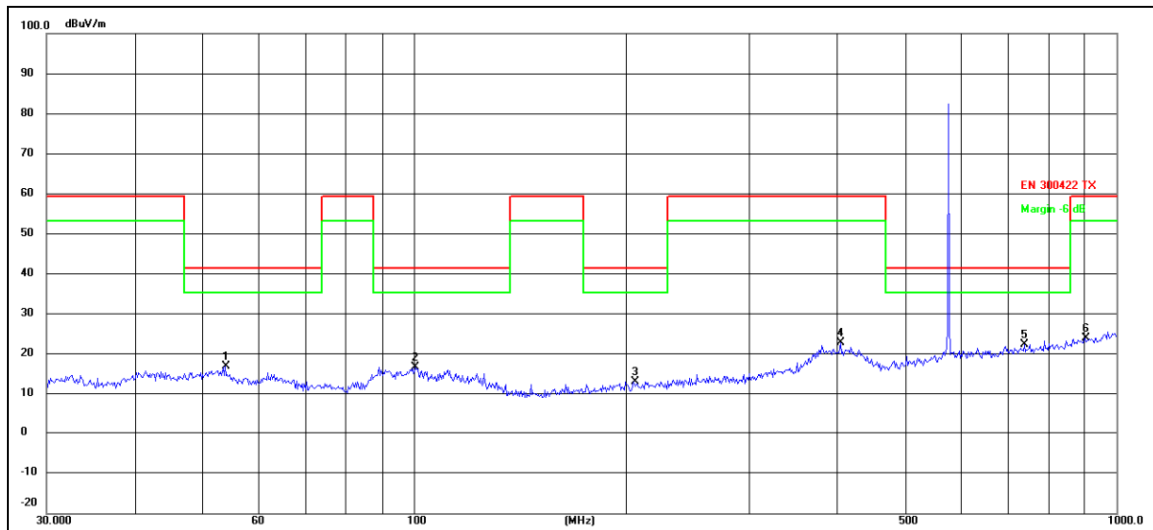

No.	Frequency (MHz)	Reading (dBuV)	Factor (dB/m)	Level (dBuV/m)	Limit (dBuV/m)	Margin (dB)	Det.
1	53.8818	46.22	-29.31	16.91	41.28	-24.37	QP
2	100.5806	44.14	-27.43	16.71	41.28	-24.57	QP
3	205.6751	43.48	-30.37	13.11	41.28	-28.17	QP
4	404.6665	48.65	-25.77	22.88	59.24	-36.36	QP
5 *	739.6604	42.82	-20.34	22.48	41.28	-18.80	QP
6	903.3094	42.20	-18.25	23.95	59.24	-35.29	QP

Vertical

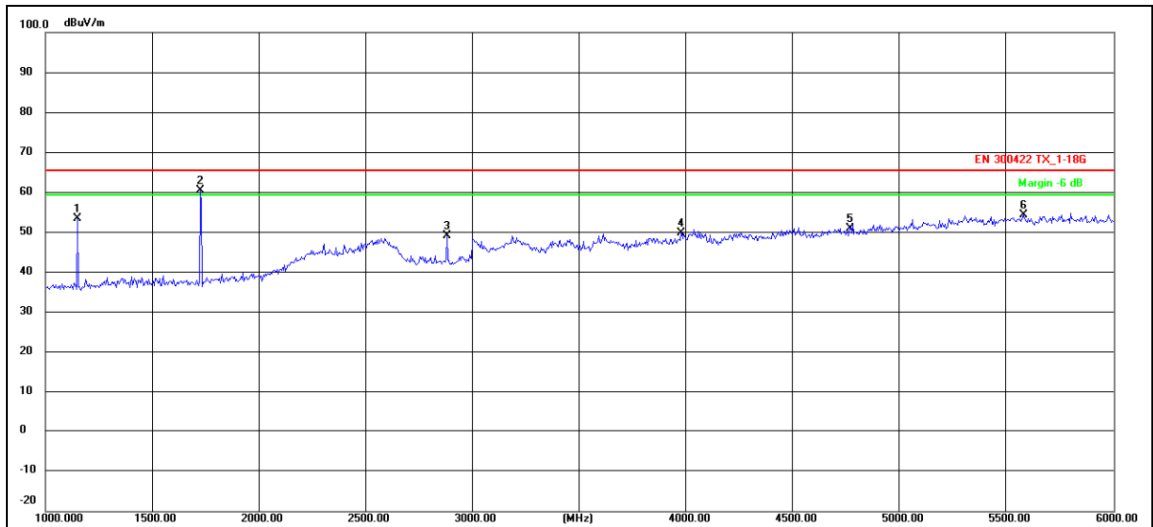

No.	Frequency (MHz)	Reading (dBuV)	Factor (dB/m)	Level (dBuV/m)	Limit (dBuV/m)	Margin (dB)	Det.
1	1150.000	68.89	-15.47	53.42	65.25	-11.83	QP
2 *	1725.000	74.40	-13.94	60.46	65.25	-4.79	QP
3	2880.000	58.24	-9.03	49.21	65.25	-16.04	QP
4	3975.000	56.68	-6.81	49.87	65.25	-15.38	QP
5	4765.000	55.42	-4.47	50.95	65.25	-14.30	QP
6	5580.000	55.19	-0.83	54.36	65.25	-10.89	QP

Note: 1, All detected emissions are more than 20 dB below the limit, In addition to main frequency.

2, Factor = Antenna Factor + Cable Loss + Amplifier Factor

3, Emission Level = Reading level + Factor    Margin = Emission Level - Limit



B

Channel 01 / 576.390MHz

Horizontal

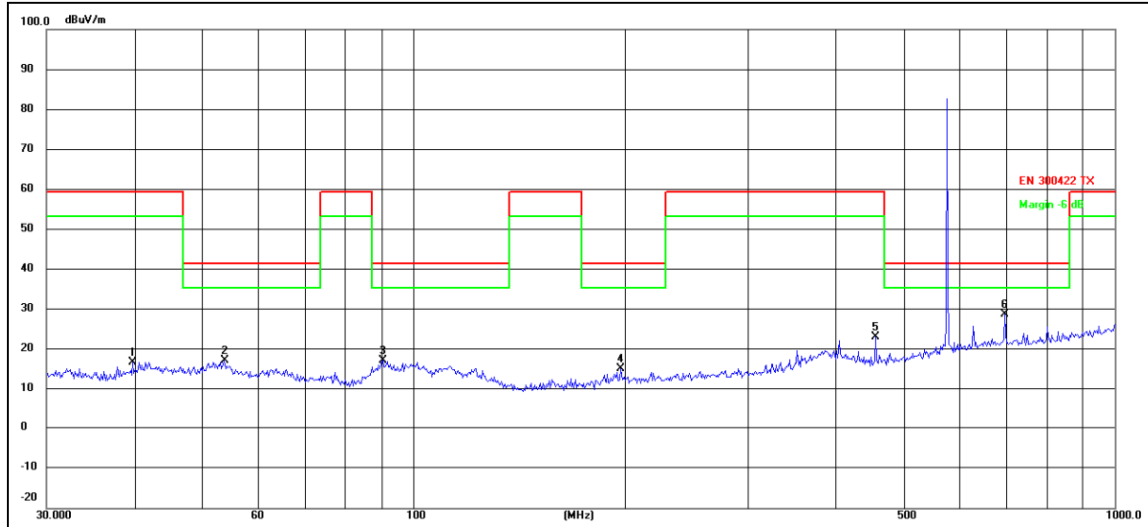

No.	Frequency (MHz)	Reading (dBuV)	Factor (dB/m)	Level (dBuV/m)	Limit (dBuV/m)	Margin (dB)	Det.
1	39.8542	46.77	-29.90	16.87	59.24	-42.37	QP
2	53.6932	46.48	-29.28	17.20	41.28	-24.08	QP
3	90.2205	46.44	-29.09	17.35	41.28	-23.93	QP
4	197.8928	45.82	-30.68	15.14	41.28	-26.14	QP
5	455.9058	47.95	-24.83	23.12	59.24	-36.12	QP
6 *	696.8567	49.58	-20.88	28.70	41.28	-12.58	QP

Horizontal



No.	Frequency (MHz)	Reading (dBuV)	Factor (dB/m)	Level (dBuV/m)	Limit (dBuV/m)	Margin (dB)	Det.
1	1152.057	73.92	-15.47	58.45	65.25	-6.80	QP
2 *	1727.174	73.93	-13.92	60.01	65.25	-5.24	QP
3	2566.301	53.02	-4.26	48.76	65.25	-16.49	QP
4	2883.284	60.44	-9.02	51.42	65.25	-13.83	QP
5	4200.482	56.30	-6.22	50.08	65.25	-15.17	QP
6	5555.085	55.90	-0.82	55.08	65.25	-10.17	QP

Channel 01 / 576.390MHz

Vertical

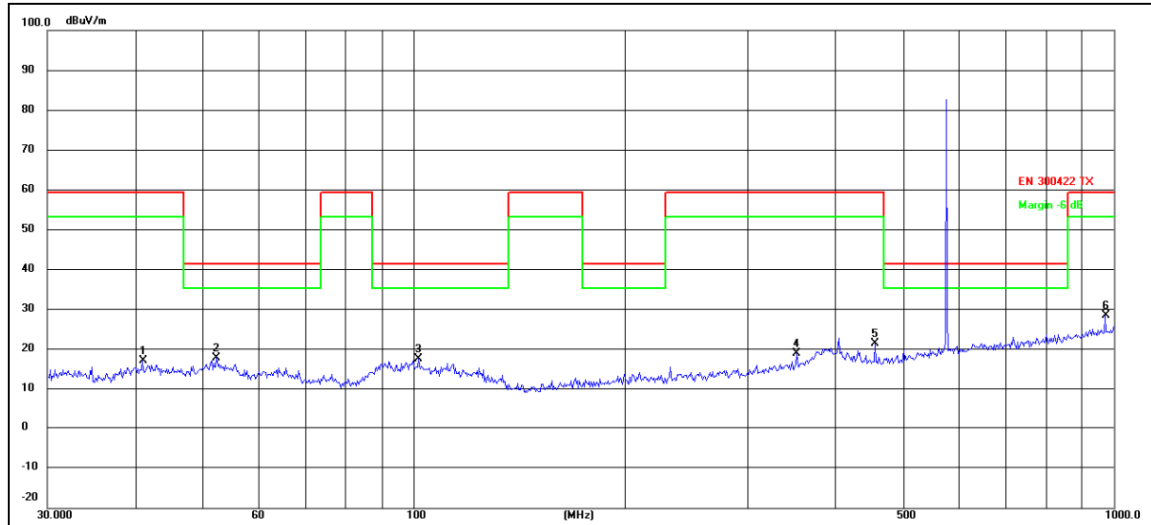

No.	Frequency (MHz)	Reading (dBuV)	Factor (dB/m)	Level (dBuV/m)	Limit (dBuV/m)	Margin (dB)	Det.
1	40.9881	46.96	-29.67	17.29	59.24	-41.95	QP
2 *	52.3912	47.09	-29.11	17.98	41.28	-23.30	QP
3	101.6443	45.07	-27.46	17.61	41.28	-23.67	QP
4	352.9433	46.08	-26.99	19.09	59.24	-40.15	QP
5	455.9058	46.37	-24.83	21.54	59.24	-37.70	QP
6	972.3374	46.08	-17.59	28.49	59.24	-30.75	QP

Vertical

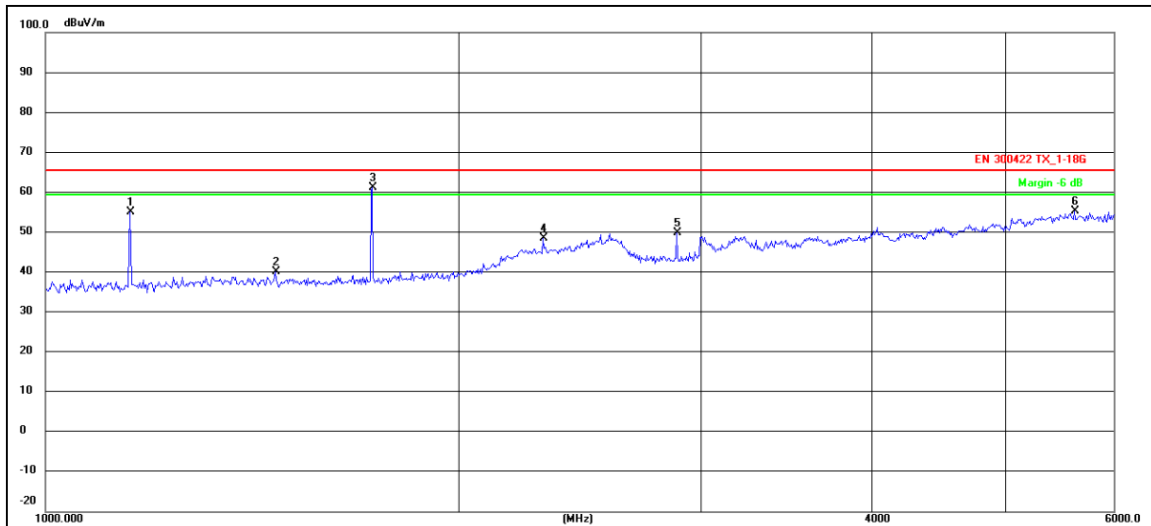

No.	Frequency (MHz)	Reading (dBuV)	Factor (dB/m)	Level (dBuV/m)	Limit (dBuV/m)	Margin (dB)	Det.
1	1152.057	70.46	-15.47	54.99	65.25	-10.26	QP
2	1469.950	54.17	-14.07	40.10	65.25	-25.15	QP
3 *	1730.272	74.98	-13.92	61.06	65.25	-4.19	QP
4	2304.722	54.96	-6.55	48.41	65.25	-16.84	QP
5	2883.284	58.90	-9.02	49.88	65.25	-15.37	QP
6	5615.128	56.16	-0.83	55.33	65.25	-9.92	QP

Channel 24/ 585.820MHz

Horizontal

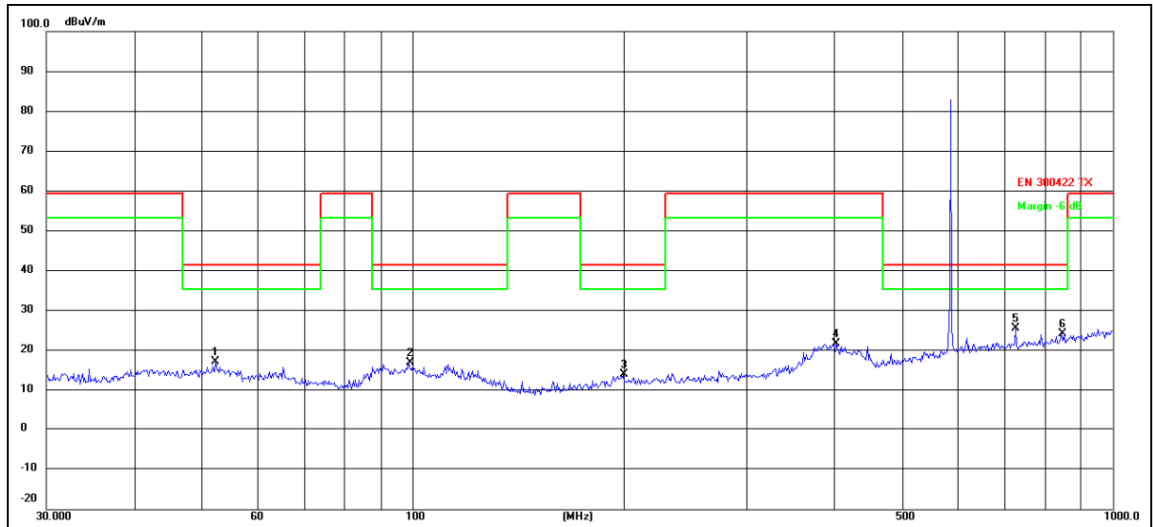

No.	Frequency (MHz)	Reading (dBuV)	Factor (dB/m)	Level (dBuV/m)	Limit (dBuV/m)	Margin (dB)	Det.
1	52.3912	46.43	-29.11	17.32	41.28	-23.96	QP
2	98.8326	44.60	-27.59	17.01	41.28	-24.27	QP
3	199.9856	44.50	-30.49	14.01	41.28	-27.27	QP
4	403.2500	47.59	-25.79	21.80	59.24	-37.44	QP
5 *	726.8052	46.14	-20.51	25.63	41.28	-15.65	QP
6	845.0878	43.29	-18.98	24.31	41.28	-16.97	QP

Horizontal

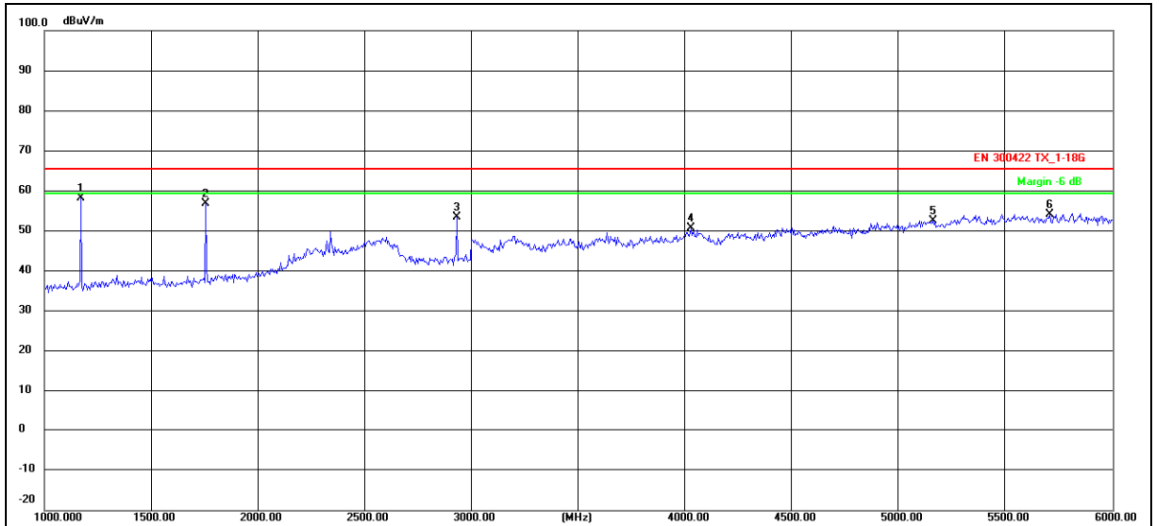

No.	Frequency (MHz)	Reading (dBuV)	Factor (dB/m)	Level (dBuV/m)	Limit (dBuV/m)	Margin (dB)	Det.
1 *	1170.000	73.61	-15.40	58.21	65.25	-7.04	QP
2	1755.000	70.66	-13.82	56.84	65.25	-8.41	QP
3	2930.000	62.39	-8.90	53.49	65.25	-11.76	QP
4	4025.000	57.33	-6.66	50.67	65.25	-14.58	QP
5	5160.000	55.26	-2.62	52.64	65.25	-12.61	QP
6	5705.000	55.03	-0.85	54.18	65.25	-11.07	QP

Channel 24/ 585.820MHz

Vertical

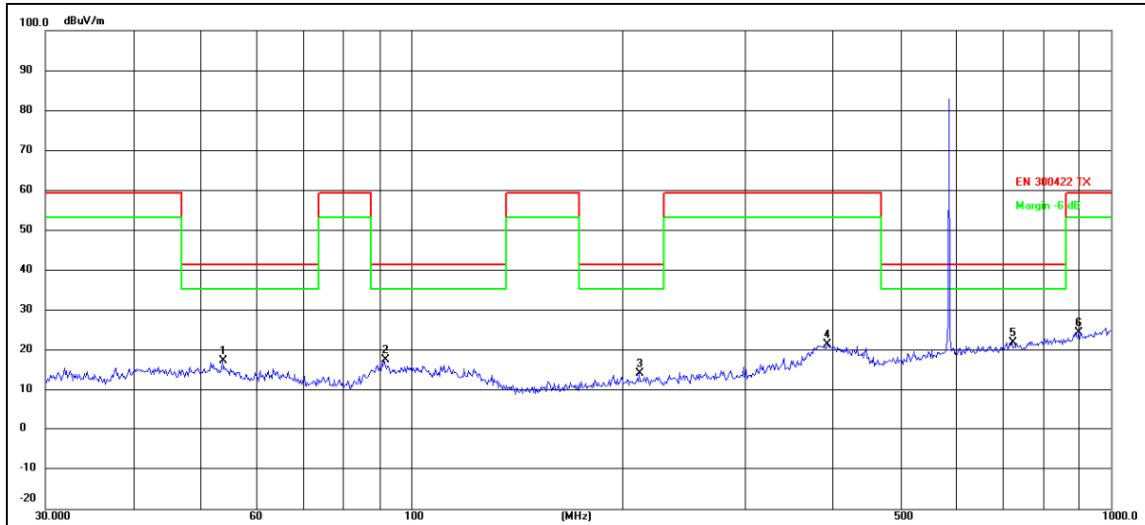

No.	Frequency (MHz)	Reading (dBuV)	Factor (dB/m)	Level (dBuV/m)	Limit (dBuV/m)	Margin (dB)	Det.
1	53.6932	46.70	-29.28	17.42	41.28	-23.86	QP
2	91.4949	46.38	-28.72	17.66	41.28	-23.62	QP
3	211.5265	44.45	-30.25	14.20	41.28	-27.08	QP
4	393.4723	47.66	-26.00	21.66	59.24	-37.58	QP
5 *	721.7259	42.52	-20.57	21.95	41.28	-19.33	QP
6	900.1474	42.85	-18.28	24.57	59.24	-34.67	QP

Vertical

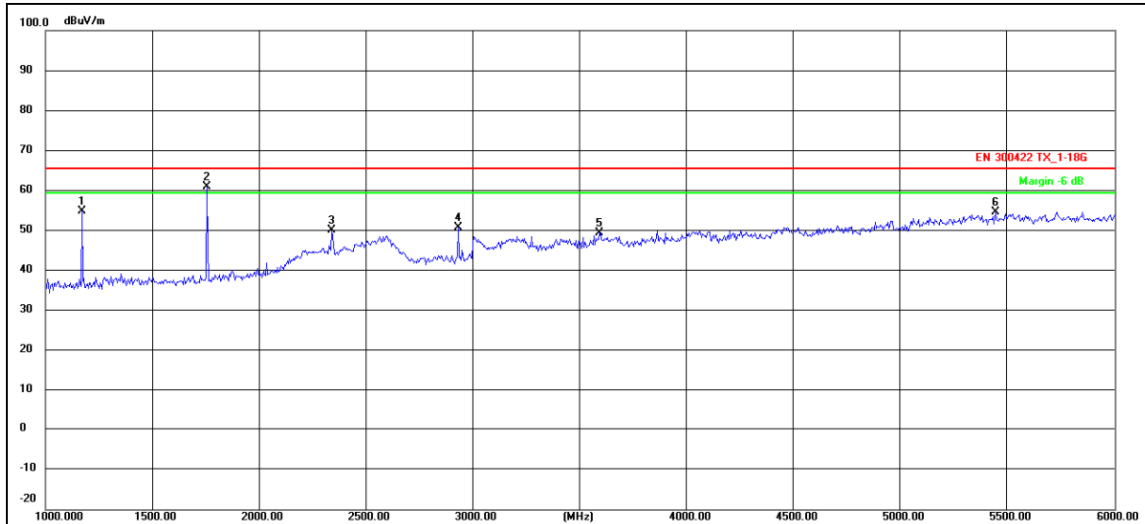

No.	Frequency (MHz)	Reading (dBuV)	Factor (dB/m)	Level (dBuV/m)	Limit (dBuV/m)	Margin (dB)	Det.
1	1170.000	70.33	-15.40	54.93	65.25	-10.32	QP
2 *	1755.000	74.77	-13.82	60.95	65.25	-4.30	QP
3	2340.000	56.59	-6.47	50.12	65.25	-15.13	QP
4	2930.000	59.76	-8.90	50.86	65.25	-14.39	QP
5	3590.000	57.29	-7.85	49.44	65.25	-15.81	QP
6	5445.000	56.03	-1.36	54.67	65.25	-10.58	QP

Channel 48 / 595.660MHz

Horizontal

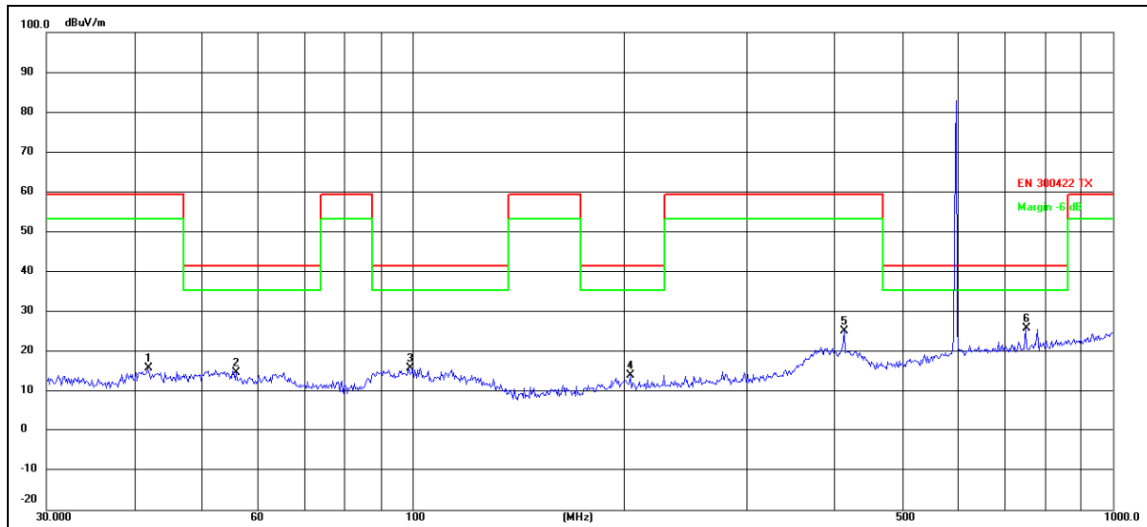

No.	Frequency (MHz)	Reading (dBuV)	Factor (dB/m)	Level (dBuV/m)	Limit (dBuV/m)	Margin (dB)	Det.
1	41.8596	45.33	-29.52	15.81	59.24	-43.43	QP
2	56.0007	44.38	-29.59	14.79	41.28	-26.49	QP
3	98.8326	43.48	-27.59	15.89	41.28	-25.39	QP
4	204.9551	44.57	-30.39	14.18	41.28	-27.10	QP
5	413.2706	50.75	-25.61	25.14	59.24	-34.10	QP
6 *	750.1083	45.97	-20.21	25.76	41.28	-15.52	QP

Horizontal

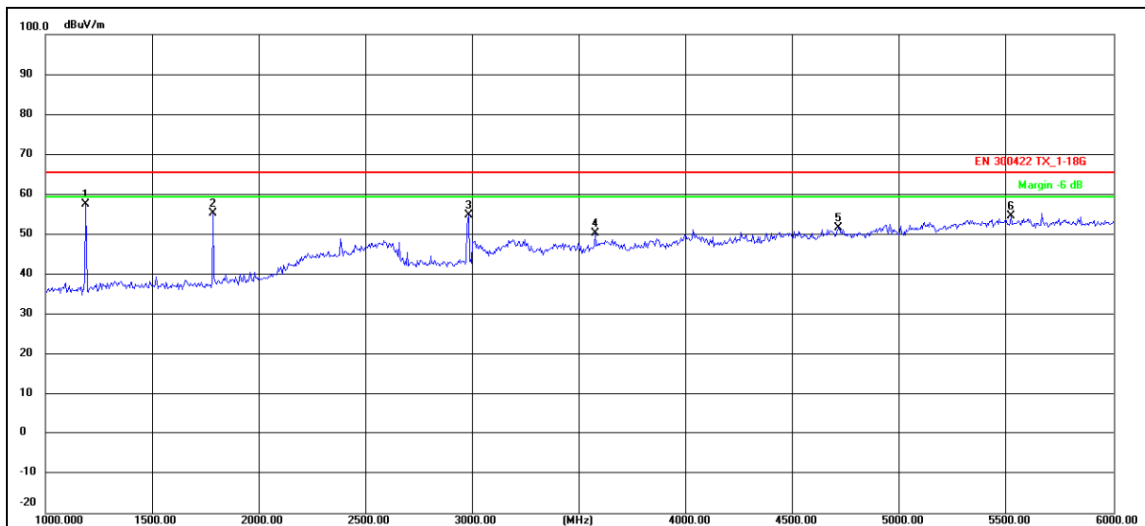

No.	Frequency (MHz)	Reading (dBuV)	Factor (dB/m)	Level (dBuV/m)	Limit (dBuV/m)	Margin (dB)	Det.
1 *	1190.000	72.95	-15.30	57.65	65.25	-7.60	QP
2	1785.000	68.87	-13.69	55.18	65.25	-10.07	QP
3	2980.000	63.47	-8.74	54.73	65.25	-10.52	QP
4	3575.000	58.25	-7.89	50.36	65.25	-14.89	QP
5	4710.000	56.28	-4.60	51.68	65.25	-13.57	QP
6	5520.000	55.63	-0.97	54.66	65.25	-10.59	QP

Channel 48 / 595.660MHz

Vertical

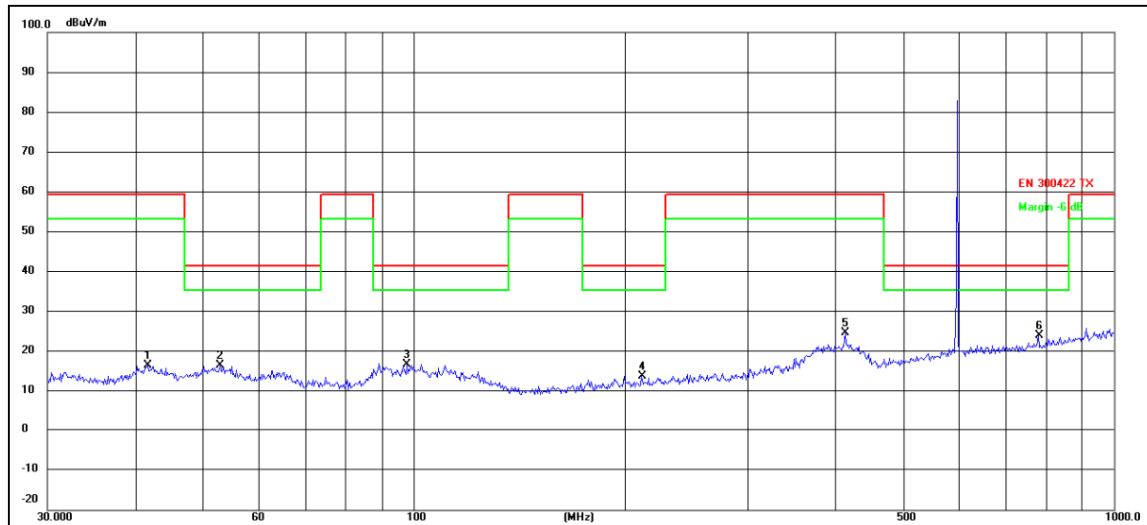

No.	Frequency (MHz)	Reading (dBuV)	Factor (dB/m)	Level (dBuV/m)	Limit (dBuV/m)	Margin (dB)	Det.
1	41.7129	46.18	-29.54	16.64	59.24	-42.60	QP
2	52.9453	45.84	-29.18	16.66	41.28	-24.62	QP
3	97.7983	44.56	-27.72	16.84	41.28	-24.44	QP
4	211.5265	44.04	-30.25	13.79	41.28	-27.49	QP
5	413.2706	50.29	-25.61	24.68	59.24	-34.56	QP
6 *	779.6068	43.93	-19.82	24.11	41.28	-17.17	QP

Vertical

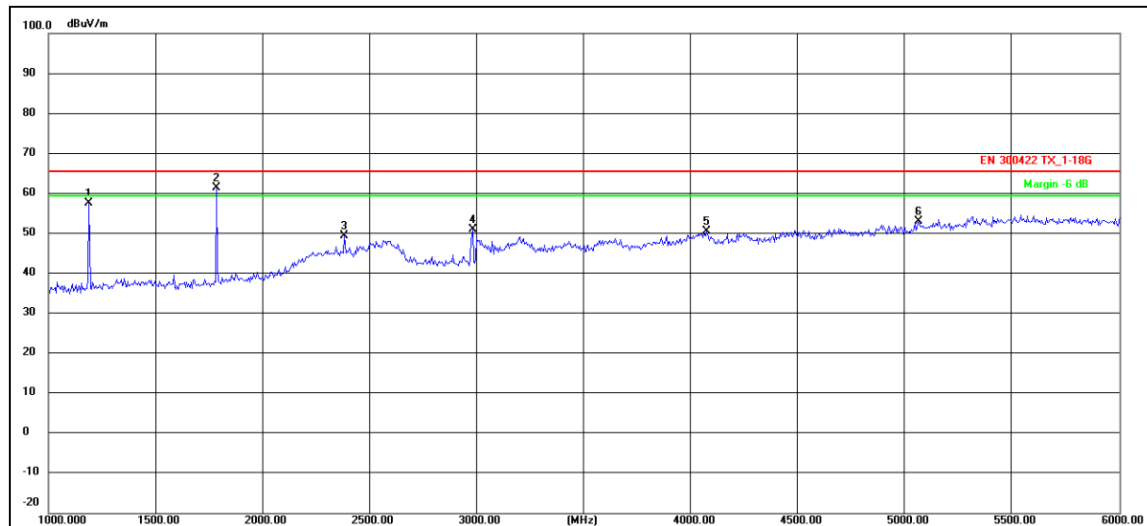

No.	Frequency (MHz)	Reading (dBuV)	Factor (dB/m)	Level (dBuV/m)	Limit (dBuV/m)	Margin (dB)	Det.
1	1190.000	72.89	-15.30	57.59	65.25	-7.66	QP
2 *	1785.000	75.01	-13.69	61.32	65.25	-3.93	QP
3	2380.000	55.83	-6.37	49.46	65.25	-15.79	QP
4	2980.000	59.62	-8.74	50.88	65.25	-14.37	QP
5	4075.000	57.08	-6.53	50.55	65.25	-14.70	QP
6	5065.000	56.17	-3.04	53.13	65.25	-12.12	QP

Note: 1, All detected emissions are more than 20 dB below the limit, In addition to main frequency.

2, Factor = Antenna Factor + Cable Loss + Amplifier Factor

3, Emission Level = Reading level + Factor    Margin = Emission Level - Limit

### 5.5.Frequency Stability

Test Requirement:FCC CFR 47 Part 74.e) 4)

Test Method:FCC CFR 47 Part 2.1055

Requirements:+/-50 ppm

(e) For low power auxiliary stations operating in the bands allocated for TV broadcasting, the following technical requirements apply:

(4) The frequency tolerance of the transmitter shall be 0.005 percent.

Test Procedure:

Frequency stability versus Environmental Temperature

The equipment under test was connected to an external DC power supply and the RF output was connected to a frequency counter via feed through attenuators.

The EUT was placed inside the temperature chamber. After the temperature stabilized for approximately 20 minutes, the frequency of the output signal was recorded from the counter.

Frequency Stability versus Input Voltage

At room temperature ( $25 \pm 5^{\circ}\text{C}$ ), an external variable DC power supply was connected to the EUT. The frequency of the transmitter was measured for 115%, 100% and 85% of the nominal operating input voltage. For hand carried, battery powered equipment, reduce primary supply voltage to the battery operating end point which shall be specified by the manufacturer.

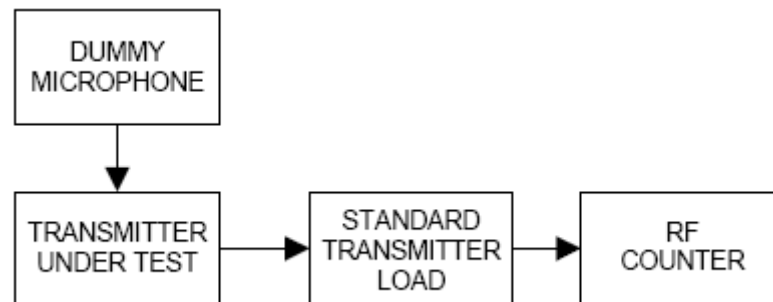

## Test Result:

Assigned Frequency: 556.710 MHz,		
Environment Temperature (°C)	Power Supplied (Vdc)	Frequency Measure with Time Elapsed Total emission within +/- 27.84kHz (KHz)
50	3	+2.93
40	3	+2.13
30	3	+2.61
20	3	+2.55
10	3	+2.33
0	3	+2.56
-10	3	+2.94
-20	3	+2.68
-30	3	+2.11
Environment Temperature (°C)	Power Supplied (Vdc)	Frequency Measure with Time Elapsed Total emission within Max +/- 27.84 kHz (KHz)
25	3	+2.02
25	2.7	+2.31
25	3.3	+2.57

Assigned Frequency: 566.140 MHz,		
Environment Temperature (°C)	Power Supplied (Vdc)	Frequency Measure with Time Elapsed Total emission within +/- 28.31 kHz (KHz)
50	3	+2.31
40	3	+2.16
30	3	+2.71
20	3	+2.85
10	3	+2.72
0	3	+2.04
-10	3	+2.23
-20	3	+2.52
-30	3	+2.14
Environment Temperature (°C)	Power Supplied (Vdc)	Frequency Measure with Time Elapsed Total emission within Max +/- 28.31 kHz (KHz)
25	3	+2.06
25	2.7	+2.12
25	3.3	+2.26



Assigned Frequency: 575.980 MHz		
Environment Temperature (°C)	Power Supplied (Vdc)	Frequency Measure with Time Elapsed Total emission within +/- 28.80 kHz (KHz)
50	3	+2.71
40	3	+2.15
30	3	+2.53
20	3	+2.81
10	3	+2.32
0	3	+2.94
-10	3	+2.12
-20	3	+2.77
-30	3	+2.33
Environment Temperature (°C)	Power Supplied (Vdc)	Frequency Measure with Time Elapsed Total emission within Max +/- 28.80 kHz (KHz)
25	3	+2.45
25	2.7	+2.84
25	3.3	+2.01

Assigned Frequency: 576.390 MHz,		
Environment Temperature (°C)	Power Supplied (Vdc)	Frequency Measure with Time Elapsed Total emission within +/- 28.82kHz (KHz)
50	3	+2.93
40	3	+2.13
30	3	+2.61
20	3	+2.55
10	3	+2.33
0	3	+2.56
-10	3	+2.94
-20	3	+2.68
-30	3	+2.11
Environment Temperature (°C)	Power Supplied (Vdc)	Frequency Measure with Time Elapsed Total emission within Max +/- 28.82 kHz (KHz)
25	3	+2.02
25	2.7	+2.31
25	3.3	+2.57

Assigned Frequency: 585.820 MHz,		
Environment Temperature (°C)	Power Supplied (Vdc)	Frequency Measure with Time Elapsed Total emission within +/- 29.29 kHz (KHz)
50	3	+2.31
40	3	+2.16
30	3	+2.71
20	3	+2.85
10	3	+2.72
0	3	+2.04
-10	3	+2.23
-20	3	+2.52
-30	3	+2.14
Environment Temperature (°C)	Power Supplied (Vdc)	Frequency Measure with Time Elapsed Total emission within Max +/- 29.29 kHz (KHz)
25	3	+2.06
25	2.7	+2.12
25	3.3	+2.26

Assigned Frequency: 595.660MHz		
Environment Temperature (°C)	Power Supplied (Vdc)	Frequency Measure with Time Elapsed Total emission within +/- 29.78 kHz (KHz)
50	3	+2.71
40	3	+2.15
30	3	+2.53
20	3	+2.81
10	3	+2.32
0	3	+2.94
-10	3	+2.12
-20	3	+2.77
-30	3	+2.33
Environment Temperature (°C)	Power Supplied (Vdc)	Frequency Measure with Time Elapsed Total emission within Max +/- 29.78 kHz (KHz)
25	3	+2.45
25	2.7	+2.84
25	3.3	+2.01

Battery end point: 3 Vdc

The results: The unit does meet the FCC requirements.

5.6.Modulation Characteristics

Test Requirement:FCC CFR 47 Part 74.e) 3)

Test Method:FCC CFR 47 Part 2.1047 & TIA/EIA 603 E 2016:Land Mobile  $\pi/4$ -DQPSK or PM Communications Equipment Measurement and Performance Standards

Requirements:

(e) For low power auxiliary stations operating in the bands allocated for TV broadcasting, the following technical requirements apply:

(3) Any form of modulation may be used. A maximum deviation of  $\pm 75$  kHz is permitted when frequency modulation is employed.

Test Procedure:

**Audio Frequency Response**

The RF output of the transceiver was connected to the input of FSP 30 with FM deviation module through sufficient attenuation so as not to overload the meter or distort the reading. An audio signal generator was connected to the audio input of microphone.

The audio signal input level was adjusted to obtain 20% of the maximum rated system deviation at 1 kHz, and recorded as DEV REF . With the audio signal generator level unchanged, set the generator frequency between 100 to 5000 Hz. The transmitter deviations (DEV FREQ ) were measured and the audio frequency response was calculated as  $20\log_{10} [DEV FREQ / DEV REF ]$

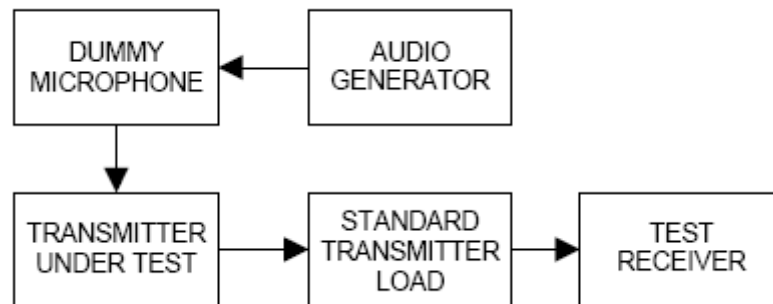

The plot(s) of Audio Frequency Response is presented hereinafter as reference.

Test Result:

Not Applicable. The EUT is a digital modulation wireless microphone.

### Modulation Limiting

- a) Adjust the transmitter per the manufacturer's procedure for full rated system deviation.
- b) Set the test receiver to measure peak positive deviation. Set the audio bandwidth for  $\leq 0.25$  Hz to  $\geq 15,000$  Hz. Turn the de-emphasis function off.
- c) Apply a **1000 Hz** modulating signal to the transmitter from the audio frequency generator, and adjust the level to obtain **60% of full rated system deviation**.
- d) Increase the level from the audio frequency generator by 20 dB in one step (rise time between the 10% and 90% points shall be 0.1 second maximum).
- e) Measure both the instantaneous and steady-state deviation at and after the time of increasing the audio input level.

With the level from the audio frequency generator held constant at the level obtained in step e), slowly vary the audio frequency from 100 to 15k Hz and observe the steady-state deviation. Record the maximum deviation.

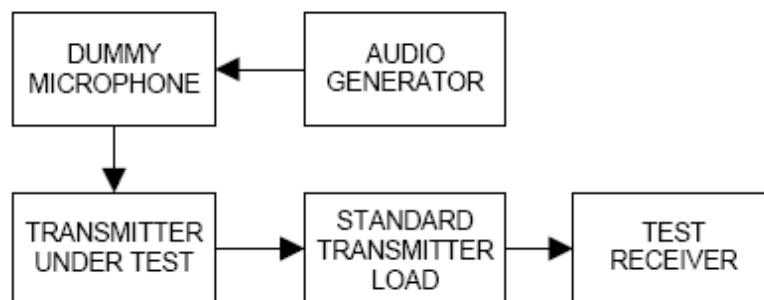

Test at five different modulating frequencies (100Hz, 300Hz, 500Hz, 1KHz, 2.5kHz, 5kHz, 10kHz, 15kHz), the output level of the audio generator was varied up to 1V and the FM deviation level was recorded.

Positive peak deviation

Test Result:

Not Applicable. The EUT is a digital modulation wireless microphone.

5.7.Necessary bandwidth (BN)

5.7.1.Measurement:

Measurement parameter	
Detector:	Peak - Quasi Peak / Average
Sweep time:	Auto
Resolution bandwidth:	1 kHz
Video bandwidth:	1 kHz
Span:	Fc-1MHz to fc+1MHz(2MHz)
Trace mode:	Max Hold

5.7.2.Limits:

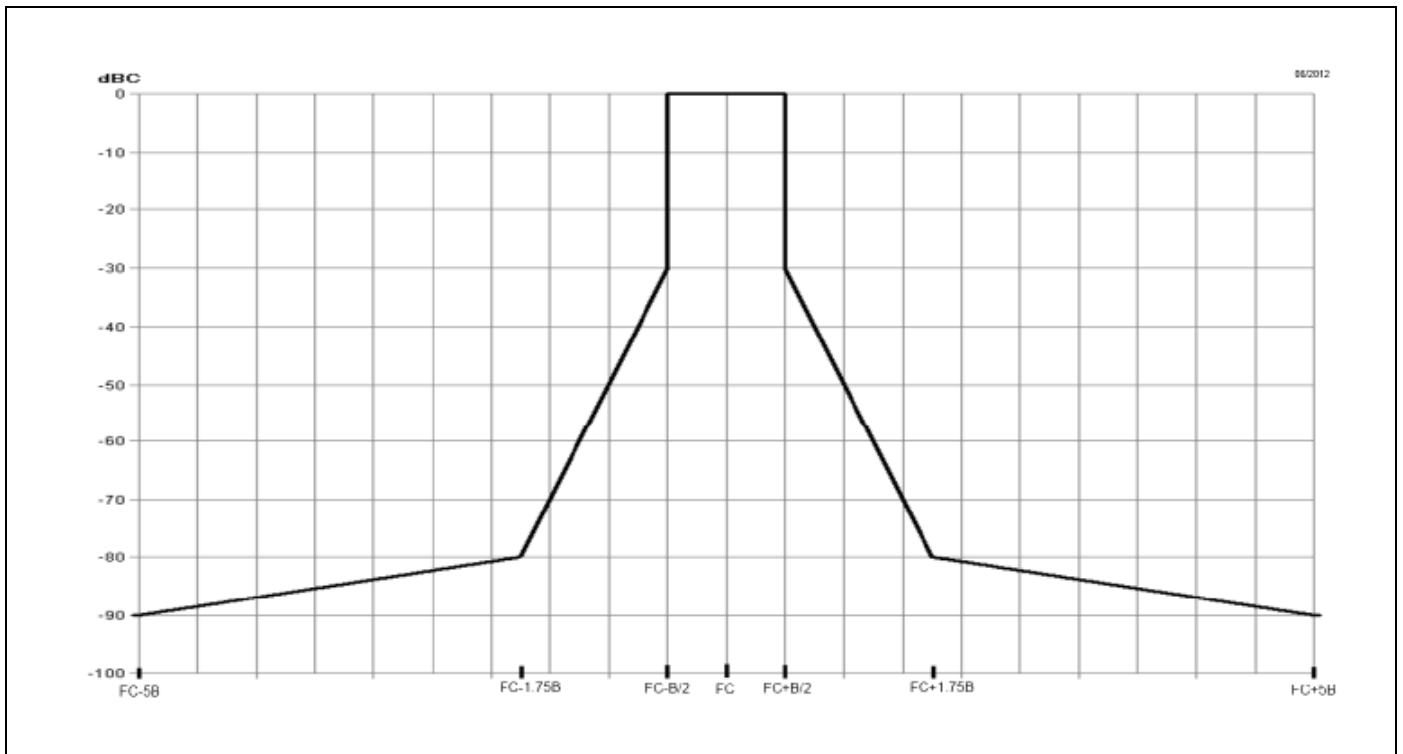

5.7.3. Results:

Necessary bandwidth

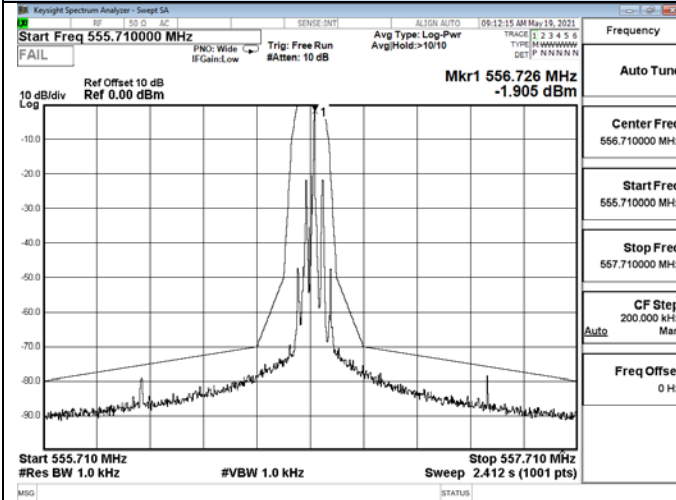

Channel 01 / 556.710 MHz

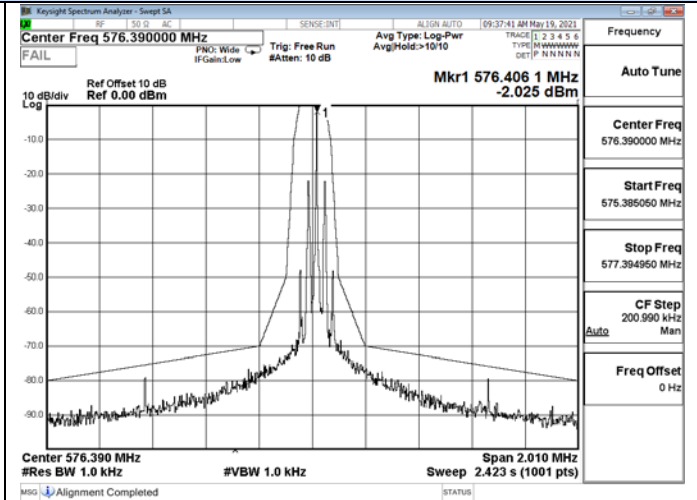

Channel 01 / 576.390MHz

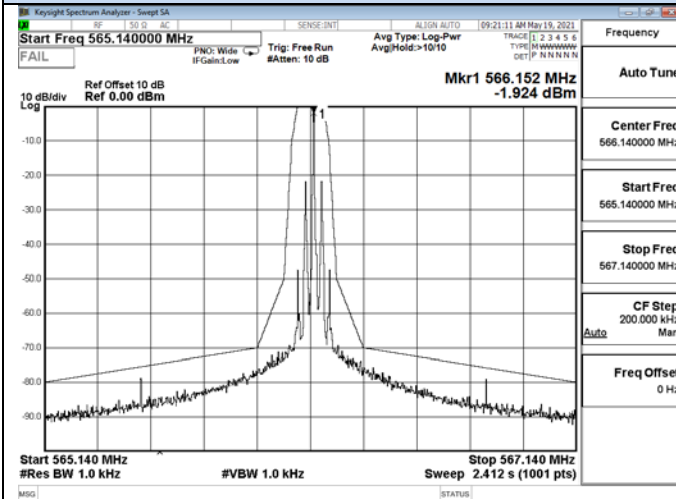

Channel 24/ 566.140MHz

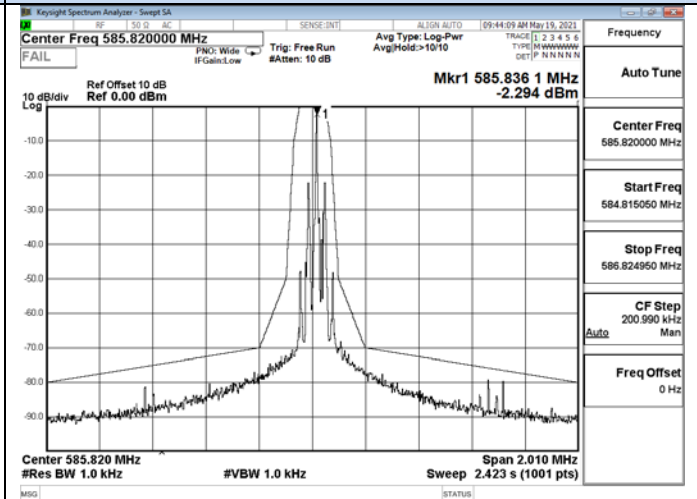

Channel 24/ 585.820MHz

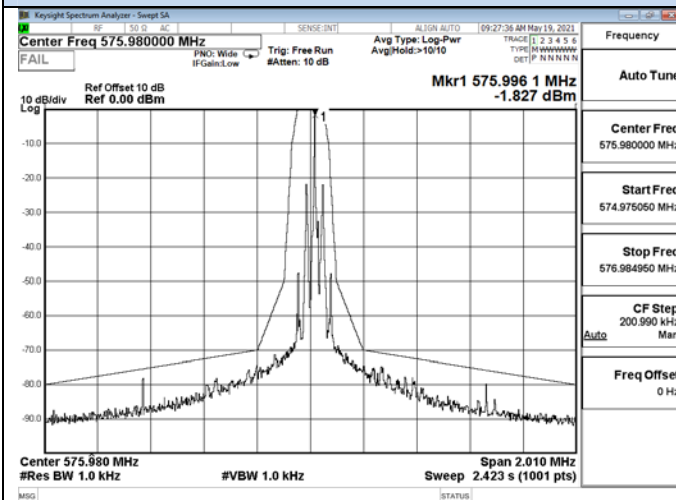

Channel 48/ 575.980MHz

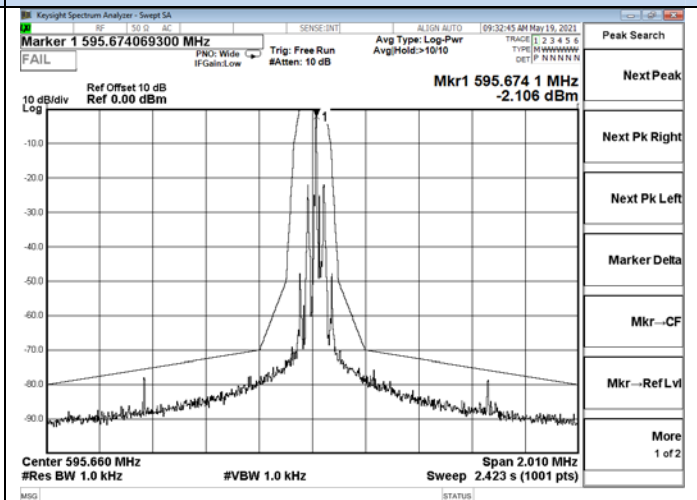

Channel 48/ 595.660MHz

## 6. LIST OF MEASURING EQUIPMENTS

Item	Equipment	Manufacturer	Model No.	Serial No.	Cal Date	Due Date
1	MXA Signal Analyzer	Agilent	N9020A	MY49100060	2020-11-17	2021-11-16
2	DC Power Supply	Agilent	E3642A	N/A	2020-11-13	2021-11-12
3	Temperature & Humidity Chamber	GUANGZHOU GOGNWEN	GDS-100	70932	2020-10-08	2021-10-07
4	EMI Test Software	Farad	EZ	/	N/A	N/A
5	3m Full Anechoic Chamber	MRDIANZI	FAC-3M	MR009	2020-09-26	2021-09-25
6	Positioning Controller	MF	MF7082	MF78020803	2020-06-22	2021-06-21
7	Active Loop Antenna	SCHWARZBECK	FMZB 1519B	00005	2018-07-26	2021-07-25
8	By-log Antenna	SCHWARZBECK	VULB9163	9163-470	2018-07-26	2021-07-25
9	Horn Antenna	SCHWARZBECK	BBHA 9120D	9120D-1925	2018-07-02	2021-07-01
10	EMI Test Receiver	R&S	ESR 7	101181	2020-06-22	2021-06-21
11	RS SPECTRUM ANALYZER	R&S	FSP40	100503	2020-11-17	2021-11-16
12	Broadband Preamplifier	/	BP-01M18G	P190501	2020-06-22	2021-06-21
13	RF Cable-R03m	Jye Bao	RG142	CB021	2020-06-22	2021-06-21
14	RF Cable-HIGH	SUHNER	SUCOFLEX 106	03CH03-HY	2020-06-22	2021-06-21
15	EMI Test Receiver	R&S	ESPI	101840	2020-06-22	2021-06-21
16	Artificial Mains	R&S	ENV216	101288	2020-06-22	2021-06-21
17	10dB Attenuator	SCHWARZBECK	MTS-IMP-136	261115-001-0032	2020-06-22	2021-06-21
18	3m Semi Anechoic Chamber	SIDT FRANKONIA	SAC-3M	03CH03-HY	2020-09-25	2021-09-25

## **7. TEST SETUP PHOTOGRAPHS OF EUT**

Please refer to separated files for Test Setup Photos of the EUT.

## **8. EXTERIOR PHOTOGRAPHS OF THE EUT**

Please refer to separated files for External Photos of the EUT.

## **9. INTERIOR PHOTOGRAPHS OF THE EUT**

Please refer to separated files for Internal Photos of the EUT.

-----THE END OF REPORT-----