

FCC TEST REPORT

FCC ID: 2ARLXFT-06

Product Name:	Fast Wireless Charger
Trademark:	N/A
Model Number:	FT-06
Prepared For :	Shengzheshi Mingtuo Technology Co.,Ltd.
Address :	Room 608, Building 407, Sangda Industrial Area, Lanhai Road, Huaqiang North Street, Futian District, Shenzhen City.
Prepared By :	Shenzhen BCTC Testing Co., Ltd.
Address :	BCTC Building & 1-2F, East of B Building, Pengzhou Industrial, Fuyuan 1st Road, Qiaotou Community, Fuyong Street, Bao'an District, Shenzhen, China
Test Date:	Sep. 25, 2018 - Oct. 17, 2018
Date of Report :	Oct. 17, 2018
Report No.:	BCTC-LH180902594E

TABLE OF CONTENTS

TEST REPORT DECLARATION	3
1.GENERAL INFORMATION	4
1.1. Report information	4
1.2. Measurement Uncertainty	4
1.3. Test Facility.....	4
1.4. Test Uncertainty.....	4
2.PRODUCT DESCRIPTION	5
2.1. EUT Description.....	5
2.2. Block Diagram of EUT Configuration.....	5
2.3. Test Conditions	5
2.4. Description Of Support Units (Conducted Mode)	6
3.TEST RESULTS SUMMARY	6
4. TEST EQUIPMENT USED.....	7
4.1. For Conducted Emission Test	7
4.2. For Radiated Emission Measurement.....	7
5.CONDUCTED EMISSION TEST.....	8
5.1. Block Diagram of Test Setup	8
5.2. Test Standard.....	8
5.3. Conducted Emission Limit.....	8
5.4. EUT Configuration on Test.....	8
5.5. Operating Condition of EUT	9
5.6. Test Procedure.....	9
5.7. Test Result.....	9
6.RADIATED EMISSION MEASUREMENT	12
6.1. Block Diagram of Test Setup	12
6.2. Test Standard.....	13
6.3. EMI Test Receiver Setup	13
6.4. Test Procedure.....	14
6.5. Test Result.....	14
7.EUT TEST PHOTOS.....	18
8.EUT PHOTOS	20

TEST REPORT DECLARATION

Applicant : Shengzheshi Mingtuo Technology Co.,Ltd.
Address : Room 608, Building 407, Sangda Industrial Area, Lanhai Road,
Huaqiang North Street, Futian District, Shenzhen City.
EUT Description : Fast Wireless Charger
Model Number : FT-06
Serial Model : N/A

Test Standards:

FCC Part 15 C

This device described above has been tested by BCTC, and the test results show that the equipment under And it is applicable only to the tested sample identified in the report.

This report shall not be reproduced except in full, without the written approval of BCTC, this document may be altered or revised by BCTC, personal only, and shall be noted in the revision of the document.

Prepared by(Engineer): Amou Zhang

Amou Zhang

Reviewer(Supervisor): Eric Yang

Eric Yang

Approved(Manager): Carson Zhang



1. GENERAL INFORMATION

1.1. Report information

- 1.1.1. This report is not a certificate of quality; it only applies to the sample of the specific product/equipment given at the time of its testing. The results are not used to indicate or imply that they are application to the similar items. In addition, such results must not be used to indicate or imply that BCTC approves recommends or endorses the manufacture, supplier or use of such product/equipment, or that BCTC in any way guarantees the later performance of the product/equipment.
- 1.1.2. The sample/s mentioned in this report is/are supplied by Applicant, BCTC therefore assumes no responsibility for the accuracy of information on the brand name, model number, origin of manufacture or any information supplied.
- 1.1.3. Additional copies of the report are available to the Applicant at an additional fee. No third part can obtain a copy of this report through BCTC, unless the applicant has authorized BCTC in writing to do so.

1.2. Measurement Uncertainty

Available upon request.

1.3. Test Facility

Site Description
Name of Firm : Shenzhen BCTC Testing Co., Ltd.

Site Location : BCTC Building & 1-2F, East of B Building,
Pengzhou Industrial, Fuyuan 1st Road, Qiaotou
Community, Fuyong Street, Bao'an District,
Shenzhen, China

1.4. Test Uncertainty

Conducted Emission = ± 2.66 dB
Uncertainty
Radiated Emission Uncertainty = ± 4.15 dB

2. PRODUCT DESCRIPTION

2.1.EUT Description

Description	: Fast Wireless Charger
Applicant	: Shengzheshi Mingtuo Technology Co.,Ltd. Room 608, Building 407, Sangda Industrial Area, Lanhai Road, Huaqiang North Street, Futian District, Shenzhen City.
Manufacturer	: Shengzheshi Mingtuo Technology Co.,Ltd. Room 608, Building 407, Sangda Industrial Area, Lanhai Road, Huaqiang North Street, Futian District, Shenzhen City.
Model Number	: FT-06
Serial Model	: N/A
Model Difference	: N/A.
Power Supply	Input: DC 5V 2A Output: 5V 1A (5W)
Work Frequency	: 110-205KHz

2.2.Block Diagram of EUT Configuration

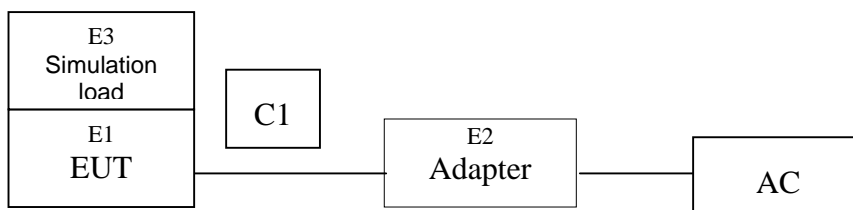

2.3.Test Conditions

Temperature: 23~25°C

Relative Humidity: 55~63 %

2.4. Description Of Support Units (Conducted Mode)

The EUT has been tested as an independent unit together with other necessary accessories or support units. The following support units or accessories were used to form a representative test configuration during the tests.

Item	Equipment	Mfr/Brand	Model/Type No.	Series No.	Note
E1	Fast Wireless Charger	N/A	FT-06	N/A	EUT
E2	Adapter	N/A	CD122	N/A	Lab provide
E3	Simulation load	N/A	BCTC027	N/A	Lab provide

Item	Shielded Type	Ferrite Core	Length	Note
C1	NO	NO	0.8M	USB cable unshielded

Note:

- (1) The support equipment was authorized by Declaration of Confirmation.
- (2) For detachable type I/O cable should be specified the length in cm in 『Length』 column.
- (3) “YES” is means “shielded” “with core”; “NO” is means “unshielded” “without core”.

3. TEST RESULTS SUMMARY

Table 1 Test Results Summary

Test Items	Test Results
Conducted disturbance	Pass
Radiated disturbance	Pass

Remark: “N/A” means “Not applicable.”

4. TEST EQUIPMENT USED

4.1. For Conducted Emission Test

Item	Equipment	Manufacturer	Type No.	Serial No.	Last calibration	Calibrated until
1	Test Receiver	R&S	ESCI	1166.5950K03-1 01165-ha	2018.06.19	2019.06.18
2	LISN	SCHWARZBECK	NSLK8127	8127739	2018.06.19	2019.06.18
3	LISN	R&S	NSLK8126	8126487	2018.08.06	2019.08.05
4	RF cables	R&S	R204	R20X	2018.08.06	2019.08.05
5	Attenuator	R&S	ESH3-Z2	143206	2018.08.06	2019.08.05

4.2. For Radiated Emission Measurement

Item	Equipment	Manufacturer	Type No.	Serial No.	Last calibration	Calibrated until
6	Horn Antenna (14GHz-40GHz)	SCHWARZBECK	BBHA 9170	9170-181	2018.08.06	2019.08.05
7	Amplifier (9KHz-6GHz)	SCHWARZBECK	BBV9744	9744-0037	2018.06.20	2019.06.19
8	Amplifier (1GHz-18GHz)	SCHWARZBECK	BBV9718	9718-309	2018.06.20	2019.06.19
9	Amplifier (18GHz-40GHz)	SCHWARZBECK	BBV 9721	9721-205	2018.08.06	2019.08.05
10	Loop Antenna (9KHz-30MHz)	SCHWARZBECK	FMZB1519B	00014	2018.06.23	2019.06.22
11	Bilog Antenna (30MHz-3GHz)	SCHWARZBECK	VULB9163	VULB9163-942	2018.06.23	2019.06.23
12	Horn Antenna (1GHz-18GHz)	SCHWARZBECK	BBHA9120D	1541	2018.06.23	2019.06.22
13	RF cables1 (9kHz-1GHz)	R&S	R203	R20X	2018.08.06	2019.08.05
14	RF cables2 (1GHz-40GHz)	R&S	R204	R21X	2018.08.06	2019.08.05
15	Antenna connector	Florida RF Labs	N/A	RF 01#	2018.08.06	2019.08.05
16	Power Metter	Keysight	E4419	\	2018.04.15	2019.04.15
17	Power Sensor (AV)	Keysight	E9 300A	\	2018.04.15	2019.04.15
18	Signal Analyzer 9kHz-26.5GHz	Agilent	N9010A	MY48030494	2018.08.06	2019.08.05
19	Test Receiver 20kHz-40GHz	R&S	ESU 40	100376	2018.08.06	2019.08.05
20	D.C. Power Supply	LongWei	PS-305D	010964729	2018.08.06	2019.08.05

5. CONDUCTED EMISSION TEST

5.1. Block Diagram of Test Setup

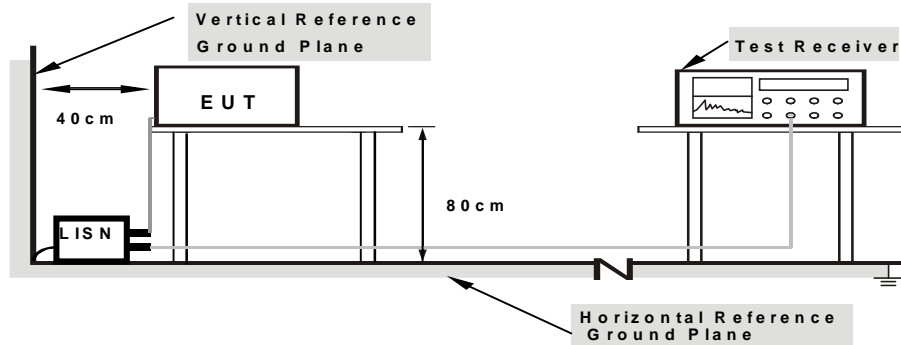

Note: 1. Support units were connected to second LISN.
 2. Both of LISNs (AMN) are 80 cm from EUT and at least 80 cm from other units and other metal planes

The setup of EUT is according with per ANSI C63.10-2013 measurement procedure. The specification used was with the FCC Part 15.207 limits.

5.2. Test Standard

FCC§15.207

5.3. Conducted Emission Limit

Frequency MHz	Limits dB(μ V)	
	Quasi-peak Level	Average Level
0.15 ~ 0.50	66 ~ 56*	56 ~ 46*
0.50 ~ 5.00	56	46
5.00 ~ 30.00	60	50

Notes: 1. *Decreasing linearly with logarithm of frequency.

5.4. EUT Configuration on Test

The following equipments are installed on conducted emission test to meet FCC Part 15.207 requirement and operating in a manner, which tends to maximize its emission characteristics in a normal application.

5.4.1.milestone dual

Model Number: FT-06

5.5.Operating Condition of EUT

5.5.1.Setup the EUT and simulators as shown in Section 5.1.

5.5.2.Turn on the power of all equipments.

5.5.3.Let the EUT work in test modes (EUT Working) and test it.

5.6.Test Procedure

The EUT is put on a table of non-conducting material that is 80cm high. The vertical conducting wall of shielding is located 40cm to the rear of the EUT. The power line of the EUT is connected to the AC mains through a Artificial Mains Network (A.M.N.). A EMI test receiver (R&S Test Receiver ESHS30) is used to test the emissions form both sides of AC line. The bandwidth of EMI test receiver is set at 9kHz.

The bandwidth of the test receiver (R&S Test Receiver ESHS30) is set at 10KHz.

We pretest AC 120V and AC 240V, the worst voltage was AC 120V and the data recording in the report.

5.7.Test Result

PASS

Please refer to the following pages.



EUT:	Fast Wireless Charger	Model Name :	FT-06
Temperature:	25 °C	Relative Humidity:	54%
Test Voltage :	AC 120V/60Hz	Phase :	L
Test Mode:	Normal Link		

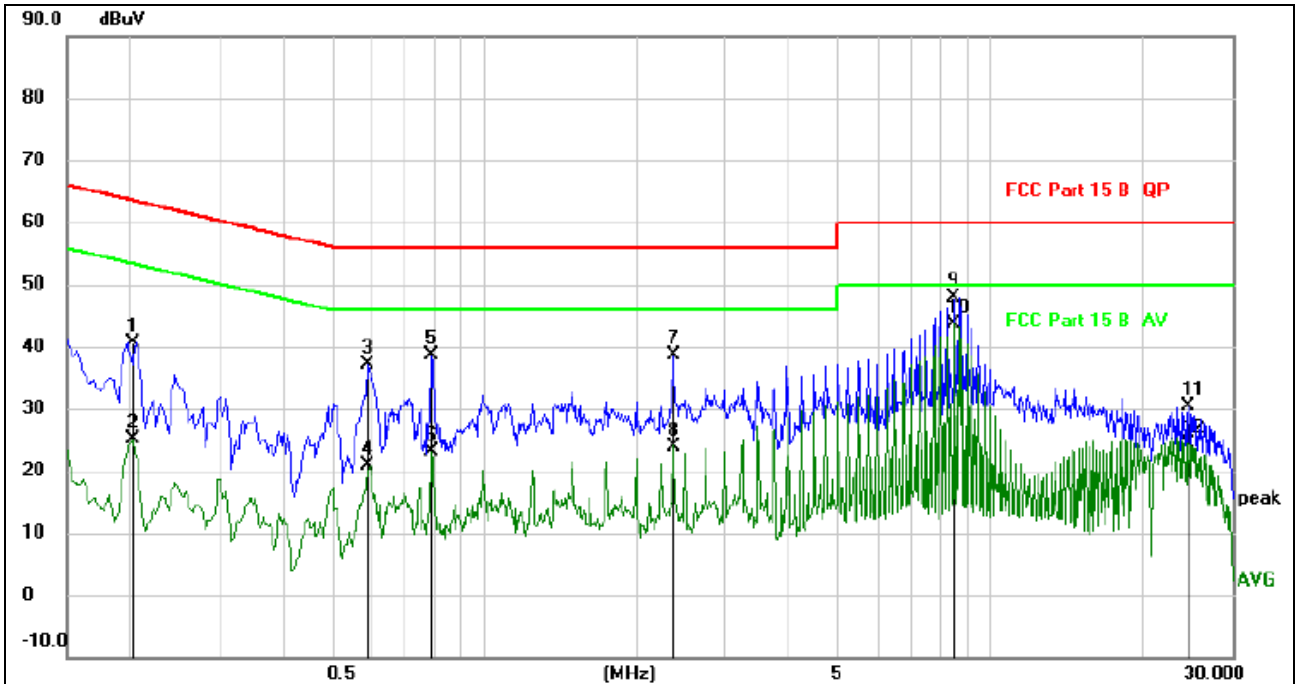

Remark:

1. All readings are Quasi-Peak and Average values.
2. Factor = Insertion Loss + Cable Loss.

No. Mk.	Freq. MHz	Reading Level dBuV	Correct Factor	Measurement dBuV	Limit dBuV	Over dB	Detector	Comment
1	0.2020	31.22	9.46	40.68	63.53	-22.85	QP	
2	0.2020	15.61	9.46	25.07	53.53	-28.46	AVG	
3	0.5899	27.10	9.96	37.06	56.00	-18.94	QP	
4	0.5899	10.95	9.96	20.91	46.00	-25.09	AVG	
5	0.7900	29.07	9.63	38.70	56.00	-17.30	QP	
6	0.7900	13.60	9.63	23.23	46.00	-22.77	AVG	
7	2.3699	29.05	9.62	38.67	56.00	-17.33	QP	
8	2.3699	14.38	9.62	24.00	46.00	-22.00	AVG	
9	8.4780	38.18	9.71	47.89	60.00	-12.11	QP	
10 *	8.4780	33.80	9.71	43.51	50.00	-6.49	AVG	
11	24.5620	20.56	9.75	30.31	60.00	-29.69	QP	
12	24.5620	14.71	9.75	24.46	50.00	-25.54	AVG	

EUT:	Fast Wireless Charger	Model Name :	FT-06
Temperature:	25 °C	Relative Humidity:	54%
Test Voltage :	AC 120V/60Hz	Phase :	N
Test Mode:	Normal Link		

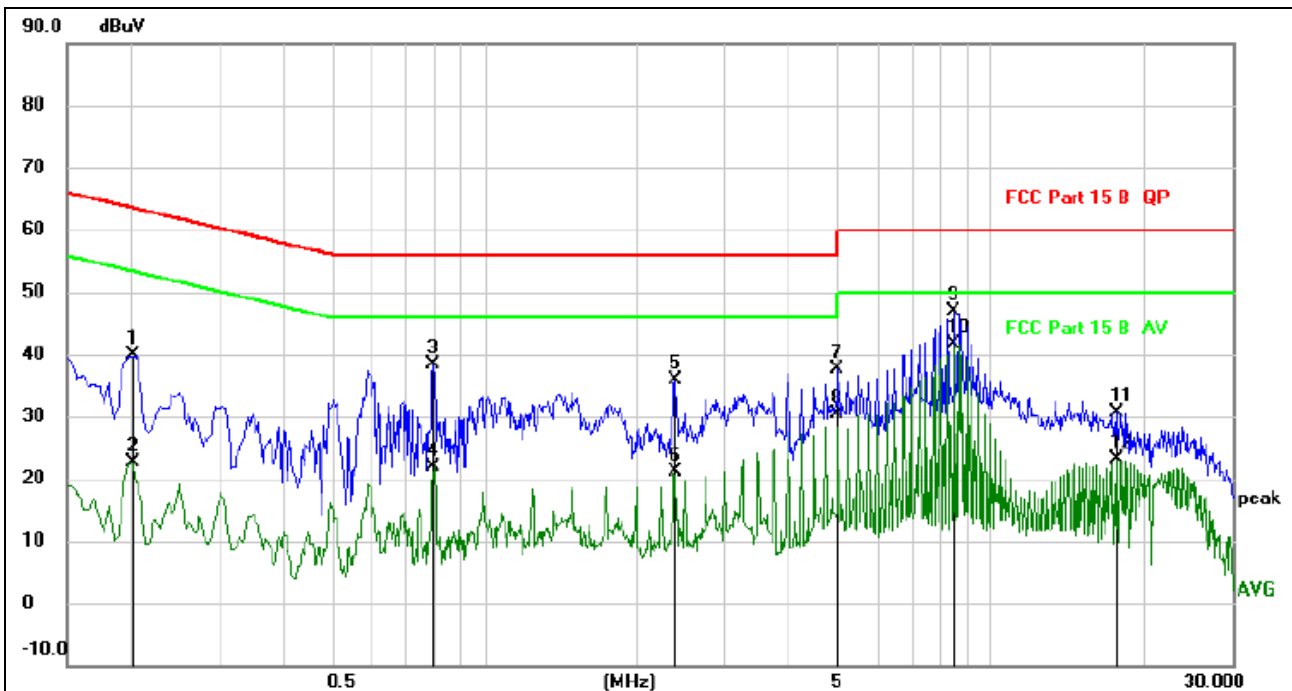

Remark:

1. All readings are Quasi-Peak and Average values.
2. Factor = Insertion Loss + Cable Loss.

No.	Mk.	Freq. MHz	Reading Level dBuV	Correct Factor	Measure- ment dBuV	Limit dBuV	Over dB	Detector	Comment
1		0.2020	30.39	9.46	39.85	63.53	-23.68	QP	
2		0.2020	13.17	9.46	22.63	53.53	-30.90	AVG	
3		0.7940	28.78	9.63	38.41	56.00	-17.59	QP	
4		0.7940	12.14	9.63	21.77	46.00	-24.23	AVG	
5		2.3900	26.32	9.62	35.94	56.00	-20.06	QP	
6		2.3900	11.55	9.62	21.17	46.00	-24.83	AVG	
7		4.9860	27.77	9.80	37.57	56.00	-18.43	QP	
8		4.9860	20.53	9.80	30.33	46.00	-15.67	AVG	
9		8.4780	37.12	9.71	46.83	60.00	-13.17	QP	
10	*	8.4780	31.86	9.71	41.57	50.00	-8.43	AVG	
11		17.7020	20.82	9.75	30.57	60.00	-29.43	QP	
12		17.7020	13.33	9.75	23.08	50.00	-26.92	AVG	

6. RADIATED EMISSION MEASUREMENT

6.1. Block Diagram of Test Setup

6.1.1. Block Diagram of connection between the EUT and the simulators

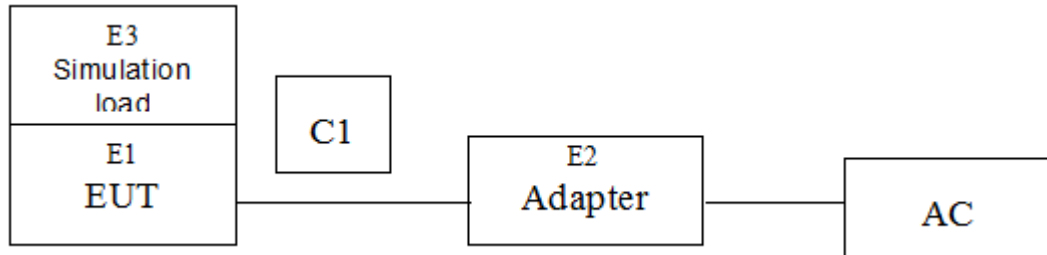

6.1.2. Anechoic Chamber Test Setup Diagram

(A) Radiated Emission Test-Up Frequency Below 30MHz

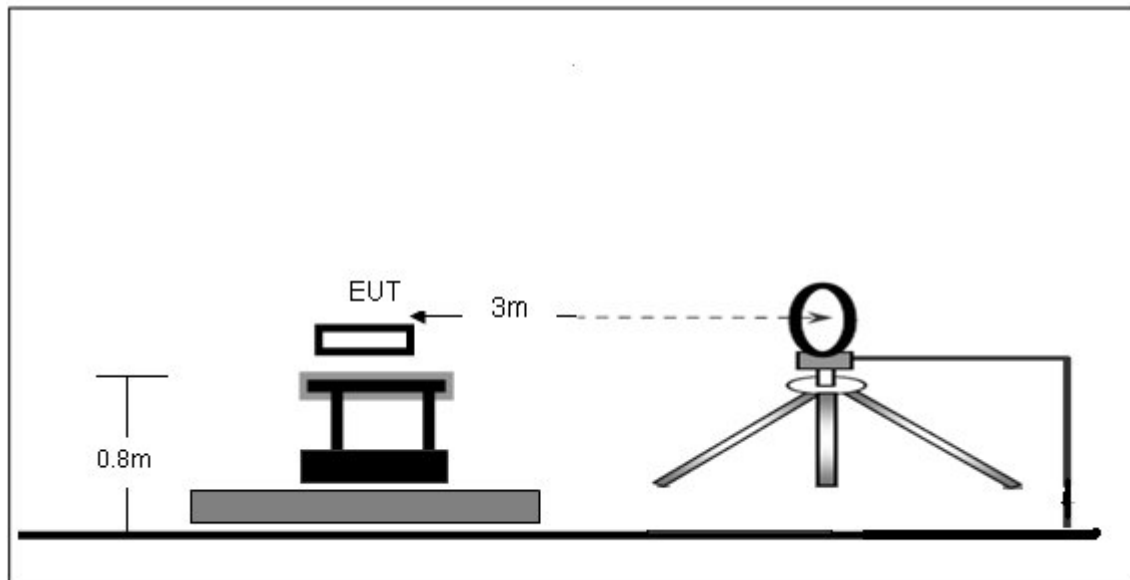

(B) Radiated Emission Test-Up Frequency 30MHz~1GHz

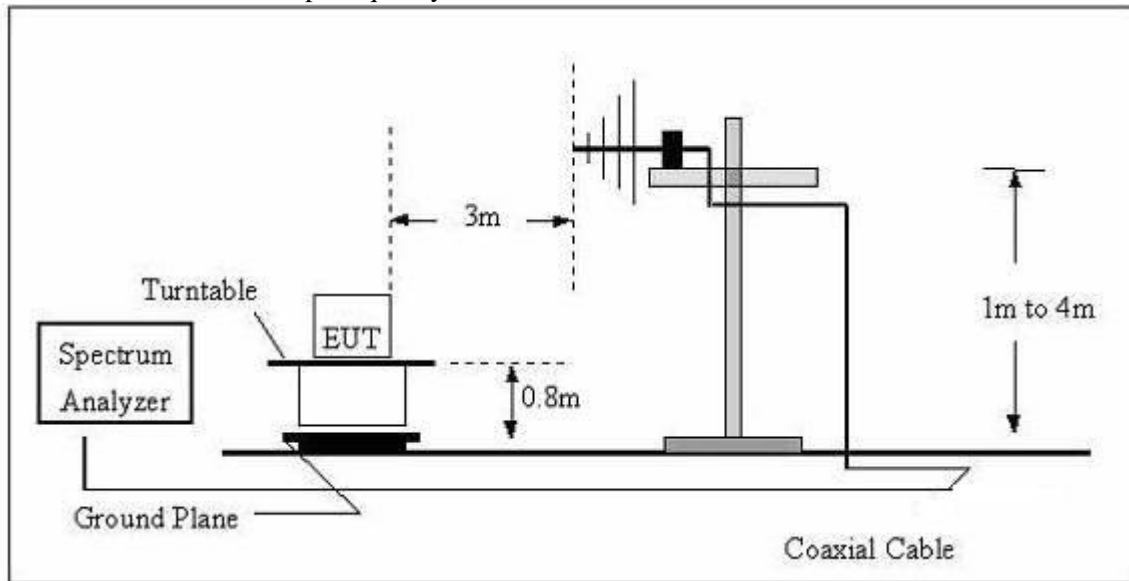

The radiated emission tests were performed in the 3 meters chamber test site, using the setup accordance with the ANSI C63.10-2013. The specification used was the FCC 15.209 and FCC 15.205 limits.

6.2. Test Standard

FCC §15.209; §15.205

Test Standard	FCC Part15 C Section 15.209 and 15.205				
	Frequency (MHz)	Field strength (microvolt/meter)	Limit (dBuV/m)	Remark	Measurement distance (m)
Test Limit	0.009MHz~0.490MHz	2400/F(kHz)	-	-	300
	0.490MHz-1.705MHz	24000/F(kHz)	-	-	30
	1.705MHz-30MHz	30	-	-	30
	30MHz~88MHz	100	40.0	Quasi-peak	3
	88MHz~216MHz	150	43.5	Quasi-peak	3
	216MHz~960MHz	200	46.0	Quasi-peak	3
	Above 1000MHz	500	54.0	Average	3
			74.0	Peak	3

6.3. EMI Test Receiver Setup

The system was investigated from 9kHz to1GHz.

During the radiated emission test, the EMI test receiver setup was set with the following configurations:

Frequency Range	RBW	Video B/W	Detector
9 kHz – 150 kHz	200 kHz	1 kHz	QP
150 kHz – 30MHz	9kHz	30kHz	QP
30 MHz – 1000 MHz	120 kHz	300 kHz	QP

Note: For the frequency bands 9-90 kHz and 110-490 kHz, the test was based on average detector.

6.4. Test Procedure

The EUT is placed on a turn table which is 0.8 meter above ground. The turn table can rotate 360 degrees to determine the position of the maximum emission level. The EUT is set 3 meters away from the receiving antenna which is mounted on a antenna tower. The antenna can move up and down between 1 to 4 meters to find out the maximum emission level. Broadband antenna (calibrated by dipole antenna) are used as a receiving antenna. Both horizontal and vertical polarization of the antenna are set on measurement.

6.5. Test Result

PASS

Please refer to the following pages.

9kHz-30MHz

EUT:	Fast Wireless Charger	Model Name :	FT-06
Temperature:	25 °C	Relative Humidity:	54%
Test Voltage :	AC 120V/60Hz	Polarization :	Horizontal
Test Mode :	Normal Link		

Frequency (kHz)	Meter Reading (dBμV)	Factor (dB)	Emission Level (dBμV/m)	Limits (dBμV/m)	Margin (dB)	Detector Type
41.3800	37.65	20.15	57.80	135.27	-77.47	PK
41.3800	33.28	20.15	53.43	115.27	-61.84	AV
153.2400	50.54	20.33	70.87	123.90	-53.03	PK
153.2400	45.32	20.33	65.65	103.90	-38.25	AV
263.2000	59.61	20.55	80.16	119.20	-39.04	PK
263.2000	52.36	20.55	72.91	99.20	-26.29	AV
621.2500	30.54	20.64	51.18	71.74	-20.56	QP
785.3600	32.12	21.26	53.38	69.70	-16.32	QP
956.3200	24.29	22.32	46.61	67.99	-21.38	QP

Note:

Pre-scan in the all of mode, the worst case in of was recorded.

Factor = antenna factor + cable loss – pre-amplifier.

Margin = Emission Level- Limit.

30MHz-1GHz

EUT:	Fast Wireless Charger	Model Name :	FT-06
Temperature:	25 °C	Relative Humidity:	54%
Test Voltage :	AC 120V/60Hz	Polarization :	Horizontal
Test Mode :	Normal Link		

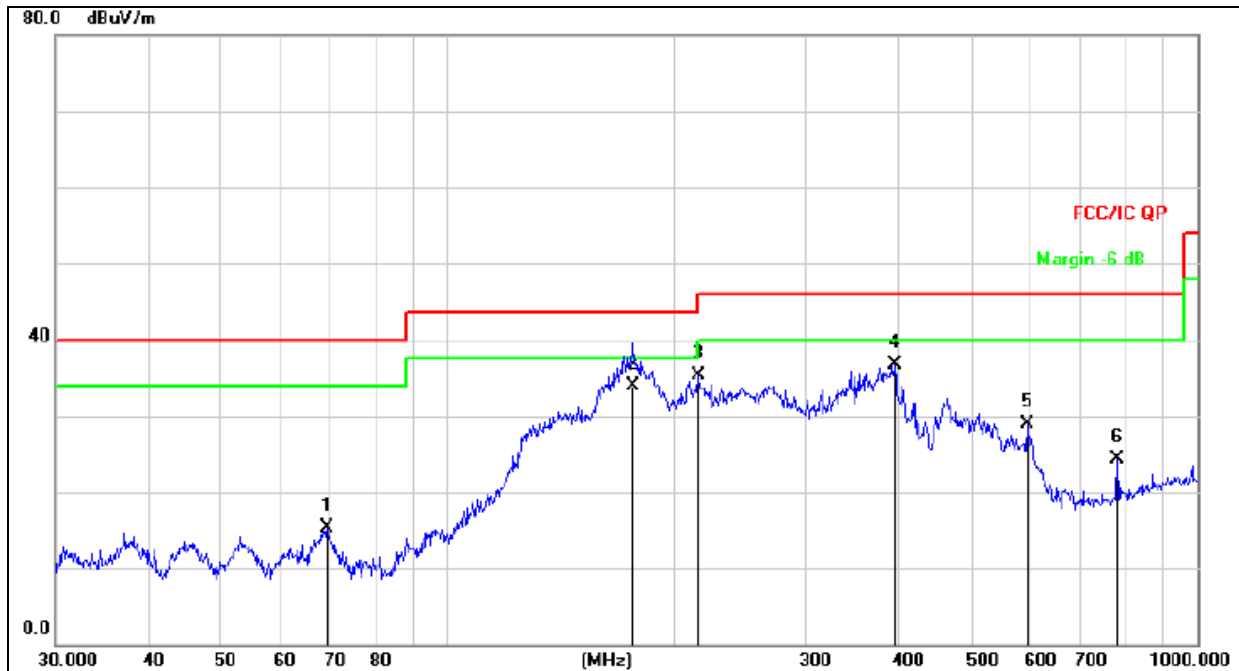

Remark:
 Factor = Antenna Factor + Cable Loss – Pre-amplifier.

No.	Mk.	Freq.	Reading Level	Correct Factor	Measurement	Limit	Over	Detector
		MHz	dBuV	dB	dBuV/m	dB/m	dB	
1		69.1141	33.28	-17.96	15.32	40.00	-24.68	QP
2		176.8688	51.59	-17.77	33.82	43.50	-9.68	QP
3		216.0240	51.22	-15.92	35.30	46.00	-10.70	QP
4	*	394.8545	47.84	-11.20	36.64	46.00	-9.36	QP
5		593.0497	35.62	-6.69	28.93	46.00	-17.07	QP
6		782.3453	28.11	-3.89	24.22	46.00	-21.78	QP

EUT:	Fast Wireless Charger	Model Name :	FT-06
Temperature:	25 °C	Relative Humidity:	54%
Test Voltage :	AC 120V/60Hz	Polarization :	Vertical
Test Mode :	Normal Link		

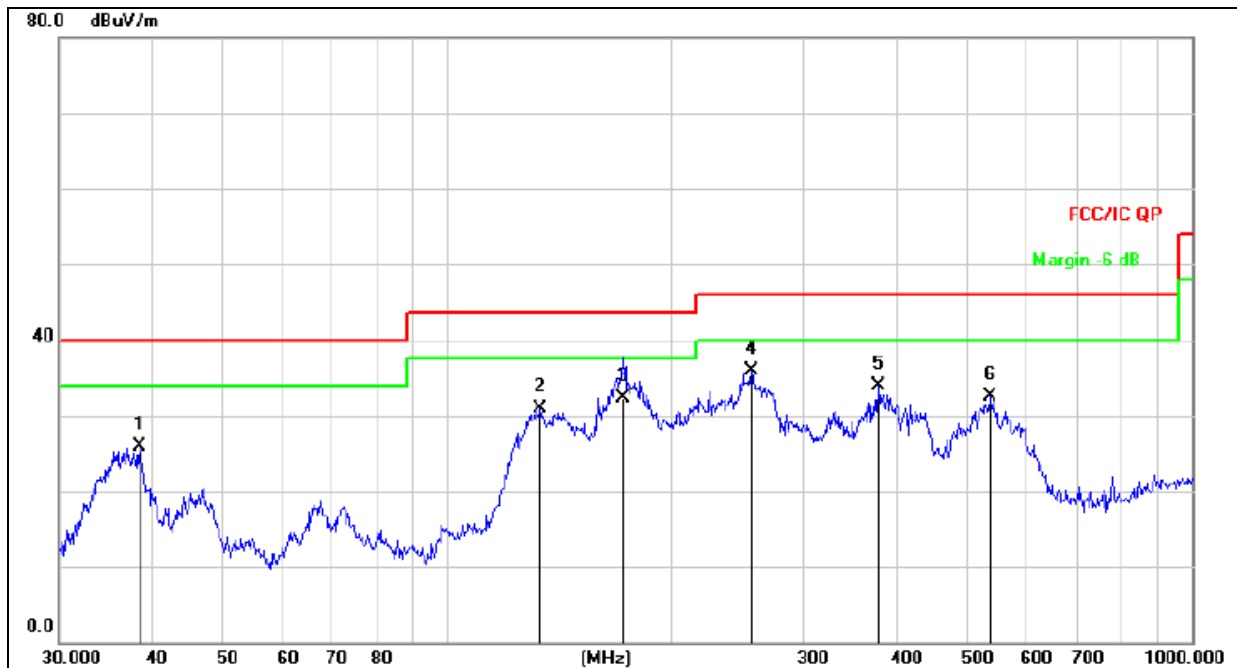

Remark:

Factor = Antenna Factor + Cable Loss – Pre-amplifier.

No.	Mk.	Freq.	Reading Level	Correct Factor	Measurement	Limit	Over	Detector
		MHz	dBuV	dB	dBuV/m	dB/m	dB	
1		38.4808	41.63	-15.72	25.91	40.00	-14.09	QP
2		133.1511	49.38	-18.42	30.96	43.50	-12.54	QP
3		172.0565	50.48	-18.09	32.39	43.50	-11.11	QP
4	*	255.6230	50.93	-14.98	35.95	46.00	-10.05	QP
5		378.5842	45.42	-11.58	33.84	46.00	-12.16	QP
6		535.7073	40.45	-8.04	32.41	46.00	-13.59	QP

7. EUT TEST PHOTOS

Conducted Measurement Photos

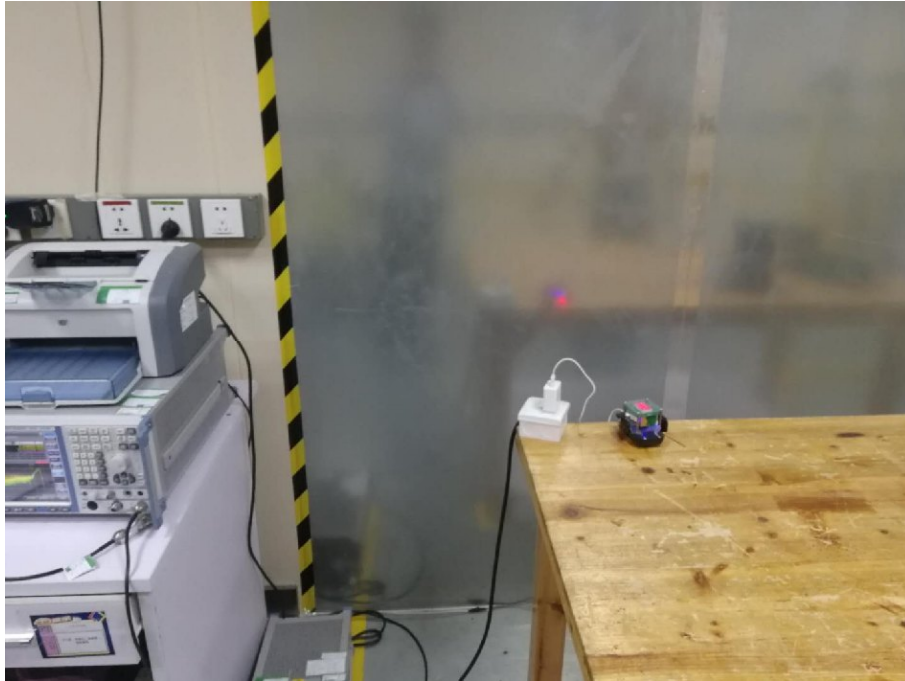

Radiated Measurement Photos
9KHz-30MHz

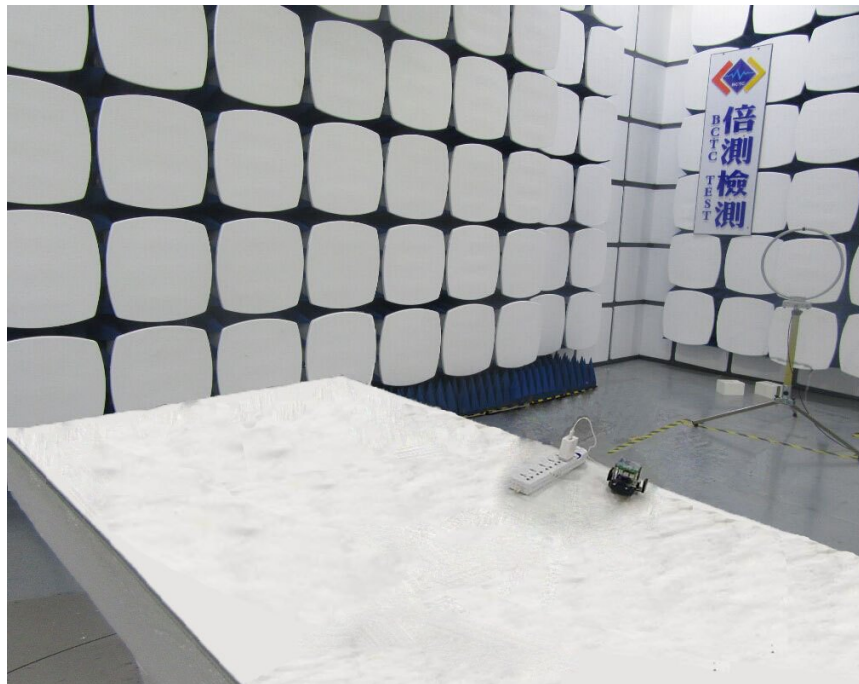

30MHz-1GHz

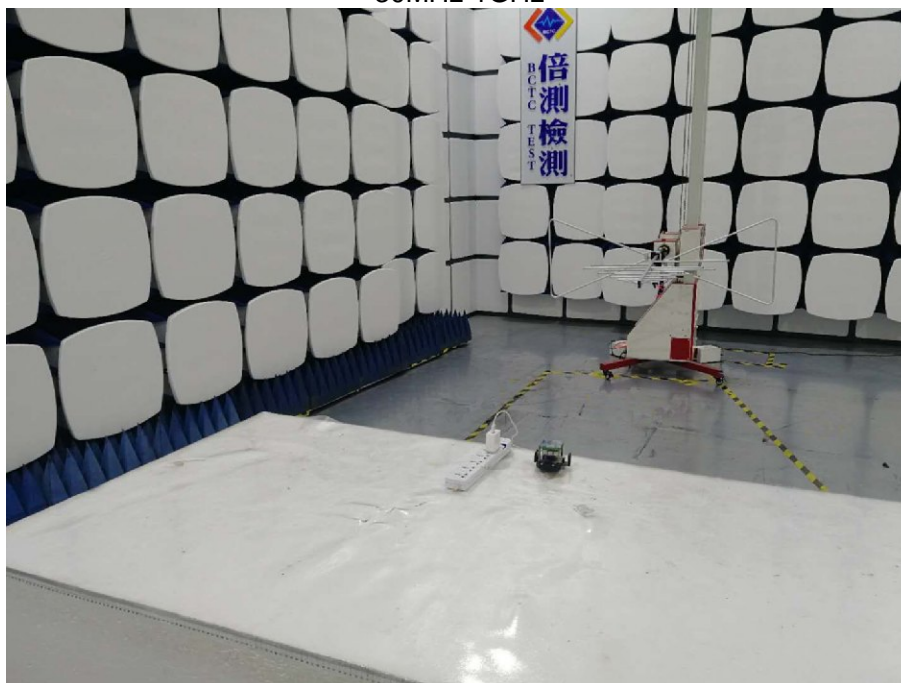

8. EUT PHOTOS



***** END OF REPORT *****