

FEELWORLD FT6 FR6

5.5" Wireless Monitor

HDMI/3D LUT/HDR

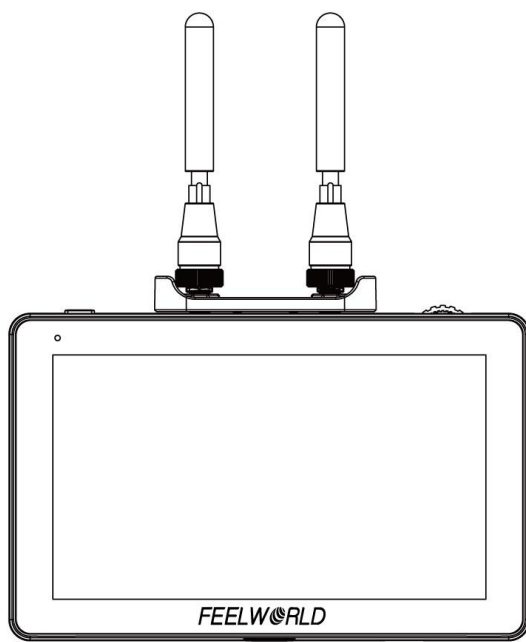

TX: FT6

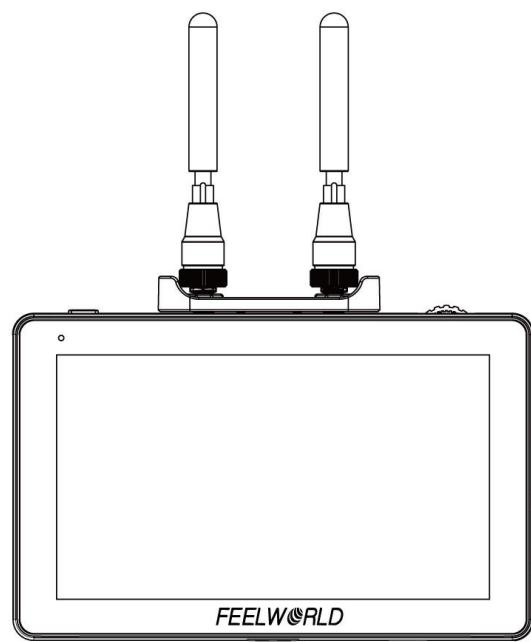

RX: FR6

User Manual

Product Overview

Thank you for purchasing our wireless video monitor. The product is a set of touch-screen monitors with a built-in wireless receiver and a built-in wireless transmitter, respectively. The highest resolution of wireless transmission is 1080P/60Hz, using 2*2dBi antenna technology and H.264 encoding and decoding technology for professional image processing, clearer image and lower delay.

Full HD color LCD monitor, which adopts advanced integrated digital signal processing circuits and professional IPS LED panel, which makes it high brightness, low power consumption, stable performance, etc. This monitor has HDMI input and output, auxiliary power output, touch screen menu operation, support user 3D LUT upload and HDR etc. It has small size, simple operation, portable convenience and wide application range. Advanced features include Parade, Vector, Histogram, Audio Meter, Focus Assist, False Color, Zebra Exposure, Pixel to Pixel, Center Marker, Safety Marker, Marker Mat, Monochrome, Image Freeze, Zoom, Anamorphic etc. The integration of image transmission and monitoring bringing you more professional and convenient enjoyment.

The monitor is equipped with dual battery plates; you can use the power adapter supply or use the external battery for power supply.



To insure the best use of the unit, please read the user's manual carefully

CAUTION

- This product should not be exposed dripping or splashing.
- Please place the wireless monitor on a flat with hard and stable surface.
- In order to reduce the risk of electric shock or fire, please do not expose the receiver/ transmitter to rain or moisture.
- Please avoid the heavy impact and drop onto the ground when move the product.
- The screen of this product is made of glass. Please do not drop the screen towards the ground. Keep away from injury if the screen is broken.
- Keep the product away from the heat source, and avoid the prolonged exposures to the sun as the LCD screen will be damaged.
- To avoid damaging the product, please do not take apart or repair the unit by yourself without the adjustable components in the unit.
- In order to better maintain the LCD screen and protect the cover, please follow the following ways to avoid damages.
 1. Please refrain from using the hard objects to hit the screen.
 2. Please do not force to wipe the screen.
 3. Please do not use the chemical solutions to clean the screen.
 4. Please do not spray any detergent on the screen.
 5. Please do not write on the screen directly.
 6. Please do not stick on the screen.
 7. Please simply wipe with a clean soft cloth and make sure no water on the screen.

Special Notice

- The impact of radio waves (such as the following environment may cause the abnormal audio and video (blocked image, noise...etc.).
 - 1) Transmit near the wall which is hard for the radio waves to get through.
 - 2) Quite close to the refrigerator, metal fitment and appliances, or net to the crowded situation.
- This product has been tested and manufactured to comply with national electrical safety rules, however, there will be noise caused by the interference with other machines in rare cases. If the interference is happened, please keep a certain distance away from other machines.
- The product is susceptible to interference from 5GHz wireless local area network or other wireless devices.
- Optimal range between transmitter and receiver is between 1 meter and 30 meters with in line of sight indoor.
- It will take 30-40 seconds to boot the system before wireless communication start, the media receiver can not be operated during this time.

Features

- Up to 250m/800ft transmission range (LOS)
- Ultra-low delay: 70ms
- Up to 1080P60Hz
- Support multiple channels selection
- Support frequency modulation on either the wireless monitor TX or RX.

- Both the transmitter (TX) and receiver (RX) support HDMI IN and HDMI OUT interface (same screen display).
- Support the opening and closing function of the wireless transmission module, which can be used as a monitor alone or as an integrated wireless monitor.
- 5.5 inches 1920x1080 full HD IPS screen, touch screen menu operation
- Support 3D LUT Log to REC.709 and user 3D LUT upload
- Support HDR monitoring
- All Waves display, Parada, Vector, Histogram, Focus assist, False color and other functions, help you accurately expose and focus
- DC 8V power out to power your DSLR camera or mirrorless camera
- External sunshade, sunlight readable

CONTENTS

1. Product Description	6
1.1 Button Instruction	7
1.2 Port Instruction (bottom)	7
1.3 Port Instruction (right)	8
1.4 Power Supply Way	9
1.5 Mount Points	9
1.6 Sunshade	10
2. Menu Operation Instruction	11
3. Menu Function Instruction	14
4. Technical Parameters	18
5. Trouble Shooting	20

1. Product Description

● Front Panel

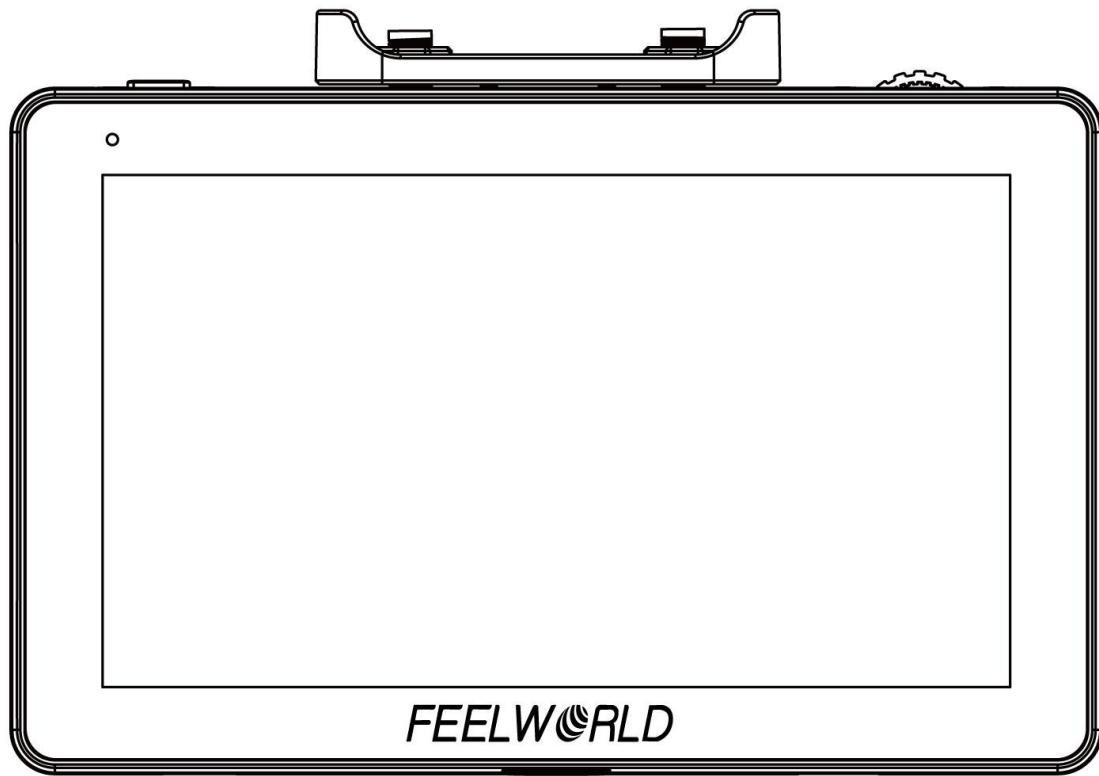

● Back Panel

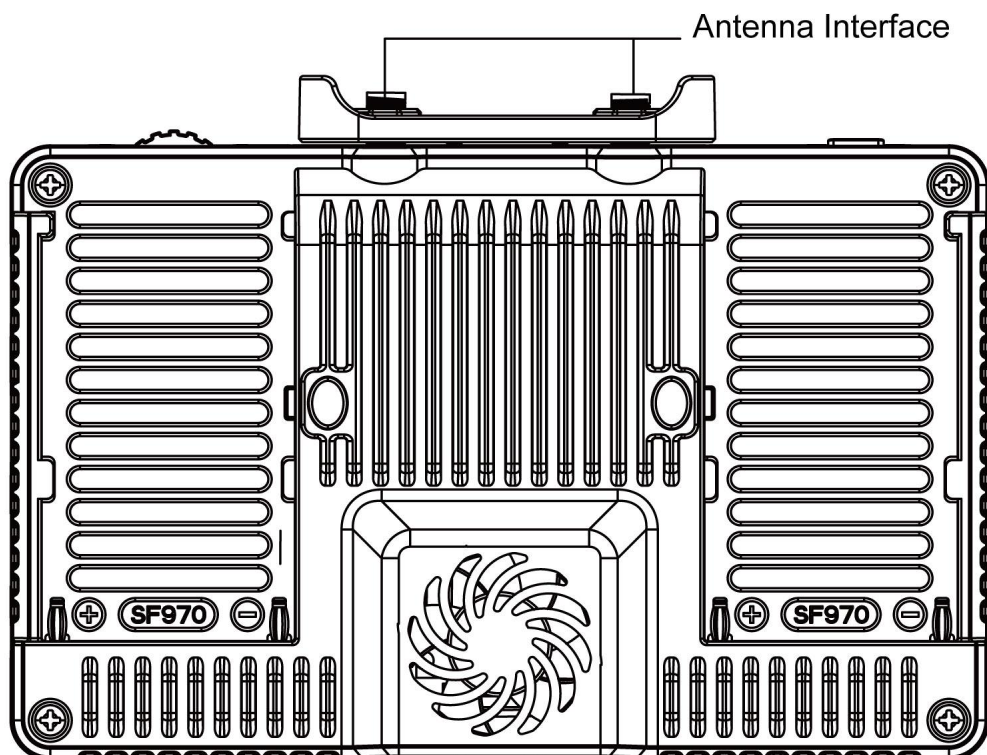

1.1 Button Instruction

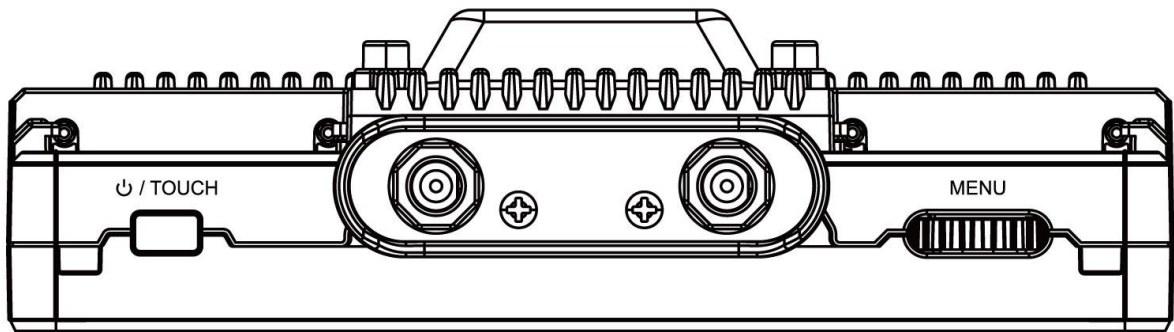

⏻ / TOUCH : Long press to turn on and off the power; short press to turn on and off the screen touch function

MENU: Long press to open the main menu and short press to open the shortcut menu. Rotate the wheel to select a menu item, press it again to open the corresponding menu function.

(See details: **2.Menu Operation Instruction**)

1.2 Port Instruction (Bottom)

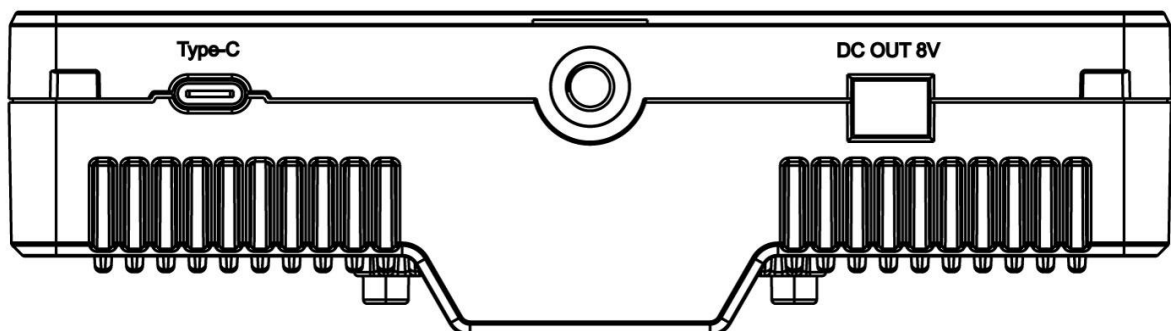

Type-C: For 3DLUT upload via type-c to USB and for firmware upgrade

DC OUT 8V: DC power output interface, polarity as the output power



Barrel output for powering your camera with a separately available DC coupler via adaptor (NP-FW50 Sony & LP-E6 Canon&DMW-BLF19 Panasonic). More adapters coming soon.

1.3 Port Instruction (Right)

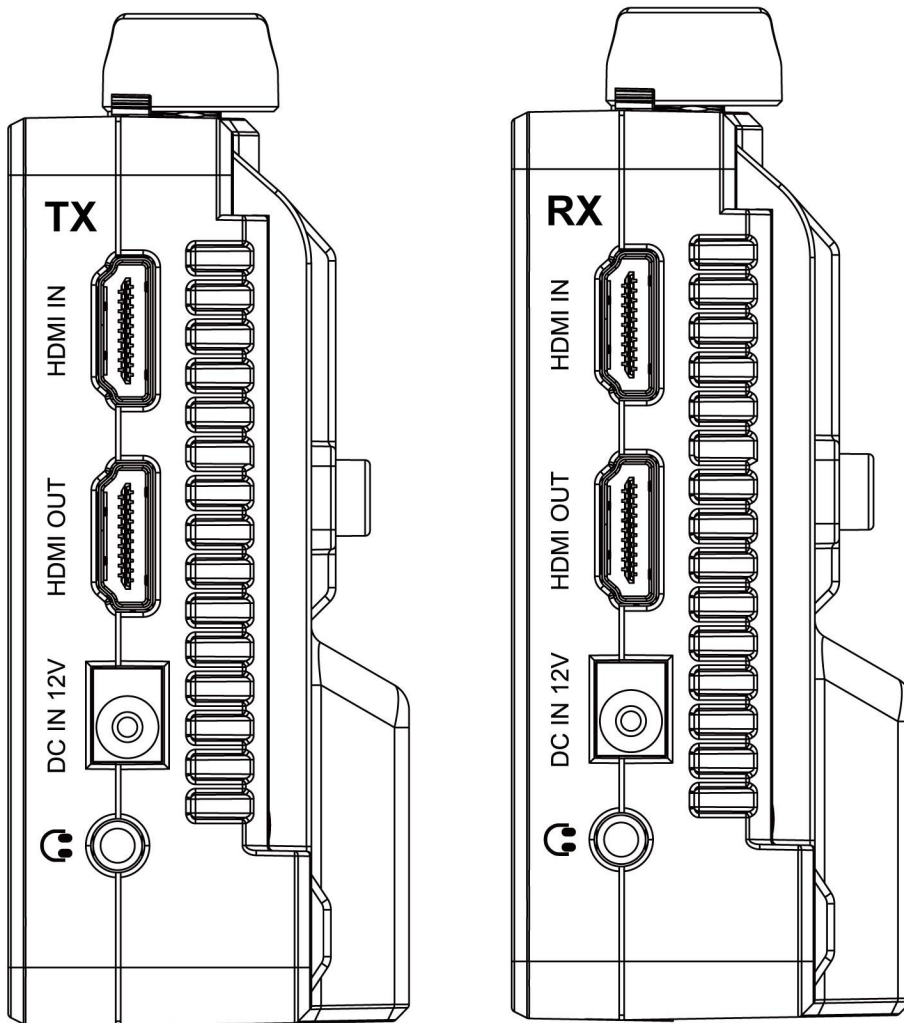

TX: Transmitter

RX: Receiver

HDMI IN: 1.4, HDMI signal input

HDMI OUT: 1.4, HDMI signal output

DC IN 12V: DC power input, polarity as the input power



: 3.5mm earphone port output

1.4 Power Supply Way

(1) The rear cover of the monitor is equipped with F970 dual battery plates, which is applicable to F970 series of batteries.

- **Sony F970 battery plate for battery of Sony DV:**

Sony F970 F960 F950 F930 F770 F750 F730 F570 F550 F530

QM91D QM91 QM90D QM90 QM71D QM71 QM70D QM70 QM51D

QM51 FM71 FM70 series

- **Battery switching instruction**

When the two battery plates are installed with batteries, the upper right corner of the monitor will display the battery level. White indicates the using battery, gray indicates non using battery. Double-click the battery icon, after about 3 seconds switch to another battery.

(2) Barrel (5.5mm outer, 2.1mm inner) at the bottom of the monitor, DC 7~24V Input.

Remark: Different specifications of the battery have different capability. The working time for the monitor will be different.

Higher capability (working time) will be longer. Please take off the battery from the monitor if you don't use the monitor in a long time.

1.5 Mount Point

There is a 1/4-20 thread point on bottom can be easily connected to the hot shoe mount, tripod fixed installation.

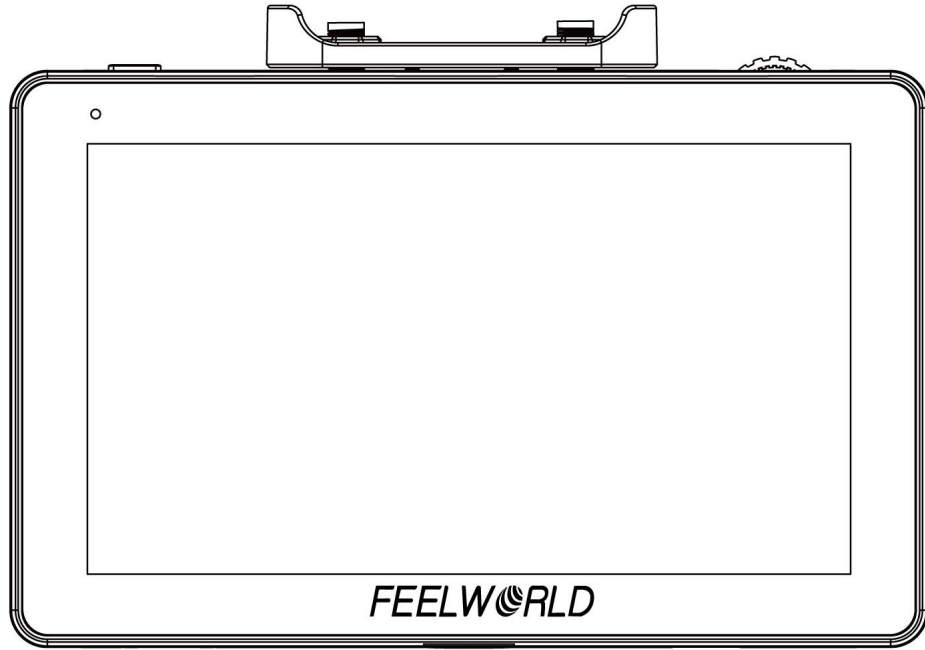

1/4-20 thread point

1.6 Sunshade



① Sunshade



② Sunshade Frame



③ Fixed Frame





④ Sunshade Application

First lock the Sunshade Frame ② with the monitor tight ③.

Open the sunshade ①, and match the sticker on the sunshade inside to the marked part of the sunshade frame ②, smooth and press 3 sides on the sunshade, and then complete the sunshade installation ④.

2. Menu Operation Instruction

After the monitor is properly connected to the power supply, the indicator light is on (red). Press  / TOUCH button to turn on the monitor power. The indicator light turns yellow. After inputting the HDMI signal, the indicator light turns from yellow to green.

After startup, short press  / TOUCH to select to turn the screen touch function on or off.

After the transmitter input the HDMI signal, the receiver will receive the signal from the transmitter, will display simultaneously for both monitors. Swipe the right side of the screen to display the transmission function including switch, signal, 4 channels and WPS pairing. Long press  until it turns red to close the wireless video transmission function.

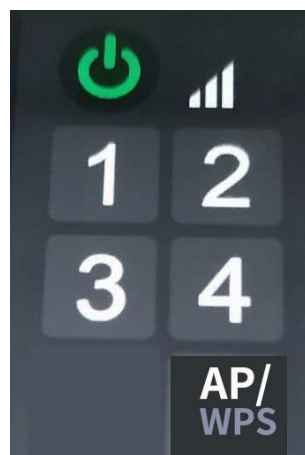

TX

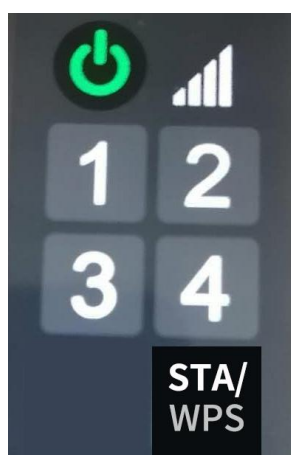

RX

(1). Directly touch the screen for menu operation (turn on the screen touch function)



- ①. Double-click on the screen to open the main menu (on the left side of the screen) and click on the corresponding menu to display the secondary menu. You can enter the corresponding function option to select or set with the "<" or ">" key of the option. Exit the menu and press  key of the main menu or click the touch screen.
- ②. Swipe up from the bottom of the screen to open the shortcut menu and click on the corresponding menu to open or set the corresponding function. Double-click the shortcut menu function and select the function setting with the "<" or ">" key.
- ③. On the left side of the screen (1/2 split screen), you can directly adjust the brightness of the screen backlight; on the right side of the screen (1/2 split screen), you can directly adjust the volume.
- ④. Swipe the right side (upper, lower, middle) of the screen to open the transmitting channel (TX), receiving channel (RX) and WPS pair. There are 4 channels for selection. Tap anywhere on the screen to exit the channel display

Figure:



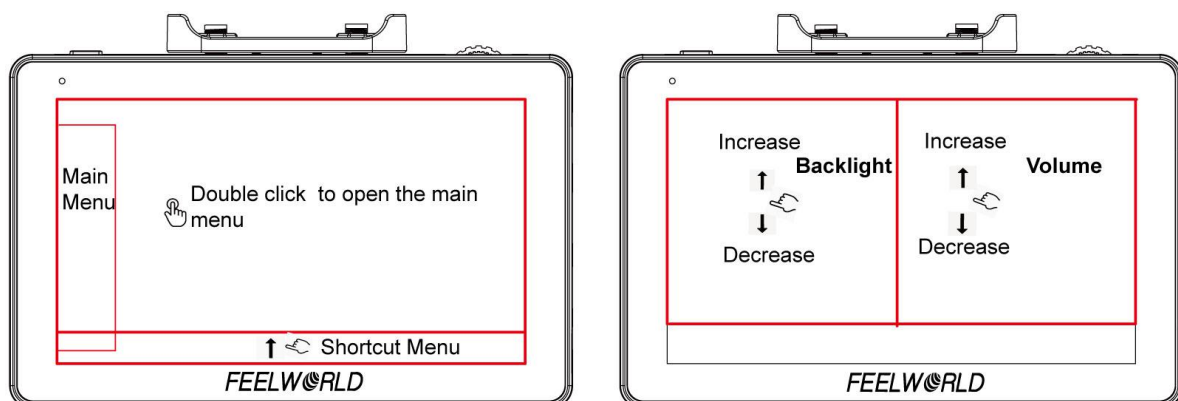
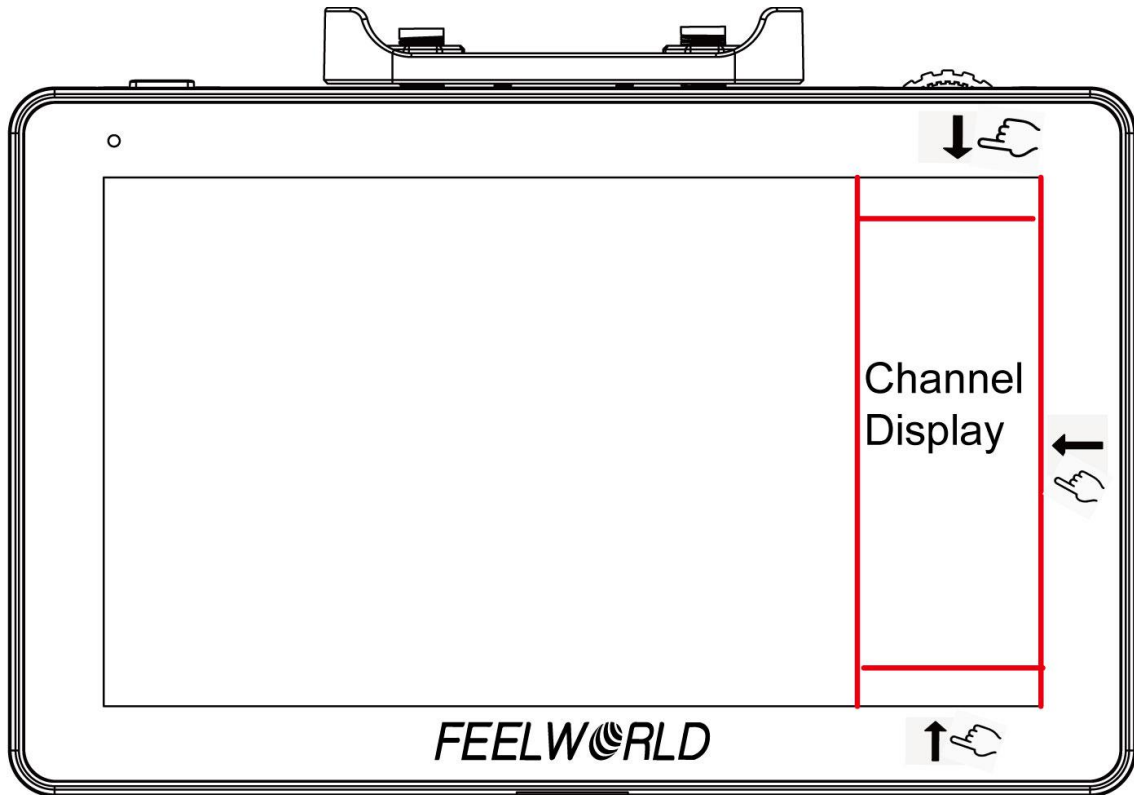

(2) Menu Operation of MENU Wheel

- ①. When the menu is not displayed, directly rotate the wheel to backlight or brightness adjustment. The wheel option can be set to backlight or brightness in the menu .
- ②. Long press the MENU wheel to open the main menu (on the left side of the screen). Rotate the wheel to select the secondary function menu. After selecting it, press the wheel, then rotate the wheel to select or set the option function.
- ③. Short press the MENU wheel to open the shortcut menu (below the screen), rotate the wheel to select the shortcut menu option, press the wheel to directly turn on/off the function, if you press the parameter selection, repeat the above operation. The shortcut

menu will automatically exit after about 5 seconds without operation.

3. Menu Function Instruction



All Waves	OFF, ON
Parada	OFF, RGB, YUV, Y
Vector	OFF, ON
Histogram	OFF, ON
Focus Assist	OFF, ON The focus level and focus color items are displayed after the focus assist is turned on.
Focus Level	1~10
Focus Color	yellow, red, green, blue, white
Audio Meter	OFF, ON
Zebra	OFF, ON The zebra value item is displayed only after the zebra is turned on.
Zebra Value	1%~100%
Monochrome	OFF, gray, red, green, blue
False Color	OFF, type 1, type2
Return ←	Please use the scroll wheel to return to the previous menu or click on the main menu directly



Nine Grid	OFF, ON
Safety Marker	OFF, 70%, 80%, 90%, 16:9, 16:10, 4:3, 5:4, 1.85:1, 2.35:1
Center Marker	OFF, ON
Marker Mat	OFF, 16:9, 16:10, 4:3, 1.85:1, 2.35:1 The Marker Mat Alpha item is displayed after the Marker Mat is turned on.
Marker Mat Alpha	0%, 25%, 50%, 75%
Marker Color	yellow, red, green, blue, white, black
Return ←	Please use the scroll wheel to return to the previous menu or click on the main menu directly



Scan Mode	Under Scan, Over Scan
Video Aspect	auto, 16:9, 16:10, 4:3, 5:4, 1.85:1, 2.35:1, stretch, user Under the user , you can customize the Video Width (100% ~ 200%), Video Height (100% ~ 200%)
Anamorphic Mode	OFF, 1.25x, 1.33x, 1.5x, 2.0x, 2.0x mag
Auto Mirror	OFF, ON
Flip H	OFF, ON
Flip V	OFF, ON
Zoom Times	OFF, 100% ~ 300%
Freeze	OFF, ON
Pixel to Pixel	OFF, ON

Return 	Please use the scroll wheel to return to the previous menu or click on the main menu directly
--	---



HDR	OFF, HLG 2020, HLG 709, HLG P3
Lut Switch	OFF, ON The Lut item is displayed after the Lut Switch is turned on.
Lut	SLOG2, SLOG3, LOGC, VLOG
Lut Import (Type-C)	After copying the 3D LUT file to the U disk and inserting it into the Type-C to USB connector, you can click the “<” or “>” key in the Lut Import(Type C) to import the 3D LUT file or rotate the wheel to import the 3D LUT file(up to 50 Luts).
Colortemp	5600K, 6500K, 9300K, user Under the “user” item, the red, green, and blue values of the image can be adjusted.
Backlight	1~100
Brightness	0~100
Contrast	0~100
Saturation	0~100
Hue	0~100
Sharpness	0~100
Return 	Please use the scroll wheel to return to the previous menu or click on the main menu directly



Wheel	Backlight, Volume After selecting the wheel option, you can click the “<” or “>” button in the wheel option, or rotate the wheel to select one of the shortcut keys to set it to the rotary wheel adjustment (when the menu is not displayed).
Language	中文, English, 日本語, Deutsch, Français, Italiano, Español, 한국, Русский
Transparency	OFF, low, middle, high
OSD Time	5s, 10s, 15s, 20s, 25s, always
Touch	OFF, ON Please short press the TOUCH button to turn on the touch function again after choosing turn off
Volume	0~100
Mute	OFF, ON
Reset	OFF, ON After selecting the reset option, you can click the “<” or “>” key in the reset option or rotate the wheel to restore the factory settings.
Firmware Update	After copying the update file to the U disk and inserting it into Type-C to USB connector, and then connect to the Type-C interface of the monitor, you can click the “<” or “>” key in the firmware update option or rotate the wheel to update.
Return 	Please use the scroll wheel to return to the previous menu or click on the main menu directly



	Exit the menu
---	---------------

4. Technical Parameters

Panel Size	5.5" touch screen
Resolution	1920 × 1080 pixels
Frequency	5.1~5.9(GHz)
Audio Format	PCM
System Latency	70ms
Video Compression Format	H.264
Transmission	250m/800ft (open environment)
Antenna Mode	2dBi x 2
Dot Pitch	0.0639 (H) × 0.0213 (W) mm
Pixel Density	400PPI
Aspect Ratio	16:9
Brightness	500cd/m ²
Contrast	1000:1
Viewing Angle	80°/80°(L/R) 80°/80°(U/D)
Backlight	LED
Adjustable Backlight	Yes
Input	HDMI V1.4
Output	HDMI V1.4, 3.5mm stereo headphone jack
Power In	DC IN 12V, Barrel (5.5mm outer, 2.1mm inner)

Power Out	DC OUT 8V, Barrel (5.5mm outer, 2.1mm inner; Power DSLR or mirrorless camera)
HDMI Input/ Output Support Format	Wireless Transmission Opening 480P,576I,576P,720P60/59.94/50,1080I50/59.94/60 1080p23.98/24/25/29.97/30/50/59.97/60 Wireless Transmission Closing 480P,576I,576P,720P60/59.94/50,1080I50/59.94/60 1080p23.98/24/25/29.97/30/50/59.97/60 4K UHD 3840×2160p (30/29.97/25/24/23.98Hz) DCI 4K 4096×2160p (24Hz)
Power Input Voltage	7~24V
Power Consumption	≦ 18W
Unit Size (mm)	148Lx103.5Hx41W (mm)
Unit Weight	370g (TX) , 370g (RX)
Mount Point	one ¼-20 thread point on bottom
Working Temperature	-20℃ ~55℃
Storage Temperature	-30℃ ~65℃

5. Trouble Shooting

5.1 Only black and white or monochrome image:

- ① please check saturation, brightness & contrast adjustment.
- ② Please check "Monochrome" is in black, white or monochrome image or other condition.

5.2 NO Image after power on

- ① Check if signal cable connecting is in good condition.
- ② Check signal cable connecting, and make sure to use the standard adapter to connect the monitor. If power is supplied by battery, please check if the battery is fully charged.

5.3 No sound

Please confirm whether the volume control is turned on, and adjust the volume.

- If there are still other problems, please contact with our related technologists.
- ★ As we are improving product features and product performance, so if there is any change on the specification without prior notice.

FCC Statement

This device complies with part 15 of the FCC rules. Operation is subject to the following two conditions: (1) this device may not cause harmful interference, and (2) this device must accept any interference received, including interference that may cause undesired operation.

Changes or modifications not expressly approved by the party responsible for compliance could void the user's authority to operate the equipment.

NOTE: This equipment has been tested and found to comply with the limits for a Class B digital device, pursuant to part 15 of the FCC Rules. These limits are designed to provide reasonable protection against harmful interference in a residential installation. This equipment generates uses and can radiate radio frequency energy and, if not installed and used in accordance with the instructions, may cause harmful interference to radio communications. However, there is no guarantee that interference will not occur in a particular installation. If this equipment does cause harmful interference to radio or television reception, which can be determined by turning the equipment off and on, the user is encouraged to try to correct the interference by one or more of the following measures:

- Reorient or relocate the receiving antenna.
- Increase the separation between the equipment and receiver.
- Connect the equipment into an outlet on a circuit different from that to which the receiver is connected.
- Consult the dealer or an experienced radio/TV technician for help.

Radiation Exposure Statement

To comply with FCC RF exposure compliance requirements, this grant is applicable to only mobile configurations. The antennas used for this transmitter must be installed to provide a separation distance of at least 20cm from all persons and must not be co-located or operating in conjunction with any other antenna or transmitter.