



**CFR 47 FCC PART 15 SUBPART C
ISED RSS-247 ISSUE 2**

CERTIFICATION TEST REPORT

For

Soundbar speaker With built-in subwoofer

MODEL NUMBER: PDB90/00

FCC ID: 2AR2SPDB90

IC: 24589-PDB90

REPORT NUMBER: 4790177870-4

ISSUE DATE: December 17, 2021

Prepared for

MMD HONG KONG HOLDING LIMITED

**Unit 1006, 10th Floor, C-Bons International Center, 108 Wai Yip Street, Kwun
Tong, Kowloon, Hong Kong**

Prepared by

UL Verification Services (Guangzhou) Co., Ltd, Song Shan Lake Branch

**Building 10, Innovation Technology Park, No. 1, Li Bin Road, Song Shan Lake Hi-
Tech Development Zone Dongguan, 523808, People's Republic of China**

Tel: +86 769 22038881

Fax: +86 769 33244054

Website: www.ul.com



Revision History

<u>Rev.</u>	<u>Issue Date</u>	<u>Revisions</u>	<u>Revised By</u>
V0	12/17/2021	Initial Issue	



Summary of Test Results			
Clause	Test Items	FCC/ISED Rules	Test Results
1	20dB Bandwidth and 99% Occupied Bandwidth	FCC 15.247 (a) (1) RSS-247 Clause 5.1 (a) RSS-Gen Clause 6.7	Pass
2	Conducted Output Power	FCC 15.247 (b) (1) RSS-247 Clause 5.1 (b)	Pass
3	Carrier Hopping Channel Separation	FCC 15.247 (a) (1) RSS-247 Clause 5.1 (b)	Pass
4	Number of Hopping Frequency	15.247 (a) (1) III RSS-247 Clause 5.1 (d)	Pass
5	Time of Occupancy (Dwell Time)	15.247 (a) (1) III RSS-247 Clause 5.1 (d)	Pass
6	Conducted Bandedge	FCC 15.247 (d) RSS-247 Clause 5.5	Pass
7	Radiated Bandedge and Spurious	FCC 15.247 (d) FCC 15.209 FCC 15.205 RSS-247 Clause 5.5 RSS-GEN Clause 8.9 RSS-GEN Clause 8.10	Pass
8	Conducted Emission Test for AC Power Port	FCC 15.207 RSS-GEN Clause 8.8	Pass
9	Antenna Requirement	FCC 15.203 RSS-GEN Clause 6.8	Pass
<p>Note:</p> <p>1. This test report is only published to and used by the applicant, and it is not for evidence purpose in China.</p> <p>2. The measurement result for the sample received is <Pass> according to < CFR 47 FCC PART 15 SUBPART C >< ISED RSS-247 > when <Accuracy Method> decision rule is applied.</p>			



TABLE OF CONTENTS

1. ATTESTATION OF TEST RESULTS	6
2. TEST METHODOLOGY	7
3. FACILITIES AND ACCREDITATION	7
4. CALIBRATION AND UNCERTAINTY	8
4.1. <i>MEASURING INSTRUMENT CALIBRATION</i>	<i>8</i>
4.2. <i>MEASUREMENT UNCERTAINTY.....</i>	<i>8</i>
5. EQUIPMENT UNDER TEST	9
5.1. <i>DESCRIPTION OF EUT</i>	<i>9</i>
5.2. <i>MAXIMUM PEAK OUTPUT POWER</i>	<i>9</i>
5.3. <i>PACKET TYPE CONFIGURATION</i>	<i>9</i>
5.4. <i>CHANNEL LIST.....</i>	<i>10</i>
5.5. <i>TEST CHANNEL CONFIGURATION.....</i>	<i>10</i>
5.6. <i>WORST-CASE CONFIGURATIONS.....</i>	<i>10</i>
5.7. <i>THE WORSE CASE POWER SETTING PARAMETER.....</i>	<i>11</i>
5.8. <i>DESCRIPTION OF AVAILABLE ANTENNAS</i>	<i>11</i>
5.9. <i>DESCRIPTION OF TEST SETUP.....</i>	<i>12</i>
6. MEASURING INSTRUMENT AND SOFTWARE USED	13
7. ANTENNA PORT TEST RESULTS	15
7.1. <i>ON TIME AND DUTY CYCLE.....</i>	<i>15</i>
7.2. <i>20 dB BANDWIDTH AND 99 % OCCUPIED BANDWIDTH</i>	<i>16</i>
7.3. <i>CONDUCTED OUTPUT POWER.....</i>	<i>18</i>
7.4. <i>CARRIER FREQUENCY SEPARATION.....</i>	<i>19</i>
7.5. <i>NUMBER OF HOPPING FREQUENCIES</i>	<i>21</i>
7.6. <i>TIME OF OCCUPANCY (DWELL TIME).....</i>	<i>23</i>
7.7. <i>CONDUCTED BANDEDGE AND SPURIOUS EMISSION.....</i>	<i>25</i>
8. RADIATED TEST RESULTS.....	27
8.1. <i>RESTRICTED BANDEDGE</i>	<i>33</i>
8.1.1. <i>GFSK MODE</i>	<i>33</i>
8.1.2. <i>8DPSK MODE</i>	<i>35</i>
8.2. <i>SPURIOUS EMISSIONS (1 GHz ~ 3 GHz).....</i>	<i>37</i>
8.2.1. <i>GFSK MODE</i>	<i>37</i>
8.3. <i>SPURIOUS EMISSIONS (3 GHz ~ 18 GHz).....</i>	<i>43</i>
8.3.1. <i>GFSK MODE</i>	<i>43</i>



8.3.2.	8DPSK MODE	49
8.4.	<i>SPURIOUS EMISSIONS (18 GHz ~ 26 GHz)</i>	55
8.4.1.	8DPSK MODE	55
8.5.	<i>SPURIOUS EMISSIONS (30 MHz ~ 1 GHz)</i>	57
8.5.1.	8DPSK MODE	57
8.6.	<i>SPURIOUS EMISSIONS BELOW 30 MHz</i>	59
8.6.1.	8DPSK MODE	59
9.	AC POWER LINE CONDUCTED EMISSIONS	62
9.1.	8DPSK MODE	63
10.	ANTENNA REQUIREMENTS	65
11.	Appendix	66
11.1.	<i>Appendix A: 20dB Emission Bandwidth</i>	66
11.1.1.	Test Result	66
11.1.2.	Test Graphs	67
11.2.	<i>Appendix B: Occupied Channel Bandwidth</i>	69
11.2.1.	Test Result	69
11.2.2.	Test Graphs	70
11.3.	<i>Appendix C: Maximum conducted output power</i>	72
11.3.1.	Test Result	72
11.4.	<i>Appendix D: Carrier frequency separation</i>	73
11.4.1.	Test Result	73
11.4.2.	Test Graphs	74
11.5.	<i>Appendix E: Time of occupancy</i>	75
11.5.1.	Test Result	75
11.5.2.	Test Graphs	76
11.6.	<i>Appendix F: Number of hopping channels</i>	78
11.6.1.	Test Result	78
11.6.2.	Test Graphs	79
11.7.	<i>Appendix G: Band edge measurements</i>	80
11.7.1.	Test Result	80
11.7.2.	Test Graphs	81
11.8.	<i>Appendix H: Conducted Spurious Emission</i>	84
11.8.1.	Test Result	84
11.8.2.	Test Graphs	85
11.9.	<i>Appendix I: Duty Cycle</i>	91
11.9.1.	Test Result	91
11.9.2.	Test Graphs	92



1. ATTESTATION OF TEST RESULTS

Applicant Information

Company Name: MMD HONG KONG HOLDING LIMITED
Address: Unit 1006, 10th Floor, C-Bons International Center, 108 Wai Yip Street, Kwun Tong, Kowloon, Hong Kong

Manufacturer Information

Company Name: MMD HONG KONG HOLDING LIMITED
Address: Unit 1006, 10th Floor, C-Bons International Center, 108 Wai Yip Street, Kwun Tong, Kowloon, Hong Kong

EUT Information

EUT Name: Soundbar speaker With built-in subwoofer
Model: PDB90/00
Brand: PORSCHE DESIGN
Sample Received Date: November 29, 2021
Sample Status: Normal
Sample ID: 4433050
Date of Tested: November 30, 2021~ December 13, 2021

APPLICABLE STANDARDS	
STANDARD	TEST RESULTS
CFR 47 FCC PART 15 SUBPART C	PASS
ISED RSS-247 Issue 2	PASS
ISED RSS-GEN Issue 5	PASS

Prepared By:

Mick Zhang
Project Engineer

Checked By:

Shawn Wen
Laboratory Leader

Approved By:

Stephen Guo
Laboratory Manager



2. TEST METHODOLOGY

The tests documented in this report were performed in accordance with KDB 558074 D01 15.247 Meas Guidance v05r02, 414788 D01 Radiated Test Site v01r01, CFR 47 FCC Part 2, CFR 47 FCC Part 15, ANSI C63.10-2013, ISED RSS-247 Issue 2 and ISED RSS-GEN Issue 5.

3. FACILITIES AND ACCREDITATION

Accreditation Certificate	<p>A2LA (Certificate No.: 4102.01) UL Verification Services (Guangzhou) Co., Ltd. Song Shan Lake Branch. has been assessed and proved to be in compliance with A2LA.</p> <p>FCC (FCC Designation No.: CN1187) UL Verification Services (Guangzhou) Co., Ltd. Song Shan Lake Branch. Has been recognized to perform compliance testing on equipment subject to the Commission's Declaration of Conformity (DoC) and Certification rules</p> <p>ISED (Company No.: 21320) UL Verification Services (Guangzhou) Co., Ltd. Song Shan Lake Branch. has been registered and fully described in a report filed with ISED. The Company Number is 21320 and the test lab Conformity Assessment Body Identifier (CABID) is CN0046.</p> <p>VCCI (Registration No.: G-20019, R-20004, C-20012 and T-20011) UL Verification Services (Guangzhou) Co., Ltd. Song Shan Lake Branch. has been assessed and proved to be in compliance with VCCI, the Membership No. is 3793. Facility Name: Chamber D, the VCCI registration No. is G-20019 and R-20004 Shielding Room B, the VCCI registration No. is C-20012 and T-20011</p>
---------------------------	--

Note 1: All tests measurement facilities use to collect the measurement data are located at Building 10, Innovation Technology Park, Song Shan Lake Hi tech Development Zone, Dongguan, 523808, China

Note 2: The test anechoic chamber in UL Verification Services (Guangzhou) Co., Ltd. Song Shan Lake Branch had been calibrated and compared to the open field sites and the test anechoic chamber is shown to be equivalent to or worst case from the open field site.

Note 3: For below 30 MHz, lab had performed measurements at test anechoic chamber and comparing to measurements obtained on an open field site. And these measurements below 30 MHz had been correlated to measurements performed on an OFS.



4. CALIBRATION AND UNCERTAINTY

4.1. MEASURING INSTRUMENT CALIBRATION

The measuring equipment utilized to perform the tests documented in this report has been calibrated in accordance with the manufacturer's recommendations and is traceable to recognized national standards.

4.2. MEASUREMENT UNCERTAINTY

Where relevant, the following measurement uncertainty levels have been estimated for tests performed on the apparatus:

Test Item	Uncertainty
Conduction emission	3.62 dB
Radiated Emission (Included Fundamental Emission) (9 kHz ~ 30 MHz)	2.2 dB
Radiated Emission (Included Fundamental Emission) (30 MHz ~ 1 GHz)	4.00 dB
Radiated Emission (Included Fundamental Emission) (1 GHz to 26 GHz)	5.78 dB (1 GHz ~ 18 GHz)
	5.23 dB (18 GHz ~ 26 GHz)
Note: This uncertainty represents an expanded uncertainty expressed at approximately the 95 % confidence level using a coverage factor of k=2.	



5. EQUIPMENT UNDER TEST

5.1. DESCRIPTION OF EUT

EUT Name	Soundbar speaker With built-in subwoofer			
Model	PDB90/00			
Product Description (Bluetooth)	Operation Frequency	2402 MHz ~ 2480 MHz		
	Modulation Type	Data Rate		
	GFSK	1Mbps		
	$\pi/4$ -DQPSK	2Mbps		
	8DPSK	3Mbps		
Supply Voltage	<input checked="" type="checkbox"/> AC mains State	input:100-240V~,50/60Hz , 30W		
	<input type="checkbox"/> DC State	<input type="checkbox"/> Internal Power Supply		
		<input type="checkbox"/> External Power Supply or AC/DC adapter	Rate Input:	
		<input type="checkbox"/> Battery	Rate Output:	

5.2. MAXIMUM PEAK OUTPUT POWER

Test Mode	Frequency (MHz)	Channel Number	Maximum Peak Output Power (dBm)	Maximum EIRP (dBm)
GFSK	2402 ~ 2480	0-78[79]	0.46	2.92
8DPSK	2402 ~ 2480	0-78[79]	1.11	3.57

5.3. PACKET TYPE CONFIGURATION

Test Mode	Packet Type	Setting (Packet Length)
GFSK	DH1	27
	DH3	183
	DH5	339
$\pi/4$ -DQPSK	2-DH1	54
	2-DH3	367
	2-DH5	679
8DPSK	3-DH1	83
	3-DH3	552
	3-DH5	1021

5.4. CHANNEL LIST

Channel	Frequency (MHz)	Channel	Frequency (MHz)	Channel	Frequency (MHz)	Channel	Frequency (MHz)
00	2402	20	2422	40	2442	60	2462
01	2403	21	2423	41	2443	61	2463
02	2404	22	2424	42	2444	62	2464
03	2405	23	2425	43	2445	63	2465
04	2406	24	2426	44	2446	64	2466
05	2407	25	2427	45	2447	65	2467
06	2408	26	2428	46	2448	66	2468
07	2409	27	2429	47	2449	67	2469
08	2410	28	2430	48	2450	68	2470
09	2411	29	2431	49	2451	69	2471
10	2412	30	2432	50	2452	70	2472
11	2413	31	2433	51	2453	71	2473
12	2414	32	2434	52	2454	72	2474
13	2415	33	2435	53	2455	73	2475
14	2416	34	2436	54	2456	74	2476
15	2417	35	2437	55	2457	75	2477
16	2418	36	2438	56	2458	76	2478
17	2419	37	2439	57	2459	77	2479
18	2420	38	2440	58	2460	78	2480
19	2421	39	2441	59	2461	/	/

5.5. TEST CHANNEL CONFIGURATION

Test Mode	Test Channel	Frequency
GFSK-DH5	CH 0(Low Channel), CH 39(MID Channel), CH 78(High Channel)	2402 MHz, 2441 MHz, 2480 MHz
8DPSK-3DH5	CH 0(Low Channel), CH 39(MID Channel), CH 78(High Channel)	2402 MHz, 2441 MHz, 2480 MHz
GFSK-DH5	Hopping	2402 MHz ~ 2480 MHz
8DPSK-3DH5	Hopping	2402 MHz ~ 2480 MHz

5.6. WORST-CASE CONFIGURATIONS

Bluetooth Mode	Modulation Technology	Modulation Type	Data Rate (Mbps)
BR	FHSS	GFSK	1Mbit/s
EDR	FHSS	8DPSK	3Mbit/s

Note: Pre-Scan has been conducted to determine the worst-case mode from all possible combinations between available modulations, data rates.

5.7. THE WORSE CASE POWER SETTING PARAMETER

The Worst Case Power Setting Parameter under 2400 ~ 2483.5MHz Band				
Test Software		BT FCC Tool		
Modulation Type	Transmit Antenna Number	Test Channel Power Setting		
		CH 00	CH 39	CH 78
GFSK	1	Default	Default	Default
8DPSK	1	Default	Default	Default

5.8. DESCRIPTION OF AVAILABLE ANTENNAS

Antenna	Frequency (MHz)	Antenna Type	MAX Antenna Gain (dBi)
1	2402-2480	FPC antenna	2.46

Test Mode	Transmit and Receive Mode	Description
GFSK	<input checked="" type="checkbox"/> 1TX, 1RX	BT Antenna can be used as transmitting/receiving antenna.
8DPSK	<input checked="" type="checkbox"/> 1TX, 1RX	BT Antenna can be used as transmitting/receiving antenna.

5.9. DESCRIPTION OF TEST SETUP

SUPPORT EQUIPMENT

Item	Equipment	Brand Name	Model Name	Remarks
1	Laptop	ThinkPad	X230i	/
2	USB TO UART	/	/	/

I/O CABLES

Cable No	Port	Connector Type	Cable Type	Cable Length(m)	Remarks
1	USB	/	/	1.0	/

ACCESSORIES

Item	Accessory	Brand Name	Model Name	Description
/	/	/	/	/

TEST SETUP

The EUT can work in engineering mode with a software through a Laptop.

SETUP DIAGRAM FOR TESTS

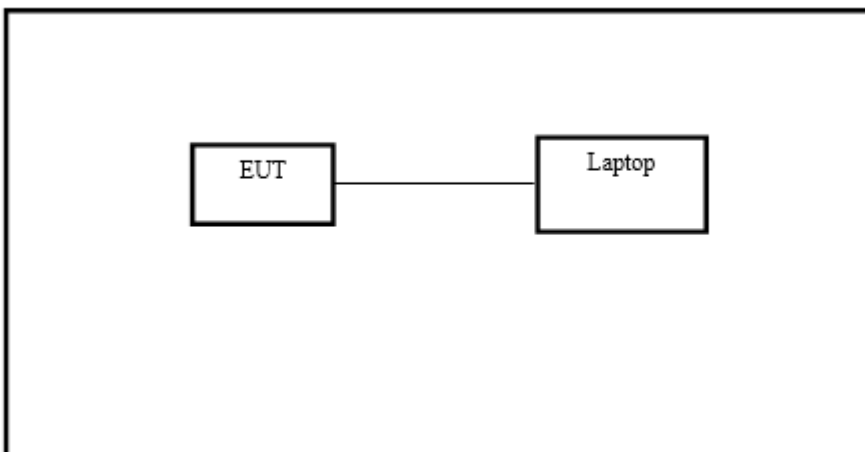

**6. MEASURING INSTRUMENT AND SOFTWARE USED**

Conducted Emissions					
Equipment	Manufacturer	Model No.	Serial No.	Last Cal.	Due Date
EMI Test Receiver	R&S	ESR3	101961	Oct.30, 2021	Oct.29, 2022
Two-Line V-Network	R&S	ENV216	101983	Oct.30, 2021	Oct.29, 2022
Artificial Mains Networks	Schwarzbeck	NSLK 8126	8126465	Oct.30, 2021	Oct.29, 2022
Software					
Description			Manufacturer	Name	Version
Test Software for Conducted Emissions			Farad	EZ-EMC	Ver. UL-3A1

Radiated Emissions					
Equipment	Manufacturer	Model No.	Serial No.	Last Cal.	Due Date
MXE EMI Receiver	KESIGHT	N9038A	MY56400036	Oct. 30, 2021	Oct. 29, 2022
Hybrid Log Periodic Antenna	TDK	HLP-3003C	130959	April 24, 2020	April 23, 2023
Preamplifier	HP	8447D	2944A09099	Oct. 30, 2021	Oct. 29, 2022
EMI Measurement Receiver	R&S	ESR26	101377	Oct. 30, 2021	Oct. 29, 2022
Horn Antenna	TDK	HRN-0118	130940	Jul. 20, 2021	Jul. 19, 2024
Preamplifier	TDK	PA-02-0118	TRS-305-00067	Oct. 31, 2021	Oct. 30, 2022
Horn Antenna	Schwarzbeck	BBHA9170	#697	July 20, 2021	July 19, 2024
Preamplifier	TDK	PA-02-2	TRS-307-00003	Oct.31, 2021	Oct.30, 2022
Preamplifier	TDK	PA-02-3	TRS-308-00002	Oct.31, 2021	Oct.30, 2022
Loop antenna	Schwarzbeck	1519B	00008	Jan.17, 2019	Jan.17,2022
Preamplifier	TDK	PA-02-001-3000	TRS-302-00050	Oct.31, 2021	Oct.30, 2022
Preamplifier	Mini-Circuits	ZX60-83LN-S+	SUP01201941	Oct.31, 2021	Oct.30, 2022
High Pass Filter	Wi	WHKX10-2700-3000-18000-40SS	23	Oct.31, 2021	Oct.30, 2022
Band Reject Filter	Wainwright	WRCJV8-2350-2400-2483.5-2533.5-40SS	4	Oct.31, 2021	Oct.30, 2022
Software					



Description	Manufacturer	Name	Version
Test Software for Radiated Emissions	Farad	EZ-EMC	Ver. UL-3A1

Tonsend RF Test System					
Equipment	Manufacturer	Model No.	Serial No.	Last Cal.	Due. Date
Wideband Radio Communication Tester	R&S	CMW500	155523	Oct.30, 2021	Oct.29, 2022
PXA Signal Analyzer	Keysight	N9030A	MY55410512	Oct.30, 2021	Oct.29, 2022
MXG Vector Signal Generator	Keysight	N5182B	MY56200284	Oct.30, 2021	Oct.29, 2022
MXG Vector Signal Generator	Keysight	N5172B	MY56200301	Oct.30, 2021	Oct.29, 2022
DC power supply	Keysight	E3642A	MY55159130	Oct.30, 2021	Oct.29, 2022
Software					
Description	Manufacturer	Name		Version	
Tonsend SRD Test System	Tonsend	JS1120-3 RF Test System		2.6.77.0518	

Other instruments					
Equipment	Manufacturer	Model No.	Serial No.	Last Cal.	Next Cal.
Spectrum Analyzer	Keysight	N9030A	MY55410512	Oct.30, 2021	Oct.29, 2022
Dual Channel Power Meter	Keysight	N1912A	MY55416024	Oct.30, 2021	Oct.29, 2022
Power Sensor	Keysight	USB Wideband Power Sensor	MY5100022	Oct.30, 2021	Oct.29, 2022

7. ANTENNA PORT TEST RESULTS

7.1. ON TIME AND DUTY CYCLE

LIMITS

None; for reporting purposes only.

PROCEDURE

Refer to ANSI C63.10-2013 Zero – Span Spectrum Analyzer method.

TEST SETUP

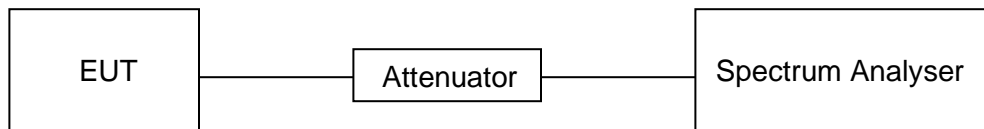

TEST ENVIRONMENT

Temperature	25.6 °C	Relative Humidity	47.1 %
Atmosphere Pressure	101 kPa	Test Voltage	AC 120V ,60Hz

RESULTS

Please refer to appendix I.

7.2. 20 dB BANDWIDTH AND 99 % OCCUPIED BANDWIDTH

LIMITS

CFR 47FCC Part15 (15.247) Subpart C ISED RSS-247 ISSUE 2			
Section	Test Item	Limit	Frequency Range (MHz)
CFR 47 FCC 15.247 (a) (1) RSS-247 Clause 5.1 (a)	20 dB Bandwidth	None; for reporting purposes only.	2400-2483.5
ISED RSS-Gen Clause 6.7	99 % Occupied Bandwidth	None; for reporting purposes only.	2400-2483.5

TEST PROCEDURE

Refer to ANSI C63.10-2013 clause 6.9.2.

Connect the EUT to the spectrum analyser and use the following settings:

Center Frequency	The center frequency of the channel under test
Detector	Peak
RBW	For 20 dB Bandwidth: 1 % to 5 % of the 20 dB bandwidth For 99 % Occupied Bandwidth: 1 % to 5 % of the occupied bandwidth
VBW	For 20 dB Bandwidth: approximately 3×RBW For 99 % Occupied Bandwidth: ≥ 3×RBW
Span	Approximately 2 to 3 times the 20dB bandwidth
Trace	Max hold
Sweep	Auto couple

a) Use the occupied bandwidth function of the instrument, allow the trace to stabilize and report the measured 99 % occupied bandwidth and 20 dB Bandwidth.

TEST SETUP

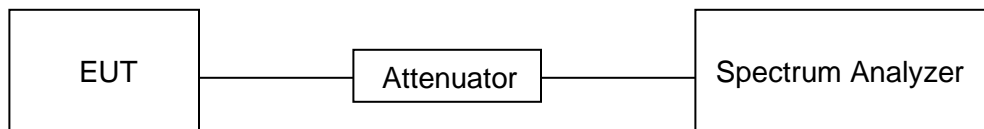



TEST ENVIRONMENT

Temperature	25.6 °C	Relative Humidity	47.1 %
Atmosphere Pressure	101 kPa	Test Voltage	AC 120V ,60Hz

RESULTS

Please refer to appendix A and B.

7.3. CONDUCTED OUTPUT POWER

LIMITS

CFR 47 FCC Part15 (15.247), Subpart C ISED RSS-247 ISSUE 2			
Section	Test Item	Limit	Frequency Range (MHz)
CFR 47 FCC 15.247 (b) (1) ISED RSS-247 Clause 5.4 (b)	Peak Conducted Output Power	Hopping channel carrier frequencies separated by a minimum of 25 kHz or the 20 dB bandwidth of the hopping channel: 1 watt or 30 dBm; Hopping channel carrier frequencies that are separated by 25 kHz or two-thirds of the 20 dB bandwidth of the hopping channel: 125 mW or 21 dBm	2400-2483.5

TEST PROCEDURE

Connect the EUT to a low loss RF cable from the antenna port to the power sensor (video bandwidth is greater than the occupied bandwidth).
Measure peak emission level, the indicated level is the peak output power, after any corrections for external attenuators and cables.

TEST SETUP

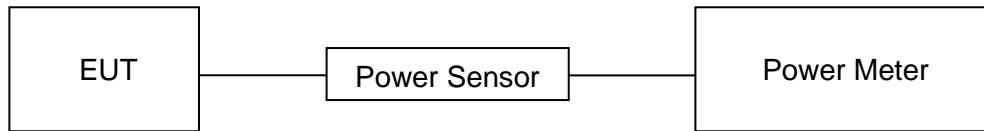

TEST ENVIRONMENT

Temperature	25.6 °C	Relative Humidity	47.1 %
Atmosphere Pressure	101 kPa	Test Voltage	AC 120V ,60Hz

RESULTS

Please refer to appendix C.

7.4. CARRIER FREQUENCY SEPARATION

LIMITS

CFR 47 FCC Part15 (15.247), Subpart C ISSED RSS-247 ISSUE 2			
Section	Test Item	Limit	Frequency Range (MHz)
CFR 47 FCC 15.247 (a) (1) ISED RSS-247 Clause 5.1 (b)	Carrier Frequency Separation	Frequency hopping systems shall have hopping channel carrier frequencies separated by a minimum of 25 kHz or the 20 dB bandwidth of the hopping channel, whichever is greater. Alternatively, frequency hopping systems operating in the 2400-2483.5 MHz band may have hopping channel carrier frequencies that are separated by 25 kHz or two-thirds of the 20 dB bandwidth of the hopping channel.	2400-2483.5

TEST PROCEDURE

Refer to ANSI C63.10-2013 clause 7.8.2.

Connect the EUT to the spectrum analyzer and use the following settings:

Center Frequency	The center frequency of the channel under test
Span	wide enough to capture the peaks of two adjacent channels
Detector	Peak
RBW	Start with the RBW set to approximately 30 % of the channel spacing; adjust as necessary to best identify the center of each individual channel.
VBW	≥RBW
Trace	Max hold
Sweep time	Auto couple

Allow the trace to stabilize and use the marker-delta function to determine the separation between the peaks of the adjacent channels.

Compliance of an EUT with the appropriate regulatory limit shall be determined.

TEST SETUP

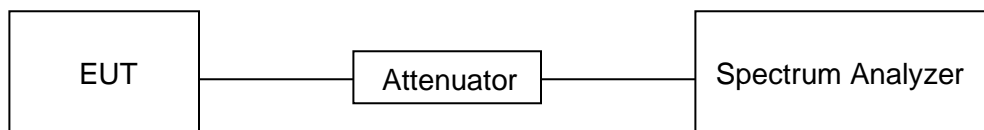



TEST ENVIRONMENT

Temperature	25.6 °C	Relative Humidity	47.1 %
Atmosphere Pressure	101 kPa	Test Voltage	AC 120V ,60Hz

RESULTS

Please refer to Appendix D.

7.5. NUMBER OF HOPPING FREQUENCIES

LIMITS

CFR 47 FCC Part15 (15.247), Subpart C ISED RSS-247 ISSUE 2		
Section	Test Item	Limit
CFR 47 15.247 (a) (1) III ISED RSS-247 Clause 5.1 (d)	Number of Hopping Frequency	at least 15 hopping channels

TEST PROCEDURE

Refer to ANSI C63.10-2013 clause 7.8.3.

Connect the EUT to the spectrum Analyzer and use the following settings:

Detector	Peak
RBW	To identify clearly the individual channels, set the RBW to less than 30% of the channel spacing or the 20 dB bandwidth, whichever is smaller.
VBW	\geq RBW
Span	The frequency band of operation. Depending on the number of channels the device supports, it may be necessary to divide the frequency range of operation across multiple spans, to allow the individual channels to be clearly seen.
Trace	Max hold
Sweep time	Auto couple

Set EUT to transmit maximum output power and switch on frequency hopping function. then set enough count time (larger than 5000 times) to get all the hopping frequency channel displayed on the screen of spectrum analyzer, count the quantity of peaks to get the number of hopping channels.

TEST SETUP

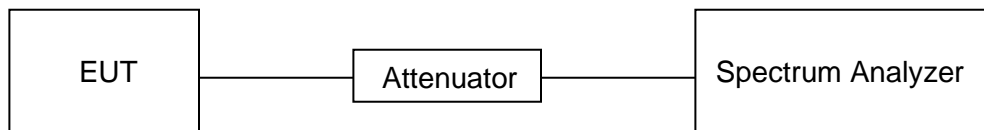



TEST ENVIRONMENT

Temperature	25.6 °C	Relative Humidity	47.1 %
Atmosphere Pressure	101 kPa	Test Voltage	AC 120V ,60Hz

RESULTS

Please refer to appendix F.



7.6. TIME OF OCCUPANCY (DWELL TIME)

LIMITS

CFR 47 FCC Part15 (15.247), Subpart C ISED RSS-247 ISSUE 2		
Section	Test Item	Limit
CFR 47 15.247 (a) (1) III ISED RSS-247 Clause 5.1 (d)	Time of Occupancy (Dwell Time)	The average time of occupancy on any channel shall not be greater than 0.4 seconds within a period of 0.4 seconds, multiplied by the number of hopping channels employed.

TEST PROCEDURE

Refer to ANSI C63.10-2013 clause 7.8.4.

Connect the EUT to the spectrum Analyzer and use the following settings:

Center Frequency	The center frequency of the channel under test
Detector	Peak
RBW	1 MHz
VBW	≥RBW
Span	Zero span, centered on a hopping channel
Trace	Max hold
Sweep time	As necessary to capture the entire dwell time per hopping channel; where possible use a video trigger and trigger delay so that the transmitted signal starts a little to the right of the start of the plot. The trigger level might need slight adjustment to prevent triggering when the system hops on an adjacent channel

Use the marker-delta function to determine the transmit time per hop (Burst Width). If this value varies with different modes of operation (data rate, modulation format, number of hopping channels, etc.), then repeat this test for each variation in transmit time.

For FHSS Mode (79 Channel):

DH1/3DH1 Dwell Time: $\text{Burst Width} * (1600/2) * 31.6 / (\text{channel number})$

DH3/3DH3 Dwell Time: $\text{Burst Width} * (1600/4) * 31.6 / (\text{channel number})$

DH5/3DH5 Dwell Time: $\text{Burst Width} * (1600/6) * 31.6 / (\text{channel number})$

For AFHSS Mode (20 Channel):

DH1/3DH1 Dwell Time: $\text{Burst Width} * (800/2) * 8 / (\text{channel number})$

DH3/3DH3 Dwell Time: $\text{Burst Width} * (800/4) * 8 / (\text{channel number})$

DH5/3DH5 Dwell Time: $\text{Burst Width} * (800/6) * 8 / (\text{channel number})$



TEST SETUP

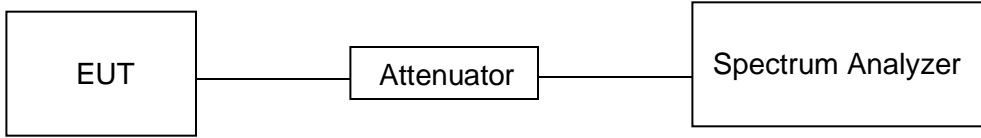

TEST ENVIRONMENT

Temperature	25.6 °C	Relative Humidity	47.1 %
Atmosphere Pressure	101 kPa	Test Voltage	AC 120V ,60Hz

RESULTS

Please refer to appendix E.



7.7. CONDUCTED BANDEdge AND SPURIOUS EMISSION

LIMITS

CFR 47 FCC Part15 (15.247), Subpart C ISED RSS-247 ISSUE 2		
Section	Test Item	Limit
CFR 47 FCC §15.247 (d) ISED RSS-247 5.5	Conducted Spurious Emission	at least 20 dB below that in the 100 kHz bandwidth within the band that contains the highest level of the desired power

TEST PROCEDURE

Refer to ANSI C63.10-2013 clause 7.8.6 and 7.8.8.

Connect the EUT to the spectrum analyser and use the following settings for reference level measurement:

Center Frequency	The center frequency of the channel under test
Detector	Peak
RBW	100 kHz
VBW	$\geq 3 \times \text{RBW}$
Span	1.5 x DTS bandwidth
Trace	Max hold
Sweep time	Auto couple.

Allow trace to fully stabilize and use the peak marker function to determine the maximum PSD level.

Change the settings for emission level measurement:

Span	Set the center frequency and span to encompass frequency range to be measured
Detector	Peak
RBW	100 kHz
VBW	$\geq 3 \times \text{RBW}$
measurement points	$\geq \text{span}/\text{RBW}$
Trace	Max hold
Sweep time	Auto couple.

Allow trace to fully stabilize and use the peak marker function to determine the maximum PSD level. Ensure that the amplitude of all unwanted emissions outside of the authorized frequency band (excluding restricted frequency bands) is attenuated by at least the minimum requirements.



TEST SETUP

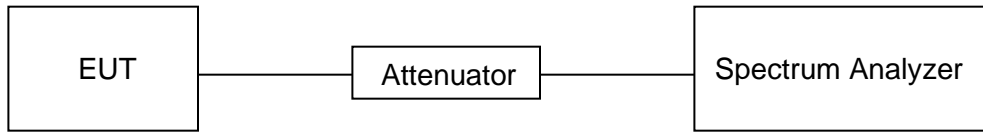

TEST ENVIRONMENT

Temperature	25.6 °C	Relative Humidity	47.1 %
Atmosphere Pressure	101 kPa	Test Voltage	AC 120V ,60Hz

RESULTS

Please refer to appendix G & H.



8. RADIATED TEST RESULTS

LIMITS

Please refer to CFR 47 FCC §15.205 and §15.209.

Please refer to ISED RSS-GEN Clause 8.9 and Clause 8.10.

Radiation Disturbance Test Limit for FCC (Class B) (9 kHz-1 GHz)

Emissions radiated outside of the specified frequency bands above 30 MHz		
Frequency Range (MHz)	Field Strength Limit (uV/m) at 3 m	Field Strength Limit (dBuV/m) at 3 m
		Quasi-Peak
30 - 88	100	40
88 - 216	150	43.5
216 - 960	200	46
Above 960	500	54
Above 1000	500	Peak
		Average
		74
		54

FCC Emissions radiated outside of the specified frequency bands below 30 MHz		
Frequency (MHz)	Field strength (microvolts/meter)	Measurement distance (meters)
0.009-0.490	2400/F(kHz)	300
0.490-1.705	24000/F(kHz)	30
1.705-30.0	30	30

ISED General field strength limits at frequencies below 30 MHz

Table 6 – General field strength limits at frequencies below 30 MHz		
Frequency	Magnetic field strength (H-Field) (µA/m)	Measurement distance (m)
9 - 490 kHz ^{Note 1}	6.37/F (F in kHz)	300
490 - 1705 kHz	63.7/F (F in kHz)	30
1.705 - 30 MHz	0.08	30

Note 1: The emission limits for the ranges 9-90 kHz and 110-490 kHz are based on measurements employing a linear average detector.



ISED Restricted bands please refer to ISED RSS-GEN Clause 8.10

Table 7 – Restricted frequency bands ^{Note 1}		
MHz	MHz	GHz
0.090 - 0.110	149.9 - 150.05	9.0 - 9.2
0.495 - 0.505	156.52475 - 156.52525	9.3 - 9.5
2.1735 - 2.1905	156.7 - 156.9	10.6 - 12.7
3.020 - 3.026	162.0125 - 167.17	13.25 - 13.4
4.125 - 4.128	167.72 - 173.2	14.47 - 14.5
4.17725 - 4.17775	240 - 285	15.35 - 16.2
4.20725 - 4.20775	322 - 335.4	17.7 - 21.4
5.677 - 5.683	399.9 - 410	22.01 - 23.12
6.215 - 6.218	608 - 614	23.6 - 24.0
6.26775 - 6.26825	960 - 1427	31.2 - 31.8
6.31175 - 6.31225	1435 - 1626.5	36.43 - 36.5
8.291 - 8.294	1645.5 - 1646.5	Above 38.6
8.362 - 8.366	1660 - 1710	
8.37625 - 8.38675	1718.8 - 1722.2	
8.41425 - 8.41475	2200 - 2300	
12.29 - 12.293	2310 - 2390	
12.51975 - 12.52025	2483.5 - 2500	
12.57675 - 12.57725	2655 - 2900	
13.36 - 13.41	3260 - 3267	
16.42 - 16.423	3332 - 3339	
16.69475 - 16.69525	3345.8 - 3358	
16.80425 - 16.80475	3500 - 4400	
25.5 - 25.67	4500 - 5150	
37.5 - 38.25	5350 - 5460	
73 - 74.6	7250 - 7750	
74.8 - 75.2	8025 - 8500	
108 - 138		

Note 1: Certain frequency bands listed in table 7 and in bands above 38.6 GHz are designated for licence-exempt applications. These frequency bands and the requirements that apply to related devices are set out in the 200 and 300 series of RSSs.

FCC Restricted bands of operation refer to FCC §15.205 (a):

MHz	MHz	MHz	GHz
0.090-0.110	16.42-16.423	399.9-410	4.5-5.15
¹ 0.495-0.505	16.69475-16.69525	608-614	5.35-5.46
2.1735-2.1905	16.80425-16.80475	960-1240	7.25-7.75
4.125-4.128	25.5-25.67	1300-1427	8.025-8.5
4.17725-4.17775	37.5-38.25	1435-1626.5	9.0-9.2
4.20725-4.20775	73-74.6	1645.5-1646.5	9.3-9.5
6.215-6.218	74.8-75.2	1660-1710	10.6-12.7
6.26775-6.26825	108-121.94	1718.8-1722.2	13.25-13.4
6.31175-6.31225	123-138	2200-2300	14.47-14.5
8.291-8.294	149.9-150.05	2310-2390	15.35-16.2
8.362-8.366	156.52475-156.52525	2483.5-2500	17.7-21.4
8.37625-8.38675	156.7-156.9	2690-2900	22.01-23.12
8.41425-8.41475	162.0125-167.17	3260-3267	23.6-24.0
12.29-12.293	167.72-173.2	3332-3339	31.2-31.8
12.51975-12.52025	240-285	3345.8-3358	36.43-36.5
12.57675-12.57725	322-335.4	3600-4400	(²)
13.36-13.41			

Note: ¹Until February 1, 1999, this restricted band shall be 0.490-0.510 MHz.

²Above 38.6c

TEST SETUP AND PROCEDURE

Below 30 MHz

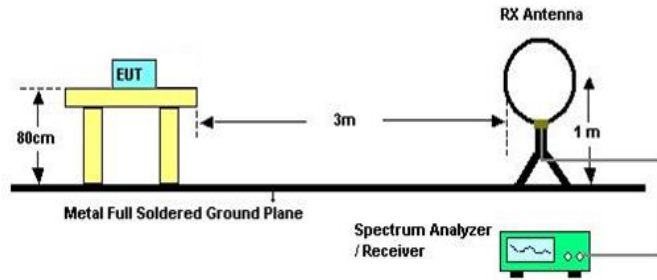

The setting of the spectrum analyser

RBW	200 Hz (From 9 kHz to 0.15 MHz)/ 9 kHz (From 0.15 MHz to 30 MHz)
VBW	200 Hz (From 9 kHz to 0.15 MHz)/ 9 kHz (From 0.15 MHz to 30 MHz)
Sweep	Auto

1. The testing follows the guidelines in ANSI C63.10-2013 clause 6.4.
2. The EUT was arranged to its worst case and then turntable (from 0 degree to 360 degrees) to find the maximum reading. A pre-amp and a high pass filter are used for the test in order to get better signal level. Both Horizontal, Face-on and Face-off polarizations of the antenna are set to make the measurement.
3. The EUT was placed on a turntable with 80 cm above ground.
4. The EUT was set 3 meters from the interference receiving antenna, which was mounted on the top of a 1 m height antenna tower.
5. The radiated emission limits are based on measurements employing a CISPR quasi-peak detector except for the frequency bands 9-90 kHz, 110-490 kHz and above 1000 MHz Radiated emission limits in these three bands are based on measurements employing an average detector.
6. For measurement below 1 GHz, the initial step in collecting conducted emission data is a spectrum analyzer peak detector mode pre-scanning the measurement frequency range. Significant peaks are then marked and then Quasi Peak and average detector mode re-measured. If the emission level of the EUT measured by the peak detector is 3 dB lower than the applicable limit, the peak emission level will be reported. Otherwise, the emission measurement will be repeated using the quasi-peak and average detector and reported.
7. Although these tests were performed other than open field site, adequate comparison measurements were confirmed against 30m open field site. Therefore sufficient tests were made to demonstrate that the alternative site produces results that correlate with the ones of tests made in an open field site based on KDB 414788.
8. The limits in CFR 47, Part 15, Subpart C, paragraph 15.209 (a), are identical to those in RSS-GEN Section 8.9, Table 6, since the measurements are performed in terms of magnetic field strength and converted to electric field strength levels (as reported in the table) using the free space impedance of 377Ω. For example, the measurement frequency X KHz resulted in a level of Y dBuV/m, which is equivalent to $Y-51.5 = Z$ dBuA/m, which has the same margin, W dB, to the corresponding RSS-GEN Table 6 limit as it has to be 15.209(a) limit.

Below 1 GHz and above 30 MHz

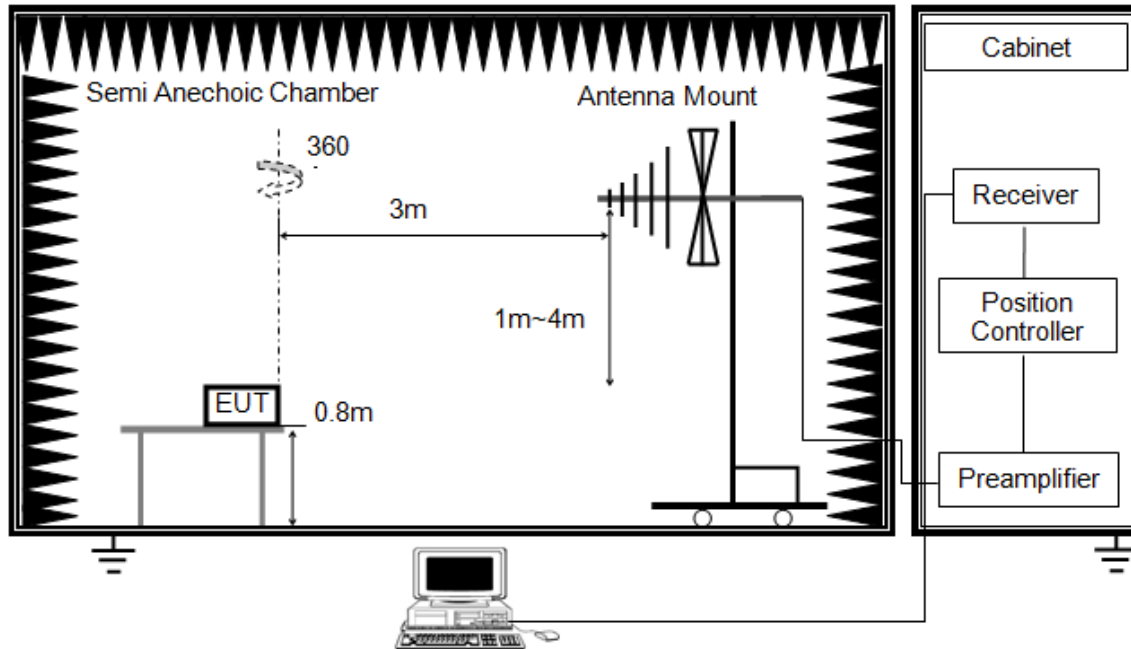

The setting of the spectrum analyser

RBW	120 kHz
VBW	300 kHz
Sweep	Auto
Detector	Peak/QP
Trace	Max hold

1. The testing follows the guidelines in ANSI C63.10-2013 clause 6.5.
2. The EUT was arranged to its worst case and then tune the antenna tower (from 1 m to 4 m) and turntable (from 0 degree to 360 degrees) to find the maximum reading. A pre-amp and a high pass filter are used for the test in order to get better signal level. Both horizontal and vertical polarizations of the antenna are set to make the measurement.
3. The EUT was placed on a turntable with 80 cm above ground.
4. The EUT was set 3 meters from the interference receiving antenna, which was mounted on the top of a variable height antenna tower.
5. For measurement below 1 GHz, the initial step in collecting conducted emission data is a spectrum analyzer peak detector mode pre-scanning the measurement frequency range. Significant peaks are then marked and then Quasi Peak detector mode re-measured. If the emission level of the EUT measured by the peak detector is 3 dB lower than the applicable limit, the peak emission level will be reported. Otherwise, the emission measurement will be repeated using the quasi-peak detector and reported.

Above 1 GHz

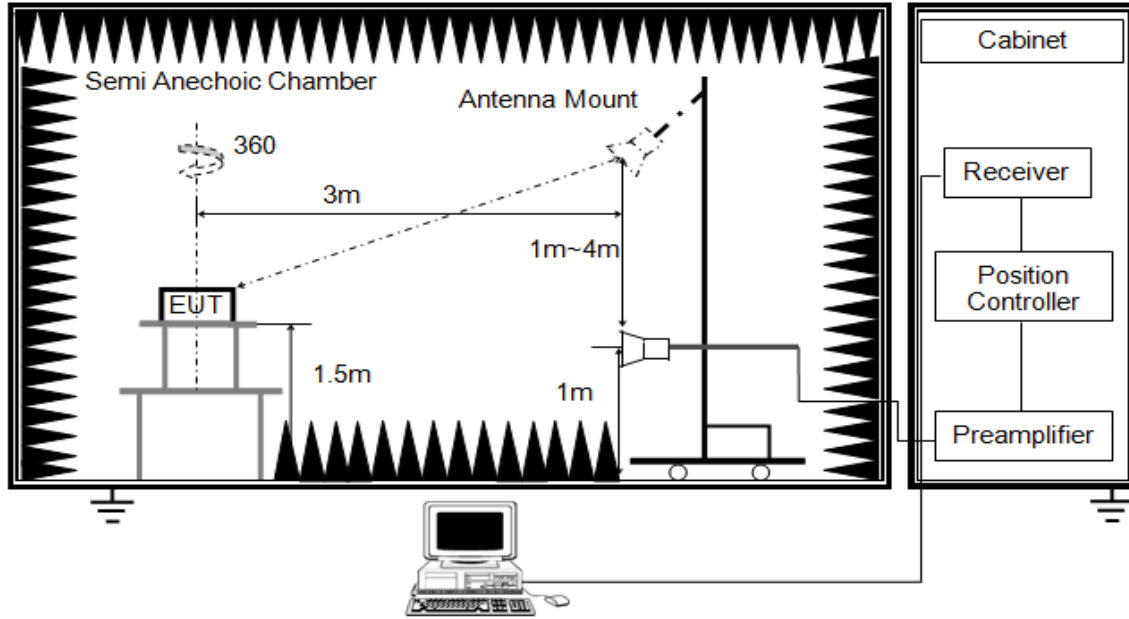

The setting of the spectrum analyser

RBW	1 MHz
VBW	PEAK: 3 MHz AVG: see note 6
Sweep	Auto
Detector	Peak
Trace	Max hold

1. The testing follows the guidelines in ANSI C63.10-2013 clause 6.6.
2. The EUT was arranged to its worst case and then tune the antenna tower (from 1 m to 4 m) and turntable (from 0 degree to 360 degrees) to find the maximum reading. A pre-amp and a high pass filter are used for the test in order to get better signal level. Both horizontal and vertical polarizations of the antenna are set to make the measurement.
3. The EUT was placed on a turntable with 1.5 m above ground.
4. The EUT was set 3 meters from the interference receiving antenna, which was mounted on the top of a variable height antenna tower.
5. For measurement above 1 GHz, the emission measurement will be measured by the peak detector. This peak level, once corrected, must comply with the limit specified in Section 15.209.
6. For measurements above 1 GHz the resolution bandwidth is set to 1 MHz, then the video bandwidth is set to 3 MHz for peak measurements and 1 MHz resolution bandwidth with 1/T video bandwidth with peak detector for average measurements. For the Duty Cycle please refer to clause 7.1.ON TIME AND DUTY CYCLE.

X axis, Y axis, Z axis positions:

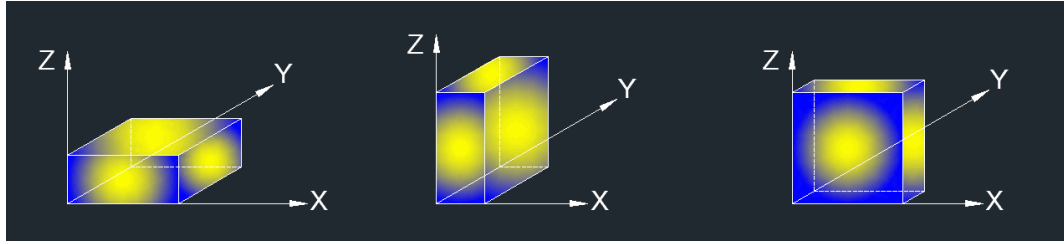

Note 1: For all radiated test, EUT in each of three orthogonal axis emissions had been tested, but only the worst case (X axis) data recorded in the report.

Note 2: Simultaneous transmission had been evaluated with the 5 GHz WLAN / 2.4 GHz WLAN and BT / BLE transmitter and has no additional or worse emissions found.

TEST ENVIRONMENT

Temperature	22.5 °C	Relative Humidity	48 %
Atmosphere Pressure	101 kPa	Test Voltage	AC 120V ,60Hz

RESULTS

8.1. RESTRICTED BANDEDGE

8.1.1. GFSK MODE

RESTRICTED BANDEDGE (LOW CHANNEL, VERTICAL)

PEAK

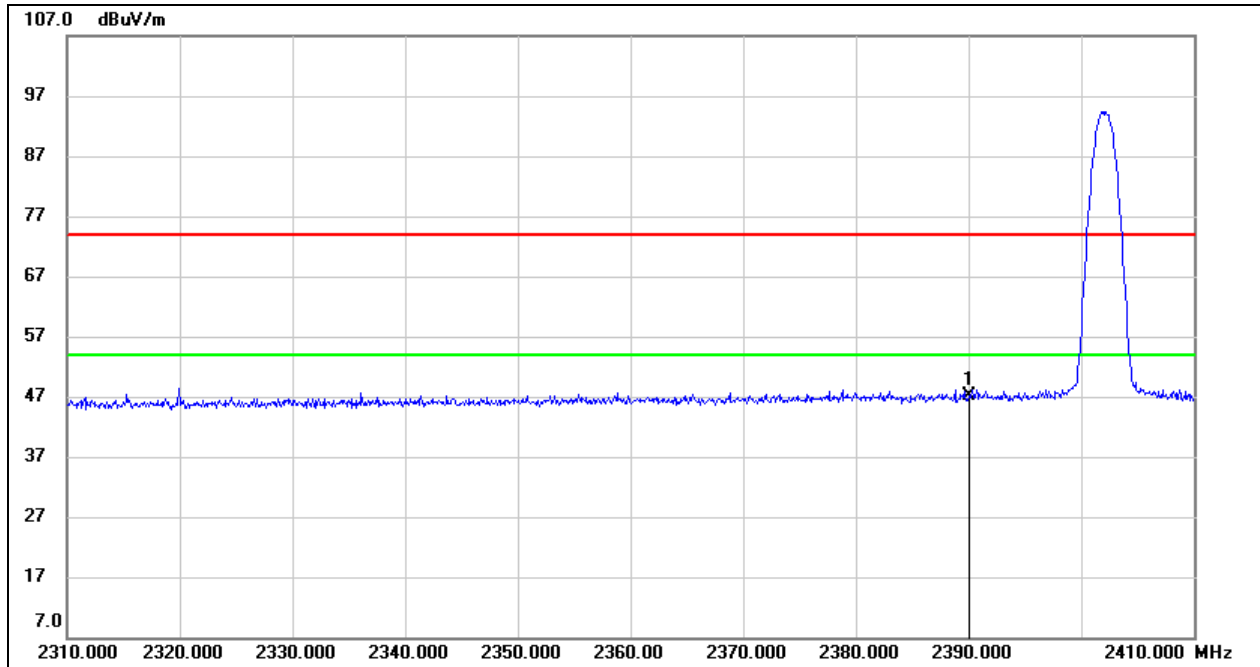

No.	Frequency (MHz)	Reading (dBuV)	Correct (dB/m)	Result (dBuV/m)	Limit (dBuV/m)	Margin (dB)	Remark
1	2390.000	14.38	32.66	47.04	74.00	-26.96	peak

- Note:
1. Measurement = Reading Level + Correct Factor.
 2. If Peak Result complies with AV limit, AV Result is deemed to comply with AV limit.
 3. Peak: Peak detector.
 4. Only the worst data was recorded, if it complies with the limit, the other emissions deemed to comply with the limit.



RESTRICTED BANDEDGE (HIGH CHANNEL, VERTICAL)

PEAK

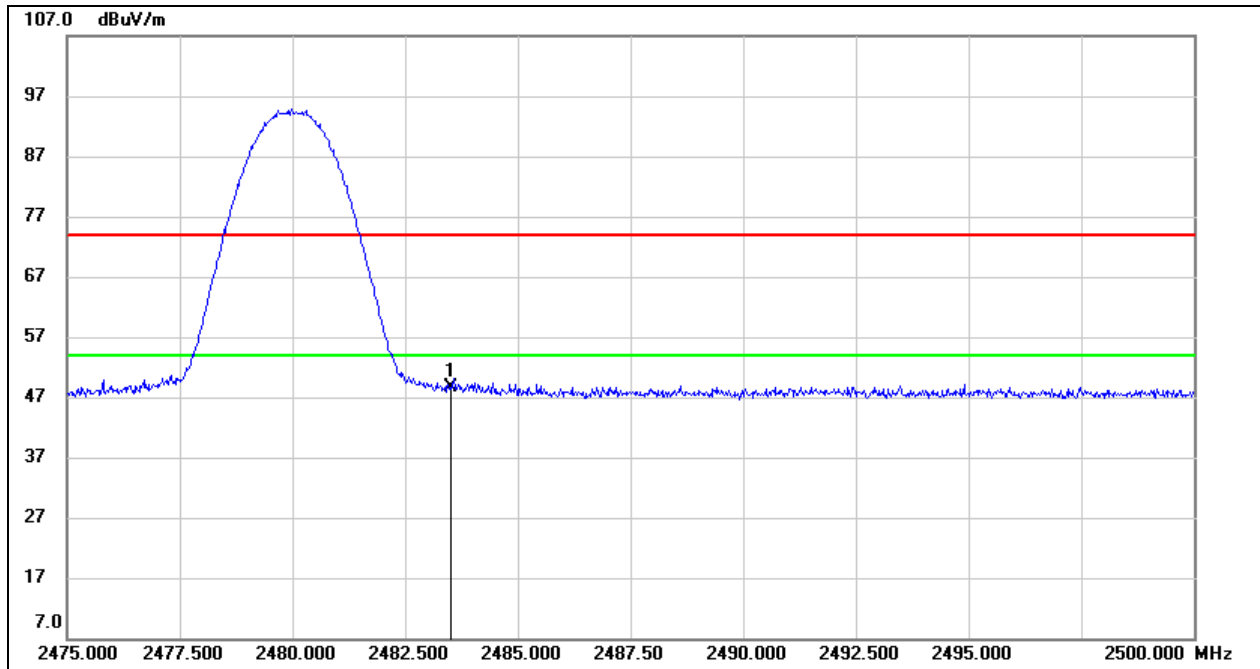

No.	Frequency (MHz)	Reading (dBuV)	Correct (dB/m)	Result (dBuV/m)	Limit (dBuV/m)	Margin (dB)	Remark
1	2483.500	15.46	33.10	48.56	74.00	-25.44	peak

- Note:
1. Measurement = Reading Level + Correct Factor.
 2. If Peak Result complies with AV limit, AV Result is deemed to comply with AV limit.
 3. Peak: Peak detector.
 4. Only the worst data was recorded, if it complies with the limit, the other emissions deemed to comply with the limit.

Note: All the polarities (Vertical & Horizontal) had been tested, only the worst data was recorded in the report.

8.1.2. 8DPSK MODE

RESTRICTED BANDEDGE (LOW CHANNEL, VERTICAL)

PEAK

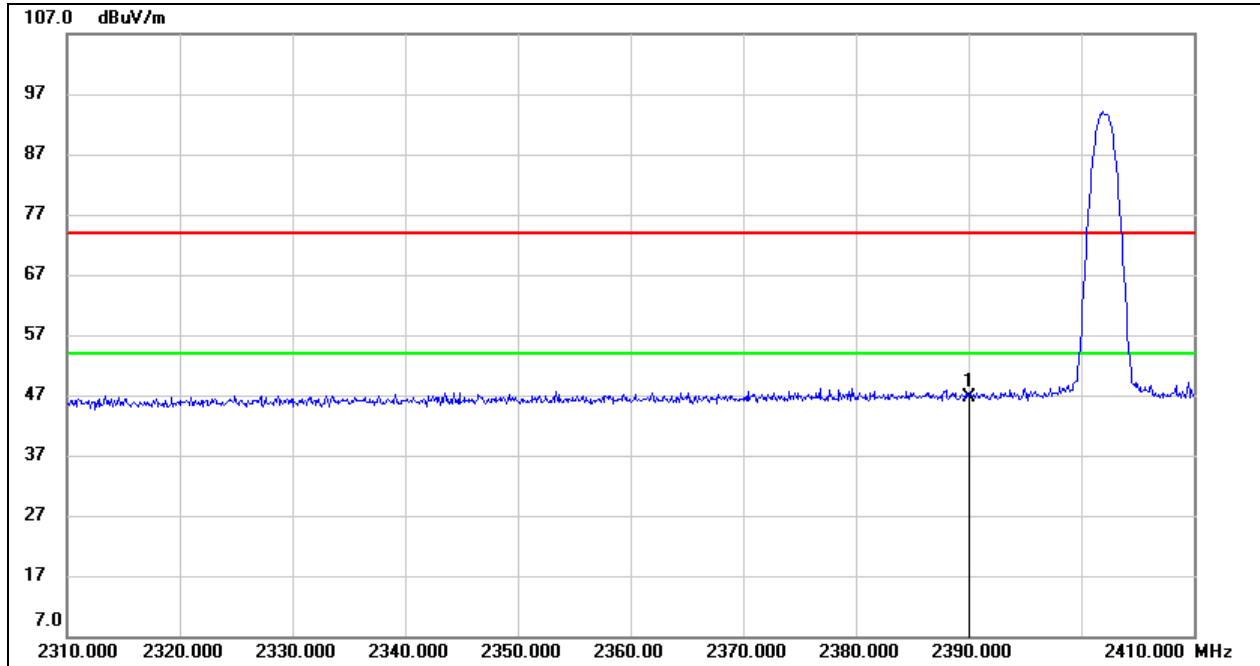

No.	Frequency (MHz)	Reading (dBuV)	Correct (dB/m)	Result (dBuV/m)	Limit (dBuV/m)	Margin (dB)	Remark
1	2390.000	14.05	32.66	46.71	74.00	-27.29	peak

- Note:
1. Measurement = Reading Level + Correct Factor.
 2. If Peak Result complies with AV limit, AV Result is deemed to comply with AV limit.
 3. Peak: Peak detector.
 4. Only the worst data was recorded, if it complies with the limit, the other emissions deemed to comply with the limit.

RESTRICTED BANDEDGE (HIGH CHANNEL, VERTICAL)

PEAK

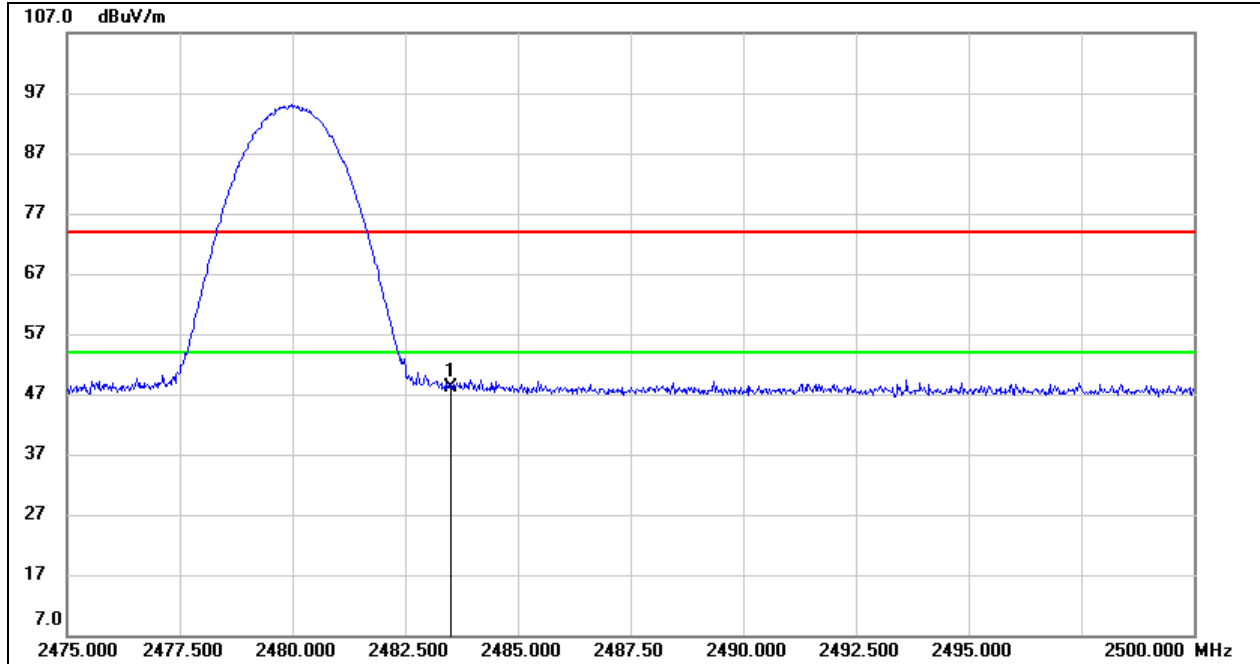

No.	Frequency (MHz)	Reading (dBuV)	Correct (dB/m)	Result (dBuV/m)	Limit (dBuV/m)	Margin (dB)	Remark
1	2483.500	15.00	33.10	48.10	74.00	-25.90	peak

- Note:
1. Measurement = Reading Level + Correct Factor.
 2. If Peak Result complies with AV limit, AV Result is deemed to comply with AV limit.
 3. Peak: Peak detector.
 4. Only the worst data was recorded, if it complies with the limit, the other emissions deemed to comply with the limit.

Note: All the polarities (Vertical & Horizontal) had been tested, only the worst data was recorded in the report.

8.2. SPURIOUS EMISSIONS (1 GHz ~ 3 GHz)

8.2.1. GFSK MODE

HARMONICS AND SPURIOUS EMISSIONS (LOW CHANNEL, HORIZONTAL)

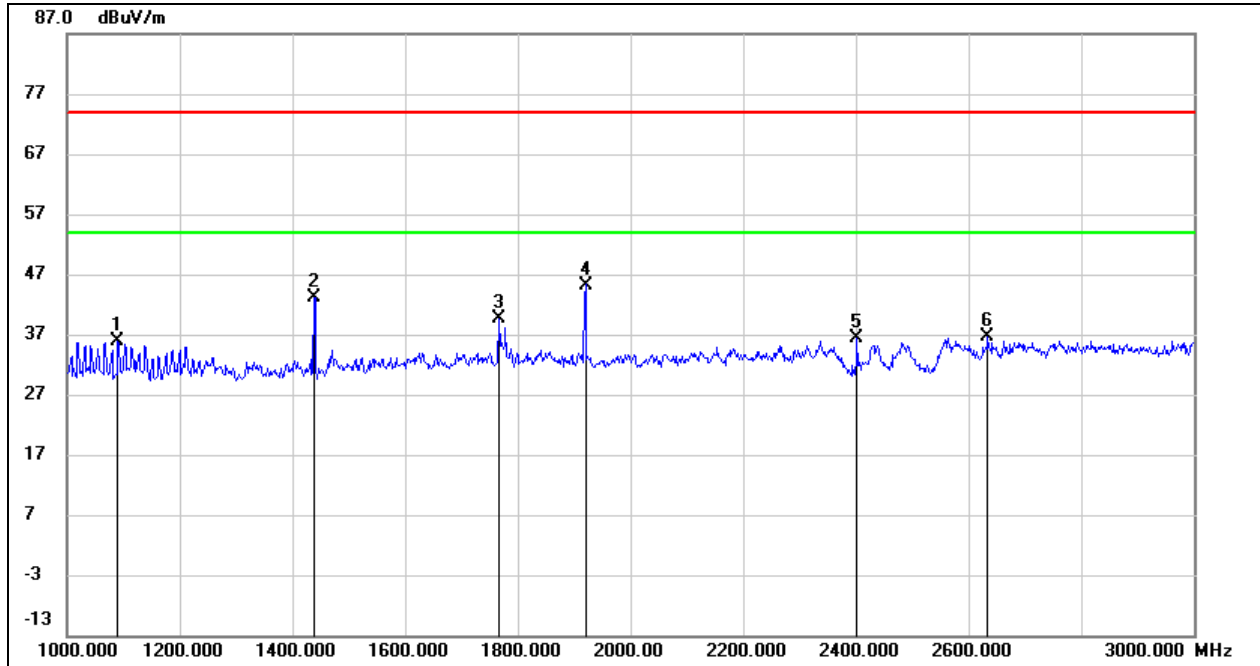

No.	Frequency (MHz)	Reading (dBuV)	Correct (dB/m)	Result (dBuV/m)	Limit (dBuV/m)	Margin (dB)	Remark
1	1091.000	50.44	-14.49	35.95	74.00	-38.05	peak
2	1439.000	56.13	-12.92	43.21	74.00	-30.79	peak
3	1767.000	50.51	-10.97	39.54	74.00	-34.46	peak
4	1920.000	56.27	-11.02	45.25	74.00	-28.75	peak
5	2402.000	45.37	-9.06	36.31	/	/	fundamental
6	2634.000	45.06	-8.48	36.58	74.00	-37.42	peak

Note:

1. Peak Result = Reading Level + Correct Factor.
2. If Peak Result complies with AV limit, AV Result is deemed to comply with AV limit.
3. Peak: Peak detector.
4. Filter losses were only considered in the spurious frequency bands and the authorized band was not corrected for Band reject filter losses.
5. Proper operation of the transmitter prior to adding the filter to the measurement chain.

HARMONICS AND SPURIOUS EMISSIONS (LOW CHANNEL, VERTICAL)

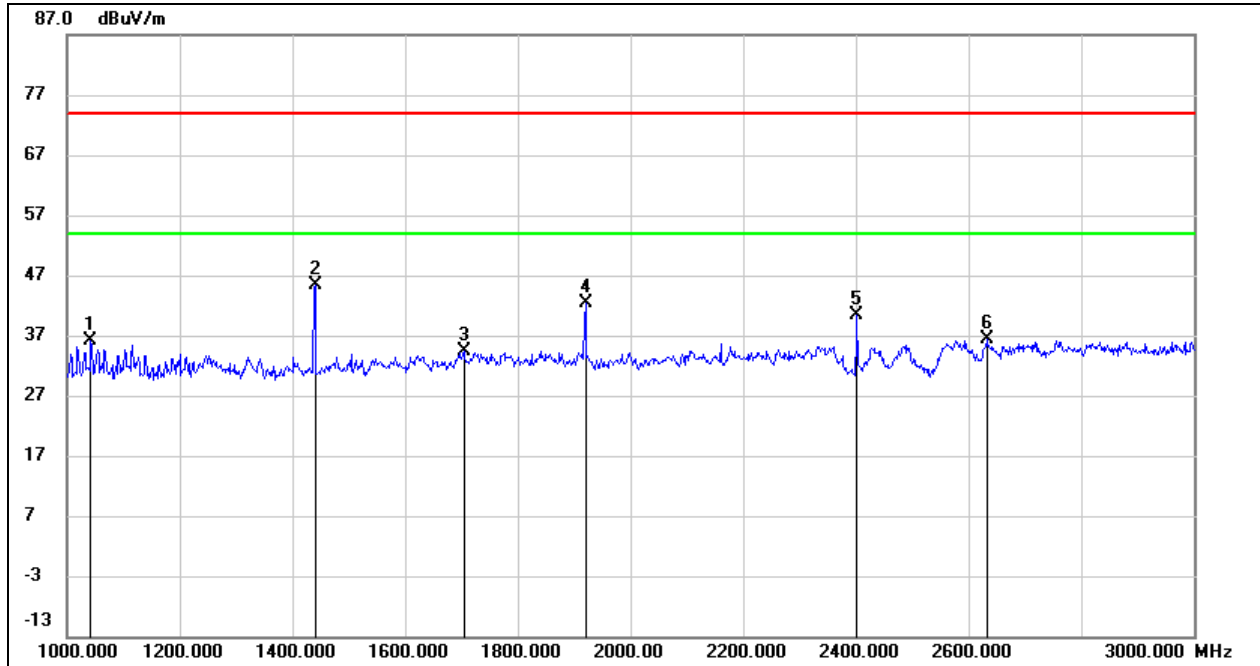

No.	Frequency (MHz)	Reading (dBuV)	Correct (dB/m)	Result (dBuV/m)	Limit (dBuV/m)	Margin (dB)	Remark
1	1043.000	50.81	-14.80	36.01	74.00	-37.99	peak
2	1440.000	58.17	-12.90	45.27	74.00	-28.73	peak
3	1704.000	45.66	-11.36	34.30	74.00	-39.70	peak
4	1920.000	53.31	-11.02	42.29	74.00	-31.71	peak
5	2402.000	49.36	-9.06	40.30	/	/	fundamental
6	2633.000	44.94	-8.48	36.46	74.00	-37.54	peak

Note:

1. Peak Result = Reading Level + Correct Factor.
2. If Peak Result complies with AV limit, AV Result is deemed to comply with AV limit.
3. Peak: Peak detector.
4. Filter losses were only considered in the spurious frequency bands and the authorized band was not corrected for Band reject filter losses.
5. Proper operation of the transmitter prior to adding the filter to the measurement chain.

HARMONICS AND SPURIOUS EMISSIONS (MID CHANNEL, HORIZONTAL)

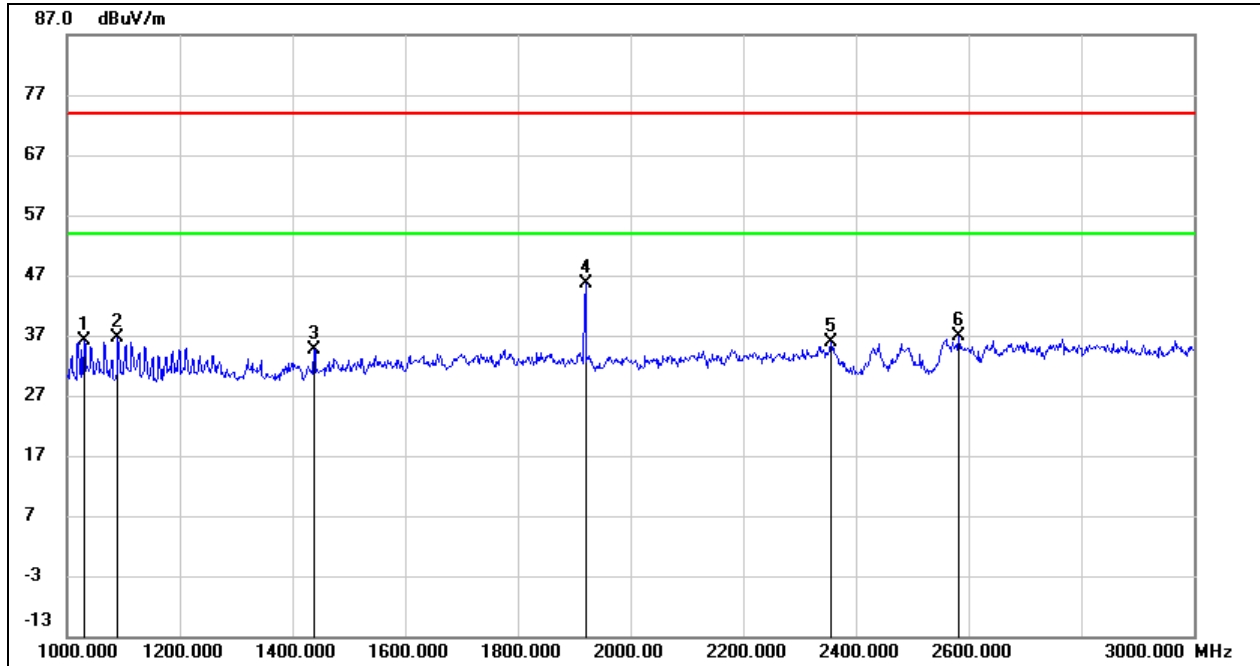

No.	Frequency (MHz)	Reading (dBuV)	Correct (dB/m)	Result (dBuV/m)	Limit (dBuV/m)	Margin (dB)	Remark
1	1031.000	51.02	-14.88	36.14	74.00	-37.86	peak
2	1091.000	51.24	-14.49	36.75	74.00	-37.25	peak
3	1439.000	47.63	-12.92	34.71	74.00	-39.29	peak
4	1920.000	56.59	-11.02	45.57	74.00	-28.43	peak
5	2356.000	45.06	-9.25	35.81	74.00	-38.19	peak
6	2582.000	45.51	-8.67	36.84	74.00	-37.16	peak

Note:

1. Peak Result = Reading Level + Correct Factor.
2. If Peak Result complies with AV limit, AV Result is deemed to comply with AV limit.
3. Peak: Peak detector.
4. Filter losses were only considered in the spurious frequency bands and the authorized band was not corrected for Band reject filter losses.
5. Proper operation of the transmitter prior to adding the filter to the measurement chain.

HARMONICS AND SPURIOUS EMISSIONS (MID CHANNEL, VERTICAL)

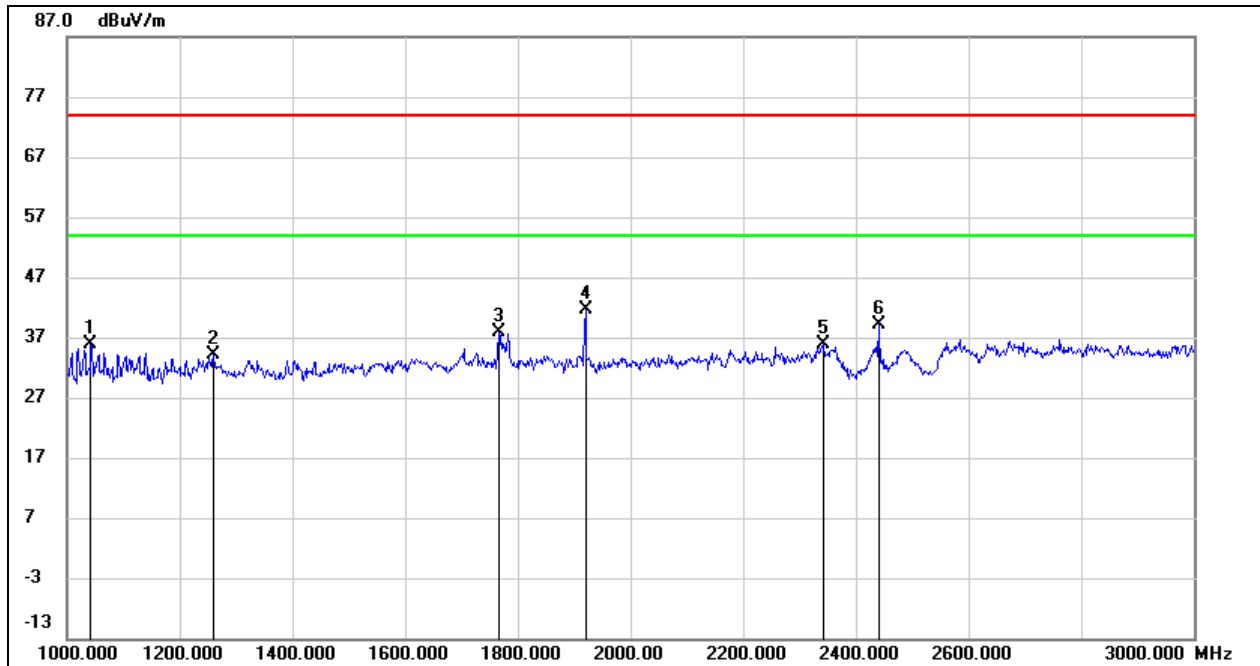

No.	Frequency (MHz)	Reading (dBuV)	Correct (dB/m)	Result (dBuV/m)	Limit (dBuV/m)	Margin (dB)	Remark
1	1043.000	50.60	-14.80	35.80	74.00	-38.20	peak
2	1260.000	47.70	-13.59	34.11	74.00	-39.89	peak
3	1766.000	48.92	-10.97	37.95	74.00	-36.05	peak
4	1920.000	52.74	-11.02	41.72	74.00	-32.28	peak
5	2342.000	45.26	-9.31	35.95	74.00	-38.05	peak
6	2441.000	47.98	-8.97	39.01	/	/	fundamental

Note:

1. Peak Result = Reading Level + Correct Factor.
2. If Peak Result complies with AV limit, AV Result is deemed to comply with AV limit.
3. Peak: Peak detector.
4. Filter losses were only considered in the spurious frequency bands and the authorized band was not corrected for Band reject filter losses.
5. Proper operation of the transmitter prior to adding the filter to the measurement chain.

HARMONICS AND SPURIOUS EMISSIONS (HIGH CHANNEL, HORIZONTAL)

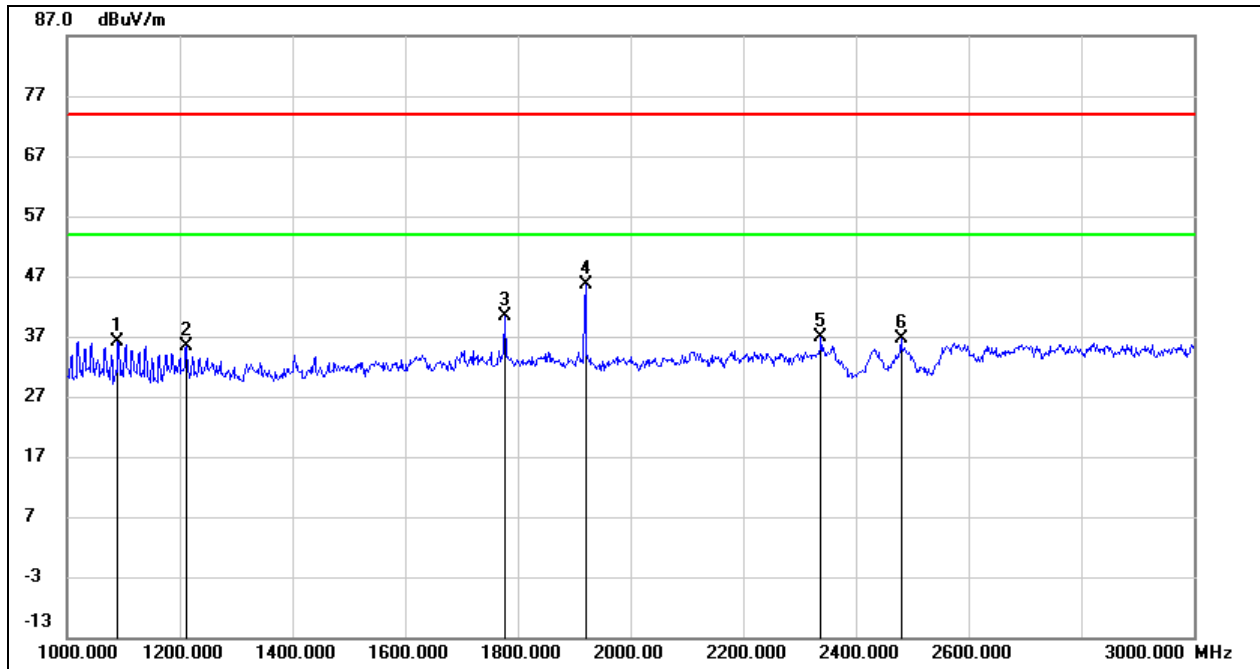

No.	Frequency (MHz)	Reading (dBuV)	Correct (dB/m)	Result (dBuV/m)	Limit (dBuV/m)	Margin (dB)	Remark
1	1091.000	50.65	-14.49	36.16	74.00	-37.84	peak
2	1212.000	49.03	-13.73	35.30	74.00	-38.70	peak
3	1777.000	51.20	-10.91	40.29	74.00	-33.71	peak
4	1920.000	56.58	-11.02	45.56	74.00	-28.44	peak
5	2339.000	46.15	-9.32	36.83	74.00	-37.17	peak
6	2480.000	45.55	-8.87	36.68	/	/	fundamental

Note:

1. Peak Result = Reading Level + Correct Factor.
2. If Peak Result complies with AV limit, AV Result is deemed to comply with AV limit.
3. Peak: Peak detector.
4. Filter losses were only considered in the spurious frequency bands and the authorized band was not corrected for Band reject filter losses.
5. Proper operation of the transmitter prior to adding the filter to the measurement chain.

HARMONICS AND SPURIOUS EMISSIONS (HIGH CHANNEL, VERTICAL)

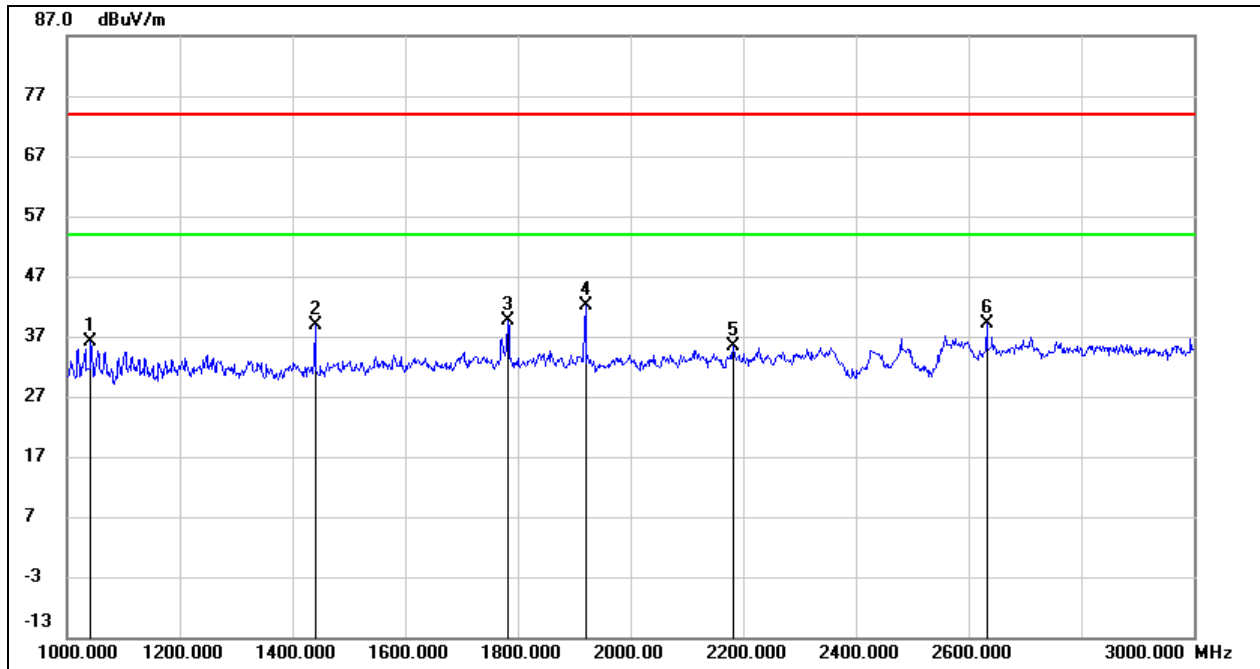

No.	Frequency (MHz)	Reading (dBuV)	Correct (dB/m)	Result (dBuV/m)	Limit (dBuV/m)	Margin (dB)	Remark
1	1043.000	50.90	-14.80	36.10	74.00	-37.90	peak
2	1440.000	51.87	-12.90	38.97	74.00	-35.03	peak
3	1782.000	50.40	-10.87	39.53	74.00	-34.47	peak
4	1920.000	53.18	-11.02	42.16	74.00	-31.84	peak
5	2182.000	45.46	-10.01	35.45	74.00	-38.55	peak
6	2633.000	47.72	-8.48	39.24	74.00	-34.76	peak

Note:

1. Peak Result = Reading Level + Correct Factor.
2. If Peak Result complies with AV limit, AV Result is deemed to comply with AV limit.
3. Peak: Peak detector.
4. Filter losses were only considered in the spurious frequency bands and the authorized band was not corrected for Band reject filter losses.
5. Proper operation of the transmitter prior to adding the filter to the measurement chain.

Note: All the modes and channels had been tested, but only the worst data was recorded in the report.

8.3. SPURIOUS EMISSIONS (3 GHz ~ 18 GHz)

8.3.1. GFSK MODE

HARMONICS AND SPURIOUS EMISSIONS (LOW CHANNEL, HORIZONTAL)

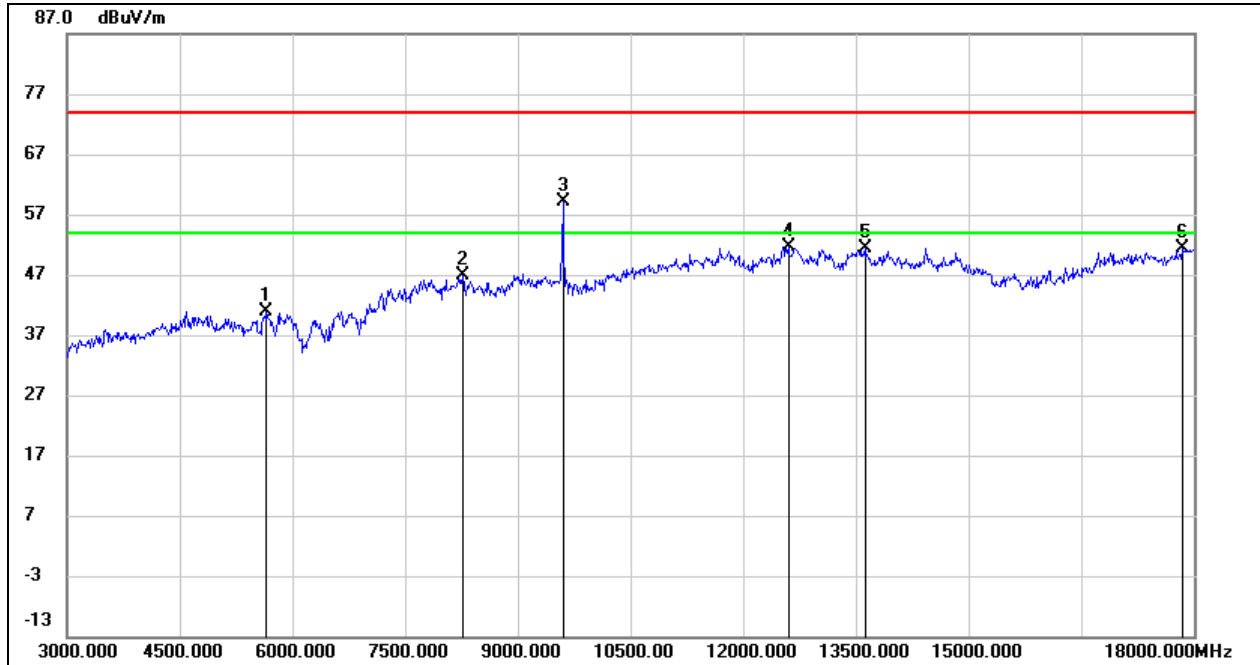

No.	Frequency (MHz)	Reading (dBuV)	Correct (dB/m)	Result (dBuV/m)	Limit (dBuV/m)	Margin (dB)	Remark
1	5662.500	39.44	1.44	40.88	74.00	-33.12	peak
2	8265.000	38.42	8.45	46.87	74.00	-27.13	peak
3*	9607.500	48.64	10.50	59.14	/	/	peak
4	12607.500	35.00	16.64	51.64	74.00	-22.36	peak
5	13627.500	32.99	18.42	51.41	74.00	-22.59	peak
6	17857.500	28.33	23.01	51.34	74.00	-22.66	peak

Note: 1. Peak Result = Reading Level + Correct Factor.
 2. If Peak Result complies with AV limit, AV Result is deemed to comply with AV limit.
 3. Peak: Peak detector.
 4. Filter losses were only considered in the spurious frequency bands and the authorized band was not corrected for High Pass Filter losses.
 5. Proper operation of the transmitter prior to adding the filter to the measurement chain.
 6.*-indicates frequency is out of the restricted bands and the limit is referring to 15.247 (d) and RSS-247 clause 5.5. We had already performed the conducted non-restricted bands test, please refer to clause 7.5.

HARMONICS AND SPURIOUS EMISSIONS (LOW CHANNEL, VERTICAL)

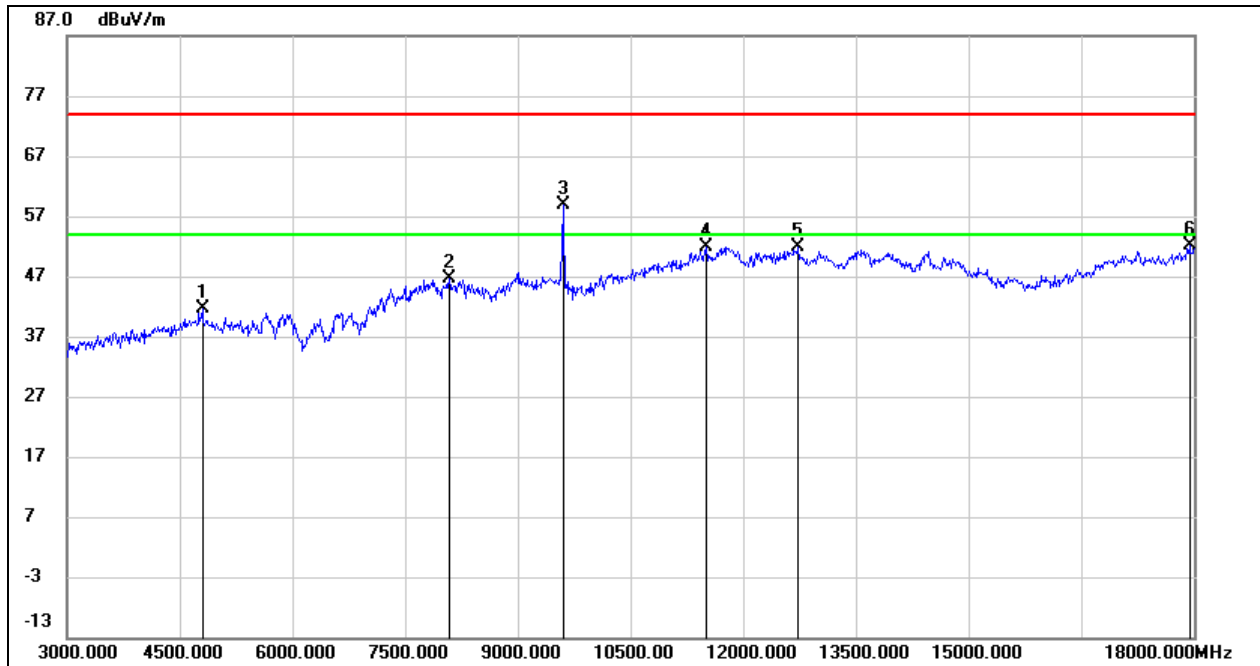

No.	Frequency (MHz)	Reading (dBuV)	Correct (dB/m)	Result (dBuV/m)	Limit (dBuV/m)	Margin (dB)	Remark
1	4800.000	42.28	-0.65	41.63	74.00	-32.37	peak
2	8085.000	38.78	7.77	46.55	74.00	-27.45	peak
3*	9607.500	48.45	10.50	58.95	/	/	peak
4	11505.000	35.81	16.15	51.96	74.00	-22.04	peak
5	12742.500	34.88	16.94	51.82	74.00	-22.18	peak
6	17947.500	28.92	23.24	52.16	74.00	-21.84	peak

Note: 1. Peak Result = Reading Level + Correct Factor.
 2. If Peak Result complies with AV limit, AV Result is deemed to comply with AV limit.
 3. Peak: Peak detector.
 4. Filter losses were only considered in the spurious frequency bands and the authorized band was not corrected for High Pass Filter losses.
 5. Proper operation of the transmitter prior to adding the filter to the measurement chain.
 6.*-indicates frequency is out of the restricted bands and the limit is referring to 15.247 (d) and RSS-247 clause 5.5. We had already performed the conducted non-restricted bands test, please refer to clause 7.5.

HARMONICS AND SPURIOUS EMISSIONS (MID CHANNEL, HORIZONTAL)

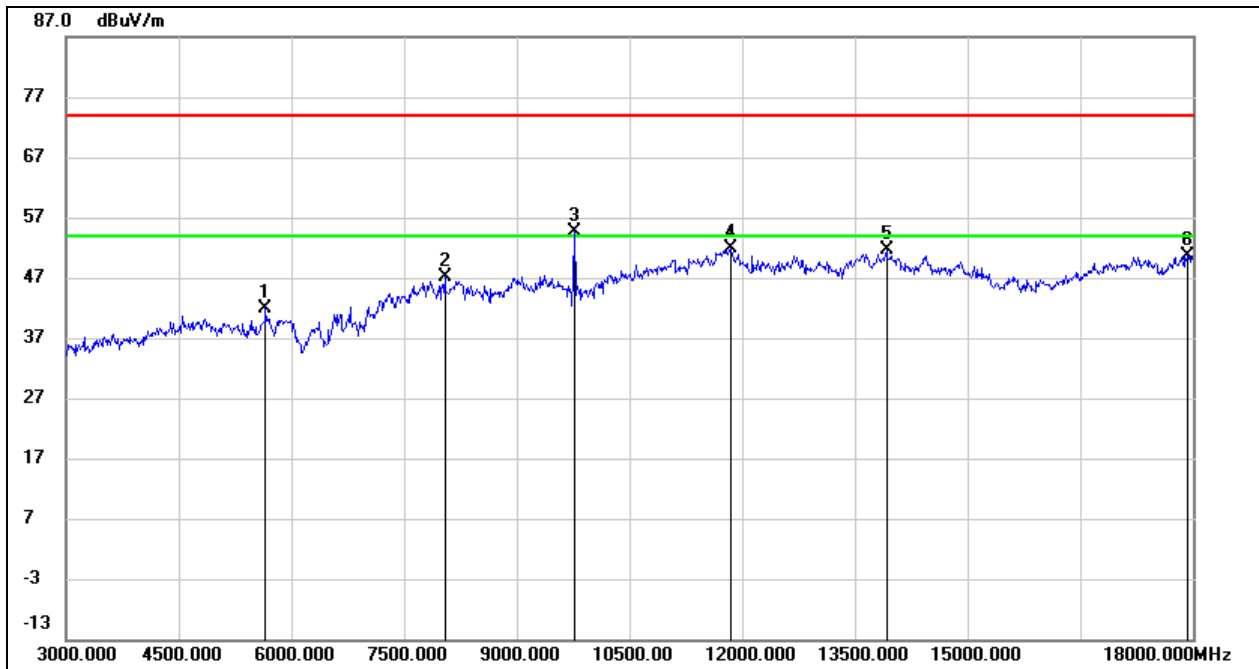

No.	Frequency (MHz)	Reading (dBuV)	Correct (dB/m)	Result (dBuV/m)	Limit (dBuV/m)	Margin (dB)	Remark
1	5655.000	40.46	1.44	41.90	74.00	-32.10	peak
2	8040.000	39.64	7.39	47.03	74.00	-26.97	peak
3*	9765.000	44.39	10.33	54.72	/	/	peak
4	11850.000	34.63	17.26	51.89	74.00	-22.11	peak
5	13927.500	32.99	18.63	51.62	74.00	-22.38	peak
6	17932.500	27.54	23.19	50.73	74.00	-23.27	peak

Note: 1. Peak Result = Reading Level + Correct Factor.
 2. If Peak Result complies with AV limit, AV Result is deemed to comply with AV limit.
 3. Peak: Peak detector.
 4. Filter losses were only considered in the spurious frequency bands and the authorized band was not corrected for High Pass Filter losses.
 5. Proper operation of the transmitter prior to adding the filter to the measurement chain.
 6.*-indicates frequency is out of the restricted bands and the limit is referring to 15.247 (d) and RSS-247 clause 5.5. We had already performed the conducted non-restricted bands test, please refer to clause 7.5.

HARMONICS AND SPURIOUS EMISSIONS (MID CHANNEL, VERTICAL)

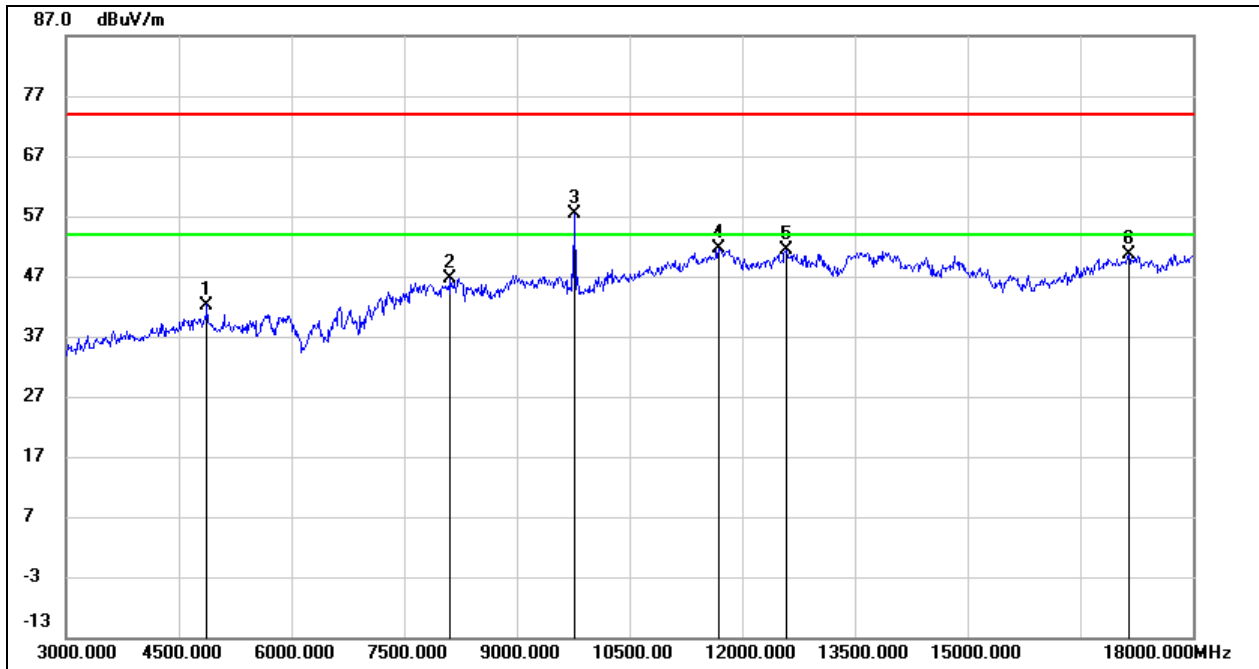

No.	Frequency (MHz)	Reading (dBuV)	Correct (dB/m)	Result (dBuV/m)	Limit (dBuV/m)	Margin (dB)	Remark
1	4882.500	42.84	-0.59	42.25	74.00	-31.75	peak
2	8115.000	38.72	8.01	46.73	74.00	-27.27	peak
3*	9765.000	46.94	10.33	57.27	/	/	peak
4	11685.000	34.76	16.75	51.51	74.00	-22.49	peak
5	12585.000	34.63	16.64	51.27	74.00	-22.73	peak
6	17152.500	31.20	19.46	50.66	74.00	-23.34	peak

Note: 1. Peak Result = Reading Level + Correct Factor.
 2. If Peak Result complies with AV limit, AV Result is deemed to comply with AV limit.
 3. Peak: Peak detector.
 4. Filter losses were only considered in the spurious frequency bands and the authorized band was not corrected for High Pass Filter losses.
 5. Proper operation of the transmitter prior to adding the filter to the measurement chain.
 6.*-indicates frequency is out of the restricted bands and the limit is referring to 15.247 (d) and RSS-247 clause 5.5. We had already performed the conducted non-restricted bands test, please refer to clause 7.5.

HARMONICS AND SPURIOUS EMISSIONS (HIGH CHANNEL, HORIZONTAL)

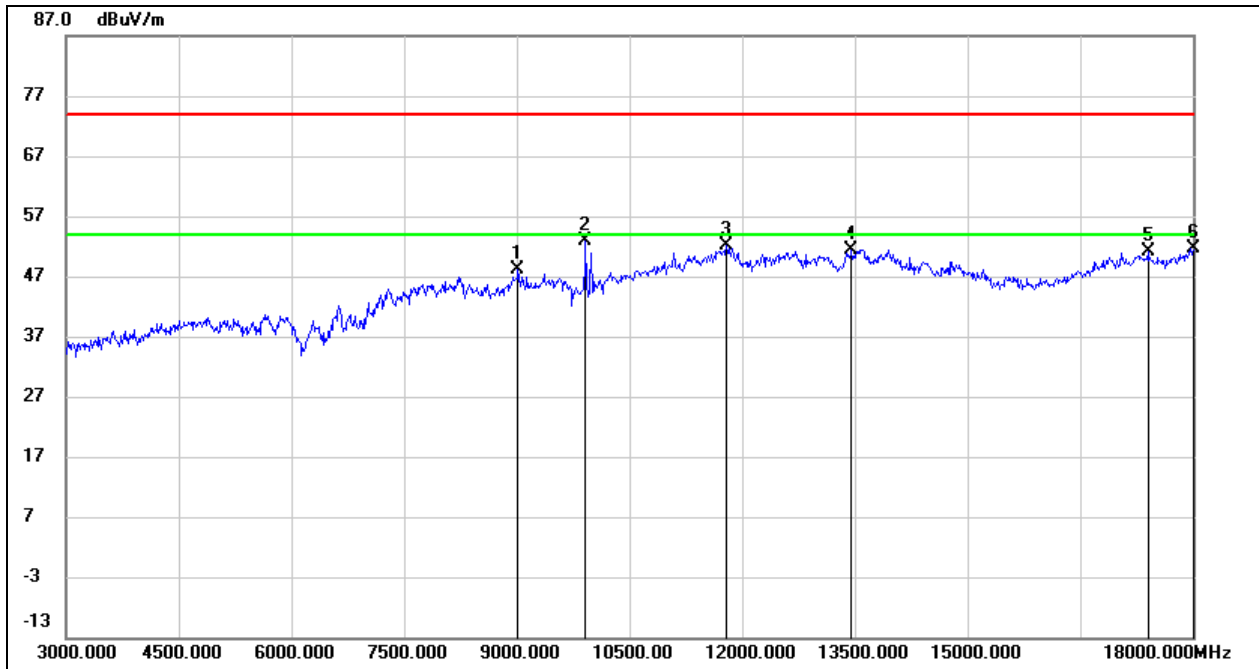

No.	Frequency (MHz)	Reading (dBuV)	Correct (dB/m)	Result (dBuV/m)	Limit (dBuV/m)	Margin (dB)	Remark
1	9022.500	38.12	10.00	48.12	74.00	-25.88	peak
2	9922.500	42.35	10.61	52.96	74.00	-21.04	peak
3	11790.000	34.88	17.30	52.18	74.00	-21.82	peak
4	13455.000	33.02	18.32	51.34	74.00	-22.66	peak
5	17407.500	31.18	19.85	51.03	74.00	-22.97	peak
6	18000.000	28.16	23.37	51.53	74.00	-22.47	peak

- Note: 1. Peak Result = Reading Level + Correct Factor.
 2. If Peak Result complies with AV limit, AV Result is deemed to comply with AV limit.
 3. Peak: Peak detector.
 4. Filter losses were only considered in the spurious frequency bands and the authorized band was not corrected for High Pass Filter losses.
 5. Proper operation of the transmitter prior to adding the filter to the measurement chain.

HARMONICS AND SPURIOUS EMISSIONS (HIGH CHANNEL, VERTICAL)

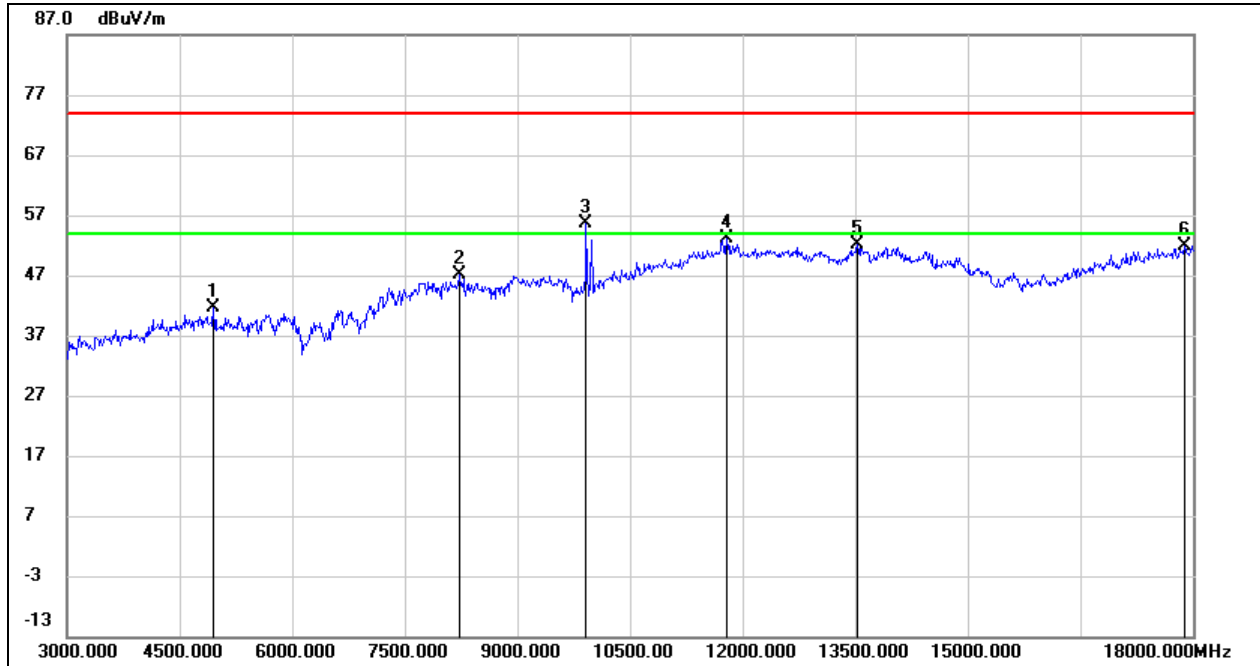

No.	Frequency (MHz)	Reading (dBuV)	Correct (dB/m)	Result (dBuV/m)	Limit (dBuV/m)	Margin (dB)	Remark
1	4957.500	42.09	-0.54	41.55	74.00	-32.45	peak
2	8227.500	38.56	8.61	47.17	74.00	-26.83	peak
3*	9922.500	45.08	10.61	55.69	/	/	peak
4	11797.500	35.82	17.34	53.16	74.00	-20.84	peak
5	13537.500	33.79	18.39	52.18	74.00	-21.82	peak
6	17902.500	28.72	23.12	51.84	74.00	-22.16	peak

Note: 1. Peak Result = Reading Level + Correct Factor.
 2. If Peak Result complies with AV limit, AV Result is deemed to comply with AV limit.
 3. Peak: Peak detector.
 4. Filter losses were only considered in the spurious frequency bands and the authorized band was not corrected for High Pass Filter losses.
 5. Proper operation of the transmitter prior to adding the filter to the measurement chain.
 6.*-indicates frequency is out of the restricted bands and the limit is referring to 15.247 (d) and RSS-247 clause 5.5. We had already performed the conducted non-restricted bands test, please refer to clause 7.5.

8.3.2. 8DPSK MODE

HARMONICS AND SPURIOUS EMISSIONS (LOW CHANNEL, HORIZONTAL)

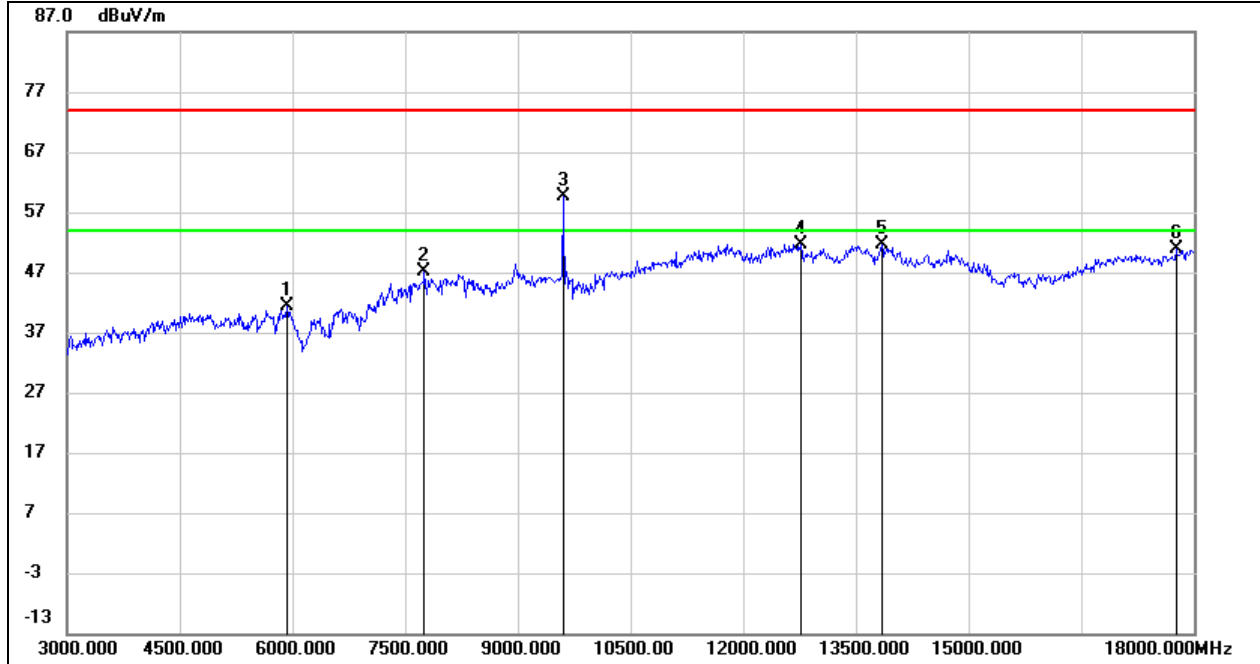

No.	Frequency (MHz)	Reading (dBuV)	Correct (dB/m)	Result (dBuV/m)	Limit (dBuV/m)	Margin (dB)	Remark
1	5925.000	39.36	1.93	41.29	74.00	-32.71	peak
2	7755.000	39.75	7.42	47.17	74.00	-26.83	peak
3*	9607.500	49.21	10.50	59.71	/	/	peak
4	12772.500	34.60	17.02	51.62	74.00	-22.38	peak
5	13852.500	32.90	18.72	51.62	74.00	-22.38	peak
6	17760.000	28.36	22.44	50.80	74.00	-23.20	peak

Note: 1. Peak Result = Reading Level + Correct Factor.
 2. If Peak Result complies with AV limit, AV Result is deemed to comply with AV limit.
 3. Peak: Peak detector.
 4. Filter losses were only considered in the spurious frequency bands and the authorized band was not corrected for High Pass Filter losses.
 5. Proper operation of the transmitter prior to adding the filter to the measurement chain.
 6.*-indicates frequency is out of the restricted bands and the limit is referring to 15.247 (d) and RSS-247 clause 5.5. We had already performed the conducted non-restricted bands test, please refer to clause 7.5.

HARMONICS AND SPURIOUS EMISSIONS (LOW CHANNEL, VERTICAL)

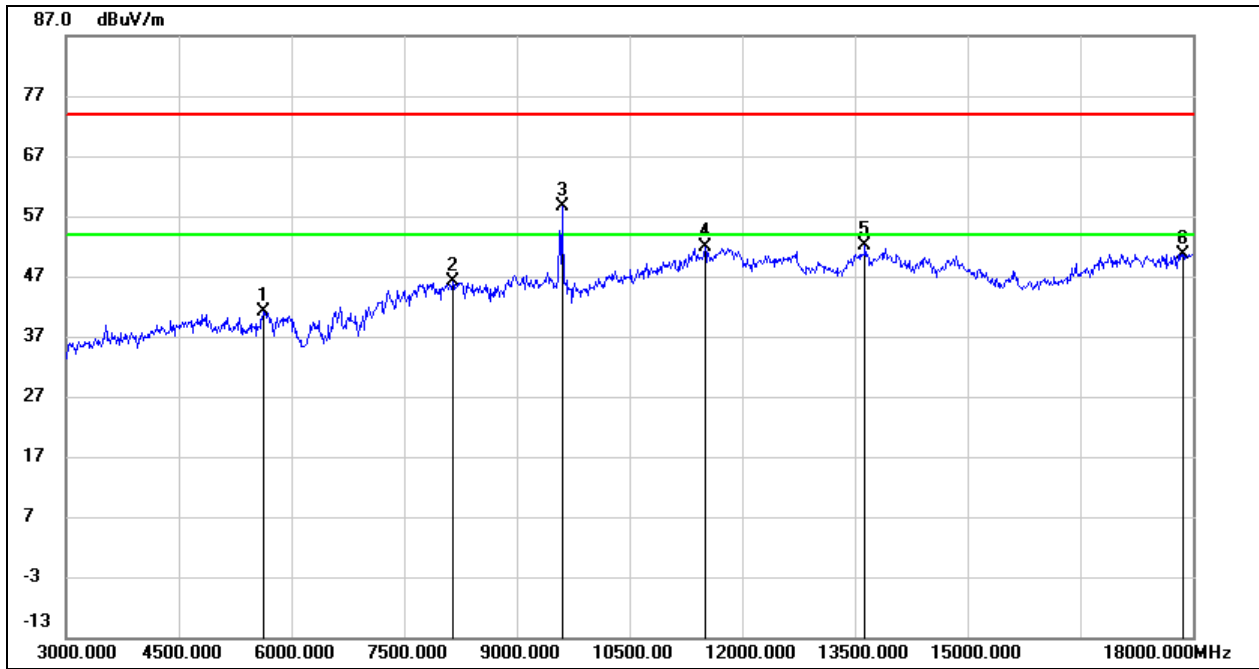

No.	Frequency (MHz)	Reading (dBuV)	Correct (dB/m)	Result (dBuV/m)	Limit (dBuV/m)	Margin (dB)	Remark
1	5632.500	39.58	1.44	41.02	74.00	-32.98	peak
2	8152.500	37.68	8.33	46.01	74.00	-27.99	peak
3*	9607.500	48.13	10.50	58.63	/	/	peak
4	11505.000	35.72	16.15	51.87	74.00	-22.13	peak
5	13642.500	33.68	18.45	52.13	74.00	-21.87	peak
6	17872.500	27.70	23.04	50.74	74.00	-23.26	peak

Note: 1. Peak Result = Reading Level + Correct Factor.
 2. If Peak Result complies with AV limit, AV Result is deemed to comply with AV limit.
 3. Peak: Peak detector.
 4. Filter losses were only considered in the spurious frequency bands and the authorized band was not corrected for High Pass Filter losses.
 5. Proper operation of the transmitter prior to adding the filter to the measurement chain.
 6.*-indicates frequency is out of the restricted bands and the limit is referring to 15.247 (d) and RSS-247 clause 5.5. We had already performed the conducted non-restricted bands test, please refer to clause 7.5.

HARMONICS AND SPURIOUS EMISSIONS (MID CHANNEL, HORIZONTAL)

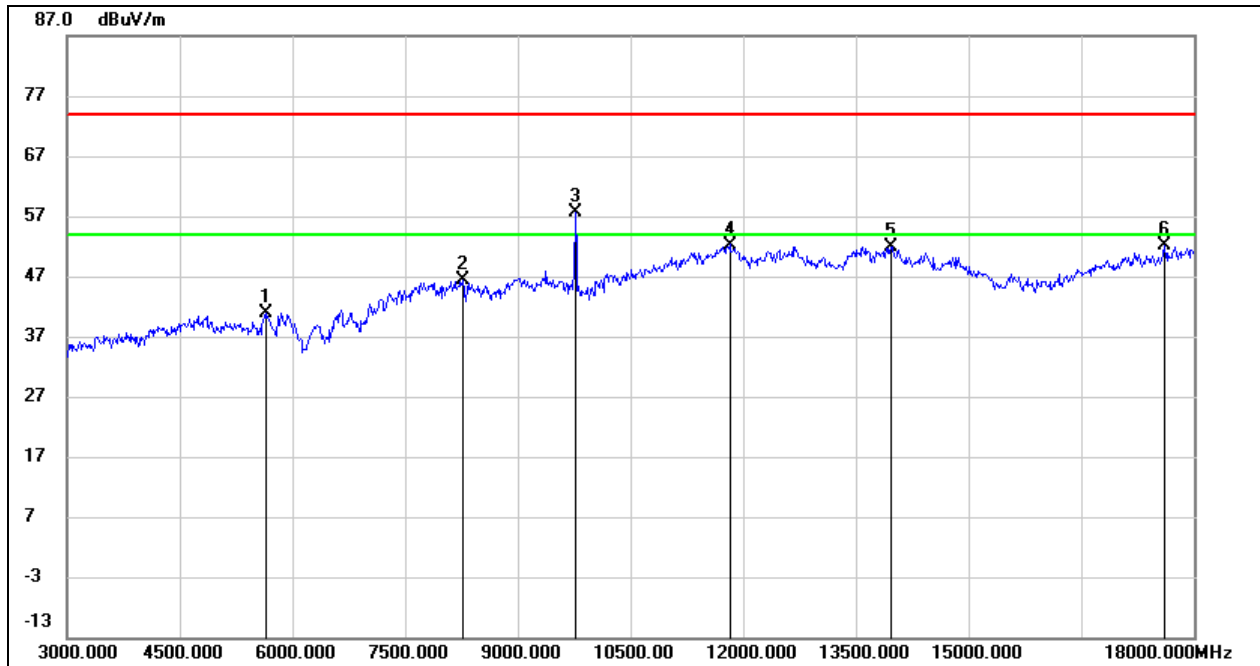

No.	Frequency (MHz)	Reading (dBuV)	Correct (dB/m)	Result (dBuV/m)	Limit (dBuV/m)	Margin (dB)	Remark
1	5662.500	39.45	1.44	40.89	74.00	-33.11	peak
2	8265.000	37.93	8.45	46.38	74.00	-27.62	peak
3*	9765.000	47.26	10.33	57.59	/	/	peak
4	11820.000	34.93	17.32	52.25	74.00	-21.75	peak
5	13965.000	33.40	18.58	51.98	74.00	-22.02	peak
6	17617.500	31.28	20.93	52.21	74.00	-21.79	peak

Note: 1. Peak Result = Reading Level + Correct Factor.
 2. If Peak Result complies with AV limit, AV Result is deemed to comply with AV limit.
 3. Peak: Peak detector.
 4. Filter losses were only considered in the spurious frequency bands and the authorized band was not corrected for High Pass Filter losses.
 5. Proper operation of the transmitter prior to adding the filter to the measurement chain.
 6.*-indicates frequency is out of the restricted bands and the limit is referring to 15.247 (d) and RSS-247 clause 5.5. We had already performed the conducted non-restricted bands test, please refer to clause 7.5.

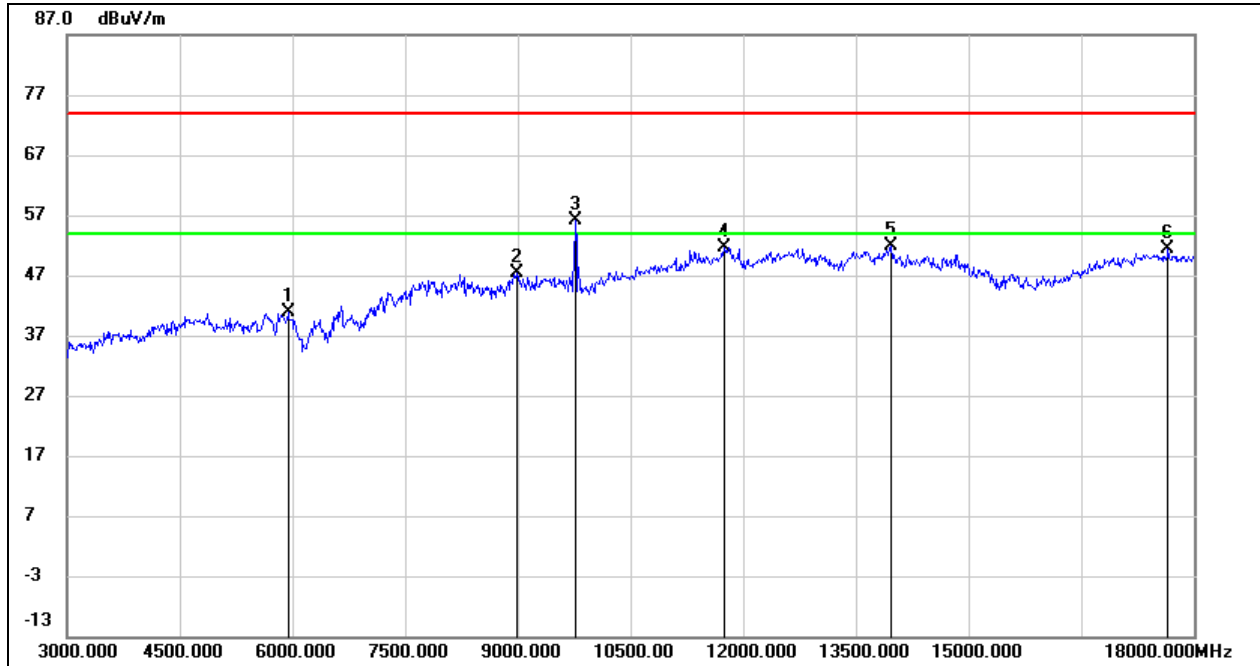
HARMONICS AND SPURIOUS EMISSIONS (MID CHANNEL, VERTICAL)

No.	Frequency (MHz)	Reading (dBuV)	Correct (dB/m)	Result (dBuV/m)	Limit (dBuV/m)	Margin (dB)	Remark
1	5947.500	38.81	2.00	40.81	74.00	-33.19	peak
2	8985.000	37.37	9.96	47.33	74.00	-26.67	peak
3*	9765.000	45.68	10.33	56.01	/	/	peak
4	11752.500	34.46	17.10	51.56	74.00	-22.44	peak
5	13972.500	33.33	18.58	51.91	74.00	-22.09	peak
6	17662.500	30.00	21.41	51.41	74.00	-22.59	peak

Note: 1. Peak Result = Reading Level + Correct Factor.

2. If Peak Result complies with AV limit, AV Result is deemed to comply with AV limit.

3. Peak: Peak detector.

4. Filter losses were only considered in the spurious frequency bands and the authorized band was not corrected for High Pass Filter losses.

5. Proper operation of the transmitter prior to adding the filter to the measurement chain.

6.*-indicates frequency is out of the restricted bands and the limit is referring to 15.247 (d) and RSS-247 clause 5.5. We had already performed the conducted non-restricted bands test, please refer to clause 7.5.

HARMONICS AND SPURIOUS EMISSIONS (HIGH CHANNEL, HORIZONTAL)

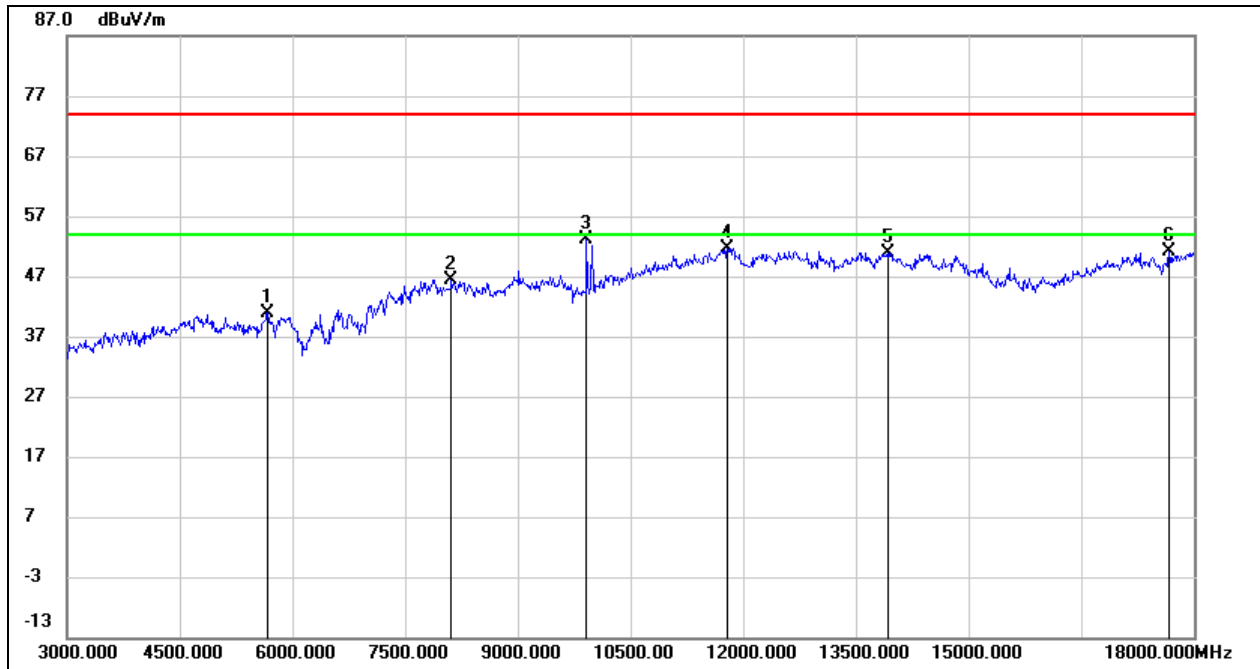

No.	Frequency (MHz)	Reading (dBuV)	Correct (dB/m)	Result (dBuV/m)	Limit (dBuV/m)	Margin (dB)	Remark
1	5670.000	39.55	1.44	40.99	74.00	-33.01	peak
2	8122.500	38.35	8.08	46.43	74.00	-27.57	peak
3	9922.500	42.44	10.61	53.05	74.00	-20.95	peak
4	11797.500	34.34	17.34	51.68	74.00	-22.32	peak
5	13920.000	32.34	18.64	50.98	74.00	-23.02	peak
6	17677.500	29.46	21.56	51.02	74.00	-22.98	peak

- Note: 1. Peak Result = Reading Level + Correct Factor.
 2. If Peak Result complies with AV limit, AV Result is deemed to comply with AV limit.
 3. Peak: Peak detector.
 4. Filter losses were only considered in the spurious frequency bands and the authorized band was not corrected for High Pass Filter losses.
 5. Proper operation of the transmitter prior to adding the filter to the measurement chain.

HARMONICS AND SPURIOUS EMISSIONS (HIGH CHANNEL, VERTICAL)

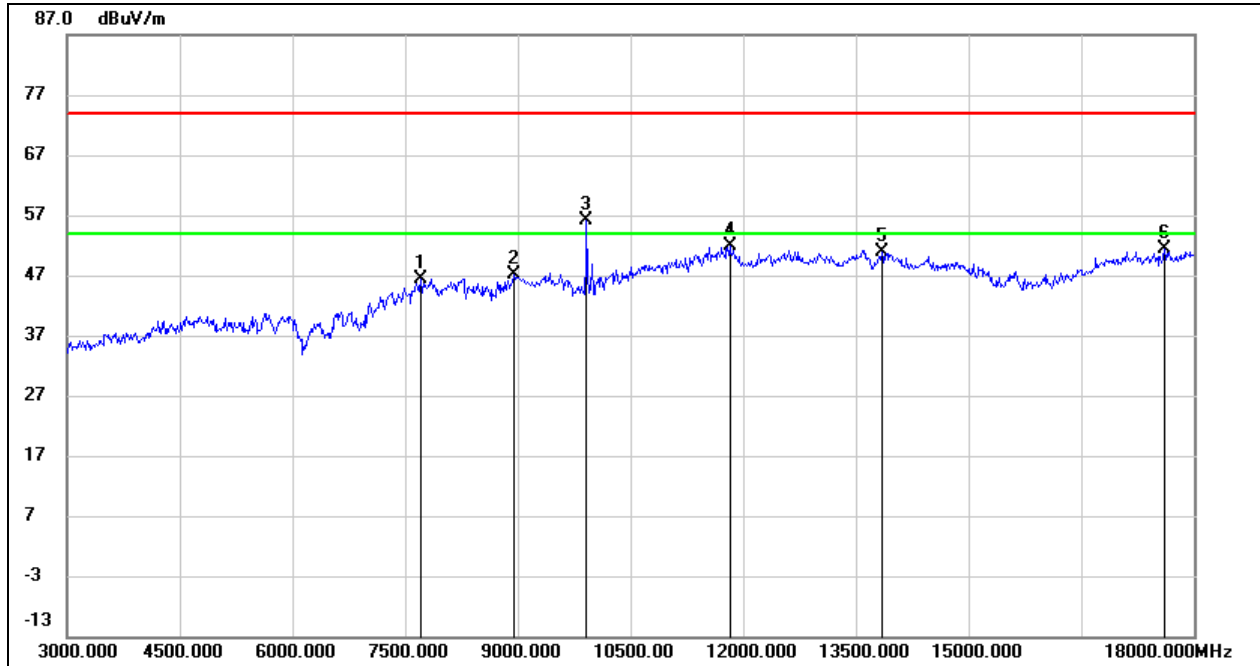

No.	Frequency (MHz)	Reading (dBuV)	Correct (dB/m)	Result (dBuV/m)	Limit (dBuV/m)	Margin (dB)	Remark
1	7710.000	39.18	7.25	46.43	74.00	-27.57	peak
2	8955.000	37.37	9.64	47.01	74.00	-26.99	peak
3*	9922.500	45.57	10.61	56.18	/	/	peak
4	11827.500	34.62	17.30	51.92	74.00	-22.08	peak
5	13852.500	32.04	18.72	50.76	74.00	-23.24	peak
6	17617.500	30.53	20.93	51.46	74.00	-22.54	peak

Note: 1. Peak Result = Reading Level + Correct Factor.
 2. If Peak Result complies with AV limit, AV Result is deemed to comply with AV limit.
 3. Peak: Peak detector.
 4. Filter losses were only considered in the spurious frequency bands and the authorized band was not corrected for High Pass Filter losses.
 5. Proper operation of the transmitter prior to adding the filter to the measurement chain.
 6.*-indicates frequency is out of the restricted bands and the limit is referring to 15.247 (d) and RSS-247 clause 5.5. We had already performed the conducted non-restricted bands test, please refer to clause 7.5.

8.4. SPURIOUS EMISSIONS (18 GHz ~ 26 GHz)

8.4.1. 8DPSK MODE

SPURIOUS EMISSIONS (MID CHANNEL, WORST-CASE CONFIGURATION, HORIZONTAL)

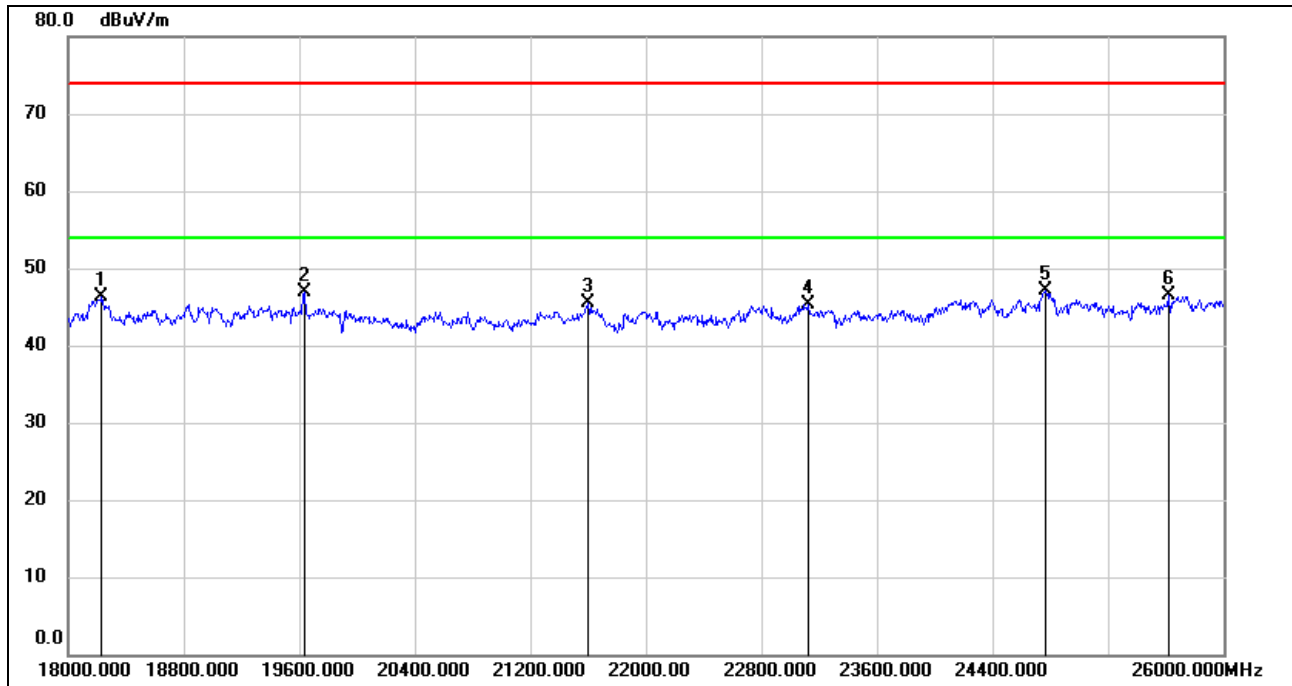

No.	Frequency (MHz)	Reading (dBuV)	Correct (dB/m)	Result (dBuV/m)	Limit (dBuV/m)	Margin (dB)	Remark
1	18232.000	51.75	-5.54	46.21	74.00	-27.79	peak
2	19640.000	52.29	-5.38	46.91	74.00	-27.09	peak
3	21600.000	50.02	-4.54	45.48	74.00	-28.52	peak
4	23120.000	48.71	-3.40	45.31	74.00	-28.69	peak
5	24768.000	49.36	-2.31	47.05	74.00	-26.95	peak
6	25616.000	47.68	-1.24	46.44	74.00	-27.56	peak

Note: 1. Peak Result = Reading Level + Correct Factor.

2. If Peak Result complies with AV limit, AV Result is deemed to comply with AV limit.

3. Peak: Peak detector.



SPURIOUS EMISSIONS (MID CHANNEL, WORST-CASE CONFIGURATION, VERTICAL)

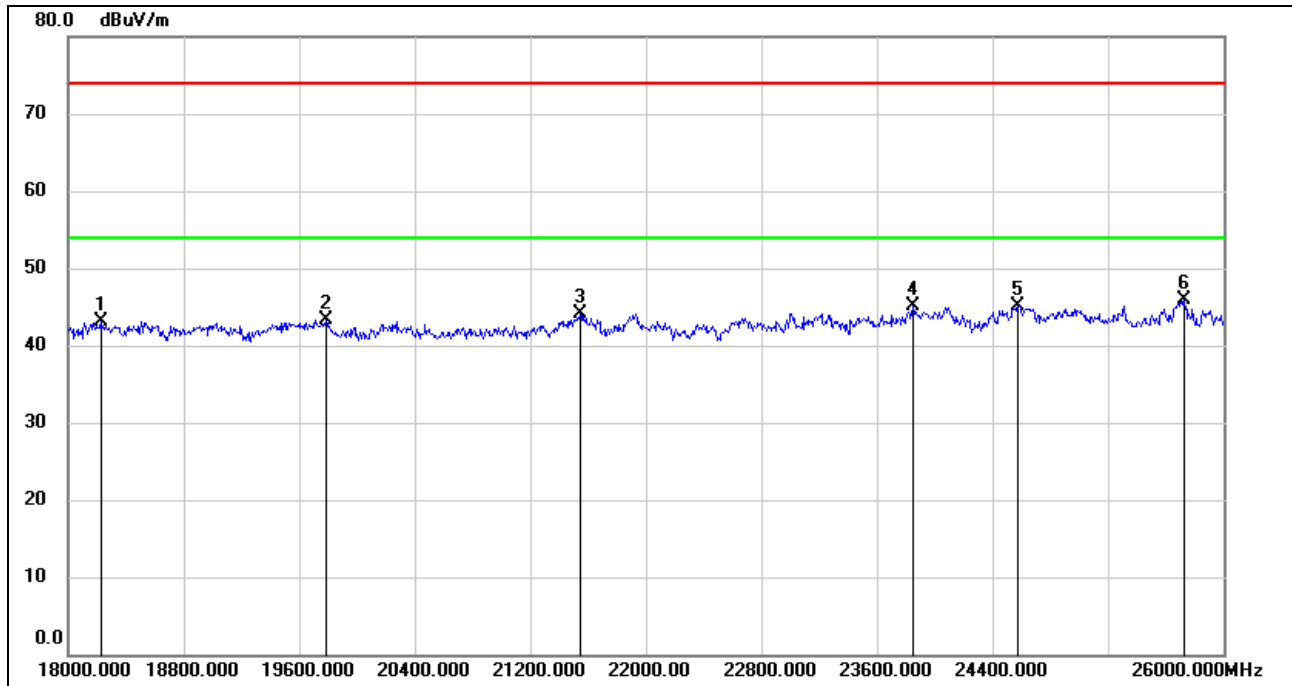

No.	Frequency (MHz)	Reading (dBuV)	Correct (dB/m)	Result (dBuV/m)	Limit (dBuV/m)	Margin (dB)	Remark
1	18224.000	48.58	-5.53	43.05	74.00	-30.95	peak
2	19784.000	48.57	-5.28	43.29	74.00	-30.71	peak
3	21544.000	48.76	-4.63	44.13	74.00	-29.87	peak
4	23848.000	48.18	-3.03	45.15	74.00	-28.85	peak
5	24576.000	47.38	-2.31	45.07	74.00	-28.93	peak
6	25728.000	46.61	-0.72	45.89	74.00	-28.11	peak

- Note: 1. Peak Result = Reading Level + Correct Factor.
 2. If Peak Result complies with AV limit, AV Result is deemed to comply with AV limit.
 3. Peak: Peak detector.

Note: All the modes have been tested, only the worst data was recorded in the report.

8.5. SPURIOUS EMISSIONS (30 MHz ~ 1 GHz)

8.5.1. 8DPSK MODE

SPURIOUS EMISSIONS (MID CHANNEL, WORST-CASE CONFIGURATION, HORIZONTAL)

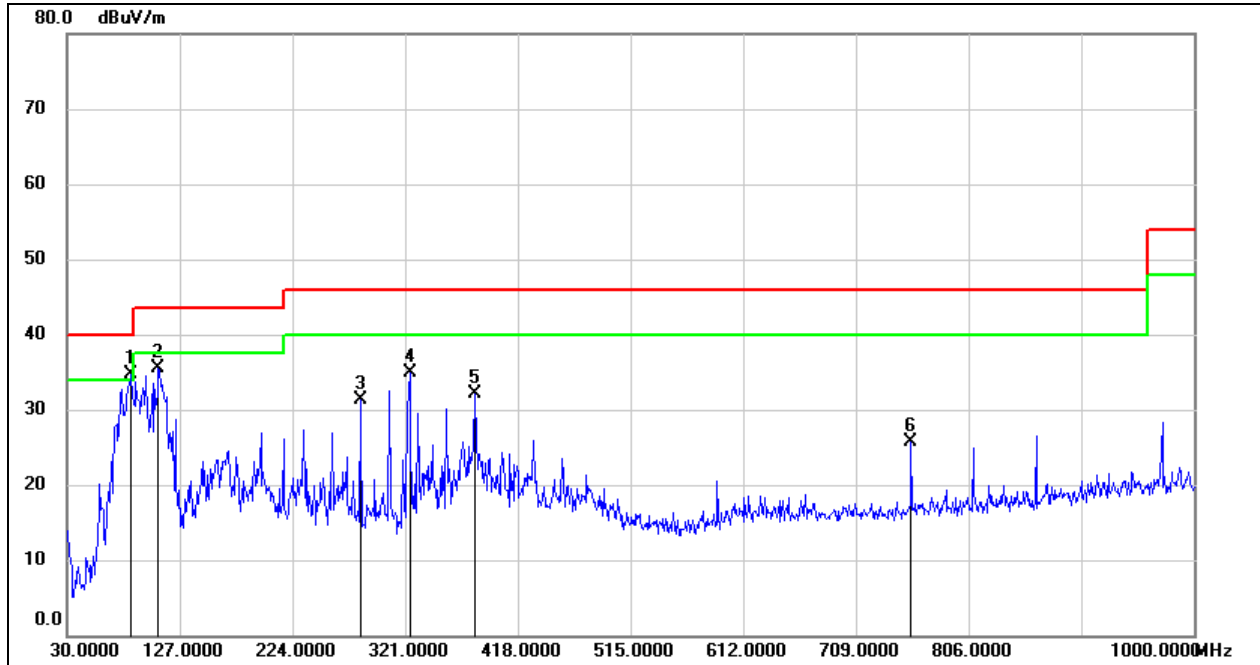

No.	Frequency (MHz)	Reading (dBuV)	Correct (dB/m)	Result (dBuV/m)	Limit (dBuV/m)	Margin (dB)	Remark
1	85.2900	56.43	-21.69	34.74	40.00	-5.26	QP
2	108.5700	56.00	-20.53	35.47	43.50	-8.03	QP
3	282.2000	47.75	-16.52	31.23	46.00	-14.77	QP
4	324.8800	49.69	-14.73	34.96	46.00	-11.04	QP
5	381.1400	45.74	-13.62	32.12	46.00	-13.88	QP
6	756.5300	33.59	-7.79	25.80	46.00	-20.20	QP

- Note: 1. Result Level = Read Level + Antenna Factor + Cable loss.
 2. If Peak Result complies with QP limit, QP Result is deemed to comply with QP limit.
 3. Test setup: RBW: 120 kHz, VBW: 300 kHz, Sweep time: auto.



SPURIOUS EMISSIONS (MID CHANNEL, WORST-CASE CONFIGURATION, VERTICAL)

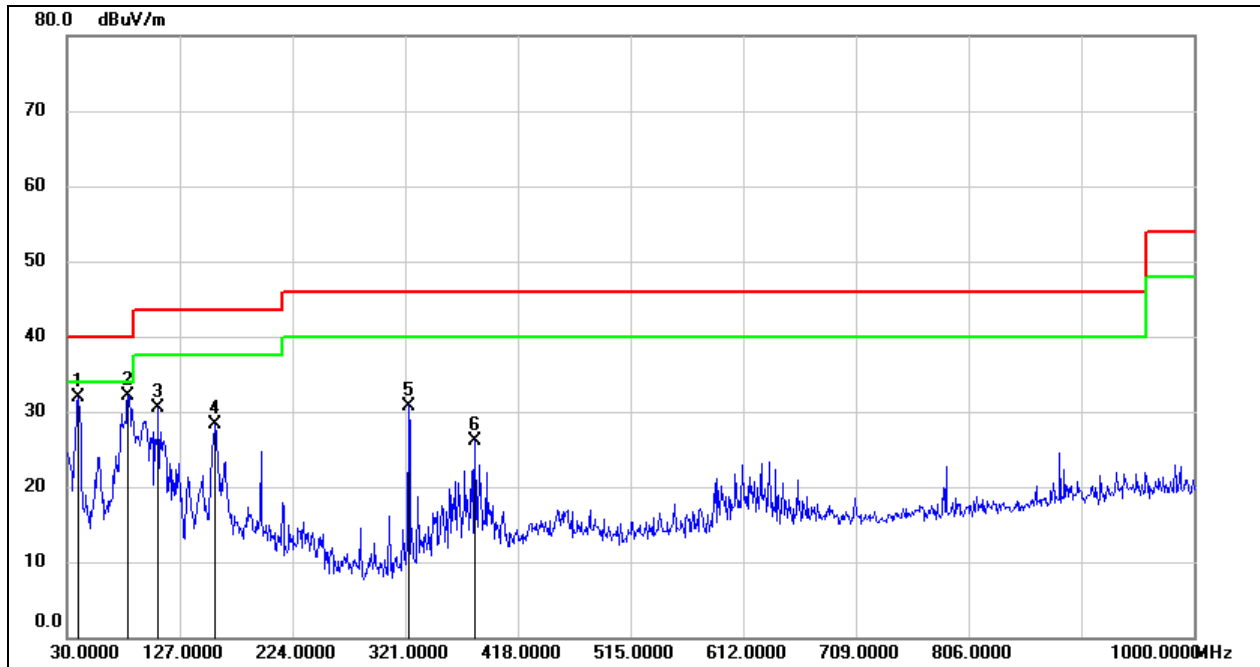

No.	Frequency (MHz)	Reading (dBuV)	Correct (dB/m)	Result (dBuV/m)	Limit (dBuV/m)	Margin (dB)	Remark
1	39.7000	51.78	-19.96	31.82	40.00	-8.18	QP
2	82.3800	53.69	-21.51	32.18	40.00	-7.82	QP
3	108.5700	50.95	-20.53	30.42	43.50	-13.08	QP
4	157.0700	46.30	-17.92	28.38	43.50	-15.12	QP
5	323.9100	45.54	-14.74	30.80	46.00	-15.20	QP
6	381.1400	39.66	-13.62	26.04	46.00	-19.96	QP

- Note: 1. Result Level = Read Level + Antenna Factor + Cable loss.
 2. If Peak Result complies with QP limit, QP Result is deemed to comply with QP limit.
 3. Test setup: RBW: 120 kHz, VBW: 300 kHz, Sweep time: auto

Note: All the modes have been tested, only the worst data was recorded in the report.

8.6. SPURIOUS EMISSIONS BELOW 30 MHz

8.6.1. 8DPSK MODE

(MID CHANNEL, LOOP ANTENNA FACE ON TO THE EUT, WORST-CASE CONFIGURATION)

9 kHz~ 150 kHz

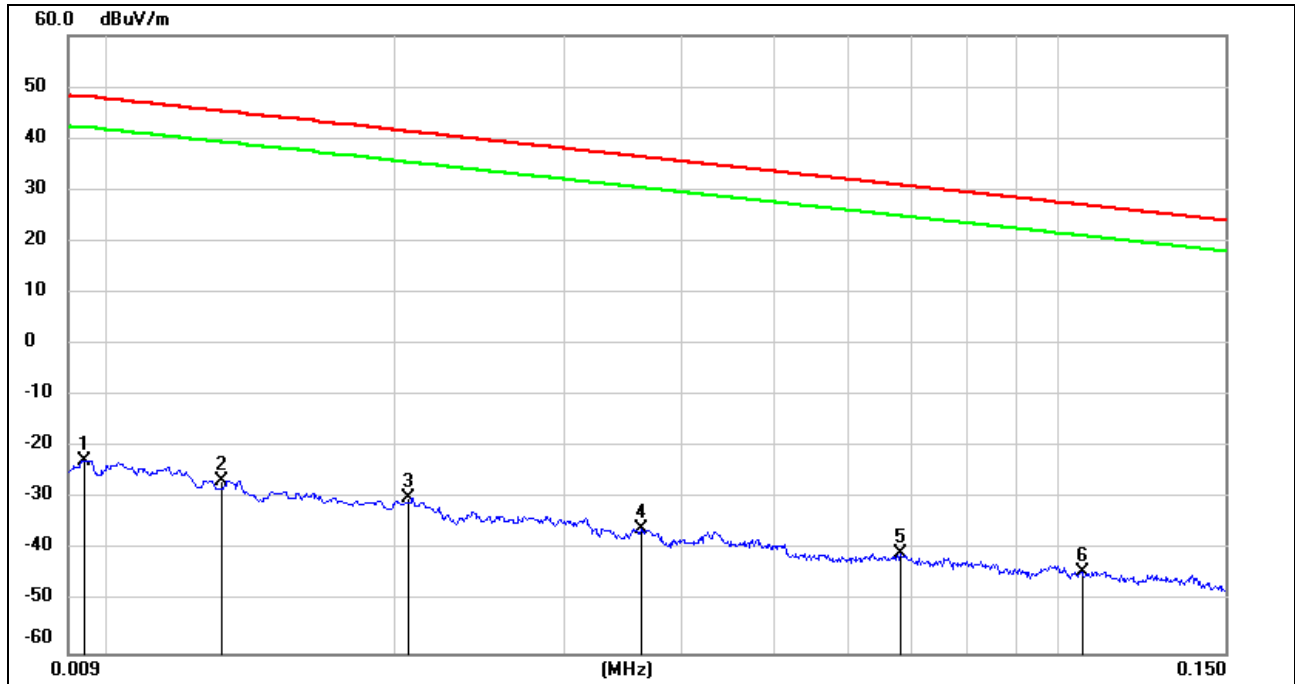

No.	Frequency (MHz)	Reading (dBuV)	Correct (dB/m)	FCC Result (dBuV/m)	FCC Limit (dBuV/m)	ISED Result (dBuA/m)	ISED Limit (dBuA/m)	Margin (dB)	Remark
1	0.0094	78.66	-101.35	-22.69	48.05	-74.19	-3.45	-70.74	peak
2	0.0131	74.97	-101.38	-26.41	45.25	-77.91	-6.25	-71.66	peak
3	0.0206	71.42	-101.35	-29.93	41.32	-81.43	-10.18	-71.25	peak
4	0.0362	65.51	-101.42	-35.91	36.43	-87.41	-15.07	-72.34	peak
5	0.0680	61.04	-101.56	-40.52	30.95	-92.02	-20.55	-71.47	peak
6	0.1058	57.57	-101.78	-44.21	27.11	-95.71	-24.39	-71.32	peak

Note: 1. Measurement = Reading Level + Correct Factor (dBuA/m= dBuV/m- 20Log10[120π] = dBuV/m- 51.5).

2. If Peak Result complies with AV and QP limit, AV and QP Result are deemed to comply with AV limit.

3. All 3 polarizations(Horizontal, Face-on and Face-off) of the loop antenna had been tested, but only the worst data recorded in the report.

150 kHz ~ 490 kHz

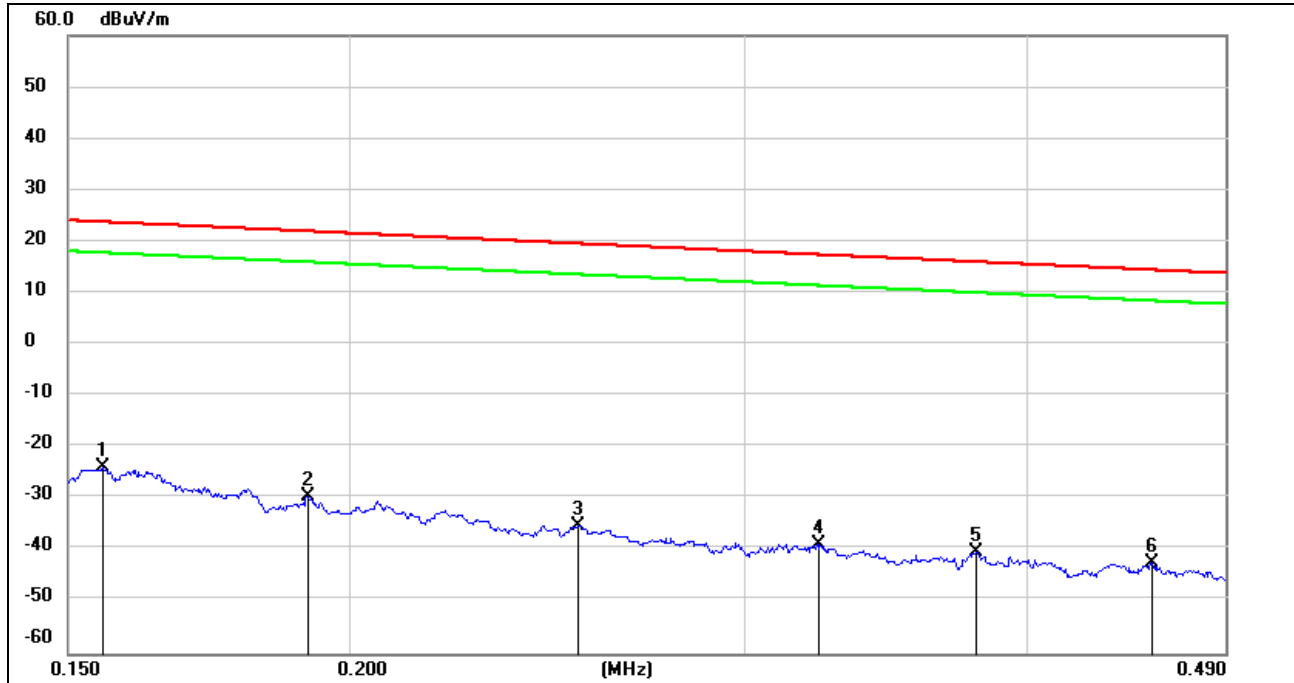

No.	Frequency (MHz)	Reading (dBuV)	Correct (dB/m)	FCC Result (dBuV/m)	FCC Limit (dBuV/m)	ISED Result (dBuA/m)	ISED Limit (dBuA/m)	Margin (dB)	Remark
1	0.1554	77.77	-101.65	-23.88	23.77	-75.38	-27.73	-47.65	peak
2	0.1917	72.04	-101.70	-29.66	21.95	-81.16	-29.55	-51.61	peak
3	0.2530	66.64	-101.80	-35.16	19.54	-86.66	-31.96	-54.70	peak
4	0.3234	62.98	-101.88	-38.90	17.41	-90.40	-34.09	-56.31	peak
5	0.3800	61.52	-101.94	-40.42	16.01	-91.92	-35.49	-56.43	peak
6	0.4550	59.64	-102.02	-42.38	14.44	-93.88	-37.06	-56.82	peak

Note: 1. Measurement = Reading Level + Correct Factor (dBuA/m= dBuV/m- 20Log10[120π] = dBuV/m- 51.5).

2. If Peak Result complies with AV and QP limit, AV and QP Result are deemed to comply with AV limit.

3. All 3 polarizations(Horizontal, Face-on and Face-off) of the loop antenna had been tested, but only the worst data recorded in the report.

490 kHz ~ 30 MHz

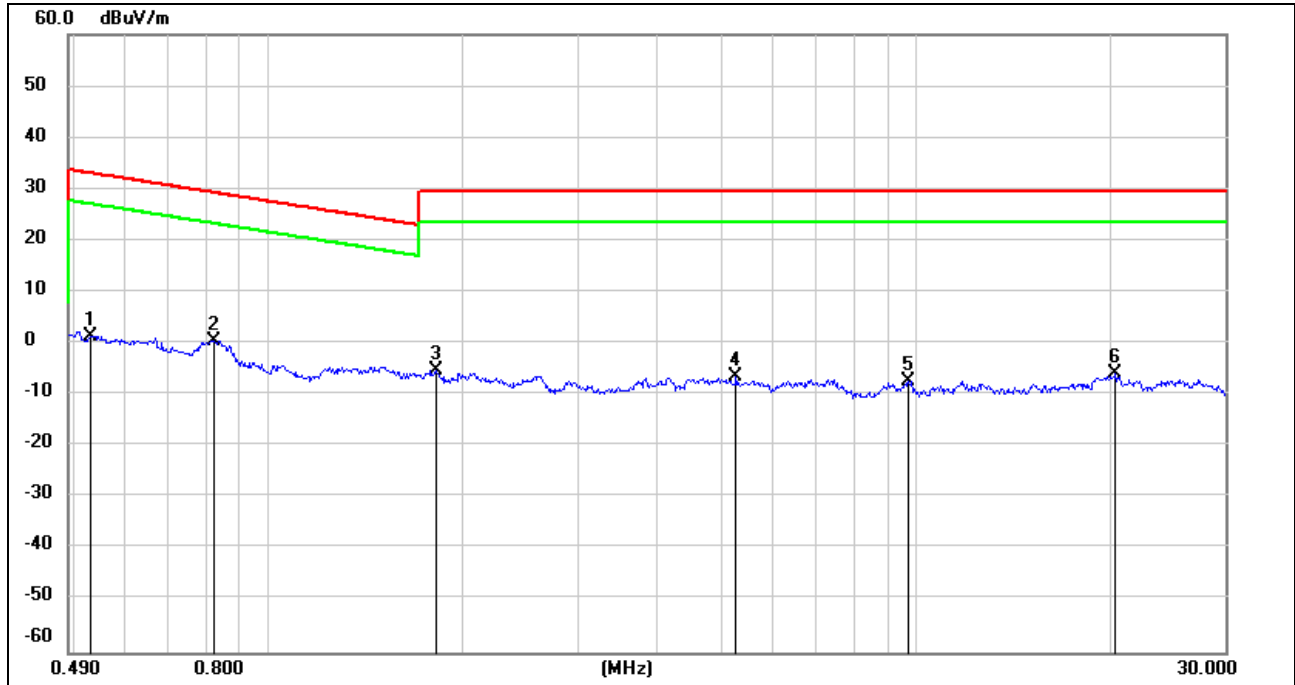

No.	Frequency (MHz)	Reading (dBuV)	Correct (dB/m)	FCC Result (dBuV/m)	FCC Limit (dBuV/m)	ISED Result (dBuA/m)	ISED Limit (dBuA/m)	Margin (dB)	Remark
1	0.5298	63.53	-62.08	1.45	33.12	-50.05	-18.38	-31.67	peak
2	0.8225	62.75	-62.16	0.59	29.30	-50.91	-22.20	-28.71	peak
3	1.8180	56.53	-61.90	-5.37	29.54	-56.87	-21.96	-34.91	peak
4	5.2705	55.04	-61.45	-6.41	29.54	-57.91	-21.96	-35.95	peak
5	9.7263	53.44	-60.84	-7.40	29.54	-58.90	-21.96	-36.94	peak
6	20.3501	54.84	-60.80	-5.96	29.54	-57.46	-21.96	-35.50	peak

Note: 1. Measurement = Reading Level + Correct Factor (dBuA/m= dBuV/m- 20Log10[120π] = dBuV/m- 51.5).

2. If Peak Result complies with AV and QP limit, AV and QP Result are deemed to comply with AV limit.

3. All 3 polarizations(Horizontal, Face-on and Face-off) of the loop antenna had been tested, but only the worst data recorded in the report.

Note: All the modes have been tested, only the worst data was recorded in the report.

9. AC POWER LINE CONDUCTED EMISSIONS

LIMITS

Please refer to CFR 47 FCC §15.207 (a) and ISED RSS-Gen Clause 8.8

FREQUENCY (MHz)	Quasi-peak	Average
0.15 -0.5	66 - 56 *	56 - 46 *
0.50 -5.0	56.00	46.00
5.0 -30.0	60.00	50.00

TEST SETUP AND PROCEDURE

Refer to ANSI C63.10-2013 clause 6.2.

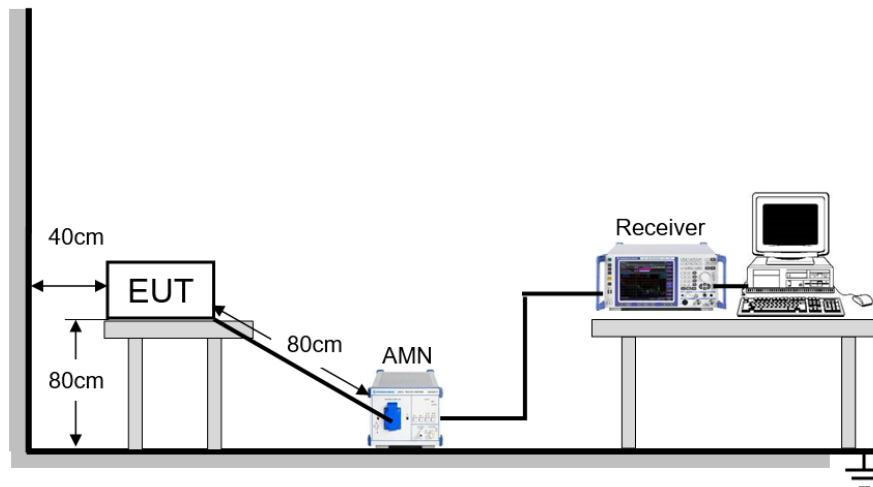

The EUT is put on a table of non-conducting material that is 80 cm high. The vertical conducting wall of shielding is located 40 cm to the rear of the EUT. The power line of the EUT is connected to the AC mains through a Artificial Mains Network (A.M.N.). A EMI Measurement Receiver (R&S Test Receiver ESR3) is used to test the emissions from both sides of AC line. According to the requirements in Section 6.2 of ANSI C63.10-2013. Conducted emissions from the EUT measured in the frequency range between 0.15 MHz and 30 MHz using CISPR Quasi-Peak and average detector mode. The bandwidth of EMI test receiver is set at 9 kHz.

The arrangement of the equipment is installed to meet the standards and operating in a manner, which tends to maximize its emission characteristics in a normal application.

TEST ENVIRONMENT

Temperature	22.7 °C	Relative Humidity	54.6 %
Atmosphere Pressure	101 kPa	Test Voltage	AC 120 V, 60 Hz

TEST RESULTS

9.1. 8DPSK MODE

LINE L RESULTS (MID CHANNEL, WORST-CASE CONFIGURATION)

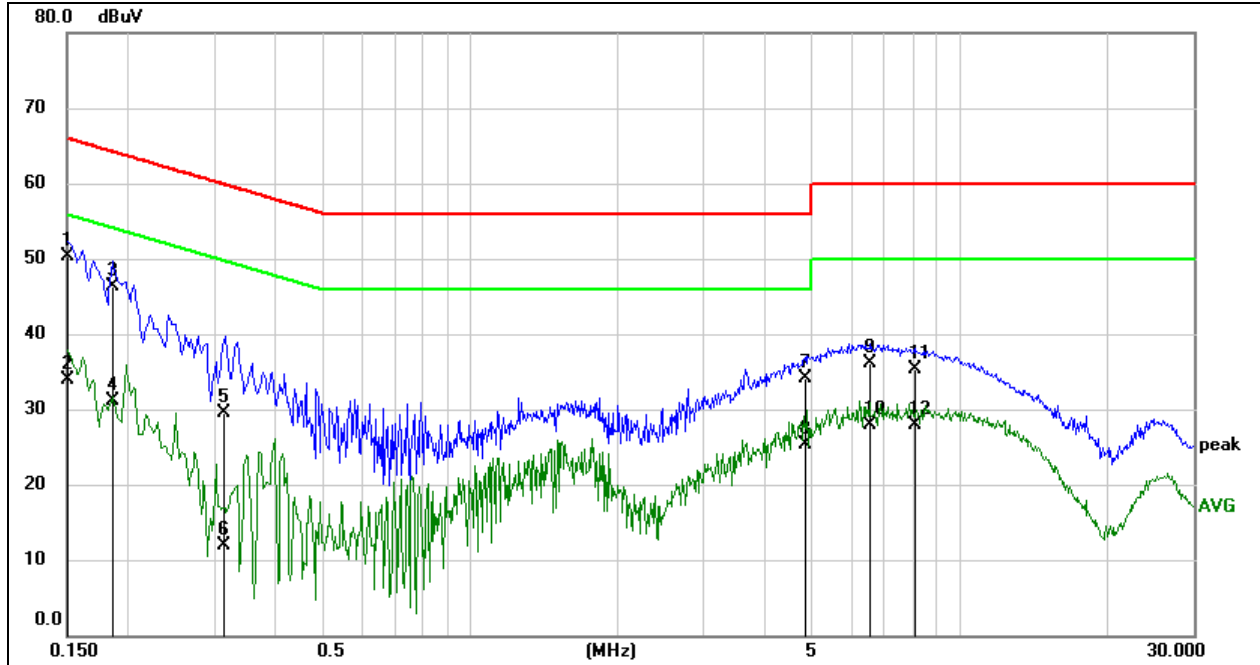

No.	Frequency (MHz)	Reading (dBuV)	Correct (dB)	Result (dBuV)	Limit (dBuV)	Margin (dB)	Remark
1	0.1503	50.74	-0.50	50.24	65.98	-15.74	QP
2	0.1503	34.39	-0.50	33.89	55.98	-22.09	AVG
3	0.1849	46.80	-0.50	46.30	64.26	-17.96	QP
4	0.1849	31.53	-0.50	31.03	54.26	-23.23	AVG
5	0.3133	30.10	-0.50	29.60	59.88	-30.28	QP
6	0.3133	12.45	-0.50	11.95	49.88	-37.93	AVG
7	4.8481	34.48	-0.30	34.18	56.00	-21.82	QP
8	4.8481	25.64	-0.30	25.34	46.00	-20.66	AVG
9	6.5766	36.22	-0.14	36.08	60.00	-23.92	QP
10	6.5766	27.96	-0.14	27.82	50.00	-22.18	AVG
11	8.0591	35.52	-0.17	35.35	60.00	-24.65	QP
12	8.0591	28.01	-0.17	27.84	50.00	-22.16	AVG

- Note: 1. Result = Reading + Correct Factor.
 2. If QP Result complies with AV limit, AV Result is deemed to comply with AV limit.
 3. Test setup: RBW: 200 Hz (9 kHz ~ 150 kHz), 9 kHz (150 kHz ~ 30 MHz).
 4. Step size: 80 Hz (0.009 MHz ~ 0.15 MHz), 4 kHz (0.15 MHz ~ 30 MHz), Scan time: auto.

LINE N RESULTS (MID CHANNEL, WORST-CASE CONFIGURATION)

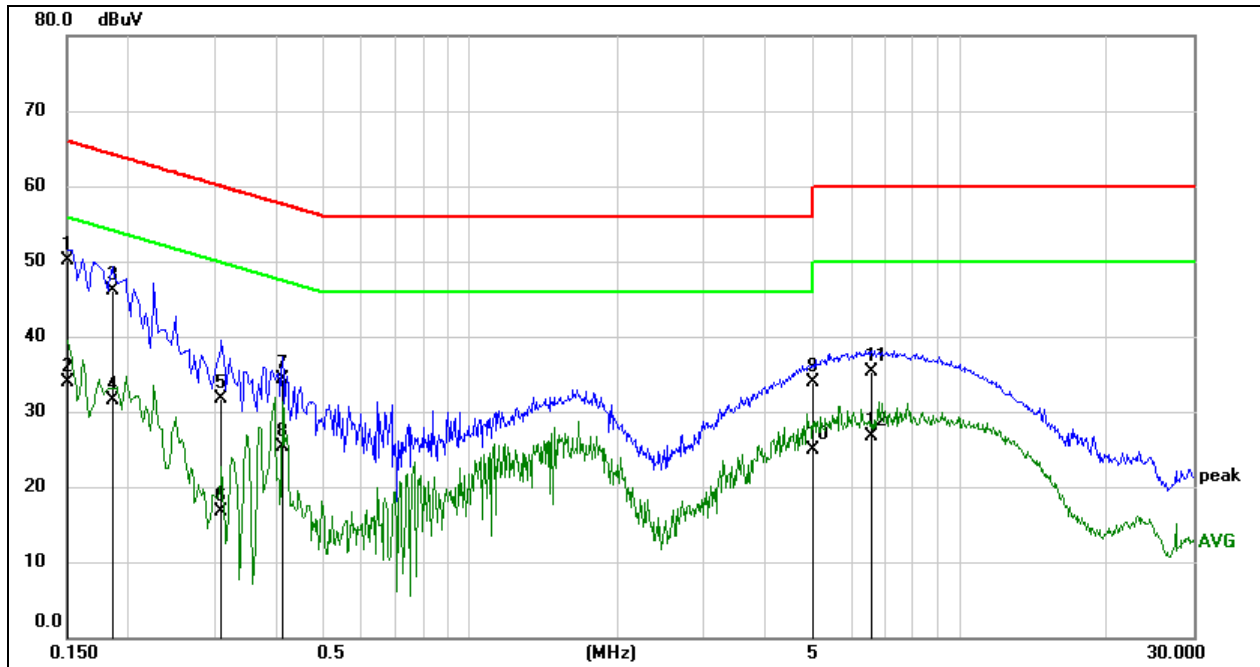

No.	Frequency (MHz)	Reading (dBuV)	Correct (dB)	Result (dBuV)	Limit (dBuV)	Margin (dB)	Remark
1	0.1501	50.57	-0.50	50.07	65.99	-15.92	QP
2	0.1501	34.32	-0.50	33.82	55.99	-22.17	AVG
3	0.1870	46.51	-0.50	46.01	64.17	-18.16	QP
4	0.1870	32.06	-0.50	31.56	54.17	-22.61	AVG
5	0.3089	32.30	-0.50	31.80	60.00	-28.20	QP
6	0.3089	17.20	-0.50	16.70	50.00	-33.30	AVG
7	0.4123	34.77	-0.50	34.27	57.60	-23.33	QP
8	0.4123	25.85	-0.50	25.35	47.60	-22.25	AVG
9	5.0142	34.15	-0.30	33.85	60.00	-26.15	QP
10	5.0142	25.29	-0.30	24.99	50.00	-25.01	AVG
11	6.6116	35.50	-0.14	35.36	60.00	-24.64	QP
12	6.6116	26.77	-0.14	26.63	50.00	-23.37	AVG

- Note: 1. Result = Reading + Correct Factor.
 2. If QP Result complies with AV limit, AV Result is deemed to comply with AV limit.
 3. Test setup: RBW: 200 Hz (9 kHz ~ 150 kHz), 9 kHz (150 kHz ~ 30 MHz).
 4. Step size: 80 Hz (0.009 MHz ~ 0.15 MHz), 4 kHz (0.15 MHz ~ 30 MHz), Scan time: auto.

Note: All the modes have been tested, only the worst data was recorded in the report.



10. ANTENNA REQUIREMENTS

APPLICABLE REQUIREMENTS

Please refer to FCC §15.203

An intentional radiator shall be designed to ensure that no antenna other than that furnished by the responsible party shall be used with the device. The use of a permanently attached antenna or of an antenna that uses a unique coupling to the intentional radiator shall be considered sufficient to comply with the provisions of this section. The manufacturer may design the unit so that a broken antenna can be replaced by the user, but the use of a standard antenna jack or electrical connector is prohibited.

Please refer to FCC §15.247(b)(4)

The conducted output power limit specified in paragraph (b) of this section is based on the use of antennas with directional gains that do not exceed 6 dBi. Except as shown in paragraph (c) of this section, if transmitting antennas of directional gain greater than 6 dBi are used, the conducted output power from the intentional radiator shall be reduced below the stated values in paragraphs (b)(1), (b)(2), and (b)(3) of this section, as appropriate, by the amount in dB that the directional gain of the antenna exceeds 6 dBi.

RESULTS

Complies



11. Appendix

11.1. Appendix A: 20dB Emission Bandwidth

11.1.1. Test Result

Test Packet Type	Antenna	Channel	20db EBW[MHz]	FL[MHz]	FH[MHz]	Verdict
DH5	Ant1	2402	0.942	2401.526	2402.468	PASS
		2441	0.951	2440.523	2441.474	PASS
		2480	0.939	2479.526	2480.465	PASS
3DH5	Ant1	2402	1.251	2401.352	2402.603	PASS
		2441	1.242	2440.358	2441.600	PASS
		2480	1.254	2479.349	2480.603	PASS



11.1.2. Test Graphs



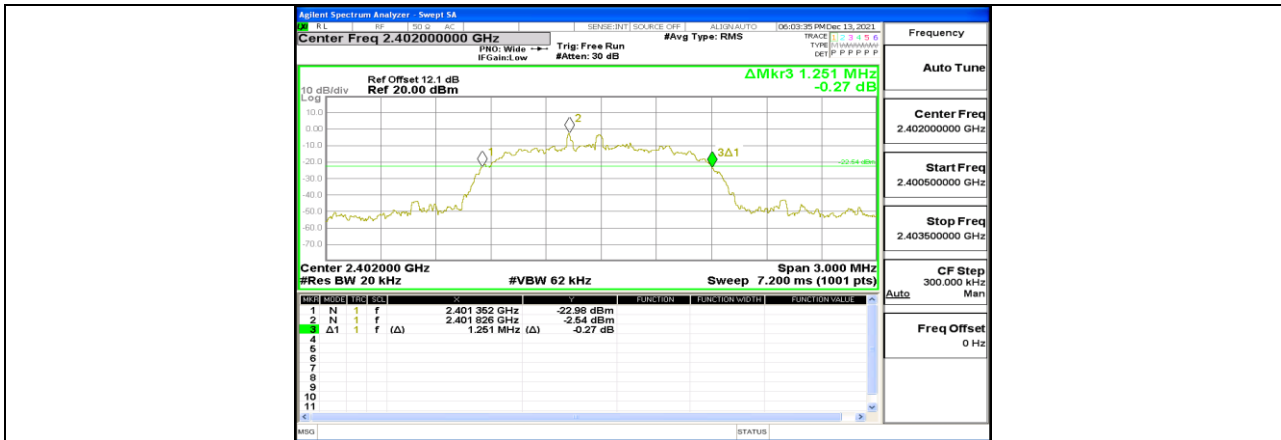

3DH5_Ant1_2402

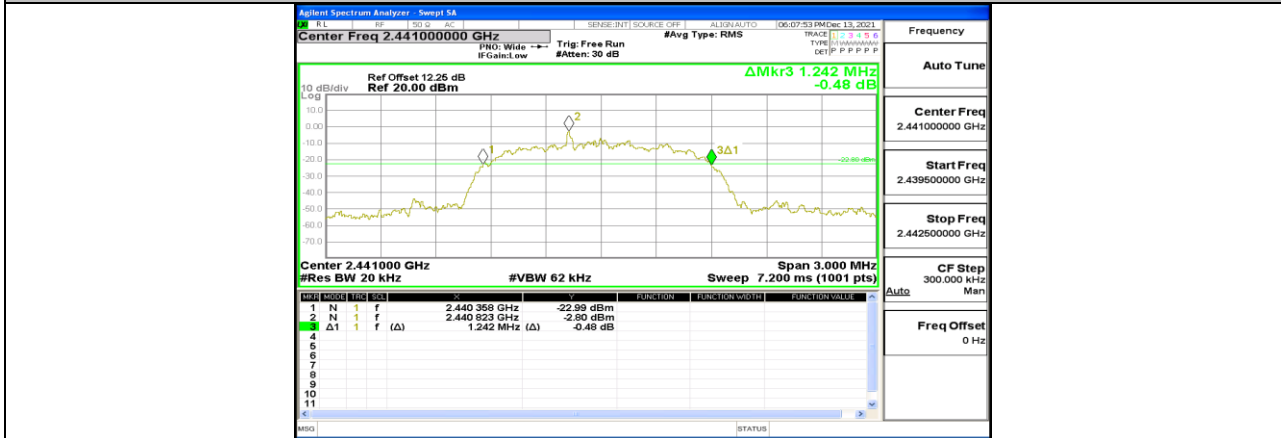

3DH5_Ant1_2441

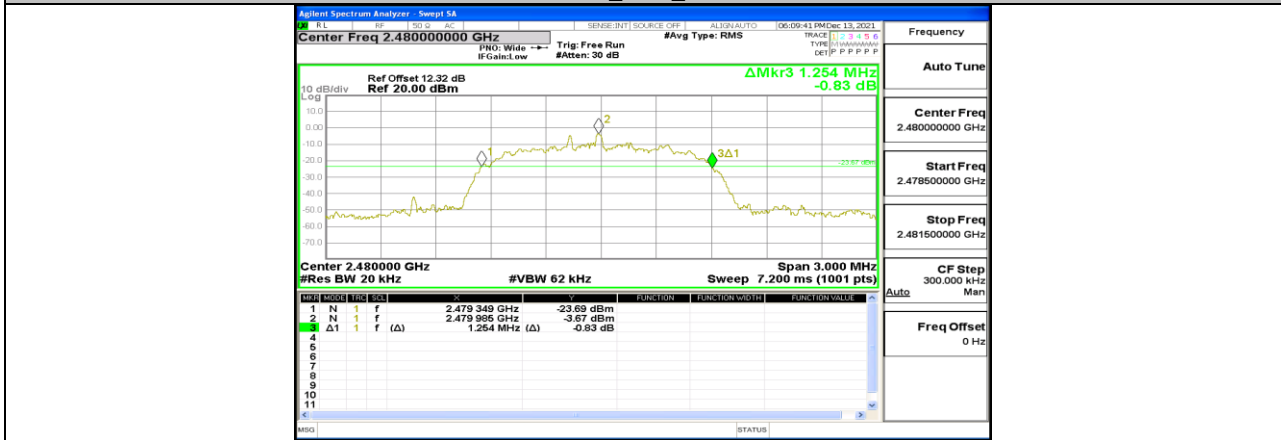

3DH5_Ant1_2480



11.2. Appendix B: Occupied Channel Bandwidth

11.2.1. Test Result

Test Packet Type	Antenna	Channel	OCB [MHz]	FL[MHz]	FH[MHz]	Verdict
DH5	Ant1	2402	0.88030	2401.545	2402.425	PASS
		2441	0.87854	2440.543	2441.421	PASS
		2480	0.89949	2479.540	2480.439	PASS
3DH5	Ant1	2402	1.1718	2401.401	2402.573	PASS
		2441	1.1825	2440.393	2441.576	PASS
		2480	1.1707	2479.400	2480.571	PASS



11.2.2. Test Graphs



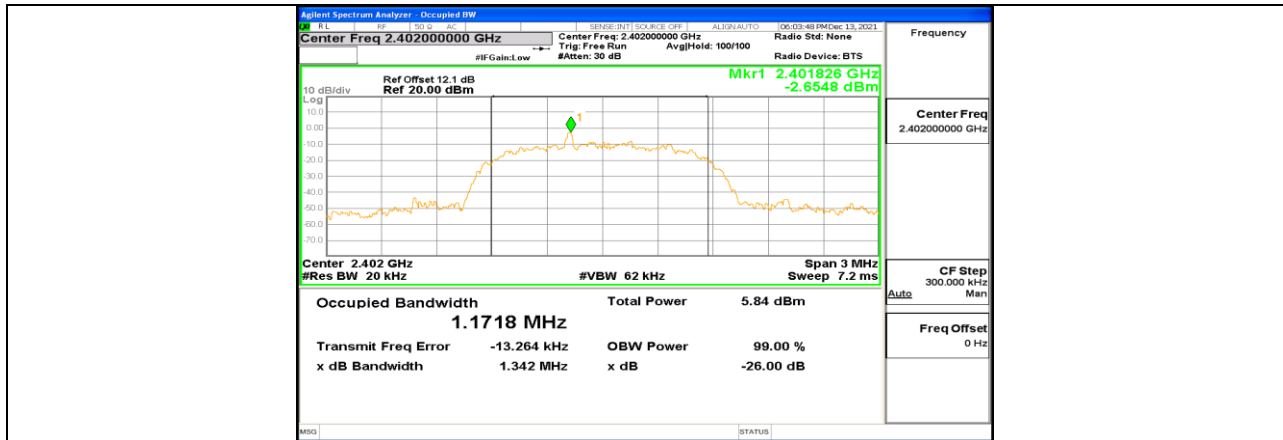

3DH5_Ant1_2402

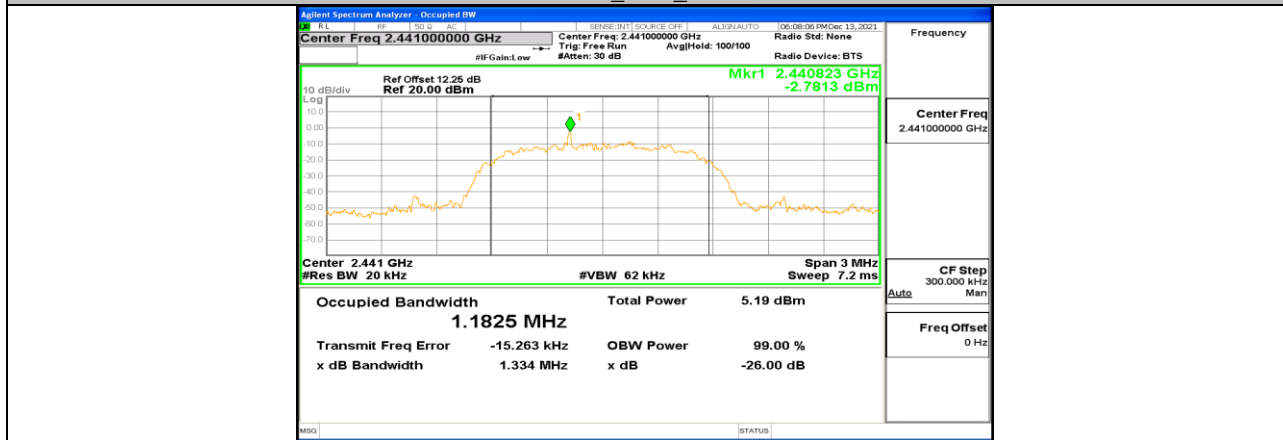

3DH5_Ant1_2441

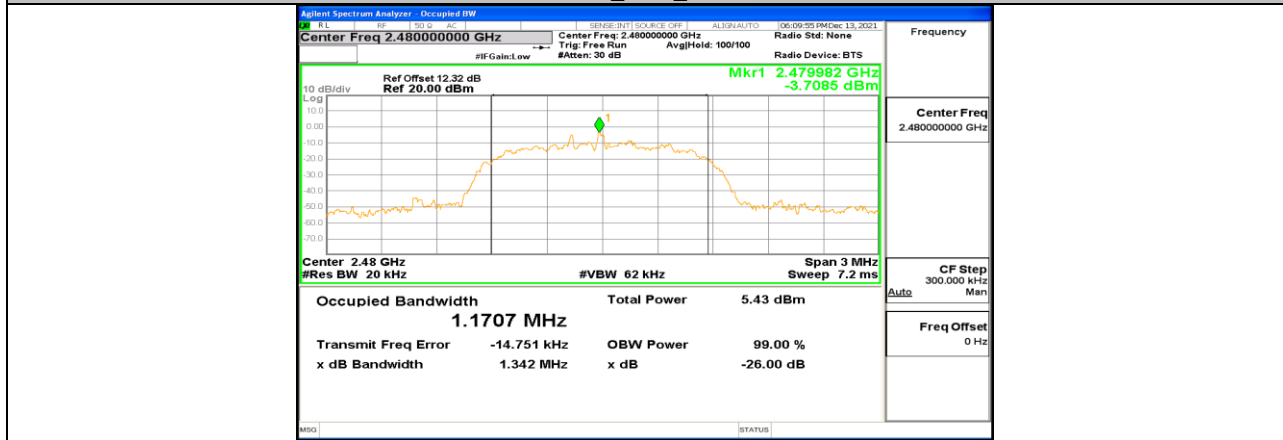

3DH5_Ant1_2480



11.3. Appendix C: Maximum conducted output power

11.3.1. Test Result

Test Packet Type	Antenna	Channel	Result[dBm]	Limit[dBm]	Verdict
DH5	Ant1	2402	0.46	≤20.97	PASS
		2441	0.18	≤20.97	PASS
		2480	0.14	≤20.97	PASS
3DH5	Ant1	2402	1.11	≤20.97	PASS
		2441	0.82	≤20.97	PASS
		2480	0.59	≤20.97	PASS



11.4. Appendix D: Carrier frequency separation

11.4.1. Test Result

Test Packet Type	Antenna	Channel	Result[MHz]	Limit[MHz]	Verdict
DH5	Ant1	Hop	1.232	≥ 0.951	PASS
3DH5	Ant1	Hop	1.268	≥ 1.254	PASS



11.4.2. Test Graphs

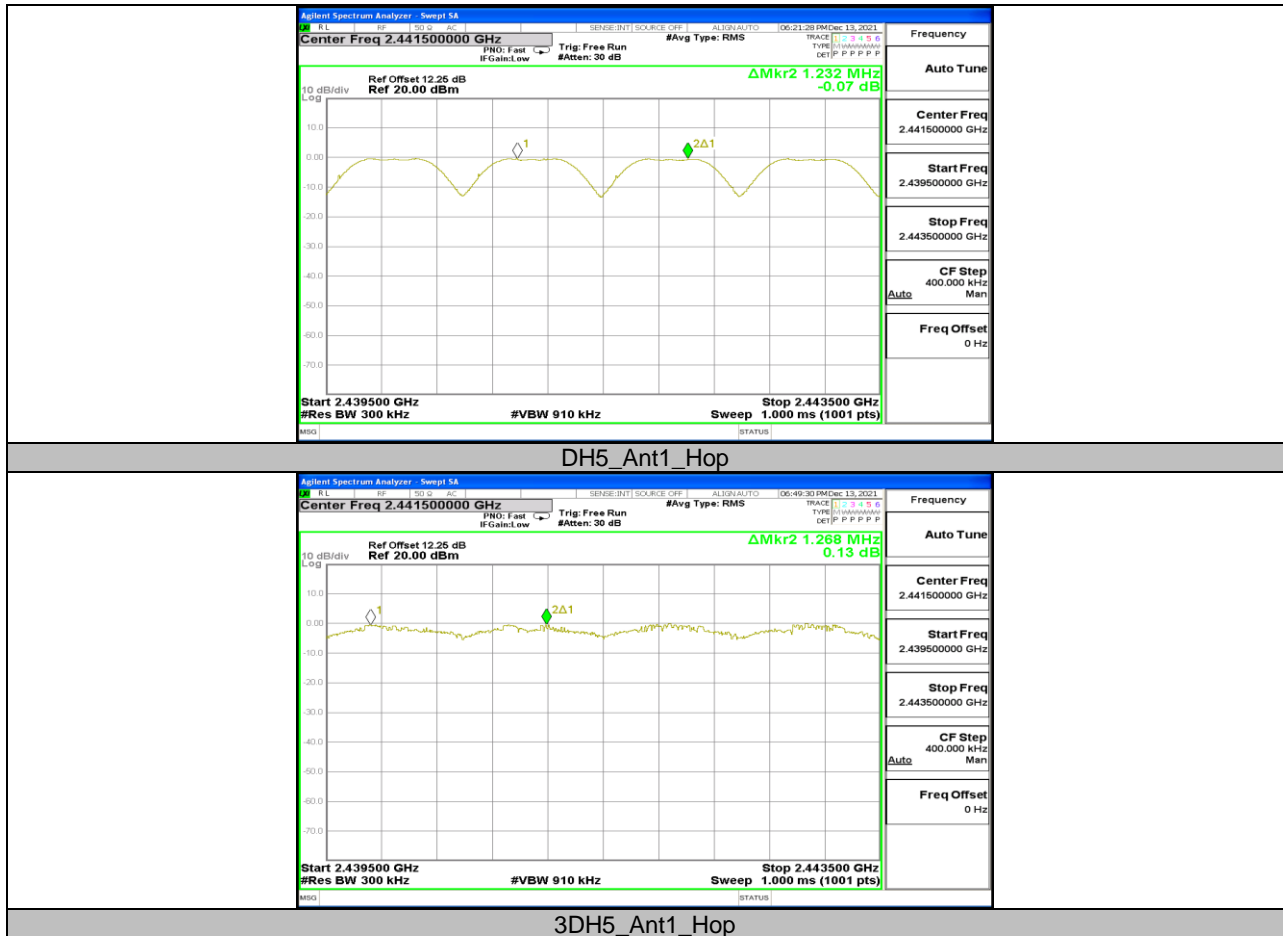

11.5. Appendix E: Time of occupancy

11.5.1. Test Result

FHSS Mode						
Test Packet Type	Antenna	Channel	BurstWidth [ms]	Result[s]	Limit[s]	Verdict
DH1	Ant1	Hop	0.37	0.118	<=0.4	PASS
DH3	Ant1	Hop	1.62	0.259	<=0.4	PASS
DH5	Ant1	Hop	2.87	0.306	<=0.4	PASS
3DH1	Ant1	Hop	0.38	0.122	<=0.4	PASS
3DH3	Ant1	Hop	1.63	0.261	<=0.4	PASS
3DH5	Ant1	Hop	2.88	0.307	<=0.4	PASS

AFHSS Mode						
Test Packet Type	Antenna	Channel	BurstWidth [ms]	Result[s]	Limit[s]	Verdict
DH1	Ant1	Hop	0.37	0.059	<=0.4	PASS
DH3	Ant1	Hop	1.62	0.130	<=0.4	PASS
DH5	Ant1	Hop	2.87	0.153	<=0.4	PASS
3DH1	Ant1	Hop	0.38	0.061	<=0.4	PASS
3DH3	Ant1	Hop	1.63	0.130	<=0.4	PASS
3DH5	Ant1	Hop	2.88	0.154	<=0.4	PASS



11.5.2. Test Graphs



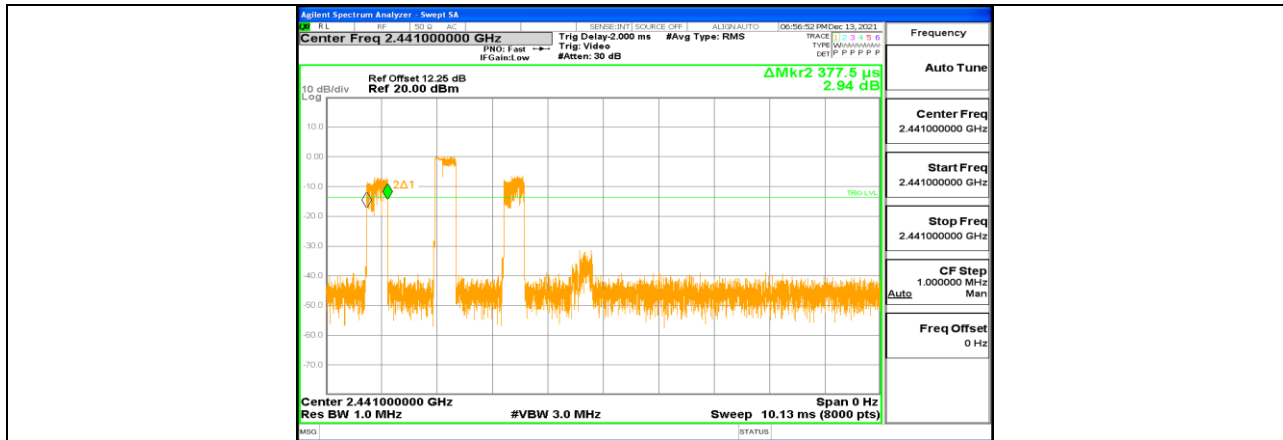

3DH1_Ant1_Hop

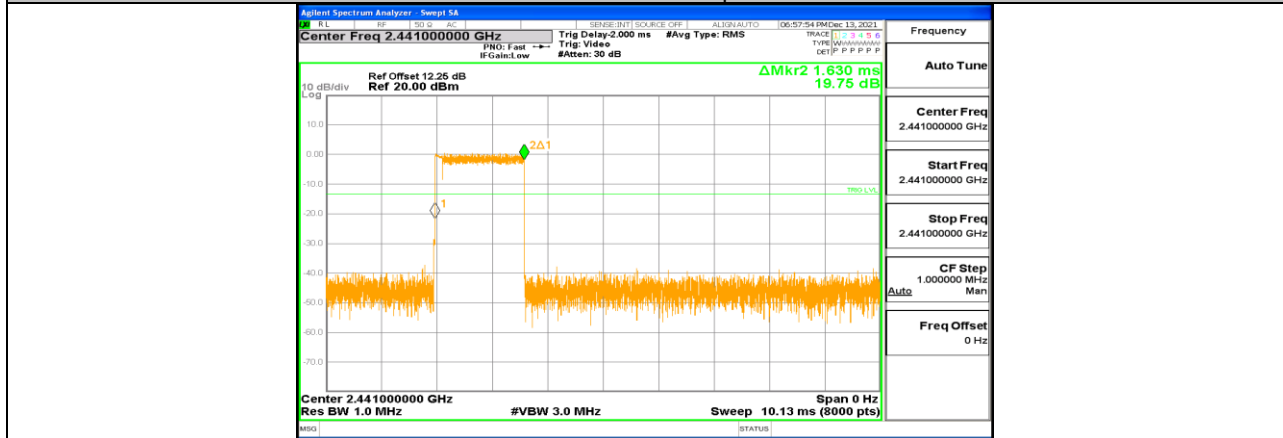

3DH3_Ant1_Hop

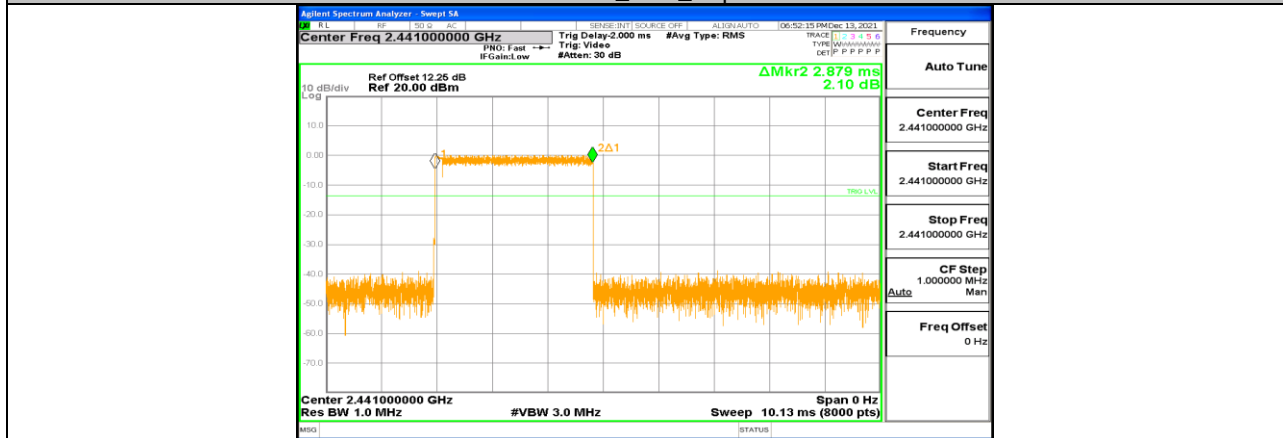

3DH5_Ant1_Hop



11.6. Appendix F: Number of hopping channels

11.6.1. Test Result

Test Packet Type	Antenna	Channel	Result[Num]	Limit[Num]	Verdict
DH5	Ant1	Hop	79	≥ 15	PASS
3DH5	Ant1	Hop	79	≥ 15	PASS

11.6.2. Test Graphs

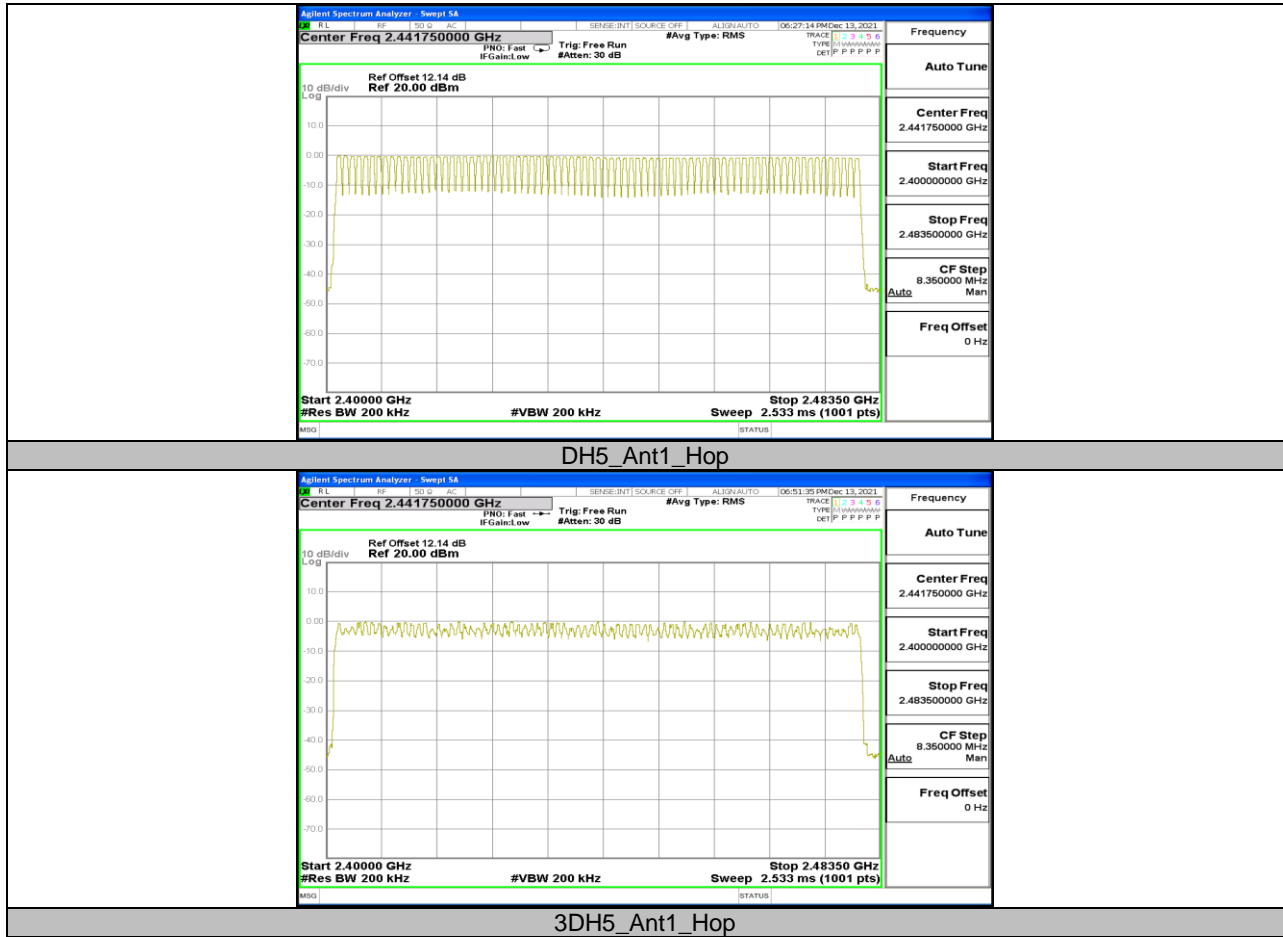

11.7. Appendix G: Band edge measurements

11.7.1. Test Result

Test Packet Type	Antenna	ChName	Channel	RefLevel [dBm]	Result [dBm]	Limit [dBm]	Verdict
DH5	Ant1	Low	2402	-0.36	-46.61	≤ -20.36	PASS
		High	2480	-0.89	-46.36	≤ -20.89	PASS
		Low	Hop_2402	-0.36	-45.43	≤ -20.36	PASS
		High	Hop_2480	-0.75	-46.39	≤ -20.75	PASS
3DH5	Ant1	Low	2402	-0.32	-45.54	≤ -20.32	PASS
		High	2480	-0.90	-46.06	≤ -20.9	PASS
		Low	Hop_2402	-3.43	-46.37	≤ -23.43	PASS
		High	Hop_2480	-3.64	-45.78	≤ -23.64	PASS

11.7.2. Test Graphs



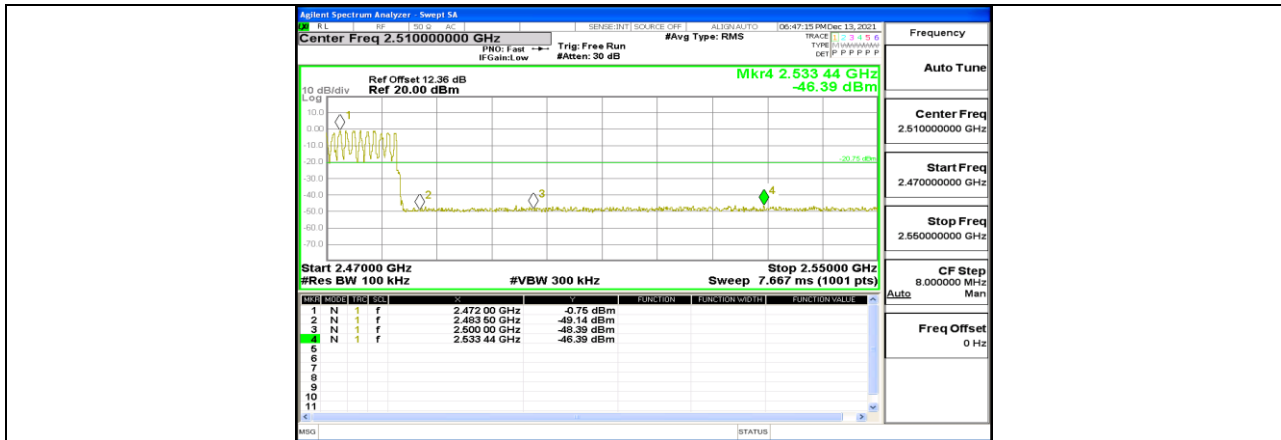

DH5_Ant1_High_Hop_2480

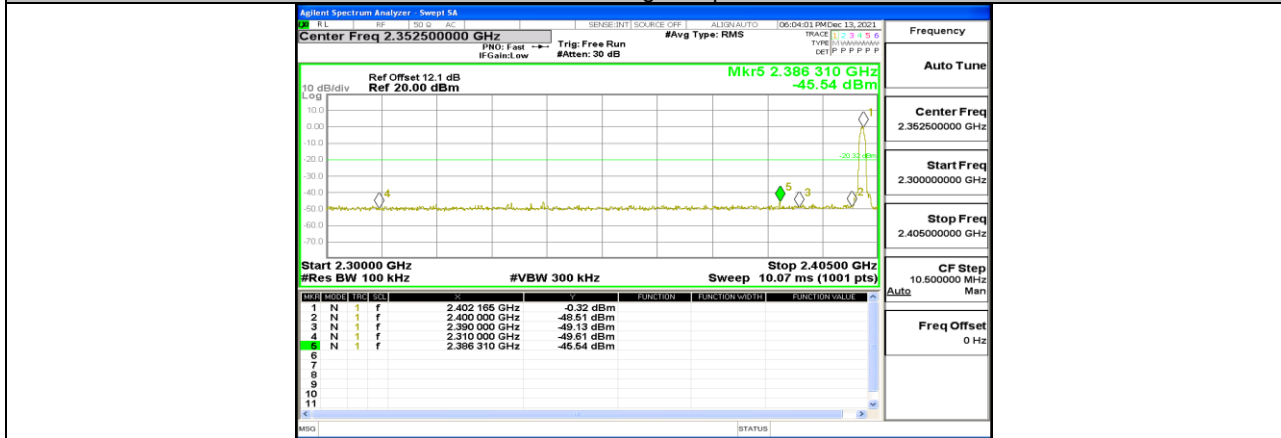

3DH5_Ant1_Low_2402

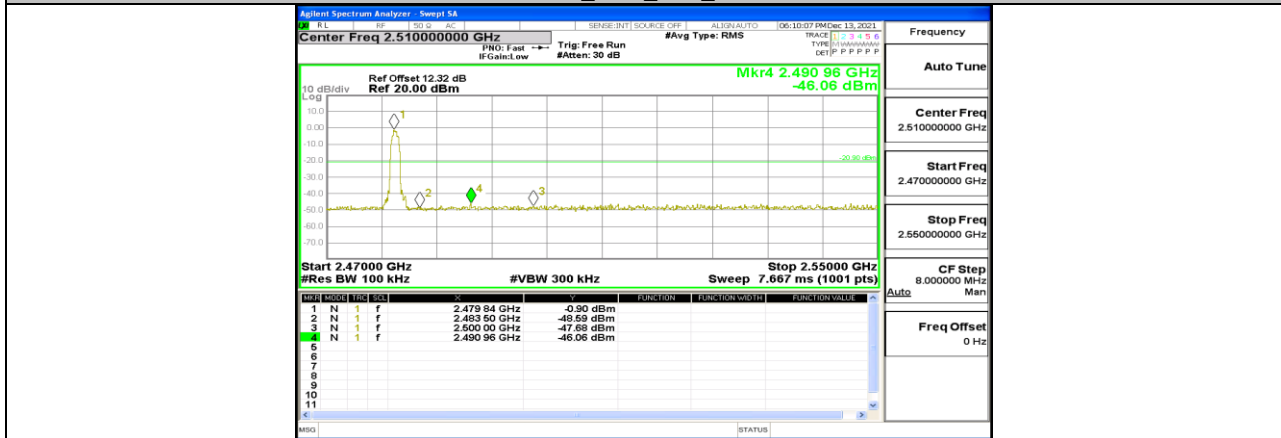

3DH5_Ant1_High_2480

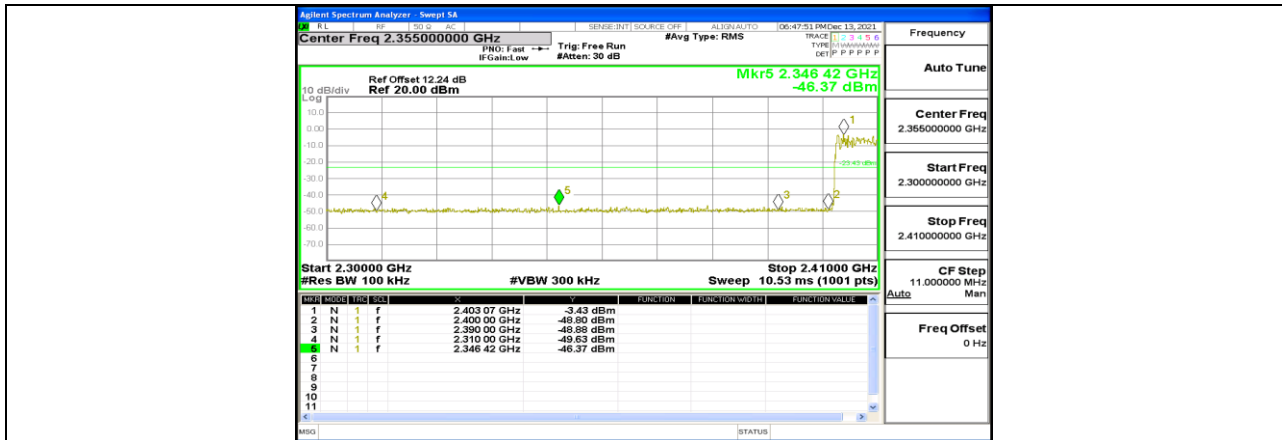

3DH5_Ant1_Low_Hop_2402

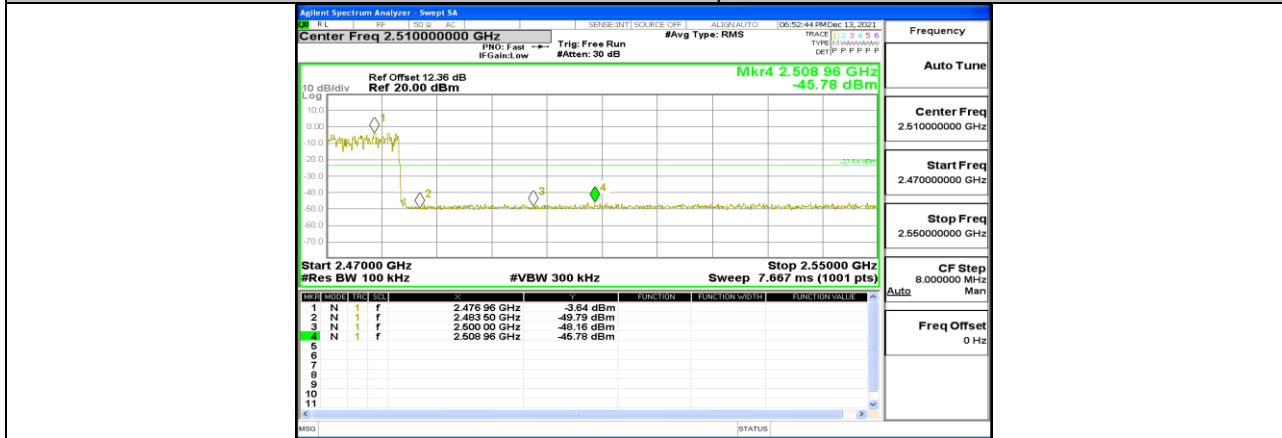

3DH5_Ant1_High_Hop_2480

11.8. Appendix H: Conducted Spurious Emission
11.8.1. Test Result

Test Packet Type	Antenna	Channel	FreqRange [MHz]	Result [dBm]	Limit [dBm]	Verdict
DH5	Ant1	2402	Reference	-0.52	---	PASS
			30~1000	-59.03	≤-20.52	PASS
			1000~26500	-47.58	≤-20.52	PASS
		2441	Reference	-1.55	---	PASS
			30~1000	-58.62	≤-21.55	PASS
			1000~26500	-47.01	≤-21.55	PASS
		2480	Reference	-1.29	---	PASS
			30~1000	-57.68	≤-21.29	PASS
			1000~26500	-46.65	≤-21.29	PASS
3DH5	Ant1	2402	Reference	-2.95	---	PASS
			30~1000	-58.97	≤-22.95	PASS
			1000~26500	-46.53	≤-22.95	PASS
		2441	Reference	-3.88	---	PASS
			30~1000	-57.95	≤-23.88	PASS
			1000~26500	-46.84	≤-23.88	PASS
		2480	Reference	-1.99	---	PASS
			30~1000	-57.85	≤-21.99	PASS
			1000~26500	-47.23	≤-21.99	PASS



11.8.2. Test Graphs

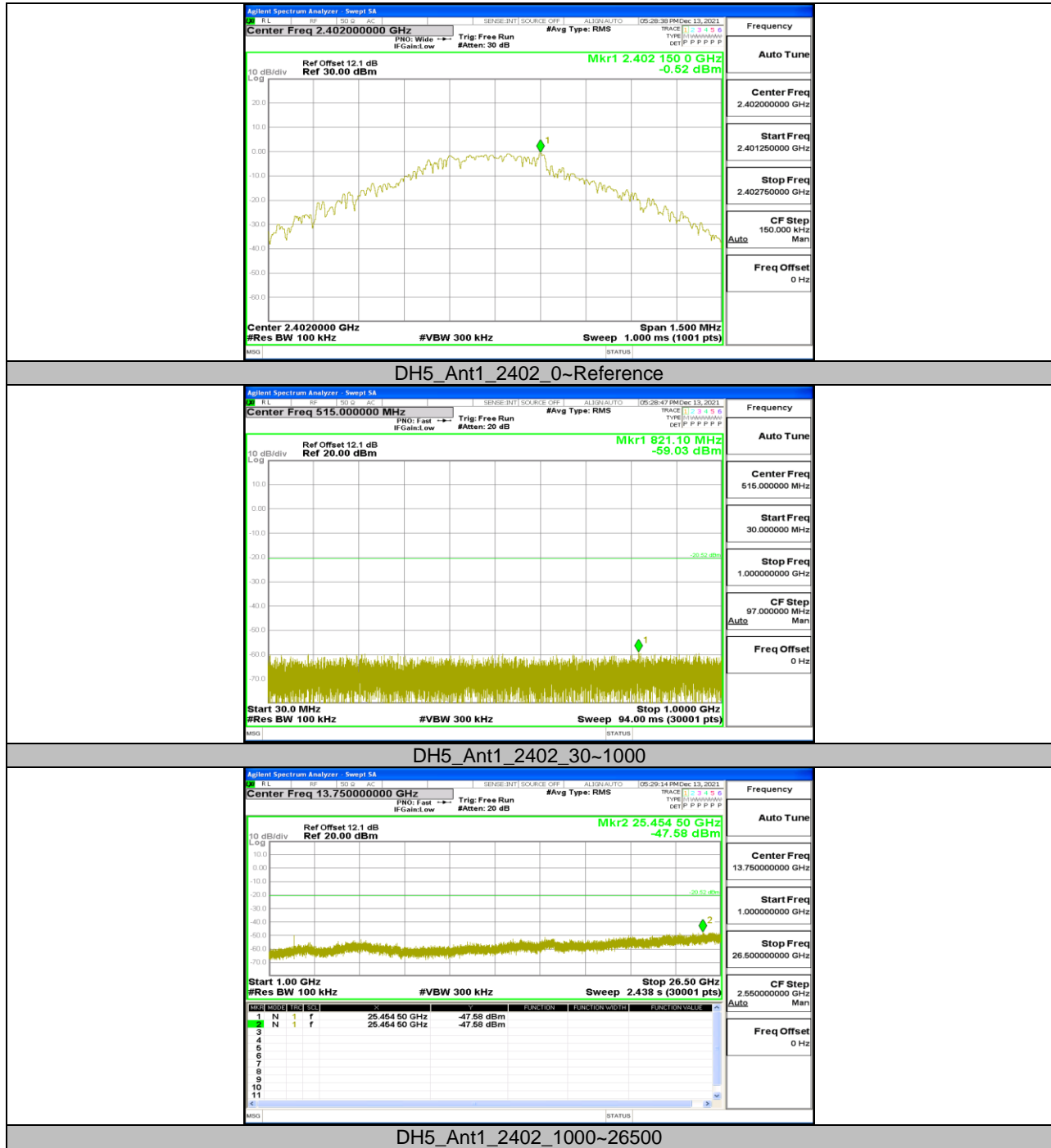



DH5_Ant1_2441_0-Reference

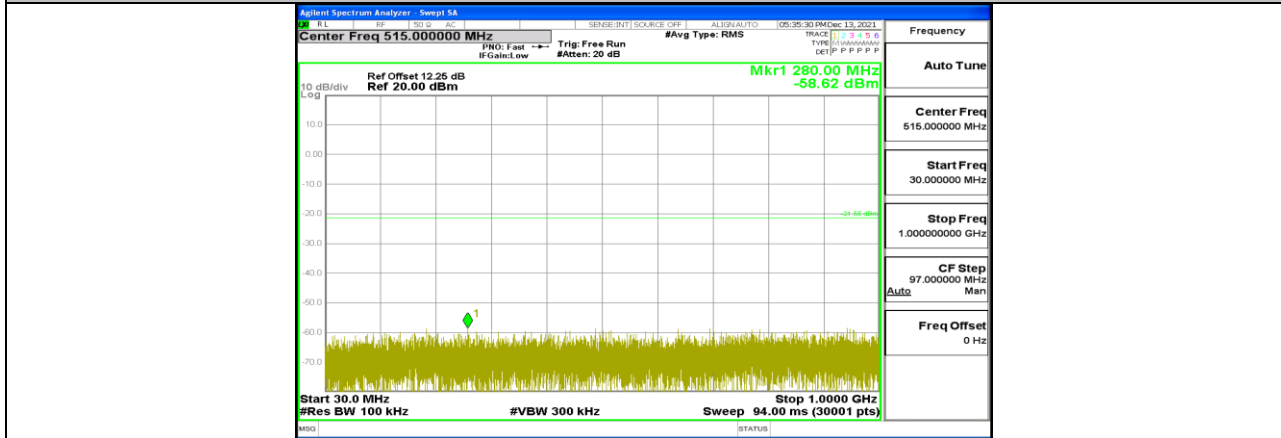

DH5_Ant1_2441_30-1000

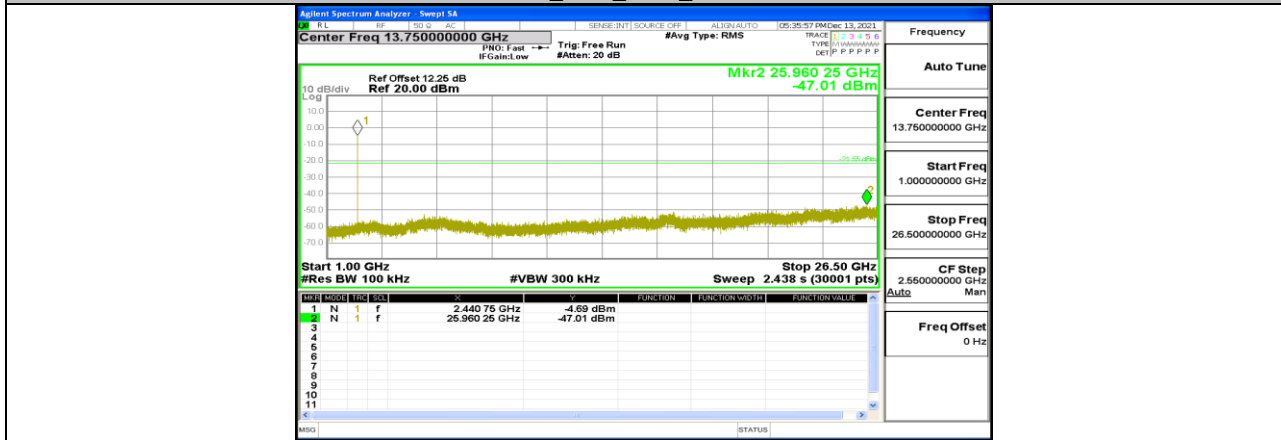

DH5_Ant1_2441_1000-26500

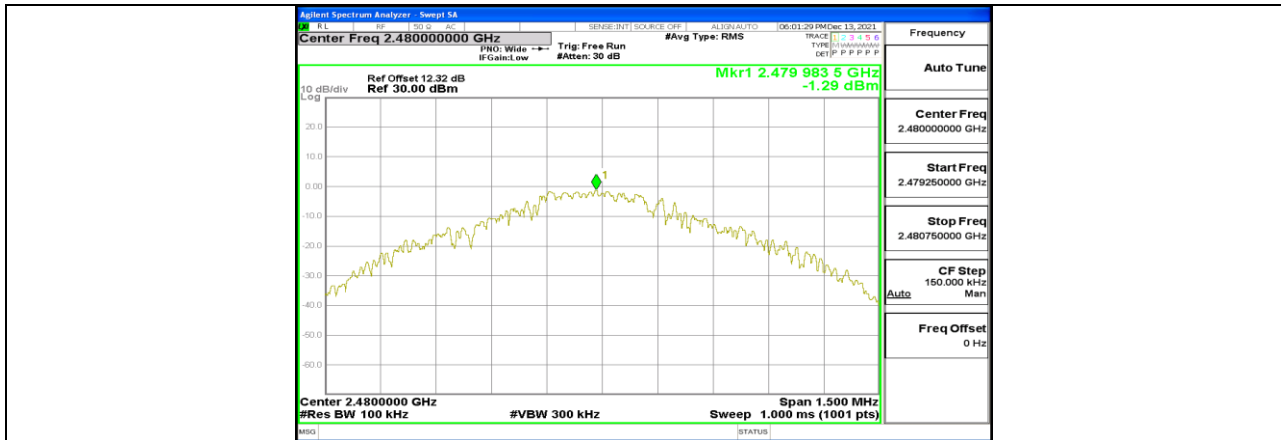

DH5_Ant1_2480_0-Reference

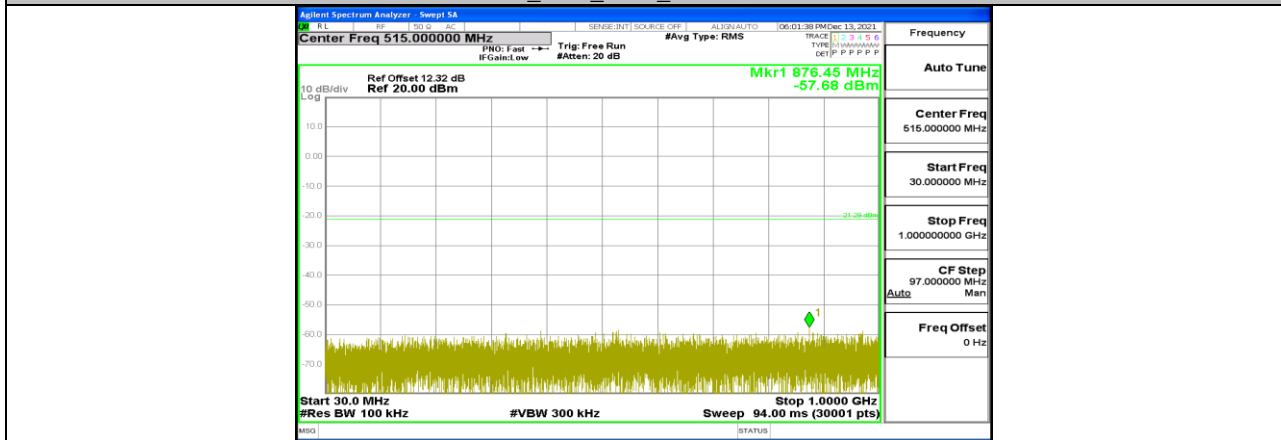

DH5_Ant1_2480_30-1000

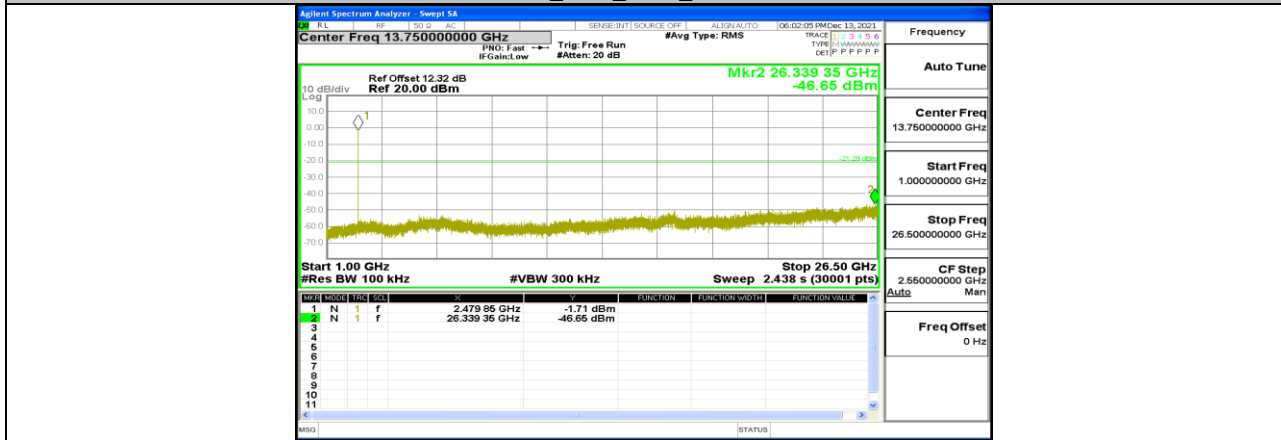

DH5_Ant1_2480_1000-26500

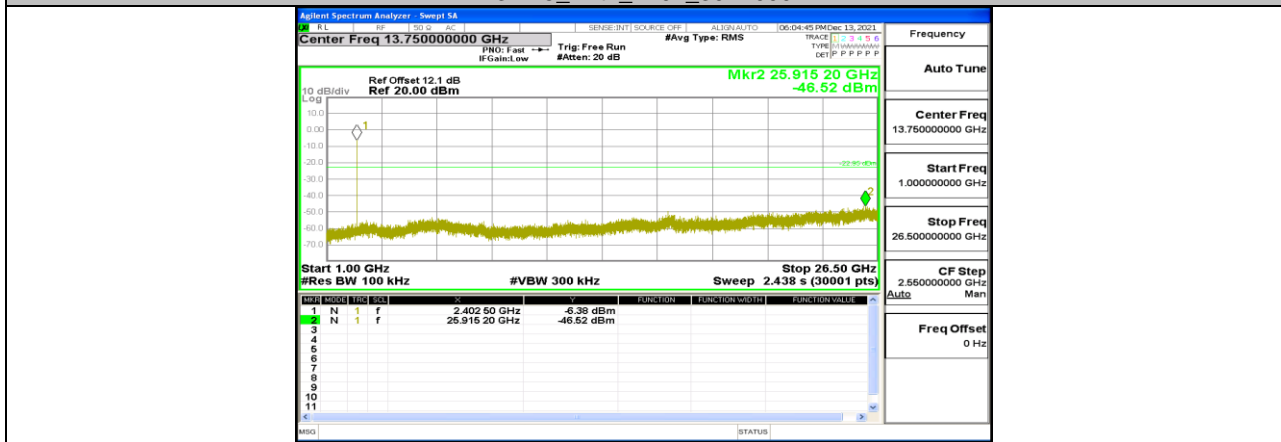
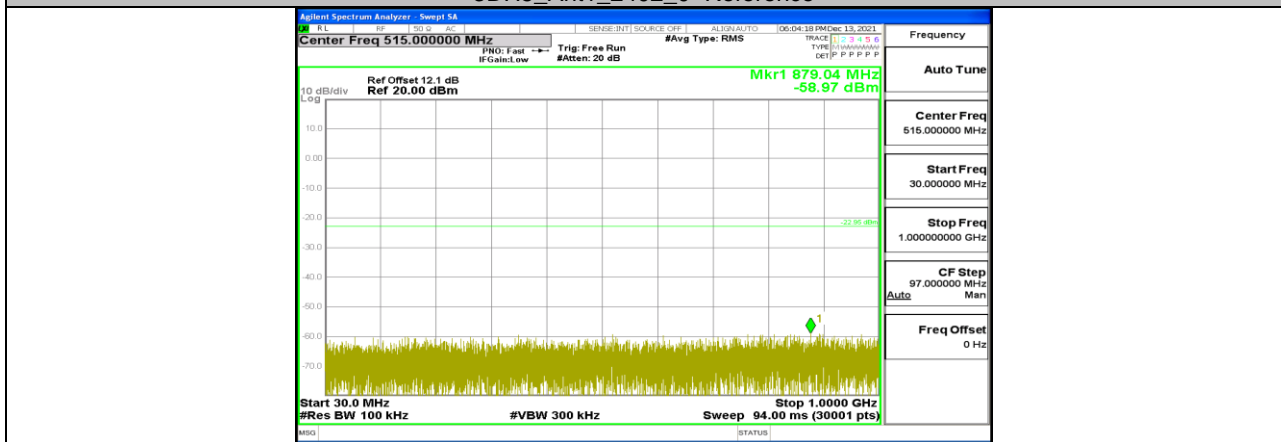
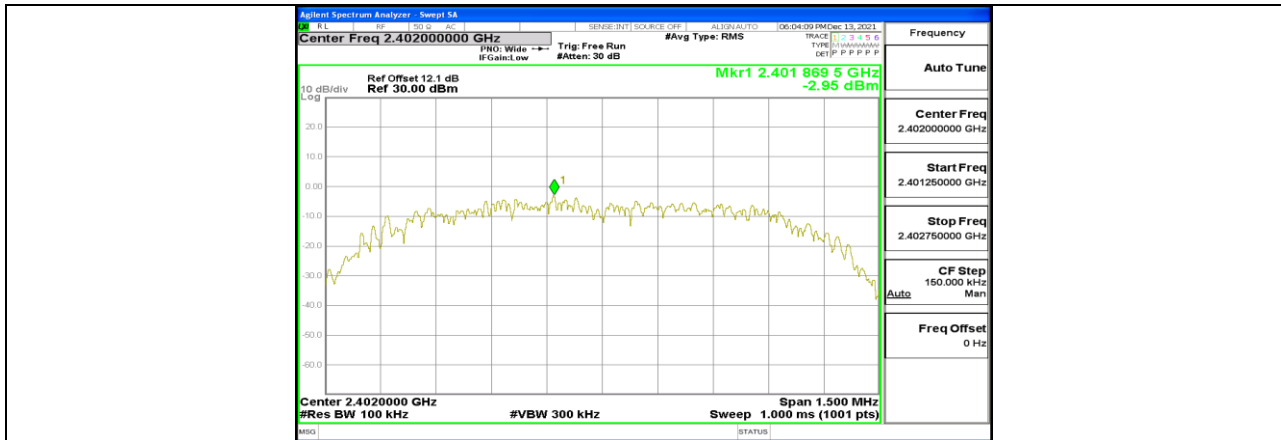

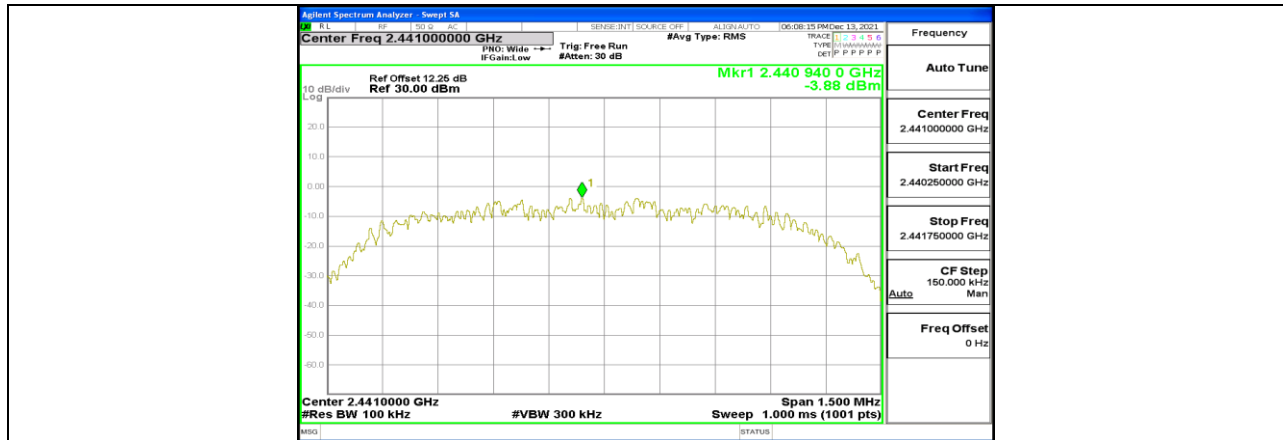

3DH5_Ant1_2441_0~Reference

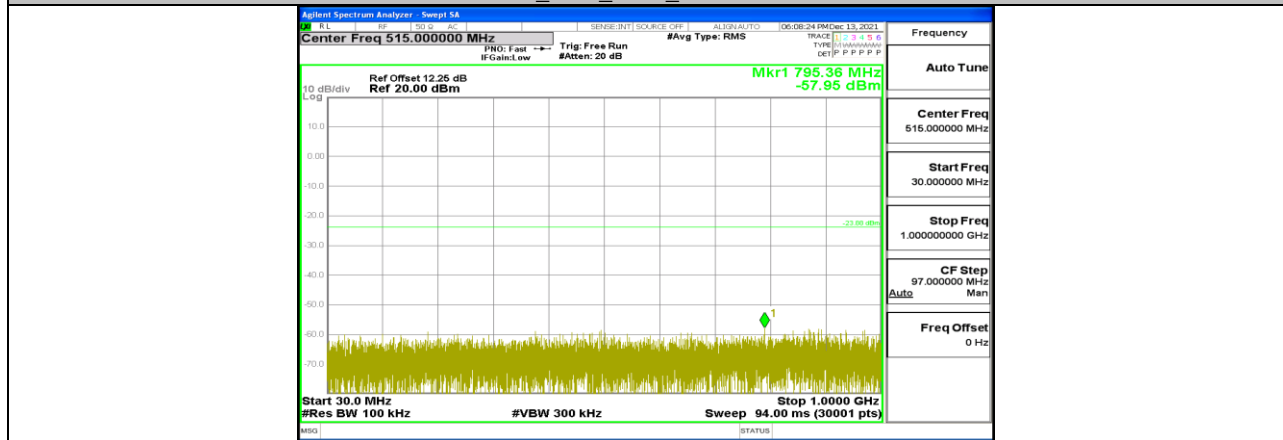

3DH5_Ant1_2441_30~1000

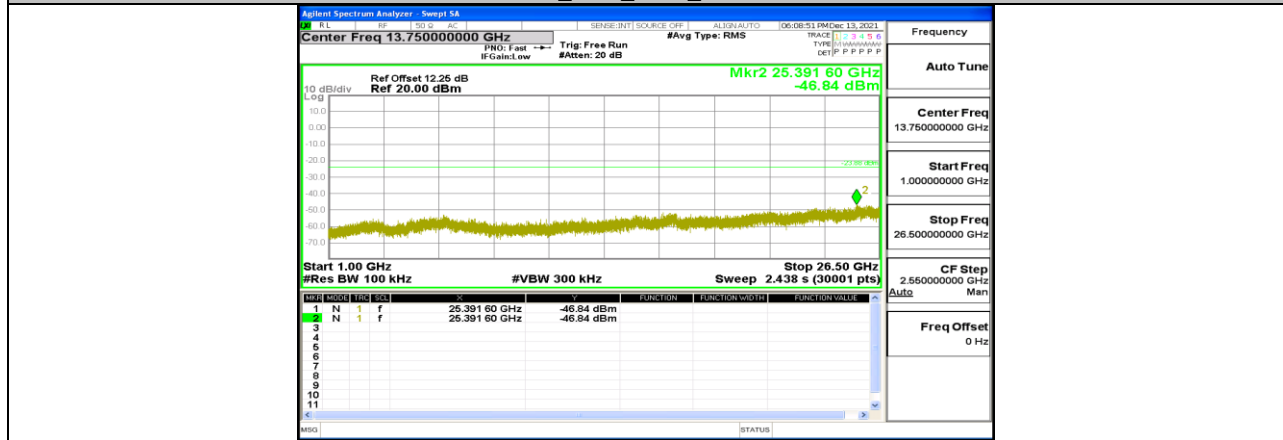

3DH5_Ant1_2441_1000~26500

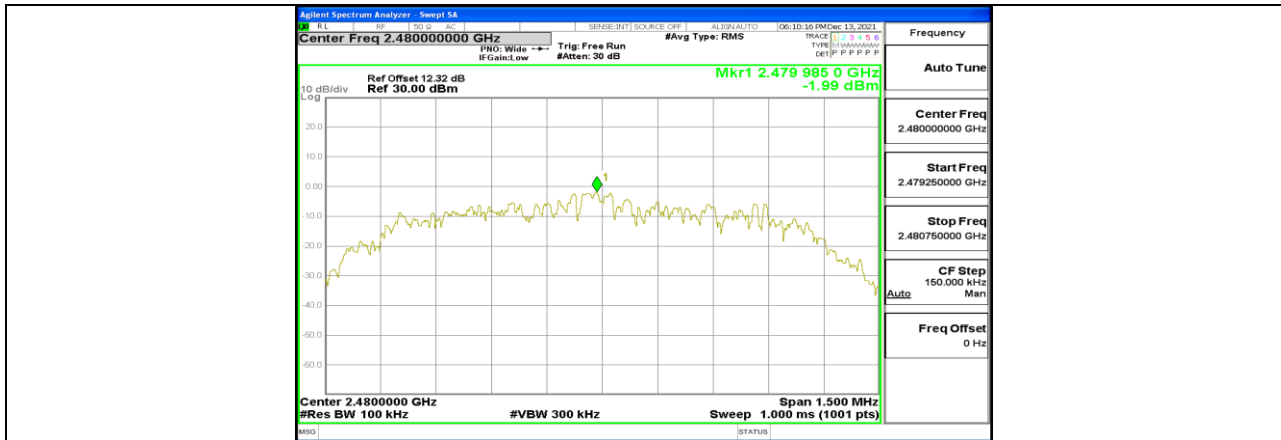

3DH5_Ant1_2480_0~Reference

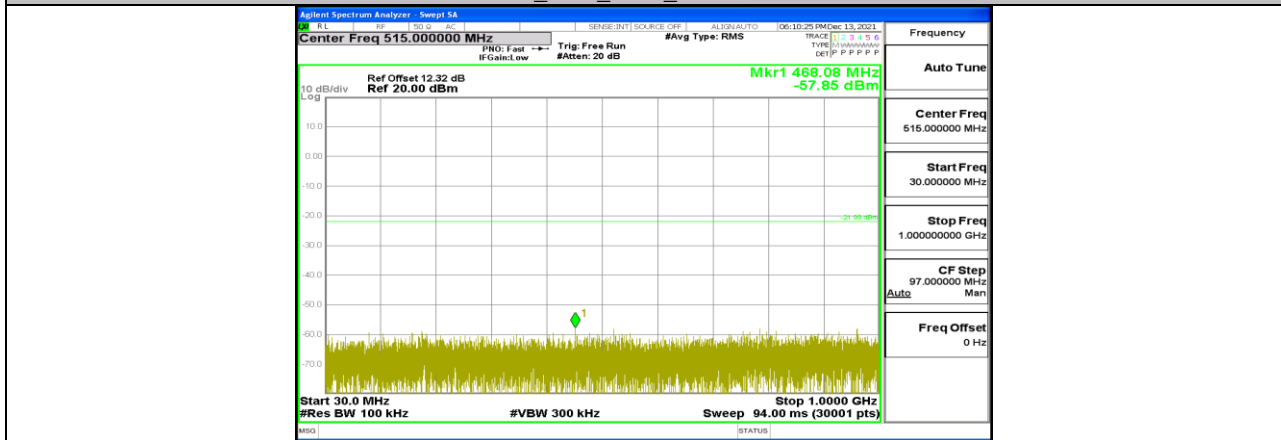

3DH5_Ant1_2480_30~1000

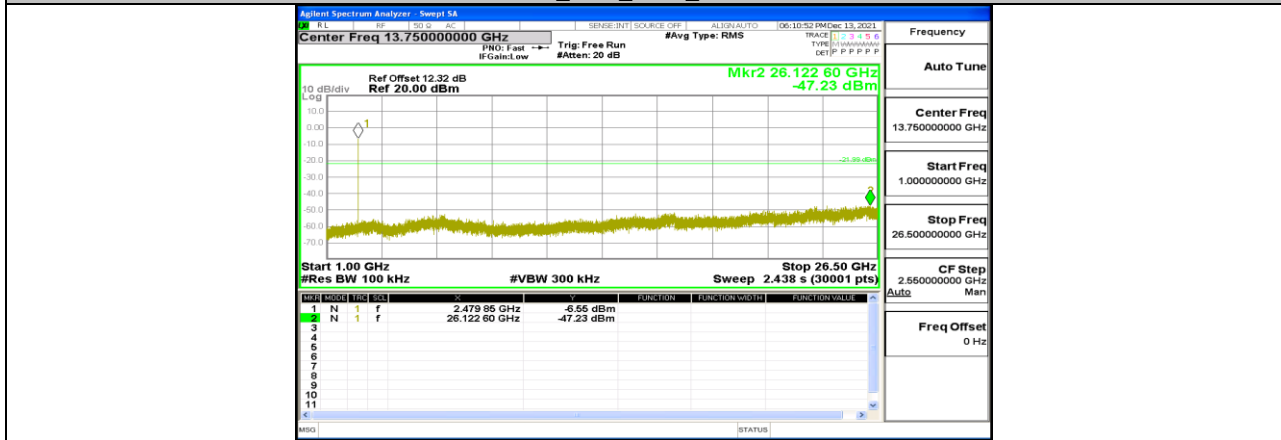

3DH5_Ant1_2480_1000~26500



11.9. Appendix I: Duty Cycle

11.9.1. Test Result

Test Packet Type	On Time (msec)	Period (msec)	Duty Cycle x (Linear)	Duty Cycle (%)	Duty Cycle Correction Factor (dB)	1/T Minimum VBW (kHz)	Final setting For VBW (kHz)
DH5	2.86	3.74	0.7647	76.47	1.17	0.35	0.5
3DH5	2.88	3.75	0.7680	76.80	1.15	0.35	0.5

Note:

Duty Cycle Correction Factor= $10\log(1/x)$.

Where: x is Duty Cycle (Linear)

Where: T is On Time

If that calculated VBW is not available on the analyzer then the next higher value should be used.



11.9.2. Test Graphs



END OF REPORT