

JIMO

A95 pro

 Shadow Creator

JIMO start your smart life

JIMO from Shadow Creator will change the way you communicate, create, cooperate and explore. Turn it on, and start your smart life. Before that, please read this instruction carefully, and set up your device.

This is a list of JIMO accessories

For more accessories, please visit www.shadowcreator.com.

Note: This product type approval code is displayed on the nameplate of the appearance of the product.

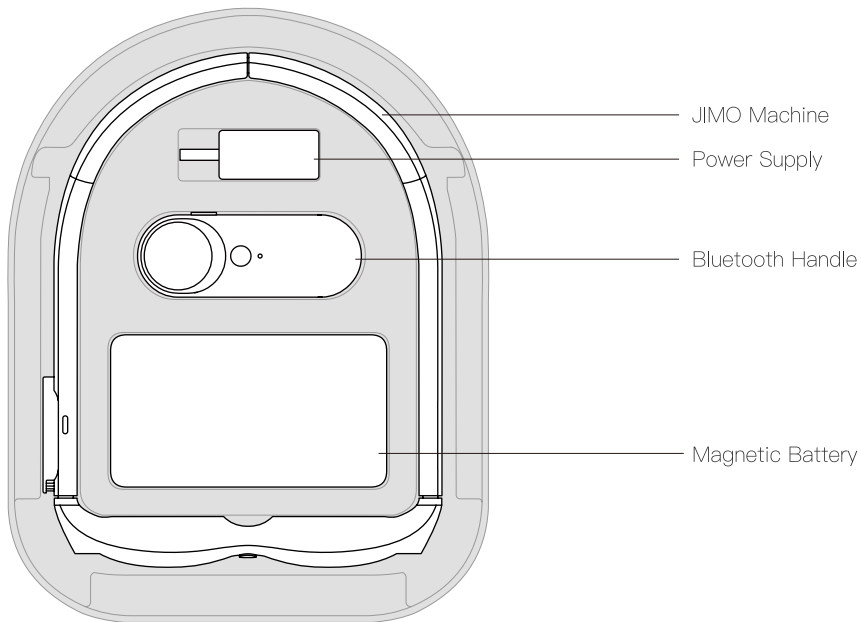

Upper

Note: This product type approval code is displayed on the nameplate of the appearance of the product.

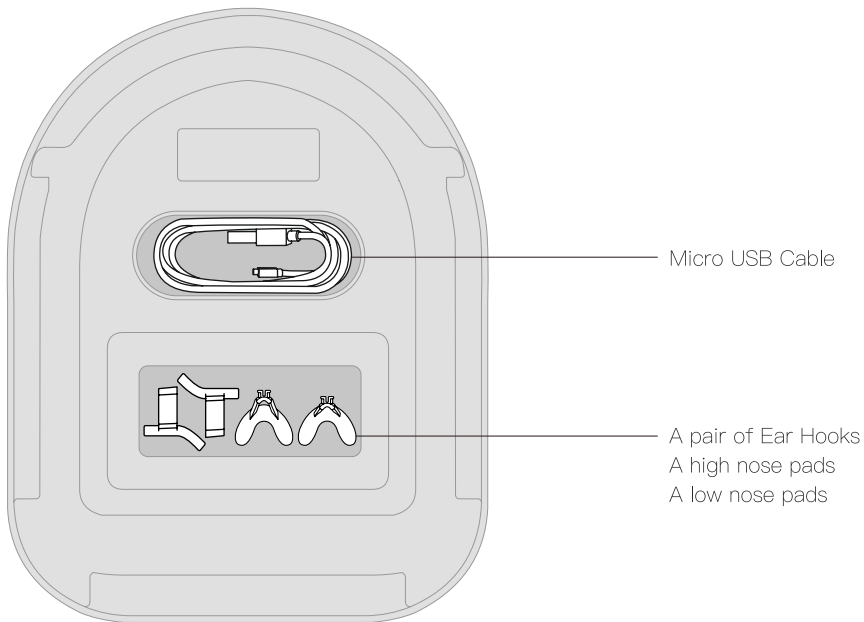

Lower

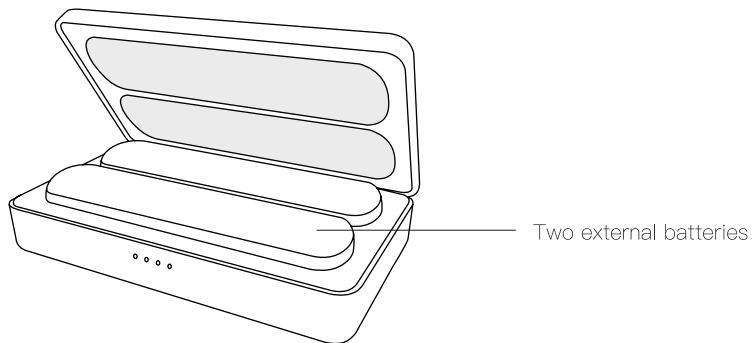

Open charging case

Safety and Comfort

Use in a safe environment

Please use JIMO in a safe space without obstacles.

Please do not use JIMO when driving or doing other things with security risks.

Stay comfortable

Please take a few breaks when using JIMO for the first time.

If you feel unwell, such as dizziness, motion sickness, nausea, confusion, headache, eye fatigue, etc., please stop using it immediately.

Right

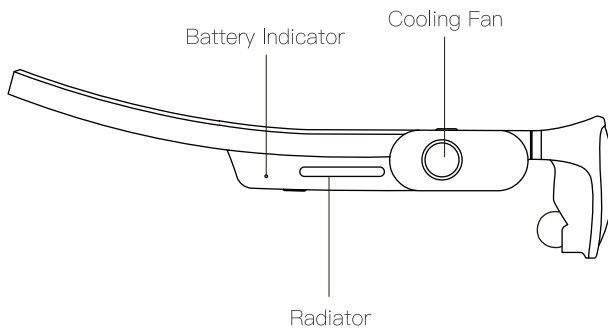

Top

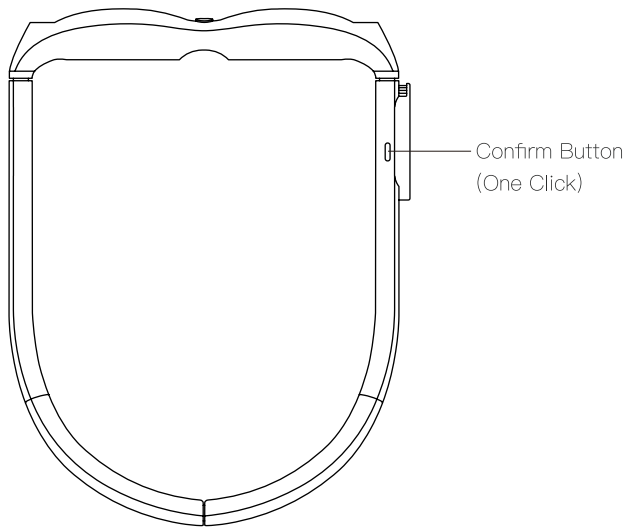

Bottom

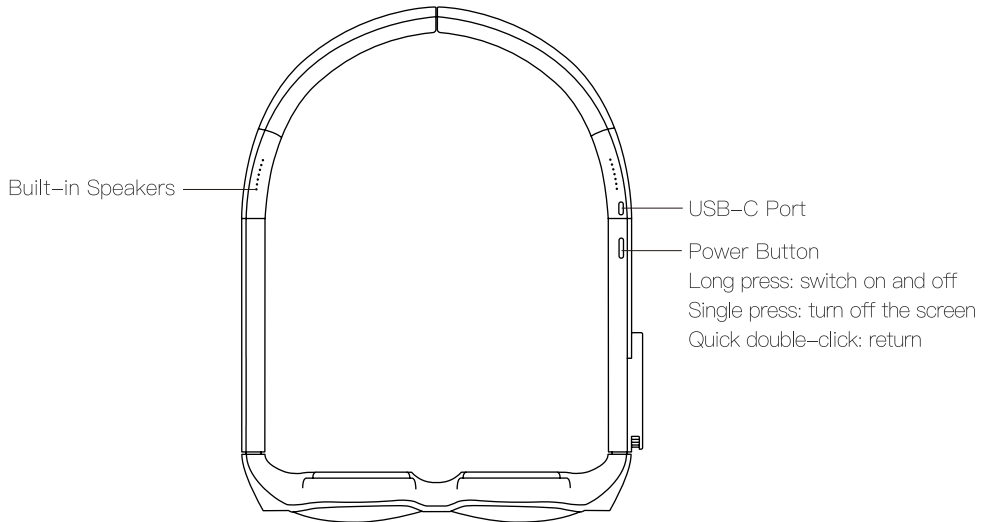

Installation Accessories

How to properly install nose pads, ear hook, and external battery.

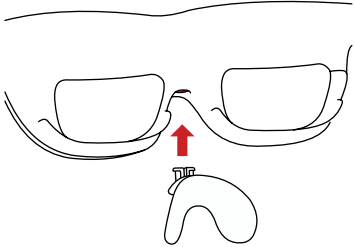

Please align slot here

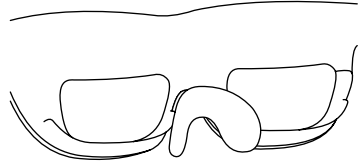

Nose pad is installed

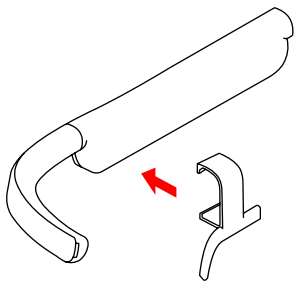

Please align at the back of the leg

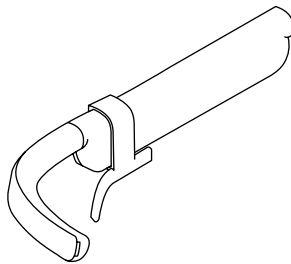

Ear hook is installed

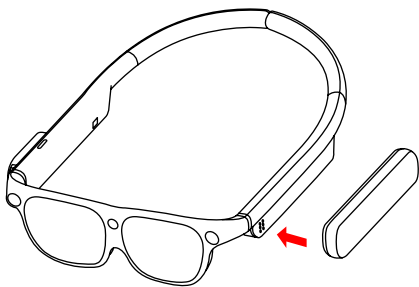

Please align the port

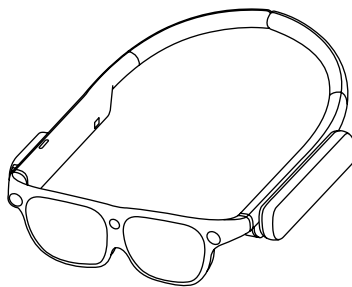

The external battery is installed

Put on your device

How to put on JIMO correctly and comfortably?

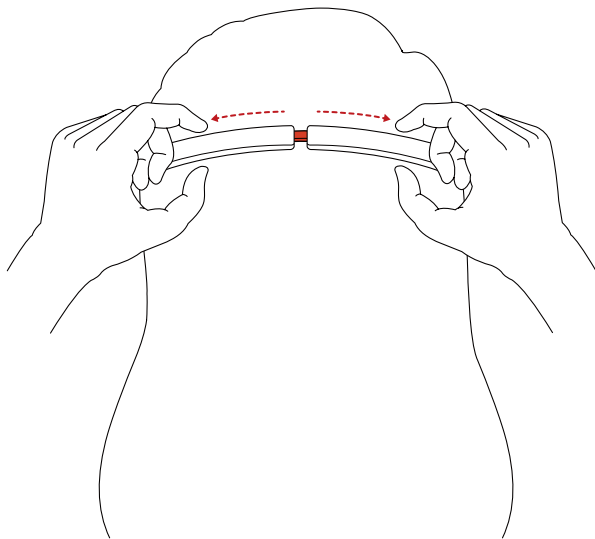

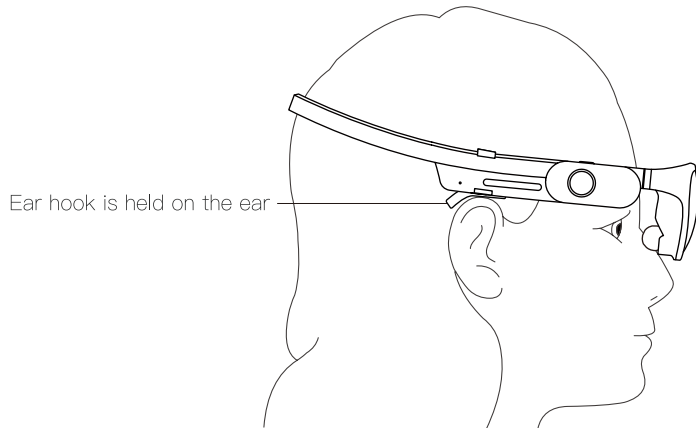

Bluetooth Handle

Make it easier for you to experience the product
In 3D mode, the handle is presented to you as an air mouse.

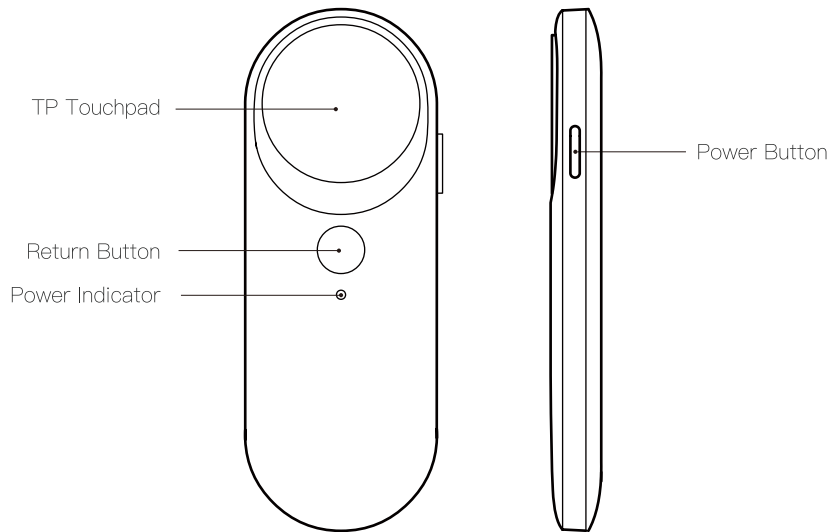



Gesture control and voice control can only be used after wedgit is turned on on the main interface.

JIMO

User Operating System Guide

1. Application List

Click the right arrow to bring up the list of installed apps



2. WiFi connection

- Open the "Setting" button on the right
- Click "Network and Internet"
- Click "WLAN"
- Select the WIFI you need to connect and enter the password
- Connection succeeded



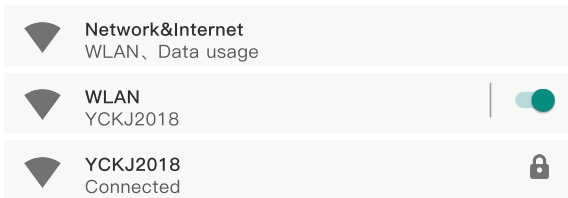

3. Bluetooth connection

- Open the "Setting" button on the right
- Click "Connected devices"
- Click "WLAN"
- Click "Pair with new device" and select the device you want to connect
- Connection succeeded

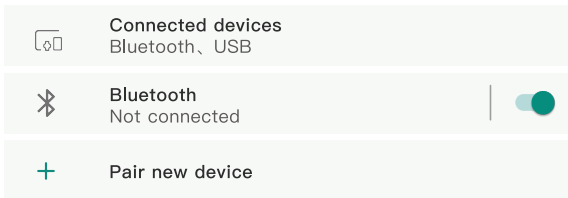

Selection and Confirmation

Use the pointer to aim at the content displayed on the screen and press the handle touchpad.

The selection and confirmation operations in the system can be completed.

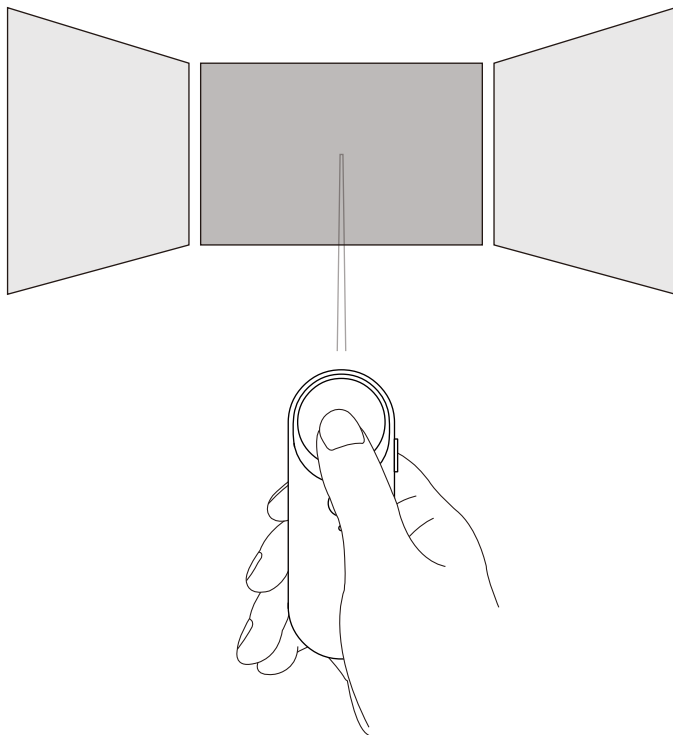

How to edit the window

Align the status bar at the top of the task window, and long-press to drag the window to any position.

Through the small icons in the status bar of the task window, the window can be zoomed in, zoomed out, zoomed in, zoomed out, fixed in full screen, and closed.

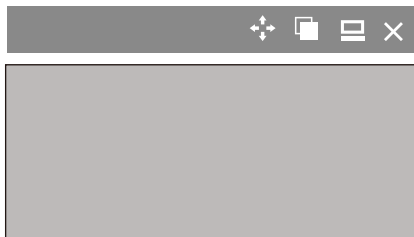

Gesture

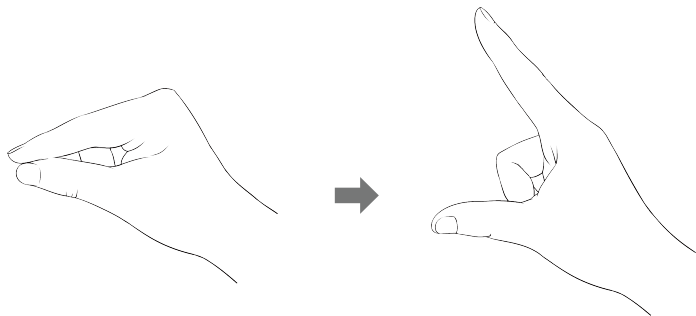

Click

Gesture

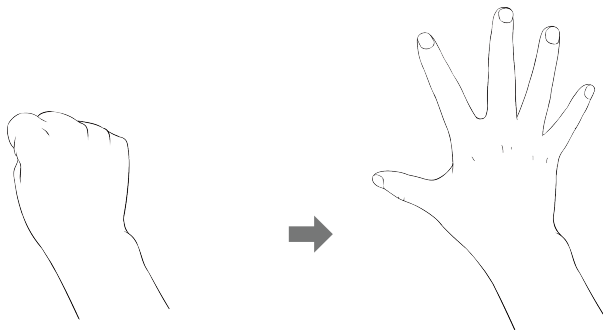

Return

FCC Warning

This device complies with part 15 of the FCC Rules. Operation is subject to the following two conditions: (1) This device may not cause harmful interference, and (2) this device must accept any interference received, including interference that may cause undesired operation.

Any Changes or modifications not expressly approved by the party responsible for compliance could void the user's authority to operate the equipment.

Note: This equipment has been tested and found to comply with the limits for a Class B digital device, pursuant to part 15 of the FCC Rules. These limits are designed to provide reasonable protection against harmful interference in a residential installation. This equipment generates uses and can radiate radio frequency energy and, if not installed and used in accordance with the instructions, may cause harmful interference to radio communications. However, there is no guarantee that interference will not occur in a particular installation. If this equipment does cause harmful interference to radio or television reception, which can be determined by turning the equipment off and on, the user is encouraged to try to correct the interference by one or more of the following measures:

- Reorient or relocate the receiving antenna.
- Increase the separation between the equipment and receiver.
- Connect the equipment into an outlet on a circuit different from that to which the receiver is connected.
- Consult the dealer or an experienced radio/TV technician for help.

FCC RF Exposure Information and Statement

The SAR limit of USA (FCC) is 1.6 W/kg averaged over one gram of tissue. Device types: A95 pro (FCC ID: 2AQYU-A95PRO) has also been tested against this SAR limit. The highest SAR value reported under this standard during product certification for use the body is 1.353W/kg. This device was tested for typical body-worn operations with the back of the handset kept 0mm from the body. To maintain compliance with FCC RF exposure requirements, use accessories that maintain a 0mm separation distance between the user's body and the back of the handset. The use of belt clips, holsters and similar accessories should not contain metallic components in its assembly. The use of accessories that do not satisfy these requirements may not comply with FCC RF exposure requirements, and should be avoided.

Body-worn Operation

This device was tested for typical body-worn operations. To comply with RF exposure requirements, a minimum separation distance of 0mm must be maintained between the user's body and the handset, including the antenna. Third-party belt-clips, holsters, and similar accessories used by this device should not contain any metallic components. Body-worn accessories that do not meet these requirements may not comply with RF exposure requirements and should be avoided. Use only the supplied or an approved antenna.