

**CFR 47 FCC PART 15 SUBPART C
ISED RSS-247 Issue 3**

TEST REPORT

For

GOLDEN TEE 3D x MIDWAY XL

MODEL NUMBER: GLD-F-404423

REPORT NUMBER: 4791254517.2-1-RF-1

ISSUE DATE: April 29, 2024

**FCC ID: 2APXHGLDMID
IC: 24128-GLDMID**

Prepared for

**WF Tastemakers Trading Limited
FCC Address: Unit 05 and unit 06, 6th Floor, Greenfield Tower Concordia Plaza, 1
Science Museum Road, TST East, Hong Kong
ISED Address: 347 Fifth Avenue Suite 1402-199, New York NY 10018 United
States Of America (Excluding The States Of Alaska)**

Prepared by

UL Verification Services (Guangzhou) Co., Ltd, Song Shan Lake Branch

**Building 10, Innovation Technology Park, No. 1, Li Bin Road, Song Shan Lake Hi-
Tech Development Zone Dongguan, 523808, People's Republic of China**

Tel: +86 769 22038881

Fax: +86 769 33244054

Website: www.ul.com

Revision History

| Rev. | Issue Date | Revisions | Revised By |
|------|----------------|---------------|------------|
| V0 | April 29, 2024 | Initial Issue | |

Summary of Test Results

| Test Item | Clause | Limit/Requirement | Result |
|-------------------------------------------|-----------------------------------------------|-------------------------------------------------------------------------------------------|--------|
| Antenna Requirement | N/A | FCC Part 15.203/15.247 (c) RSS-GEN Clause 6.8 | Pass |
| AC Power Line Conducted Emission | ANSI C63.10-2013, Clause 6.2 | FCC Part 15.207 RSS-GEN Clause 8.8 | Pass |
| Conducted Output Power | ANSI C63.10-2013, Clause 11.9.1.3 | FCC Part 15.247 (b)(3) RSS-247 Clause 5.4 (d) | Pass |
| 6dB Bandwidth and 99% Occupied Bandwidth | ANSI C63.10-2013, Clause 11.8.1 | FCC Part 15.247 (a)(2) RSS-247 Clause 5.2 (a) ISED RSS-Gen Clause 6.7 | Pass |
| Power Spectral Density | ANSI C63.10-2013, Clause 11.10.2 | FCC Part 15.247 (e) RSS-247 Clause 5.2 (b) | Pass |
| Conducted Band edge and spurious emission | ANSI C63.10-2013, Clause 11.11 | FCC Part 15.247(d) RSS-247 Clause 5.5 | Pass |
| Radiated Band edge and Spurious Emission | ANSI C63.10-2013, Clause 11.12 & Clause 11.13 | FCC Part 15.247 (d) FCC Part 15.205/15.209 RSS-247 Clause 5.5 RSS-GEN Clause 8.9 | Pass |
| Duty Cycle | ANSI C63.10-2013, Clause 11.6 | None; for reporting purposes only. | Pass |

*This test report is only published to and used by the applicant, and it is not for evidence purpose in China.

*The measurement result for the sample received is <Pass> according to <CFR 47 FCC PART 15 SUBPART C ISED RSS-247 Issue 3> when <Simple Acceptance> decision rule is applied.

CONTENTS

| | |
|------------------------------------------------------------|-----------|
| 1. ATTESTATION OF TEST RESULTS..... | 6 |
| 2. TEST METHODOLOGY..... | 7 |
| 3. FACILITIES AND ACCREDITATION..... | 7 |
| 4. CALIBRATION AND UNCERTAINTY | 8 |
| 4.1. <i>MEASURING INSTRUMENT CALIBRATION</i> | <i>8</i> |
| 4.2. <i>MEASUREMENT UNCERTAINTY.....</i> | <i>8</i> |
| 5. EQUIPMENT UNDER TEST | 9 |
| 5.1. <i>DESCRIPTION OF EUT</i> | <i>9</i> |
| 5.2. <i>CHANNEL LIST</i> | <i>9</i> |
| 5.3. <i>MAXIMUM POWER.....</i> | <i>9</i> |
| 5.4. <i>TEST CHANNEL CONFIGURATION.....</i> | <i>9</i> |
| 5.5. <i>THE WORSE CASE POWER SETTING PARAMETER.....</i> | <i>10</i> |
| 5.6. <i>DESCRIPTION OF AVAILABLE ANTENNAS</i> | <i>11</i> |
| 5.7. <i>SUPPORT UNITS FOR SYSTEM TEST.....</i> | <i>12</i> |
| 6. MEASURING EQUIPMENT AND SOFTWARE USED..... | 13 |
| 7. ANTENNA PORT TEST RESULTS | 16 |
| 7.1. <i>CONDUCTED OUTPUT POWER.....</i> | <i>16</i> |
| 7.2. <i>6DB BANDWIDTH AND 99% OCCUPIED BANDWIDTH.....</i> | <i>17</i> |
| 7.3. <i>POWER SPECTRAL DENSITY</i> | <i>19</i> |
| 7.4. <i>CONDUCTED BAND EDGE AND SPURIOUS EMISSION.....</i> | <i>21</i> |
| 7.5. <i>DUTY CYCLE</i> | <i>23</i> |
| 8. RADIATED TEST RESULTS..... | 24 |
| 8.1. <i>RESTRICTED BANDEDGE</i> | <i>32</i> |
| 8.2. <i>SPURIOUS EMISSIONS(1 GHZ~3 GHZ)</i> | <i>46</i> |
| 8.3. <i>SPURIOUS EMISSIONS(3 GHZ~18 GHZ)</i> | <i>52</i> |
| 8.4. <i>SPURIOUS EMISSIONS(9 KHZ~30 MHZ)</i> | <i>70</i> |
| 8.5. <i>SPURIOUS EMISSIONS(18 GHZ~26 GHZ)</i> | <i>73</i> |
| 8.6. <i>SPURIOUS EMISSIONS(30 MHZ~1 GHZ).....</i> | <i>75</i> |
| 9. ANTENNA REQUIREMENT | 77 |
| 10. AC POWER LINE CONDUCTED EMISSION | 78 |
| 11. TEST DATA..... | 81 |
| 11.1. <i>APPENDIX A: DTS BANDWIDTH.....</i> | <i>81</i> |
| 11.1.1. <i>Test Result.....</i> | <i>81</i> |

| | | |
|---------|--------------------------------------------------------|------------|
| 11.1.2. | Test Graphs | 82 |
| 11.2. | <i>APPENDIX B: OCCUPIED CHANNEL BANDWIDTH.....</i> | <i>85</i> |
| 11.2.1. | Test Result..... | 85 |
| 11.2.2. | Test Graphs | 86 |
| 11.3. | <i>APPENDIX C: MAXIMUM CONDUCTED OUTPUT POWER.....</i> | <i>89</i> |
| 11.3.1. | Test Result..... | 89 |
| 11.4. | <i>APPENDIX D: MAXIMUM POWER SPECTRAL DENSITY.....</i> | <i>90</i> |
| 11.4.1. | Test Result..... | 90 |
| 11.4.2. | Test Graphs | 91 |
| 11.5. | <i>APPENDIX E: BAND EDGE MEASUREMENTS.....</i> | <i>94</i> |
| 11.5.1. | Test Result..... | 94 |
| 11.5.2. | Test Graphs | 95 |
| 11.6. | <i>APPENDIX F: CONDUCTED SPURIOUS EMISSION</i> | <i>97</i> |
| 11.6.1. | Test Result..... | 97 |
| 11.6.2. | Test Graphs | 98 |
| 11.7. | <i>APPENDIX G: DUTY CYCLE.....</i> | <i>106</i> |
| 11.7.1. | Test Result..... | 106 |
| 11.7.2. | Test Graphs | 107 |

1. ATTESTATION OF TEST RESULTS

Applicant Information

Company Name: WF Tastemakers Trading Limited
 Address: FCC Address: Unit 05 and unit 06, 6th Floor, Greenfield Tower Concordia Plaza, 1 Science Museum Road, TST East, Hong Kong
 ISED Address: 347 Fifth Avenue Suite 1402-199, New York NY 10018 United States Of America (Excluding The States Of Alaska)

Manufacturer Information

Company Name: WF Tastemakers Trading Limited
 Address: FCC Address: Unit 05 and unit 06, 6th Floor, Greenfield Tower Concordia Plaza, 1 Science Museum Road, TST East, Hong Kong
 ISED Address: 347 Fifth Avenue Suite 1402-199, New York NY 10018 United States Of America (Excluding The States Of Alaska)

EUT Information

EUT Name: GOLDEN TEE 3D x MIDWAY XL
 Model: GLD-F-404423
 Brand: ARCADE1UP
 Sample Received Date: April 7, 2024
 Sample Status: Normal
 Sample ID: 7095945
 Date of Tested: April 7, 2024 to April 29, 2024

| APPLICABLE STANDARDS | |
|------------------------------------------------------|--------------|
| STANDARD | TEST RESULTS |
| CFR 47 FCC PART 15 SUBPART C ISED RSS-247 Issue 3 | Pass |

Prepared By:



Fanny Huang
 Engineer Project Associate

Checked By:

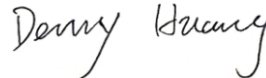

Denny Huang
 Senior Project Engineer

Approved By:



Stephen Guo
 Operations Manager

2. TEST METHODOLOGY

All tests were performed in accordance with the standard CFR 47 FCC PART 15 SUBPART C ISED RSS-247 Issue 3, KDB 558074 D01 15.247 Meas Guidance v05r02, KDB 414788 D01 Radiated Test Site v01r01, CFR 47 FCC Part 2, ANSI C63.10-2013 and ISED RSS-GEN Issue 5

3. FACILITIES AND ACCREDITATION

| | |
|---------------------------|------------------------------------------------------------------------------------------------------------------------------------------------------------------------------------------------------------------------------------------------------------------------------------------------------------------------------------------------------------------------------------------------------------------------------------------------------------------------------------------------------------------------------------------------------------------------------------------------------------------------------------------------------------------------------------------------------------------------------------------------------------------------------------------------------------------------------------------------------------------------------------------------------------------------------------------------------------------------------------------------------------------------------------------------------------------------------------------------------------------------------------------------------------------------|
| Accreditation Certificate | <p>A2LA (Certificate No.: 4102.01) UL Verification Services (Guangzhou) Co., Ltd. Song Shan Lake Branch. has been assessed and proved to be in compliance with A2LA.</p> <p>FCC (FCC Designation No.: CN1187) UL Verification Services (Guangzhou) Co., Ltd. Song Shan Lake Branch. Has been recognized to perform compliance testing on equipment subject to the Commission's Declaration of Conformity (DoC) and Certification rules</p> <p>ISED (Company No.: 21320) UL Verification Services (Guangzhou) Co., Ltd. Song Shan Lake Branch. has been registered and fully described in a report filed with ISED. The Company Number is 21320 and the test lab Conformity Assessment Body Identifier (CABID) is CN0046.</p> <p>VCCI (Registration No.: G-20192, C-20153, T-20155 and R-20202) UL Verification Services (Guangzhou) Co., Ltd. Song Shan Lake Branch. has been assessed and proved to be in compliance with VCCI, the Membership No. is 3793. Facility Name: Chamber D, the VCCI registration No. is G-20192 and R-20202 Shielding Room B, the VCCI registration No. is C-20153 and T-20155</p> |
|---------------------------|------------------------------------------------------------------------------------------------------------------------------------------------------------------------------------------------------------------------------------------------------------------------------------------------------------------------------------------------------------------------------------------------------------------------------------------------------------------------------------------------------------------------------------------------------------------------------------------------------------------------------------------------------------------------------------------------------------------------------------------------------------------------------------------------------------------------------------------------------------------------------------------------------------------------------------------------------------------------------------------------------------------------------------------------------------------------------------------------------------------------------------------------------------------------|

Note 1:

All tests measurement facilities use to collect the measurement data are located at Building 10, Innovation Technology Park, No. 1, Li Bin Road, Song Shan Lake Hi-Tech Development Zone Dongguan, 523808, People's Republic of China.

Note 2:

The test anechoic chamber in UL Verification Services (Guangzhou) Co., Ltd. Song Shan Lake Branch had been calibrated and compared to the open field sites and the test anechoic chamber is shown to be equivalent to or worst case from the open field site.

Note 3:

For below 30 MHz, lab had performed measurements at test anechoic chamber and comparing to measurements obtained on an open field site. And these measurements below 30 MHz had been correlated to measurements performed on an OFS.

4. CALIBRATION AND UNCERTAINTY

4.1. MEASURING INSTRUMENT CALIBRATION

The measuring equipment utilized to perform the tests documented in this report has been calibrated in accordance with the manufacturer's recommendations and is traceable to recognized national standards.

4.2. MEASUREMENT UNCERTAINTY

Where relevant, the following measurement uncertainty levels have been estimated for tests performed on the apparatus:

| Test Item | Uncertainty |
|-----------------------------------------------------------------------------------------------------------------------------------------------|---------------------------|
| Conduction emission | 3.62 dB |
| Radiated Emission (Included Fundamental Emission) (9 kHz ~ 30 MHz) | 2.2 dB |
| Radiated Emission (Included Fundamental Emission) (30 MHz ~ 1 GHz) | 4.00 dB |
| Radiated Emission (Included Fundamental Emission) (1 GHz to 26 GHz) | 5.78 dB (1 GHz ~ 18 GHz) |
| | 5.23 dB (18 GHz ~ 26 GHz) |
| Duty Cycle | ±0.028% |
| DTS and 99% Occupied Bandwidth | ±0.0196% |
| Maximum Conducted Output Power | ±0.686 dB |
| Maximum Power Spectral Density Level | ±0.743 dB |
| Conducted Band-edge Compliance | ±1.328 dB |
| Conducted Unwanted Emissions In Non-restricted Frequency Bands | ±0.746 dB (9 kHz ~ 1 GHz) |
| | ±1.328dB (1 GHz ~ 26 GHz) |
| Note: This uncertainty represents an expanded uncertainty expressed at approximately the 95% confidence level using a coverage factor of k=2. | |

5. EQUIPMENT UNDER TEST

5.1. DESCRIPTION OF EUT

| | |
|----------------------|-------------------------------------------------------------------------------------------|
| EUT Name | GOLDEN TEE 3D x MIDWAY XL |
| Model | GLD-F-404423 |
| Frequency Range: | 2412 MHz to 2462 MHz |
| Type of Modulation: | IEEE 802.11b: DSSS(CCK, DQPSK, DBPSK) IEEE 802.11g/n: OFDM(64-QAM, 16-QAM, QPSK, BPSK) |
| Radio Technology: | IEEE 802.11b/g/n HT20 |
| Normal Test Voltage: | AC 120 V, 60 Hz |

5.2. CHANNEL LIST

| Channel List For Bandwidth=20 MHz | | | | | | | |
|-----------------------------------|-----------------|---------|-----------------|---------|-----------------|---------|-----------------|
| Channel | Frequency (MHz) | Channel | Frequency (MHz) | Channel | Frequency (MHz) | Channel | Frequency (MHz) |
| 1 | 2412 | 4 | 2427 | 7 | 2442 | 10 | 2457 |
| 2 | 2417 | 5 | 2432 | 8 | 2447 | 11 | 2462 |
| 3 | 2422 | 6 | 2437 | 9 | 2452 | / | / |

5.3. MAXIMUM POWER

| IEEE Std. 802.11 | Frequency (MHz) | Channel Number | Maximum Conducted AVG Output Power (dBm) | Maximum AVG EIRP (dBm) |
|------------------|-----------------|----------------|------------------------------------------|------------------------|
| b | 2412 ~ 2462 | 1-11[11] | 16.31 | 19.12 |
| g | 2412 ~ 2462 | 1-11[11] | 14.54 | 17.35 |
| n HT20 | 2412 ~ 2462 | 1-11[11] | 13.82 | 16.63 |

5.4. TEST CHANNEL CONFIGURATION

| IEEE Std. 802.11 | Test Channel Number | Frequency |
|------------------|-----------------------------------------------------------|------------------------------|
| b | CH 1(Low Channel), CH 6(MID Channel), CH 11(High Channel) | 2412 MHz, 2437 MHz, 2462 MHz |
| g | CH 1(Low Channel), CH 6(MID Channel), CH 11(High Channel) | 2412 MHz, 2437 MHz, 2462 MHz |
| n HT20 | CH 1(Low Channel), CH 6(MID Channel), CH 11(High Channel) | 2412 MHz, 2437 MHz, 2462 MHz |

5.5. THE WORSE CASE POWER SETTING PARAMETER

| The Worse Case Power Setting Parameter under 2400 ~ 2483.5MHz Band | | | | | | | |
|--------------------------------------------------------------------|-------------------------|--------------|------|-------|------------|------|------|
| Test Software | | Putty | | | | | |
| Modulation Mode | Transmit Antenna Number | Test Channel | | | | | |
| | | NCB: 20MHz | | | NCB: 40MHz | | |
| | | CH 1 | CH 6 | CH 11 | CH 3 | CH 6 | CH 9 |
| 802.11b | 1 | 36 | 40 | 44 | / | | |
| 802.11g | 1 | 46 | 48 | 50 | | | |
| 802.11n HT20 | 1 | 44 | 46 | 48 | | | |

WORST-CASE CONFIGURATIONS

The EUT was tested in the following configuration(s):

Controlled in test mode using a software application on the EUT supplied by customer. The application was used to enable a continuous transmission and to select the mode, test channels, bandwidth, data rates as required.

Test channels referring to section 5.4.

Maximum power setting referring to section 5.5.

Worst-case data rates as provided by the client were:

802.11b mode: 1 Mbps
 802.11g mode: 6 Mbps
 802.11n HT20 mode: MCS0

The measured additional path loss was included in any path loss calculations for all RF cable used during tested.

5.6. DESCRIPTION OF AVAILABLE ANTENNAS

| Antenna | Frequency (MHz) | Antenna Type | MAX Antenna Gain (dBi) | Cable loss (dB) | Final Gain (dBi) |
|---------|-----------------|------------------|------------------------|-----------------|------------------|
| 1 | 2412-2462 | Monopole Antenna | 4.23 | -1.42 | 2.81 |

| Test Mode | Transmit and Receive Mode | Description |
|-------------------|----------------------------------------------|------------------------------------------------------|
| IEEE 802.11b | <input checked="" type="checkbox"/> 1TX, 1RX | ANT 1 can be used as transmitting/receiving antenna. |
| IEEE 802.11g | <input checked="" type="checkbox"/> 1TX, 1RX | ANT 1 can be used as transmitting/receiving antenna. |
| IEEE 802.11n HT20 | <input checked="" type="checkbox"/> 1TX, 1RX | ANT 1 can be used as transmitting/receiving antenna. |

5.7. SUPPORT UNITS FOR SYSTEM TEST

SUPPORT EQUIPMENT

| Item | Equipment | Brand Name | Model Name | P/N |
|------|-----------|------------|------------|---------------|
| 1 | Laptop | ThinkPad | T460S | SL10K24796 JS |
| 2 | UART | / | / | / |

I/O CABLES

| Cable No | Port | Connector Type | Cable Type | Cable Length(m) | Remarks |
|----------|------|----------------|------------|-----------------|---------|
| 1 | USB | / | / | 1.0 | / |

ACCESSORIES

| Item | Accessory | Brand Name | Model Name | Description |
|------|------------------------|------------|--------------------|-------------------------------------------------------------------------------------------|
| 1 | Switching Power Supply | Royal | BI36L-120300-I-LED | Input: 100-240V~ 50/60Hz 1.2A Output: 12.0V $\overline{\overline{=}}$ 3.0A 36.0W |

TEST SETUP

The EUT can work in engineering mode with a software through a Laptop.

SETUP DIAGRAM

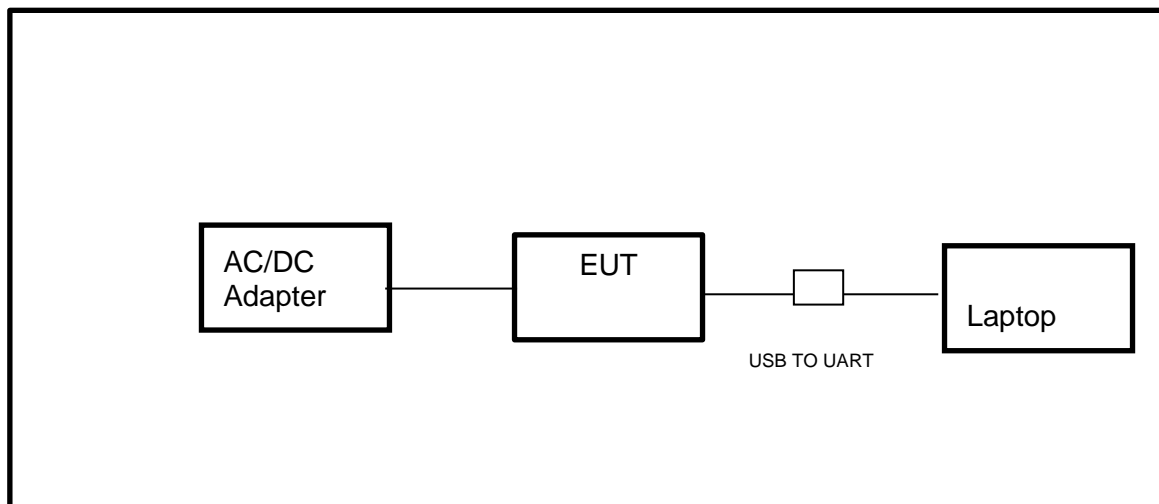

6. MEASURING EQUIPMENT AND SOFTWARE USED

| R&S TS 8997 Test System | | | | | |
|-------------------------------------|-----------------|-------------------------|------------------|--------------|--------------|
| Equipment | Manufacturer | Model No. | Serial No. | Last Cal. | Due. Date |
| Power sensor, Power Meter | R&S | OSP120 | 100921 | Mar.25,2024 | Mar.24,2025 |
| Vector Signal Generator | R&S | SMBV100A | 261637 | Oct.12, 2023 | Oct.11, 2024 |
| Signal Generator | R&S | SMB100A | 178553 | Oct.12, 2023 | Oct.11, 2024 |
| Signal Analyzer | R&S | FSV40 | 101118 | Oct.12, 2023 | Oct.11, 2024 |
| Software | | | | | |
| Description | Manufacturer | Name | | Version | |
| For R&S TS 8997 Test System | Rohde & Schwarz | EMC 32 | | 10.60.10 | |
| Tonsend RF Test System | | | | | |
| Equipment | Manufacturer | Model No. | Serial No. | Last Cal. | Due. Date |
| Wideband Radio Communication Tester | R&S | CMW500 | 155523 | Oct.12, 2023 | Oct.11, 2024 |
| Wireless Connectivity Tester | R&S | CMW270 | 1201.0002N75-102 | Sep.25, 2023 | Sep.24, 2024 |
| PXA Signal Analyzer | Keysight | N9030A | MY55410512 | Oct.12, 2023 | Oct.11, 2024 |
| MXG Vector Signal Generator | Keysight | N5182B | MY56200284 | Oct.12, 2023 | Oct.11, 2024 |
| MXG Vector Signal Generator | Keysight | N5172B | MY56200301 | Oct.12, 2023 | Oct.11, 2024 |
| DC power supply | Keysight | E3642A | MY55159130 | Oct.12, 2023 | Oct.11, 2024 |
| Temperature & Humidity Chamber | SANMOOD | SG-80-CC-2 | 2088 | Oct.12, 2023 | Oct.11, 2024 |
| Attenuator | Aglient | 8495B | 2814a12853 | Oct.12, 2023 | Oct.11, 2024 |
| RF Control Unit | Tonscend | JS0806-2 | 23B80620666 | Mar.25,2024 | Mar.24,2025 |
| Software | | | | | |
| Description | Manufacturer | Name | | Version | |
| Tonsend SRD Test System | Tonsend | JS1120-3 RF Test System | | V3.2.22 | |

| Conducted Emissions | | | | | |
|---------------------------------------|--------------|-----------|--------------|--------------|--------------|
| Equipment | Manufacturer | Model No. | Serial No. | Last Cal. | Due Date |
| EMI Test Receiver | R&S | ESR3 | 101961 | Oct.13, 2023 | Oct.12, 2024 |
| Two-Line V-Network | R&S | ENV216 | 101983 | Oct.13, 2023 | Oct.12, 2024 |
| Artificial Mains Networks | Schwarzbeck | NSLK 8126 | 8126465 | Oct.13, 2023 | Oct.12, 2024 |
| Software | | | | | |
| Description | | | Manufacturer | Name | Version |
| Test Software for Conducted Emissions | | | Farad | EZ-EMC | Ver. UL-3A1 |

| Radiated Emissions | | | | | |
|--------------------------------------|--------------|-------------------------------------|---------------|---------------|---------------|
| Equipment | Manufacturer | Model No. | Serial No. | Last Cal. | Due Date |
| MXE EMI Receiver | KESIGHT | N9038A | MY56400036 | Oct.12, 2023 | Oct.11, 2024 |
| Hybrid Log Periodic Antenna | TDK | HLP-3003C | 130959 | Aug.02, 2021 | Aug.01, 2024 |
| Preamplifier | HP | 8447D | 2944A09099 | Oct.12, 2023 | Oct.11, 2024 |
| EMI Measurement Receiver | R&S | ESR26 | 101377 | Oct.12, 2023 | Oct.11, 2024 |
| Horn Antenna | TDK | HRN-0118 | 130940 | July 20, 2021 | July 19, 2024 |
| Preamplifier | TDK | PA-02-0118 | TRS-305-00067 | Oct.12, 2023 | Oct.11, 2024 |
| Horn Antenna | Schwarzbeck | BBHA9170 | 697 | July 20, 2021 | July 19, 2024 |
| Preamplifier | TDK | PA-02-2 | TRS-307-00003 | Oct.12, 2023 | Oct.11, 2024 |
| Preamplifier | TDK | PA-02-3 | TRS-308-00002 | Oct.12, 2023 | Oct.11, 2024 |
| Loop antenna | Schwarzbeck | 1519B | 00008 | Dec.14, 2021 | Dec.13, 2024 |
| Preamplifier | TDK | PA-02-001-3000 | TRS-302-00050 | Oct.12, 2023 | Oct.11, 2024 |
| High Pass Filter | Wi | WHKX10-2700-3000-18000-40SS | 23 | Oct.12, 2023 | Oct.11, 2024 |
| Band Reject Filter | Wainwright | WRCJV8-2350-2400-2483.5-2533.5-40SS | 4 | Oct.12, 2023 | Oct.11, 2024 |
| Software | | | | | |
| Description | | | Manufacturer | Name | Version |
| Test Software for Radiated Emissions | | | Farad | EZ-EMC | Ver. UL-3A1 |

| Other Instrument | | | | | |
|----------------------------|--------------|-----------|------------|--------------|--------------|
| Equipment | Manufacturer | Model No. | Serial No. | Last Cal. | Due Date |
| Temperature humidity probe | OMEGA | ITHX-SD-5 | 18470007 | Oct.21, 2023 | Oct.20, 2024 |
| Barometer | Yiyi | Baro | N/A | Oct.19, 2023 | Oct.18, 2024 |
| Attenuator | Agilent | 8495B | 2814a12853 | Oct.12, 2023 | Oct.11, 2024 |

7. ANTENNA PORT TEST RESULTS

7.1. CONDUCTED OUTPUT POWER

LIMITS

| CFR 47 FCC Part15 (15.247) Subpart C ISED RSS-247 ISSUE 3 | | | |
|--------------------------------------------------------------|------------------|------------------|-----------------------|
| Section | Test Item | Limit | Frequency Range (MHz) |
| CFR 47 FCC 15.247(b)(3) ISED RSS-247 5.4 (d) | AVG Output Power | 1 watt or 30 dBm | 2400-2483.5 |

TEST PROCEDURE

Refer to ANSI C63.10-2013 clause 11.9.2.3.1.

Connect the EUT to a low loss RF cable from the antenna port to the power sensor (video bandwidth is greater than the occupied bandwidth).

Measure peak emission level, the indicated level is the average output power, after any corrections for external attenuators and cables.

The test result in dBm by adding $[10 \log (1 / D)]$, where D is the duty cycle.

TEST SETUP

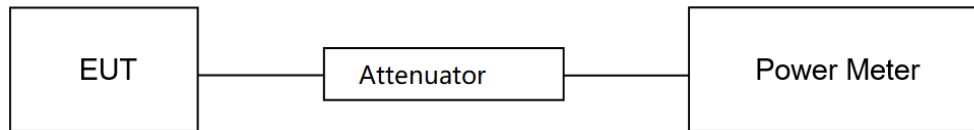

TEST ENVIRONMENT

| | | | |
|---------------------|--------|-------------------|--------------|
| Temperature | 25.2°C | Relative Humidity | 59.5% |
| Atmosphere Pressure | 101kPa | Test Voltage | AC 120V 60Hz |

TEST DATE / ENGINEER

| | | | |
|-----------|----------------|---------|-------------|
| Test Date | April 26, 2024 | Test By | Walker Yuan |
|-----------|----------------|---------|-------------|

TEST RESULTS

Please refer to section "Test Data" - Appendix C

7.2. 6DB BANDWIDTH AND 99% OCCUPIED BANDWIDTH

LIMITS

| CFR 47 FCC Part15 (15.247) Subpart C ISED RSS-247 ISSUE 3 | | | |
|--------------------------------------------------------------|-------------------------|------------------------------|-----------------------|
| Section | Test Item | Limit | Frequency Range (MHz) |
| CFR 47 FCC 15.247(a)(2) ISED RSS-247 5.2 (a) | 6 dB Bandwidth | ≥ 500 kHz | 2400-2483.5 |
| ISED RSS-Gen Clause 6.7 | 99 % Occupied Bandwidth | For reporting purposes only. | 2400-2483.5 |

TEST PROCEDURE

Refer to ANSI C63.10-2013 clause 11.8 for DTS bandwidth and clause 6.9 for Occupied Bandwidth.

Connect the EUT to the spectrum analyzer and use the following settings:

| | |
|------------------|---------------------------------------------------------------------------------------------------------------------------------------------------------------|
| Center Frequency | The center frequency of the channel under test |
| Frequency Span | For 6 dB Bandwidth: Enough to capture all products of the modulation carrier emission For 99 % Occupied Bandwidth: Between 1.5 times and 5.0 times the OBW |
| Detector | Peak |
| RBW | For 6 dB Bandwidth: 100 kHz For 99 % Occupied Bandwidth: 1 % to 5 % of the occupied bandwidth |
| VBW | For 6 dB Bandwidth: ≥3 × RBW For 99 % Occupied Bandwidth: ≥3 × RBW |
| Trace | Max hold |
| Sweep | Auto couple |

a) Use the 99 % power bandwidth function of the instrument, allow the trace to stabilize and report the measured bandwidth.

b) Allow the trace to stabilize and measure the maximum width of the emission that is constrained by the frequencies associated with the two outermost amplitude points (upper and lower frequencies) that are attenuated by 6 dB relative to the maximum level measured in the fundamental emission.

TEST SETUP

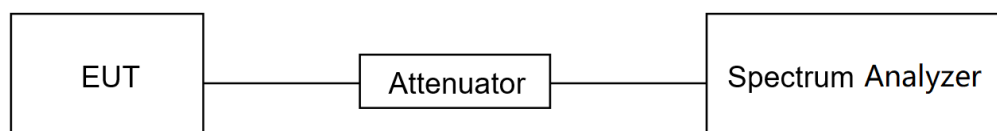

TEST ENVIRONMENT

| | | | |
|---------------------|--------|-------------------|--------------|
| Temperature | 25.2°C | Relative Humidity | 59.5% |
| Atmosphere Pressure | 101kPa | Test Voltage | AC 120V 60Hz |

TEST DATE / ENGINEER

| | | | |
|-----------|----------------|---------|-------------|
| Test Date | April 26, 2024 | Test By | Walker Yuan |
|-----------|----------------|---------|-------------|

TEST RESULTS

Please refer to section "Test Data" - Appendix A&B

7.3. POWER SPECTRAL DENSITY

LIMITS

| CFR 47 FCC Part15 (15.247) Subpart C ISED RSS-247 ISSUE 3 | | | |
|--------------------------------------------------------------|------------------------|-------------------------|-----------------------|
| Section | Test Item | Limit | Frequency Range (MHz) |
| CFR 47 FCC §15.247 (e) ISED RSS-247 5.2 (b) | Power Spectral Density | 8 dBm in any 3 kHz band | 2400-2483.5 |

TEST PROCEDURE

Refer to ANSI C63.10-2013 clause 11.10.2.

Connect the EUT to the spectrum analyzer and use the following settings:

| | |
|------------------|--------------------------------------------------------------|
| Center Frequency | The center frequency of the channel under test |
| Detector | power averaging (rms) |
| RBW | $3 \text{ kHz} \leq \text{RBW} \leq 100 \text{ kHz}$ |
| VBW | $\geq 3 \times \text{RBW}$ |
| Span | 1.5 x OBW bandwidth |
| Trace | Employ trace averaging(rms)mode over a minimum of 100 traces |
| Sweep time | Auto couple |

Allow trace to fully stabilize and use the peak marker function to determine the maximum amplitude level within the RBW.

If measured value exceeds limit, reduce RBW (no less than 3 kHz) and repeat.

TEST SETUP

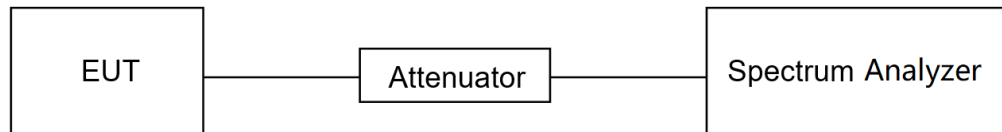

TEST ENVIRONMENT

| | | | |
|---------------------|--------|-------------------|--------------|
| Temperature | 25.2°C | Relative Humidity | 59.5% |
| Atmosphere Pressure | 101kPa | Test Voltage | AC 120V 60Hz |

TEST DATE / ENGINEER

| | | | |
|-----------|----------------|---------|-------------|
| Test Date | April 26, 2024 | Test By | Walker Yuan |
|-----------|----------------|---------|-------------|

TEST RESULTS

Please refer to section "Test Data" - Appendix D

7.4. CONDUCTED BAND EDGE AND SPURIOUS EMISSION

LIMITS

| CFR 47 FCC Part15 (15.247) Subpart C ISED RSS-247 ISSUE 3 | | |
|--------------------------------------------------------------|-------------------------------------------------|-------------------------------------------------------------------------------------------------------------------------------|
| Section | Test Item | Limit |
| CFR 47 FCC §15.247 (d) ISED RSS-247 5.5 | Conducted Bandedge and Spurious Emissions | at least 30 dB below that in the 100 kHz bandwidth within the band that contains the highest level of the desired power |

TEST PROCEDURE

Refer to ANSI C63.10-2013 clause 11.11 and 11.13.

Connect the EUT to the spectrum analyzer and use the following settings for reference level measurement:

| | |
|------------------|------------------------------------------------|
| Center Frequency | The center frequency of the channel under test |
| Detector | Peak |
| RBW | 100 kHz |
| VBW | $\geq 3 \times \text{RBW}$ |
| Span | 1.5 x DTS bandwidth |
| Trace | Max hold |
| Sweep time | Auto couple. |

Allow trace to fully stabilize and use the peak marker function to determine the maximum PSD level.

Change the settings for emission level measurement:

| | |
|--------------------|-------------------------------------------------------------------------------|
| Span | Set the center frequency and span to encompass frequency range to be measured |
| Detector | Peak |
| RBW | 100 kHz |
| VBW | $\geq 3 \times \text{RBW}$ |
| measurement points | $\geq \text{span}/\text{RBW}$ |
| Trace | Max hold |
| Sweep time | Auto couple. |

Allow trace to fully stabilize and use the peak marker function to determine the maximum PSD level. Ensure that the amplitude of all unwanted emissions outside of the authorized frequency band (excluding restricted frequency bands) is attenuated by at least the minimum requirements specified in 11.11.

TEST SETUP

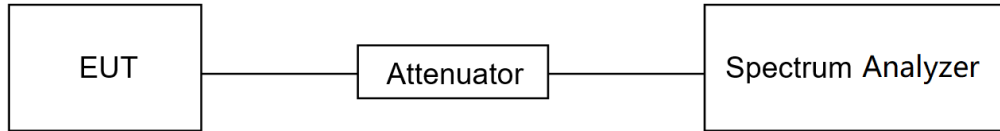

TEST ENVIRONMENT

| | | | |
|---------------------|--------|-------------------|--------------|
| Temperature | 25.2°C | Relative Humidity | 59.5% |
| Atmosphere Pressure | 101kPa | Test Voltage | AC 120V 60Hz |

TEST DATE / ENGINEER

| | | | |
|-----------|----------------|---------|-------------|
| Test Date | April 26, 2024 | Test By | Walker Yuan |
|-----------|----------------|---------|-------------|

TEST RESULTS

Please refer to section "Test Data" - Appendix E&F

7.5. DUTY CYCLE

LIMITS

None; for reporting purposes only.

TEST PROCEDURE

Refer to ANSI C63.10-2013 clause 11.6 Zero – Span Spectrum Analyzer method.

TEST SETUP

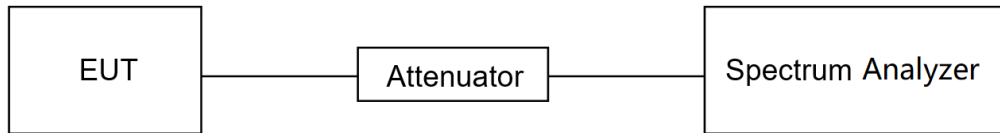

TEST ENVIRONMENT

| | | | |
|---------------------|--------|-------------------|--------------|
| Temperature | 25.2°C | Relative Humidity | 59.5% |
| Atmosphere Pressure | 101kPa | Test Voltage | AC 120V 60Hz |

TEST DATE / ENGINEER

| | | | |
|-----------|----------------|---------|-------------|
| Test Date | April 26, 2024 | Test By | Walker Yuan |
|-----------|----------------|---------|-------------|

TEST RESULTS

Please refer to section "Test Data" - Appendix G

8. RADIATED TEST RESULTS

LIMITS

Please refer to CFR 47 FCC §15.205 and §15.209.

Please refer to ISED RSS-GEN Clause 8.9 and Clause 8.10.

Radiation Disturbance Test Limit for FCC (Class B) (9 kHz ~ 1 GHz)

| Emissions radiated outside of the specified frequency bands above 30 MHz | | | |
|--------------------------------------------------------------------------|------------------------------------|--------------------------------------|---------|
| Frequency Range (MHz) | Field Strength Limit (uV/m) at 3 m | Field Strength Limit (dBuV/m) at 3 m | |
| | | Quasi-Peak | |
| 30 - 88 | 100 | 40 | |
| 88 - 216 | 150 | 43.5 | |
| 216 - 960 | 200 | 46 | |
| Above 960 | 500 | 54 | |
| Above 1000 | 500 | Peak | Average |
| | | 74 | 54 |

| FCC Emissions radiated outside of the specified frequency bands below 30 MHz | | |
|------------------------------------------------------------------------------|-----------------------------------|-------------------------------|
| Frequency (MHz) | Field strength (microvolts/meter) | Measurement distance (meters) |
| 0.009-0.490 | 2400/F(kHz) | 300 |
| 0.490-1.705 | 24000/F(kHz) | 30 |
| 1.705-30.0 | 30 | 30 |

ISED General field strength limits at frequencies below 30 MHz

| Table 6 – General field strength limits at frequencies below 30 MHz | | |
|---------------------------------------------------------------------|------------------------------------------|--------------------------|
| Frequency | Magnetic field strength (H-Field) (µA/m) | Measurement distance (m) |
| 9 - 490 kHz ^{Note 1} | 6.37/F (F in kHz) | 300 |
| 490 - 1705 kHz | 63.7/F (F in kHz) | 30 |
| 1.705 - 30 MHz | 0.08 | 30 |

Note 1: The emission limits for the ranges 9-90 kHz and 110-490 kHz are based on measurements employing a linear average detector.

ISED Restricted bands please refer to ISED RSS-GEN Clause 8.10

| Table 7 – Restricted frequency bands ^{Note 1} | | |
|--------------------------------------------------------|-----------------------|---------------|
| MHz | MHz | GHz |
| 0.090 - 0.110 | 149.9 - 150.05 | 9.0 - 9.2 |
| 0.495 - 0.505 | 156.52475 - 156.52525 | 9.3 - 9.5 |
| 2.1735 - 2.1905 | 156.7 - 156.9 | 10.6 - 12.7 |
| 3.020 - 3.026 | 162.0125 - 167.17 | 13.25 - 13.4 |
| 4.125 - 4.128 | 167.72 - 173.2 | 14.47 - 14.5 |
| 4.17725 - 4.17775 | 240 - 285 | 15.35 - 16.2 |
| 4.20725 - 4.20775 | 322 - 335.4 | 17.7 - 21.4 |
| 5.677 - 5.683 | 399.9 - 410 | 22.01 - 23.12 |
| 6.215 - 6.218 | 608 - 614 | 23.6 - 24.0 |
| 6.26775 - 6.26825 | 960 - 1427 | 31.2 - 31.8 |
| 6.31175 - 6.31225 | 1435 - 1626.5 | 36.43 - 36.5 |
| 8.291 - 8.294 | 1645.5 - 1646.5 | Above 38.6 |
| 8.362 - 8.366 | 1660 - 1710 | |
| 8.37625 - 8.38675 | 1718.8 - 1722.2 | |
| 8.41425 - 8.41475 | 2200 - 2300 | |
| 12.29 - 12.293 | 2310 - 2390 | |
| 12.51975 - 12.52025 | 2483.5 - 2500 | |
| 12.57675 - 12.57725 | 2655 - 2900 | |
| 13.36 - 13.41 | 3260 - 3267 | |
| 16.42 - 16.423 | 3332 - 3339 | |
| 16.69475 - 16.69525 | 3345.8 - 3358 | |
| 16.80425 - 16.80475 | 3500 - 4400 | |
| 25.5 - 25.67 | 4500 - 5150 | |
| 37.5 - 38.25 | 5350 - 5460 | |
| 73 - 74.6 | 7250 - 7750 | |
| 74.8 - 75.2 | 8025 - 8500 | |
| 108 - 138 | | |

Note 1: Certain frequency bands listed in table 7 and in bands above 38.6 GHz are designated for licence-exempt applications. These frequency bands and the requirements that apply to related devices are set out in the 200 and 300 series of RSSs.

FCC Restricted bands of operation refer to FCC §15.205 (a):

| MHz | MHz | MHz | GHz |
|--------------------------|---------------------|---------------|------------------|
| 0.090-0.110 | 16.42-16.423 | 399.9-410 | 4.5-5.15 |
| ¹ 0.495-0.505 | 16.69475-16.69525 | 608-614 | 5.35-5.46 |
| 2.1735-2.1905 | 16.80425-16.80475 | 960-1240 | 7.25-7.75 |
| 4.125-4.128 | 25.5-25.67 | 1300-1427 | 8.025-8.5 |
| 4.17725-4.17775 | 37.5-38.25 | 1435-1626.5 | 9.0-9.2 |
| 4.20725-4.20775 | 73-74.6 | 1645.5-1646.5 | 9.3-9.5 |
| 6.215-6.218 | 74.8-75.2 | 1660-1710 | 10.6-12.7 |
| 6.26775-6.26825 | 108-121.94 | 1718.8-1722.2 | 13.25-13.4 |
| 6.31175-6.31225 | 123-138 | 2200-2300 | 14.47-14.5 |
| 8.291-8.294 | 149.9-150.05 | 2310-2390 | 15.35-16.2 |
| 8.362-8.366 | 156.52475-156.52525 | 2483.5-2500 | 17.7-21.4 |
| 8.37625-8.38675 | 156.7-156.9 | 2690-2900 | 22.01-23.12 |
| 8.41425-8.41475 | 162.0125-167.17 | 3260-3267 | 23.6-24.0 |
| 12.29-12.293 | 167.72-173.2 | 3332-3339 | 31.2-31.8 |
| 12.51975-12.52025 | 240-285 | 3345.8-3358 | 36.43-36.5 |
| 12.57675-12.57725 | 322-335.4 | 3600-4400 | (²) |
| 13.36-13.41 | | | |

Note: ¹Until February 1, 1999, this restricted band shall be 0.490-0.510 MHz.

²Above 38.6c

TEST SETUP AND PROCEDURE

Below 30 MHz

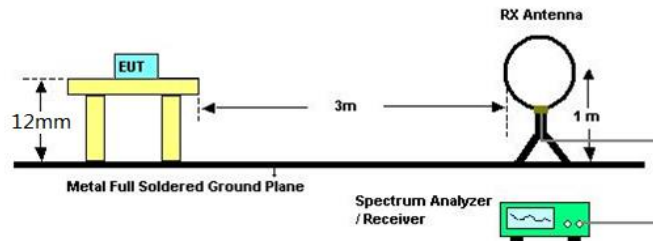

The setting of the spectrum analyser

| | |
|-------|------------------------------------------------------------------|
| RBW | 200 Hz (From 9 kHz to 0.15 MHz)/ 9 kHz (From 0.15 MHz to 30 MHz) |
| VBW | 200 Hz (From 9 kHz to 0.15 MHz)/ 9 kHz (From 0.15 MHz to 30 MHz) |
| Sweep | Auto |
| Trace | Max hold |

1. The testing follows the guidelines in ANSI C63.10-2013 clause 6.4.
2. The EUT was arranged to its worst case and then turntable (from 0 degree to 360 degrees) to find the maximum reading. A pre-amp and a high pass filter are used for the test in order to get better signal level. Both Horizontal, Face-on and Face-off polarizations of the antenna are set to make the measurement.
3. The EUT was placed on a turntable with 12 mm above ground.
4. The EUT was set 3 meters from the interference receiving antenna, which was mounted on the top of a 1 m height antenna tower.
5. The radiated emission limits are based on measurements employing a CISPR quasi-peak detector except for the frequency bands 9-90 kHz, 110-490 kHz and above 1000 MHz. Radiated emission limits in these three bands are based on measurements employing an average detector.
6. For measurement below 1 GHz, the initial step in collecting conducted emission data is a spectrum analyzer peak detector mode pre-scanning the measurement frequency range. Significant peaks are then marked and then Quasi Peak and average detector mode re-measured. If the emission level of the EUT measured by the peak detector is 3 dB lower than the applicable limit, the peak emission level will be reported. Otherwise, the emission measurement will be repeated using the quasi-peak and average detector and reported.
7. Although these tests were performed other than open field site, adequate comparison measurements were confirmed against 30 m open field site. Therefore sufficient tests were made to demonstrate that the alternative site produces results that correlate with the ones of tests made in an open field site based on KDB 414788.
8. The limits in CFR 47, Part 15, Subpart C, paragraph 15.209 (a), are identical to those in RSS-GEN Section 8.9, Table 6, since the measurements are performed in terms of magnetic field strength and converted to electric field strength levels (as reported in the table) using the free space impedance of 377 Ω . For example, the measurement frequency X kHz resulted in a level of Y dBuV/m, which is equivalent to $Y-51.5 = Z$ dBuA/m, which has the same margin, W dB, to the corresponding RSS-GEN Table 6 limit as it has to be 15.209(a) limit.

Below 1 GHz and above 30 MHz

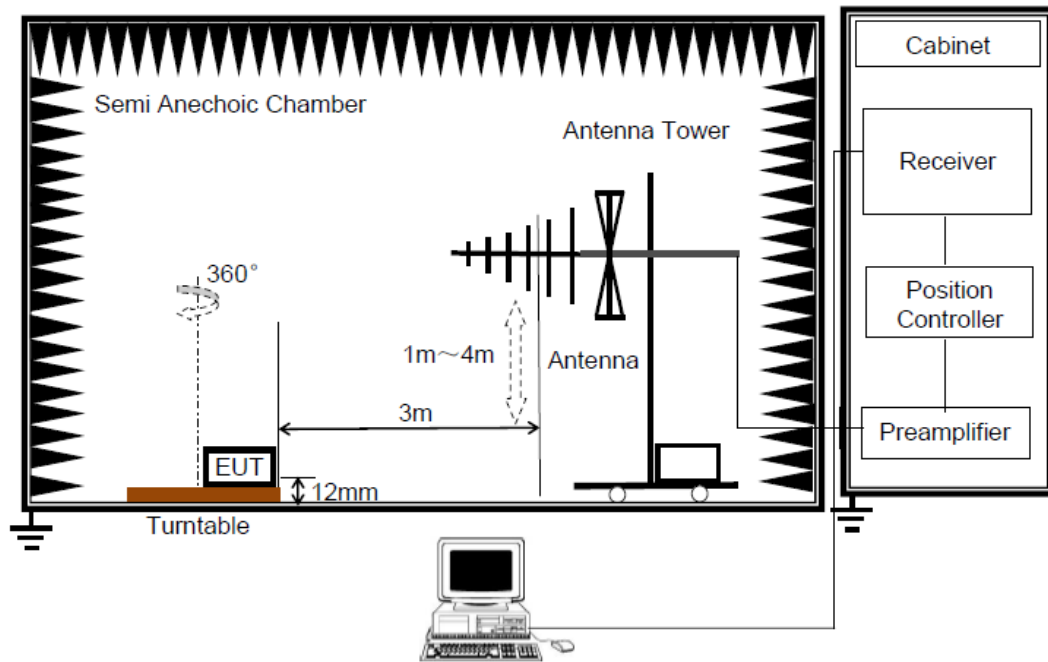

The setting of the spectrum analyser

| | |
|----------|----------|
| RBW | 120 kHz |
| VBW | 300 kHz |
| Sweep | Auto |
| Detector | Peak/QP |
| Trace | Max hold |

1. The testing follows the guidelines in ANSI C63.10-2013 clause 6.5.
2. The EUT was arranged to its worst case and then tune the antenna tower (from 1 m to 4 m) and turntable (from 0 degree to 360 degrees) to find the maximum reading. A pre-amp and a high pass filter are used for the test in order to get better signal level. Both horizontal and vertical polarizations of the antenna are set to make the measurement.
3. The EUT was placed on a turntable with 12 mm above ground.
4. The EUT was set 3 meters from the interference receiving antenna, which was mounted on the top of a variable height antenna tower.
5. For measurement below 1 GHz, the initial step in collecting conducted emission data is a spectrum analyzer peak detector mode pre-scanning the measurement frequency range. Significant peaks are then marked and then Quasi Peak detector mode re-measured. If the emission level of the EUT measured by the peak detector is 3 dB lower than the applicable limit, the peak emission level will be reported. Otherwise, the emission measurement will be repeated using the quasi-peak detector and reported.

Above 1 GHz

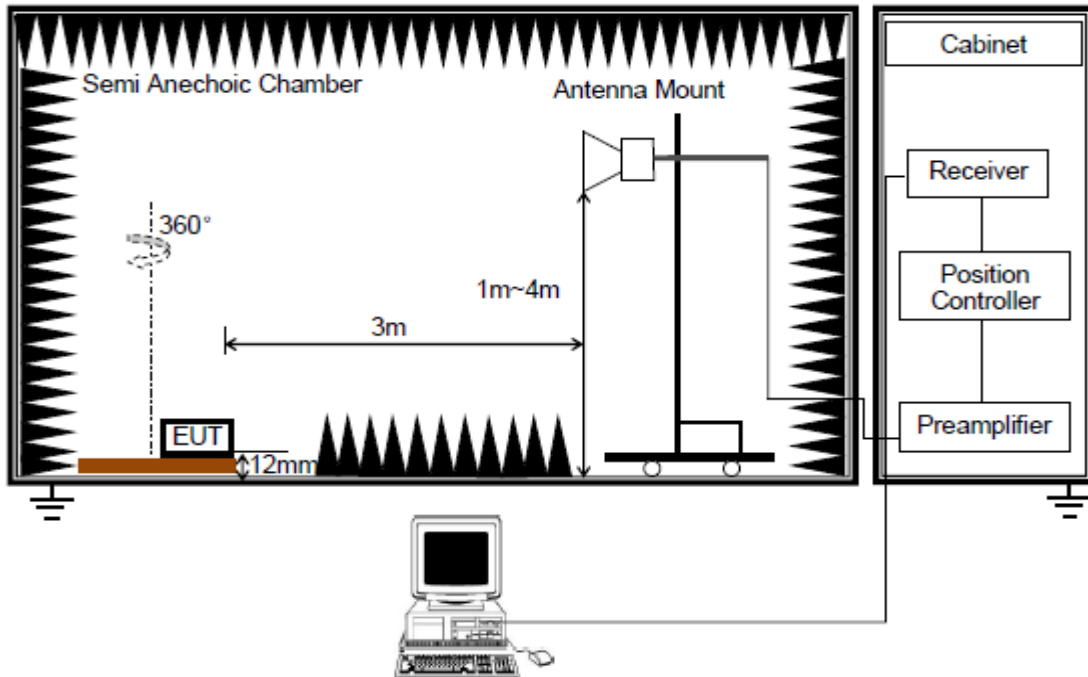

The setting of the spectrum analyser

| | |
|----------|--------------------------------|
| RBW | 1 MHz |
| VBW | PEAK: 3 MHz AVG: see note 6 |
| Sweep | Auto |
| Detector | Peak |
| Trace | Max hold |

1. The testing follows the guidelines in ANSI C63.10-2013 clause 6.6.
2. The EUT was arranged to its worst case and then tune the antenna tower (from 1 m to 4 m) and turntable (from 0 degree to 360 degrees) to find the maximum reading. A pre-amp and a high pass filter are used for the test in order to get better signal level. Both horizontal and vertical polarizations of the antenna are set to make the measurement.
3. The EUT was placed on a turntable with 12 mm above ground.
4. The EUT was set 3 meters from the interference receiving antenna, which was mounted on the top of a variable height antenna tower.
5. For measurement above 1 GHz, the emission measurement will be measured by the peak detector. This peak level, once corrected, must comply with the limit specified in Section 15.209.
6. For measurements above 1 GHz the resolution bandwidth is set to 1 MHz, then the video bandwidth is set to 3 MHz for peak measurements and 1 MHz resolution bandwidth with 1/T video bandwidth with peak detector for average measurements. For the Duty Cycle please refer to clause 7.5.ON TIME AND DUTY CYCLE.

Note 1: The manufacturer has recommended that the EUT only be used in the desktop (horizontal) orientation; therefore, all radiated testing was performed in desktop orientation.

For Restricted Bandedge:

Note:

1. Measurement = Reading Level + Correct Factor.
2. If the peak values are less than the average limit of 54 dBuV/m, the average result is deemed to comply with average limit.
3. PK=Peak: Peak detector.
4. AV=Average: $VBW=1/Ton$, where: Ton is the transmitting duration.
5. For the transmitting duration, please refer to clause 7.5.
6. Only the worst data was recorded, if it complies with the limit, the other emissions deemed to comply with the limit.
7. Both horizontal and vertical have been tested, only the worst data was recorded in the report.
8. All modes have been tested, but only the worst data was recorded in the report.

For Radiate Spurious emission (9 kHz ~ 30 MHz):

Note:

1. Measurement = Reading Level + Correct Factor.
2. If the peak values are less than the QP limit, the QP result is deemed to comply with QP limit.
3. All 3 polarizations (Horizontal, Face-on and Face-off) of the loop antenna had been tested, but only the worst data recorded in the report.
4. All modes have been tested, but only the worst data was recorded in the report.
5. $dBuA/m = dBuV/m - 20\log_{10}[120\pi] = dBuV/m - 51.5$

For Radiate Spurious Emission (30 MHz ~ 1 GHz):

Note:

1. Result Level = Read Level + Correct Factor.
2. If the peak values are less than the QP limit, the QP result is deemed to comply with QP limit.
3. All modes have been tested, but only the worst data was recorded in the report.

For Radiate Spurious Emission (1 GHz ~ 3 GHz):

Note:

1. Measurement = Reading Level + Correct Factor.
2. If the peak values are less than the average limit of 54 dBuV/m, the average result is deemed to comply with average limit.
3. Peak: Peak detector.
4. AVG: $VBW=1/Ton$, where: Ton is the transmitting duration.
5. For the transmitting duration, please refer to clause 7.5.
6. Filter losses were only considered in the spurious frequency bands and the authorized band was not corrected for Band reject filter losses.
7. Proper operation of the transmitter prior to adding the filter to the measurement chain.
8. All modes have been tested, but only the worst data was recorded in the report.

For Radiate Spurious Emission (3 GHz ~ 18 GHz):

Note:

1. Peak Result = Reading Level + Correct Factor.
2. If the peak values are less than the average limit of 54 dBuV/m, the average result is deemed to comply with average limit.
3. Peak: Peak detector.
4. AVG: $VBW=1/Ton$, where: Ton is the transmitting duration.
5. For the transmitting duration, please refer to clause 7.5.
6. Filter losses were only considered in the spurious frequency bands and the authorized band was not corrected for High Pass Filter losses.
7. Proper operation of the transmitter prior to adding the filter to the measurement chain.
8. All modes have been tested, but only the worst data was recorded in the report.

For Radiate Spurious emission (18 GHz ~ 26 GHz):

Note:

1. Measurement = Reading Level + Correct Factor.
2. If the peak values are less than the average limit of 54 dBuV/m, the average result is deemed to comply with average limit.
3. Peak: Peak detector.
4. All modes have been tested, but only the worst data was recorded in the report.

TEST ENVIRONMENT

| | | | |
|---------------------|--------|-------------------|-------|
| Temperature | 24.6°C | Relative Humidity | 62.7% |
| Atmosphere Pressure | 101kPa | Test Voltage | |

TEST DATE / ENGINEER

| | | | |
|-----------|----------------|---------|------------|
| Test Date | April 28, 2024 | Test By | Mason Wang |
|-----------|----------------|---------|------------|

TEST RESULTS

8.1. RESTRICTED BANDEDGE

| | | | |
|------------|------------|-----------------|--------------|
| Test Mode: | 802.11b PK | Frequency(MHz): | 2412 |
| Polarity: | Horizontal | Test Voltage: | AC 120V_60Hz |

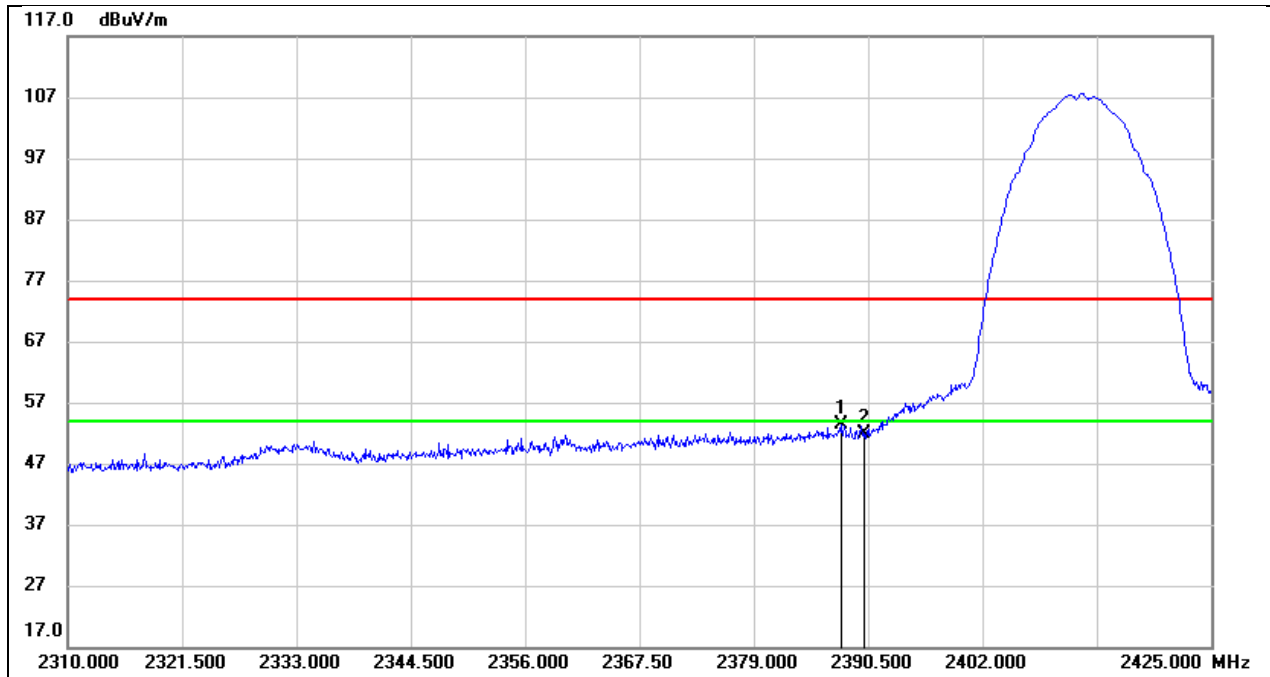

| No. | Frequency (MHz) | Reading (dBuV) | Correct (dB/m) | Result (dBuV/m) | Limit (dBuV/m) | Margin (dB) | Remark |
|-----|-----------------|----------------|----------------|-----------------|----------------|-------------|--------|
| 1 | 2387.740 | 20.53 | 32.91 | 53.44 | 74.00 | -20.56 | peak |
| 2 | 2390.000 | 18.97 | 32.92 | 51.89 | 74.00 | -22.11 | peak |

| | | | |
|------------|------------|-----------------|--------------|
| Test Mode: | 802.11b AV | Frequency(MHz): | 2412 |
| Polarity: | Horizontal | Test Voltage: | AC 120V_60Hz |

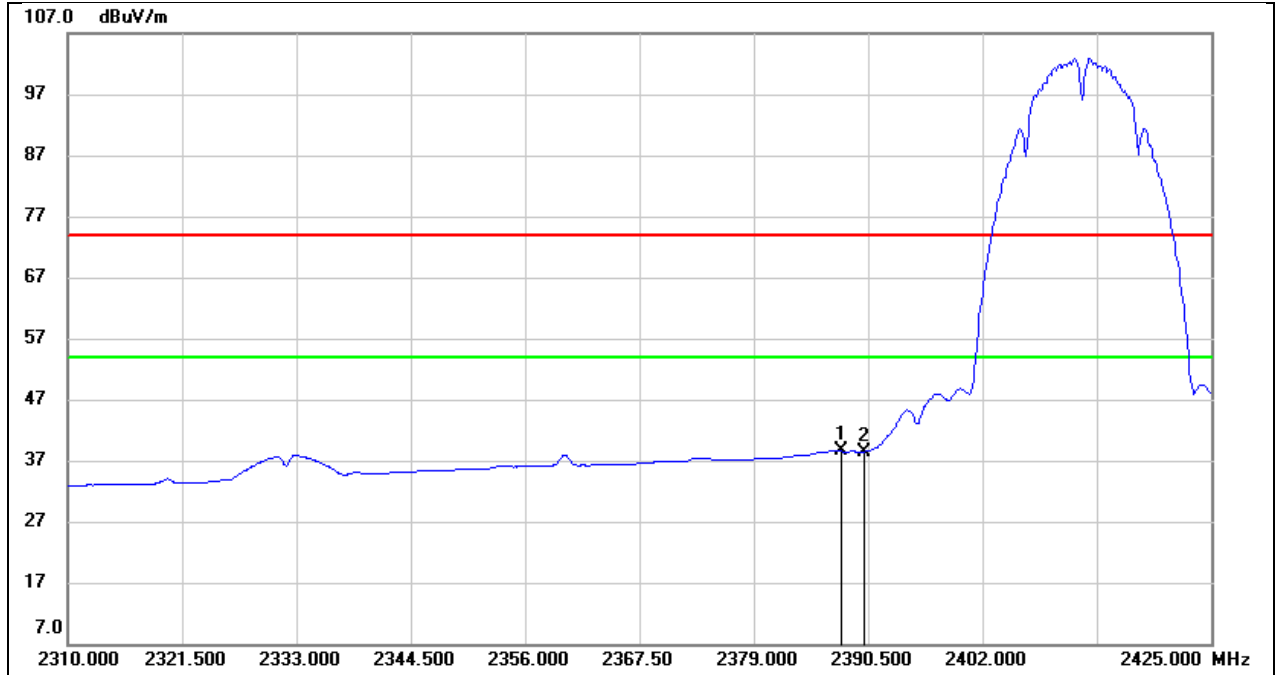

| No. | Frequency (MHz) | Reading (dBuV) | Correct (dB/m) | Result (dBuV/m) | Limit (dBuV/m) | Margin (dB) | Remark |
|-----|-----------------|----------------|----------------|-----------------|----------------|-------------|--------|
| 1 | 2387.740 | 5.64 | 32.91 | 38.55 | 54.00 | -15.45 | AVG |
| 2 | 2390.000 | 5.55 | 32.92 | 38.47 | 54.00 | -15.53 | AVG |

| | | | |
|------------|------------|-----------------|--------------|
| Test Mode: | 802.11b PK | Frequency(MHz): | 2412 |
| Polarity: | Vertical | Test Voltage: | AC 120V_60Hz |

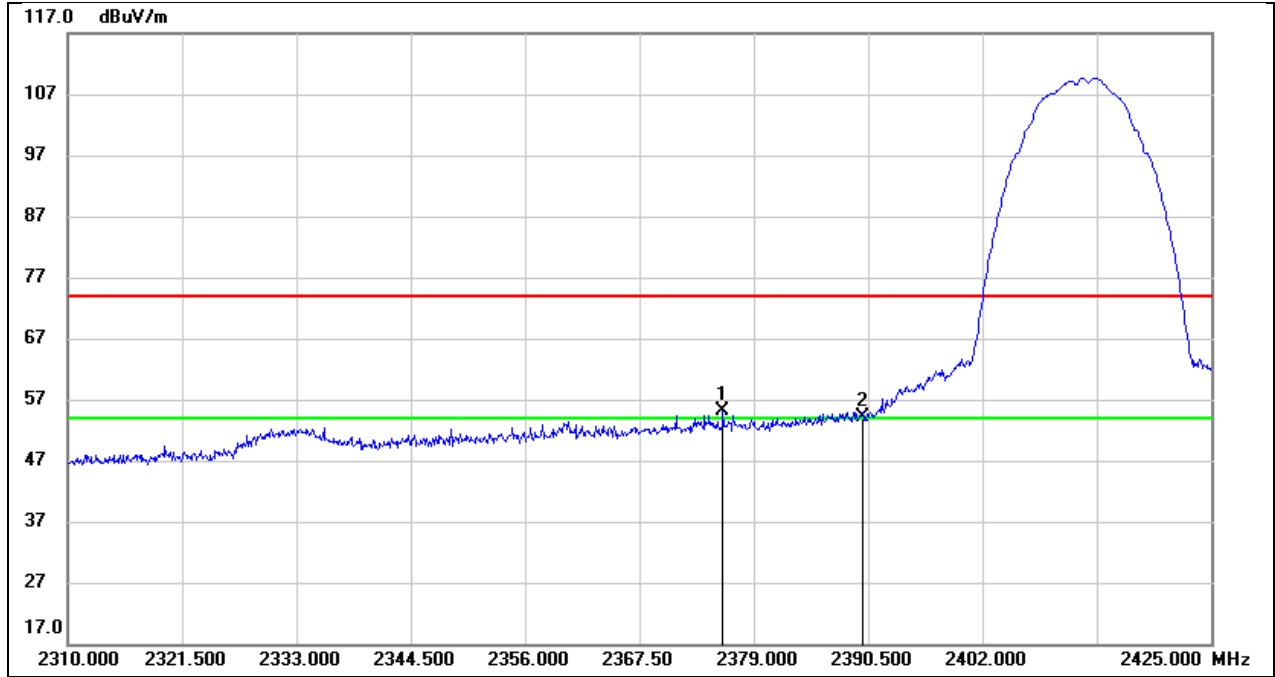

| No. | Frequency (MHz) | Reading (dBuV) | Correct (dB/m) | Result (dBuV/m) | Limit (dBuV/m) | Margin (dB) | Remark |
|-----|-----------------|----------------|----------------|-----------------|----------------|-------------|--------|
| 1 | 2375.895 | 22.22 | 32.85 | 55.07 | 74.00 | -18.93 | peak |
| 2 | 2390.000 | 21.19 | 32.92 | 54.11 | 74.00 | -19.89 | peak |

| | | | |
|------------|------------|-----------------|--------------|
| Test Mode: | 802.11b AV | Frequency(MHz): | 2412 |
| Polarity: | Vertical | Test Voltage: | AC 120V_60Hz |

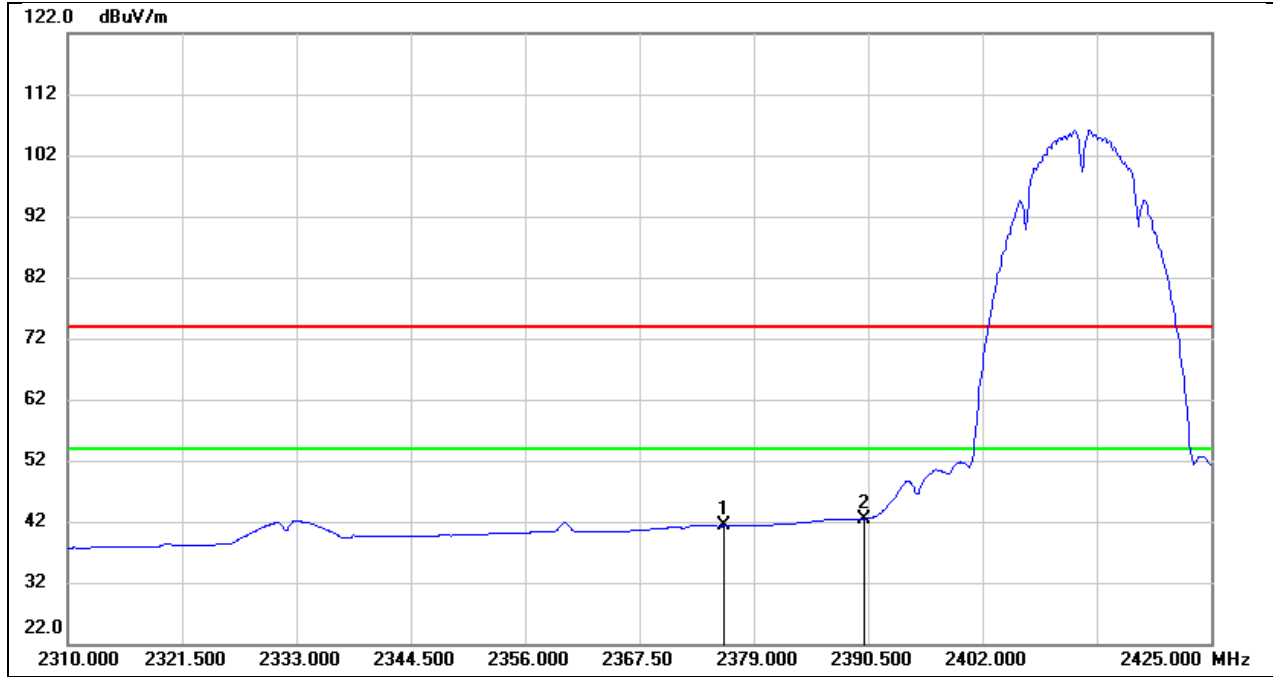

| No. | Frequency (MHz) | Reading (dBuV) | Correct (dB/m) | Result (dBuV/m) | Limit (dBuV/m) | Margin (dB) | Remark |
|-----|-----------------|----------------|----------------|-----------------|----------------|-------------|--------|
| 1 | 2375.895 | 8.43 | 32.85 | 41.28 | 54.00 | -12.72 | AVG |
| 2 | 2390.000 | 9.51 | 32.92 | 42.43 | 54.00 | -11.57 | AVG |

| | | | |
|------------|------------|-----------------|--------------|
| Test Mode: | 802.11b PK | Frequency(MHz): | 2462 |
| Polarity: | Vertical | Test Voltage: | AC 120V_60Hz |

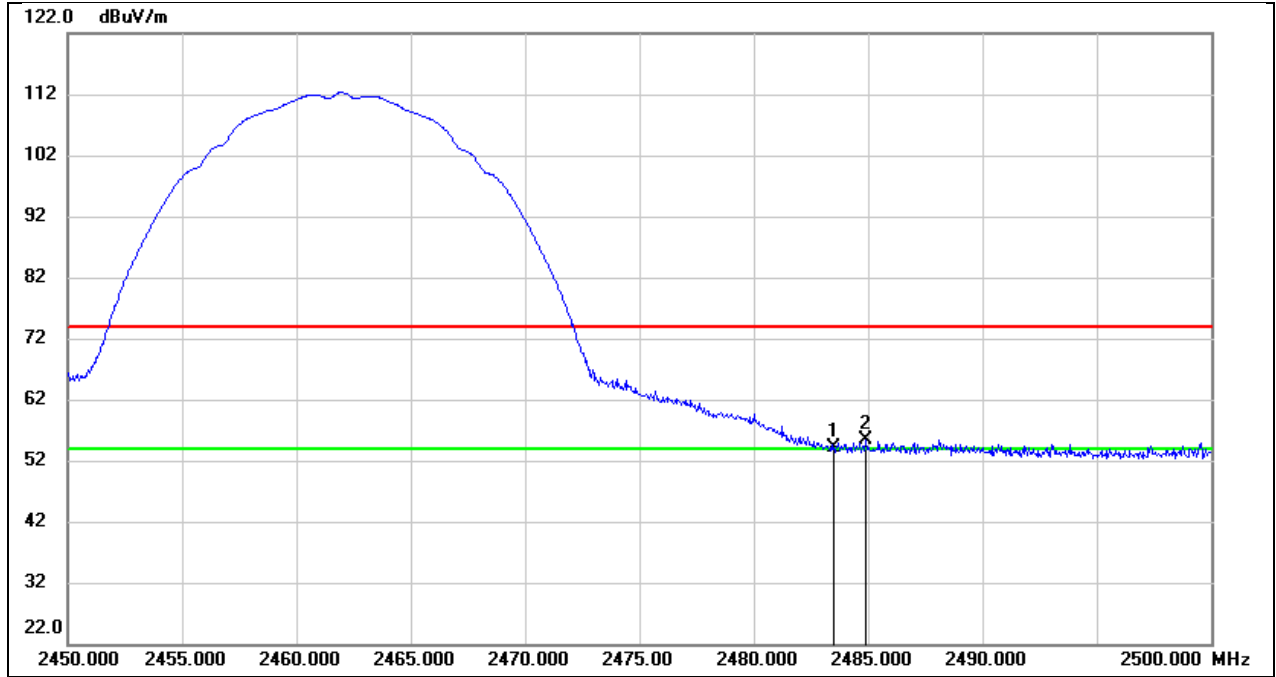

| No. | Frequency (MHz) | Reading (dBuV) | Correct (dB/m) | Result (dBuV/m) | Limit (dBuV/m) | Margin (dB) | Remark |
|-----|-----------------|----------------|----------------|-----------------|----------------|-------------|--------|
| 1 | 2483.500 | 21.30 | 32.94 | 54.24 | 74.00 | -19.76 | peak |
| 2 | 2484.900 | 22.53 | 32.94 | 55.47 | 74.00 | -18.53 | peak |

| | | | |
|------------|------------|-----------------|--------------|
| Test Mode: | 802.11b AV | Frequency(MHz): | 2462 |
| Polarity: | Vertical | Test Voltage: | AC 120V_60Hz |

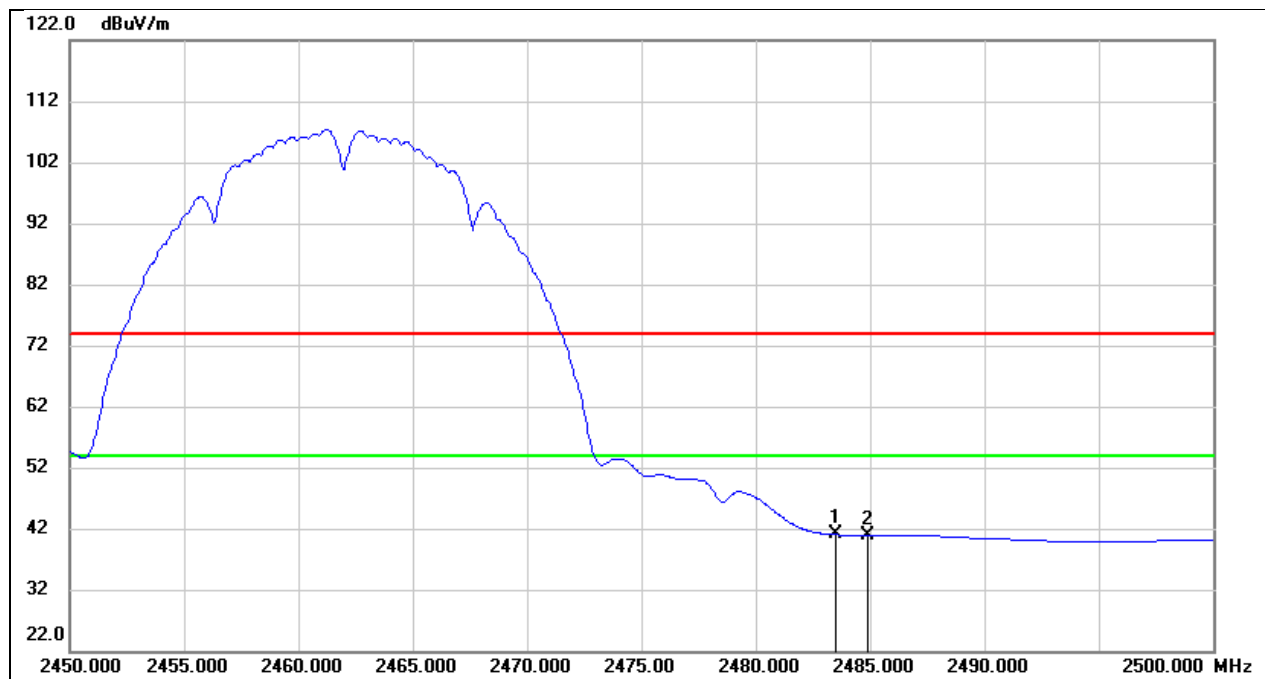

| No. | Frequency (MHz) | Reading (dBuV) | Correct (dB/m) | Result (dBuV/m) | Limit (dBuV/m) | Margin (dB) | Remark |
|-----|-----------------|----------------|----------------|-----------------|----------------|-------------|--------|
| 1 | 2483.500 | 8.09 | 32.94 | 41.03 | 54.00 | -12.97 | AVG |
| 2 | 2484.900 | 7.86 | 32.94 | 40.80 | 54.00 | -13.20 | AVG |

| | | | |
|------------|------------|-----------------|--------------|
| Test Mode: | 802.11g PK | Frequency(MHz): | 2412 |
| Polarity: | Vertical | Test Voltage: | AC 120V_60Hz |

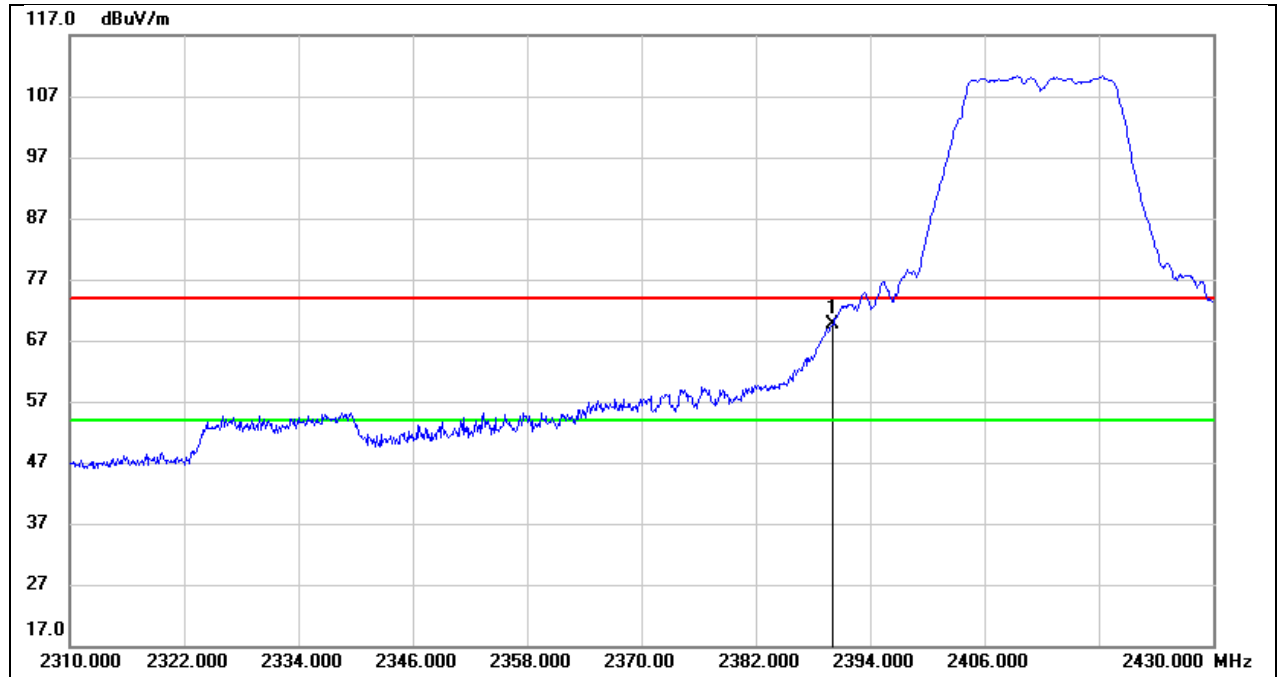

| No. | Frequency (MHz) | Reading (dBuV) | Correct (dB/m) | Result (dBuV/m) | Limit (dBuV/m) | Margin (dB) | Remark |
|-----|-----------------|----------------|----------------|-----------------|----------------|-------------|--------|
| 1 | 2390.000 | 36.69 | 32.92 | 69.61 | 74.00 | -4.39 | peak |

| | | | |
|------------|------------|-----------------|--------------|
| Test Mode: | 802.11g AV | Frequency(MHz): | 2412 |
| Polarity: | Vertical | Test Voltage: | AC 120V_60Hz |

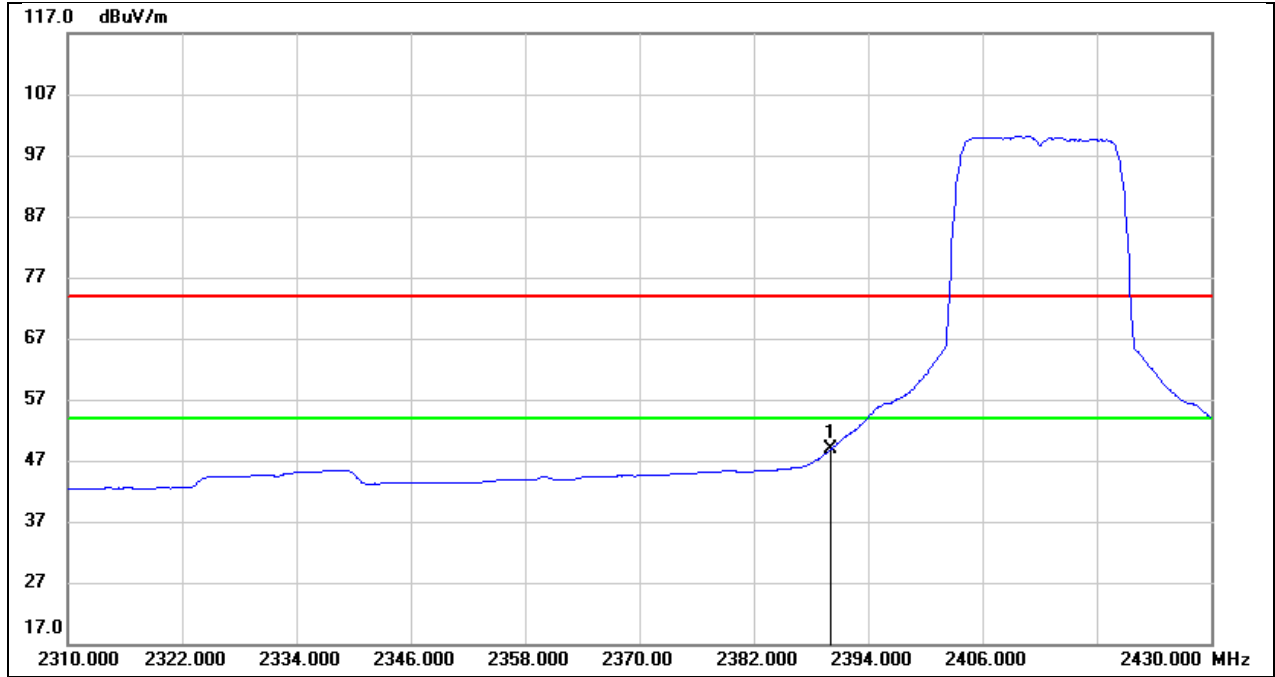

| No. | Frequency (MHz) | Reading (dBuV) | Correct (dB/m) | Result (dBuV/m) | Limit (dBuV/m) | Margin (dB) | Remark |
|-----|-----------------|----------------|----------------|-----------------|----------------|-------------|--------|
| 1 | 2390.000 | 15.91 | 32.92 | 48.83 | 54.00 | -5.17 | AVG |

| | | | |
|------------|------------|-----------------|--------------|
| Test Mode: | 802.11g PK | Frequency(MHz): | 2462 |
| Polarity: | Vertical | Test Voltage: | AC 120V_60Hz |

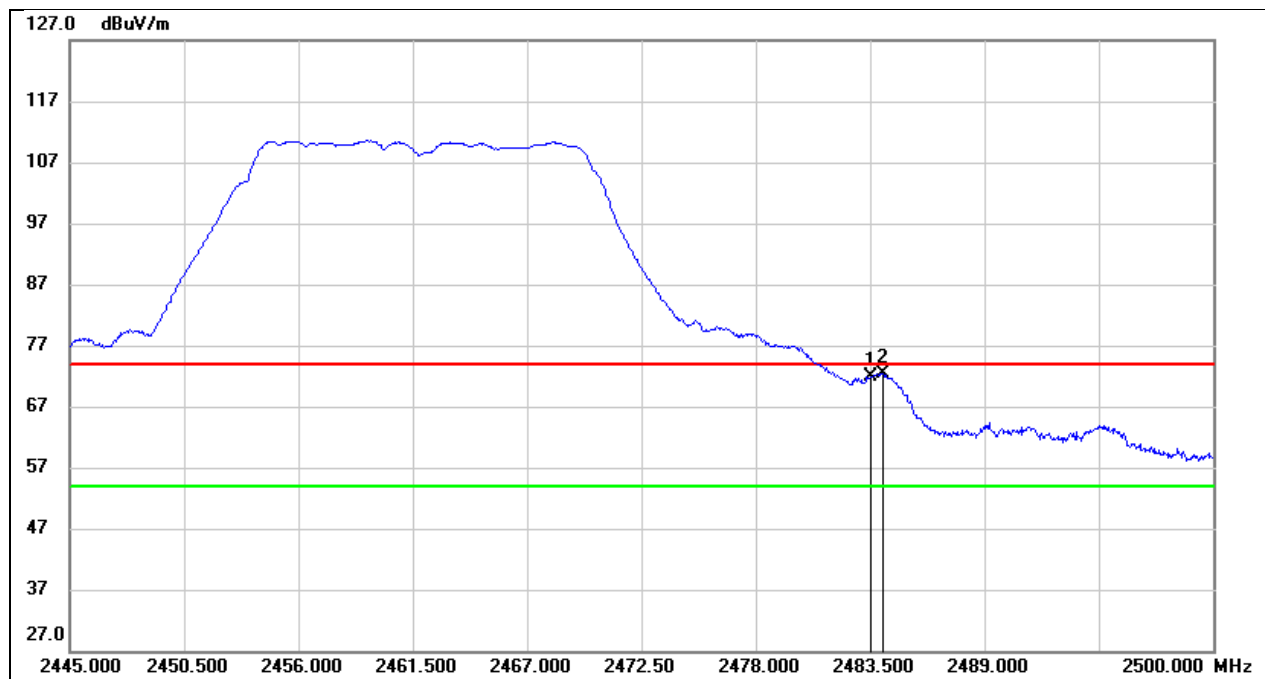

| No. | Frequency (MHz) | Reading (dBuV) | Correct (dB/m) | Result (dBuV/m) | Limit (dBuV/m) | Margin (dB) | Remark |
|-----|-----------------|----------------|----------------|-----------------|----------------|-------------|--------|
| 1 | 2483.500 | 38.99 | 32.94 | 71.93 | 74.00 | -2.07 | peak |
| 2 | 2484.105 | 39.47 | 32.94 | 72.41 | 74.00 | -1.59 | peak |

| | | | |
|------------|------------|-----------------|--------------|
| Test Mode: | 802.11g AV | Frequency(MHz): | 2462 |
| Polarity: | Vertical | Test Voltage: | AC 120V_60Hz |

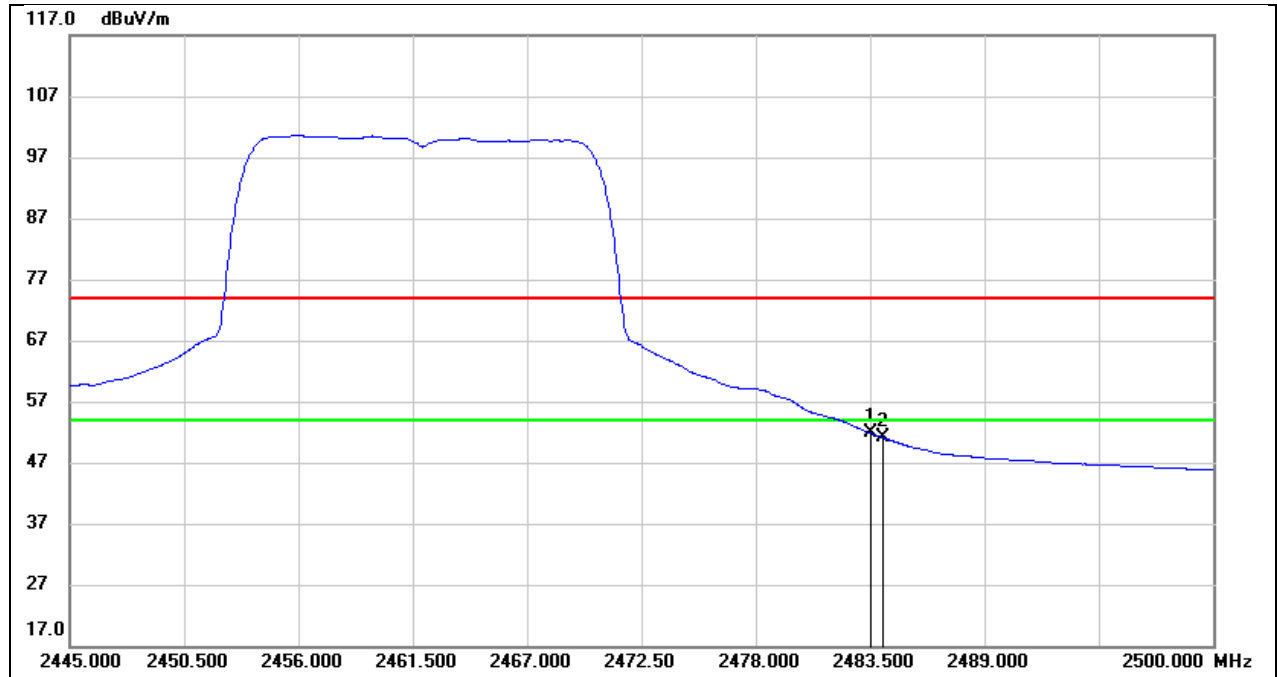

| No. | Frequency (MHz) | Reading (dBuV) | Correct (dB/m) | Result (dBuV/m) | Limit (dBuV/m) | Margin (dB) | Remark |
|-----|-----------------|----------------|----------------|-----------------|----------------|-------------|--------|
| 1 | 2483.500 | 18.87 | 32.94 | 51.81 | 54.00 | -2.19 | AVG |
| 2 | 2484.105 | 18.14 | 32.94 | 51.08 | 54.00 | -2.92 | AVG |

| | | | |
|------------|-----------------|-----------------|--------------|
| Test Mode: | 802.11n HT20 PK | Frequency(MHz): | 2412 |
| Polarity: | Vertical | Test Voltage: | AC 120V_60Hz |

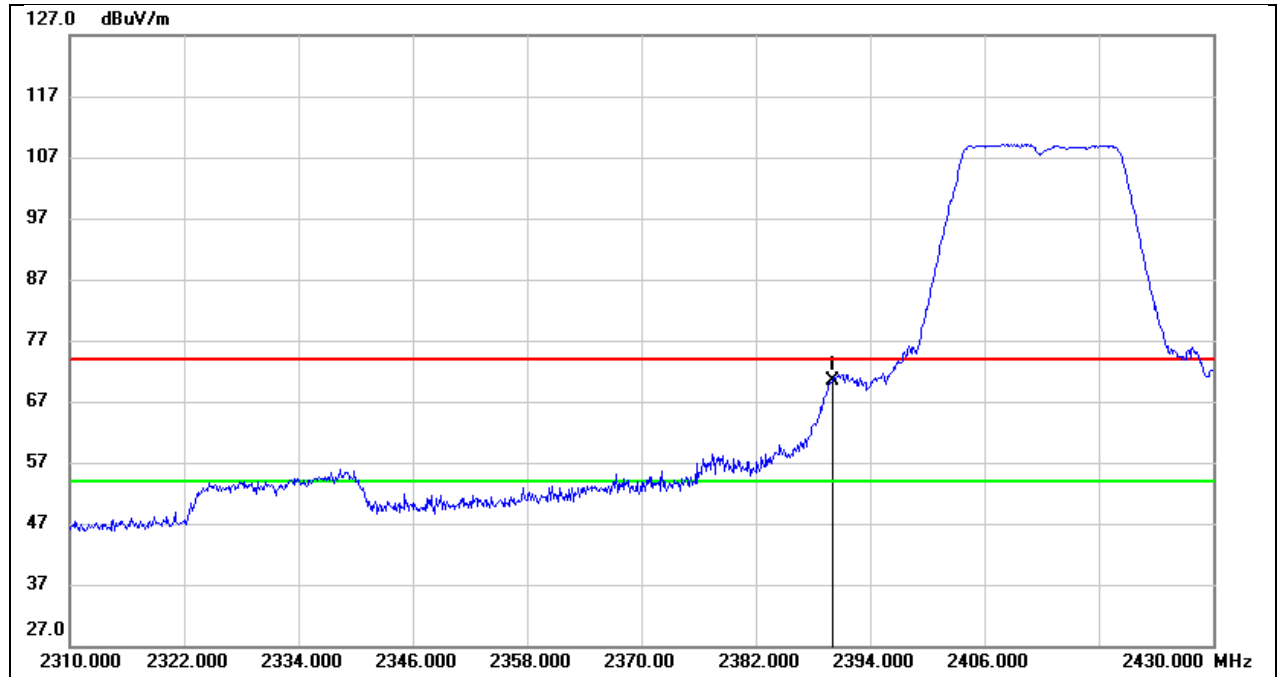

| No. | Frequency (MHz) | Reading (dBuV) | Correct (dB/m) | Result (dBuV/m) | Limit (dBuV/m) | Margin (dB) | Remark |
|-----|-----------------|----------------|----------------|-----------------|----------------|-------------|--------|
| 1 | 2390.000 | 37.47 | 32.92 | 70.39 | 74.00 | -3.61 | peak |

| | | | |
|------------|-----------------|-----------------|--------------|
| Test Mode: | 802.11n HT20 AV | Frequency(MHz): | 2412 |
| Polarity: | Vertical | Test Voltage: | AC 120V_60Hz |

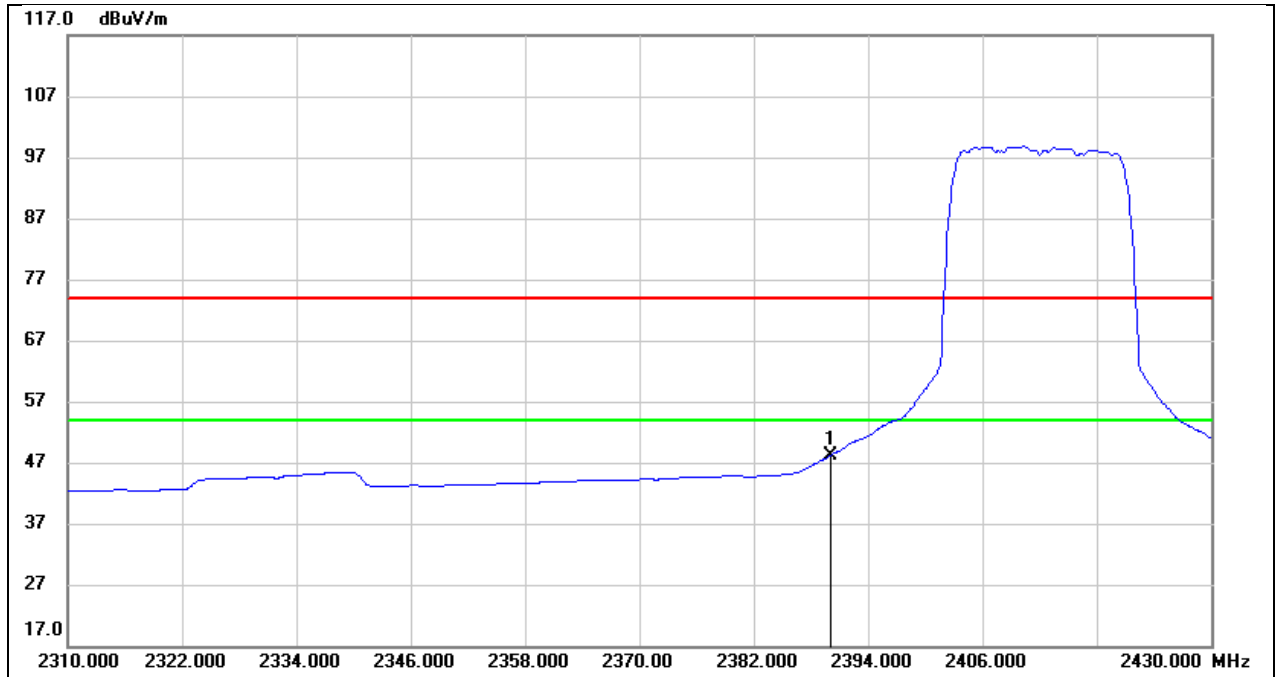

| No. | Frequency (MHz) | Reading (dBuV) | Correct (dB/m) | Result (dBuV/m) | Limit (dBuV/m) | Margin (dB) | Remark |
|-----|-----------------|----------------|----------------|-----------------|----------------|-------------|--------|
| 1 | 2390.000 | 15.32 | 32.92 | 48.24 | 54.00 | -5.76 | AVG |

| | | | |
|------------|-----------------|-----------------|--------------|
| Test Mode: | 802.11n HT20 PK | Frequency(MHz): | 2462 |
| Polarity: | Vertical | Test Voltage: | AC 120V_60Hz |

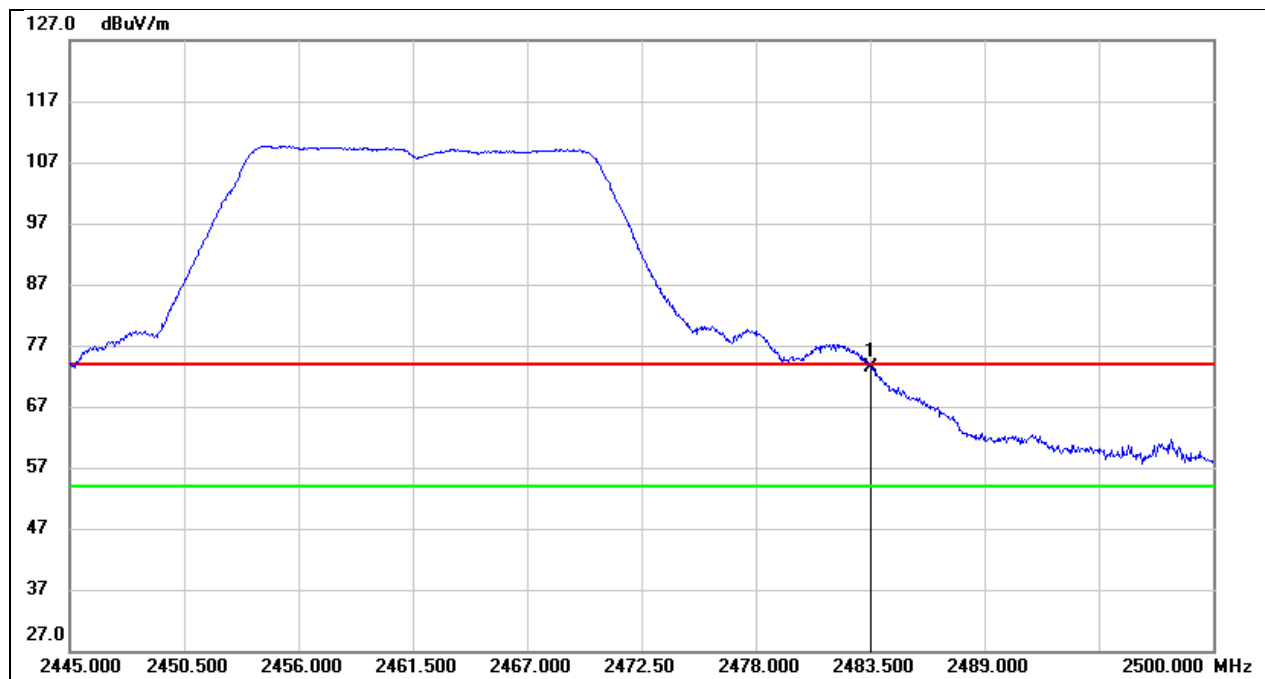

| No. | Frequency (MHz) | Reading (dBuV) | Correct (dB/m) | Result (dBuV/m) | Limit (dBuV/m) | Margin (dB) | Remark |
|-----|-----------------|----------------|----------------|-----------------|----------------|-------------|--------|
| 1 | 2483.500 | 40.47 | 32.94 | 73.41 | 74.00 | -0.59 | peak |

| | | | |
|------------|-----------------|-----------------|--------------|
| Test Mode: | 802.11n HT20 AV | Frequency(MHz): | 2462 |
| Polarity: | Vertical | Test Voltage: | AC 120V_60Hz |

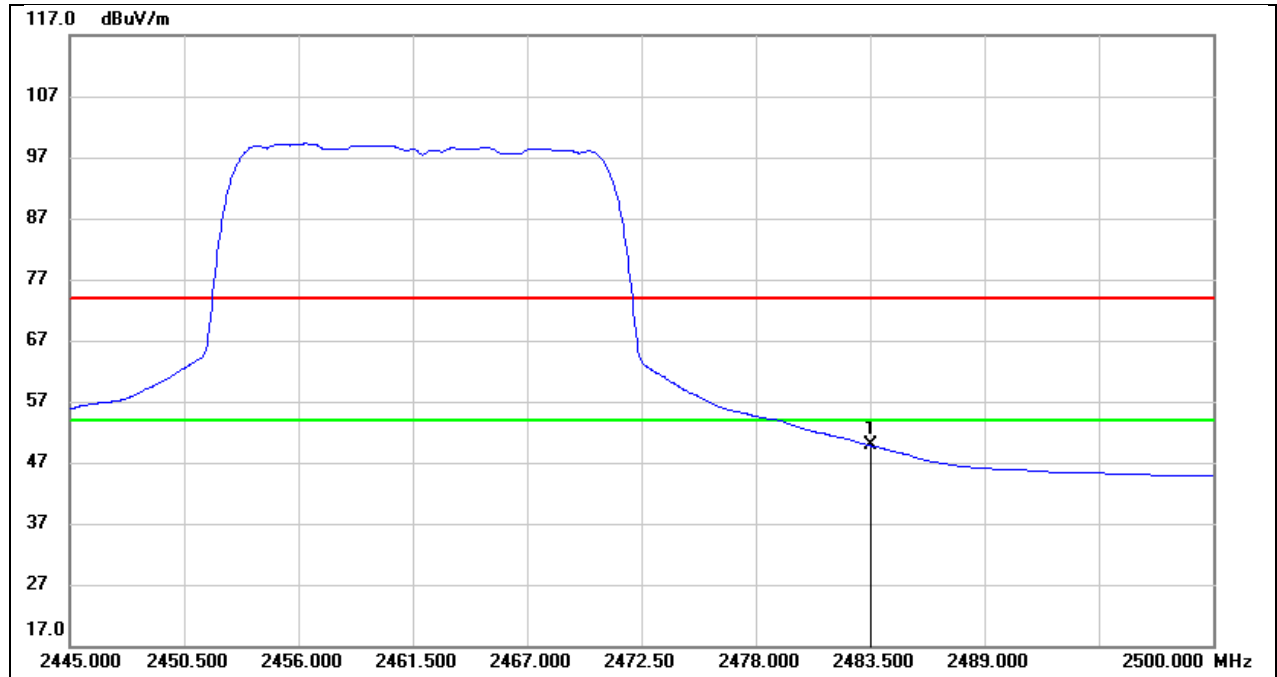

| No. | Frequency (MHz) | Reading (dBuV) | Correct (dB/m) | Result (dBuV/m) | Limit (dBuV/m) | Margin (dB) | Remark |
|-----|-----------------|----------------|----------------|-----------------|----------------|-------------|--------|
| 1 | 2483.500 | 16.90 | 32.94 | 49.84 | 54.00 | -4.16 | AVG |

8.2. SPURIOUS EMISSIONS(1 GHZ~3 GHZ)

| | | | |
|------------|------------|-----------------|--------------|
| Test Mode: | 802.11b | Frequency(MHz): | 2412 |
| Polarity: | Horizontal | Test Voltage: | AC 120V_60Hz |

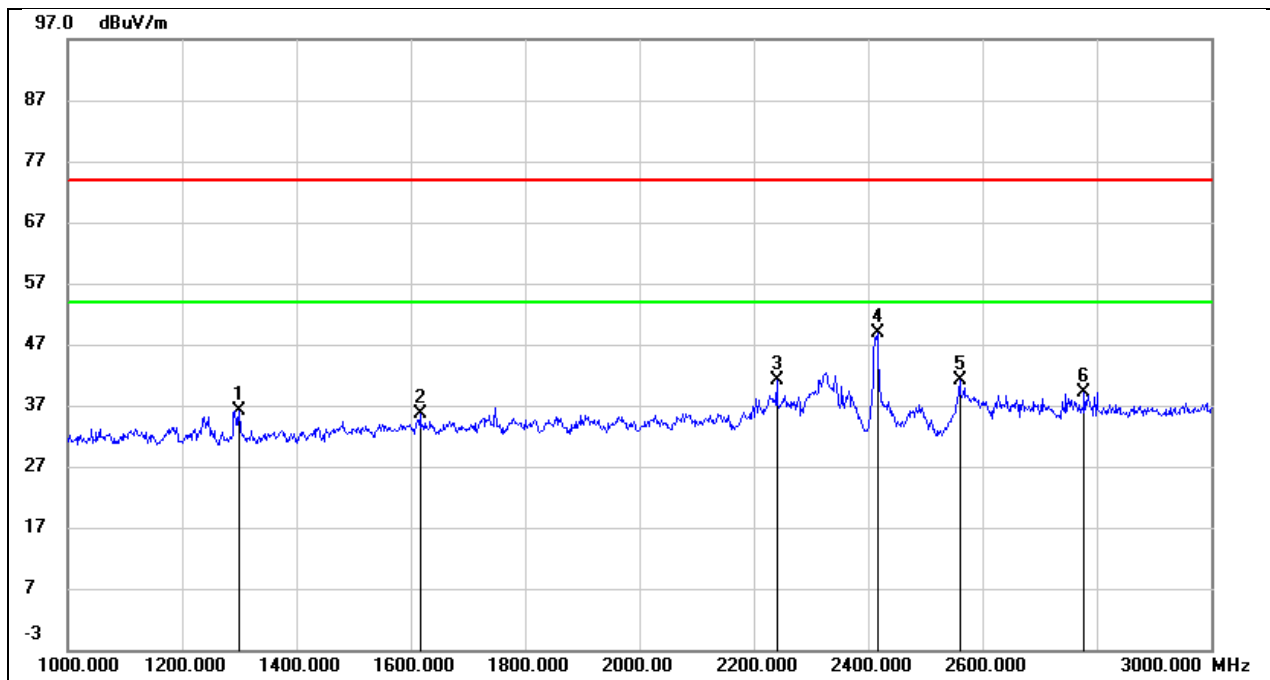

| No. | Frequency (MHz) | Reading (dBuV) | Correct (dB/m) | Result (dBuV/m) | Limit (dBuV/m) | Margin (dB) | Remark |
|-----|-----------------|----------------|----------------|-----------------|----------------|-------------|-------------|
| 1 | 1300.000 | 48.74 | -12.53 | 36.21 | 74.00 | -37.79 | peak |
| 2 | 1616.000 | 46.60 | -11.09 | 35.51 | 74.00 | -38.49 | peak |
| 3 | 2240.000 | 49.67 | -8.59 | 41.08 | 74.00 | -32.92 | peak |
| 4 | 2412.000 | 56.24 | -7.42 | 48.82 | / | / | fundamental |
| 5 | 2560.000 | 48.78 | -7.61 | 41.17 | 74.00 | -32.83 | peak |
| 6 | 2778.000 | 46.09 | -6.90 | 39.19 | 74.00 | -34.81 | peak |

| | | | |
|------------|----------|-----------------|--------------|
| Test Mode: | 802.11b | Frequency(MHz): | 2412 |
| Polarity: | Vertical | Test Voltage: | AC 120V_60Hz |

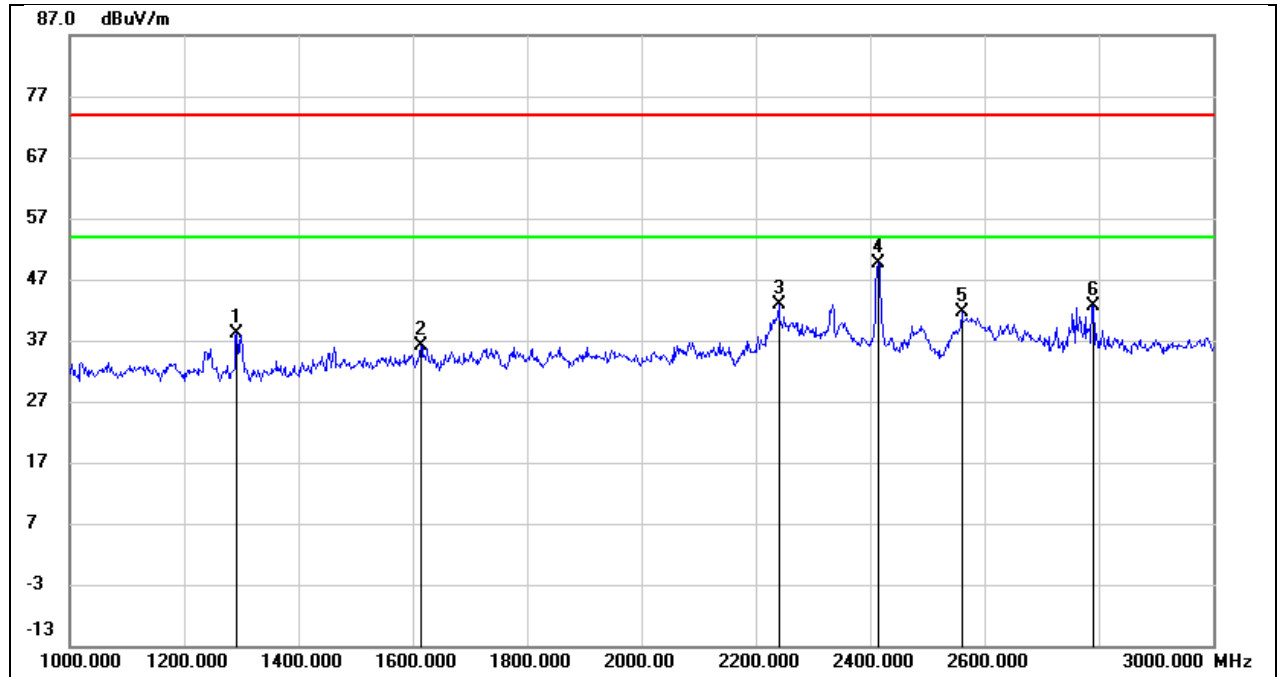

| No. | Frequency (MHz) | Reading (dBuV) | Correct (dB/m) | Result (dBuV/m) | Limit (dBuV/m) | Margin (dB) | Remark |
|-----|-----------------|----------------|----------------|-----------------|----------------|-------------|-------------|
| 1 | 1292.000 | 50.59 | -12.54 | 38.05 | 74.00 | -35.95 | peak |
| 2 | 1614.000 | 47.24 | -11.11 | 36.13 | 74.00 | -37.87 | peak |
| 3 | 2240.000 | 51.46 | -8.59 | 42.87 | 74.00 | -31.13 | peak |
| 4 | 2412.000 | 56.93 | -7.41 | 49.52 | / | / | fundamental |
| 5 | 2560.000 | 49.13 | -7.61 | 41.52 | 74.00 | -32.48 | peak |
| 6 | 2790.000 | 49.47 | -6.85 | 42.62 | 74.00 | -31.38 | peak |

| | | | |
|------------|------------|-----------------|--------------|
| Test Mode: | 802.11b | Frequency(MHz): | 2437 |
| Polarity: | Horizontal | Test Voltage: | AC 120V_60Hz |

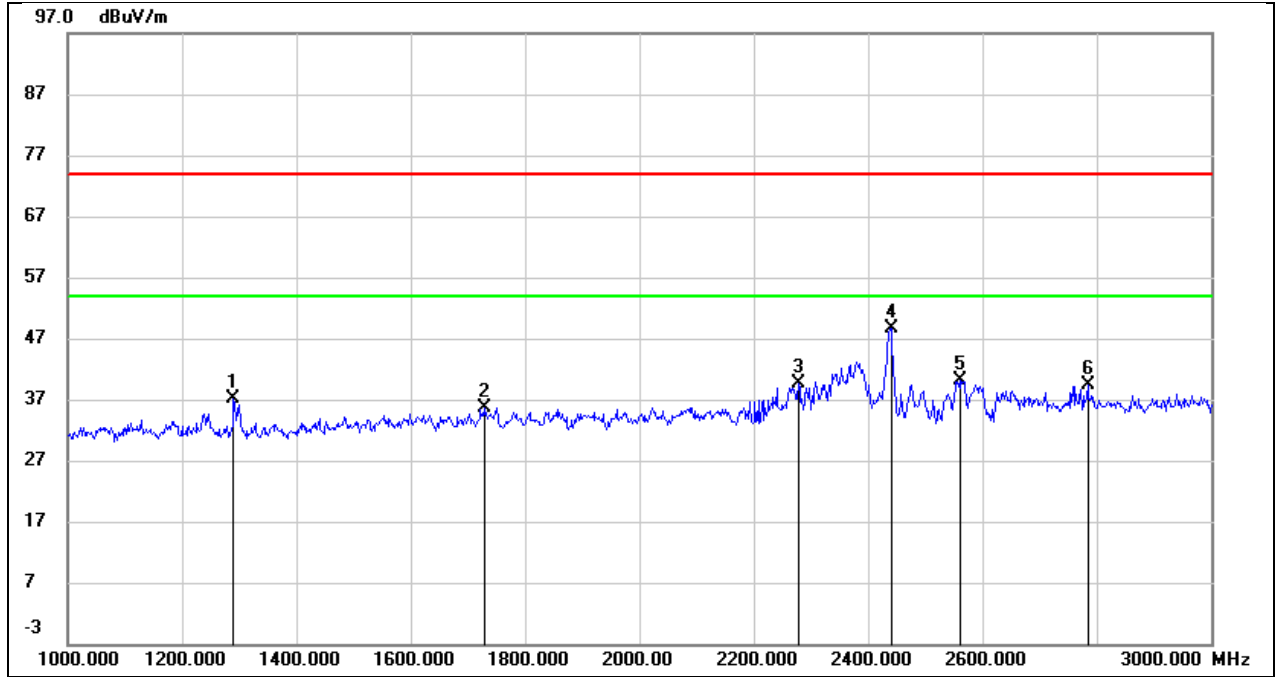

| No. | Frequency (MHz) | Reading (dBuV) | Correct (dB/m) | Result (dBuV/m) | Limit (dBuV/m) | Margin (dB) | Remark |
|-----|-----------------|----------------|----------------|-----------------|----------------|-------------|-------------|
| 1 | 1290.000 | 49.55 | -12.53 | 37.02 | 74.00 | -36.98 | peak |
| 2 | 1728.000 | 46.31 | -10.57 | 35.74 | 74.00 | -38.26 | peak |
| 3 | 2278.000 | 48.00 | -8.31 | 39.69 | 74.00 | -34.31 | peak |
| 4 | 2437.000 | 56.18 | -7.44 | 48.74 | / | / | fundamental |
| 5 | 2560.000 | 47.78 | -7.61 | 40.17 | 74.00 | -33.83 | peak |
| 6 | 2784.000 | 46.22 | -6.87 | 39.35 | 74.00 | -34.65 | peak |

| | | | |
|------------|----------|-----------------|--------------|
| Test Mode: | 802.11b | Frequency(MHz): | 2437 |
| Polarity: | Vertical | Test Voltage: | AC 120V_60Hz |

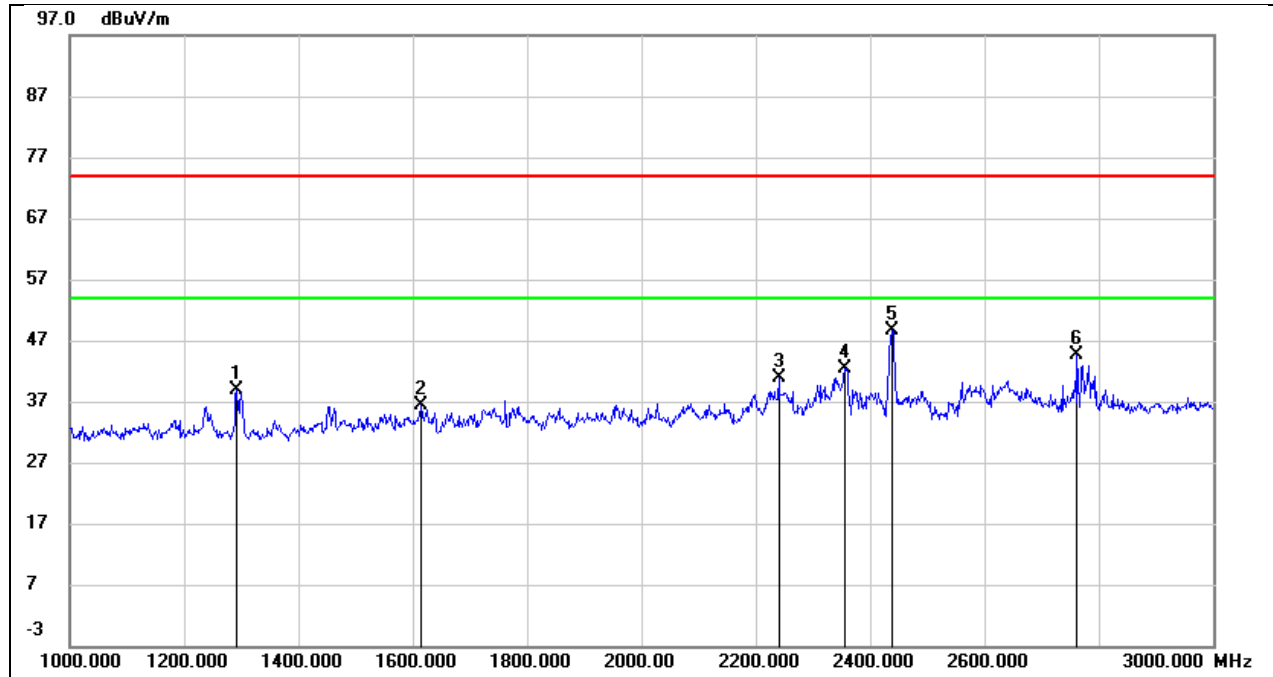

| No. | Frequency (MHz) | Reading (dBuV) | Correct (dB/m) | Result (dBuV/m) | Limit (dBuV/m) | Margin (dB) | Remark |
|-----|-----------------|----------------|----------------|-----------------|----------------|-------------|-------------|
| 1 | 1292.000 | 51.30 | -12.54 | 38.76 | 74.00 | -35.24 | peak |
| 2 | 1614.000 | 47.52 | -11.11 | 36.41 | 74.00 | -37.59 | peak |
| 3 | 2240.000 | 49.36 | -8.59 | 40.77 | 74.00 | -33.23 | peak |
| 4 | 2356.000 | 50.14 | -7.72 | 42.42 | 74.00 | -31.58 | peak |
| 5 | 2437.000 | 55.99 | -7.43 | 48.56 | / | / | fundamental |
| 6 | 2762.000 | 51.50 | -6.97 | 44.53 | 74.00 | -29.47 | peak |

| | | | |
|------------|------------|-----------------|--------------|
| Test Mode: | 802.11b | Frequency(MHz): | 2462 |
| Polarity: | Horizontal | Test Voltage: | AC 120V_60Hz |

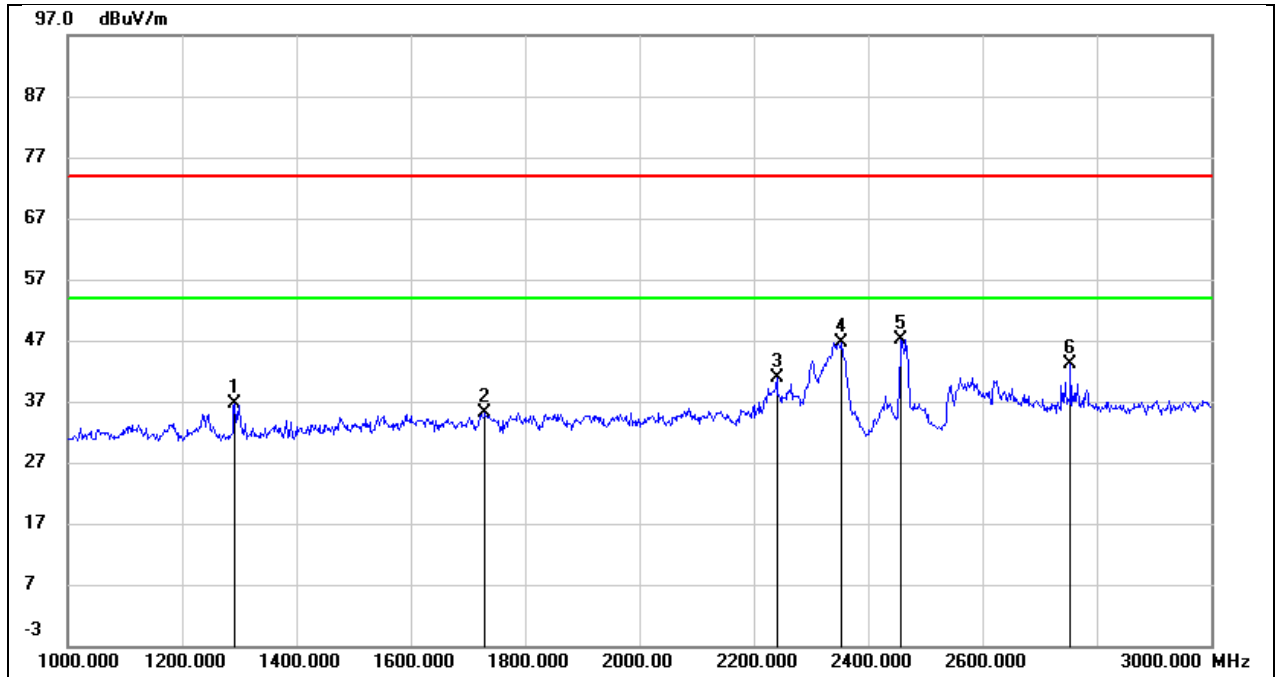

| No. | Frequency (MHz) | Reading (dBuV) | Correct (dB/m) | Result (dBuV/m) | Limit (dBuV/m) | Margin (dB) | Remark |
|-----|-----------------|----------------|----------------|-----------------|----------------|-------------|-------------|
| 1 | 1292.000 | 49.22 | -12.54 | 36.68 | 74.00 | -37.32 | peak |
| 2 | 1730.000 | 45.67 | -10.57 | 35.10 | 74.00 | -38.90 | peak |
| 3 | 2240.000 | 49.39 | -8.59 | 40.80 | 74.00 | -33.20 | peak |
| 4 | 2354.000 | 54.27 | -7.74 | 46.53 | 74.00 | -27.47 | peak |
| 5 | 2462.000 | 54.71 | -7.46 | 47.25 | / | / | fundamental |
| 6 | 2754.000 | 50.10 | -7.00 | 43.10 | 74.00 | -30.90 | peak |

| | | | |
|------------|----------|-----------------|--------------|
| Test Mode: | 802.11b | Frequency(MHz): | 2462 |
| Polarity: | Vertical | Test Voltage: | AC 120V_60Hz |

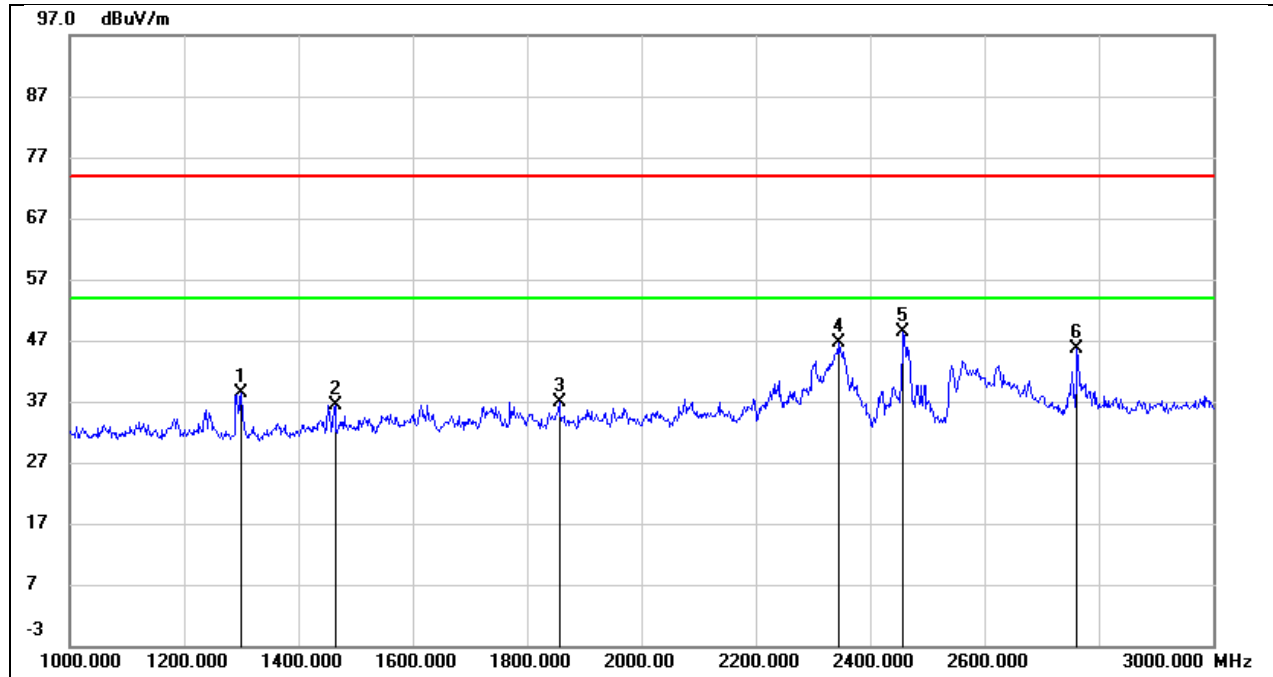

| No. | Frequency (MHz) | Reading (dBuV) | Correct (dB/m) | Result (dBuV/m) | Limit (dBuV/m) | Margin (dB) | Remark |
|-----|-----------------|----------------|----------------|-----------------|----------------|-------------|-------------|
| 1 | 1300.000 | 51.03 | -12.53 | 38.50 | 74.00 | -35.50 | peak |
| 2 | 1464.000 | 48.42 | -11.98 | 36.44 | 74.00 | -37.56 | peak |
| 3 | 1856.000 | 47.11 | -10.21 | 36.90 | 74.00 | -37.10 | peak |
| 4 | 2344.000 | 54.40 | -7.82 | 46.58 | 74.00 | -27.42 | peak |
| 5 | 2462.000 | 55.94 | -7.46 | 48.48 | / | / | fundamental |
| 6 | 2762.000 | 52.49 | -6.97 | 45.52 | 74.00 | -28.48 | peak |

8.3. SPURIOUS EMISSIONS(3 GHZ~18 GHZ)

| | | | |
|------------|------------|-----------------|--------------|
| Test Mode: | 802.11b | Frequency(MHz): | 2412 |
| Polarity: | Horizontal | Test Voltage: | AC 120V_60Hz |

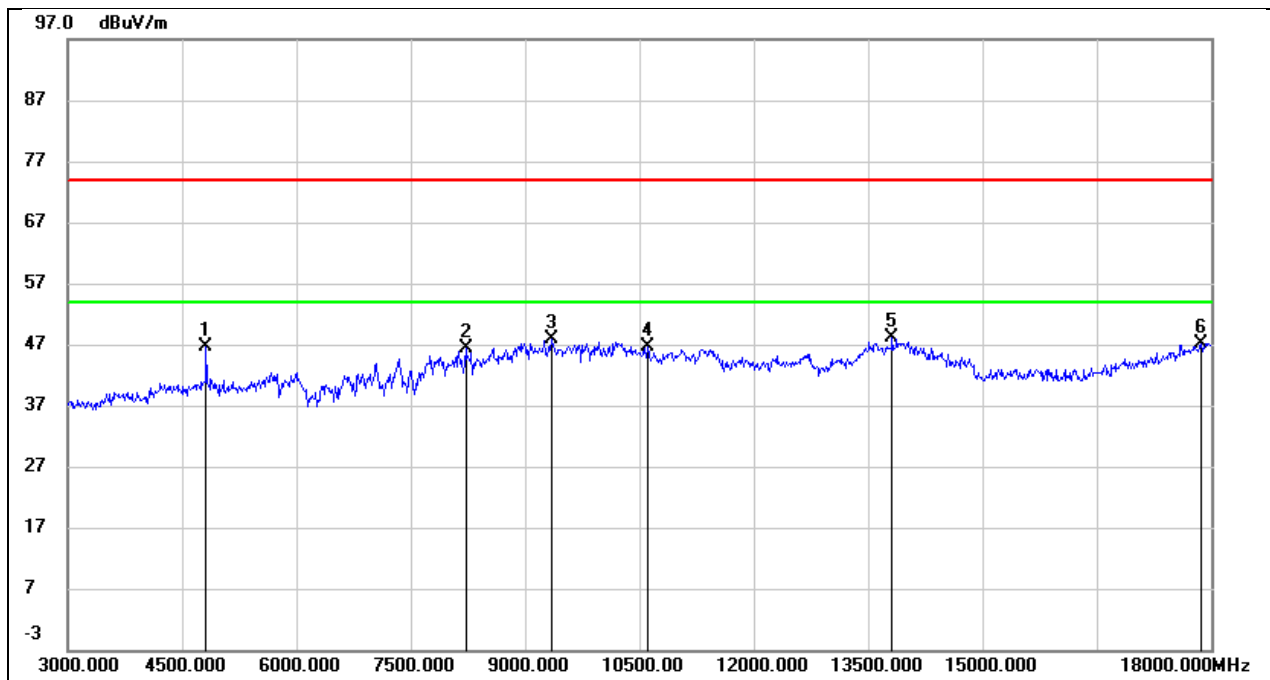

| No. | Frequency (MHz) | Reading (dBuV) | Correct (dB/m) | Result (dBuV/m) | Limit (dBuV/m) | Margin (dB) | Remark |
|-----|-----------------|----------------|----------------|-----------------|----------------|-------------|--------|
| 1 | 4815.000 | 46.14 | 0.49 | 46.63 | 74.00 | -27.37 | peak |
| 2 | 8220.000 | 37.67 | 8.76 | 46.43 | 74.00 | -27.57 | peak |
| 3 | 9345.000 | 37.46 | 10.32 | 47.78 | 74.00 | -26.22 | peak |
| 4 | 10605.000 | 32.70 | 13.94 | 46.64 | 74.00 | -27.36 | peak |
| 5 | 13815.000 | 25.38 | 22.65 | 48.03 | 74.00 | -25.97 | peak |
| 6 | 17865.000 | 20.77 | 26.33 | 47.10 | 74.00 | -26.90 | peak |

| | | | |
|------------|----------|-----------------|--------------|
| Test Mode: | 802.11b | Frequency(MHz): | 2412 |
| Polarity: | Vertical | Test Voltage: | AC 120V_60Hz |

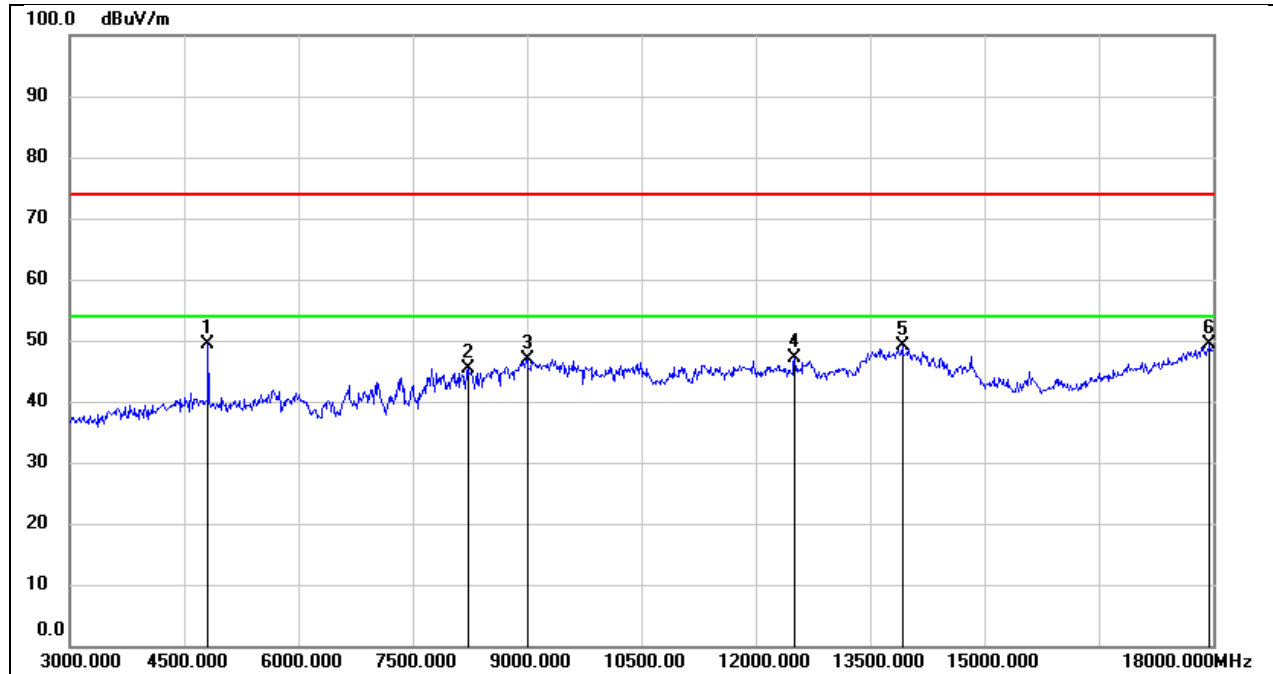

| No. | Frequency (MHz) | Reading (dBuV) | Correct (dB/m) | Result (dBuV/m) | Limit (dBuV/m) | Margin (dB) | Remark |
|-----|-----------------|----------------|----------------|-----------------|----------------|-------------|--------|
| 1 | 4815.000 | 48.90 | 0.49 | 49.39 | 74.00 | -24.61 | peak |
| 2 | 8220.000 | 36.57 | 8.76 | 45.33 | 74.00 | -28.67 | peak |
| 3 | 9000.000 | 35.80 | 11.17 | 46.97 | 74.00 | -27.03 | peak |
| 4 | 12510.000 | 28.53 | 18.51 | 47.04 | 74.00 | -26.96 | peak |
| 5 | 13920.000 | 26.31 | 22.71 | 49.02 | 74.00 | -24.98 | peak |
| 6 | 17955.000 | 22.76 | 26.66 | 49.42 | 74.00 | -24.58 | peak |

| | | | |
|------------|------------|-----------------|--------------|
| Test Mode: | 802.11b | Frequency(MHz): | 2437 |
| Polarity: | Horizontal | Test Voltage: | AC 120V_60Hz |

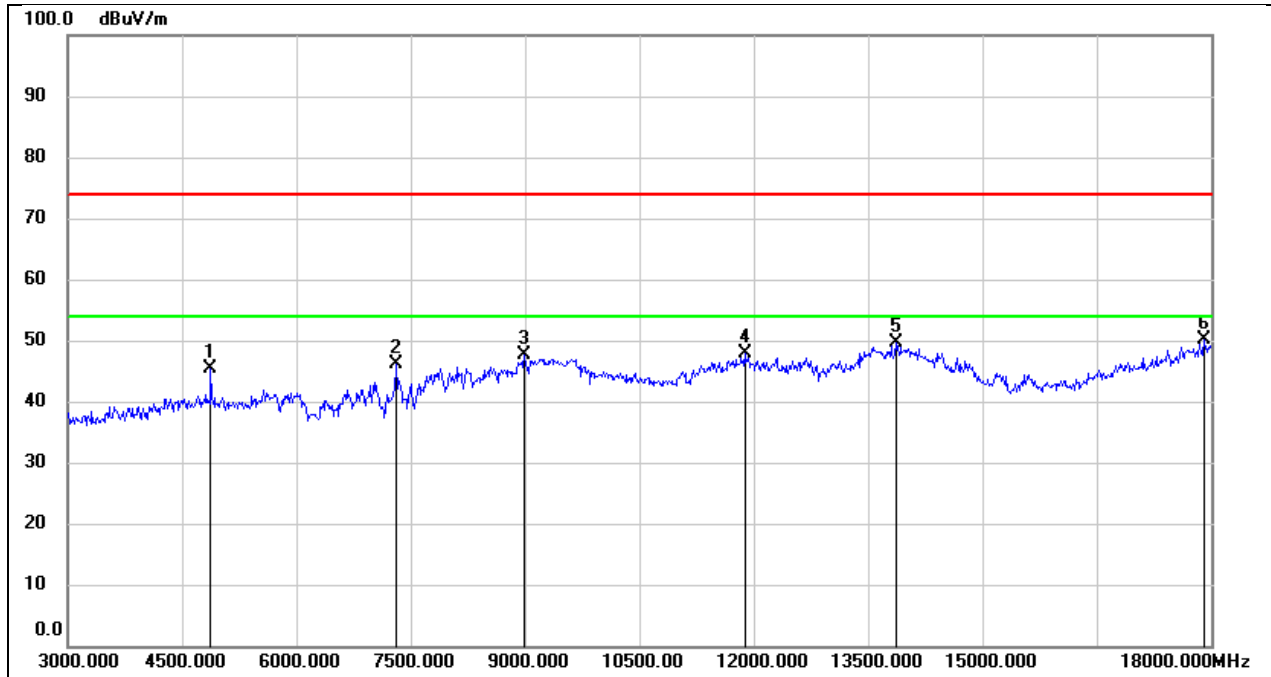

| No. | Frequency (MHz) | Reading (dBuV) | Correct (dB/m) | Result (dBuV/m) | Limit (dBuV/m) | Margin (dB) | Remark |
|-----|-----------------|----------------|----------------|-----------------|----------------|-------------|--------|
| 1 | 4875.000 | 44.89 | 0.61 | 45.50 | 74.00 | -28.50 | peak |
| 2 | 7305.000 | 39.18 | 6.89 | 46.07 | 74.00 | -27.93 | peak |
| 3 | 8985.000 | 36.57 | 10.97 | 47.54 | 74.00 | -26.46 | peak |
| 4 | 11880.000 | 29.80 | 17.97 | 47.77 | 74.00 | -26.23 | peak |
| 5 | 13860.000 | 26.85 | 22.68 | 49.53 | 74.00 | -24.47 | peak |
| 6 | 17910.000 | 23.65 | 26.50 | 50.15 | 74.00 | -23.85 | peak |

| | | | |
|------------|----------|-----------------|--------------|
| Test Mode: | 802.11b | Frequency(MHz): | 2437 |
| Polarity: | Vertical | Test Voltage: | AC 120V_60Hz |

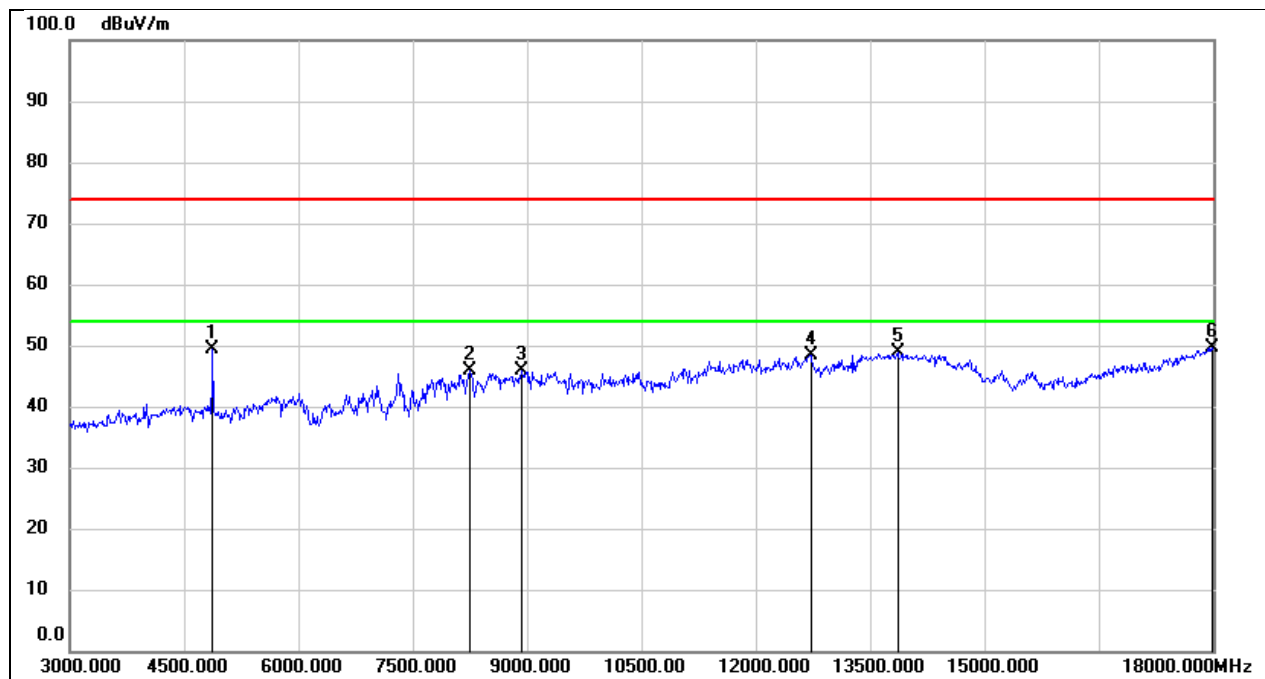

| No. | Frequency (MHz) | Reading (dBuV) | Correct (dB/m) | Result (dBuV/m) | Limit (dBuV/m) | Margin (dB) | Remark |
|-----|-----------------|----------------|----------------|-----------------|----------------|-------------|--------|
| 1 | 4875.000 | 48.86 | 0.61 | 49.47 | 74.00 | -24.53 | peak |
| 2 | 8250.000 | 37.35 | 8.61 | 45.96 | 74.00 | -28.04 | peak |
| 3 | 8925.000 | 35.70 | 10.14 | 45.84 | 74.00 | -28.16 | peak |
| 4 | 12720.000 | 29.65 | 18.71 | 48.36 | 74.00 | -25.64 | peak |
| 5 | 13860.000 | 26.31 | 22.68 | 48.99 | 74.00 | -25.01 | peak |
| 6 | 17985.000 | 22.89 | 26.77 | 49.66 | 74.00 | -24.34 | peak |

| | | | |
|------------|------------|-----------------|--------------|
| Test Mode: | 802.11b | Frequency(MHz): | 2462 |
| Polarity: | Horizontal | Test Voltage: | AC 120V_60Hz |

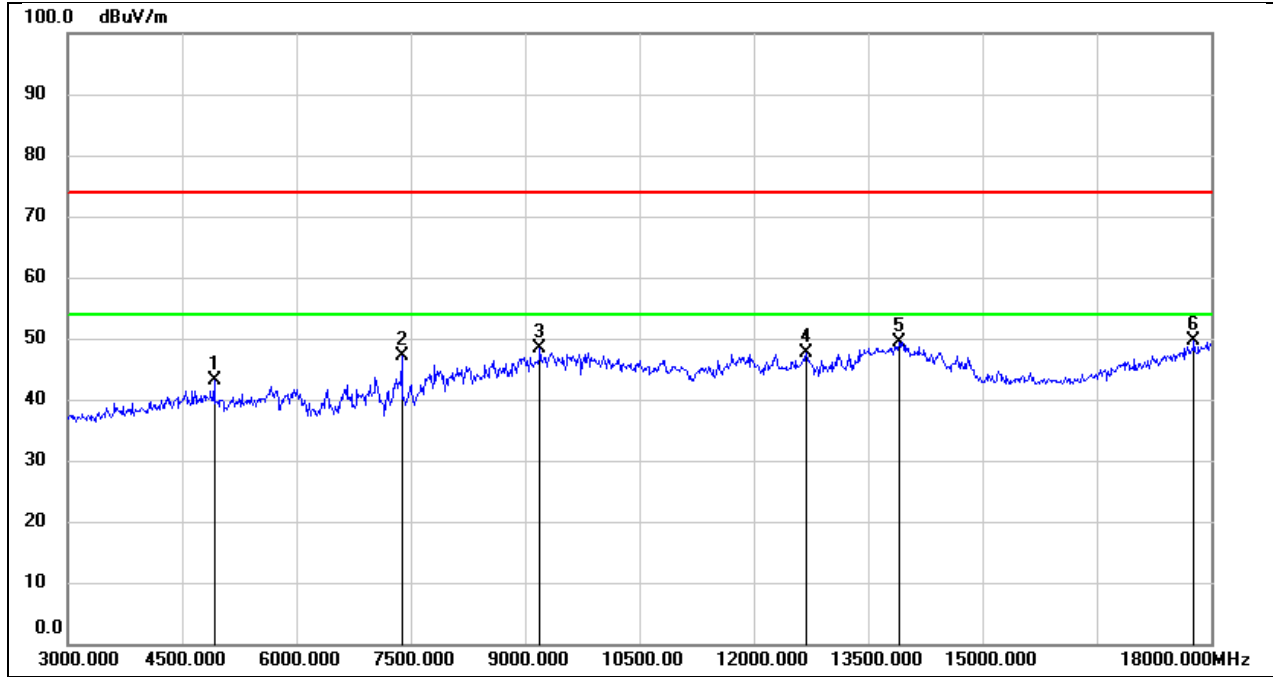

| No. | Frequency (MHz) | Reading (dBuV) | Correct (dB/m) | Result (dBuV/m) | Limit (dBuV/m) | Margin (dB) | Remark |
|-----|-----------------|----------------|----------------|-----------------|----------------|-------------|--------|
| 1 | 4920.000 | 42.41 | 0.69 | 43.10 | 74.00 | -30.90 | peak |
| 2 | 7380.000 | 39.77 | 7.34 | 47.11 | 74.00 | -26.89 | peak |
| 3 | 9195.000 | 38.26 | 10.03 | 48.29 | 74.00 | -25.71 | peak |
| 4 | 12690.000 | 29.07 | 18.60 | 47.67 | 74.00 | -26.33 | peak |
| 5 | 13905.000 | 26.78 | 22.70 | 49.48 | 74.00 | -24.52 | peak |
| 6 | 17775.000 | 23.66 | 25.86 | 49.52 | 74.00 | -24.48 | peak |

| | | | |
|------------|----------|-----------------|--------------|
| Test Mode: | 802.11b | Frequency(MHz): | 2462 |
| Polarity: | Vertical | Test Voltage: | AC 120V_60Hz |

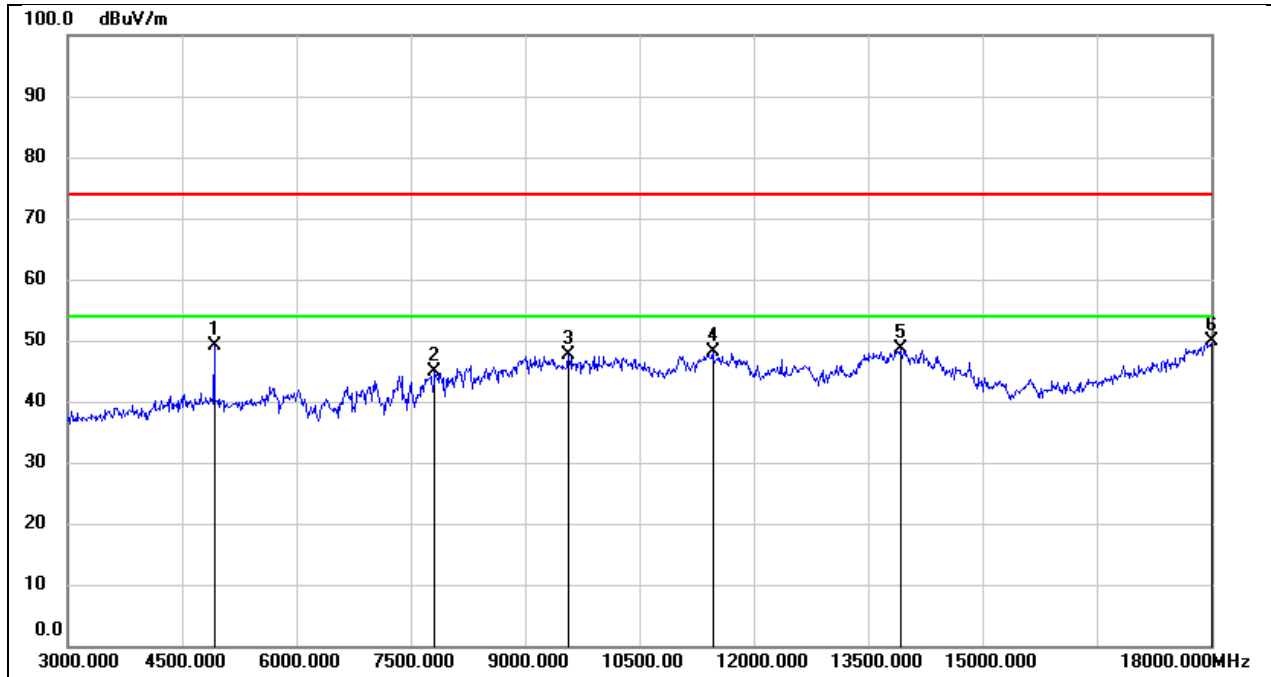

| No. | Frequency (MHz) | Reading (dBuV) | Correct (dB/m) | Result (dBuV/m) | Limit (dBuV/m) | Margin (dB) | Remark |
|-----|-----------------|----------------|----------------|-----------------|----------------|-------------|--------|
| 1 | 4920.000 | 48.42 | 0.69 | 49.11 | 74.00 | -24.89 | peak |
| 2 | 7815.000 | 37.44 | 7.50 | 44.94 | 74.00 | -29.06 | peak |
| 3 | 9570.000 | 36.54 | 10.98 | 47.52 | 74.00 | -26.48 | peak |
| 4 | 11460.000 | 31.35 | 16.74 | 48.09 | 74.00 | -25.91 | peak |
| 5 | 13935.000 | 25.95 | 22.72 | 48.67 | 74.00 | -25.33 | peak |
| 6 | 18000.000 | 23.01 | 26.83 | 49.84 | 74.00 | -24.16 | peak |

| | | | |
|------------|------------|-----------------|--------------|
| Test Mode: | 802.11g | Frequency(MHz): | 2412 |
| Polarity: | Horizontal | Test Voltage: | AC 120V_60Hz |

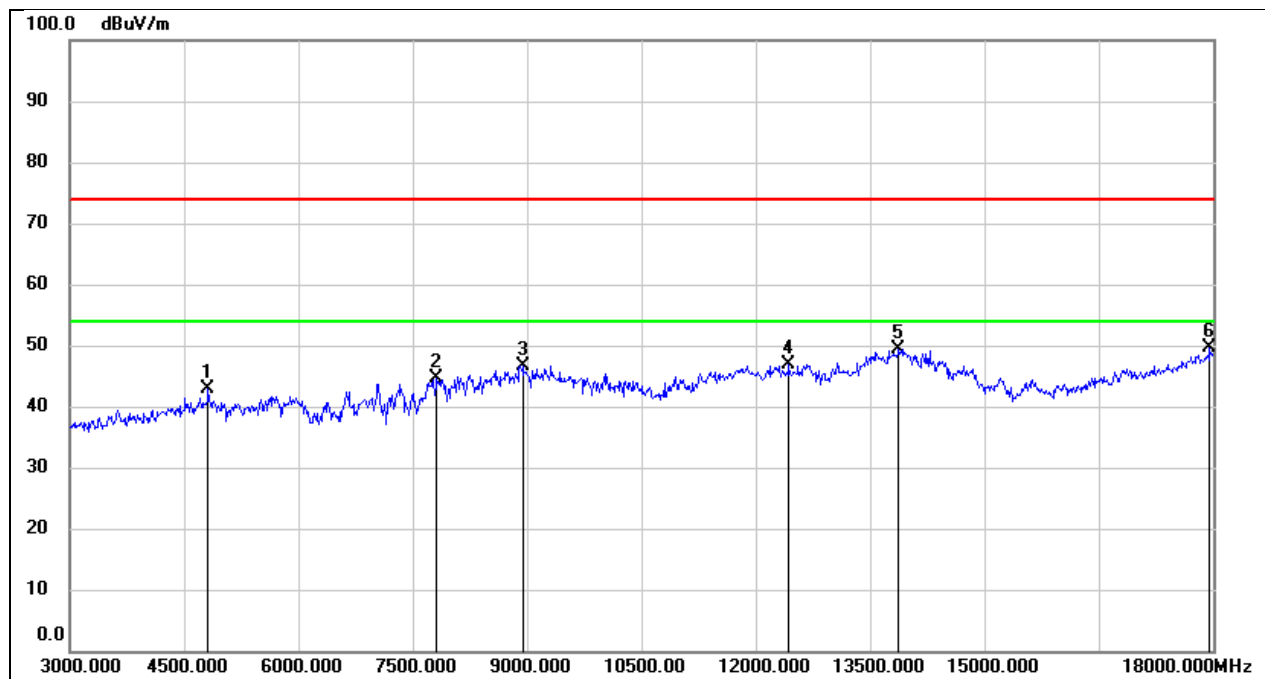

| No. | Frequency (MHz) | Reading (dBuV) | Correct (dB/m) | Result (dBuV/m) | Limit (dBuV/m) | Margin (dB) | Remark |
|-----|-----------------|----------------|----------------|-----------------|----------------|-------------|--------|
| 1 | 4815.000 | 42.44 | 0.49 | 42.93 | 74.00 | -31.07 | peak |
| 2 | 7815.000 | 37.07 | 7.50 | 44.57 | 74.00 | -29.43 | peak |
| 3 | 8940.000 | 36.25 | 10.35 | 46.60 | 74.00 | -27.40 | peak |
| 4 | 12435.000 | 27.96 | 18.84 | 46.80 | 74.00 | -27.20 | peak |
| 5 | 13875.000 | 26.66 | 22.68 | 49.34 | 74.00 | -24.66 | peak |
| 6 | 17955.000 | 22.86 | 26.66 | 49.52 | 74.00 | -24.48 | peak |

| | | | |
|------------|----------|-----------------|--------------|
| Test Mode: | 802.11g | Frequency(MHz): | 2412 |
| Polarity: | Vertical | Test Voltage: | AC 120V_60Hz |

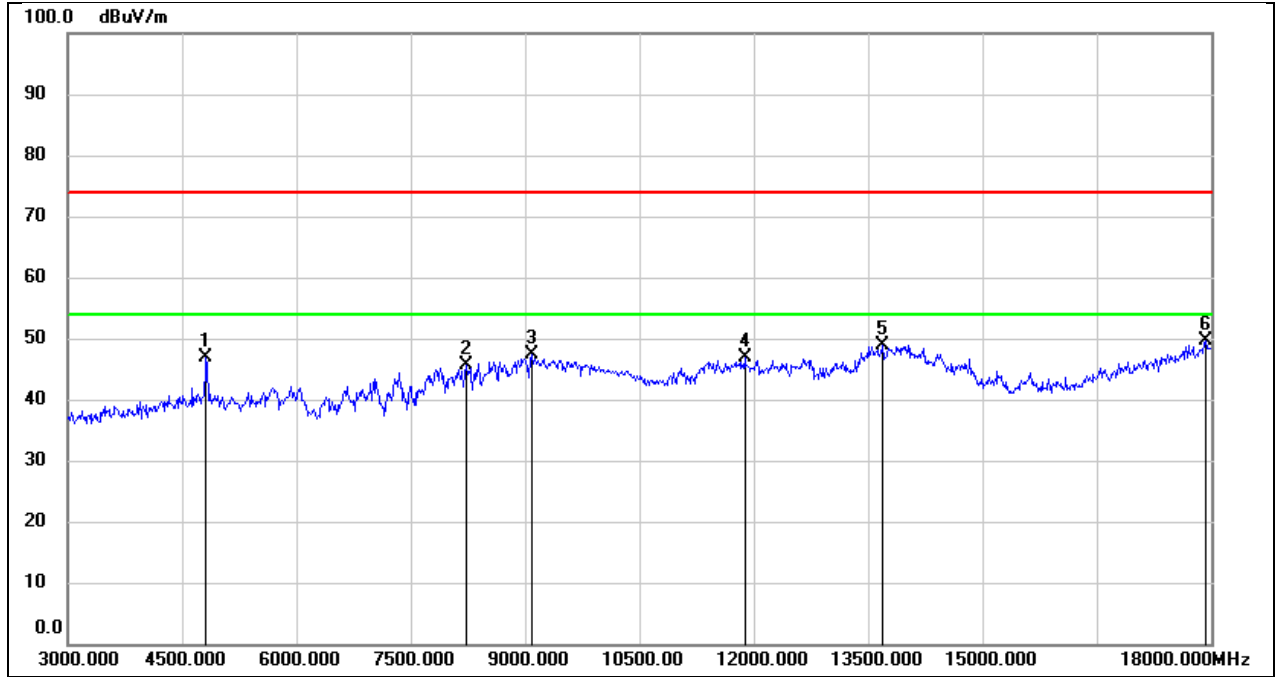

| No. | Frequency (MHz) | Reading (dBuV) | Correct (dB/m) | Result (dBuV/m) | Limit (dBuV/m) | Margin (dB) | Remark |
|-----|-----------------|----------------|----------------|-----------------|----------------|-------------|--------|
| 1 | 4815.000 | 46.30 | 0.49 | 46.79 | 74.00 | -27.21 | peak |
| 2 | 8235.000 | 36.99 | 8.70 | 45.69 | 74.00 | -28.31 | peak |
| 3 | 9090.000 | 36.66 | 10.65 | 47.31 | 74.00 | -26.69 | peak |
| 4 | 11880.000 | 28.98 | 17.97 | 46.95 | 74.00 | -27.05 | peak |
| 5 | 13695.000 | 26.66 | 22.13 | 48.79 | 74.00 | -25.21 | peak |
| 6 | 17925.000 | 23.19 | 26.55 | 49.74 | 74.00 | -24.26 | peak |

| | | | |
|------------|------------|-----------------|--------------|
| Test Mode: | 802.11g | Frequency(MHz): | 2437 |
| Polarity: | Horizontal | Test Voltage: | AC 120V_60Hz |

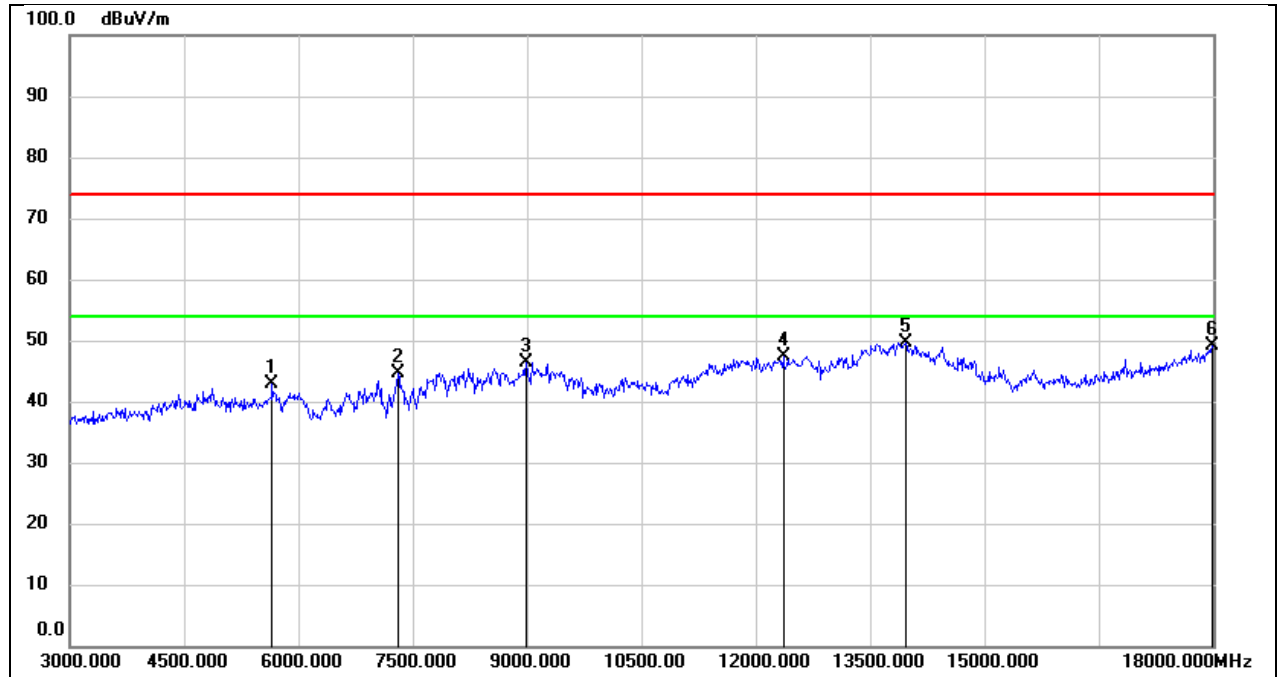

| No. | Frequency (MHz) | Reading (dBuV) | Correct (dB/m) | Result (dBuV/m) | Limit (dBuV/m) | Margin (dB) | Remark |
|-----|-----------------|----------------|----------------|-----------------|----------------|-------------|--------|
| 1 | 5655.000 | 40.26 | 2.67 | 42.93 | 74.00 | -31.07 | peak |
| 2 | 7305.000 | 37.69 | 6.89 | 44.58 | 74.00 | -29.42 | peak |
| 3 | 8985.000 | 35.45 | 10.97 | 46.42 | 74.00 | -27.58 | peak |
| 4 | 12360.000 | 28.56 | 18.85 | 47.41 | 74.00 | -26.59 | peak |
| 5 | 13965.000 | 26.94 | 22.74 | 49.68 | 74.00 | -24.32 | peak |
| 6 | 17985.000 | 22.35 | 26.77 | 49.12 | 74.00 | -24.88 | peak |

| | | | |
|------------|----------|-----------------|--------------|
| Test Mode: | 802.11g | Frequency(MHz): | 2437 |
| Polarity: | Vertical | Test Voltage: | AC 120V_60Hz |

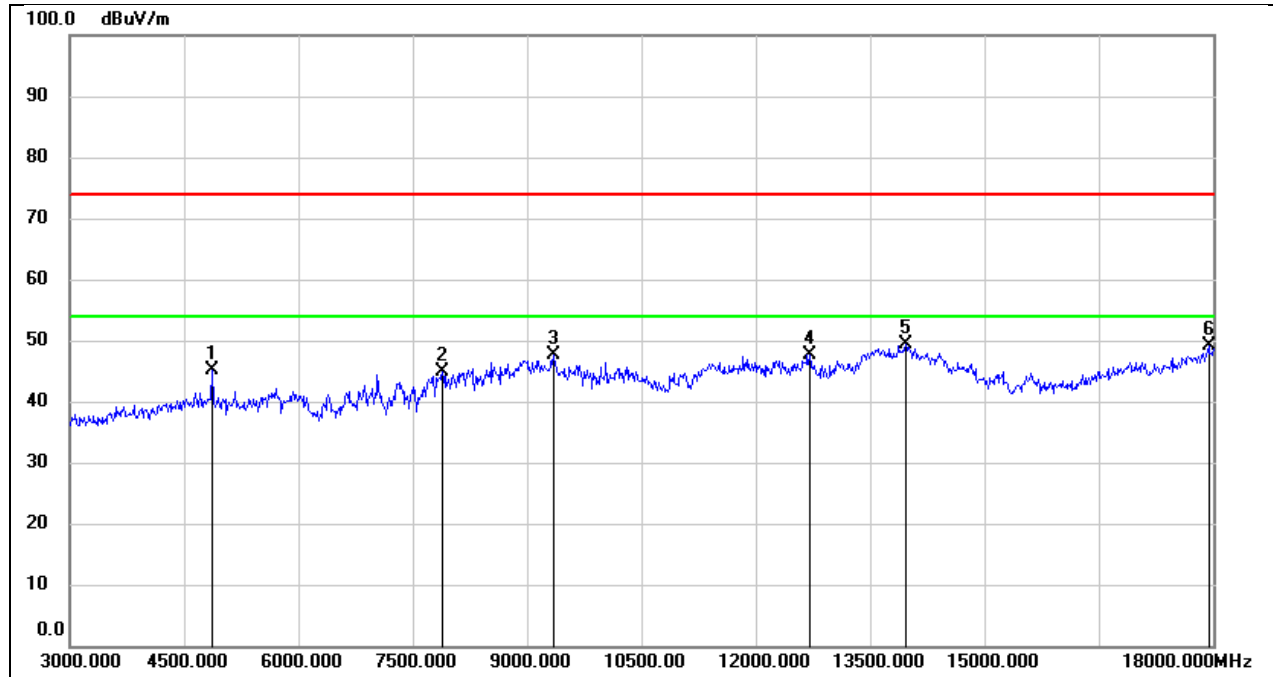

| No. | Frequency (MHz) | Reading (dBuV) | Correct (dB/m) | Result (dBuV/m) | Limit (dBuV/m) | Margin (dB) | Remark |
|-----|-----------------|----------------|----------------|-----------------|----------------|-------------|--------|
| 1 | 4860.000 | 44.56 | 0.57 | 45.13 | 74.00 | -28.87 | peak |
| 2 | 7890.000 | 37.60 | 7.29 | 44.89 | 74.00 | -29.11 | peak |
| 3 | 9345.000 | 37.19 | 10.32 | 47.51 | 74.00 | -26.49 | peak |
| 4 | 12705.000 | 28.89 | 18.66 | 47.55 | 74.00 | -26.45 | peak |
| 5 | 13965.000 | 26.62 | 22.74 | 49.36 | 74.00 | -24.64 | peak |
| 6 | 17940.000 | 22.43 | 26.61 | 49.04 | 74.00 | -24.96 | peak |

| | | | |
|------------|------------|-----------------|--------------|
| Test Mode: | 802.11g | Frequency(MHz): | 2462 |
| Polarity: | Horizontal | Test Voltage: | AC 120V_60Hz |

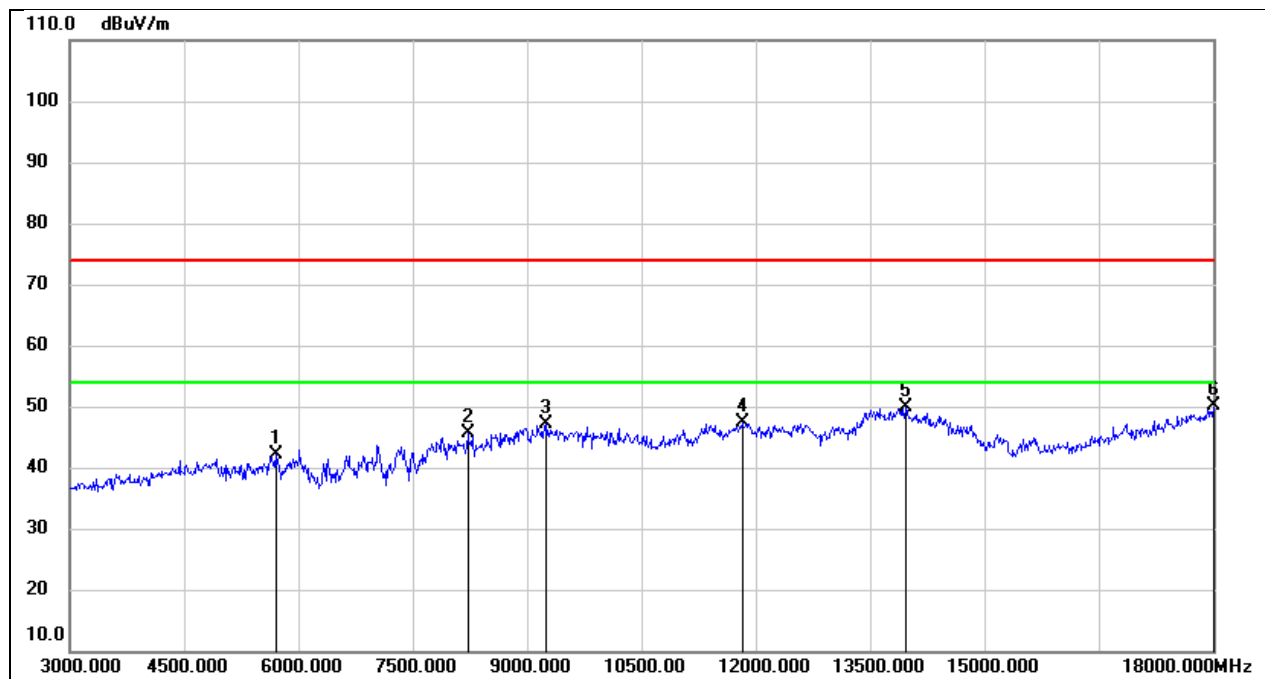

| No. | Frequency (MHz) | Reading (dBuV) | Correct (dB/m) | Result (dBuV/m) | Limit (dBuV/m) | Margin (dB) | Remark |
|-----|-----------------|----------------|----------------|-----------------|----------------|-------------|--------|
| 1 | 5700.000 | 39.67 | 2.54 | 42.21 | 74.00 | -31.79 | peak |
| 2 | 8220.000 | 36.97 | 8.76 | 45.73 | 74.00 | -28.27 | peak |
| 3 | 9255.000 | 36.93 | 10.14 | 47.07 | 74.00 | -26.93 | peak |
| 4 | 11820.000 | 29.53 | 17.73 | 47.26 | 74.00 | -26.74 | peak |
| 5 | 13965.000 | 27.18 | 22.74 | 49.92 | 74.00 | -24.08 | peak |
| 6 | 18000.000 | 23.20 | 26.83 | 50.03 | 74.00 | -23.97 | peak |

| | | | |
|------------|----------|-----------------|--------------|
| Test Mode: | 802.11g | Frequency(MHz): | 2462 |
| Polarity: | Vertical | Test Voltage: | AC 120V_60Hz |

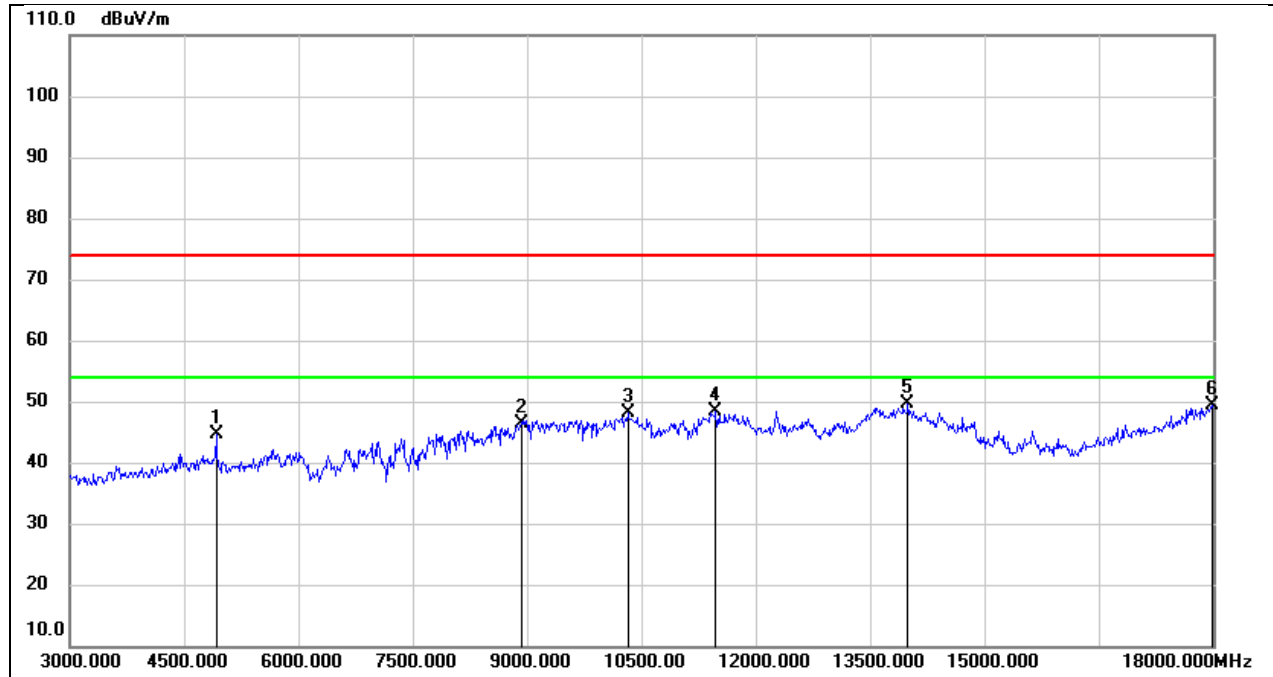

| No. | Frequency (MHz) | Reading (dBuV) | Correct (dB/m) | Result (dBuV/m) | Limit (dBuV/m) | Margin (dB) | Remark |
|-----|-----------------|----------------|----------------|-----------------|----------------|-------------|--------|
| 1 | 4920.000 | 43.87 | 0.69 | 44.56 | 74.00 | -29.44 | peak |
| 2 | 8925.000 | 36.12 | 10.14 | 46.26 | 74.00 | -27.74 | peak |
| 3 | 10320.000 | 35.11 | 13.07 | 48.18 | 74.00 | -25.82 | peak |
| 4 | 11475.000 | 31.69 | 16.78 | 48.47 | 74.00 | -25.53 | peak |
| 5 | 13995.000 | 26.99 | 22.76 | 49.75 | 74.00 | -24.25 | peak |
| 6 | 17985.000 | 22.72 | 26.77 | 49.49 | 74.00 | -24.51 | peak |

| | | | |
|------------|--------------|-----------------|--------------|
| Test Mode: | 802.11n HT20 | Frequency(MHz): | 2412 |
| Polarity: | Horizontal | Test Voltage: | AC 120V_60Hz |

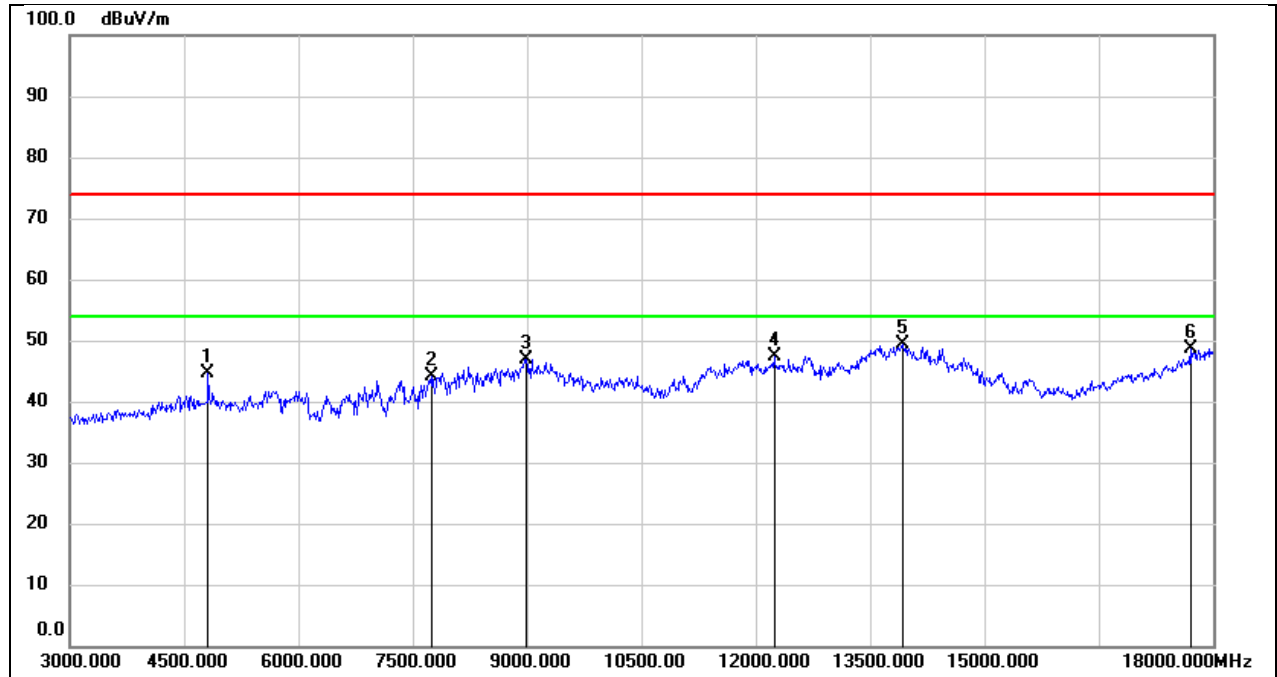

| No. | Frequency (MHz) | Reading (dBuV) | Correct (dB/m) | Result (dBuV/m) | Limit (dBuV/m) | Margin (dB) | Remark |
|-----|-----------------|----------------|----------------|-----------------|----------------|-------------|--------|
| 1 | 4815.000 | 44.16 | 0.49 | 44.65 | 74.00 | -29.35 | peak |
| 2 | 7755.000 | 36.75 | 7.38 | 44.13 | 74.00 | -29.87 | peak |
| 3 | 8985.000 | 36.01 | 10.97 | 46.98 | 74.00 | -27.02 | peak |
| 4 | 12240.000 | 28.92 | 18.46 | 47.38 | 74.00 | -26.62 | peak |
| 5 | 13920.000 | 26.67 | 22.71 | 49.38 | 74.00 | -24.62 | peak |
| 6 | 17700.000 | 23.39 | 25.17 | 48.56 | 74.00 | -25.44 | peak |

| | | | |
|------------|--------------|-----------------|--------------|
| Test Mode: | 802.11n HT20 | Frequency(MHz): | 2412 |
| Polarity: | Vertical | Test Voltage: | AC 120V_60Hz |

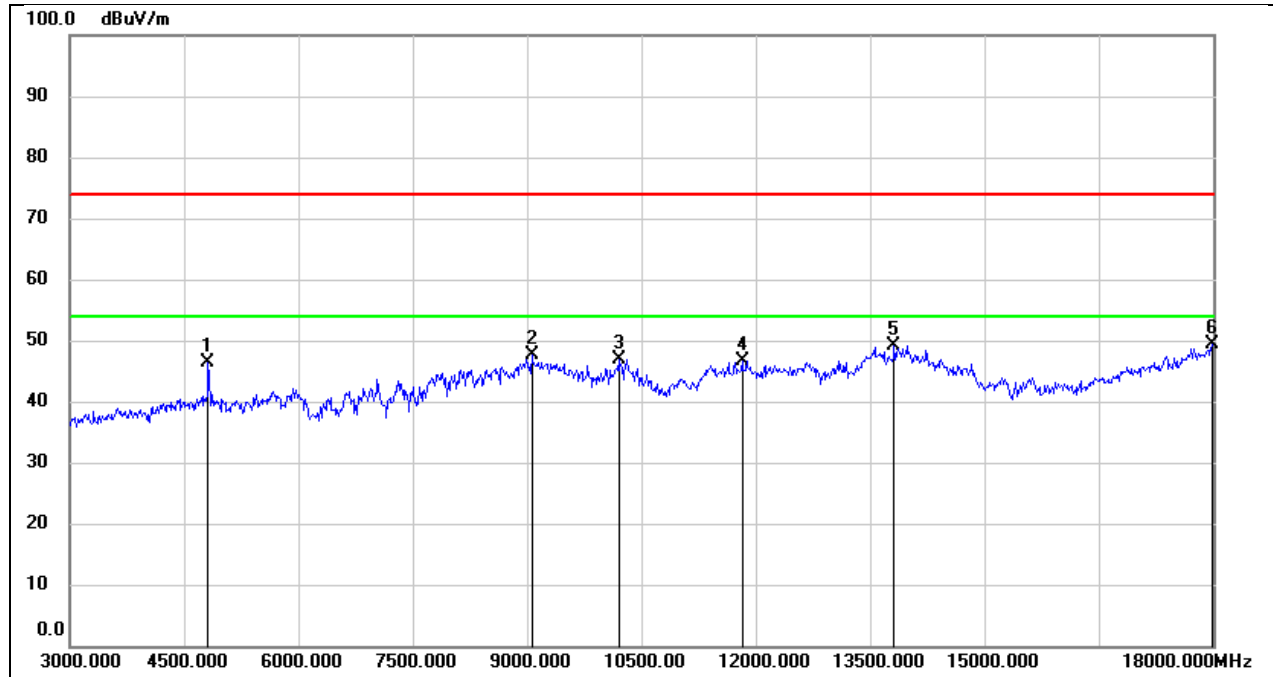

| No. | Frequency (MHz) | Reading (dBuV) | Correct (dB/m) | Result (dBuV/m) | Limit (dBuV/m) | Margin (dB) | Remark |
|-----|-----------------|----------------|----------------|-----------------|----------------|-------------|--------|
| 1 | 4815.000 | 45.84 | 0.49 | 46.33 | 74.00 | -27.67 | peak |
| 2 | 9060.000 | 36.71 | 10.82 | 47.53 | 74.00 | -26.47 | peak |
| 3 | 10200.000 | 34.32 | 12.48 | 46.80 | 74.00 | -27.20 | peak |
| 4 | 11820.000 | 28.82 | 17.73 | 46.55 | 74.00 | -27.45 | peak |
| 5 | 13815.000 | 26.38 | 22.65 | 49.03 | 74.00 | -24.97 | peak |
| 6 | 17985.000 | 22.60 | 26.77 | 49.37 | 74.00 | -24.63 | peak |

| | | | |
|------------|--------------|-----------------|--------------|
| Test Mode: | 802.11n HT20 | Frequency(MHz): | 2437 |
| Polarity: | Horizontal | Test Voltage: | AC 120V_60Hz |

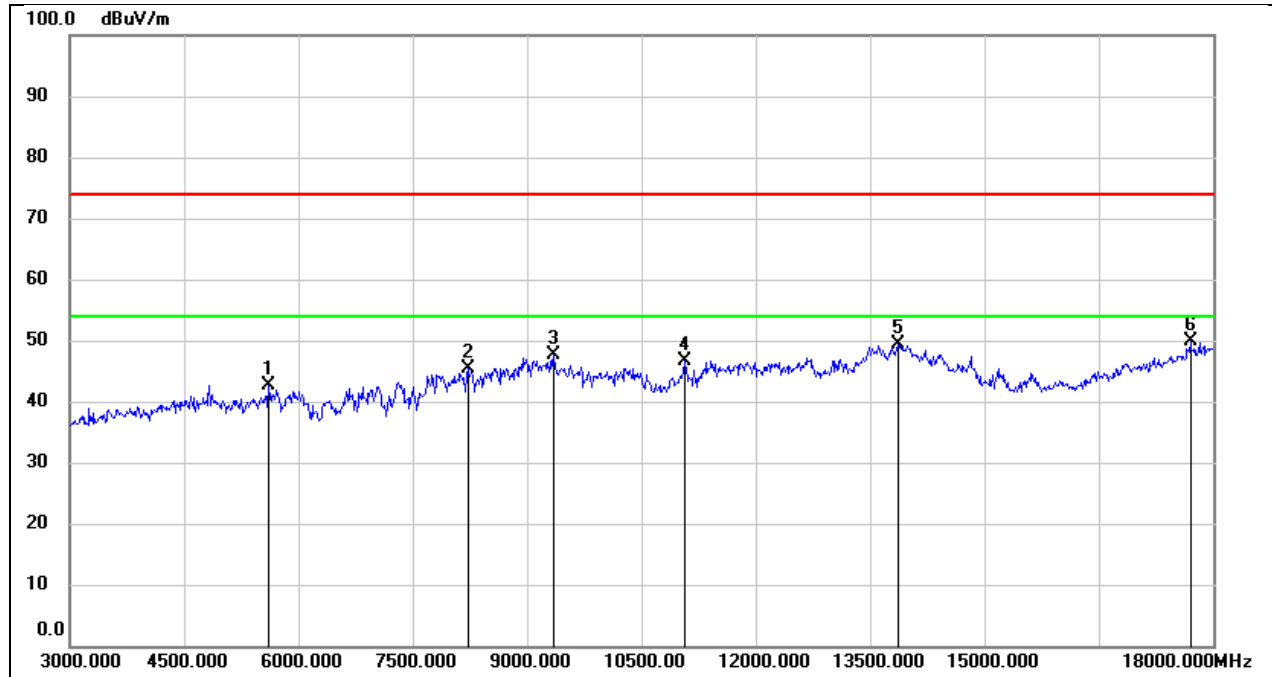

| No. | Frequency (MHz) | Reading (dBuV) | Correct (dB/m) | Result (dBuV/m) | Limit (dBuV/m) | Margin (dB) | Remark |
|-----|-----------------|----------------|----------------|-----------------|----------------|-------------|--------|
| 1 | 5610.000 | 39.96 | 2.78 | 42.74 | 74.00 | -31.26 | peak |
| 2 | 8220.000 | 36.54 | 8.76 | 45.30 | 74.00 | -28.70 | peak |
| 3 | 9345.000 | 37.29 | 10.32 | 47.61 | 74.00 | -26.39 | peak |
| 4 | 11070.000 | 31.59 | 15.08 | 46.67 | 74.00 | -27.33 | peak |
| 5 | 13875.000 | 26.70 | 22.68 | 49.38 | 74.00 | -24.62 | peak |
| 6 | 17700.000 | 24.71 | 25.17 | 49.88 | 74.00 | -24.12 | peak |

| | | | |
|------------|--------------|-----------------|--------------|
| Test Mode: | 802.11n HT20 | Frequency(MHz): | 2437 |
| Polarity: | Vertical | Test Voltage: | AC 120V_60Hz |

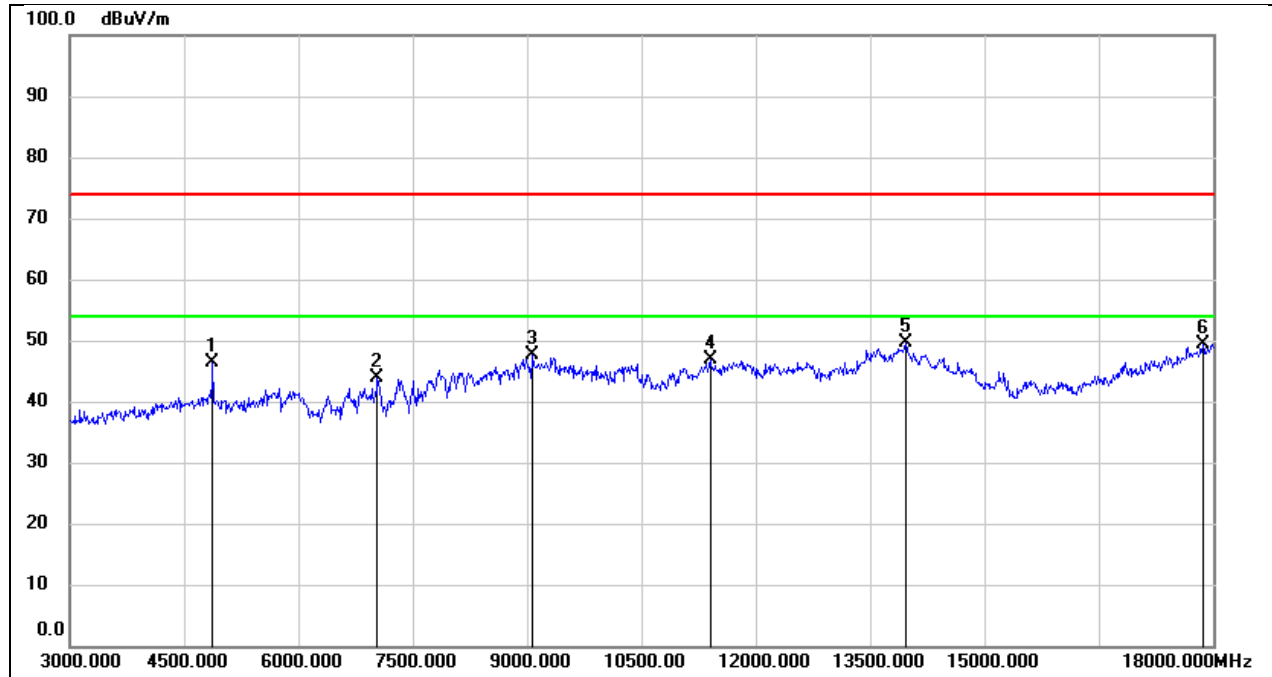

| No. | Frequency (MHz) | Reading (dBuV) | Correct (dB/m) | Result (dBuV/m) | Limit (dBuV/m) | Margin (dB) | Remark |
|-----|-----------------|----------------|----------------|-----------------|----------------|-------------|--------|
| 1 | 4875.000 | 45.88 | 0.61 | 46.49 | 74.00 | -27.51 | peak |
| 2 | 7035.000 | 36.70 | 7.28 | 43.98 | 74.00 | -30.02 | peak |
| 3 | 9075.000 | 37.00 | 10.74 | 47.74 | 74.00 | -26.26 | peak |
| 4 | 11400.000 | 30.31 | 16.54 | 46.85 | 74.00 | -27.15 | peak |
| 5 | 13965.000 | 27.01 | 22.74 | 49.75 | 74.00 | -24.25 | peak |
| 6 | 17865.000 | 23.09 | 26.33 | 49.42 | 74.00 | -24.58 | peak |

| | | | |
|------------|--------------|-----------------|--------------|
| Test Mode: | 802.11n HT20 | Frequency(MHz): | 2462 |
| Polarity: | Horizontal | Test Voltage: | AC 120V_60Hz |

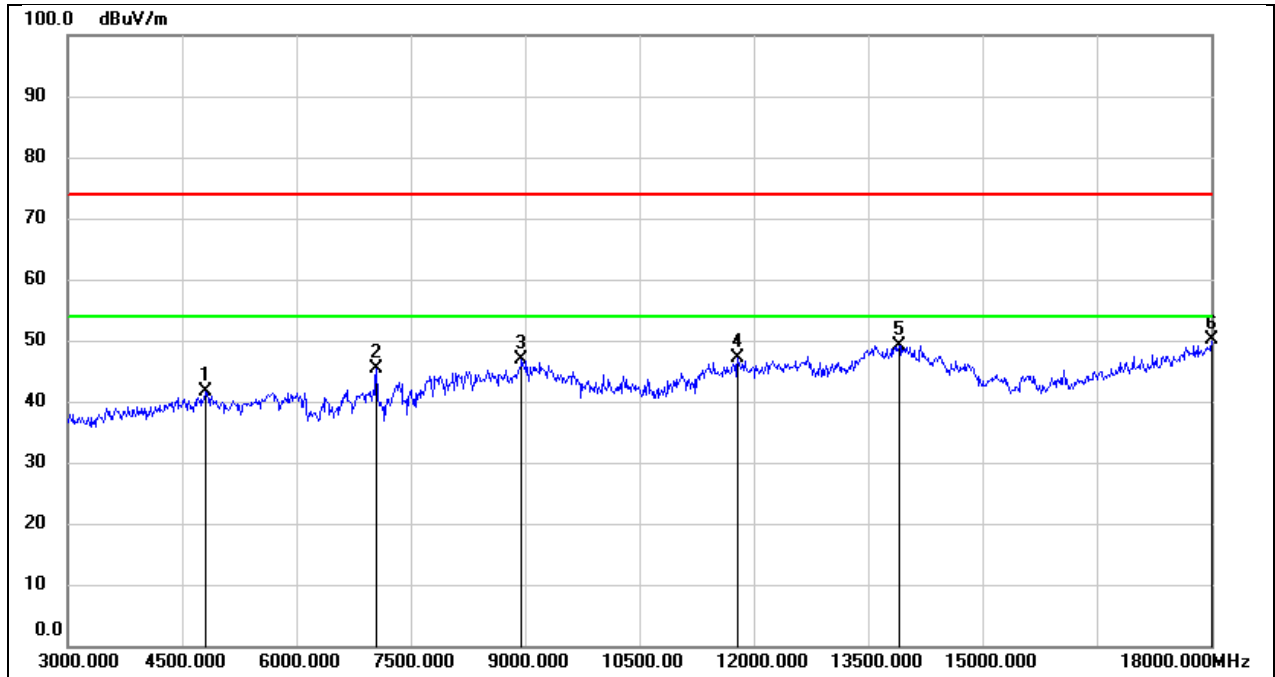

| No. | Frequency (MHz) | Reading (dBuV) | Correct (dB/m) | Result (dBuV/m) | Limit (dBuV/m) | Margin (dB) | Remark |
|-----|-----------------|----------------|----------------|-----------------|----------------|-------------|--------|
| 1 | 4815.000 | 41.17 | 0.49 | 41.66 | 74.00 | -32.34 | peak |
| 2 | 7050.000 | 38.20 | 7.19 | 45.39 | 74.00 | -28.61 | peak |
| 3 | 8955.000 | 36.42 | 10.56 | 46.98 | 74.00 | -27.02 | peak |
| 4 | 11790.000 | 29.50 | 17.60 | 47.10 | 74.00 | -26.90 | peak |
| 5 | 13905.000 | 26.42 | 22.70 | 49.12 | 74.00 | -24.88 | peak |
| 6 | 18000.000 | 23.37 | 26.83 | 50.20 | 74.00 | -23.80 | peak |

| | | | |
|------------|--------------|-----------------|--------------|
| Test Mode: | 802.11n HT20 | Frequency(MHz): | 2462 |
| Polarity: | Vertical | Test Voltage: | AC 120V_60Hz |

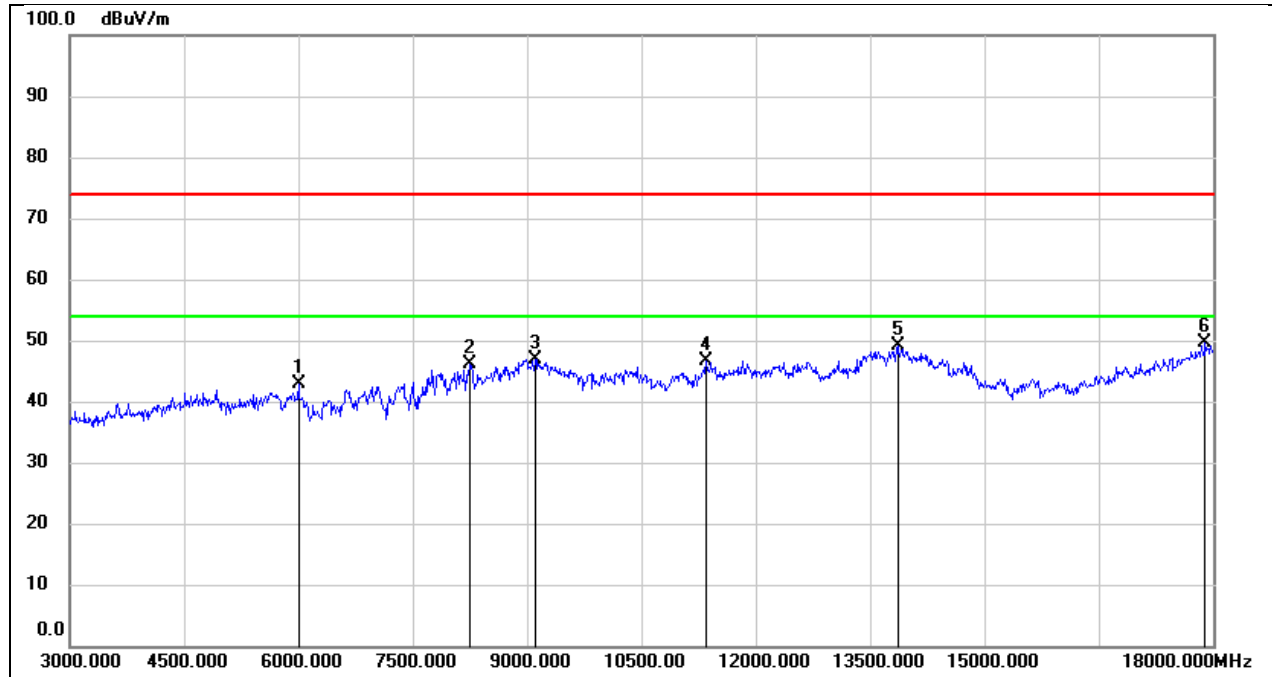

| No. | Frequency (MHz) | Reading (dBuV) | Correct (dB/m) | Result (dBuV/m) | Limit (dBuV/m) | Margin (dB) | Remark |
|-----|-----------------|----------------|----------------|-----------------|----------------|-------------|--------|
| 1 | 6000.000 | 39.69 | 3.11 | 42.80 | 74.00 | -31.20 | peak |
| 2 | 8250.000 | 37.58 | 8.61 | 46.19 | 74.00 | -27.81 | peak |
| 3 | 9105.000 | 36.37 | 10.57 | 46.94 | 74.00 | -27.06 | peak |
| 4 | 11340.000 | 30.49 | 16.19 | 46.68 | 74.00 | -27.32 | peak |
| 5 | 13860.000 | 26.56 | 22.68 | 49.24 | 74.00 | -24.76 | peak |
| 6 | 17895.000 | 23.11 | 26.44 | 49.55 | 74.00 | -24.45 | peak |

8.4. SPURIOUS EMISSIONS(9 KHZ~30 MHZ)

| | | | |
|------------|------------|-----------------|--------------|
| Test Mode: | 802.11b | Frequency(MHz): | 2412 |
| Polarity: | Horizontal | Test Voltage: | AC 120V_60Hz |

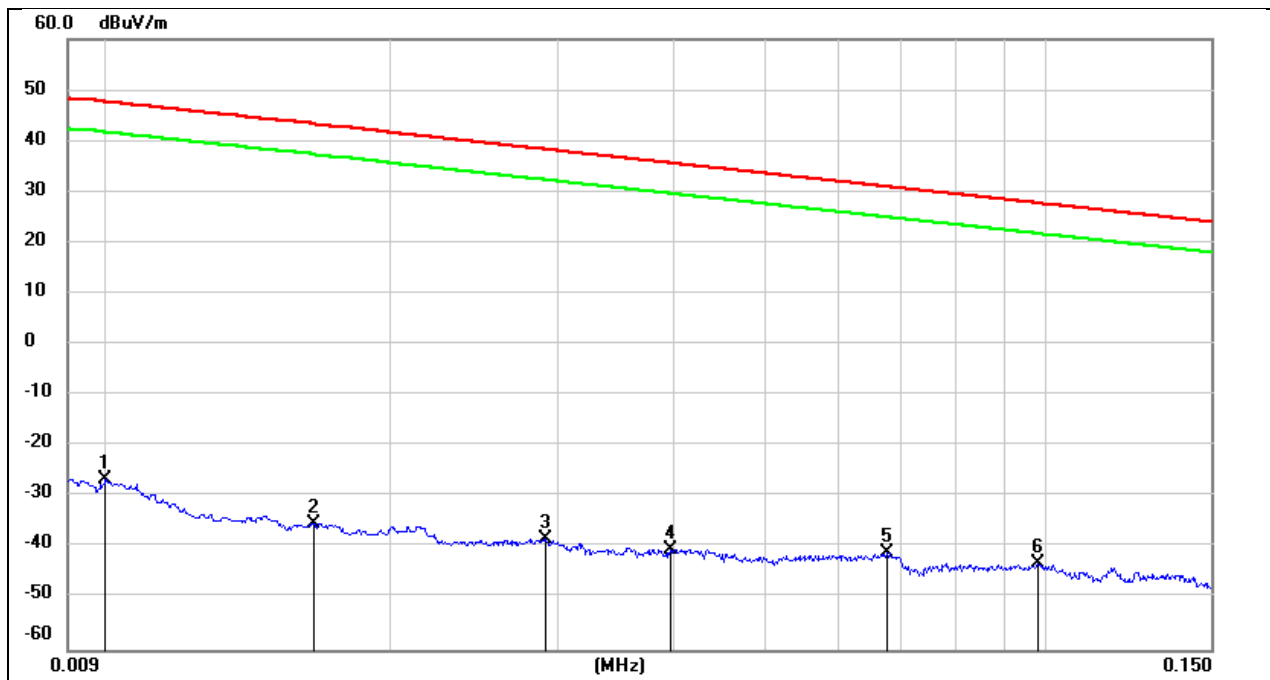

| No. | Frequency (MHz) | Reading (dBuV) | Correct (dB/m) | FCC Result (dBuV/m) | FCC Limit (dBuV/m) | ISED Result (dBuA/m) | ISED Limit (dBuA/m) | Margin (dB) | Remark |
|-----|--------------------|-------------------|-------------------|---------------------------|-----------------------|----------------------------|---------------------------|----------------|--------|
| 1 | 0.0100 | 74.72 | -101.40 | -26.68 | 47.60 | -78.18 | -3.90 | -74.28 | peak |
| 2 | 0.0165 | 66.14 | -101.37 | -35.23 | 43.25 | -86.73 | -8.25 | -78.48 | peak |
| 3 | 0.0292 | 63.29 | -101.39 | -38.10 | 38.29 | -89.60 | -13.21 | -76.39 | peak |
| 4 | 0.0396 | 61.11 | -101.43 | -40.32 | 35.65 | -91.82 | -15.85 | -75.97 | peak |
| 5 | 0.0675 | 60.64 | -101.56 | -40.92 | 31.02 | -92.42 | -20.48 | -71.94 | peak |
| 6 | 0.0981 | 58.77 | -101.78 | -43.01 | 27.77 | -94.51 | -23.73 | -70.78 | peak |

| | | | |
|------------|------------|-----------------|--------------|
| Test Mode: | 802.11b | Frequency(MHz): | 2412 |
| Polarity: | Horizontal | Test Voltage: | AC 120V_60Hz |

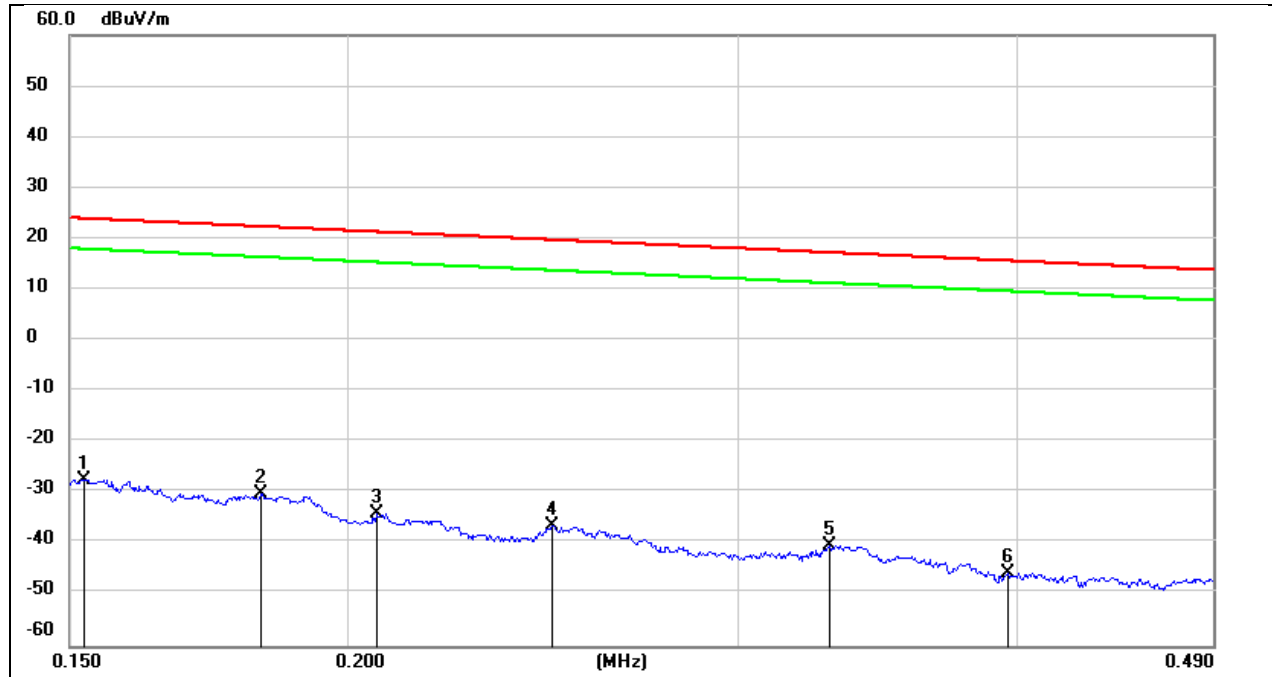

| No. | Frequency (MHz) | Reading (dBuV) | Correct (dB/m) | FCC Result (dBuV/m) | FCC Limit (dBuV/m) | ISED Result (dBuA/m) | ISED Limit (dBuA/m) | Margin (dB) | Remark |
|-----|--------------------|-------------------|-------------------|---------------------------|-----------------------|----------------------------|---------------------------|----------------|--------|
| 1 | 0.1524 | 74.30 | -101.63 | -27.33 | 23.94 | -78.83 | -27.56 | -51.27 | peak |
| 2 | 0.1827 | 71.67 | -101.69 | -30.02 | 22.37 | -81.52 | -29.13 | -52.39 | peak |
| 3 | 0.2061 | 67.68 | -101.73 | -34.05 | 21.32 | -85.55 | -30.18 | -55.37 | peak |
| 4 | 0.2472 | 65.45 | -101.80 | -36.35 | 19.74 | -87.85 | -31.76 | -56.09 | peak |
| 5 | 0.3300 | 61.47 | -101.88 | -40.41 | 17.23 | -91.91 | -34.27 | -57.64 | peak |
| 6 | 0.3966 | 56.18 | -101.96 | -45.78 | 15.63 | -97.28 | -35.87 | -61.41 | peak |

| | | | |
|------------|------------|-----------------|--------------|
| Test Mode: | 802.11b | Frequency(MHz): | 2412 |
| Polarity: | Horizontal | Test Voltage: | AC 120V_60Hz |

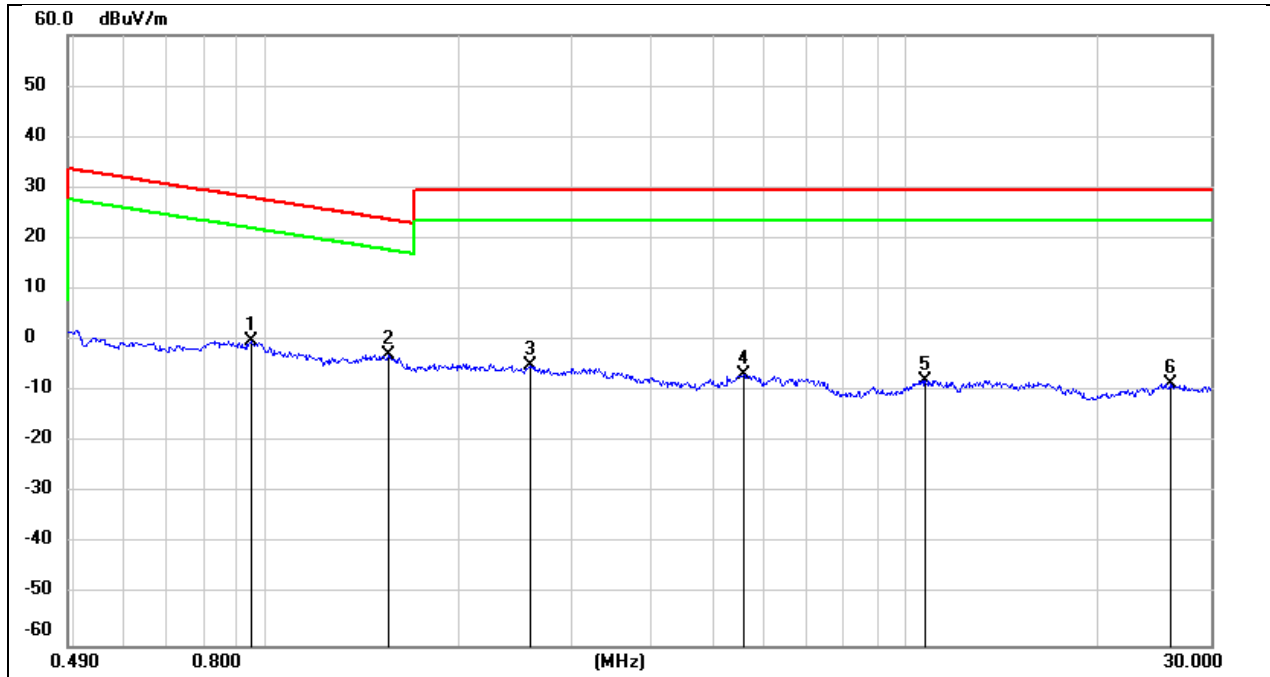

| No. | Frequency (MHz) | Reading (dBuV) | Correct (dB/m) | FCC Result (dBuV/m) | FCC Limit (dBuV/m) | ISED Result (dBuA/m) | ISED Limit (dBuA/m) | Margin (dB) | Remark |
|-----|--------------------|-------------------|-------------------|---------------------------|-----------------------|----------------------------|---------------------------|----------------|--------|
| 1 | 0.9465 | 62.10 | -62.23 | -0.13 | 28.08 | -51.63 | -23.42 | -28.21 | peak |
| 2 | 1.5564 | 59.18 | -62.02 | -2.84 | 23.76 | -54.34 | -27.74 | -26.60 | peak |
| 3 | 2.5935 | 56.61 | -61.68 | -5.07 | 29.54 | -56.57 | -21.96 | -34.61 | peak |
| 4 | 5.5952 | 54.55 | -61.41 | -6.86 | 29.54 | -58.36 | -21.96 | -36.40 | peak |
| 5 | 10.7299 | 52.98 | -60.83 | -7.85 | 29.54 | -59.35 | -21.96 | -37.39 | peak |
| 6 | 25.8978 | 51.76 | -60.36 | -8.60 | 29.54 | -60.10 | -21.96 | -38.14 | peak |

8.5. SPURIOUS EMISSIONS(18 GHZ~26 GHZ)

| | | | |
|------------|------------|-----------------|--------------|
| Test Mode: | 802.11b | Frequency(MHz): | 2412 |
| Polarity: | Horizontal | Test Voltage: | AC 120V_60Hz |

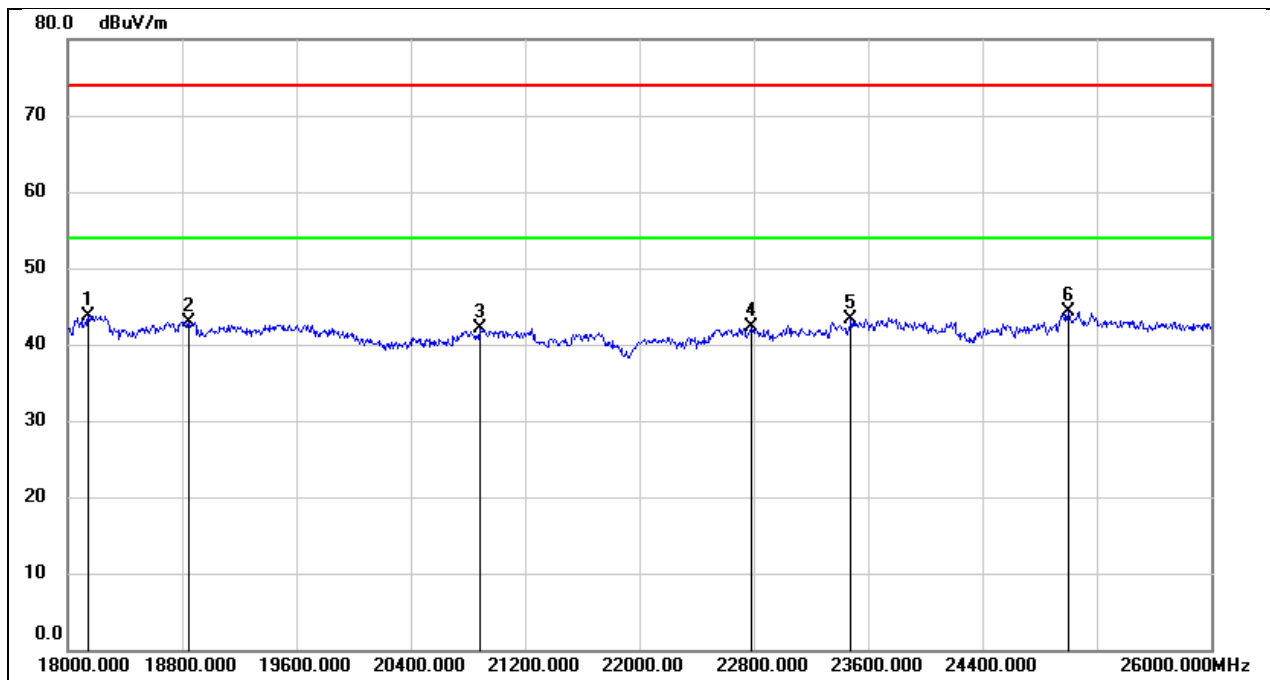

| No. | Frequency (MHz) | Reading (dBuV) | Correct (dB/m) | Result (dBuV/m) | Limit (dBuV/m) | Margin (dB) | Remark |
|-----|-----------------|----------------|----------------|-----------------|----------------|-------------|--------|
| 1 | 18144.000 | 49.27 | -5.48 | 43.79 | 74.00 | -30.21 | peak |
| 2 | 18848.000 | 48.35 | -5.35 | 43.00 | 74.00 | -31.00 | peak |
| 3 | 20888.000 | 47.11 | -4.98 | 42.13 | 74.00 | -31.87 | peak |
| 4 | 22784.000 | 45.98 | -3.65 | 42.33 | 74.00 | -31.67 | peak |
| 5 | 23480.000 | 46.54 | -3.16 | 43.38 | 74.00 | -30.62 | peak |
| 6 | 25000.000 | 46.36 | -2.10 | 44.26 | 74.00 | -29.74 | peak |

| | | | |
|------------|----------|-----------------|--------------|
| Test Mode: | 802.11b | Frequency(MHz): | 2412 |
| Polarity: | Vertical | Test Voltage: | AC 120V_60Hz |

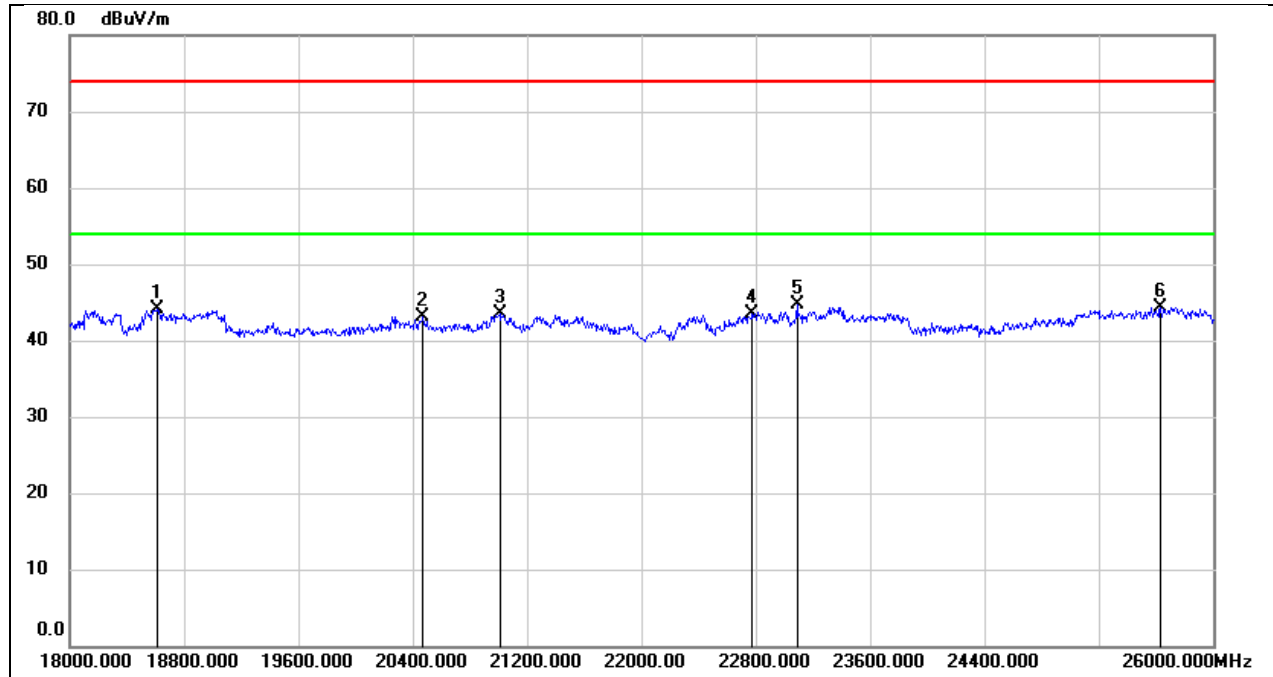

| No. | Frequency (MHz) | Reading (dBuV) | Correct (dB/m) | Result (dBuV/m) | Limit (dBuV/m) | Margin (dB) | Remark |
|-----|-----------------|----------------|----------------|-----------------|----------------|-------------|--------|
| 1 | 18616.000 | 49.39 | -5.34 | 44.05 | 74.00 | -29.95 | peak |
| 2 | 20472.000 | 48.57 | -5.39 | 43.18 | 74.00 | -30.82 | peak |
| 3 | 21008.000 | 48.32 | -4.88 | 43.44 | 74.00 | -30.56 | peak |
| 4 | 22776.000 | 47.11 | -3.66 | 43.45 | 74.00 | -30.55 | peak |
| 5 | 23088.000 | 48.02 | -3.41 | 44.61 | 74.00 | -29.39 | peak |
| 6 | 25632.000 | 45.56 | -1.16 | 44.40 | 74.00 | -29.60 | peak |

8.6. SPURIOUS EMISSIONS(30 MHZ~1 GHZ)

| | | | |
|------------|------------|-----------------|-------------|
| Test Mode: | 802.11b | Frequency(MHz): | 2412 |
| Polarity: | Horizontal | Test Voltage: | AC120V_60Hz |

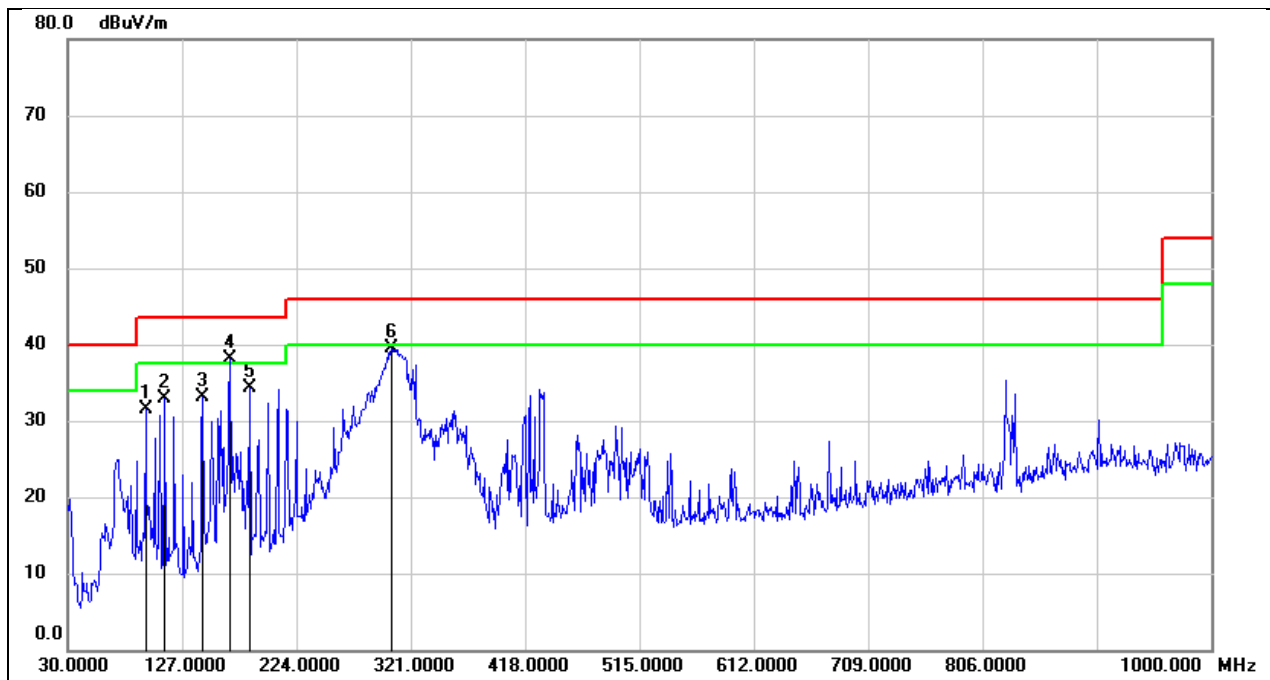

| No. | Frequency (MHz) | Reading (dBuV) | Correct (dB/m) | Result (dBuV/m) | Limit (dBuV/m) | Margin (dB) | Remark |
|-----|-----------------|----------------|----------------|-----------------|----------------|-------------|--------|
| 1 | 95.9600 | 48.34 | -16.82 | 31.52 | 43.50 | -11.98 | QP |
| 2 | 112.4500 | 48.42 | -15.52 | 32.90 | 43.50 | -10.60 | QP |
| 3 | 144.4600 | 46.96 | -13.84 | 33.12 | 43.50 | -10.38 | QP |
| 4 | 167.7400 | 50.52 | -12.37 | 38.15 | 43.50 | -5.35 | QP |
| 5 | 184.2300 | 46.36 | -12.05 | 34.31 | 43.50 | -9.19 | QP |
| 6 | 304.5100 | 51.04 | -11.51 | 39.53 | 46.00 | -6.47 | QP |

| | | | |
|------------|----------|-----------------|-------------|
| Test Mode: | 802.11b | Frequency(MHz): | 2412 |
| Polarity: | Vertical | Test Voltage: | AC120V_60Hz |

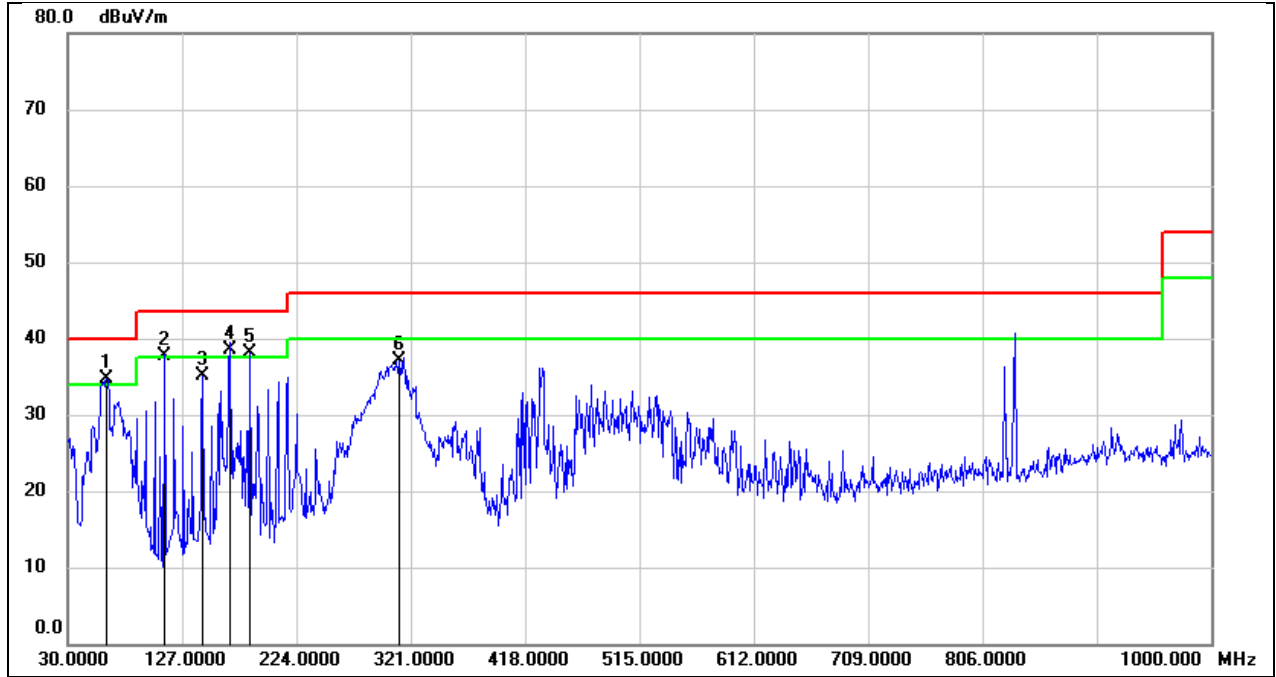

| No. | Frequency (MHz) | Reading (dBuV) | Correct (dB/m) | Result (dBuV/m) | Limit (dBuV/m) | Margin (dB) | Remark |
|-----|-----------------|----------------|----------------|-----------------|----------------|-------------|--------|
| 1 | 62.9800 | 50.09 | -15.31 | 34.78 | 40.00 | -5.22 | QP |
| 2 | 112.4500 | 53.19 | -15.52 | 37.67 | 43.50 | -5.83 | QP |
| 3 | 144.4600 | 48.93 | -13.84 | 35.09 | 43.50 | -8.41 | QP |
| 4 | 167.7400 | 50.92 | -12.37 | 38.55 | 43.50 | -4.95 | QP |
| 5 | 184.2300 | 50.21 | -12.05 | 38.16 | 43.50 | -5.34 | QP |
| 6 | 311.3000 | 48.23 | -11.22 | 37.01 | 46.00 | -8.99 | QP |

9. ANTENNA REQUIREMENT

REQUIREMENT

Please refer to FCC part 15.203

An intentional radiator shall be designed to ensure that no antenna other than that furnished by the responsible party shall be used with the device. The use of a permanently attached antenna or of an antenna that uses a unique coupling to the intentional radiator shall be considered sufficient to comply with the provisions of this section. The manufacturer may design the unit so that a broken antenna can be replaced by the user, but the use of a standard antenna jack or electrical connector is prohibited.

Please refer to FCC part 15.247(b)(4)

The conducted output power limit specified in paragraph (b) of this section is based on the use of antennas with directional gains that do not exceed 6 dBi. Except as shown in paragraph (c) of this section, if transmitting antennas of directional gain greater than 6 dBi are used, the conducted output power from the intentional radiator shall be reduced below the stated values in paragraphs (b)(1), (b)(2), and (b)(3) of this section, as appropriate, by the amount in dB that the directional gain of the antenna exceeds 6 dBi.

DESCRIPTION

Pass

10. AC POWER LINE CONDUCTED EMISSION

LIMITS

Please refer to CFR 47 FCC §15.207 (a) and ISED RSS-Gen Clause 8.8

| FREQUENCY (MHz) | Quasi-peak | Average |
|-----------------|------------|-----------|
| 0.15 -0.5 | 66 - 56 * | 56 - 46 * |
| 0.50 -5.0 | 56.00 | 46.00 |
| 5.0 -30.0 | 60.00 | 50.00 |

TEST SETUP AND PROCEDURE

Refer to ANSI C63.10-2013 clause 6.2.

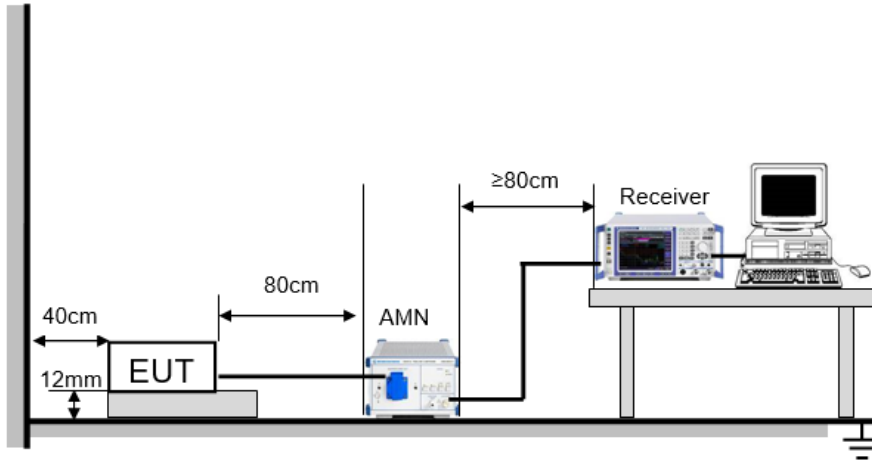

The EUT is put on a table of non-conducting material that is 12 mm high. The vertical conducting wall of shielding is located 40 cm to the rear of the EUT. The power line of the EUT is connected to the AC mains through a Artificial Mains Network (A.M.N.). A EMI Measurement Receiver (R&S Test Receiver ESR3) is used to test the emissions from both sides of AC line. According to the requirements in Section 6.2 of ANSI C63.10-2013. Conducted emissions from the EUT measured in the frequency range between 0.15 MHz and 30 MHz using CISPR Quasi-Peak and average detector mode. The bandwidth of EMI test receiver is set at 9 kHz.

The arrangement of the equipment is installed to meet the standards and operating in a manner, which tends to maximize its emission characteristics in a normal application.

TEST ENVIRONMENT

| | | | |
|---------------------|--------|-------------------|-----------------|
| Temperature | 23.6°C | Relative Humidity | 55% |
| Atmosphere Pressure | 101kPa | Test Voltage | AC 120 V, 60 Hz |

TEST DATE / ENGINEER

| | | | |
|-----------|----------------|---------|-------------|
| Test Date | April 29, 2024 | Test By | Fanny Huang |
|-----------|----------------|---------|-------------|

TEST RESULTS

| | | | |
|------------|---------|-----------------|------|
| Test Mode: | 802.11b | Frequency(MHz): | 2412 |
| Line: | Line | | |

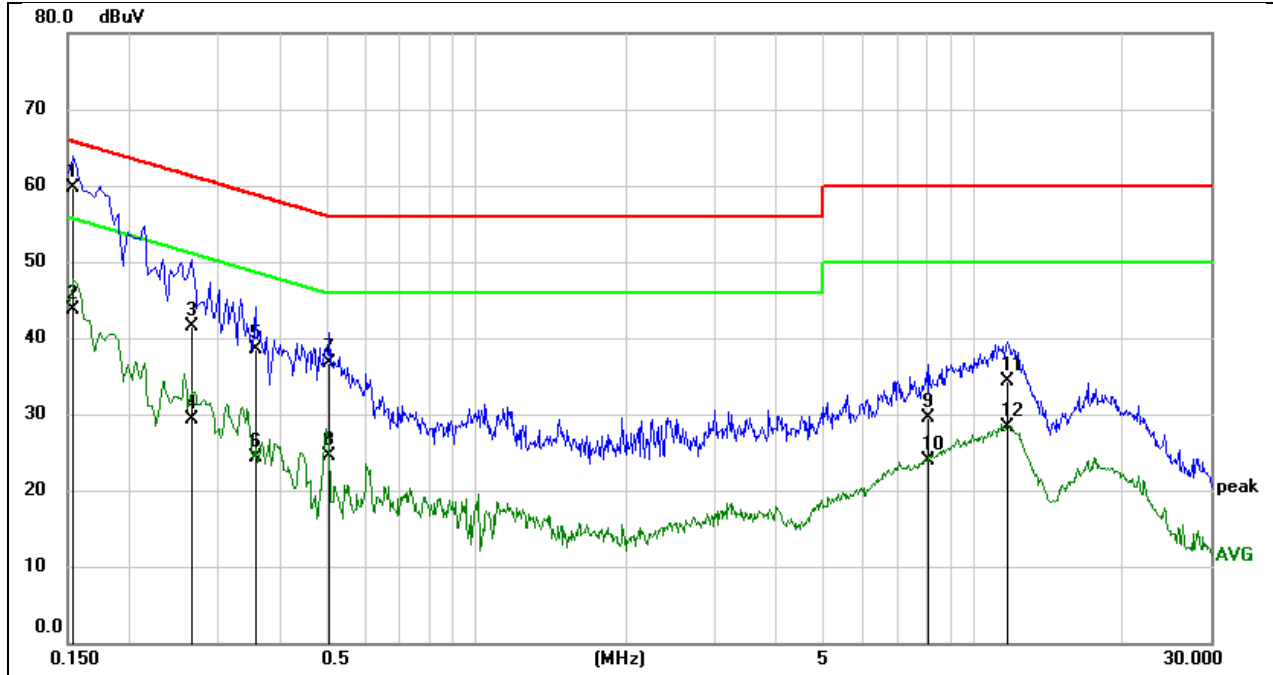

| No. | Frequency (MHz) | Reading (dBuV) | Correct (dB) | Result (dBuV) | Limit (dBuV) | Margin (dB) | Remark |
|-----|-----------------|----------------|--------------|---------------|--------------|-------------|--------|
| 1 | 0.1527 | 49.35 | 10.28 | 59.63 | 65.85 | -6.22 | QP |
| 2 | 0.1527 | 33.33 | 10.28 | 43.61 | 55.85 | -12.24 | AVG |
| 3 | 0.2651 | 31.28 | 10.19 | 41.47 | 61.27 | -19.80 | QP |
| 4 | 0.2651 | 19.03 | 10.19 | 29.22 | 51.27 | -22.05 | AVG |
| 5 | 0.3612 | 28.24 | 10.19 | 38.43 | 58.70 | -20.27 | QP |
| 6 | 0.3612 | 14.06 | 10.19 | 24.25 | 48.70 | -24.45 | AVG |
| 7 | 0.5061 | 26.50 | 10.20 | 36.70 | 56.00 | -19.30 | QP |
| 8 | 0.5061 | 14.26 | 10.20 | 24.46 | 46.00 | -21.54 | AVG |
| 9 | 8.1322 | 19.21 | 10.31 | 29.52 | 60.00 | -30.48 | QP |
| 10 | 8.1322 | 13.52 | 10.31 | 23.83 | 50.00 | -26.17 | AVG |
| 11 | 11.6720 | 23.95 | 10.42 | 34.37 | 60.00 | -25.63 | QP |
| 12 | 11.6720 | 17.87 | 10.42 | 28.29 | 50.00 | -21.71 | AVG |

Note:

1. Result = Reading + Correct Factor.
2. If QP Result complies with AV limit, AV Result is deemed to comply with AV limit.
3. Test setup: RBW: 200 Hz (9 kHz ~ 150 kHz), 9 kHz (150 kHz ~ 30 MHz).
4. Step size: 80 Hz (0.009 MHz ~ 0.15 MHz), 4 kHz (0.15 MHz ~ 30 MHz), Scan time: auto.

Note: All the modes have been tested, only the worst data was recorded in the report.

| | | | |
|------------|---------|-----------------|------|
| Test Mode: | 802.11b | Frequency(MHz): | 2412 |
| Line: | Neutral | | |

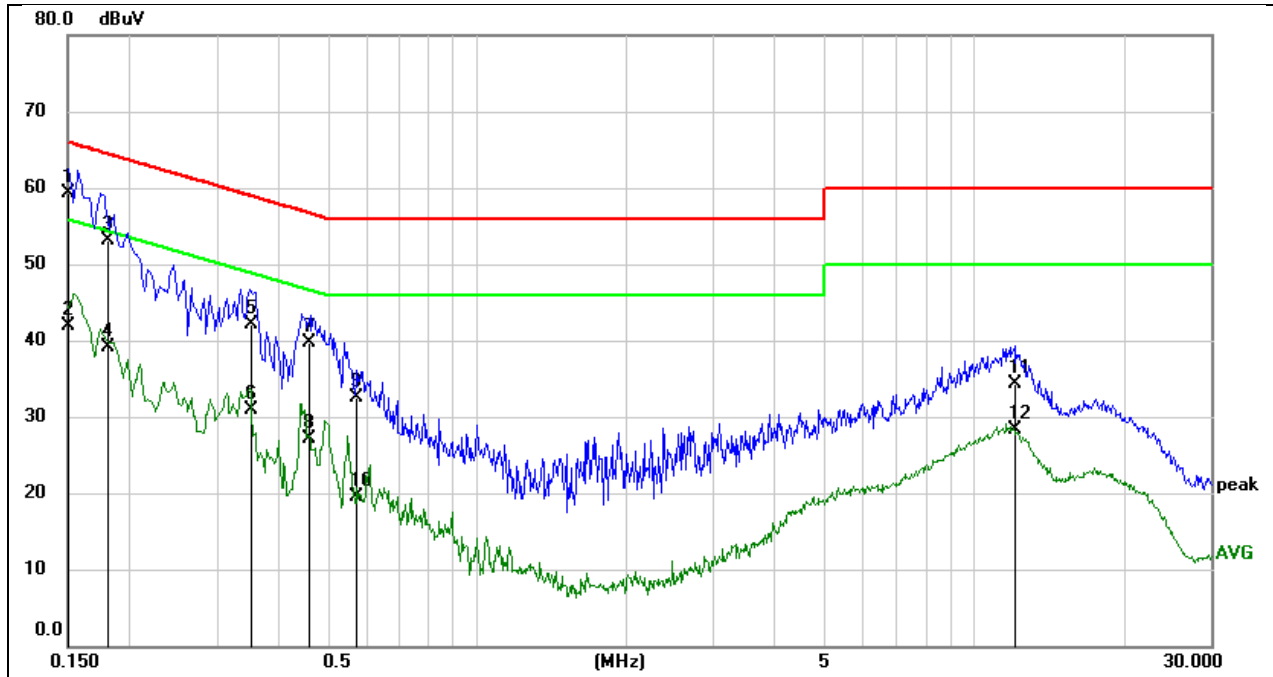

| No. | Frequency (MHz) | Reading (dBuV) | Correct (dB) | Result (dBuV) | Limit (dBuV) | Margin (dB) | Remark |
|-----|-----------------|----------------|--------------|---------------|--------------|-------------|--------|
| 1 | 0.1501 | 49.03 | 10.29 | 59.32 | 65.99 | -6.67 | QP |
| 2 | 0.1501 | 31.63 | 10.29 | 41.92 | 55.99 | -14.07 | AVG |
| 3 | 0.1814 | 42.79 | 10.23 | 53.02 | 64.42 | -11.40 | QP |
| 4 | 0.1814 | 28.90 | 10.23 | 39.13 | 54.42 | -15.29 | AVG |
| 5 | 0.3503 | 31.86 | 10.19 | 42.05 | 58.96 | -16.91 | QP |
| 6 | 0.3503 | 20.72 | 10.19 | 30.91 | 48.96 | -18.05 | AVG |
| 7 | 0.4583 | 29.51 | 10.20 | 39.71 | 56.72 | -17.01 | QP |
| 8 | 0.4583 | 16.94 | 10.20 | 27.14 | 46.72 | -19.58 | AVG |
| 9 | 0.5740 | 22.23 | 10.20 | 32.43 | 56.00 | -23.57 | QP |
| 10 | 0.5740 | 9.24 | 10.20 | 19.44 | 46.00 | -26.56 | AVG |
| 11 | 12.0367 | 23.83 | 10.44 | 34.27 | 60.00 | -25.73 | QP |
| 12 | 12.0367 | 17.93 | 10.44 | 28.37 | 50.00 | -21.63 | AVG |

Note:

1. Result = Reading + Correct Factor.
2. If QP Result complies with AV limit, AV Result is deemed to comply with AV limit.
3. Test setup: RBW: 200 Hz (9 kHz ~ 150 kHz), 9 kHz (150 kHz ~ 30 MHz).
4. Step size: 80 Hz (0.009 MHz ~ 0.15 MHz), 4 kHz (0.15 MHz ~ 30 MHz), Scan time: auto.

Note: All the modes have been tested, only the worst data was recorded in the report.

11. TEST DATA

11.1. APPENDIX A: DTS BANDWIDTH

11.1.1. Test Result

| Test Mode | Antenna | Frequency[MHz] | DTS BW [MHz] | FL[MHz] | FH[MHz] | Limit[MHz] | Verdict |
|-----------|---------|----------------|--------------|---------|---------|------------|---------|
| 11B | Ant1 | 2412 | 9.00 | 2407.48 | 2416.48 | ≥ 0.5 | PASS |
| | | 2437 | 9.04 | 2432.44 | 2441.48 | ≥ 0.5 | PASS |
| | | 2462 | 8.16 | 2457.44 | 2465.60 | ≥ 0.5 | PASS |
| 11G | Ant1 | 2412 | 16.60 | 2403.68 | 2420.28 | ≥ 0.5 | PASS |
| | | 2437 | 16.48 | 2428.68 | 2445.16 | ≥ 0.5 | PASS |
| | | 2462 | 16.48 | 2453.68 | 2470.16 | ≥ 0.5 | PASS |
| 11N20SISO | Ant1 | 2412 | 17.76 | 2403.12 | 2420.88 | ≥ 0.5 | PASS |
| | | 2437 | 17.72 | 2428.08 | 2445.80 | ≥ 0.5 | PASS |
| | | 2462 | 17.72 | 2453.08 | 2470.80 | ≥ 0.5 | PASS |

11.1.2. Test Graphs

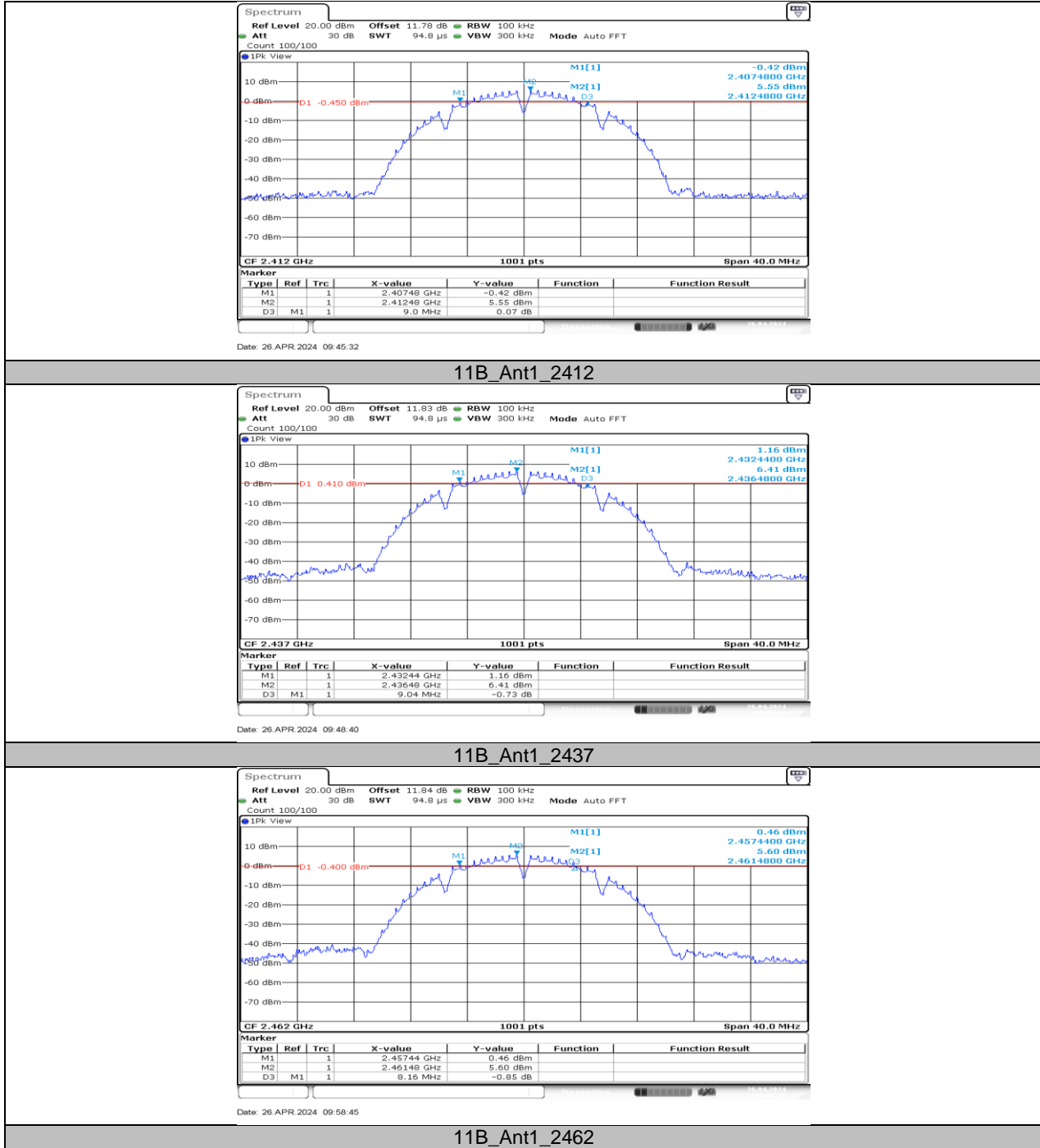

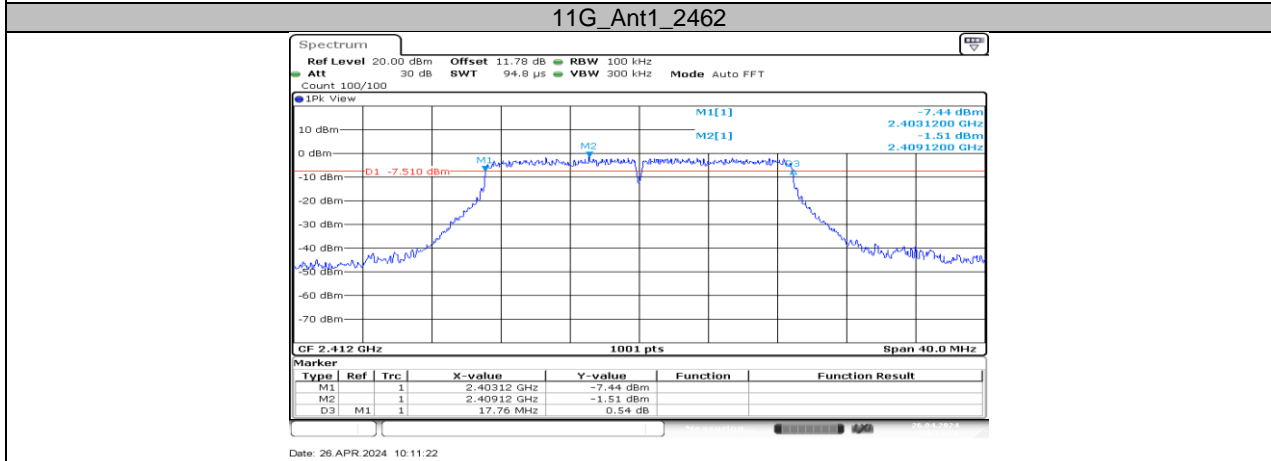
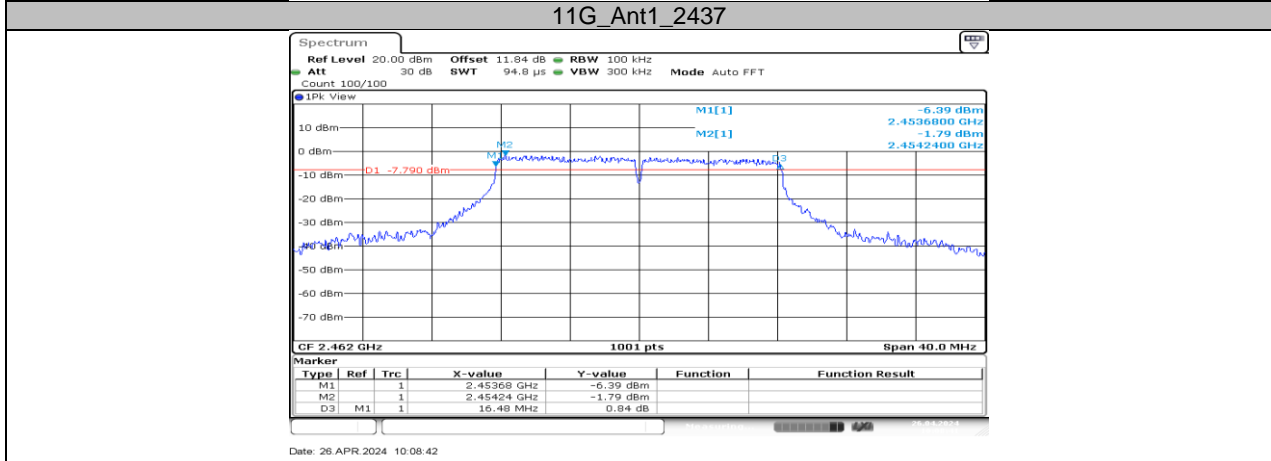
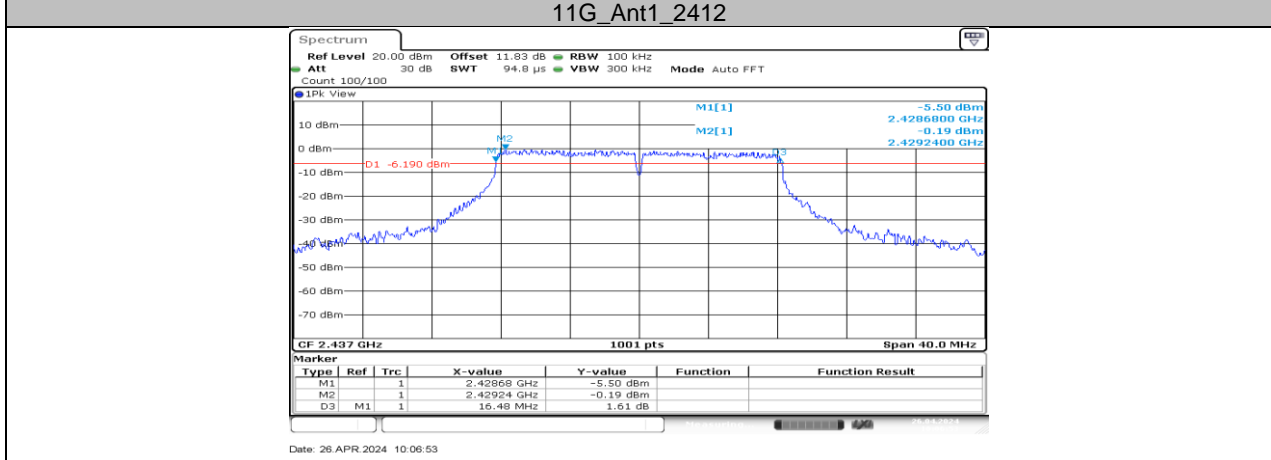
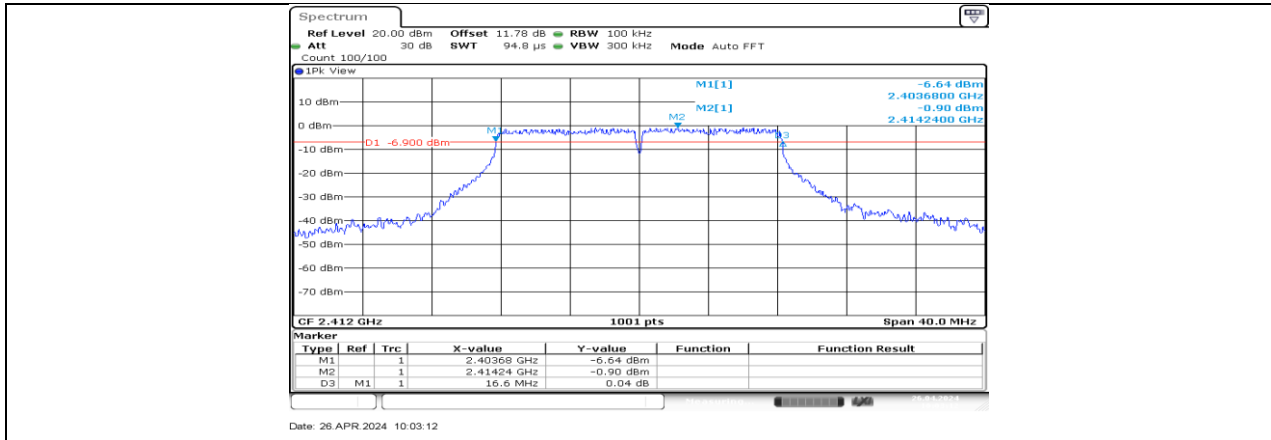

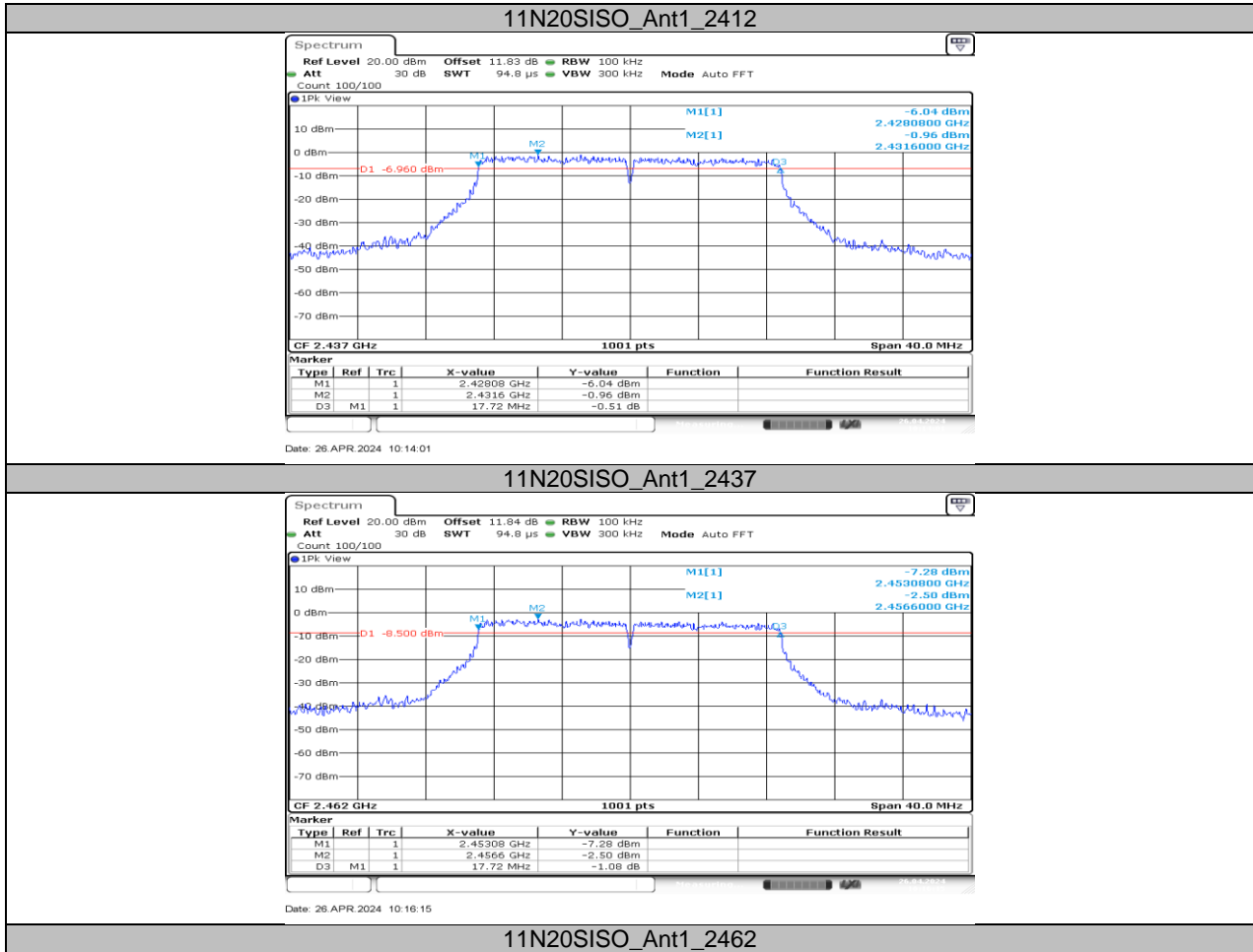

11.2. APPENDIX B: OCCUPIED CHANNEL BANDWIDTH

11.2.1. Test Result

| Test Mode | Antenna | Frequency[MHz] | OCB [MHz] | FL[MHz] | FH[MHz] | Verdict |
|-----------|---------|----------------|-----------|-----------|-----------|---------|
| 11B | Ant1 | 2412 | 13.267 | 2405.4066 | 2418.6733 | PASS |
| | | 2437 | 13.506 | 2430.0869 | 2443.5934 | PASS |
| | | 2462 | 13.546 | 2455.0470 | 2468.5934 | PASS |
| 11G | Ant1 | 2412 | 17.463 | 2403.1289 | 2420.5914 | PASS |
| | | 2437 | 17.502 | 2427.9690 | 2445.4715 | PASS |
| | | 2462 | 17.582 | 2452.8891 | 2470.4715 | PASS |
| 11N20SISO | Ant1 | 2412 | 18.262 | 2402.8492 | 2421.1109 | PASS |
| | | 2437 | 18.342 | 2427.6893 | 2446.0310 | PASS |
| | | 2462 | 18.382 | 2452.6494 | 2471.0310 | PASS |

11.2.2. Test Graphs

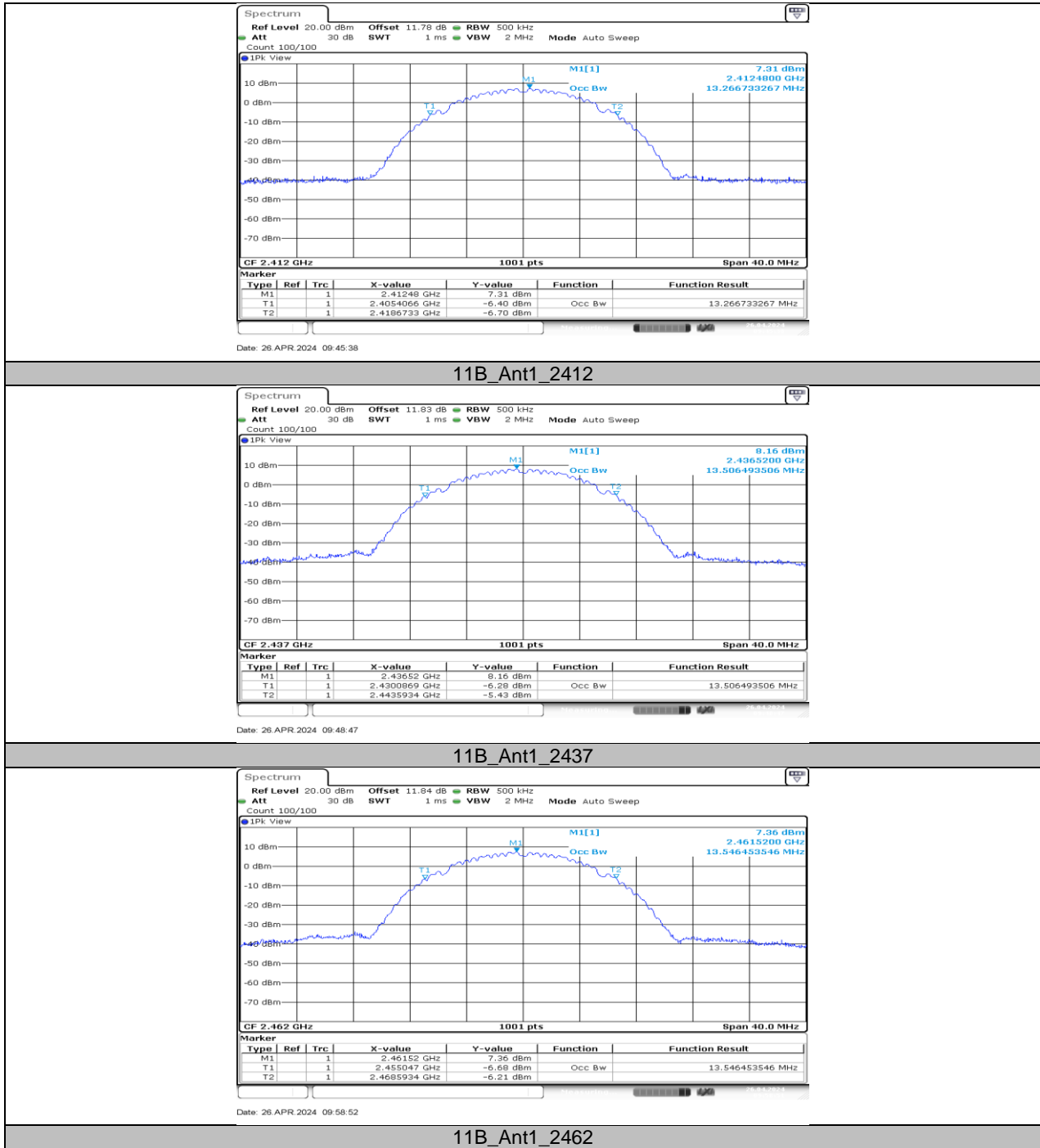

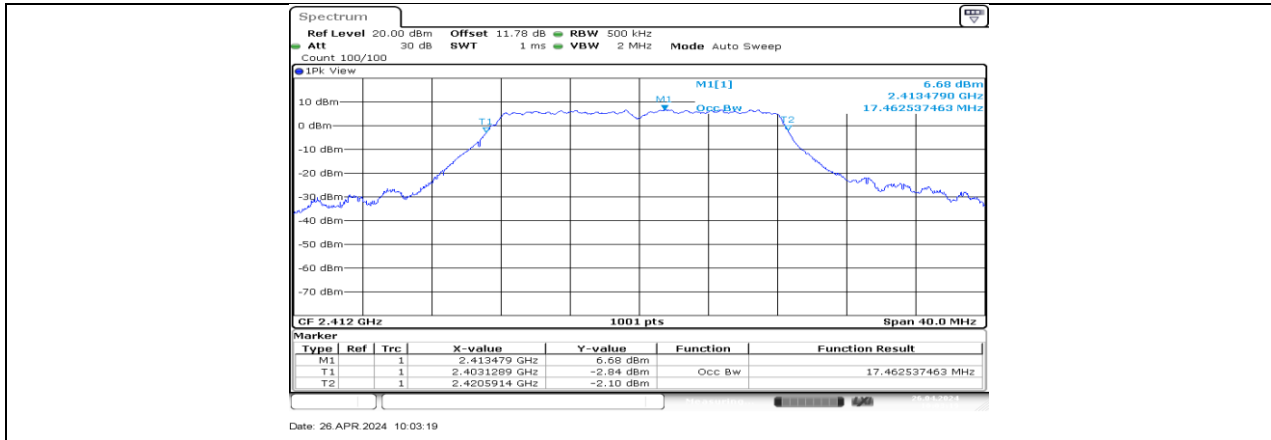

11G_Ant1_2412

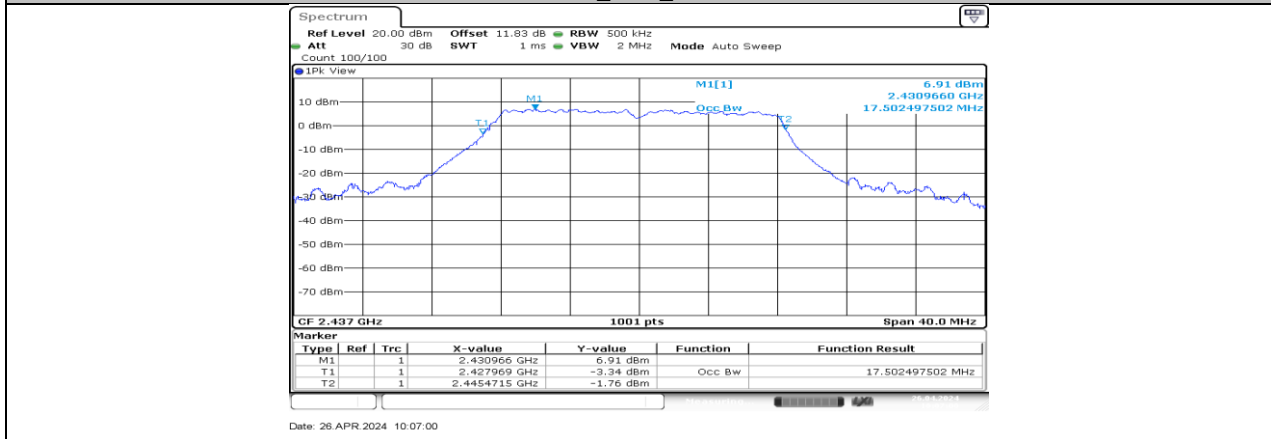

11G_Ant1_2437

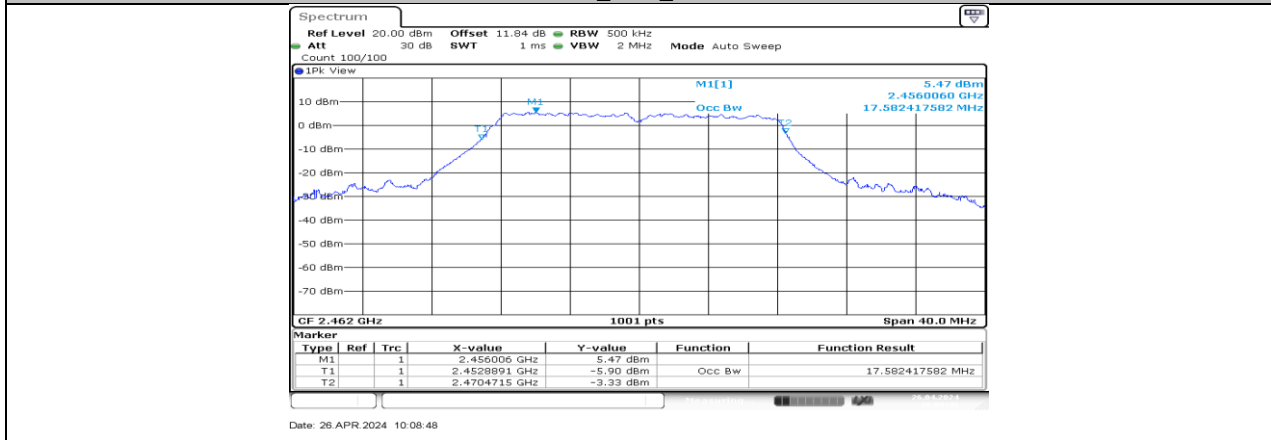

11G_Ant1_2462

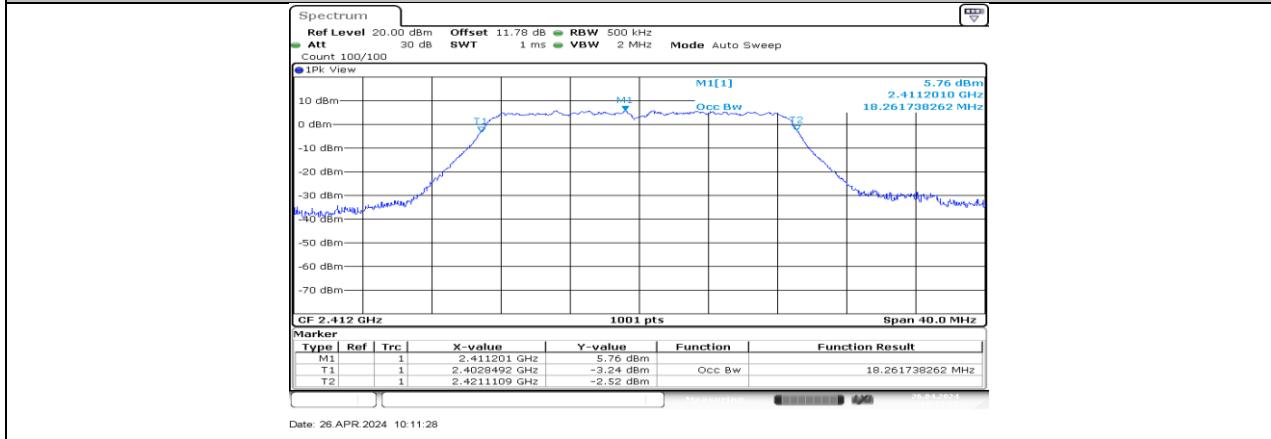

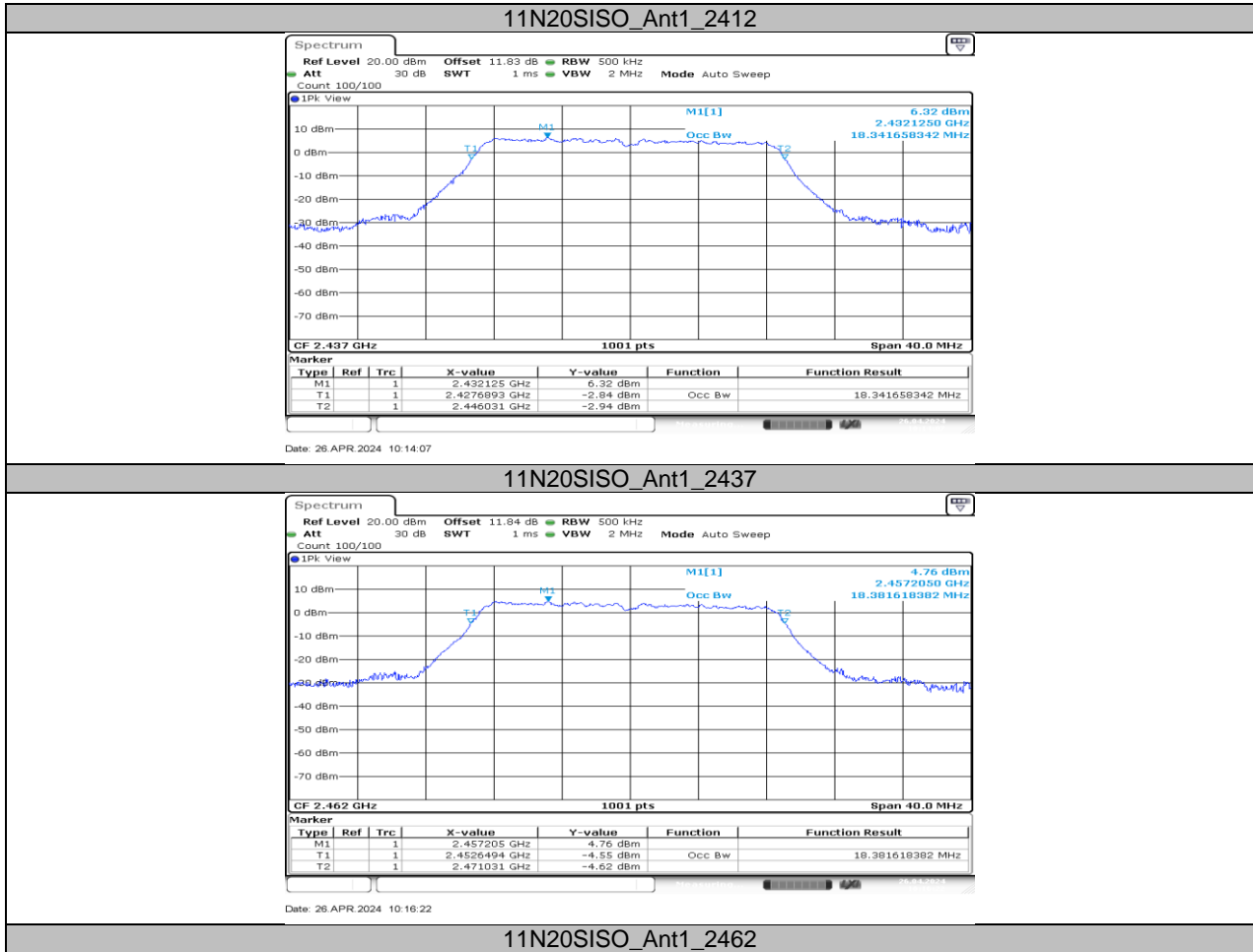

11N20SISO_Ant1_2462

11.3. APPENDIX C: MAXIMUM CONDUCTED OUTPUT POWER

11.3.1. Test Result

| Test Mode | Antenna | Frequency[MHz] | Result[dBm] | Limit[dBm] | Verdict |
|-----------|---------|----------------|-------------|------------|---------|
| 11B | Ant1 | 2412 | 15.44 | ≤30.00 | PASS |
| | | 2437 | 16.31 | ≤30.00 | PASS |
| | | 2462 | 16.16 | ≤30.00 | PASS |
| 11G | Ant1 | 2412 | 14.47 | ≤30.00 | PASS |
| | | 2437 | 14.54 | ≤30.00 | PASS |
| | | 2462 | 13.27 | ≤30.00 | PASS |
| 11N20SISO | Ant1 | 2412 | 13.59 | ≤30.00 | PASS |
| | | 2437 | 13.82 | ≤30.00 | PASS |
| | | 2462 | 12.41 | ≤30.00 | PASS |

Note: 1. Conducted Power=Meas. Level+ Correction Factor

2. The Duty Cycle Factor (refer to section 7.5) had already compensated to the test data.

11.4. APPENDIX D: MAXIMUM POWER SPECTRAL DENSITY

11.4.1. Test Result

| Test Mode | Antenna | Frequency[MHz] | Result[dBm/3kHz] | Limit[dBm/3kHz] | Verdict |
|-----------|---------|----------------|------------------|-----------------|---------|
| 11B | Ant1 | 2412 | -16.22 | ≤8.00 | PASS |
| | | 2437 | -15.42 | ≤8.00 | PASS |
| | | 2462 | -16.18 | ≤8.00 | PASS |
| 11G | Ant1 | 2412 | -18.74 | ≤8.00 | PASS |
| | | 2437 | -18.39 | ≤8.00 | PASS |
| | | 2462 | -19.57 | ≤8.00 | PASS |
| 11N20SISO | Ant1 | 2412 | -20.11 | ≤8.00 | PASS |
| | | 2437 | -20.06 | ≤8.00 | PASS |
| | | 2462 | -21.44 | ≤8.00 | PASS |

11.4.2. Test Graphs

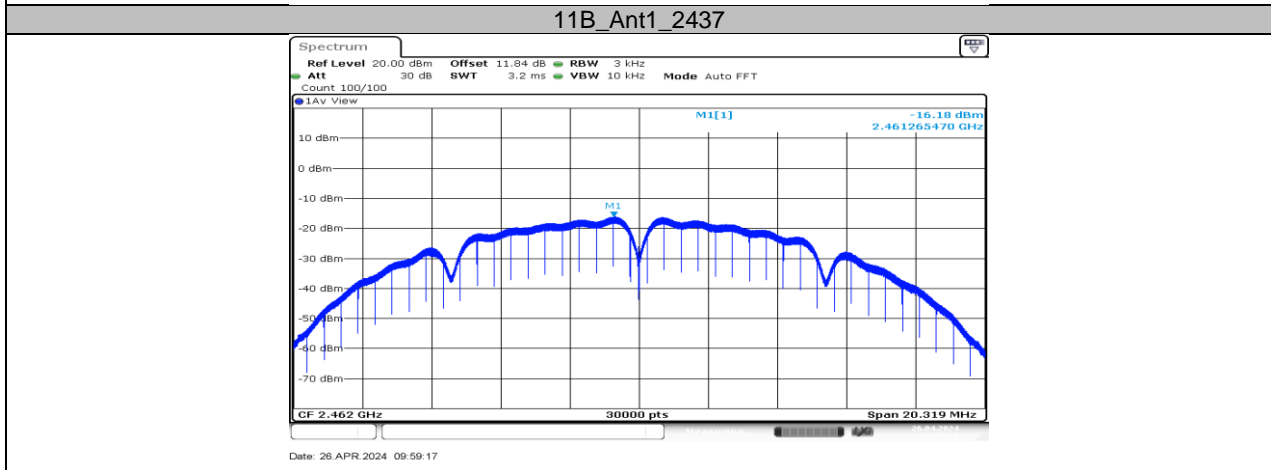
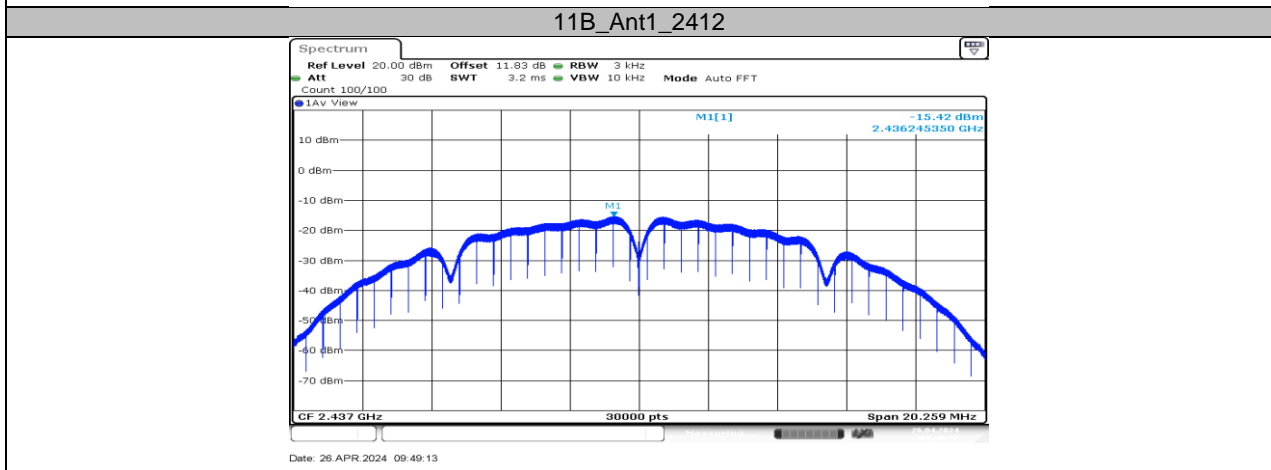
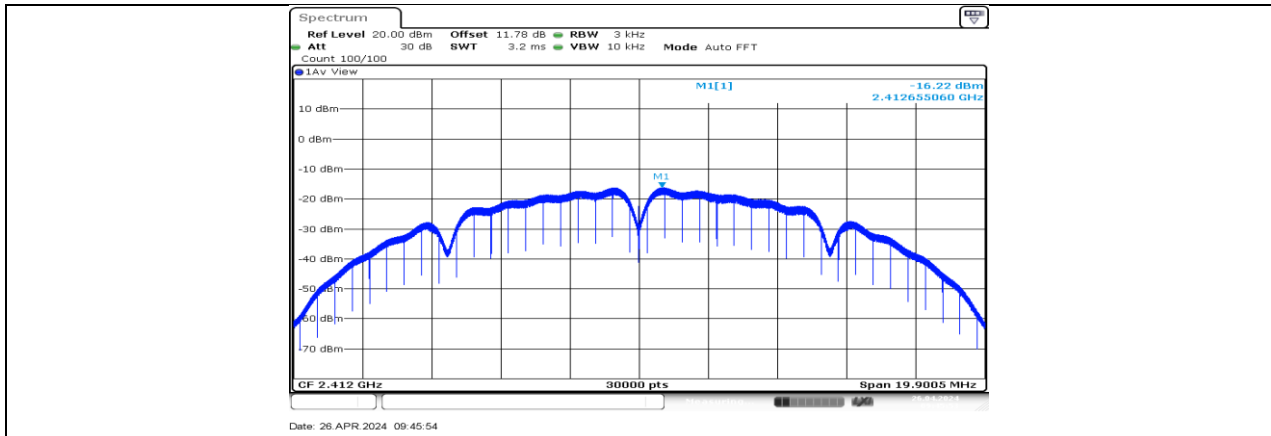

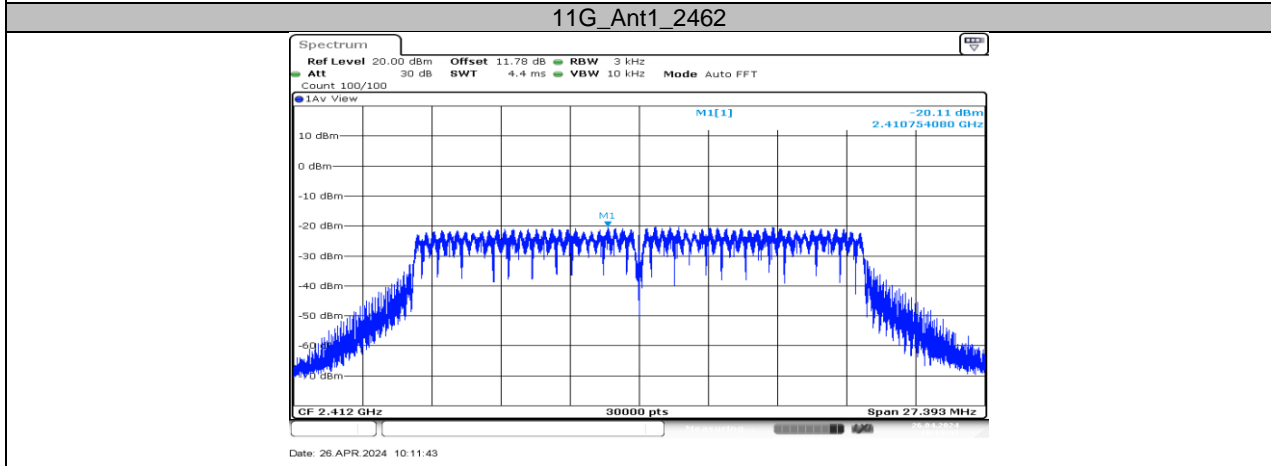
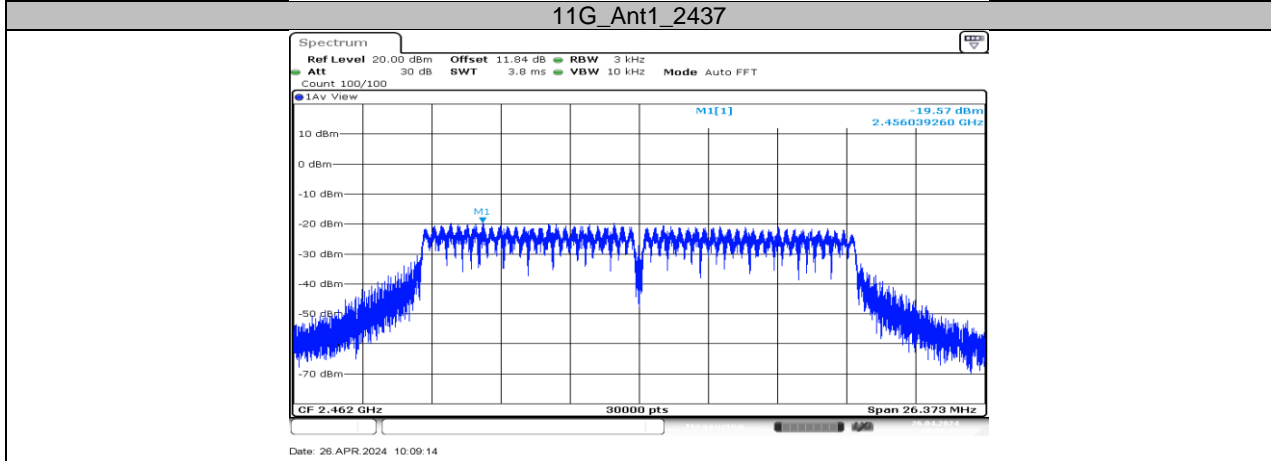
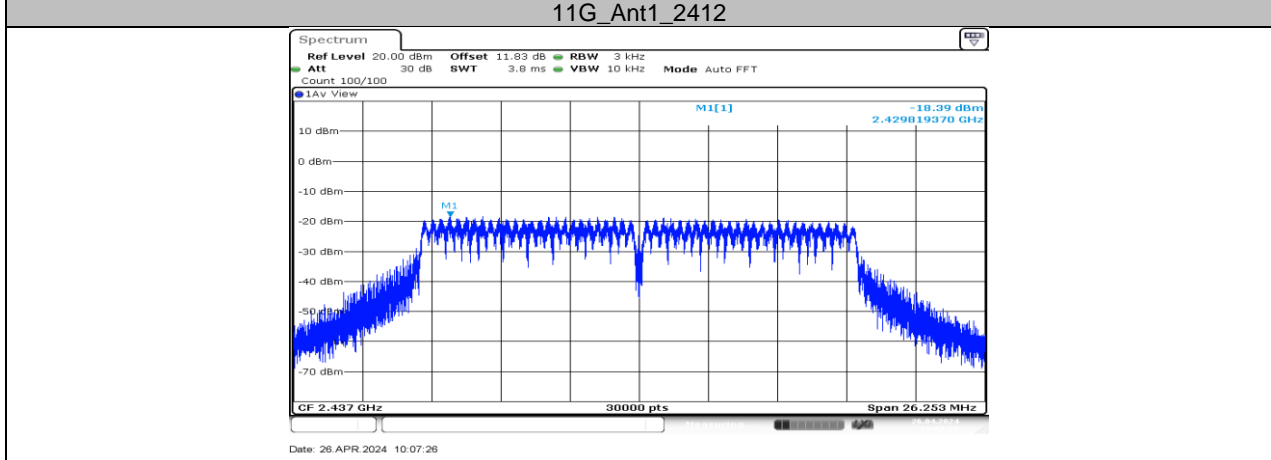
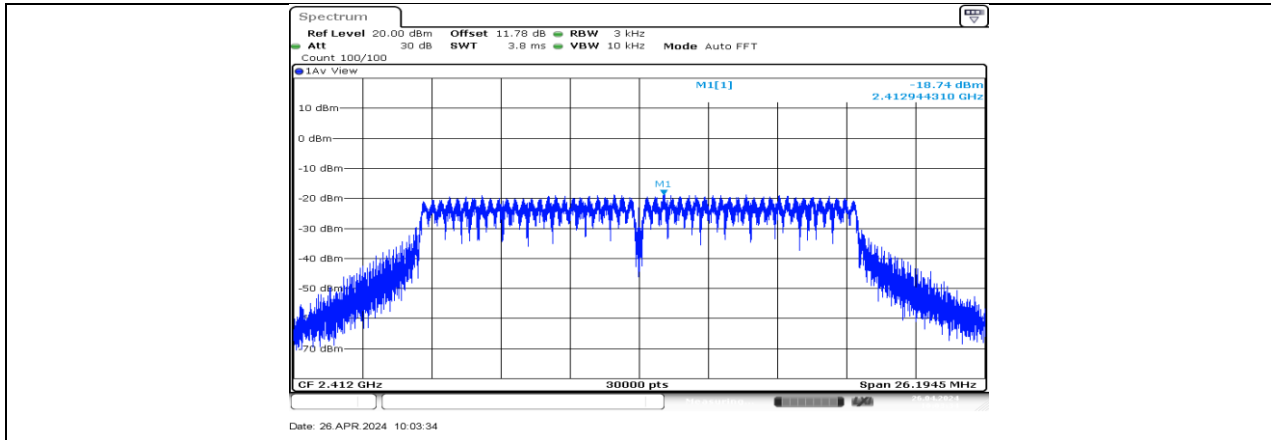

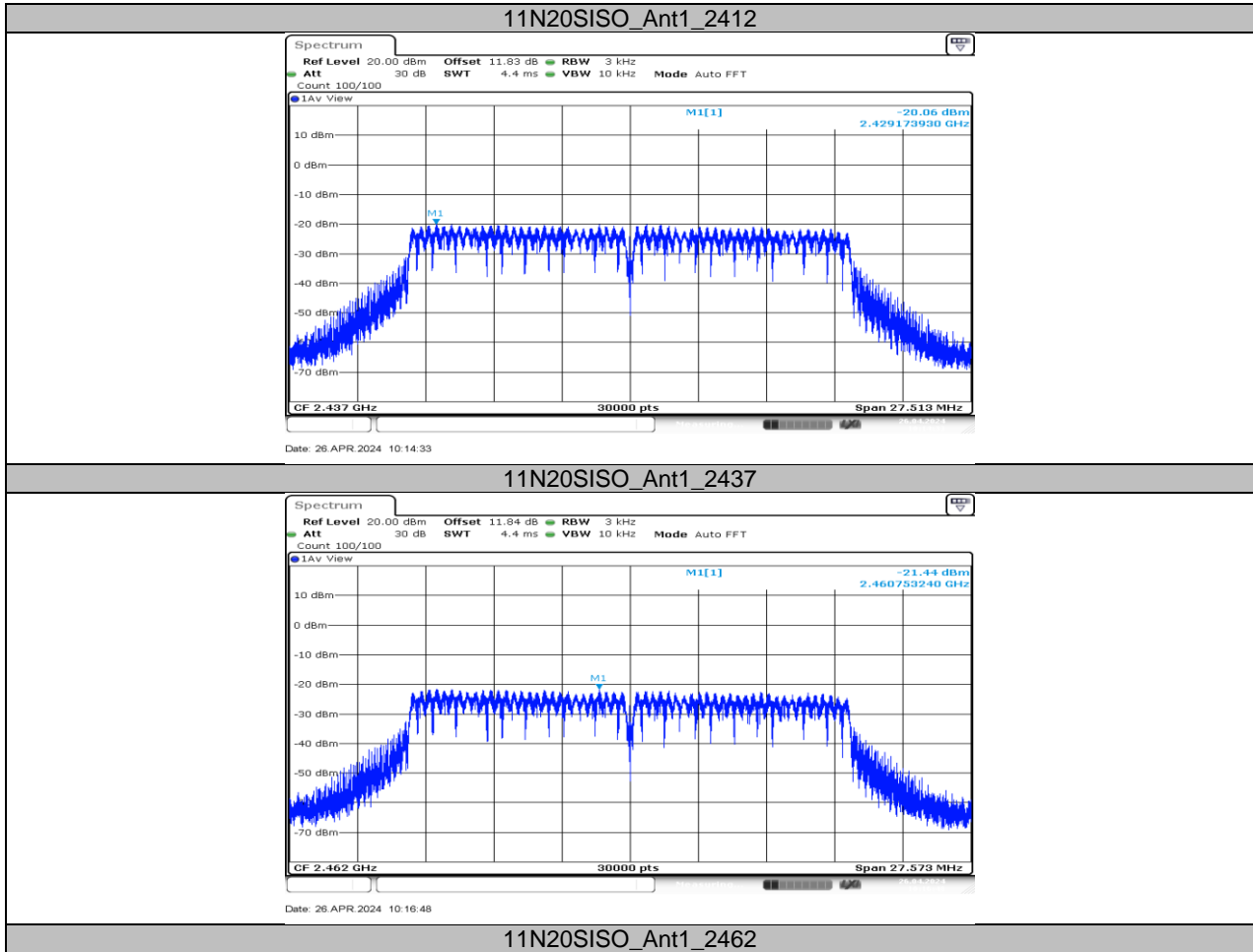

11.5. APPENDIX E: BAND EDGE MEASUREMENTS

11.5.1. Test Result

| Test Mode | Antenna | ChName | Frequency [MHz] | RefLevel [dBm] | Result[dBm] | Limit[dBm] | Verdict |
|-----------|---------|--------|-----------------|----------------|-------------|------------|---------|
| 11B | Ant1 | Low | 2412 | 5.41 | -45.46 | ≤-24.59 | PASS |
| | | High | 2462 | 5.59 | -46.83 | ≤-24.41 | PASS |
| 11G | Ant1 | Low | 2412 | -0.73 | -35.65 | ≤-30.73 | PASS |
| | | High | 2462 | -1.63 | -44.3 | ≤-31.63 | PASS |
| 11N20SISO | Ant1 | Low | 2412 | -1.41 | -38.81 | ≤-31.41 | PASS |
| | | High | 2462 | -2.76 | -44.43 | ≤-32.76 | PASS |

11.5.2. Test Graphs

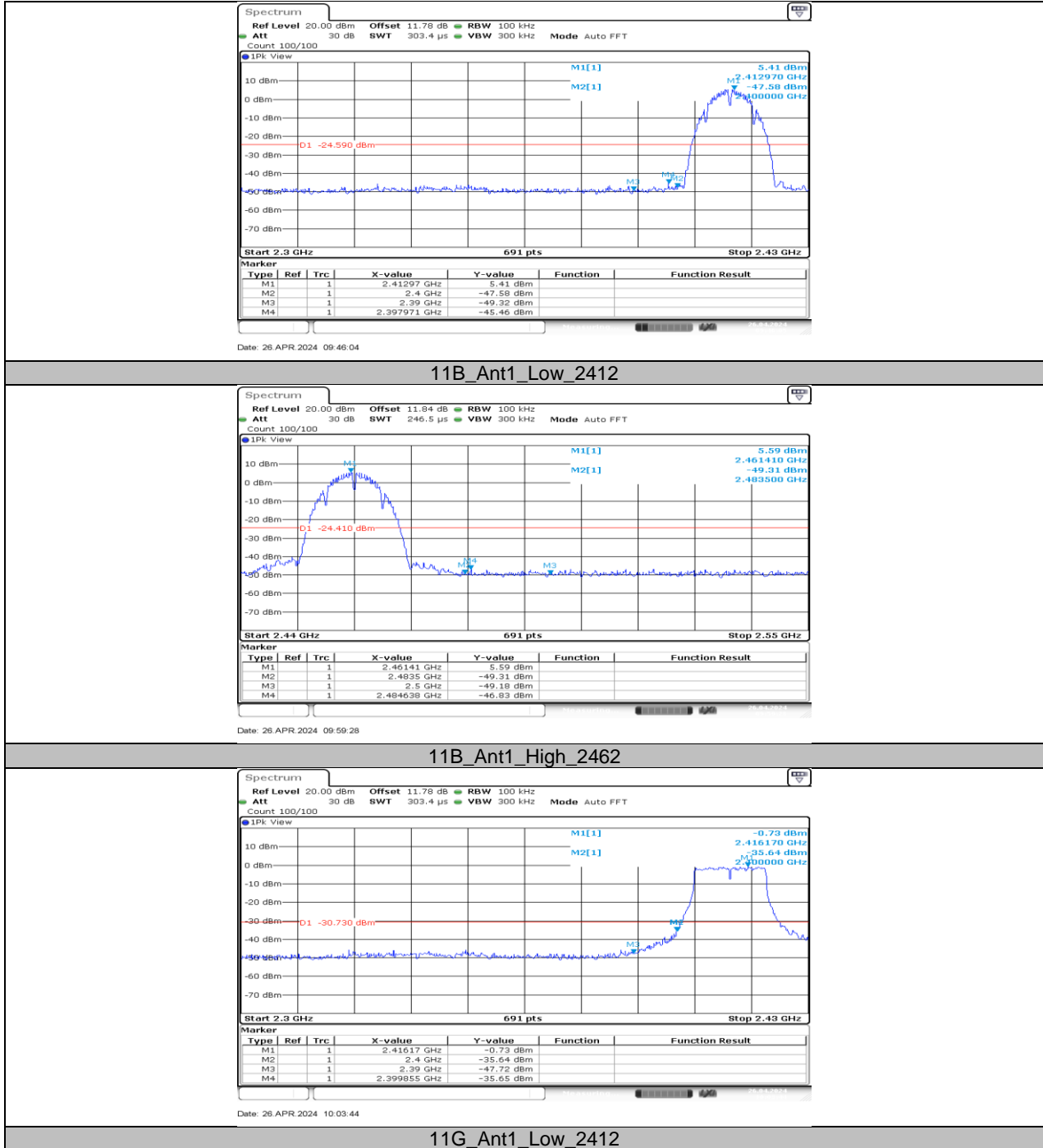

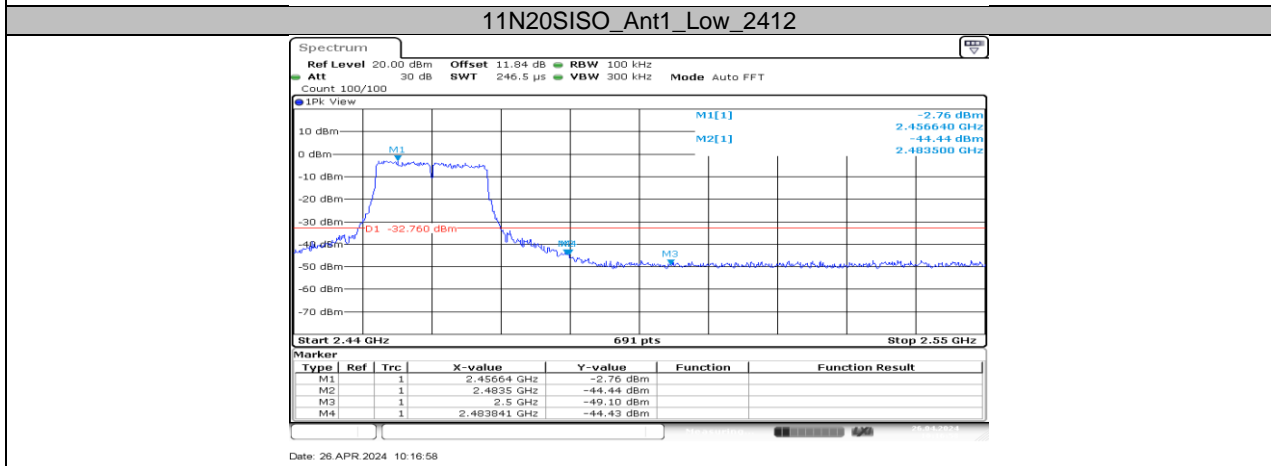
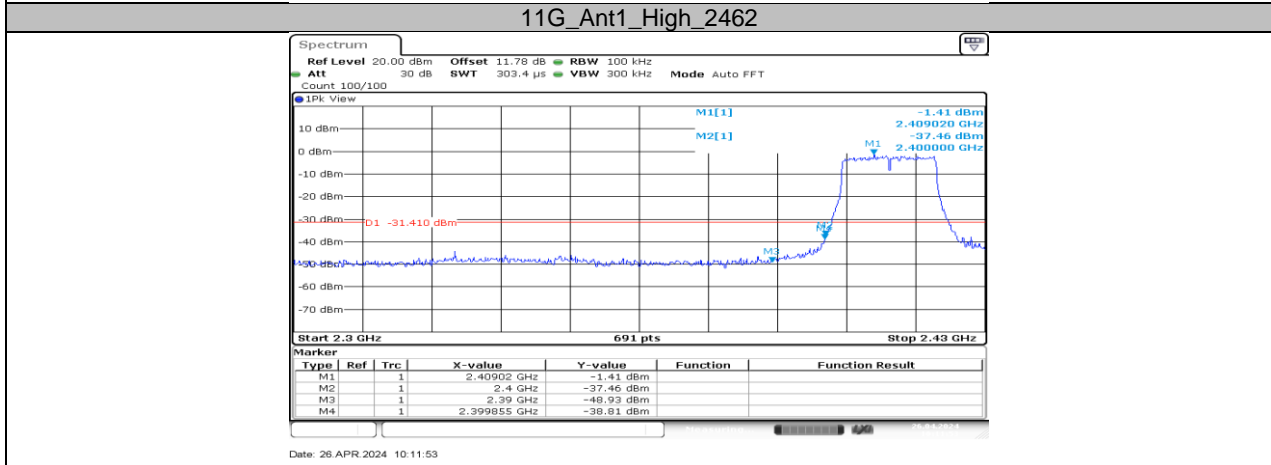
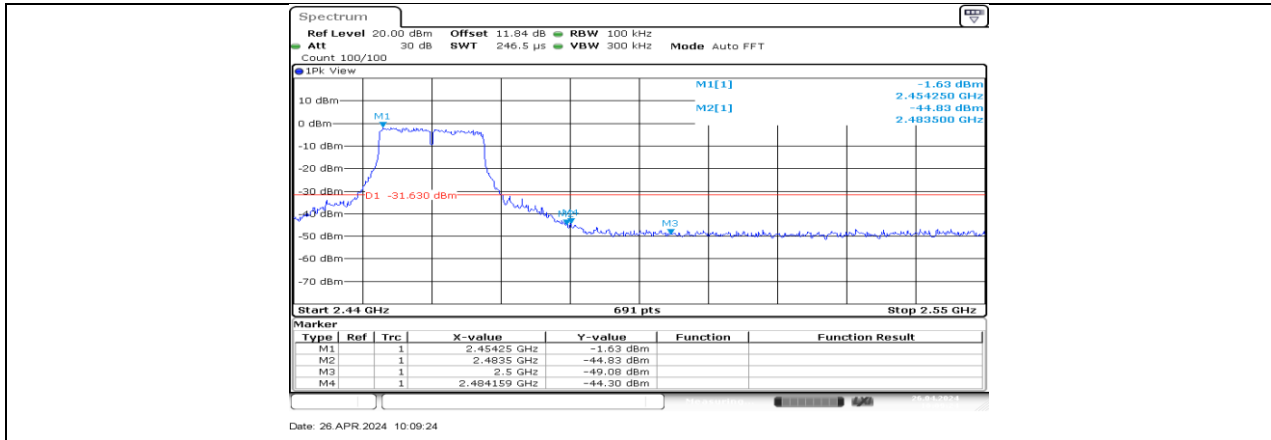

11.6. APPENDIX F: CONDUCTED SPURIOUS EMISSION

11.6.1. Test Result

| Test Mode | Antenna | Frequency[MHz] | FreqRange [Mhz] | Result [dBm] | Limit [dBm] | Verdict |
|-----------|---------|----------------|-----------------|--------------|-------------|---------|
| 11B | Ant1 | 2412 | Reference | 5.49 | --- | PASS |
| | | | 30~1000 | -49.78 | ≤-24.51 | PASS |
| | | | 1000~26500 | -50.46 | ≤-24.51 | PASS |
| | | 2437 | Reference | 6.40 | --- | PASS |
| | | | 30~1000 | -48.74 | ≤-23.6 | PASS |
| | | | 1000~26500 | -49.75 | ≤-23.6 | PASS |
| | | 2462 | Reference | 5.61 | --- | PASS |
| | | | 30~1000 | -49.92 | ≤-24.39 | PASS |
| | | | 1000~26500 | -50.25 | ≤-24.39 | PASS |
| 11G | Ant1 | 2412 | Reference | -0.69 | --- | PASS |
| | | | 30~1000 | -49.79 | ≤-30.69 | PASS |
| | | | 1000~26500 | -49.69 | ≤-30.69 | PASS |
| | | 2437 | Reference | -0.58 | --- | PASS |
| | | | 30~1000 | -49.39 | ≤-30.58 | PASS |
| | | | 1000~26500 | -50.29 | ≤-30.58 | PASS |
| | | 2462 | Reference | -2.07 | --- | PASS |
| | | | 30~1000 | -50.03 | ≤-32.07 | PASS |
| | | | 1000~26500 | -50.14 | ≤-32.07 | PASS |
| 11N20SISO | Ant1 | 2412 | Reference | -1.33 | --- | PASS |
| | | | 30~1000 | -50.13 | ≤-31.33 | PASS |
| | | | 1000~26500 | -49.9 | ≤-31.33 | PASS |
| | | 2437 | Reference | -0.93 | --- | PASS |
| | | | 30~1000 | -49.78 | ≤-30.93 | PASS |
| | | | 1000~26500 | -49.8 | ≤-30.93 | PASS |
| | | 2462 | Reference | -2.54 | --- | PASS |
| | | | 30~1000 | -50.2 | ≤-32.54 | PASS |
| | | | 1000~26500 | -49.64 | ≤-32.54 | PASS |

11.6.2. Test Graphs

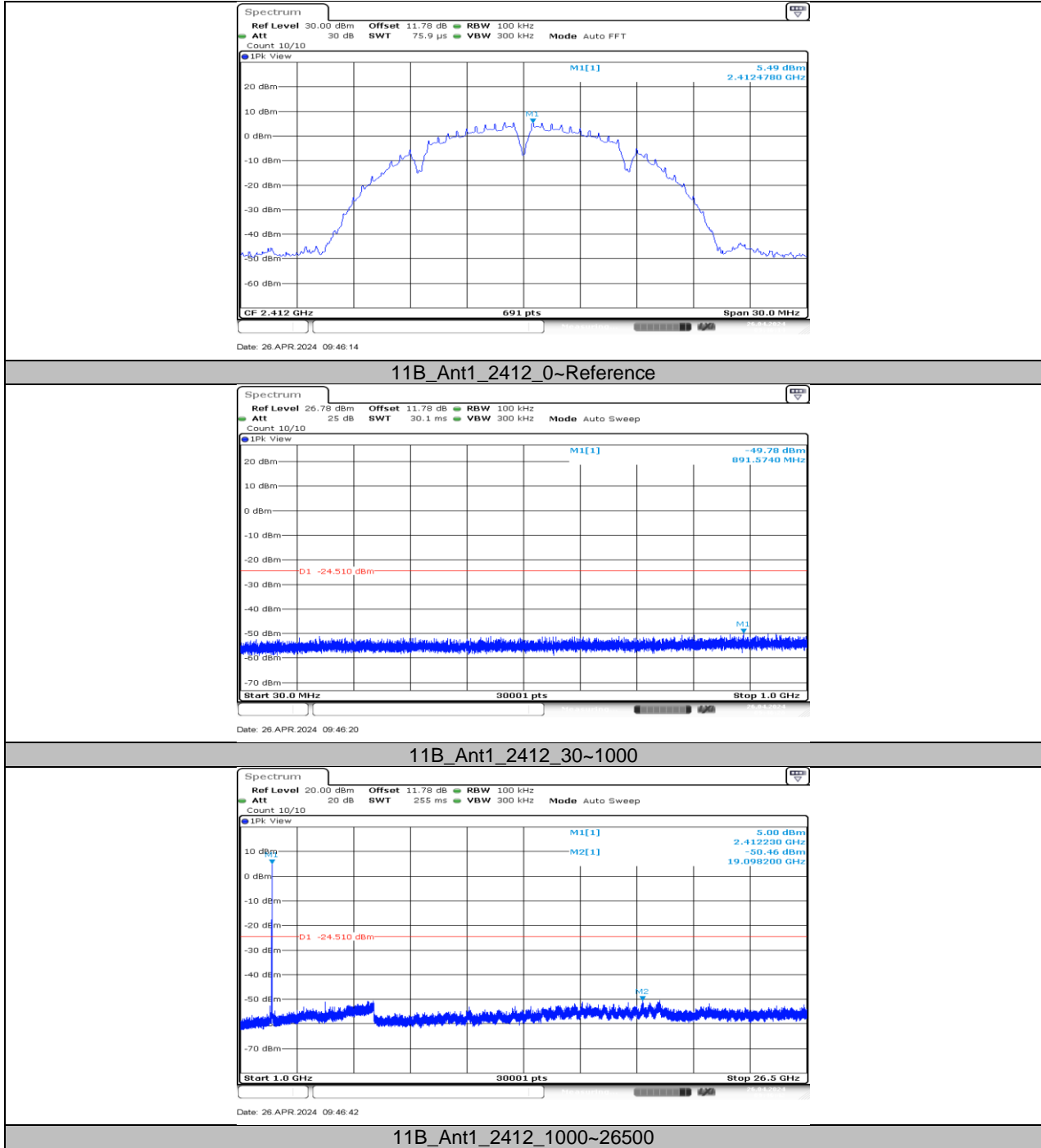

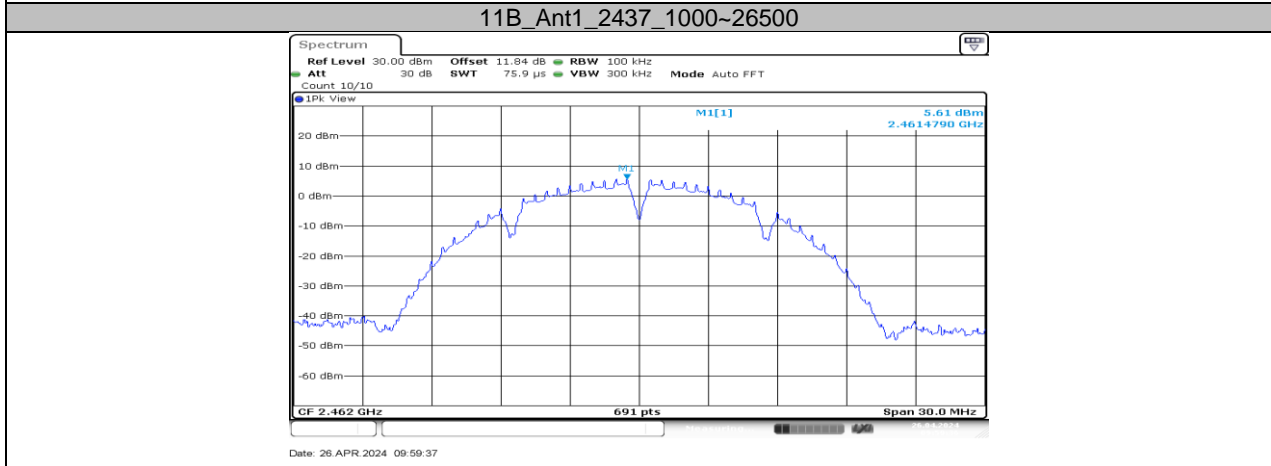
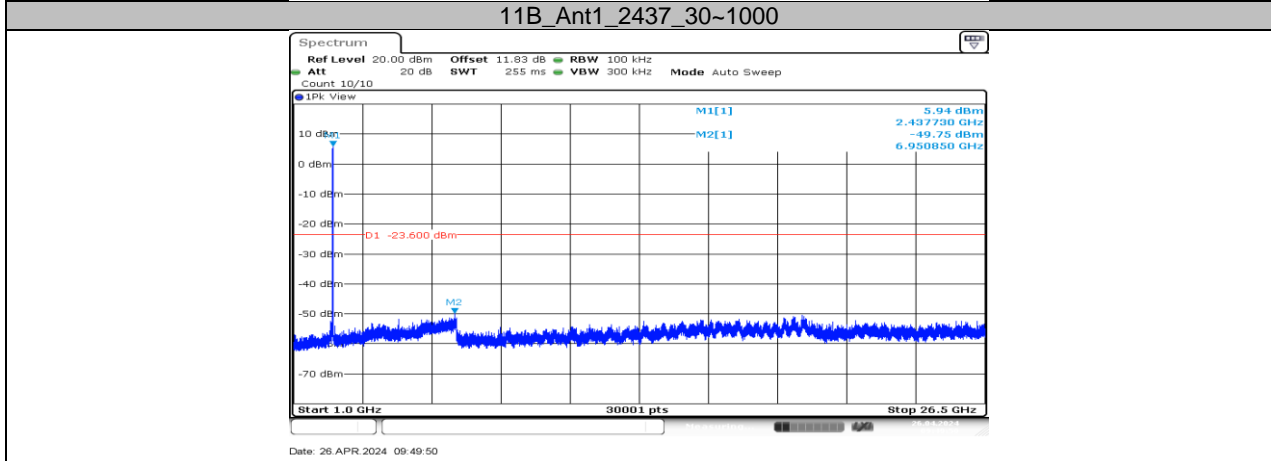
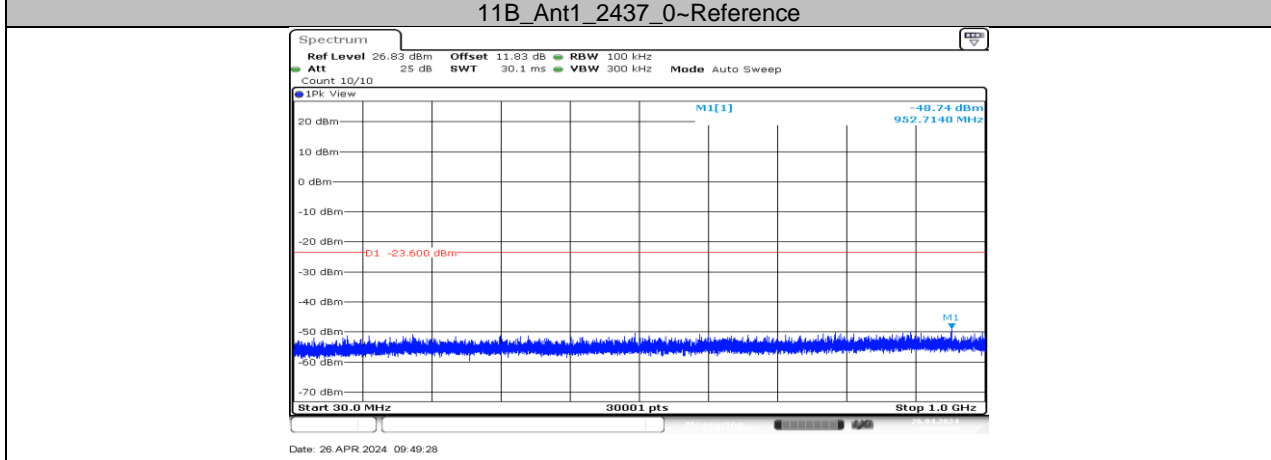
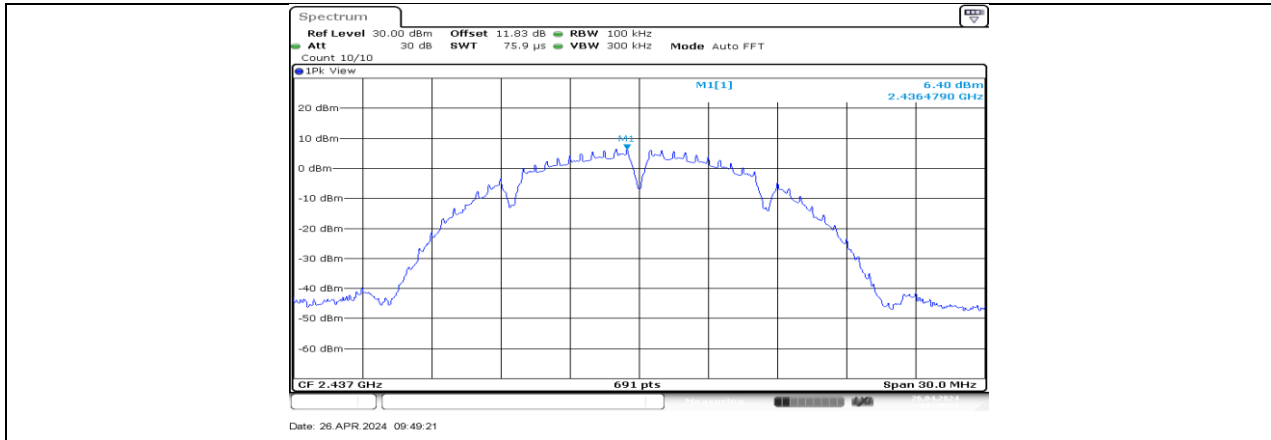

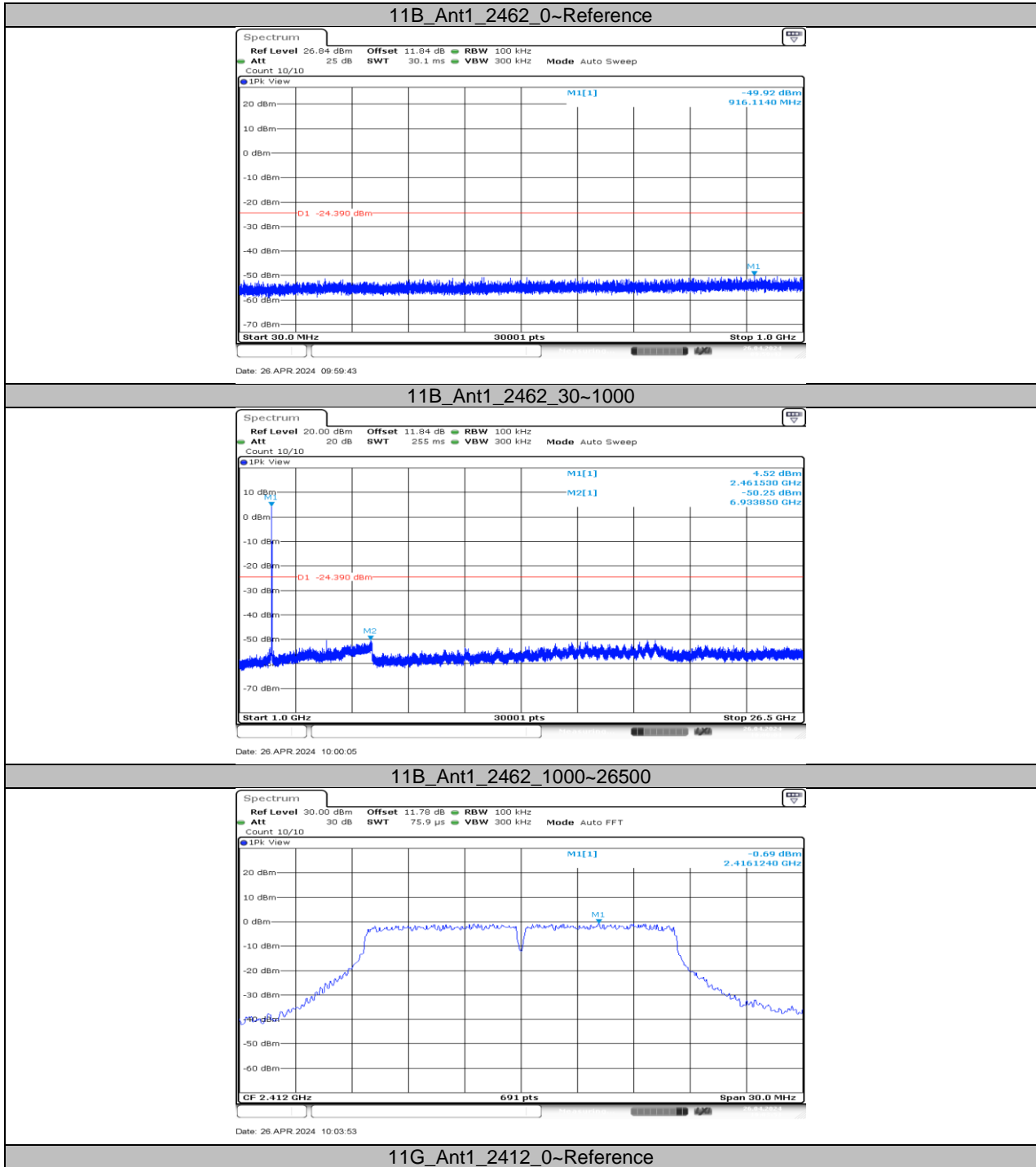

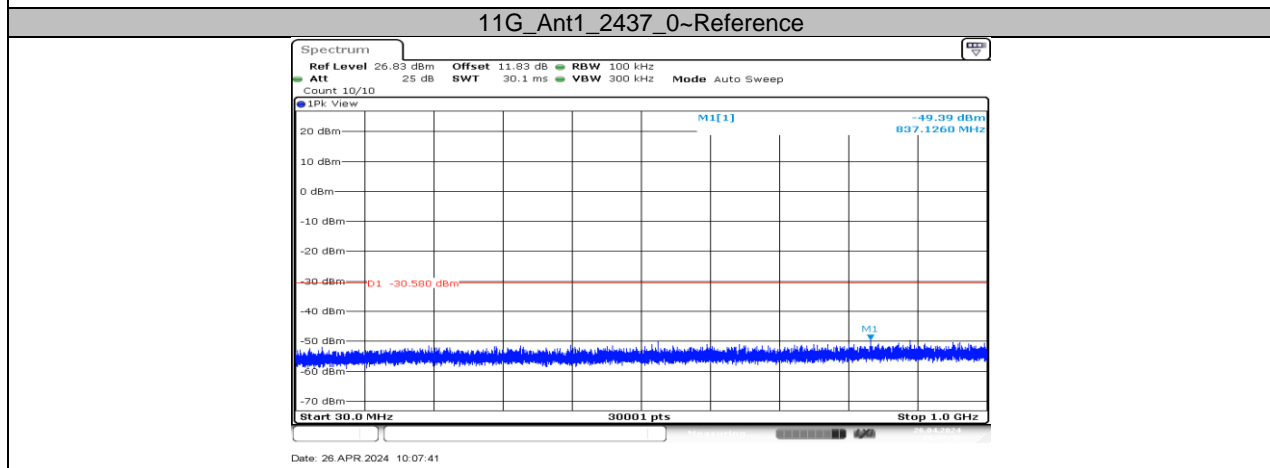
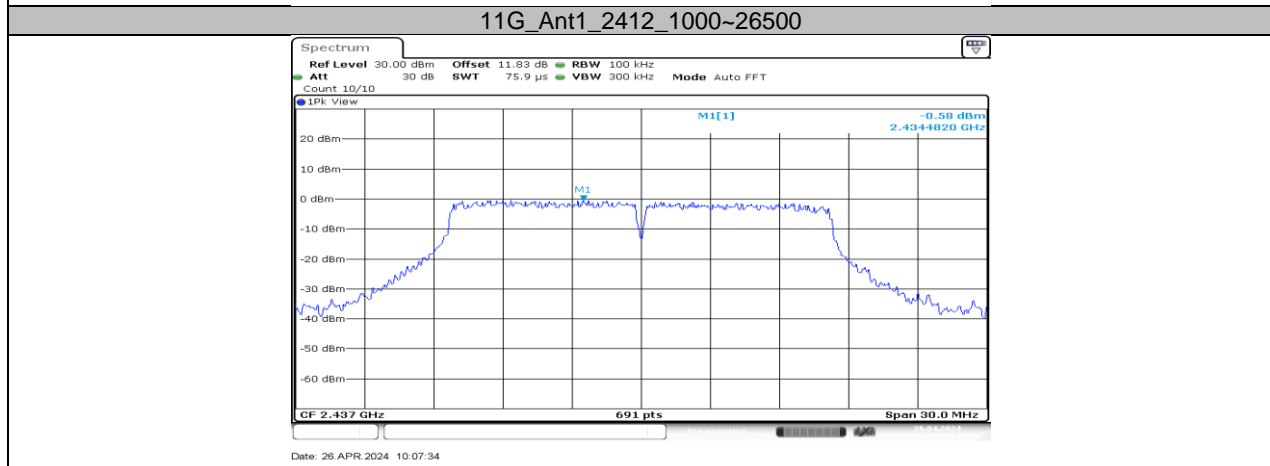
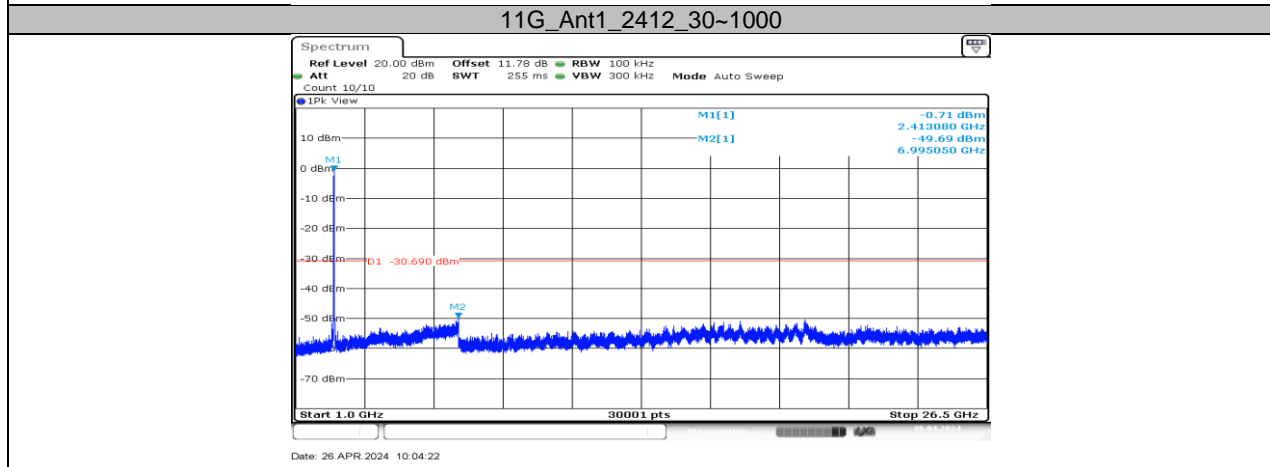
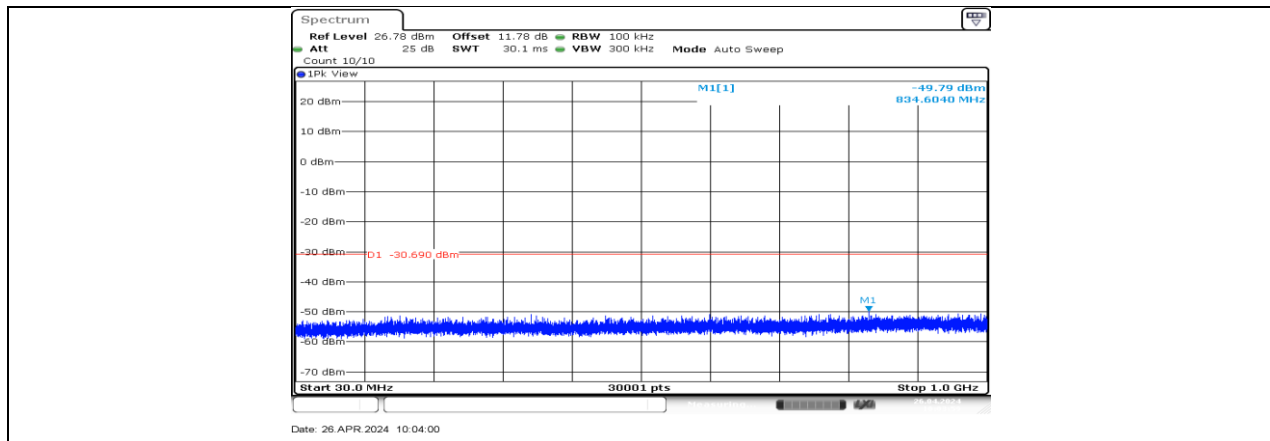

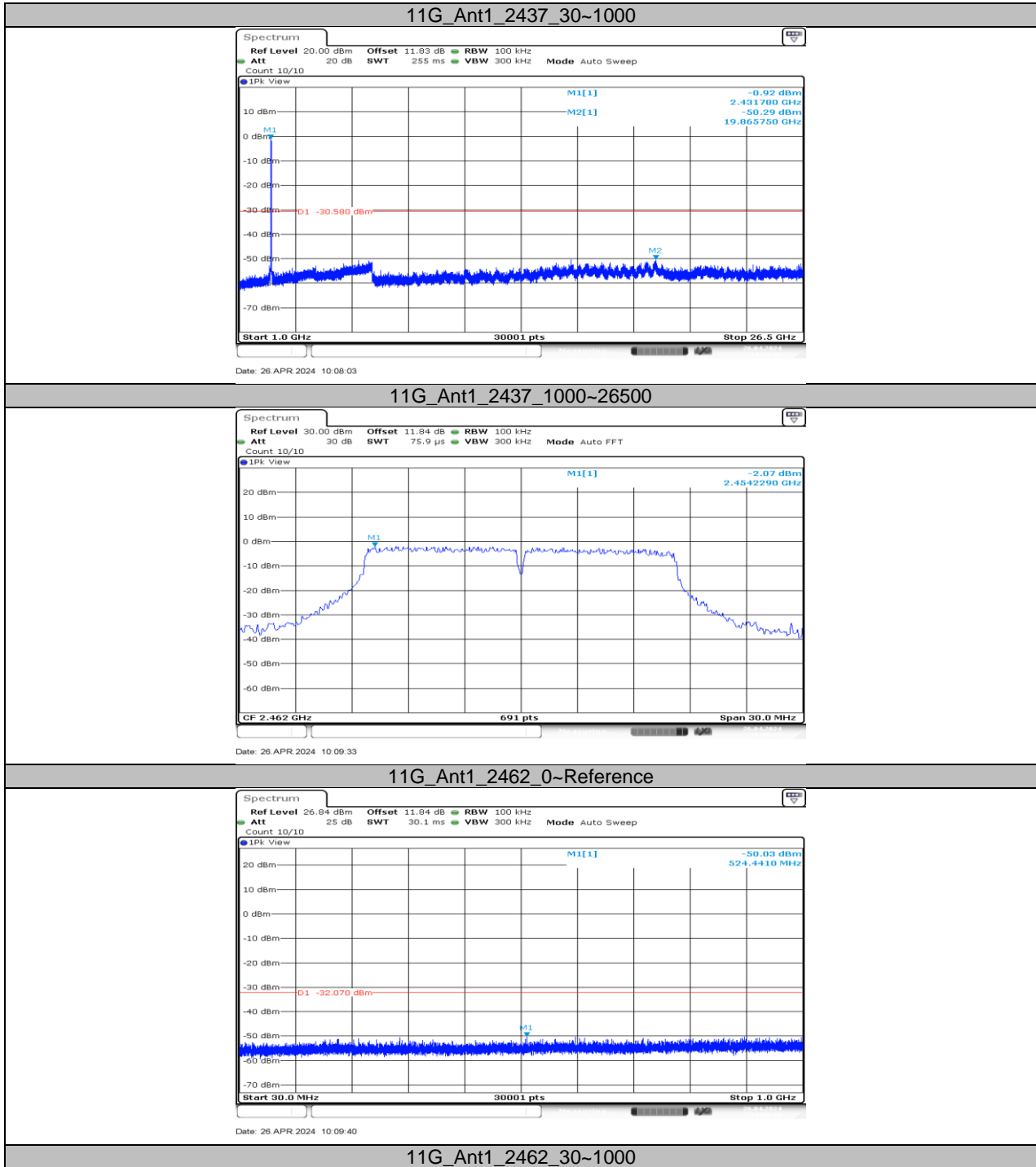

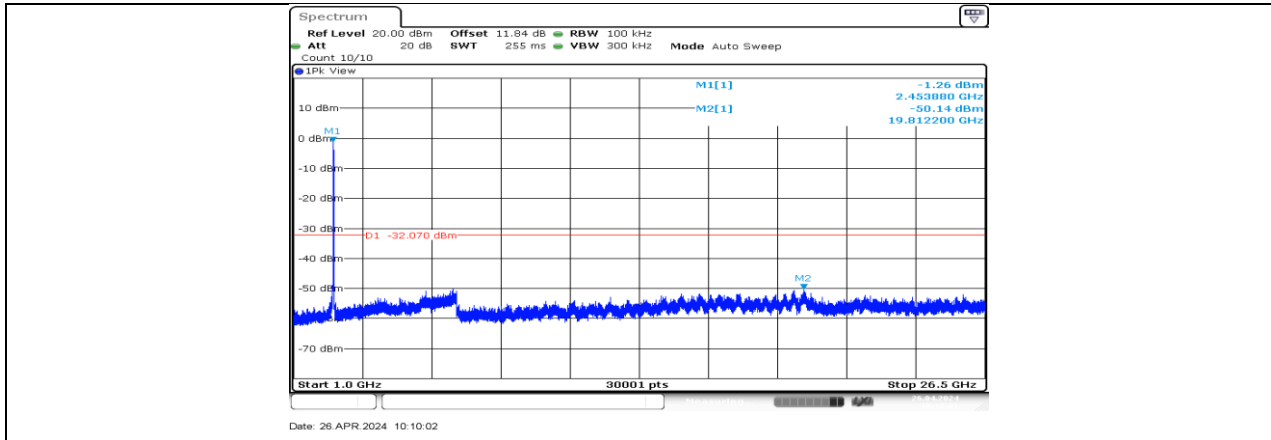

11G_Ant1_2462_1000~26500

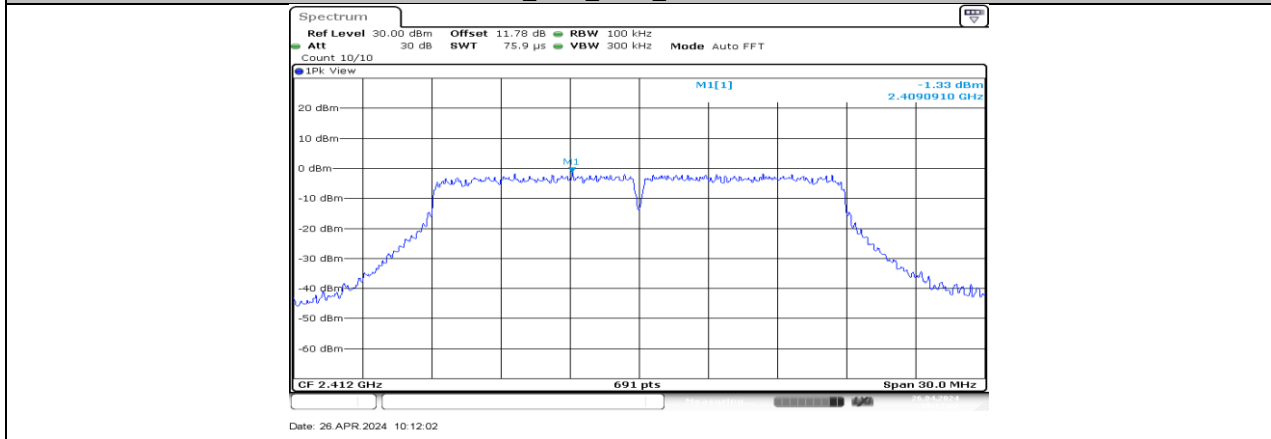

11N20SISO_Ant1_2412_0~Reference

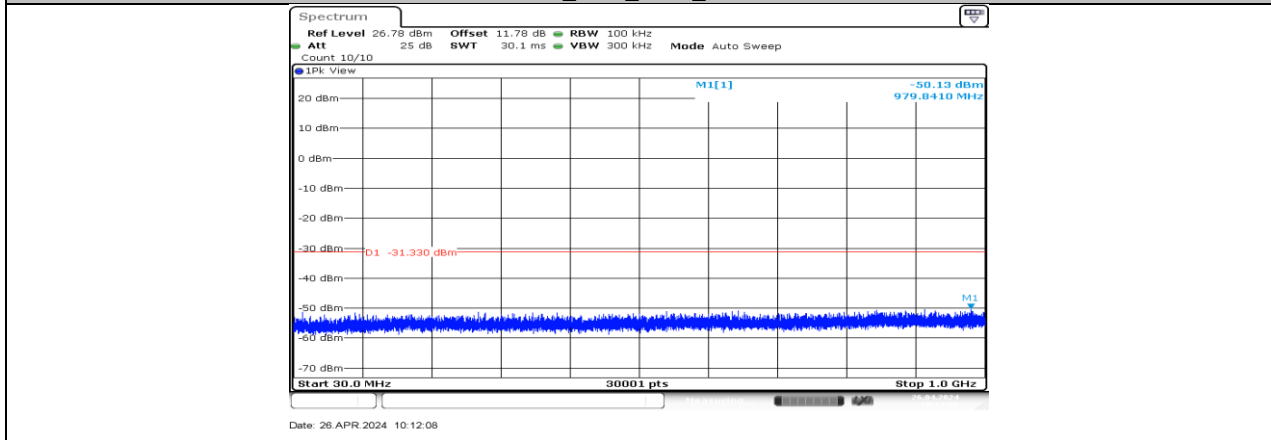

11N20SISO_Ant1_2412_30~1000

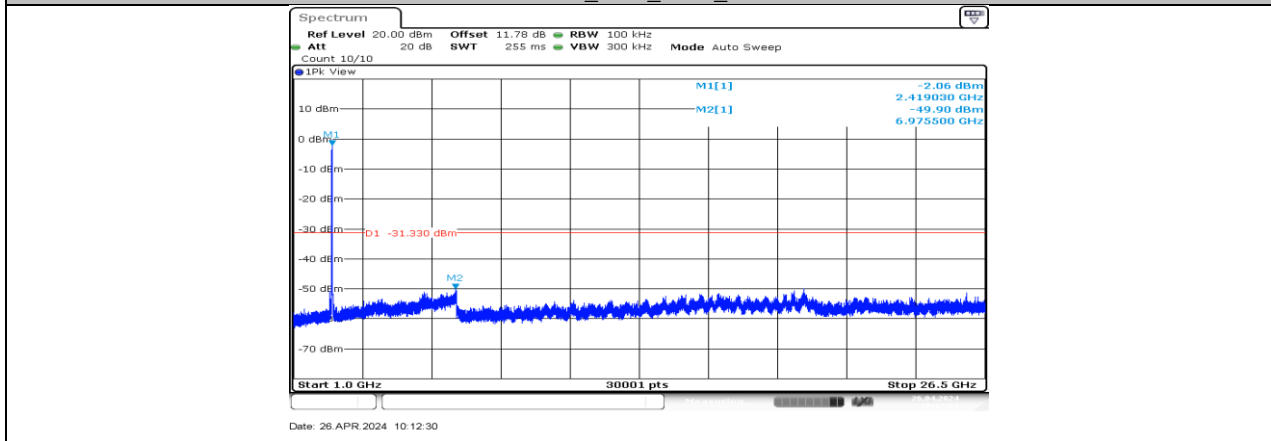

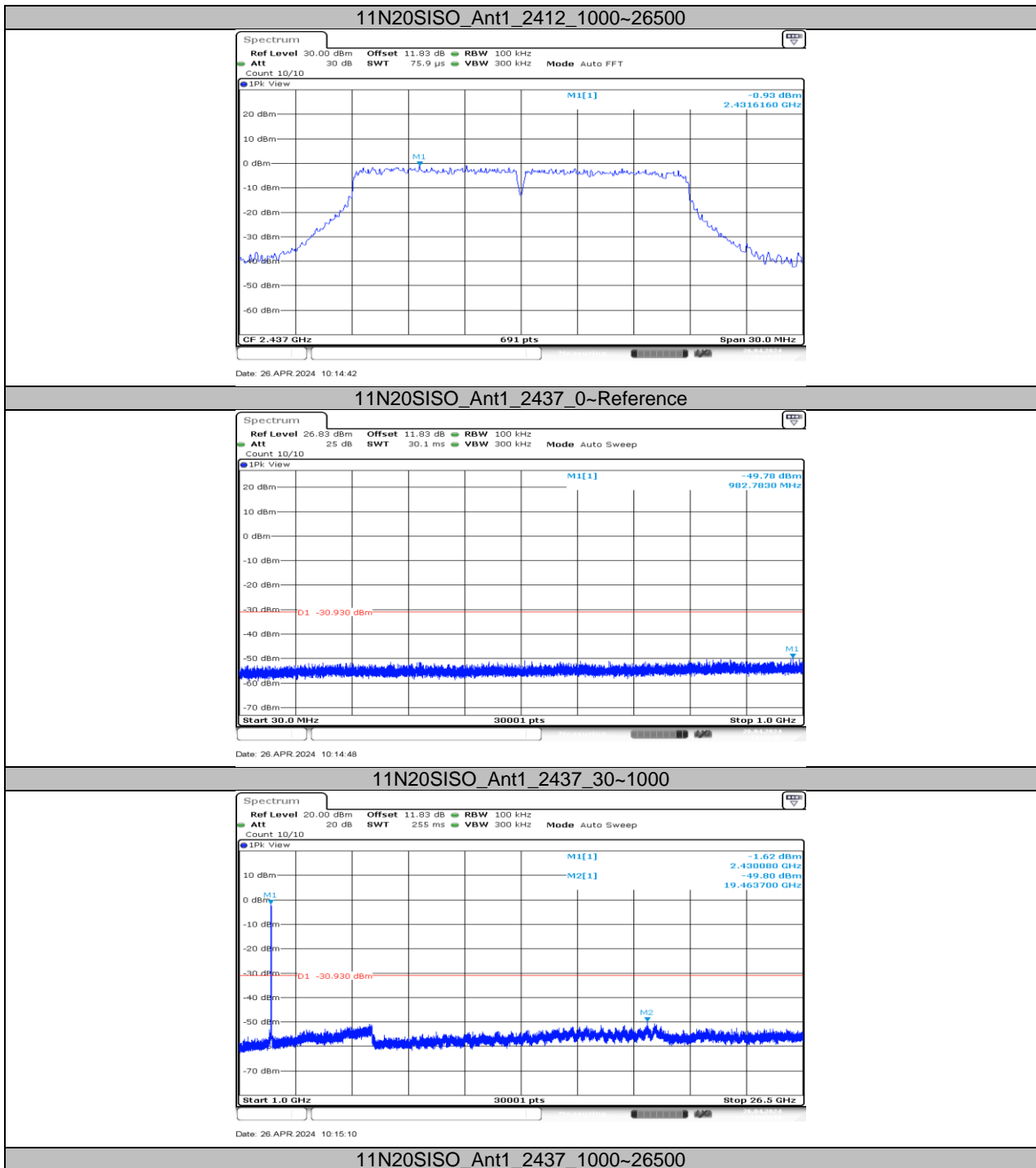

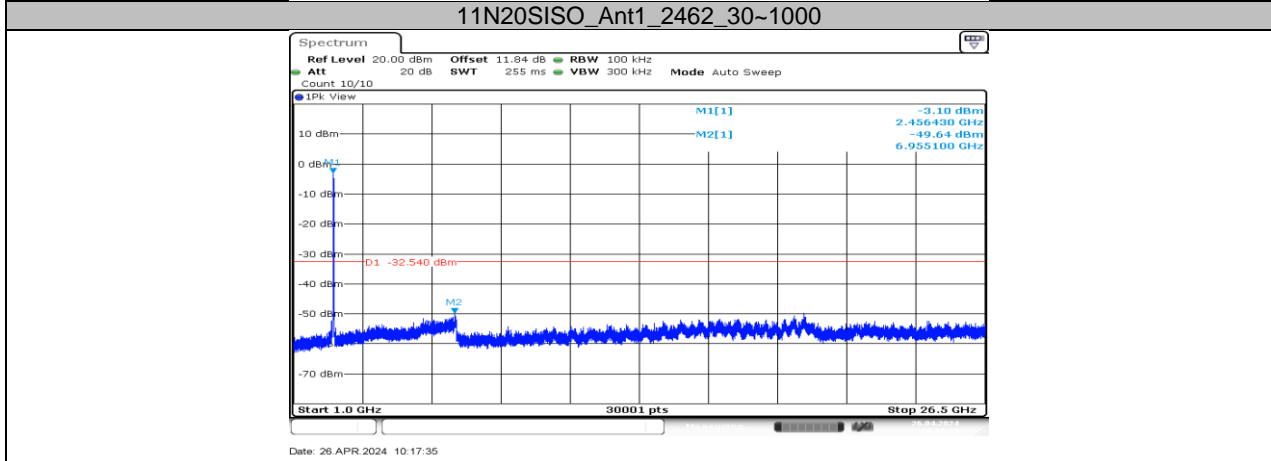
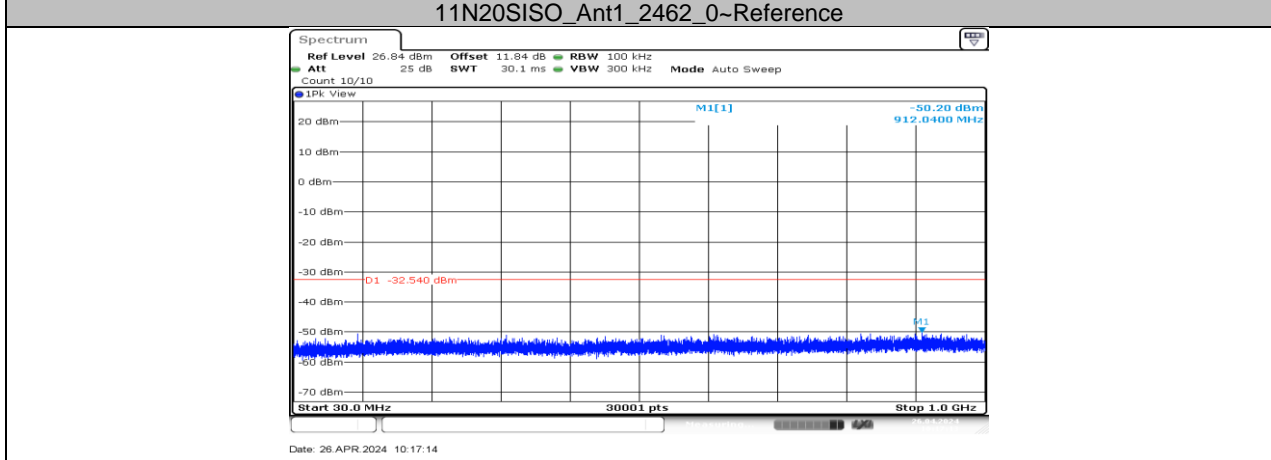
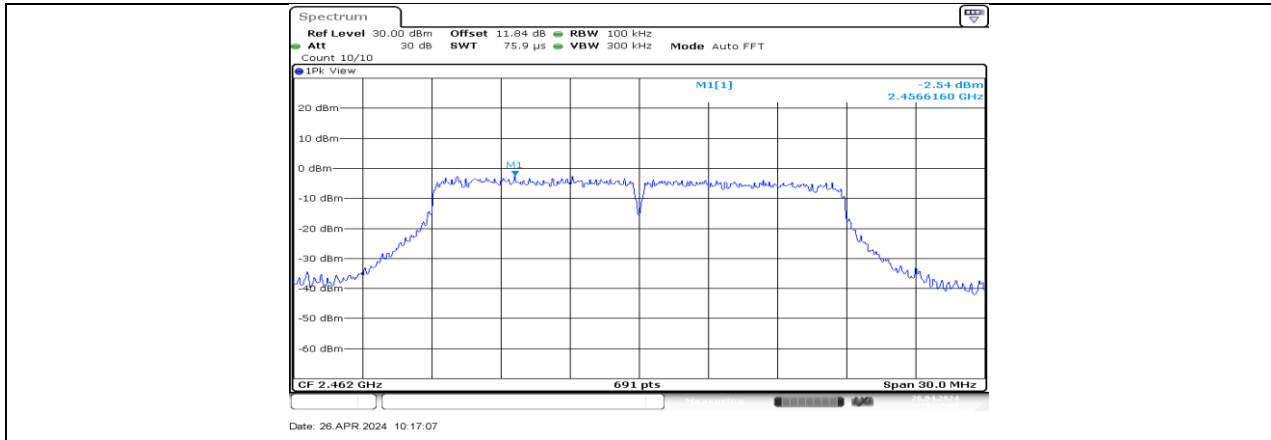

11.7. APPENDIX G: DUTY CYCLE

11.7.1. Test Result

| Test Mode | On Time (msec) | Period (msec) | Duty Cycle x (Linear) | Duty Cycle (%) | Duty Cycle Correction Factor (dB) | 1/T Minimum VBW (kHz) | Final setting For VBW (kHz) |
|-----------|----------------|---------------|-----------------------|----------------|-----------------------------------|-----------------------|-----------------------------|
| 11B | 100 | 100 | 1.0000 | 100.00 | 0.00 | N/A | 0.01 |
| 11G | 100 | 100 | 1.0000 | 100.00 | 0.00 | N/A | 0.01 |
| 11N20SISO | 100 | 100 | 1.0000 | 100.00 | 0.00 | N/A | 0.01 |

Note:

Duty Cycle Correction Factor=10log (1/x).

Where: x is Duty Cycle (Linear)

Where: T is On Time

If that calculated VBW is not available on the analyzer then the next higher value should be used.

If the EUT is configured to transmit with duty cycle $\geq 98\%$, set VBW \leq RBW/100 (i.e., 10 kHz) but not less than 10 Hz.

11.7.2. Test Graphs



END OF REPORT