

RiCloud Control System

User Manual

RiCLOUD

Wifi Box (20142445)

Thermostat (20142444)

Boiler RF Receiver (20142446)

RIELLO

1	GENERAL INFORMATION	50
1.1	General notices	50
1.2	What is the RiCLOUD for?	51
1.3	Modes of use	52
1.4	Glossary of technical terms	52
1.5	RiCLOUD control Class Declaration, according to the ErP Directive..	54
2	INSTALLATION	56
2.1	Contents of the package	56
2.2	Practical installation diagramspage	58
2.3	Technical Data.....	58
2.4	Three-phase installation	58
3	COMMISSIONING	65
3.1	User interface.....	65
3.2	Display	65
3.3	Setting the date and time.....	65
3.4	Setting the heating/cooling mode	66
3.5	Setting the operating mode	67
3.6	Setting the extra functions.....	69
3.7	Setting the heating/cooling time program in automatic operating mode	70
3.8	Setting the DHW time program	72
3.9	Setting the heating/cooling room setpoint temperature	73
3.10	Setting the DHW setpoint temperature	75
3.11	Displaying operating information	76
3.12	Technical menu – Advanced programming	79
3.13	Linking function	86
4	ALARMS AND OPERATING STATUSES.....	89
4.1	LED notification lights for the WiFi Box and boiler RF receiver ** ...	89
4.2	Boiler and RiCLOUD alarms	90

1 GENERAL INFORMATION

1.1 General notices

Please read this manual before installing and using the device.

 Risk of electric shock. This device should be installed by a qualified professional and in line with the standards in force for electrical installations. Always disconnect the power supply before installing.

 Note to the installer:

- Most of the product parameters are factory set. If the device is activated without a WiFi connection, the date and time should be set on the thermostat as a minimum (this information is wiped every time the batteries are removed and if not updated via the web). All other settings – such as linking the receiver and the transmitter (for the WiFi Box), usage mode and temperatures – are pre-configured.

 These instructions must be read together with the sections of the boiler manual regarding the room thermostat/boiler remote control. It is recommended that the device be installed by qualified technicians.

 **RiCLOUD** should be installed in the most accessible room for you as regards controlling the room temperature (usually the living room).

 As per the standards, **RiCLOUD** should be positioned 1.5 m from the floor to make sure that you can easily read the display.

 **RiCLOUD** is powered by 2 x AA batteries.

 **RiCLOUD** must be kept away from sources of heat or air currents as these may affect the accuracy of the readings from the incorporated room sensor.

 Do not open **RiCLOUD** for any reason, unless to replace the batteries; it does not require any maintenance to operate.

 Do not press on the liquid crystal display glass as this may damage the glass and cause problems with reading the display.

 To clean the display, use a dry cloth only. Any seepage would damage the liquid crystal display.



When the WiFi Box is connected in ON/OFF mode to the boiler or another device via cable, should all the thermostats be faulty or the batteries flat, the Box will show as OFF (no heating/cooling requests). The Wi-Fi Box relay can be forced on and off manually using the APP.



With the WiFi Box connected in OTBus mode to the boiler via cable, should all the thermostats be faulty or the batteries flat, the Box will remain in the last operating mode. From the APP, you can manually force the boiler in heating mode on or off when connected to the internet.



With **RiCLOUD** connected (ON/OFF) to the boiler or another device via cable, should all the thermostats be faulty or the batteries flat, the thermostat relay will remain in the last operating mode.



With the WiFi Box connected in ON/OFF or OTBus mode to the boiler via cable, should there be a power outage, the WiFi box remains in the last operating mode.

1.2 What is the RiCLOUD for?

The **RiCLOUD** allows you to check the temperature in your house and the operation of your boiler without you needing to access it. For reasons of space optimisation, your boiler may be located outside (for example, on a terrace or balcony or in an outdoor space); **RiCLOUD**, on the other hand, is usually installed in the largest room in the house, where it can be easily checked and adjusted. Where installed in systems with a boiler which is not equipped with the specific communication bus, **RiCLOUD** allows you to check the temperature of the room where it is installed and consequently send the heat requests to the house generator with no boiler remote control (domestic hot water temperature and boiler settings/alarms cannot be managed).

For both types of installation, the **RiCLOUD** system allows you to check the temperature in different zones in your house, where there are zone valves and each one of these is connected to a single additional **RiCLOUD** (multi-zone management).

If **RiCLOUD** is installed together with the WiFi Box and you have a WiFi internet connection in your home, **RiCLOUD** system allows you to carry out the same functions available via **RiCLOUD** itself remotely on a smartphone.

1.3 Modes of use

RiCLOUD means you can manage your domestic heating in a more sophisticated way; you can decide how and when the boiler will come on to heat your living spaces. In addition, it allows you to set the domestic hot water temperature, without having to access the boiler panel (where connected to the boiler via OTBus or a specific communication bus). The purpose of this manual is to explain each of these ways of using the device and the related functions.

1.4 Glossary of technical terms

Heating water: the water in the radiators that has been heated by the boiler.

Domestic hot water: the water heated by the boiler which is dispensed from the domestic taps.

Fault code: this code shows on the display to flag any boiler or **RiCLOUD** faults.

Original set-up: this is the control panel configuration after turning on the device for the first time or after a reset.

Display: this is the liquid crystal panel where each of the symbols corresponding to the various functions are shown.

Anti-freeze function: this function ensures that any drops in temperature do not cause the water inside the pipes to freeze and cause damage to the heating system. This function is activated when the room temperature drops below 5°C (**this value can be changed by the qualified technical service**).

NOTE

This function is active only if the boiler is in the correct operating condition (i.e. powered and not blocked) and no hydraulic system splitting into sections.

Restore factory settings: this restores the control panel to its original set-up, resetting any user programming excluding the system clock.

Summer: the heating system is not active in this mode (for example, during the summer).

The boiler can dispense domestic hot water. If correctly connected and configured (in cooling mode), **RiCLOUD** can be used to manage a cooling system in the summer, turning the relay on in ON/OFF mode, in the opposite way to the winter operating mode. The relay keeps the user request connected (e.g. a zone valve) until the room temperature falls below a certain level.

The cooling mode requires a specific system and generator for this purpose.

Winter: RiCLOUD dispenses domestic hot water and hot water for heating in this mode.

T1 anti-freeze temperature: this is the temperature used when the rooms are not lived in.

T2 economy temperature: this is the temperature used when the rooms are not lived in during the day, at night or when you are on holiday.

T3 comfort temperature: this is the temperature at which you obtain ideal room heating during the day.

Room temperature: this is the temperature in the room where RiCLOUD is installed (see "NOTE 1" page 54).

Room setpoint temperature: this is the desired room temperature.

External temperature: this is the temperature outside, read using an external probe connected to the boiler or read in another way (see "NOTE 2" page 54).

Heating curve: this is the relationship between the external temperature and the heating flow temperature. Where external temperature data are available (via an external probe or other method), the heating flow temperature is automatically adjusted as the external temperature varies in order to maintain a constant temperature in the room. The heating curve must be set by the installer on the basis of the geographical location and type of system.

Connection via OTBus communication bus: this is a communication mode between RiCLOUD and the boiler, where a series of information is exchanged between the two electronic systems. This **proprietary** connection can be used as opposed to the simple ON/OFF (open/closed contact) and is set by the boiler manufacturer specifically for RiCLOUD

Check the compatibility of your boiler with the OTBus connection first.

ON/OFF connection (boiler room thermostat): this is the simple communication method between the RiCLOUD and the boiler (or any other unit capable of receiving this command), where the relay in RiCLOUD (or on the WiFi Box/receiver) sends an on/off request via the room thermostat (TA) contact on the boiler. The ON/OFF connection is also used when a request is made to another system component such as a zone valve or similar.

RiCLOUD ON/OFF contact always maintains the same technical characteristics (**RiCLOUD** relay, WiFi Box relay, boiler RF receiver relay) wherever it is positioned and these must be respected when connecting the relay and the components it controls via cable. **NOTE:** Never exceed the maximum electrical loads (see page 21).

NOTE 1

The display range for the room temperature is between -7°C and $+50^{\circ}\text{C}$.

NOTE 2

The display range for the external temperature is between -40°C and $+60^{\circ}\text{C}$. Temperatures outside of these ranges are shown as three dashes " - - -".

1.5 RiCLOUD control Class Declaration, according to the ErP Directive

With reference to Delegated Regulation (EU) No. 811/2013, the data in the table can be used to complete the product data sheets and energy labelling of space heaters, combination heaters, packages of space heater, temperature control devices and solar devices.

Manufacturer/Brand	Model
RIELLO SpA / RiCLOUD	RiCLOUD

Possible **RiCLOUD** configurations, the relative configuration classes and the energy contribution to the system.

Boiler characteristics	RiCLOUD configuration	Class and contribution
Boiler with fixed delivery temperature (ON/OFF control)	RiCLOUD ON/OFF connection	I = 1%
Boiler with variable delivery temperature (controlled by communication bus)	Connection via communication bus to RiCLOUD . Delivery temperature to the boiler calculated on the basis of one room temperature only	V = 3%
Boiler with variable delivery temperature (controlled by communication bus)	Connection via communication bus to RiCLOUD . Delivery temperature to the boiler calculated on the basis of the room temperature and the external temperature (given by the external probe or via the web).	VI = 4%

Boiler characteristics	RiCLOUD configuration	Class and contribution
Boiler with variable delivery temperature (controlled by communication bus)	Connection via communication bus to RiCLOUD . Delivery temperature to the boiler calculated on the basis of at least 3 distinct room temperatures. At least 3 RiCLOUDs (sensors) connected to at least 3 zone valves (actuators) are required.	VIII = 5%

Definition of classes

Class I – On/off room thermostat: a room thermostat that controls the on/off operation of a heater. Performance parameters, including switching differential and room temperature control accuracy are determined by the thermostat's mechanical construction.

Class V – Modulating room thermostat, for use with modulating heaters: an electronic room thermostat that varies the flow temperature of the water leaving the heater dependent upon measured room temperature deviation from room thermostat set point. Control is achieved by modulating the output of the heater.



Class VI – Weather compensator and room sensor, for use with modulating heaters: a heater flow temperature control that varies the flow temperature of water leaving the heater dependent upon prevailing outside temperature and selected weather compensation curve. A room temperature sensor monitors room temperature and adjusts the compensation curve parallel displacement to improve room comfort. Control is achieved by modulating the output of the heater.

Class VIII – Multi-sensor room temperature control, for use with modulating heaters: an electronic control, equipped with 3 or more room sensors, that varies the flow temperature of the water leaving the heater dependent upon the aggregated measured room temperature deviation from room sensor set points. Control is achieved by modulating the output of the heater.

2 INSTALLATION

2.1 Contents of the package

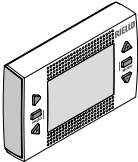
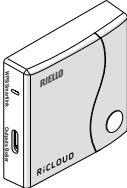
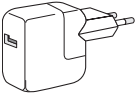
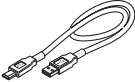
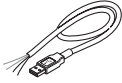
The WiFi **RiCLOUD** package contains the following components:

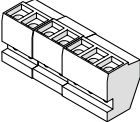

Qty	Component	Description
1		<p>RiCLOUD = boiler remote control with room programmable thermostat function (*) or room programmable thermostat (**).</p> <p>(*) where there is an active OTBus connection in one of the following configurations: between the WiFi Box and the boiler, between the RF receiver (optional) and the boiler, between RiCLOUD and the boiler,</p> <p>(**) where the TA connection between the WiFi Box and the boiler is active</p>
1		<p>WiFi Box = device for communicating with RiCLOUD programmable thermostat. It can operate with the Boiler RF receiver (optional) via radio frequency, with the boiler itself via cable (provided as standard) and with your home router via a WiFi connection. Magnetic back so that it can be attached to the boiler's metal casing.</p>
1		USB power adapter
1		USB cable A – USB Mini B = WiFi Box power cable
1		USB cable A = cable connecting the WiFi Box and the boiler
2		1.5V AA batteries
1		Installer/User Manual

Qty	Component	Description
2		Screws with plugs
1		OTBus connector (only for boilers without one) for an OTBus connection between the WiFi Box and the boiler or the Boiler RF receiver (optional) and the boiler or RiCLOUD and the boiler. It can also be used to connect the external probe (optional).

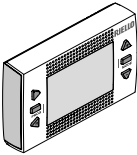

If installing additional **RiCLOUDs** or boiler RF receivers, you must follow the procedure to link them to the WiFi Box (see "3.13 Linking function" page 86).

RiCLOUD package contains the following components:

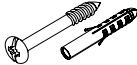
Qty	Component	Description
1		RiCLOUD = boiler remote control with room programmable thermostat function (*) or room programmable thermostat (**). (*) where there is an active OTBus connection in one of the following configurations: between the WiFi Box (optional) and the boiler, between the RF receiver (optional) and the boiler, and between RiCLOUD and the boiler, (**) where the TA connection between the WiFi Box (optional) and the boiler is active
2		1.5V AA batteries
1		Installer/User Manual
2		Screws with plugs



If installing additional **RiCLOUDs** or boiler RF receivers, you must follow the procedure to link them to the WiFi Box (see "3.13 Linking function" page 86).

2.2 Practical installation diagrams page

See practical installation diagrams on page 192.

2.3 Technical Data

See page 210.

2.4 Three-phase installation

Preparation

Before installing the device

Check that the thermostat is compatible with the boiler (see boiler installer manual).

The wireless **RiCLOUD** thermostat can be installed anywhere, however the most suitable place should be chosen taking into account the following:

- Avoid draughts (A).
- Do not install above sources of heat (B).
- Avoid direct sunlight (C).
- Position at the appropriate height (D).

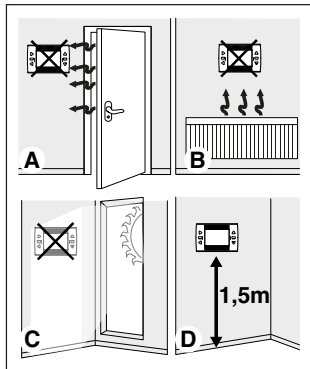

Wireless installation does not require any wiring, making the process very simple.

RiCLOUD thermostat can also be installed with wiring, to replace any existing thermostat, provided compatibility is checked in advance.

Before installing the boiler control unit (WiFi Box), disconnect the boiler from the power supply.

Installation

The following tools are required:

- Phillips screwdriver
- Small slotted screwdriver
- Pliers and wire strippers

Installing RiCLOUD

Remove **RiCLOUD** from its base;

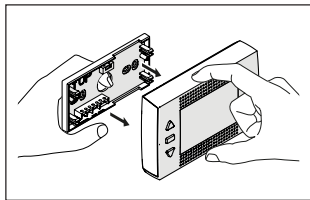

Fix **RiCLOUD** base to the wall or electrical box using the screws provided, use the optics level in the plastic wrapping to install **RiCLOUD** horizontally.

Using screws other than those PROVIDED may compromise the correct closure of the plastic. Make sure that the screw head is correctly inserted in the hole.

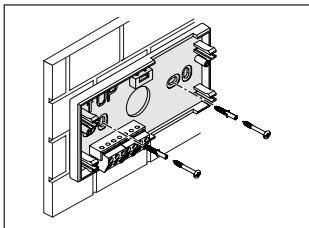

RiCLOUD can be installed in one of the following ways:

Wireless

No wiring is required.

Please check the maximum open-field distances shown in **RiCLOUD** thermostat technical data.

Loss of radio frequency communication is flagged with alarm E82. Distances which exceed the maximum may occasionally generate an E82 alarm, causing incorrect system operation.

Wired in ON/OFF mode (room thermostat contact on **RiCLOUD** base)

When replacing old thermostats or as a new wired ON/OFF installation. **RiCLOUD** can be connected to a boiler, zone valve or other device. The electrical load on **RiCLOUD** room thermostat contact must not exceed the specifications for the relay itself (see page 211). Should the electrical load not be compatible with the technical characteristics indicated in **RiCLOUD** thermostat technical data, it is recommended that you use an additional separation relay.

Connect the cables from the boiler room thermostat terminal or the power supply for any zone valves to **RiCLOUD** room thermostat terminal.

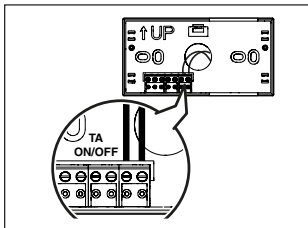

Wired in OTBus mode (OTBus contact on **RiCLOUD** base)

Direct connection via two wires to the boiler equipped with the same communication protocol.

We recommend checking the maximum cable length between the WiFi Box and the boiler OTBus terminal or **RiCLOUD** and the boiler OTBus terminal (see page 211). For the electrical connection to the boiler, please see the boiler manual.



A wired connection via OTBus between the **RiCLOUD** and the boiler is recommended in the absence of a WiFi Box. With the above connection and a WiFi Box, only one zone can be controlled and operation via the APP is not guaranteed.

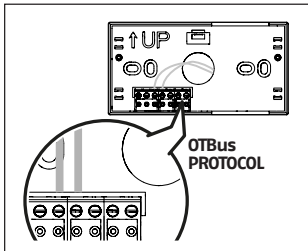

Insert the 2 x AA batteries provided, with correct polarity.

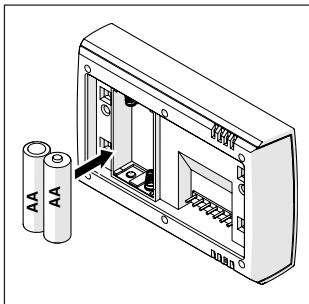

Fit the **RiCLOUD** onto the base;

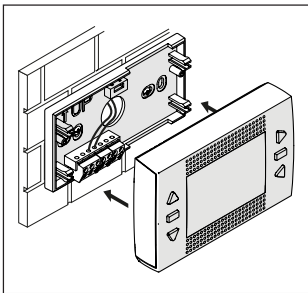

Installing the WiFi Box

Description of the WiFi Box

The WiFi Box communicates with **RiCLOUD** thermostat or with the boiler RF receiver only via radio frequency (wireless).

OUTPUTS

The WiFi Box contains a relay (see page 21) which replicates **RiCLOUD** thermostat relays linked to it. It is ON if at least 1 of **RiCLOUD** relays is ON, and OFF if all of **RiCLOUD** relays are OFF.

The WiFi Box can be wired to the boiler OTBus connection. This transforms the WiFi Box into a wireless receiver of an OTBus command. All of the information available in **RiCLOUD** via the OTBus connection is repeated to the receiver which wires it to the boiler; it is therefore an example of complex radio frequency communication.

The relay and OTBus outputs are identified on the WiFi Box by the term **OUTPUTS** and are available via a USB plug.

The position and distinction between the 2 outputs on the USB plug are given below.

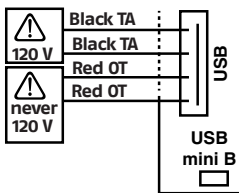

USB Outputs/Boiler:
Dry contact TA
 ON/OFF relay
 max 2 A at 30 VDC
 max 0.5 A at 120 VAC
OTBus protocol contact
Never 120 V

Power supply:
 USB mini B 5V – 1A
 WiFi: IEEE 802.11 b/g/n – 2.4 GHz
 Radio frequency: 915 MHz
 Power consumption: 0.5 W

Two USB cables are also supplied, one to provide power via the USB power adapter and the other to connect the WiFi Box to the boiler.

The cable to connect it to the electrical power supply is a USB mini.

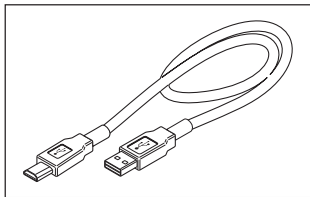

The USB cable to connect the device to the boiler has an end with 4 terminals.

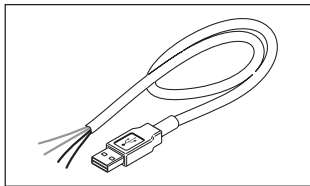

The black terminals are for the ON/OFF connection and are to be connected to the "boiler room thermostat" output.

The red terminals are for the connection via OTBus and are to be connected to the "OTBus" output on the boiler.

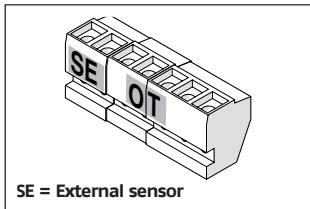

SE = External sensor

If there is a RF boiler receiver installed in the system, these do nothing other than repeat everything that happens in the WiFi Box on a RF receiver with the same outputs (ON/OFF and OTBus) which use the same wiring colours: Red = OTBus, Black = ON/OFF

WiFi Box connection via OTBus (only for boilers equipped with a compatible OTBus protocol)

Connect the red wires of the USB cable to the boiler OTBus terminal (please consult the boiler installer manual). Should the boiler not be equipped with an OTBus terminal, you can use an OTBus connector provided in the WiFi **RiCLOUD** package (only for boilers without one).



Only one of **RiCLOUD** system components (**RiCLOUD**, WiFi Box or boiler RF receiver) must be connected to the boiler via cable via OTBus.



For Family models for interiors (exterior and recessed versions are not compatible with this operating mode), the NEUTRAL ITRF11 INTERFACE BOARD KIT PART NO.20047522 must be bought and the communication board installed, following the instructions included in the kit.

ON/OFF WiFi Box connection

Connect the black wires of the USB cable to the boiler room thermostat terminal (it is recommended that you consult the boiler installer manual).



In the case of **RiCLOUD** thermostats wired in ON/OFF mode, or zone valve microswitches, it is recommended that you connect these to the boiler room thermostat terminal and wire the WiFi Box to the boiler via OTBus only (only for boilers equipped with a compatible OTBus protocol).

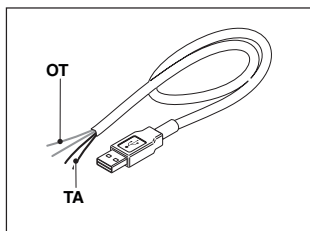
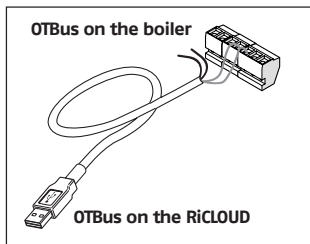

Black cables = TA (ON/OFF)

Red cables = OTBus communication protocol

Attach the WiFi Box to the boiler casing using the magnet on the back;

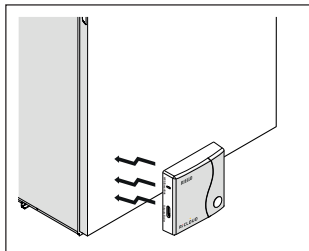

Connect the USB connector on the previously connected cable to the WiFi Box **OUTPUTS/BOILER** output;

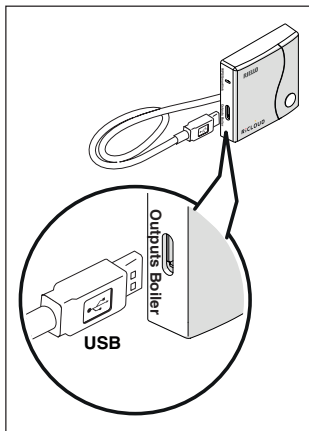

Power the WiFi Box via the relevant cable and power adapter provided.

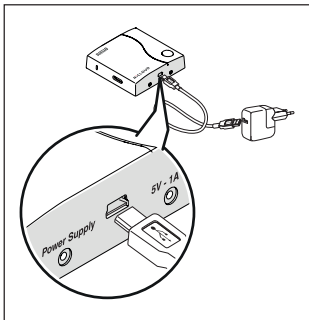

Resetting the OTBus connection auto-configuration function

RiCLOUD is configured to function in ON/OFF mode.

Should it be connected to an OTBus communication bus (wired or wireless/radio frequency), **RiCLOUD** auto-configures to the "Boiler remote control" operating mode.

To restore the thermostat to its original operating mode (ON/OFF), remove and then reinsert the batteries.



The alarm E82 may be triggered by a change of operating mode from OTBus to ON/OFF or vice versa.

Installing and configuring the smartphone APP

Download the APP on your smartphone or tablet;



Create a user account;

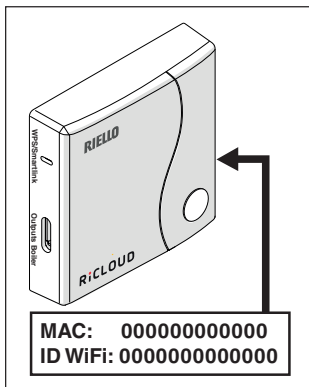

Match the WiFi ID of the WiFi Box to the user account.

If you need to link other thermostats and/or boiler RF receivers to the WiFi Box via radio frequency, press the clear button on the WiFi Box for 5 seconds until the LEDs flash at the same time and set the device to be linked to the same operating mode (see "3.13 Linking function" page 86). After making these links, the system automatically resumes normal operation.

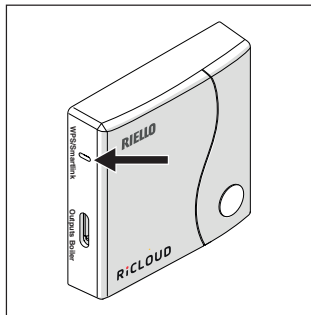

Link you home modem password to the WiFi Box via one of the following methods.

! Smartphones or tablets must be connected to the WiFi network that will be matched to the WiFi Box.

Smart Link

- Press the Smart Link button on the WiFi Box once with an appropriate implement.
- The green and red LEDs start flashing frequently.
- Select the "Configure WiFi" field from the drop-down menu in the APP, insert your home modem password and press the "Connect" button.

The process is complete if the APP displays the message "Connection complete".

! Once online, the system requires up to 4 minutes to auto-configure.

WPS (only for modems with this function)

- Set your home modem to WPS mode.
- Press the WPS button on the WiFi Box using an appropriate implement and hold for 5 seconds until the red and green LEDs flash frequently.

The link has been made if the red LED on the WiFi Box flashes frequently after a few seconds.

! Once online, the system requires up to 4 minutes to auto-configure.

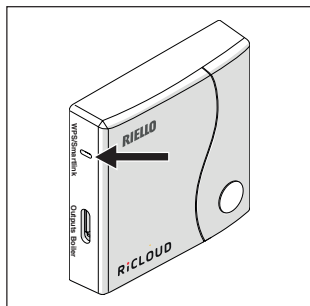

Restart the WiFi router after the operation is completed.

NOTE

For further information, please see **RiCLOUD APP** manual.

3 COMMISSIONING

3.1 User interface

See page 188.

3.2 Display

See page 191.

3.3 Setting the date and time

From the HOME screen, press the SET/PROGRAM button twice.

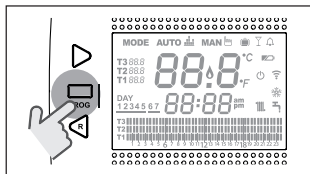

Select the desired field (hours, minutes or day) using the FORWARD > or BACK < button (time, minutes, day, month and year).

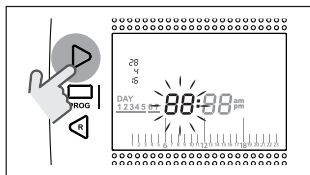

When day is selected, the corresponding number flashes and the message DAY is displayed.

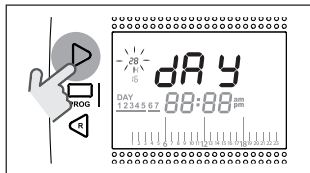

When month is selected, the corresponding number flashes and the message Non is displayed.

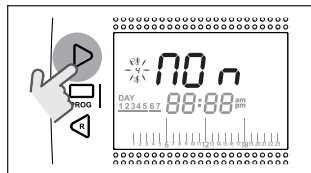

When year is selected, the corresponding number flashes and the message YEA is displayed.

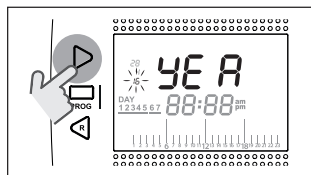

Change the value using the UP ^ or DOWN v buttons.

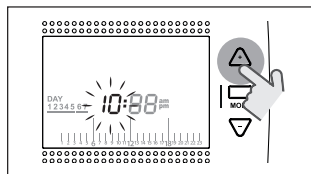

Press the SET/PROGRAM button to save and return to the programming menu, press ESC/MODE to save and exit the programming menu, or wait 30 seconds to automatically save the value and return to the home screen.

3.4 Setting the heating/cooling mode

RiCLOUD is default set to heating mode.

In heating mode, RiCLOUD activates a request for heat when the room temperature is **below** the set temperature.

In cooling mode, RiCLOUD activates an ON request (where there is a cooling system) when the room temperature is **above** the set temperature.

From the HOME screen, press the SET/PROGRAM button to open the user menu.

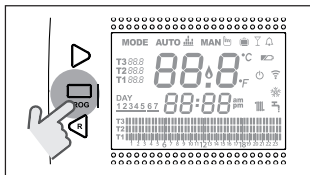

Press the FORWARD > or BACK < button to select the field HEATING/COOLING.

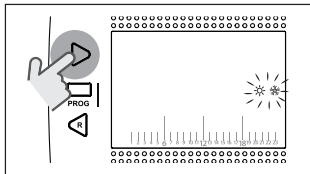

Press the SET/PROG button to set.

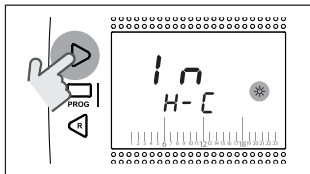

Press the UP ^ or DOWN v button to select the desired mode.

IN=WINTER

Heating mode.

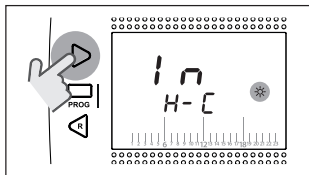

SU=SUMMER

Cooling mode.

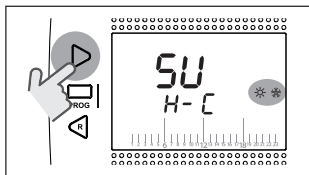

Press the SET/PROG button to save and return to the programming menu, press ESC/MODE to save and exit the programming menu, or wait 30 seconds to automatically save the value and return to the HOME screen



If at least one RiCLOUD thermostat is in cooling mode, the heating request via OTBus is not considered.

3.5 Setting the operating mode

From the HOME screen, press ESC/ MODE repeatedly

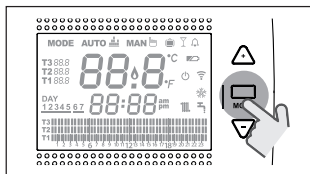

to select one of the following modes:

3.5.1 OFF mode

In OFF mode, **RiCLOUD** guarantees the minimum room temperature set at parameter 01 from the PL technical menu only.

NOTE

Only if the boiler is in the correct operating condition (i.e. powered and not blocked).

In case of an OTBus connection between the WiFi Box and the boiler (including other types of connection via OTBus), the boiler remains OFF if all **RiCLOUD** thermostats in the system are OFF. When the boiler is OFF it does not provide any heating or **domestic hot water**.

3.5.2 SUMMER/DHW mode

RiCLOUD in SUMMER/DOMESTIC HOT WATER mode. In this mode, the boiler provides domestic hot water where requested (instant boiler).

If the parameter 24 CLOC is set to ON; **RiCLOUD** follows the time periods set in the user-programming menu for DHW, pre-heating the water in the storage tank (only for boilers with integrated tank).

The minimum room temperature set at parameter 01 from the PL technical menu is, however, guaranteed.

In case of an OTBus connection between the WiFi Box and the boiler (including other types of connection via OTBus), the boiler remains in SUMMER mode if at least one of the thermostats is in summer mode and the others are OFF.

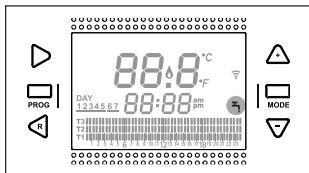

3.5.3 WINTER/AUTOMATIC mode

AUTO 

In Winter/AUTOMATIC mode, **RiCLOUD** follows the time program set in the user-programming menu for heating. In case of an OTBus connection between the WiFi Box and the boiler (including other types of connection via OTBus), the boiler remains in Winter/AUTOMATIC mode if at least one of the thermostats is in heating mode.

 For installations with multiple **RiCLOUD** thermostats connected via OTBus, if one of these devices is in **cooling** mode, the heating request to the boiler is not considered.

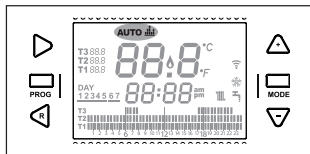

3.5.4 WINTER/MANUAL mode MAN

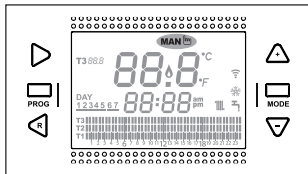

RiCLOUD in Winter/MANUAL mode, **RiCLOUD** programmable thermostat takes the T3 room setpoint temperature (comfort), ignoring the heating time program. In case of an OTBus connection between the WiFi Box and the boiler (including other types of connection via OTBus), the boiler remains in Winter/MANUAL mode if at least one of the thermostats is in heating mode.

 For installations with multiple **RiCLOUD** thermostats connected via OTBus, if one of these devices is in cooling mode, the heating request to the boiler is not considered.





3.5.5 WINTER/HOLIDAY mode

In HOLIDAY mode, **RiCLOUD** takes the T2 room setpoint temperature (economy), ignoring the heating time program, for the days set with the FORWARD > or BACK < buttons.

RiCLOUD returns to AUTO mode AUTO  once the days set in HOLIDAY mode  have lapsed.

In case of an OTBus connection between the WiFi Box and the boiler (including other types of connection via OTBus), the boiler remains in Winter/HOLIDAY mode if at least one of the thermostats is in heating mode.

 Every day, including programming day, ends at 24h00.

 For installations with multiple **RiCLOUD** thermostats connected via OTBus, if one of these devices is in **cooling** mode, the heating request to the boiler is not considered.

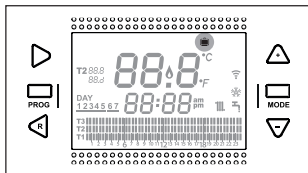

3.5.6 WINTER/PARTY mode

In PARTY mode, **RiCLOUD** takes the T3 room setpoint temperature (comfort), ignoring the heating time program, until midnight of the current day, and then automatically switches back to AUTO mode .

In case of an OTBus connection between the WiFi Box and the boiler (including other types of connection via OTBus), the boiler remains in Winter/PARTY mode if at least one of the thermostats is in heating mode.



For installations with multiple **RiCLOUD** thermostats connected via OTBus, if one of these devices is in **cooling** mode, the heating request to the boiler is not considered.

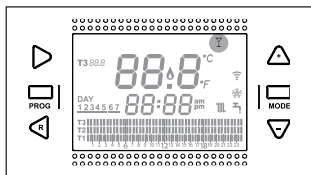

3.6 Setting the extra functions

3.6.1 ADVANCE function for AUTOMATIC operating mode

The ADVANCE function allows you to bring forward the next heating/cooling time period and the relative room setpoint temperature desired, or to disable the heating time period if it is already running.

To activate/deactivate the ADVANCE function, from the HOME screen press the FORWARD button  (if active, the MAN icon is displayed).

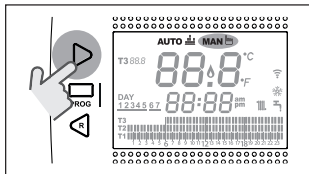

3.6.2 ONE HOUR BOOSTER function for AUTOMATIC operating mode

The ONE HOUR BOOSTER function allows you to activate the heating/cooling time period and the relative T3 room temperature (comfort) for 60 minutes, if it is not already in operation.



If the heating time period relative to the T3 room setpoint temperature (comfort) is already running, by activating the function the time period is extended by one hour, but not beyond midnight of the current day.

To activate/deactivate the ONE HOUR BOOSTER function, from the HOME screen press the BACK button  (if active, the MAN icon is displayed).

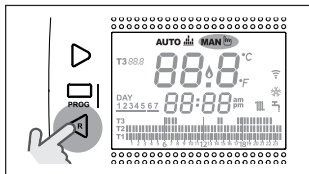

3.6.3 SEMI-AUTOMATIC FILLING function

The SEMI-AUTOMATIC FILLING function allows the correct system pressure to be restored and is only available for boilers equipped with the relevant

function (if OTBus connection available between the WiFi Box and the boiler or the RF receiver and the boiler or **RiCLOUD** and the boiler, if provided for by the OTBus protocol). If the rIE alarm is quickly flashing (0,5 sec) on the HOME screen in the room temperature field,

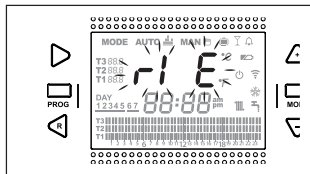

press the ESC/MODE button and hold for 5 seconds to start semi-automatic filling (the message rIE will stop flashing and remain on). When releasing the button ESC/MODE the rIE message starts flashing slowly (2 secs) until the end of the function.

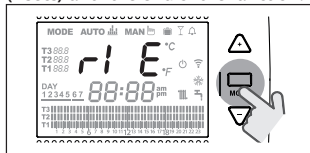

Once the system pressure has been restored, **RiCLOUD** automatically returns to the normal HOME screen display.

! If the SEMI-AUTOMATIC FILLING function is not carried out within 90 seconds, the rIE alarm flashes quickly (1sec.) and is displayed on the HOME page again.

3.6.4 KEY-LOCK function

To enable/disable the KEY-LOCK function, press the FORWARD > and UP ^ buttons together for 5 seconds from the HOME page (if enabled, LOC will be displayed for 5 seconds, if disabled, UnL will be displayed for 5 seconds).

3.7 Setting the heating/cooling time program in automatic operating mode

From the HOME screen, press the SET/PROGRAM button to open the user menu.

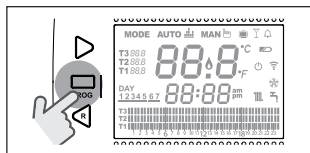

Press the FORWARD > or BACK < button to select the field HEATING/Cooling TIME PROGRAM.

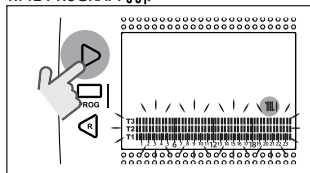

Press the SET/PROG button to set.

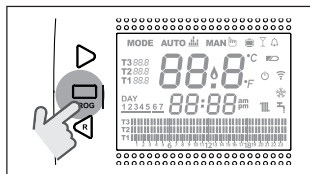

Press the FORWARD > or BACK < button to select the day or period of the week to be changed.

Days	Display
Monday Friday	
Saturday Sunday	
Monday Sunday	
Monday	
Tuesday	
Wednesday	
Thursday	

Friday	
Saturday	
Sunday	

Press the SET/PROGRAM button to confirm the day or period of the week to be changed.

Press the FORWARD > or BACK < button to select the time segment to be changed.

Press the ESC/MODE button to select the desired room setpoint temperature (T1, T2, T3).

Press the UP button ^ to copy the previous setting to the following time segment (the DOWN v button can be used to go back or copy the setting to the previous time segment).

Press the SET/PROG button to save and return to the programming menu, press ESC/MODE to save and exit the programming menu, or wait 30 seconds to automatically save the value and return to the HOME screen.

3.8 Setting the DHW time program

This function is available only if the parameter 24 CLOC is set to ON.

The time periods are default set to ON (domestic hot water function active).

From the HOME screen, press the SET/PROGRAM button to open the user menu.

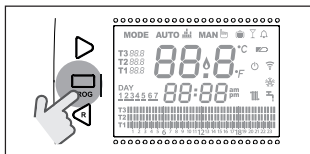

Press the FORWARD > or BACK < button to select the field DHW TIME PROGRAM

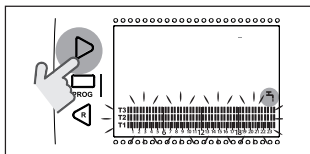

Press the SET/PROG button to set. Press the FORWARD > or BACK < button to select the day or period of the week to be changed.

Days	Display
Monday Friday	 DAY 1234567 T3 T2 T1
Saturday Sunday	 DAY 1234567 T3 T2 T1

Monday Sunday	 DAY 1234567 T3 T2 T1
Monday	 DAY 1234567 T3 T2 T1
Tuesday	 DAY 1234567 T3 T2 T1
Wednesday	 DAY 1234567 T3 T2 T1
Thursday	 DAY 1234567 T3 T2 T1
Friday	 DAY 1234567 T3 T2 T1
Saturday	 DAY 1234567 T3 T2 T1
Sunday	 DAY 1234567 T3 T2 T1

Press the SET/PROGRAM button to confirm the day or period of the week to be changed.

Press the FORWARD > or BACK < button to select the time segment to be changed.

Press the ESC/MODE button to activate or deactivate the domestic hot water function.

Press the UP button ^ to copy the previous setting to the following time segment (the DOWN v button can be used to go back or copy the setting to the previous time segment).

Press the SET/PROG button to save and return to the programming menu, press ESC/MODE to save and exit the programming menu, or wait 30 seconds to automatically save the value and return to the HOME screen.

3.9 Setting the heating/cooling room setpoint temperature

To change the T1/T2/T3 room setpoint temperature, press the SET/PROGRAM button from the HOME screen to enter the user menu.

Press the FORWARD > or BACK < button to select the field HEATING/COOLING TEMPERATURE.

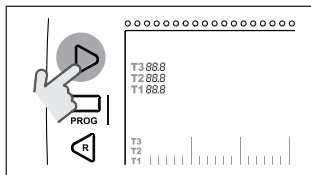

Press the SET/PROG button to set.

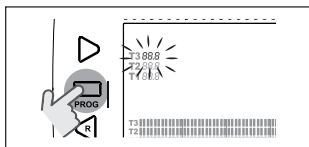

Press the FORWARD > or BACK < button to select the temperature to be changed.

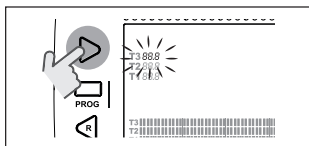
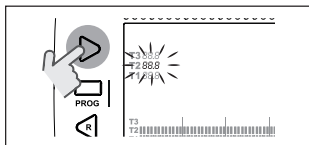
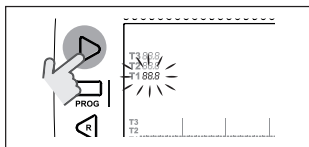

Press the UP ^ or DOWN v button to modify the selected room setpoint temperature.

! The T3 temperature (comfort) cannot be higher than 35°C or less than or equal to T2 (economy).

! The T2 temperature (economy) cannot be higher than or equal

to T3 (comfort) or less than or equal to T1 (anti-freeze).

! The T1 temperature (anti-freeze) cannot be higher than or equal to T2 (economy) or less than 1°C.

Press the SET/PROG button to save and return to the programming menu, press ESC/MODE to save and exit the programming menu, or wait 30 seconds to automatically save the value and return to the HOME screen.

The room setpoint temperatures can also be modified instantly if **RiCLOUD** is in the operating mode corresponding to the room setpoint temperature to be modified.

3.9.1 Setting the temperature in MANUAL mode

From the HOME screen, press the UP \wedge or DOWN \vee button to set the desired T3 (comfort) room setpoint temperature.

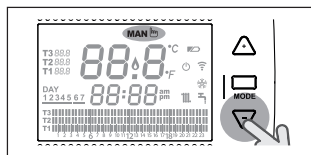

! The room setpoint temperature set cannot be less than or equal to the T2 temperature (economy).

Press the SET/PROG button to save and return to the HOME screen, press ESC/MODE to save and return to the HOME screen, or wait 5 seconds to automatically save the value and return to the HOME screen.

3.9.2 Setting the temperature in AUTOMATIC mode

From the HOME screen, press the UP \wedge or DOWN \vee button to set the desired room setpoint temperature for the current time period.

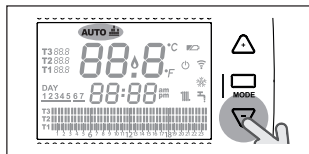

Press the SET/PROG button to save and return to the HOME screen, press ESC/MODE to save and return to the HOME screen, or wait 5 seconds to automatically save the value and return to the HOME screen.

3.9.3 Setting the temperature in HOLIDAY mode

From the HOME screen, press the UP \wedge or DOWN \vee button to set the desired T2 (economy) room setpoint temperature.

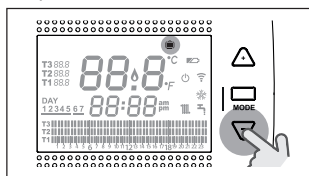

! The room setpoint temperature set cannot be higher than or equal to T3 (comfort) or less than or equal to T1 (anti-freeze).

Press the SET/PROG button to save and return to the HOME screen, press ESC/MODE to save and return to the HOME screen, or wait 5 seconds to automatically save the value and return to the HOME screen.

3.9.4 Setting the temperature in PARTY mode

Press the UP \wedge or DOWN \vee button on the HOME screen to set the desired room setpoint temperature.

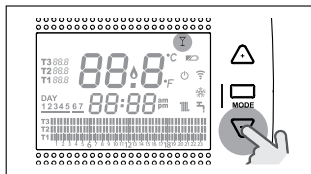

The room temperature set cannot be less than or equal to the desired T3 (comfort) room setpoint temperature.

! The room setpoint temperature set cannot be less than or equal to the T2 temperature (economy).

Press the SET/PROG button to save and return to the HOME screen, press ESC/MODE to save and return to the HOME screen, or wait 5 seconds to automatically save the value and return to the HOME screen.

3.10 Setting the DHW setpoint temperature

From the HOME screen, press the SET/PROGRAM button to open the user menu.

Press the FORWARD \triangleright or BACK \triangleleft button to select the field DOMESTIC HOT WATER TEMPERATURE.

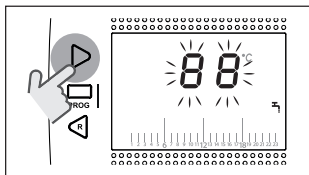

Press the SET/PROG button to set.

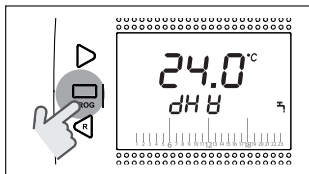

Press the UP \wedge or DOWN \vee button to modify the domestic hot water setpoint temperature.

Press the SET/PROG button to save and return to the programming menu, press ESC/MODE to save and exit the programming menu, or wait 30 seconds to automatically save the value and return to the HOME screen.

3.11 Displaying operating information

This function (available with OTBus connection between the WiFi Box and the boiler or the RF receiver and the boiler or **RiCLOUD** and the boiler, if provided for by the OTBus protocol) allows you to display the boiler probe values and some boiler operating statuses.

From the HOME screen, press the SET/PROGRAM button to open the user menu.

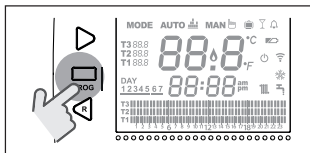

Press the FORWARD > or BACK < button to select the field InFO.

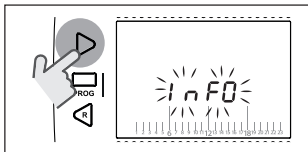

Press the SET/PROGRAM button to display this field.

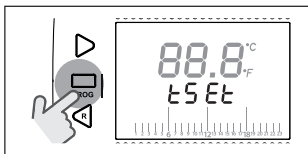



Press the UP ^ or DOWN v button to select the desired parameter and wait until it is displayed.

Parameter	Description
<p>tSet</p>	<p>Heating delivery setpoint calculated by RiCLOUD (shown only if RiCLOUD has received a heating request). The value calculated by RiCLOUD may differ from the real heating delivery setpoint delivered by the boiler, if the minimum boiler heating setpoint parameter is higher than this value.</p>
<p>tFLO</p>	<p>Temperature read by the boiler heating delivery probe (available with OTBus connection between the WiFi Box and the boiler or the RF receiver and the boiler or RiCLOUD and the boiler, if provided for by the OTBus protocol).</p>

EXAMPLE:

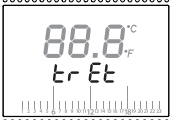
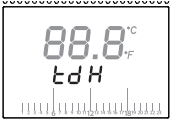
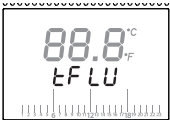
The heating delivery setpoint calculated by **RiCLOUD** is 30°C, the minimum boiler heating setpoint parameter is 40°C, the real heating delivery setpoint delivered by the boiler is 40°C.

Parameter	Description
<p data-bbox="263 108 306 129">trEt</p> 	<p data-bbox="474 108 965 234">Temperature read by the boiler heating return probe (available with OTBus connection between the WiFi Box and the boiler or the RF receiver and the boiler or RiCLOUD and the boiler, if provided for by the OTBus protocol).</p>
<p data-bbox="263 327 306 348">tdH</p> 	<p data-bbox="474 327 965 452">Temperature read by the boiler DHW probe (available with OTBus connection between the WiFi Box and the boiler or the RF receiver and the boiler or RiCLOUD and the boiler, if provided for by the OTBus protocol).</p>
<p data-bbox="263 545 306 566">tFLU</p> 	<p data-bbox="474 545 965 671">Temperature read by the boiler flue gas probe (available with OTBus connection between the WiFi Box and the boiler or the RF receiver and the boiler or RiCLOUD and the boiler, if provided for by the OTBus protocol).</p>
<p data-bbox="263 763 306 785">tEst</p> 	<p data-bbox="474 763 965 946">Temperature read by the external probe connected to the boiler or the external temperature communicated via the APP (available with OTBus connection between the WiFi Box and the boiler or the RF receiver and the boiler or RiCLOUD and the boiler, if provided for by the OTBus protocol).</p>
<p data-bbox="252 982 317 1003">MODU</p> 	<p data-bbox="474 982 965 1193">Boiler fan speed percentage (available with OTBus connection between the WiFi Box and the boiler or the RF receiver and the boiler or RiCLOUD and the boiler, if provided for by the OTBus protocol). The value 0.0 corresponds to the MINIMUM DOMESTIC HOT WATER POWER; the value 100 corresponds to the MAXIMUM DOMESTIC HOT WATER POWER.</p>

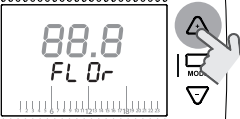
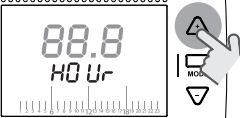
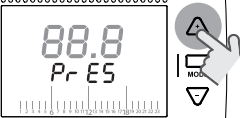
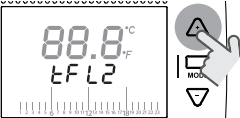
Parameter	Description
<p data-bbox="208 97 256 115">FLOr</p> 	<p data-bbox="422 97 923 248">Flow meter rate in litres/minute, where a flow meter is available (available with OTBus connection between the WiFi Box and the boiler or the RF receiver and the boiler or RiCLOUD and the boiler, if provided for by the OTBus protocol).</p>
<p data-bbox="205 317 260 335">HOUr</p> 	<p data-bbox="422 317 923 468">Number of operating hours in high condensation mode (available with OTBus connection between the WiFi Box and the boiler or the RF receiver and the boiler or RiCLOUD and the boiler, if provided for by the OTBus protocol).</p>
<p data-bbox="208 536 256 555">PrES</p> 	<p data-bbox="422 588 923 715">System pressure (available with OTBus connection between the WiFi Box and the boiler or the RF receiver and the boiler or RiCLOUD and the boiler, if provided for by the OTBus protocol).</p>
<p data-bbox="211 756 253 775">tF12</p> 	<p data-bbox="422 809 923 961">Temperature read by the delivery probe in the second heating circuit (available with OTBus connection between the WiFi Box and the boiler or the RF receiver and the boiler or RiCLOUD and the boiler, if provided for by the OTBus protocol).</p>

Press the SET/PROG button to save and return to the programming menu, press ESC/MODE to save and exit the programming menu, or wait 180 seconds to automatically save the value and return to the HOME screen.

3.12 Technical menu – Advanced programming

From the HOME screen, press the SET/PROGRAM button to open the user menu.

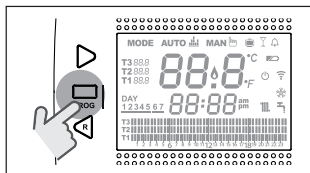

Press the FORWARD > or BACK < button to select the field PL.

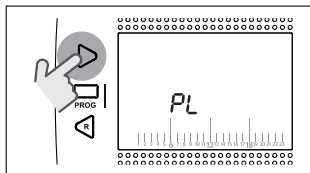

Press the SET/PROG button to set.

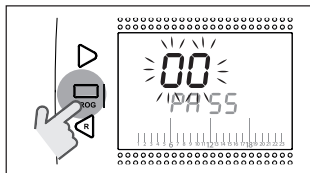

Press the UP ^ or DOWN v button to insert the installer password (password = 18).

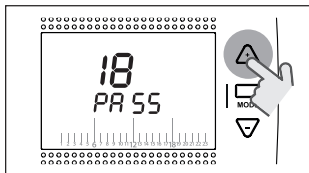

Press the SET/PROG button to set.

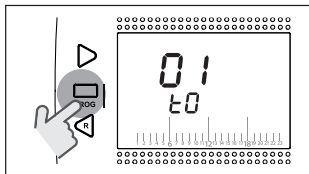







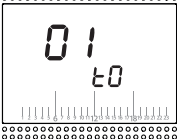

Press the FORWARD > or BACK < button to select the desired parameter.

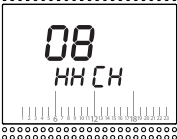
Press the SET/PROGRAM button to set the selected parameter. For parameters 08 to 19, use the FORWARD > or BACK < button to select the 2 sub-parameters.

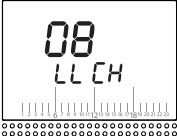
Press the UP ^ or DOWN v button to modify the selected parameter.

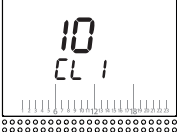
Press the SET/PROG button to save and return to the technical menu, press ESC/MODE to save and exit the technical menu, or wait 120 seconds to automatically save the value and return to the HOME screen.

Parameter	Description
<p style="text-align: center;">01 to</p>  	<p>Minimum safety temperature. The value can be set from 1°C to 5°C. Default set to 3°C. Should RiCLOUD room probe detect a temperature below the parameter set, a heating request is generated – only when HEATING in operating modes SUMMER/ DOMESTIC HOT WATER and OFF – taking into account the hysteresis set under the H0n and H0FF parameters.</p>
<p style="text-align: center;">08 HHCH</p>  	<p>Maximum local central heating temperature setpoint (available with OTBus connection between the WiFi Box and the boiler or the RF receiver and the boiler or RiCLOUD and the boiler, if provided for by the OTBus protocol). The value can be set between 80°C and 40°C (for high temperature heating) or from 45°C to 20°C (for low temperature heating).</p>
<p style="text-align: center;">08 LLCH</p>  	<p>Minimum heating setpoint temperature (available with OTBus connection between the WiFi Box and the boiler or the RF receiver and the boiler or RiCLOUD and the boiler, if provided for by the OTBus protocol). The value can be set from 10°C to HHCH -1°C.</p>
<p style="text-align: center;">10 CL</p>  	<p>Thermoregulation curve with external probe connected to the boiler or external web probe via the APP (available with OTBus connection between the WiFi Box and the boiler or the RF receiver and the boiler or RiCLOUD and the boiler, if provided for by the OTBus protocol). Default set to 1.2°C. The value can be set from 0.2°C to 3°C. The parameter in question affects the calculation of the heating delivery setpoint temperature.</p>

Parameter

Description

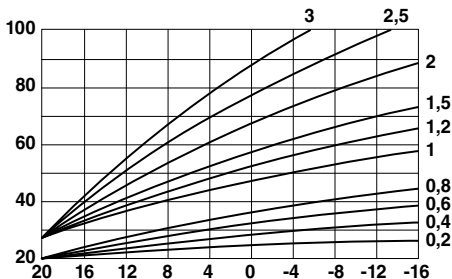

$$T \text{ Mand risc} = T \text{ Mand Curva} + (CLI * InFL * \Delta T \text{ Amb})$$

T Mand Curva = Delivery temperature calculated using the thermoregulation curve set under parameter CLI

CLI = thermoregulation curve

InFL = room influence

$\Delta T \text{ Amb}$ = (room temperature set) – (current room temperature)

11 InFL

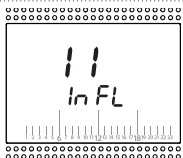

Influence of room probe on calculation of heating delivery setpoint temperature (available with OTBus connection between the WiFi Box and the boiler or the RF receiver and the boiler or RiCLOUD and the boiler, if provided for by the OTBus protocol). Default set to 10.

The value can be set from 0°C to 20°C.

$$T \text{ Mand risc} = T \text{ Mand Curva} + (CLI * InFL * \Delta T \text{ Amb})$$

T Mand Curva = Delivery temperature calculated using the thermoregulation curve set under parameter CLI













CLI = thermoregulation curve



InFL = room influence







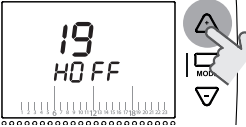

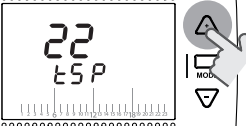

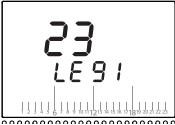
$\Delta T \text{ Amb}$ = (room temperature set) – (current room temperature)

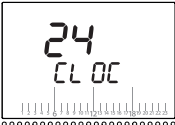

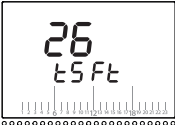

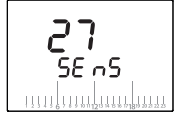
Setting the parameter InFL=0, with the external probe disconnected from the boiler and the web external probe not enabled on the app, the heating delivery temperature (per la zona comandata dal RiCLOUD) is the same as the temperature set under parameter LLCH.

Parameter	Description
<p>13 CALI</p>  	<p>Correction of the temperature detected by RiCLOUD room probe. The value can be set with a hysteresis of $\pm 7^{\circ}\text{C}$.</p>
<p>14 FACT</p>  	<p>Restore factory settings. The value can be set from 0 to 1. By setting this parameter to 1, RiCLOUD values are restored to the default setting, excluding the date and time and the domestic hot water temperature.</p>
<p>16 SOFt</p>  	<p>RiCLOUD software version. Read-only parameter.</p>
<p>17 dEgr</p>      	<p>Setting the unit of measure. The value can be set to $^{\circ}\text{C}$ or $^{\circ}\text{F}$. The default setting is $^{\circ}\text{C}$ (degrees Centigrade). This parameter allows you to set and view temperatures on the degrees Centigrade or degrees Fahrenheit scale.</p>

Parameter	Description
<p data-bbox="241 111 326 135">19 HOn</p> 	<p data-bbox="474 111 971 158">Setting the ON hysteresis for heating or cooling requests.</p> <p data-bbox="474 161 971 208">The value can be set from 0°C to 2°C; the default setting is 0.4°C.</p> <p data-bbox="474 211 971 361">RiCLOUD processes an ON request below the target room temperature set (desired room setpoint – H On) if the heating mode is active, or above the target room temperature set (desired room setpoint + H On) if the cooling mode is active.</p>
<p data-bbox="241 378 326 402">19 HOFF</p> 	<p data-bbox="474 378 971 425">Setting the OFF hysteresis for heating or cooling requests.</p> <p data-bbox="474 428 971 475">The value can be set from 0°C to 2°C; the default setting is 0.1°C.</p> <p data-bbox="474 478 971 628">RiCLOUD processes an OFF request above the target room temperature set (desired room setpoint + H OFF) if the heating mode is active, or below the target room temperature set (desired room setpoint – H OFF) if the cooling mode is active.</p>
<p data-bbox="251 645 315 669">21 ALL</p> 	<p data-bbox="474 645 971 823">Alarm history display (available with OTBus connection between the WiFi Box and the boiler or the RF receiver and the boiler or RiCLOUD and the boiler, if provided for by the OTBus protocol). The last 9 alarms generated by the boiler and saved by RiCLOUD are shown.</p>
<p data-bbox="251 912 315 936">22 tSP</p> 	<p data-bbox="474 912 971 1058">Setting boiler parameters (available with OTBus connection between the WiFi Box and the boiler or the RF receiver and the boiler or RiCLOUD and the boiler, if provided for by the OTBus protocol). This parameter is set by the Authorised Service Centre.</p>

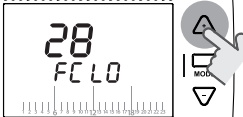
Parameter	Description
<p data-bbox="191 111 270 135">23 LEgI</p>  	<p data-bbox="422 111 923 287">Enabling the anti-legionella function for boilers with domestic hot water tank (available with OTBus connection between the WiFi Box and the boiler or the RF receiver and the boiler or RiCLOUD and the boiler, if provided for by the OTBus protocol). Default set to OFF.</p> <p data-bbox="422 291 923 515">This value can be set to ON or OFF. By setting this parameter to ON; every 20 domestic hot water request cycles a request to replenish the tank is sent with a domestic hot water delivery setpoint of 65°C. If the 20 cycles have not be performed within one week, a request to replenish the tank is sent with a domestic hot water delivery setpoint of 65°C on Saturday at 1.00 a.m.</p>
<p data-bbox="191 531 270 555">24 CLOC</p>  	<p data-bbox="422 531 923 682">Enabling domestic hot water timer for boilers with domestic hot water tank (available with OTBus connection between the WiFi Box and the boiler or the RF receiver and the boiler or RiCLOUD and the boiler, if provided for by the OTBus protocol).</p> <p data-bbox="422 686 923 811">Default set to OFF. This value can be set to ON or OFF. Setting this parameter to ON, the domestic hot water time periods can be programmed, as explained in "3.8 Setting the DHW time program" page 72.</p>
<p data-bbox="191 825 270 849">26 tSft</p>  	<p data-bbox="422 825 923 1125">The parameter will only be shown if the SE nS parameter is OFF (available with OTBus connection between the WiFi Box and the boiler or the RF receiver and the boiler or RiCLOUD and the boiler, if provided for by the OTBus protocol). Default set to 10°C. The value can be set from 1°C to 20°C. The value set for this parameter will be subtracted from the heating delivery setpoint calculated by RiCLOUD (tSEt), only in AUTO AUTO  operating mode, during the T2 (economy) or T1 (anti-freeze) time period.</p>
<p data-bbox="191 1142 270 1166">27 SE nS</p>  	<p data-bbox="422 1142 923 1318">Enabling/disabling room sensor to activate pure climate control (thermoregulation from a single external probe). Default set to ON. This value can be set to ON or OFF. In AUTO AUTO , MAN MAN  and PARTY  operating modes only, by setting this parameter to OFF the heating/cooling request is processed as follows:</p>

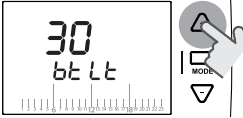
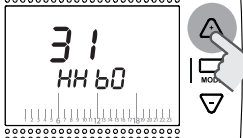
Parameter	Description
<ul style="list-style-type: none"> - In ON/OFF mode, the heating/cooling request is always active (relay closed) if the T3 (comfort) time period is active. - In OTBus mode, the heating request is always active (only with the external probe connected to the boiler or the external web probe via the APP) and the heating setpoint temperature is calculated using the external probe value only. The value set for parameter 26 (tSft) is subtracted from the heating delivery setpoint calculated by RiCLOUD (tSet), only in AUTO AUTO mode operating mode, during the T2 (economy) or T1 (anti-freeze) time period. 	
 This function uses one RiCLOUD only.	
<p>28 FCLO</p> 	<p>Time display setting. Default set to 24-hour clock.</p> <p>The format can be set to the 12- or 24-hour clock.</p> <p>Setting the parameter to 12H, the field is display in the 12-hour a.m./p.m. format.</p>
<p>29 CHOt</p> 	<p>Enabling/disabling heat request via OTBus (available with OTBus connection between the WiFi Box and the boiler or the RF receiver and the boiler or RiCLOUD and the boiler, if provided for by the OTBus protocol). Default set to ON. This value can be set to ON or OFF. Setting this parameter to OFF, RiCLOUD thermostat does not consider the heating request via OTBus to the boiler.</p>
<p>30 btLt</p> 	<p>Enable/disable backlighting.</p> <p>ON/OFF Configurable value: set to OFF so that the backlighting will not switch on at every operation thus making the batteries last longer. Press the button SET/PROG or ESC/MODE to go back to the HOME page.</p>
<p>31 HHbO</p> 	<p>Maximum boiler/central heating temperature setpoint (available with OTBus connection between the WiFi Box and the boiler or the RF receiver and the boiler or RiCLOUD and the boiler, if provided for by the OTBus protocol). The value can be set between 80°C and 40°C (for high temperature heating) or from 45°C to 20°C (for low temperature heating). This parameter has to be set by the Authorised Service Centre.</p>
<p>00 EHIt</p>	<p>Press the SET/PROG button or ESC/MODE to return to the HOME screen.</p>

3.13 Linking function

RiCLOUD linking with the WiFi Box

RiCLOUD and the WiFi Box in the WiFi RiCLOUD package are already linked. If installing an additional RiCLOUD, follow the procedure below.

Ensure that RiCLOUD and the WiFi Box are connected to a power source and there are no alarms.

Press the prismatic dome clear LED button (A) and hold for 5 seconds until the green and red LEDs flash slow (1 sec) at the same time (once linked the flash will return to normal).

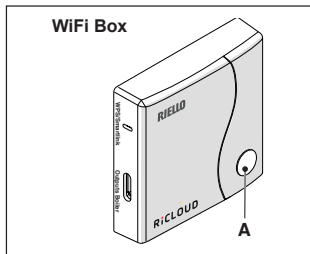

From RiCLOUD HOME screen, press the ESC/MODE button and hold for 5 seconds to display the following (alternating) information.

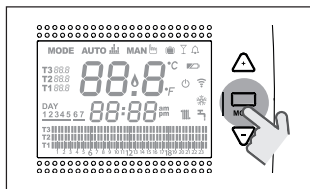

EXAMPLE OF LINKED RiCLOUD

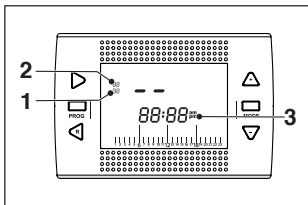

- 1 Radio frequency channel
- 2 Receiver (WiFi Box) number
- 3 Radio frequency address

EXAMPLE OF LINKED RiCLOUD

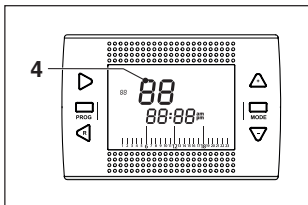

- 4 Transmitter number (RiCLOUD)

To complete the link, press the SET/PROGRAM button or wait for RiCLOUD to return to the HOME screen.

! This may take up to 2 minutes, after which RiCLOUD automatically returns to the HOME screen.

Should the link not be successful, please contact the Authorised Service Centre.

Linking the boiler RF receiver to the WiFi Box

If installing a boiler RF receiver, please follow the procedure below.

Press the prismatic dome clear LED button (A) on the **WiFi Box** and hold for 5 seconds until the green and red LEDs flash slow at the same time (1 second).

Press and hold again for 5 seconds until the green and red LEDs momentarily switch off and then flash slowly (every 2 seconds).

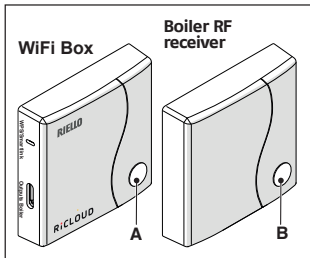

Press the prismatic dome clear LED button (B) on the boiler RF receiver and hold for 5 seconds until the green and red LEDs flash frequently (every 0.5 seconds) at the same time.

The WiFi Box flashes frequently (every 0.5 seconds) to show the link has been made.

Press the button on the WiFi Box again to confirm.

The boiler RF receiver auto-configures to normal operating mode.



This may take up to 2 minutes, after which the **RiCLOUD** automatically returns to the HOME screen.

Should the link not be successful, please contact the Authorised Service Centre.

Linking the boiler RF receiver to the RiCLOUD

RiCLOUD programmable thermostat can be linked to a wireless receiver if you want to replicate the relay functionality on the thermostat in a remote zone (e.g. zone valve), which is not accessible with a cable (wireless access).

Follow the procedure below to link them:

Press the prismatic dome clear LED button on the boiler RF receiver and hold for 5 seconds until the green and red LEDs flash slow (1 seconds) at the same time (once linked the flash returns to normal).

From **RiCLOUD HOME** screen, press the **ESC/MODE** button and hold for 5 seconds to display the following (alternating) information:

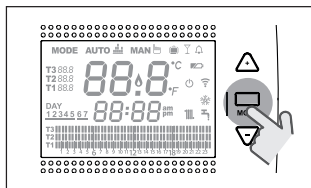

EXAMPLE OF LINKED RiCLOUD

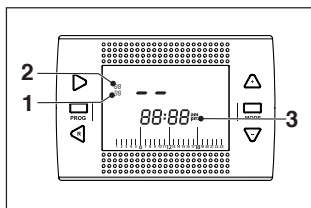

- 1 Radio frequency channel
- 2 Receiver (WiFi Box) number
- 3 Radio frequency address

EXAMPLE OF LINKED RiCLOUD

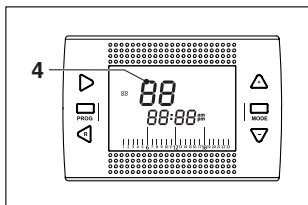

4 Transmitter number (**RiCLOUD**)

To complete the link, press the **SET/PROGRAM** button or wait for **RiCLOUD** to return to the **HOME** screen.



This may take up to 2 minutes, after which **RiCLOUD** automatically returns to the **HOME** screen.

Should the link not be successful, please contact the **Authorised Service Centre**.

4 ALARMS AND OPERATING STATUSES

4.1 LED notification lights for the WiFi Box and boiler RF receiver **

LED Green	LED Red	Status
F05		Relay = closed (only for ON/OFF connections)
F1		Relay = open (only for ON/OFF connections)
ON		OTBus connection = OK (for OTBus connection)
ON	F01	Boiler alarm (only for OTBus connection)
F05 F1 ON	ON	Network or RF error
F05	F05	WPS mode active – Wait for WPS signal from the router*
	F05	WPS signal accepted*
F05	F05	Smartlink mode active*
F1	F1	Encoded RF mode active*

* Only for WiFi Box

** The notification lights on boiler RF receivers may differ with respect to the table.

LED

ON = remains on

F05 = quick flash (every 0.5 seconds)

F1 = slow flash (every 1 second)

Operation of the prismatic dome clear LED button on the WiFi Box and boiler RF receiver

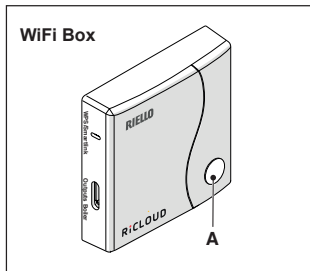

In case of a boiler alarm (available with OTBus connection between the WiFi Box and the boiler or the RF receiver and the boiler or RiCLOUD and the boiler, if provided for by the OTBus protocol), the alarm can be reset by pressing the prismatic dome clear LED button (A) (for alarm A99, reset from the boiler).

With an ON/OFF connection, the relay can be activated or deactivated by pressing the prismatic dome clear LED button (A).

4.2 Boiler and RiCLOUD alarms



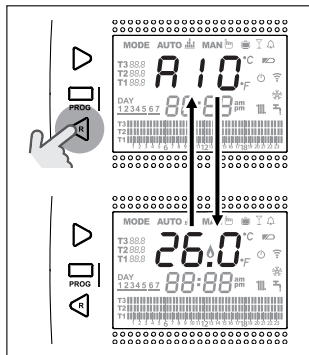

The alarm is shown in alternation with the room temperature detected by RiCLOUD on the display.

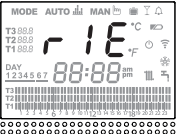
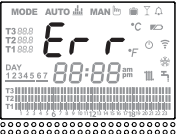
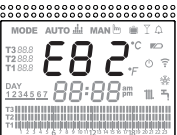
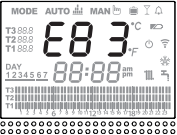

In case of a boiler alarm (available with OTBus connection between the WiFi Box and the boiler, if provided for by the OTBus protocol), the alarm can be reset by pressing the BACK/RESET button < (for alarm A99, reset from the boiler).

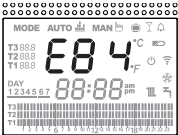
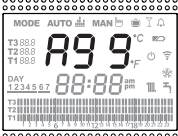
! RiCLOUD alarms (rIE, E82, E83) and the temporary boiler alarms may be automatically reset once the fault has been resolved.

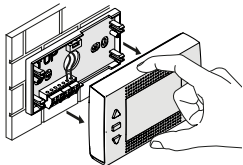
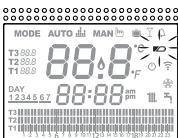
Alarm	Description	Solution
rIE	 <p>Semi-automatic fill function.</p>	<ul style="list-style-type: none"> - See "3.6.3 SEMI-AUTOMATIC FILLING function" page 69 - Check the system pressure. - Should you not be able to remove the alarm, please contact the Authorised Service Centre.
Err	 <p>RiCLOUD room temperature sensor damaged. Cannot be repaired.</p>	<ul style="list-style-type: none"> - Replace RiCLOUD - Contact the Authorised Service Centre.
E82	 <p>Communication failure between the RiCLOUD and the WiFi Box.</p>	<ul style="list-style-type: none"> - Check the distance between RiCLOUD and the WiFi Box (see page 211). - Remove and then reinsert the batteries. - Check that the WiFi Box is connected to a power source. - Check the coupling between RiCLOUD and the WiFi Box (see "3.13 Linking function" page 86). - Contact the Authorised Service Centre.
E83	 <p>OTBus communication failure between the WiFi Box and the boiler or the RiCLOUD and the boiler.</p>	<ul style="list-style-type: none"> - Check the OTBus electrical connection and the maximum distance between the WiFi Box and the boiler OTBus terminal or between RiCLOUD and the boiler OTBus terminal (see page 211). - Contact the Authorised Service Centre.

<p>E84</p>	 <p>Hardware error RiCLOUD. Cannot be repaired.</p>	<ul style="list-style-type: none"> - Replace RiCLOUD. - Contact the Authorised Service Centre.
<p>A01....99</p>	<p>Boiler alarm.</p>	<ul style="list-style-type: none"> - See boiler manual.
<p>A99</p>	 <p>Too many boiler resets performed via remote control.</p>	<ul style="list-style-type: none"> - Reset from the boiler.
	  <p>Batteries running low</p>	<p>To replace the batteries, remove RiCLOUD from its base.</p> <ul style="list-style-type: none"> - Replace the batteries. - Check that the contacts are not rusty. - Replace RiCLOUD. - Contact the Authorised Service Centre. <p> Replace the batteries as soon as possible. When the low battery warning is on, correct operation of RiCLOUD and any RF communication is no longer guaranteed.</p>

Alarm	Description
A01-A10	Burner ignition/detection failure after numerous attempts
A02-A20	Limit thermostat tripped
A03-A30	Flue gas thermostat and/or safety thermostat and/or air pressure switch and/or fan fault
A04-A40	Primary circuit pressure insufficient
A06-A60	DHW NTC probe anomaly
A07-A70	Alarm relating to heating NTC probe and/or delivery NTC probe and/or excessive differential between the delivery and return NTC probes
A08	Alarm relating to return NTC probe and/or excessive differential between probes
A09-A91	Flue gas NTC probe or dirty exchanger alarm
A77	Low external temperature limit thermostat tripped
A99	Too many resets performed via remote control

The alarm history can be viewed under the parameter ALL from the advanced programming menu.

For details of boiler alarms, please see the boiler installer manual.

FCC Statement

This device complies with Part 15 of the FCC Rules. Operation is subject to the following two conditions: (1) this device may not cause harmful interference, and (2) this device must accept any interference received, including interference that may cause undesired operation.

Changes or modifications not expressly approved by the party responsible for compliance could void the user's authority to operate the equipment.

NOTE: This equipment has been tested and found to comply with the limits for a Class B digital device, pursuant to Part 15 of the FCC Rules. These limits are designed to provide reasonable protection against harmful interference in a residential installation. This equipment generates, uses instructions, may cause harmful interference to radio communications. However, there is no guarantee that interference will not occur in a particular installation. If this equipment does cause harmful interference to radio or television reception, which can be determined by turning the equipment off and on, the user is encouraged to try to correct the interference by one or more of the following measures:

- Reorient or relocate the receiving antenna.
- Increase the separation between the equipment and receiver.
- Connect the equipment into an outlet on a circuit different from that to which the receiver is connected.
- Consult the dealer or an experienced radio/TV technician for help.

The distance between user and products should be no less than 20cm

IC Statement

This device complies with Industry Canada's licence-exempt RSSs. Operation is subject to the following two conditions:

- (1) This device may not cause interference; and
 - (2) This device must accept any interference, including interference that may cause undesired operation of the device. The distance between user and products should be no less than 20cm. Cet appareil est conforme aux CNR exemptes de licence d'Industrie Canada . Son fonctionnement est soumis aux deux conditions suivantes :
- (1) Ce dispositif ne peut causer d'interférences ; et
- (2) Ce dispositif doit accepter toute interférence , y compris les interférences qui peuvent causer un mauvais fonctionnement de l'appareil. la distance entre l'utilisateur et les produits devraient être au moins 20 cm.