

CFR 47 FCC PART 15 SUBPART C

TEST REPORT

For

Security Camera

MODEL NUMBER: VMC3081, VMC2081

REPORT NUMBER: 4791756546-1-RF-1

ISSUE DATE: June 26, 2025

FCC ID:2APLE18300433

Prepared for

**Arlo Technologies, Inc.
5770 Fleet St, Suite 200, Carlsbad, CA 92008 USA**

Prepared by

UL Verification Services (Guangzhou) Co., Ltd, Song Shan Lake Branch

**Room 101, Building 2, No.4, Information Road, Songshan Lake, Dongguan,
Guangdong, China**

Tel: +86 769 22038881

Fax: +86 769 33244054

Website: www.ul.com

The results reported herein have been performed in accordance with the laboratory's terms of accreditation. This report shall not be reproduced except in full without the written approval of the Laboratory. The results in this report apply to the test sample(s) mentioned above at the time of the testing period only and are not to be used to indicate applicability to other similar products.

Revision History

Rev.	Issue Date	Revisions	Revised By
V0	June 26, 2025	Initial Issue	

Summary of Test Results

Test Item	Clause	Limit/Requirement	Result
Antenna Requirement	N/A	FCC Part 15.203/15.247 (c)	Pass
AC Power Line Conducted Emission	ANSI C63.10-2013, Clause 6.2	FCC Part 15.207	Pass
Conducted Output Power	ANSI C63.10-2013, Clause 11.9.1.3 & 11.9.2.3.1	FCC Part 15.247 (b)(3)	Pass
6dB Bandwidth and 99% Occupied Bandwidth	ANSI C63.10-2013, Clause 11.8.1	FCC Part 15.247 (a)(2)	Pass
Power Spectral Density	ANSI C63.10-2013, Clause 11.10.2	FCC Part 15.247 (e)	Pass
Conducted Band edge and spurious emission	ANSI C63.10-2013, Clause 11.11	FCC Part 15.247(d)	Pass
Radiated Band edge and Spurious Emission	ANSI C63.10-2013, Clause 11.12 & Clause 11.13	FCC Part 15.247 (d) FCC Part 15.205/15.209	Pass
Duty Cycle	ANSI C63.10-2013, Clause 11.6	None; for reporting purposes only.	Pass

*This test report is only published to and used by the applicant, and it is not for evidence purpose in China.

*The measurement result for the sample received is <Pass> according to <CFR 47 FCC PART 15 SUBPART C> when <Simple Acceptance> decision rule is applied.

CONTENTS

1. ATTESTATION OF TEST RESULTS	6
2. TEST METHODOLOGY	7
3. FACILITIES AND ACCREDITATION	7
4. CALIBRATION AND UNCERTAINTY	8
4.1. <i>MEASURING INSTRUMENT CALIBRATION</i>	8
4.2. <i>MEASUREMENT UNCERTAINTY</i>	8
5. EQUIPMENT UNDER TEST	9
5.1. <i>DESCRIPTION OF EUT</i>	9
5.2. <i>CHANNEL LIST</i>	9
5.3. <i>MAXIMUM POWER</i>	9
5.4. <i>TEST CHANNEL CONFIGURATION</i>	9
5.5. <i>THE WORSE CASE POWER SETTING PARAMETER</i>	10
5.6. <i>DESCRIPTION OF AVAILABLE ANTENNAS</i>	10
5.7. <i>SUPPORT UNITS FOR SYSTEM TEST</i>	11
6. MEASURING EQUIPMENT AND SOFTWARE USED	12
7. ANTENNA PORT TEST RESULTS	15
7.1. <i>CONDUCTED OUTPUT POWER</i>	15
7.2. <i>6DB BANDWIDTH AND 99% OCCUPIED BANDWIDTH</i>	17
7.3. <i>POWER SPECTRAL DENSITY</i>	19
7.4. <i>CONDUCTED BAND EDGE AND SPURIOUS EMISSION</i>	21
7.5. <i>DUTY CYCLE</i>	23
8. RADIATED TEST RESULTS	24
8.1. <i>RESTRICTED BANDEDGE</i>	32
8.2. <i>SPURIOUS EMISSIONS(1 GHZ~3 GHZ)</i>	36
8.3. <i>SPURIOUS EMISSIONS(3 GHZ~18 GHZ)</i>	42
8.4. <i>SPURIOUS EMISSIONS(9 KHZ~30 MHZ)</i>	48
8.5. <i>SPURIOUS EMISSIONS(18 GHZ~26 GHZ)</i>	51
8.6. <i>SPURIOUS EMISSIONS(30 MHZ~1 GHZ)</i>	53
9. ANTENNA REQUIREMENT	55
10. AC POWER LINE CONDUCTED EMISSION	56
11. TEST DATA	60

11.1.	<i>APPENDIX A: DTS BANDWIDTH</i>	60
11.1.1.	Test Result	60
11.1.2.	Test Graphs	61
11.2.	<i>APPENDIX B: OCCUPIED CHANNEL BANDWIDTH</i>	62
11.2.1.	Test Result	62
11.2.2.	Test Graphs	63
11.3.	<i>APPENDIX C: MAXIMUM CONDUCTED OUTPUT POWER</i>	64
11.4.	<i>APPENDIX D: MAXIMUM POWER SPECTRAL DENSITY</i>	65
11.4.1.	Test Result	65
11.4.2.	Test Graphs	66
11.5.	<i>APPENDIX E: BAND EDGE MEASUREMENTS</i>	67
11.5.1.	Test Result	67
11.5.2.	Test Graphs	68
11.6.	<i>APPENDIX F: CONDUCTED SPURIOUS EMISSION</i>	69
11.6.1.	Test Result	69
11.6.2.	Test Graphs	70
11.7.	<i>APPENDIX G: DUTY CYCLE</i>	73
11.7.1.	Test Result	73
11.7.2.	Test Graphs	74

1. ATTESTATION OF TEST RESULTS

Applicant Information

Company Name: Arlo Technologies, Inc.
Address: 5770 Fleet St, Suite 200, Carlsbad, CA 92008 USA

Manufacturer Information

Company Name: Arlo Technologies, Inc.
Address: 5770 Fleet St, Suite 200, Carlsbad, CA 92008 USA

EUT Information

EUT Name: Security Camera
Model: VMC3081
Series Model: VMC2081
Sample Received Date: March 20, 2025
Sample Status: Normal
Sample ID: 8388280
Date of Tested: March 21, 2025 to June 26, 2025

APPLICABLE STANDARDS	
STANDARD	TEST RESULTS
CFR 47 FCC PART 15 SUBPART C	Pass

Prepared By:

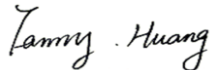

Fanny Huang
Engineer Project Associate

Checked By:

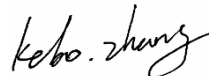

Kebo Zhang
Senior Project Engineer

Approved By:



Stephen Guo
Operations Manager

2. TEST METHODOLOGY

All tests were performed in accordance with the standard CFR 47 FCC PART 15 SUBPART C KDB 558074 D01 15.247 Meas Guidance v05r02, 414788 D01 Radiated Test Site v01r01, CFR 47 FCC Part 2, ANSI C63.10-2013.

3. FACILITIES AND ACCREDITATION

Accreditation Certificate	<p>A2LA (Certificate No.: 4102.01) UL Verification Services (Guangzhou) Co., Ltd. Song Shan Lake Branch. has been assessed and proved to be in compliance with A2LA.</p> <p>FCC (FCC Designation No.: CN1187) UL Verification Services (Guangzhou) Co., Ltd. Song Shan Lake Branch. Has been recognized to perform compliance testing on equipment subject to the Commission's Declaration of Conformity (DoC) and Certification rules.</p> <p>ISED (Company No.: 21320) UL Verification Services (Guangzhou) Co., Ltd. Song Shan Lake Branch. has been registered and fully described in a report filed with ISED. The Company Number is 21320 and the test lab Conformity Assessment Body Identifier (CABID) is CN0046.</p>
---------------------------	--

Note 1:

All tests measurement facilities use to collect the measurement data are located at Room 101, Building 2, No.4, Information Road, Songshan Lake, Dongguan, Guangdong, China.

Note 2:

The test anechoic chamber in UL Verification Services (Guangzhou) Co., Ltd. Song Shan Lake Branch had been calibrated and compared to the open field sites and the test anechoic chamber is shown to be equivalent to or worst case from the open field site.

Note 3:

For below 30 MHz, lab had performed measurements at test anechoic chamber and comparing to measurements obtained on an open field site. And these measurements below 30 MHz had been correlated to measurements performed on an OFS.

4. CALIBRATION AND UNCERTAINTY

4.1. MEASURING INSTRUMENT CALIBRATION

The measuring equipment utilized to perform the tests documented in this report has been calibrated in accordance with the manufacturer's recommendations and is traceable to recognized national standards.

4.2. MEASUREMENT UNCERTAINTY

Where relevant, the following measurement uncertainty levels have been estimated for tests performed on the apparatus:

Test Item	Uncertainty
Conduction emission	3.62 dB
Radiated Emission (Included Fundamental Emission) (9 kHz ~ 30 MHz)	2.2 dB
Radiated Emission (Included Fundamental Emission) (30 MHz ~ 1 GHz)	4.00 dB
Radiated Emission (Included Fundamental Emission) (1 GHz to 26 GHz)	5.78 dB (1 GHz ~ 18 GHz)
	5.23 dB (18 GHz ~ 26 GHz)
Duty Cycle	±0.028%
DTS and 99% Occupied Bandwidth	±0.0196%
Maximum Conducted Output Power	±0.686 dB
Maximum Power Spectral Density Level	±0.743 dB
Conducted Band-edge Compliance	±1.328 dB
Conducted Unwanted Emissions In Non-restricted Frequency Bands	±0.746 dB (9 kHz ~ 1 GHz)
	±1.328dB (1 GHz ~ 26 GHz)
Note: This uncertainty represents an expanded uncertainty expressed at approximately the 95% confidence level using a coverage factor of k=2.	

5. EQUIPMENT UNDER TEST

5.1. DESCRIPTION OF EUT

EUT Name	Security Camera
Model	VMC3081
Series Model	VMC2081
Model Difference	Please refer to the declaration letter.

Frequency Range:	2402 MHz to 2480 MHz
Type of Modulation:	GFSK
Data Rates:	1Mbps
Normal Test Voltage:	AC 120 V, 60 Hz

5.2. CHANNEL LIST

Channel	Frequency (MHz)	Channel	Frequency (MHz)	Channel	Frequency (MHz)	Channel	Frequency (MHz)
0	2402	11	2424	22	2446	33	2468
1	2404	12	2426	23	2448	34	2470
2	2406	13	2428	24	2450	35	2472
3	2408	14	2430	25	2452	36	2474
4	2410	15	2432	26	2454	37	2476
5	2412	16	2434	27	2456	38	2478
6	2414	17	2436	28	2458	39	2480
7	2416	18	2438	29	2460	/	/
8	2418	19	2440	30	2462	/	/
9	2420	20	2442	31	2464	/	/
10	2422	21	2444	32	2466	/	/

5.3. MAXIMUM POWER

Test Mode	Frequency (MHz)	Channel Number	Maximum Peak Output Power (dBm)	Maximum EIRP (dBm)
LE 1M	2402 ~ 2480	0-39[40]	16.57	19.47

5.4. TEST CHANNEL CONFIGURATION

Test Mode	Test Channel	Frequency
-----------	--------------	-----------

LE 1M	CH 0(Low Channel), CH 19(MID Channel), CH 39(High Channel)	2402 MHz, 2440 MHz, 2480 MHz
-------	--	------------------------------

5.5. THE WORSE CASE POWER SETTING PARAMETER

The Worst Case Power Setting Parameter under 2400 ~ 2483.5MHz Band			
Test Software Version		CMD	
Modulation Type	Transmit Antenna Number	Test Software setting value	
		CH 0	CH 19
GFSK(1Mbps)	1	15	15

5.6. DESCRIPTION OF AVAILABLE ANTENNAS

Antenna	Frequency (MHz)	Antenna Type	MAX Antenna Gain (dBi)
1	2402-2480	PIFA Antenna	2.90

Test Mode	Transmit and Receive Mode	Description
LE 1M	<input checked="" type="checkbox"/> 1TX, 1RX	Antenna 1 can be used as transmitting/receiving antenna.
Note: 1.BLE&WLAN 2.4G, BLE & WLAN 5G, WLAN 2.4G & WLAN 5G can't transmit simultaneously. (declared by client)		

5.7. SUPPORT UNITS FOR SYSTEM TEST

SUPPORT EQUIPMENT

Item	Equipment	Brand Name	Model Name	Remarks
1	Laptop	Lenovo	E42-80	R303U5AG

I/O CABLES

Cable No	Port	Connector Type	Cable Type	Cable Length(m)	Remarks
1	USB	/	/	1.0	/

ACCESSORIES

Item	Accessory	Brand Name	Model Name	Description
1	Power Adapter	/	GTF9V1C-C	Input: AC 100-240V, 50/60Hz, 0.3A Output: DC 9.0V, 1.0A, 9.0W
2	Power Adapter	/	AD2151321	Input: AC 100-240V, 50/60Hz, 0.3A Output: DC 6.6V, 1.0A
3	POE	/	VMA3900	Input: 37-57 VDC Output: DC 5V, 2A

Note: All the Power Adapter and POE have been pre-tested, and only the worst data was recorded in the report.

TEST SETUP

The EUT can work in engineering mode with a software through a Laptop.

SETUP DIAGRAM FOR TESTS

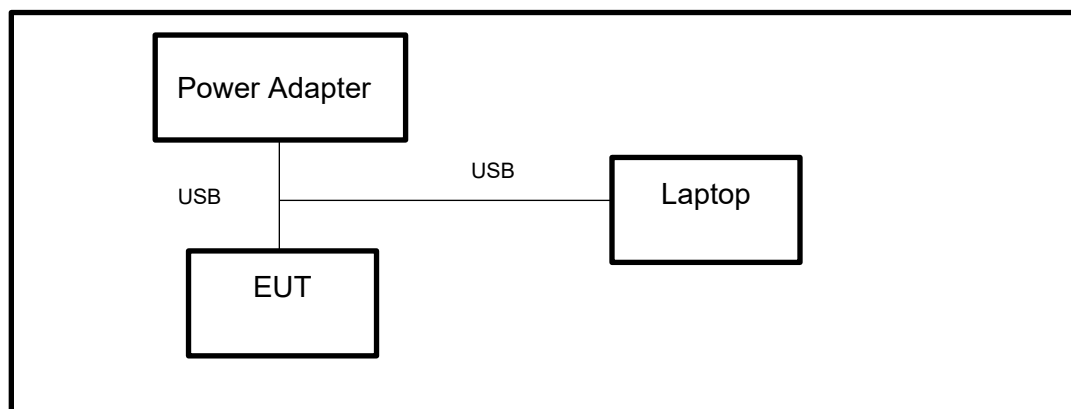

6. MEASURING EQUIPMENT AND SOFTWARE USED

R&S TS 8997 Test System					
Equipment	Manufacturer	Model No.	Serial No.	Last Cal.	Due. Date
Power sensor, Power Meter	R&S	OSP120	100921	Dec.27,2024	Dec.26,2025
Vector Signal Generator	R&S	SMBV100A	261637	Sep.28, 2024	Sep.27, 2025
Signal Generator	R&S	SMB100A	178553	Sep.28, 2024	Sep.27, 2025
Signal Analyzer	R&S	FSV40	101118	Sep.28, 2024	Sep.27, 2025
Software					
Description	Manufacturer	Name		Version	
For R&S TS 8997 Test System	Rohde & Schwarz	EMC 32		10.60.10	
Tonsend RF Test System					
Equipment	Manufacturer	Model No.	Serial No.	Last Cal.	Due. Date
Wireless Connectivity Tester	R&S	CMW270	1201.0002N75-102	Sep.13, 2024	Sep.12, 2025
PXA Signal Analyzer	Keysight	N9030A	MY55410512	Sep.28, 2024	Sep.27, 2025
MXG Vector Signal Generator	Keysight	N5182B	MY56200284	Sep.28, 2024	Sep.27, 2025
MXG Vector Signal Generator	Keysight	N5172B	MY56200301	Sep.28, 2024	Sep.27, 2025
DC power supply	Keysight	E3642A	MY55159130	Sep.28, 2024	Sep.27, 2025
Temperature & Humidity Chamber	SANMOOD	SG-80-CC-2	2088	Sep.28, 2024	Sep.27, 2025
Attenuator	Aglient	8495B	2814a12853	Sep.28, 2024	Sep.27, 2025
RF Control Unit	Tonscend	JS0806-2	23B80620666	Dec.27,2024	Dec.26,2025
Software					
Description	Manufacturer	Name		Version	
Tonsend SRD Test System	Tonsend	JS1120-3 RF Test System		V3.2.22	

Conducted Emissions					
Equipment	Manufacturer	Model No.	Serial No.	Last Cal.	Due Date
EMI Test Receiver	R&S	ESR3	101961	Sep.28, 2024	Sep.27, 2025
Two-Line V-Network	R&S	ENV216	101983	Sep.28, 2024	Sep.27, 2025
Artificial Mains Networks	Schwarzbeck	NSLK 8126	8126465	Sep.28, 2024	Sep.27, 2025
Software					
Description			Manufacturer	Name	Version
Test Software for Conducted Emissions			Farad	EZ-EMC	Ver. UL-3A1

Radiated Emissions					
Equipment	Manufacturer	Model No.	Serial No.	Last Cal.	Due Date
MXE EMI Receiver	KESIGHT	N9038A	MY56400036	Sep.28, 2024	Sep.27, 2025
Hybrid Log Periodic Antenna	TDK	HLP-3003C	130960	June 28, 2024	June.27 2027
Preamplifier	HP	8447D	2944A09099	Sep.28, 2024	Sep.27, 2025
EMI Measurement Receiver	R&S	ESR26	101377	Sep.28, 2024	Sep.27, 2025
Horn Antenna	TDK	HRN-0118	130940	Dec.10, 2024	Dec.11, 2027
Preamplifier	TDK	PA-02-0118	TRS-305-00067	Sep.28, 2024	Sep.27, 2025
Horn Antenna	Schwarzbeck	BBHA9170	697	Jun 30, 2024	Jun 29, 2027
Preamplifier	TDK	PA-02-2	TRS-307-00003	Sep.28, 2024	Sep.27, 2025
Preamplifier	TDK	PA-02-3	TRS-308-00002	Sep.28, 2024	Sep.27, 2025
Loop antenna	Schwarzbeck	1519B	00008	Dec.09, 2024	Dec.08, 2027
High Pass Filter	Wi	WHKX10-2700-3000-18000-40SS	23	Sep.28, 2024	Sep.27, 2025
Band Reject Filter	Wainwright	WRCJV8-2350-2400-2483.5-2533.5-40SS	4	Sep.28, 2024	Sep.27, 2025
Software					
Description			Manufacturer	Name	Version
Test Software for Radiated Emissions			Farad	EZ-EMC	Ver. UL-3A1

Other Instrument					
Equipment	Manufacturer	Model No.	Serial No.	Last Cal.	Due Date
Temperature humidity probe	OMEGA	ITHX-SD-5	18470007	Oct.8, 2024	Oct.7, 2025
Barometer	Yiyi	Baro	N/A	Oct.10, 2024	Oct.9, 2025
Attenuator	Agilent	8495B	2814a12853	Sep.28, 2024	Sep.27, 2025

7. ANTENNA PORT TEST RESULTS

7.1. CONDUCTED OUTPUT POWER

LIMITS

CFR 47 FCC Part15 (15.247) Subpart C			
Section	Test Item	Limit	Frequency Range (MHz)
CFR 47 FCC 15.247(b)(3)	Peak and AVG Conduct Output Power	1 watt or 30 dBm	2400-2483.5

TEST PROCEDURE

For peak power:
Refer to ANSI C63.10-2013 clause 11.9.1.3.

Connect the EUT to a low loss RF cable from the antenna port to the power sensor (video bandwidth is greater than the occupied bandwidth).
Measure peak emission level, the indicated level is the peak output power, after any corrections for external attenuators and cables.

For average power:
Refer to ANSI C63.10-2013 clause 11.9.2.3.1.

Connect the EUT to a low loss RF cable from the antenna port to the power sensor (video bandwidth is greater than the occupied bandwidth).
Measure peak emission level, the indicated level is the average output power, after any corrections for external attenuators and cables.
The test result in dBm by adding $[10 \log (1 / D)]$, where D is the duty cycle.

TEST SETUP

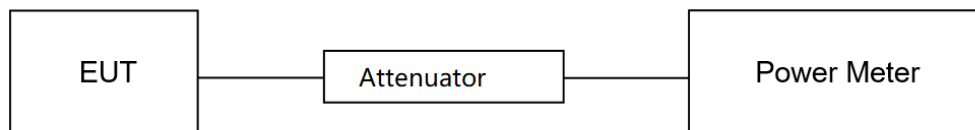

TEST ENVIRONMENT

Temperature	22.8°C	Relative Humidity	58%
Atmosphere Pressure	101kPa	Test Voltage	AC 120V 60Hz

TEST DATE / ENGINEER

Test Date	March 21, 2025	Test By	Walker Yuan
-----------	----------------	---------	-------------

TEST RESULTS

Please refer to section "Test Data" - Appendix C

7.2. 6DB BANDWIDTH AND 99% OCCUPIED BANDWIDTH

LIMITS

CFR 47 FCC Part15 (15.247) Subpart C			
Section	Test Item	Limit	Frequency Range (MHz)
CFR 47 FCC 15.247(a)(2)	6 dB Bandwidth	≥ 500 kHz	2400-2483.5
ISED RSS-Gen Clause 6.7	99 % Occupied Bandwidth	For reporting purposes only.	2400-2483.5

TEST PROCEDURE

Refer to ANSI C63.10-2013 clause 11.8 for DTS bandwidth and clause 6.9 for Occupied Bandwidth.

Connect the EUT to the spectrum analyzer and use the following settings:

Center Frequency	The center frequency of the channel under test
Frequency Span	For 6 dB Bandwidth: Enough to capture all products of the modulation carrier emission For 99 % Occupied Bandwidth: Between 1.5 times and 5.0 times the OBW
Detector	Peak
RBW	For 6 dB Bandwidth: 100 kHz For 99 % Occupied Bandwidth: 1 % to 5 % of the occupied bandwidth
VBW	For 6 dB Bandwidth: ≥3 × RBW For 99 % Occupied Bandwidth: ≥3 × RBW
Trace	Max hold
Sweep	Auto couple

a) Use the 99 % power bandwidth function of the instrument, allow the trace to stabilize and report the measured bandwidth.

b) Allow the trace to stabilize and measure the maximum width of the emission that is constrained by the frequencies associated with the two outermost amplitude points (upper and lower frequencies) that are attenuated by 6 dB relative to the maximum level measured in the fundamental emission.

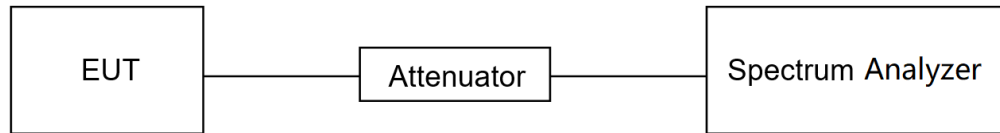
TEST SETUP**TEST ENVIRONMENT**

Temperature	22.8°C	Relative Humidity	58%
Atmosphere Pressure	101kPa	Test Voltage	AC 120V 60Hz

TEST DATE / ENGINEER

Test Date	March 21, 2025	Test By	Walker Yuan
-----------	----------------	---------	-------------

TEST RESULTS

Please refer to section "Test Data" - Appendix A & B

7.3. POWER SPECTRAL DENSITY

LIMITS

CFR 47 FCC Part15 (15.247) Subpart C			
Section	Test Item	Limit	Frequency Range (MHz)
CFR 47 FCC §15.247 (e)	Power Spectral Density	8 dBm in any 3 kHz band	2400-2483.5

TEST PROCEDURE

Refer to ANSI C63.10-2013 clause 11.10.2.

Connect the EUT to the spectrum analyzer and use the following settings:

Center Frequency	The center frequency of the channel under test
Detector	Peak
RBW	$3 \text{ kHz} \leq \text{RBW} \leq 100 \text{ kHz}$
VBW	$\geq 3 \times \text{RBW}$
Span	$1.5 \times \text{DTS bandwidth}$
Trace	Max hold
Sweep time	Auto couple

Allow trace to fully stabilize and use the peak marker function to determine the maximum amplitude level within the RBW.

If measured value exceeds limit, reduce RBW (no less than 3 kHz) and repeat.

TEST SETUP

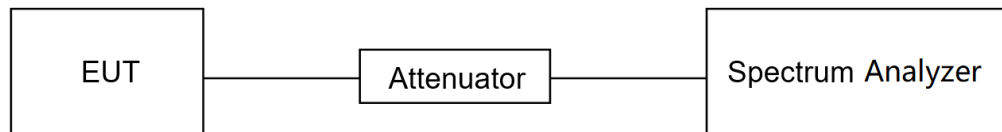

TEST ENVIRONMENT

Temperature	22.8°C	Relative Humidity	58%
Atmosphere Pressure	101kPa	Test Voltage	AC 120V 60Hz

TEST DATE / ENGINEER

Test Date	March 21, 2025	Test By	Walker Yuan
-----------	----------------	---------	-------------

TEST RESULTS

Please refer to section "Test Data" - Appendix D

7.4. CONDUCTED BAND EDGE AND SPURIOUS EMISSION

LIMITS

CFR 47 FCC Part15 (15.247) Subpart C		
Section	Test Item	Limit
CFR 47 FCC §15.247 (d)	Conducted Bandedge and Spurious Emissions	at least 20 dB below that in the 100 kHz bandwidth within the band that contains the highest level of the desired power

TEST PROCEDURE

Refer to ANSI C63.10-2013 clause 11.11 and 11.13.

Connect the EUT to the spectrum analyzer and use the following settings for reference level measurement:

Center Frequency	The center frequency of the channel under test
Detector	Peak
RBW	100 kHz
VBW	$\geq 3 \times \text{RBW}$
Span	1.5 x DTS bandwidth
Trace	Max hold
Sweep time	Auto couple.

Allow trace to fully stabilize and use the peak marker function to determine the maximum PSD level.

Change the settings for emission level measurement:

Span	Set the center frequency and span to encompass frequency range to be measured
Detector	Peak
RBW	100 kHz
VBW	$\geq 3 \times \text{RBW}$
measurement points	$\geq \text{span}/\text{RBW}$
Trace	Max hold
Sweep time	Auto couple.

Allow trace to fully stabilize and use the peak marker function to determine the maximum PSD level. Ensure that the amplitude of all unwanted emissions outside of the authorized frequency band (excluding restricted frequency bands) is attenuated by at least the minimum requirements specified in 11.11.

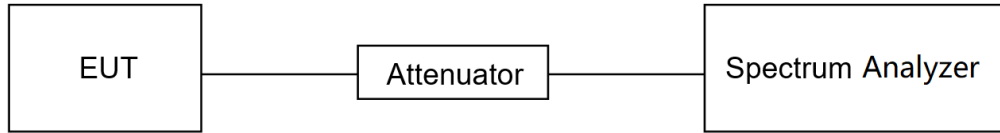
TEST SETUP**TEST ENVIRONMENT**

Temperature	21.6°C	Relative Humidity	55.3%
Atmosphere Pressure	101kPa	Test Voltage	AC 120V 60Hz

TEST DATE / ENGINEER

Test Date	June 24, 2025	Test By	Walker Yuan
-----------	---------------	---------	-------------

TEST RESULTS

Please refer to section "Test Data" - Appendix E & F

7.5. DUTY CYCLE

LIMITS

None; for reporting purposes only.

TEST PROCEDURE

Refer to ANSI C63.10-2013 clause 11.6 Zero – Span Spectrum Analyzer method.

TEST SETUP

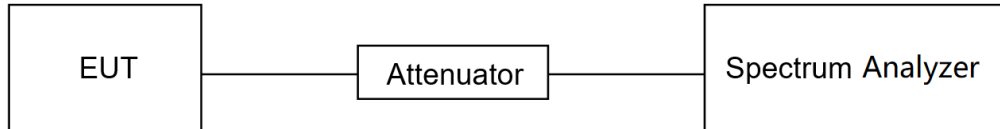

TEST ENVIRONMENT

Temperature	21.6°C	Relative Humidity	55.3%
Atmosphere Pressure	101kPa	Test Voltage	AC 120V 60Hz

TEST DATE / ENGINEER

Test Date	June 24, 2025	Test By	Walker Yuan
-----------	---------------	---------	-------------

TEST RESULTS

Please refer to section "Test Data" - Appendix G

8. RADIATED TEST RESULTS

LIMITS

Please refer to CFR 47 FCC §15.205 and §15.209.

Radiation Disturbance Test Limit for FCC (Class B) (9 kHz ~ 1 GHz)

Emissions radiated outside of the specified frequency bands above 30 MHz			
Frequency Range (MHz)	Field Strength Limit ($\mu\text{V}/\text{m}$) at 3 m	Field Strength Limit (dB $\mu\text{V}/\text{m}$) at 3 m	
		Quasi-Peak	
30 - 88	100	40	
88 - 216	150	43.5	
216 - 960	200	46	
Above 960	500	54	
Above 1000	500	Peak	Average
		74	54

FCC Emissions radiated outside of the specified frequency bands below 30 MHz		
Frequency (MHz)	Field strength (microvolts/meter)	Measurement distance (meters)
0.009-0.490	2400/F(kHz)	300
0.490-1.705	24000/F(kHz)	30
1.705-30.0	30	30

FCC Restricted bands of operation refer to FCC §15.205 (a):

MHz	MHz	MHz	GHz
0.090-0.110	16.42-16.423	399.9-410	4.5-5.15
¹ 0.495-0.505	16.69475-16.69525	608-614	5.35-5.46
2.1735-2.1905	16.80425-16.80475	960-1240	7.25-7.75
4.125-4.128	25.5-25.67	1300-1427	8.025-8.5
4.17725-4.17775	37.5-38.25	1435-1626.5	9.0-9.2
4.20725-4.20775	73-74.6	1645.5-1646.5	9.3-9.5
6.215-6.218	74.8-75.2	1660-1710	10.6-12.7
6.26775-6.26825	108-121.94	1718.8-1722.2	13.25-13.4
6.31175-6.31225	123-138	2200-2300	14.47-14.5
8.291-8.294	149.9-150.05	2310-2390	15.35-16.2
8.362-8.366	156.52475-156.52525	2483.5-2500	17.7-21.4
8.37625-8.38675	156.7-156.9	2690-2900	22.01-23.12
8.41425-8.41475	162.0125-167.17	3260-3267	23.6-24.0
12.29-12.293	167.72-173.2	3332-3339	31.2-31.8
12.51975-12.52025	240-285	3345.8-3358	36.43-36.5
12.57675-12.57725	322-335.4	3600-4400	(²)
13.36-13.41			

Note: ¹Until February 1, 1999, this restricted band shall be 0.490-0.510 MHz.

²Above 38.6c

TEST PROCEDURE

Below 30 MHz

The setting of the spectrum analyzer

RBW	200 Hz (From 9 kHz to 0.15 MHz)/ 9 kHz (From 0.15 MHz to 30 MHz)
VBW	200 Hz (From 9 kHz to 0.15 MHz)/ 9 kHz (From 0.15 MHz to 30 MHz)
Sweep	Auto

1. The testing follows the guidelines in ANSI C63.10-2013 clause 6.4.
2. The EUT was arranged to its worst case and then turntable (from 0 degree to 360 degrees) to find the maximum reading. A pre-amp and a high pass filter are used for the test in order to get better signal level. Both Horizontal, Face-on and Face-off polarizations of the antenna are set to make the measurement.
3. The EUT was placed on a turntable with 80 cm above ground.
4. The EUT was set 3 meters from the interference receiving antenna, which was mounted on the top of a 1 m height antenna tower.
5. The radiated emission limits are based on measurements employing a CISPR quasi-peak detector except for the frequency bands 9-90 kHz, 110-490 kHz and above 1000 MHz Radiated emission limits in these three bands are based on measurements employing an average detector.
6. For measurement below 1 GHz, the initial step in collecting conducted emission data is a spectrum analyzer peak detector mode pre-scanning the measurement frequency range. Significant peaks are then marked and then Quasi Peak and average detector mode re-measured. If the emission level of the EUT measured by the peak detector is 3 dB lower than the applicable limit, the peak emission level will be reported. Otherwise, the emission measurement will be repeated using the quasi-peak and average detector and reported.

7. Although these tests were performed other than open field site, adequate comparison measurements were confirmed against 30m open field site. Therefore sufficient tests were made to demonstrate that the alternative site produces results that correlate with the ones of tests made in an open field site based on KDB 414788.

8. The limits in CFR 47, Part 15, Subpart C, paragraph 15.209 (a), are identical to those in RSS-GEN Section 8.9, Table 6, since the measurements are performed in terms of magnetic field strength and converted to electric field strength levels (as reported in the table) using the free space impedance of 377Ω . For example, the measurement frequency X kHz resulted in a level of Y dBuV/m, which is equivalent to $Y-51.5 = Z$ dBuA/m, which has the same margin, W dB, to the corresponding RSS-GEN Table 6 limit as it has to be 15.209(a) limit.

Below 1 GHz and above 30 MHz

The setting of the spectrum analyzer

RBW	120 kHz
VBW	300 kHz
Sweep	Auto
Detector	Peak/QP
Trace	Max hold

1. The testing follows the guidelines in ANSI C63.10-2013 clause 6.5.
2. The EUT was arranged to its worst case and then tune the antenna tower (from 1 m to 4 m) and turntable (from 0 degree to 360 degrees) to find the maximum reading. A pre-amp and a high pass filter are used for the test in order to get better signal level. Both horizontal and vertical polarizations of the antenna are set to make the measurement.
3. The EUT was placed on a turntable with 80 cm above ground.
4. The EUT was set 3 meters from the interference receiving antenna, which was mounted on the top of a variable height antenna tower.
5. For measurement below 1 GHz, the initial step in collecting conducted emission data is a spectrum analyzer peak detector mode pre-scanning the measurement frequency range. Significant peaks are then marked and then Quasi Peak detector mode re-measured. If the emission level of the EUT measured by the peak detector is 3 dB lower than the applicable limit, the peak emission level will be reported. Otherwise, the emission measurement will be repeated using the quasi-peak detector and reported.

Above 1 GHz

The setting of the spectrum analyzer

RBW	1 MHz
VBW	PEAK: 3 MHz AVG: see note 6
Sweep	Auto
Detector	Peak
Trace	Max hold

1. The testing follows the guidelines in ANSI C63.10-2013 clause 6.6.
2. The EUT was arranged to its worst case and then tune the antenna tower (from 1 m to 4 m) and turntable (from 0 degree to 360 degrees) to find the maximum reading. A pre-amp and a high pass filter are used for the test in order to get better signal level. Both horizontal and vertical polarizations of the antenna are set to make the measurement.
3. The EUT was placed on a turntable with 1.5 m above ground.
4. The EUT was set 3 meters from the interference receiving antenna, which was mounted on the top of a variable height antenna tower.
5. For measurement above 1 GHz, the emission measurement will be measured by the peak detector. This peak level, once corrected, must comply with the limit specified in Section 15.209.
6. For measurements above 1 GHz the resolution bandwidth is set to 1 MHz, then the video bandwidth is set to 3 MHz for peak measurements and 1 MHz resolution bandwidth with 1/T video bandwidth with peak detector for average measurements. For the Duty Cycle please refer to clause 7.5. ON TIME AND DUTY CYCLE.

X axis, Y axis, Z axis positions:

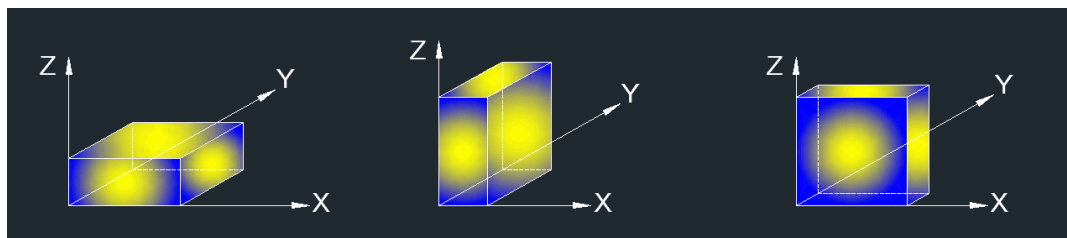

Note 1: For all radiated test, EUT in each of three orthogonal axis emissions had been tested, but only the worst case (X axis) data recorded in the report.

For Restricted Bandedge:

Note:

1. Measurement = Reading Level + Correct Factor.
2. If the peak values are less than the average limit of 54 dBuV/m, the average result is deemed to comply with average limit.
3. PK=Peak: Peak detector.
4. AV=Average: VBW=1/Ton, where: Ton is the transmitting duration.
5. For the transmitting duration, please refer to clause 7.5.
6. Only the worst data was recorded, if it complies with the limit, the other emissions deemed to comply with the limit.
7. Both horizontal and vertical have been tested, only the worst data was recorded in the report.
8. All modes have been tested, but only the worst data was recorded in the report.

For Radiate Spurious emission (9 kHz ~ 30 MHz):

Note:

1. Measurement = Reading Level + Correct Factor.
2. If the peak values are less than the QP limit, the QP result is deemed to comply with QP limit.
3. All 3 polarizations (Horizontal, Face-on and Face-off) of the loop antenna had been tested, but only the worst data recorded in the report.
4. All modes have been tested, but only the worst data was recorded in the report.
5. $\text{dBuA/m} = \text{dBuV/m} - 20\text{Log}_{10}[120\pi] = \text{dBuV/m} - 51.5$

For Radiate Spurious Emission (30 MHz ~ 1 GHz):

Note:

1. Result Level = Read Level + Correct Factor.
2. If the peak values are less than the QP limit, the QP result is deemed to comply with QP limit.
3. All modes have been tested, but only the worst data was recorded in the report.

For Radiate Spurious Emission (1 GHz ~ 3 GHz):

Note:

1. Measurement = Reading Level + Correct Factor.
2. If the peak values are less than the average limit of 54 dBuV/m, the average result is deemed to comply with average limit.
3. Peak: Peak detector.
4. AVG: VBW=1/Ton, where: Ton is the transmitting duration.
5. For the transmitting duration, please refer to clause 7.5.
6. Filter losses were only considered in the spurious frequency bands and the authorized band was not corrected for Band reject filter losses.
7. Proper operation of the transmitter prior to adding the filter to the measurement chain.
8. All modes have been tested, but only the worst data was recorded in the report.

For Radiate Spurious Emission (3 GHz ~ 18 GHz):

Note:

1. Peak Result = Reading Level + Correct Factor.
2. If the peak values are less than the average limit of 54 dBuV/m, the average result is deemed to comply with average limit.
3. Peak: Peak detector.
4. AVG: $VBW=1/T_{on}$, where: T_{on} is the transmitting duration.
5. For the transmitting duration, please refer to clause 7.5.
6. Filter losses were only considered in the spurious frequency bands and the authorized band was not corrected for High Pass Filter losses.
7. Proper operation of the transmitter prior to adding the filter to the measurement chain.
8. All modes have been tested, but only the worst data was recorded in the report.

For Radiate Spurious emission (18 GHz ~ 26 GHz):

Note:

1. Measurement = Reading Level + Correct Factor.
2. If the peak values are less than the average limit of 54 dBuV/m, the average result is deemed to comply with average limit.
3. Peak: Peak detector.
4. All modes have been tested, but only the worst data was recorded in the report.

TEST SETUP

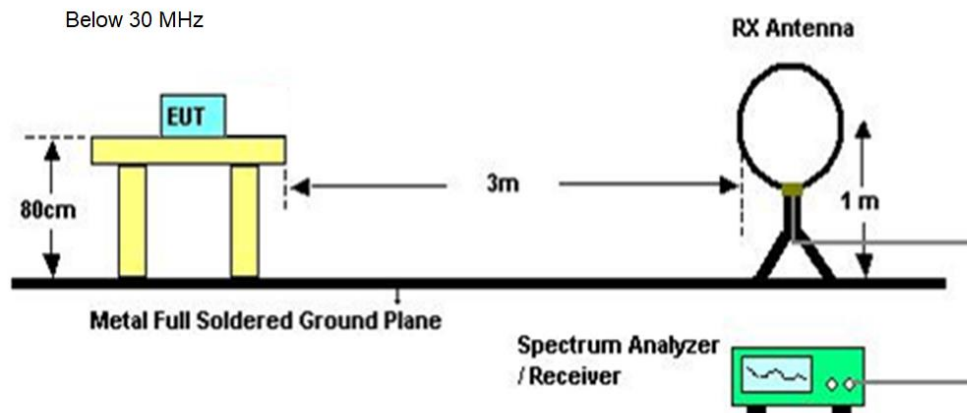

Below 1 GHz and above 30 MHz

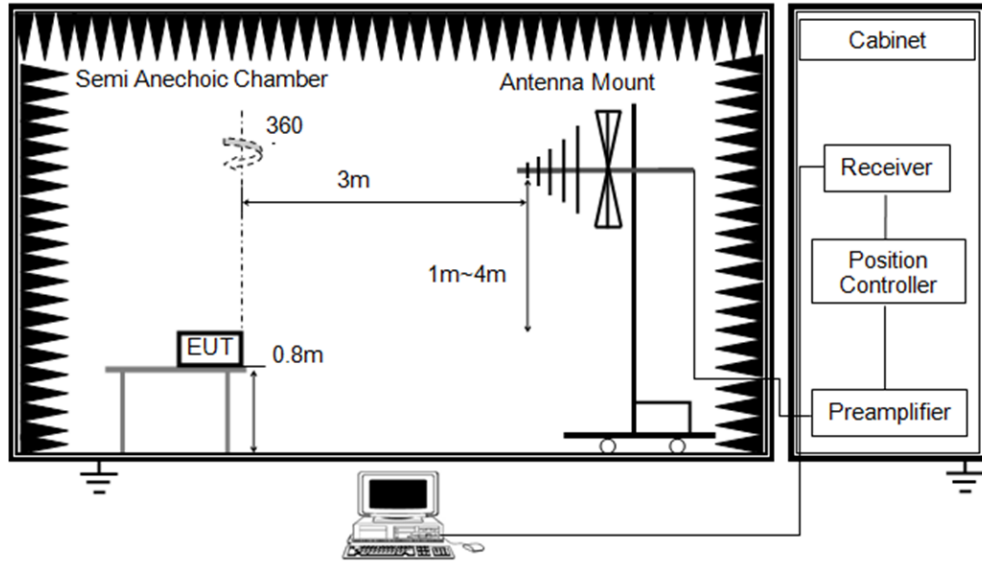

Above 1GHz

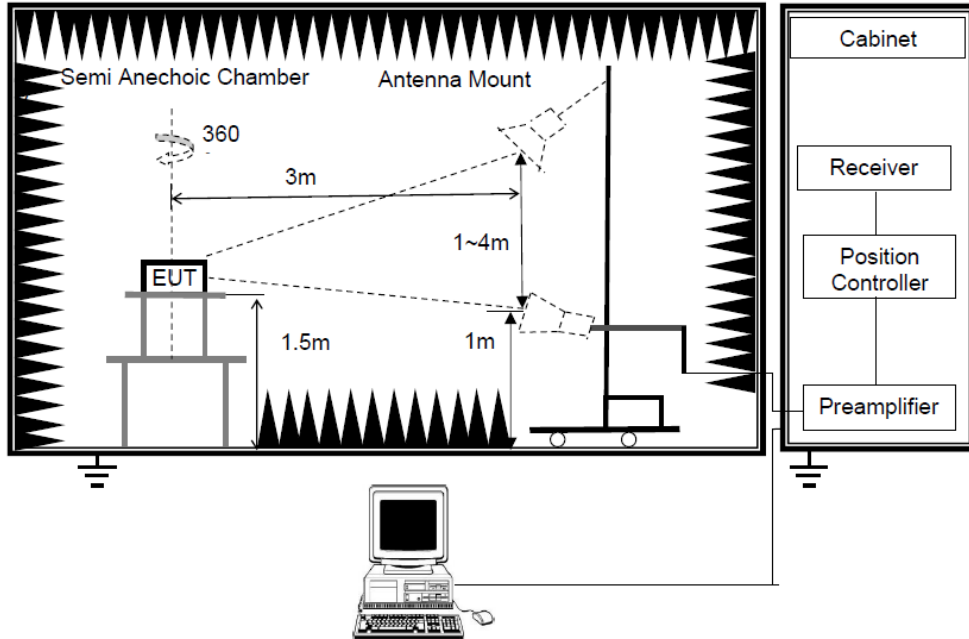

TEST ENVIRONMENT

Temperature	21.6°C	Relative Humidity	57.5%
Atmosphere Pressure	101kPa	Test Voltage	

TEST DATE / ENGINEER

Test Date	June 26, 2025	Test By	Mason Wang
-----------	---------------	---------	------------

TEST RESULTS

8.1. RESTRICTED BANDEDGE

Test Mode:	BLE 1M PK	Frequency(MHz):	2402
Polarity:	Horizontal	Test Voltage:	AC 120V_60Hz

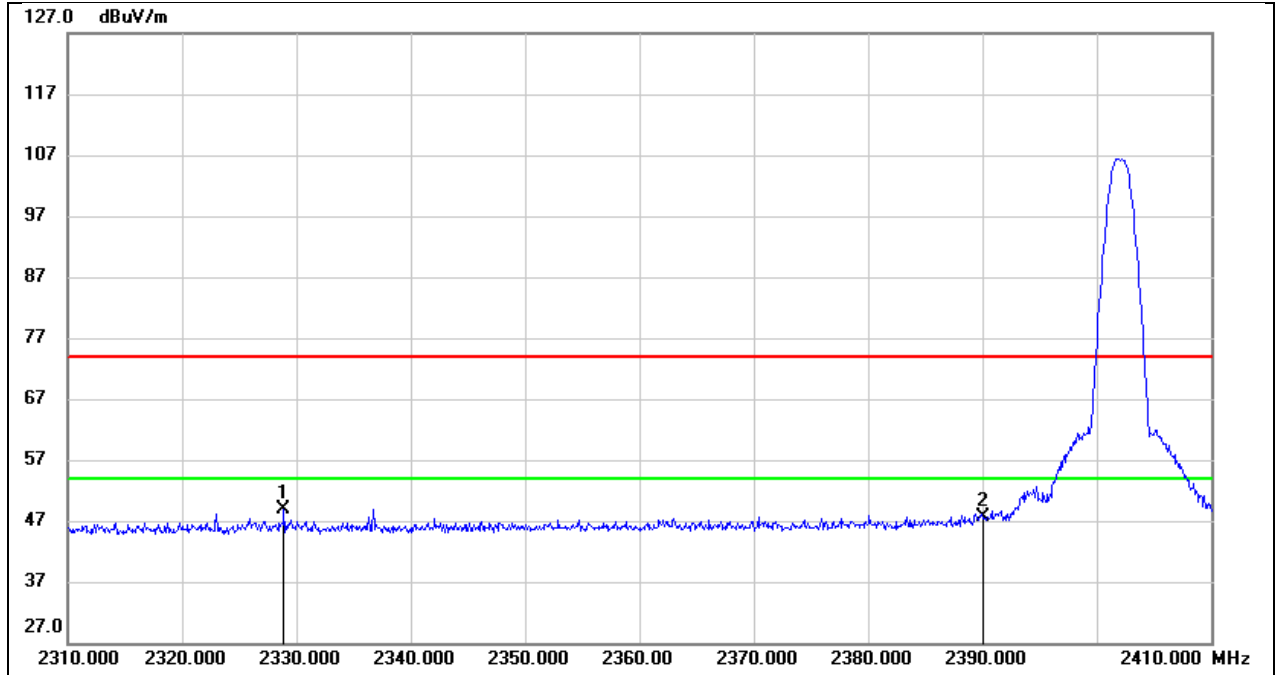

No.	Frequency (MHz)	Reading (dBuV)	Correct (dB/m)	Result (dBuV/m)	Limit (dBuV/m)	Margin (dB)	Remark
1	2328.900	17.48	31.50	48.98	74.00	-25.02	peak
2	2390.000	15.83	31.73	47.56	74.00	-26.44	peak

Test Mode:	BLE 1M PK	Frequency(MHz):	2402
Polarity:	Vertical	Test Voltage:	AC 120V_60Hz

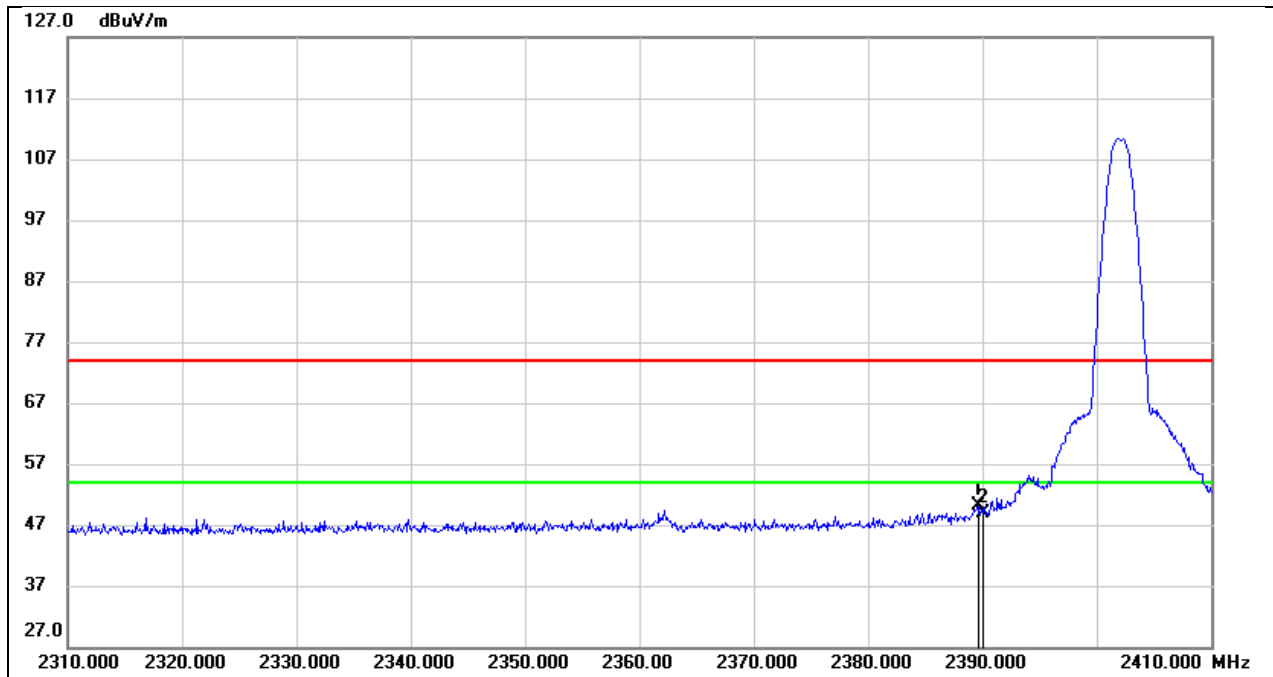

No.	Frequency (MHz)	Reading (dBuV)	Correct (dB/m)	Result (dBuV/m)	Limit (dBuV/m)	Margin (dB)	Remark
1	2389.600	17.50	32.55	50.05	74.00	-23.95	peak
2	2390.000	16.23	32.55	48.78	74.00	-25.22	peak

Test Mode:	BLE 1M PK	Frequency(MHz):	2480
Polarity:	Vertical	Test Voltage:	AC 120V_60Hz

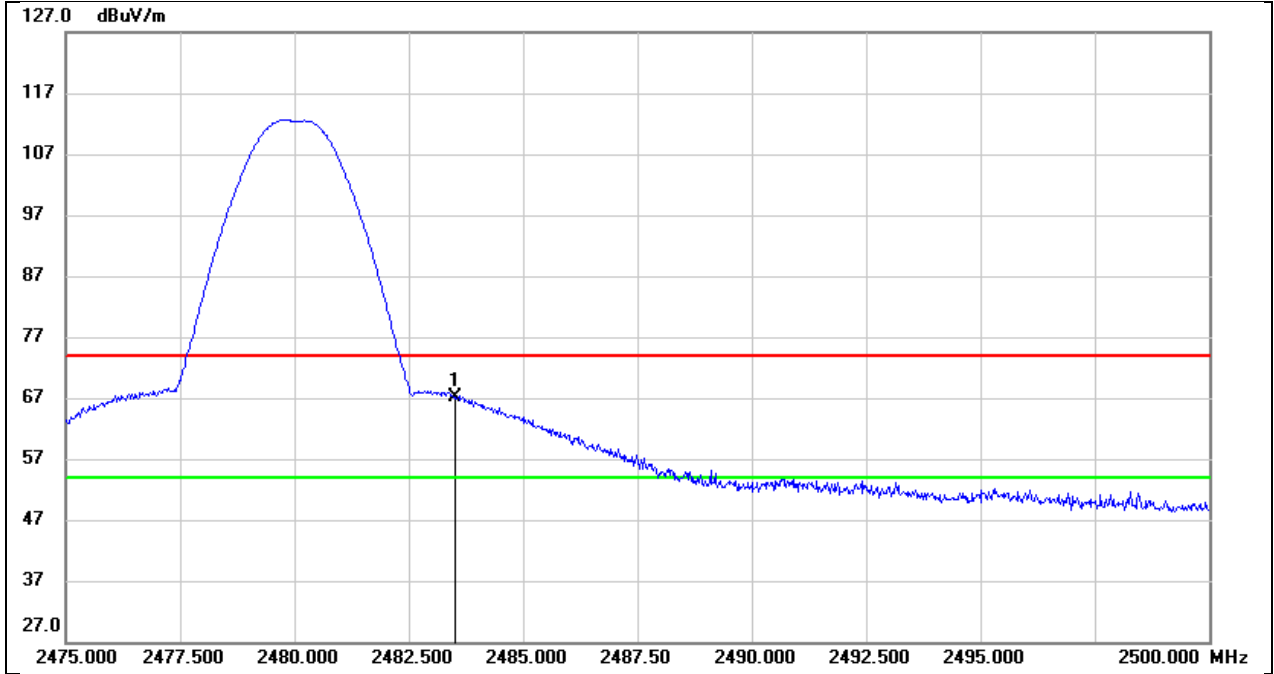

No.	Frequency (MHz)	Reading (dBuV)	Correct (dB/m)	Result (dBuV/m)	Limit (dBuV/m)	Margin (dB)	Remark
1	2483.500	34.28	32.80	67.08	74.00	-6.92	peak

Test Mode:	BLE 1M AV	Frequency(MHz):	2480
Polarity:	Vertical	Test Voltage:	AC 120V_60Hz

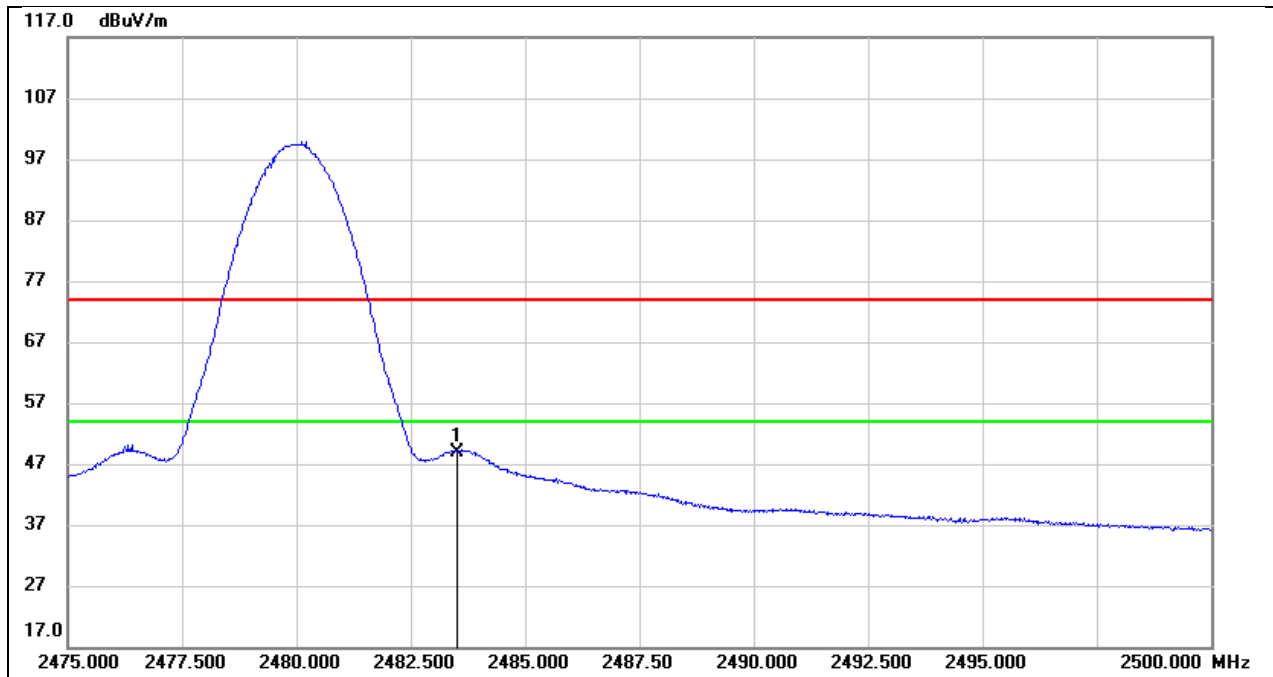

No.	Frequency (MHz)	Reading (dBuV)	Correct (dB/m)	Result (dBuV/m)	Limit (dBuV/m)	Margin (dB)	Remark
1	2483.500	16.15	32.80	48.95	54.00	-5.05	AVG

8.2. SPURIOUS EMISSIONS(1 GHZ~3 GHZ)

Test Mode:	BLE 1M	Frequency(MHz):	2402
Polarity:	Horizontal	Test Voltage:	AC 120V_60Hz

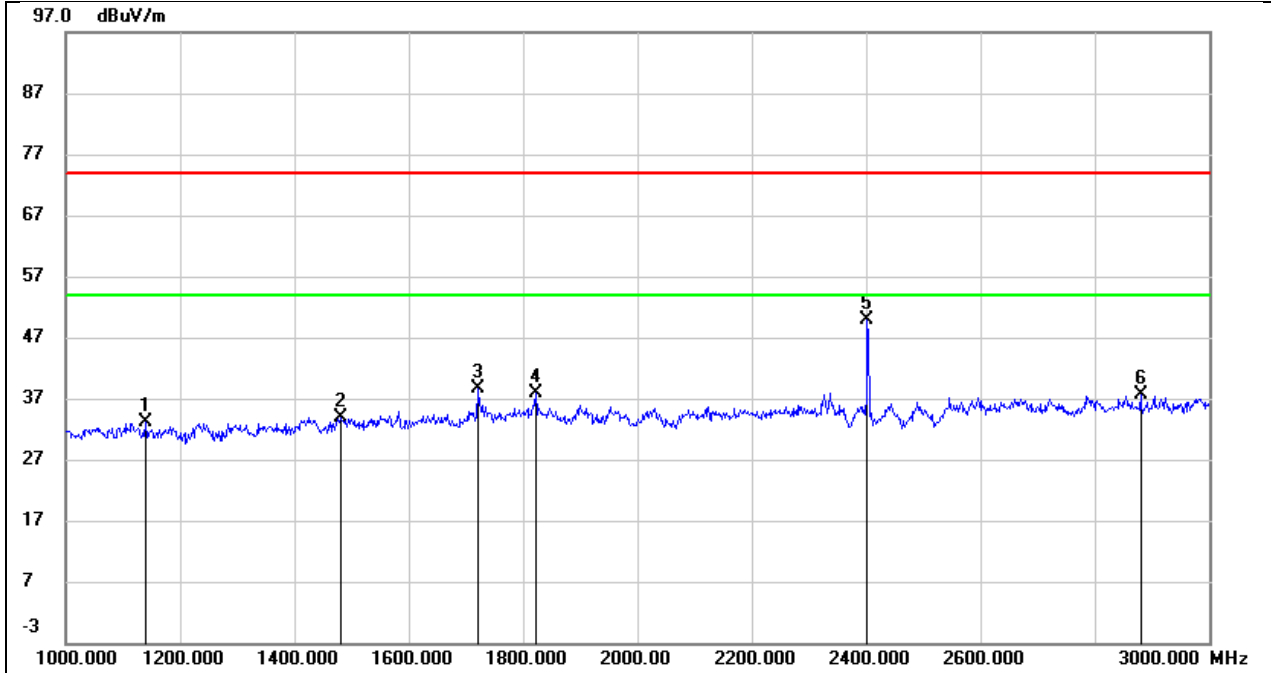

No.	Frequency (MHz)	Reading (dBuV)	Correct (dB/m)	Result (dBuV/m)	Limit (dBuV/m)	Margin (dB)	Remark
1	1140.000	46.86	-13.76	33.10	74.00	-40.90	peak
2	1482.000	45.82	-11.98	33.84	74.00	-40.16	peak
3	1720.000	49.17	-10.54	38.63	74.00	-35.37	peak
4	1822.000	47.82	-9.98	37.84	74.00	-36.16	peak
5	2402.000	58.39	-8.59	49.80	/	/	Fundamental
6	2880.000	44.10	-6.55	37.55	74.00	-36.45	peak

Test Mode:	BLE 1M	Frequency(MHz):	2402
Polarity:	Vertical	Test Voltage:	AC 120V_60Hz

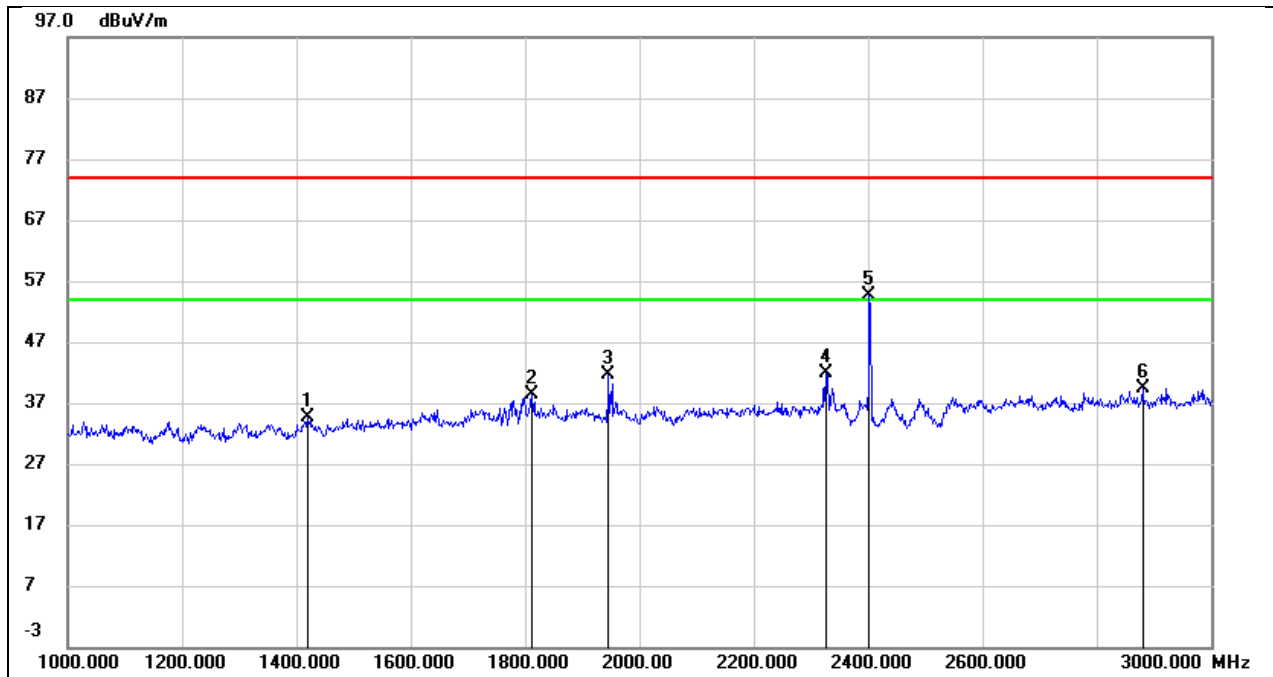

No.	Frequency (MHz)	Reading (dBuV)	Correct (dB/m)	Result (dBuV/m)	Limit (dBuV/m)	Margin (dB)	Remark
1	1420.000	46.71	-12.15	34.56	74.00	-39.44	peak
2	1812.000	47.69	-9.37	38.32	74.00	-35.68	peak
3	1946.000	50.87	-9.25	41.62	74.00	-32.38	peak
4	2326.000	49.80	-8.03	41.77	74.00	-32.23	peak
5	2402.000	62.40	-7.77	54.63	/	/	Fundamental
6	2880.000	44.73	-5.37	39.36	74.00	-34.64	peak

Test Mode:	BLE 1M	Frequency(MHz):	2440
Polarity:	Horizontal	Test Voltage:	AC 120V_60Hz

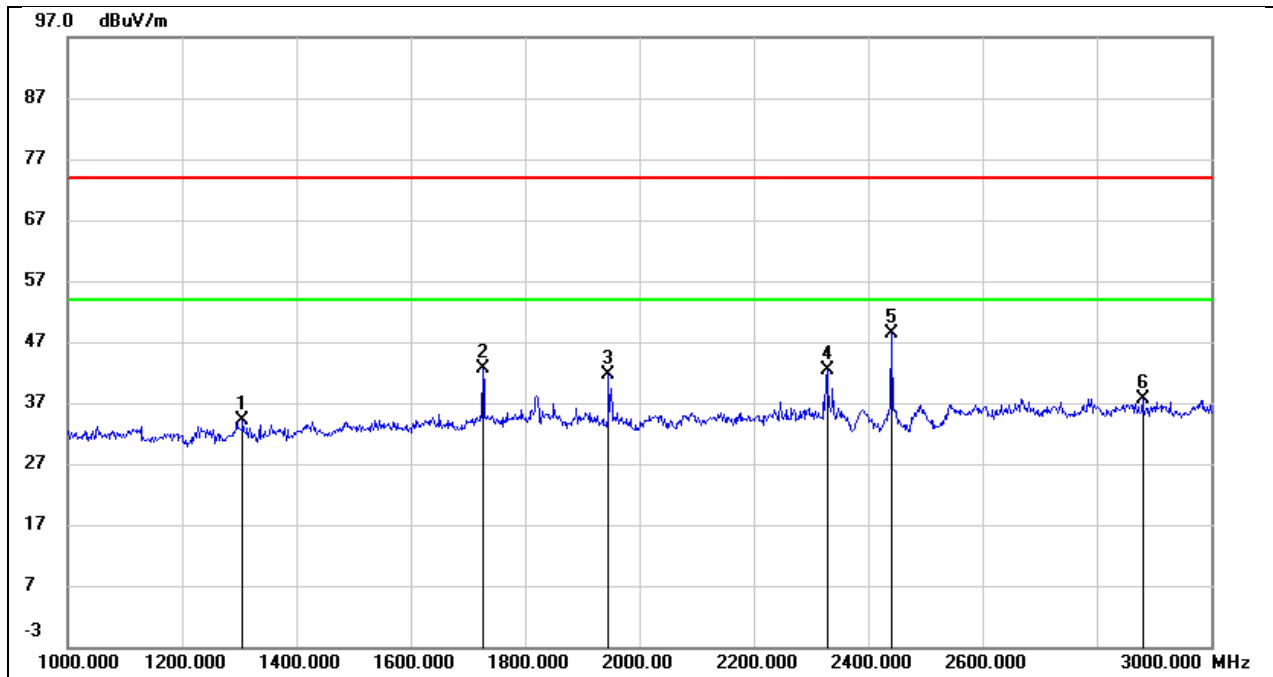

No.	Frequency (MHz)	Reading (dBuV)	Correct (dB/m)	Result (dBuV/m)	Limit (dBuV/m)	Margin (dB)	Remark
1	1306.000	47.11	-12.93	34.18	74.00	-39.82	peak
2	1726.000	53.01	-10.48	42.53	74.00	-31.47	peak
3	1946.000	51.59	-10.06	41.53	74.00	-32.47	peak
4	2328.000	51.14	-8.85	42.29	74.00	-31.71	peak
5	2440.000	56.93	-8.44	48.49	/	/	Fundamental
6	2880.000	44.23	-6.55	37.68	74.00	-36.32	peak

Test Mode:	BLE 1M	Frequency(MHz):	2440
Polarity:	Vertical	Test Voltage:	AC 120V_60Hz

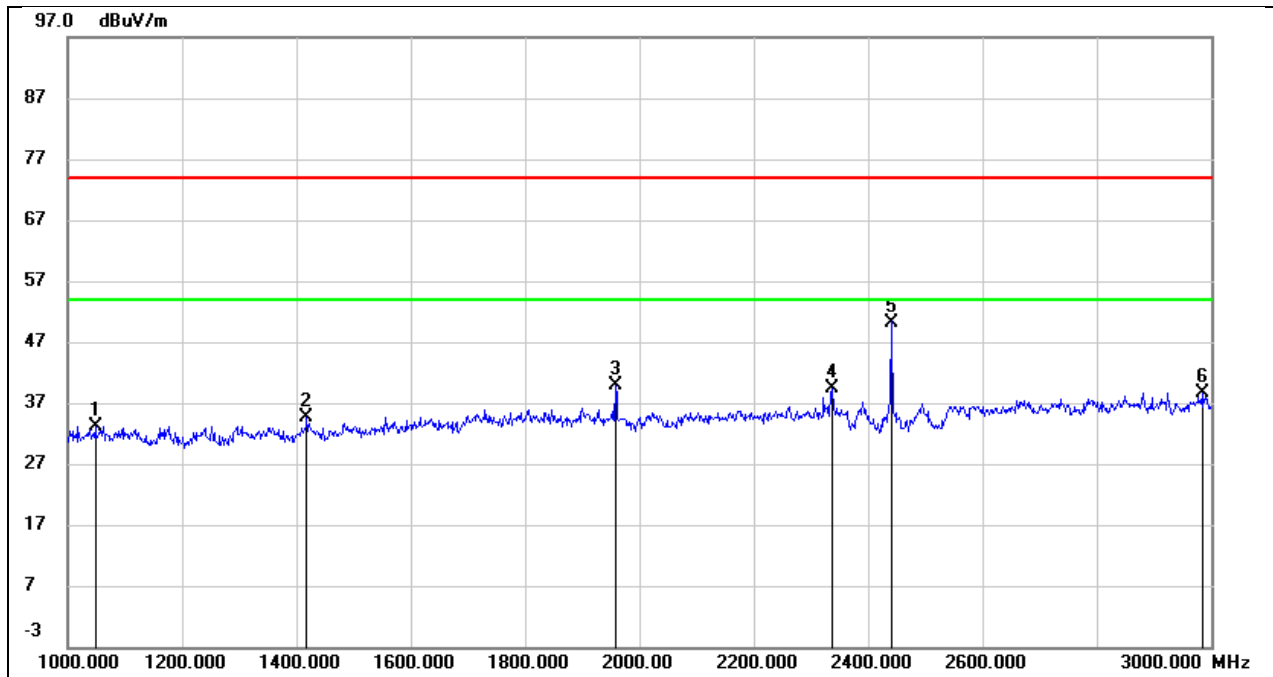

No.	Frequency (MHz)	Reading (dBuV)	Correct (dB/m)	Result (dBuV/m)	Limit (dBuV/m)	Margin (dB)	Remark
1	1048.000	46.80	-13.56	33.24	74.00	-40.76	peak
2	1418.000	46.71	-12.16	34.55	74.00	-39.45	peak
3	1958.000	49.03	-9.24	39.79	74.00	-34.21	peak
4	2336.000	47.41	-8.00	39.41	74.00	-34.59	peak
5	2440.000	57.88	-7.63	50.25	/	/	Fundamental
6	2984.000	43.54	-4.80	38.74	74.00	-35.26	peak

Test Mode:	BLE 1M	Frequency(MHz):	2480
Polarity:	Horizontal	Test Voltage:	AC 120V_60Hz

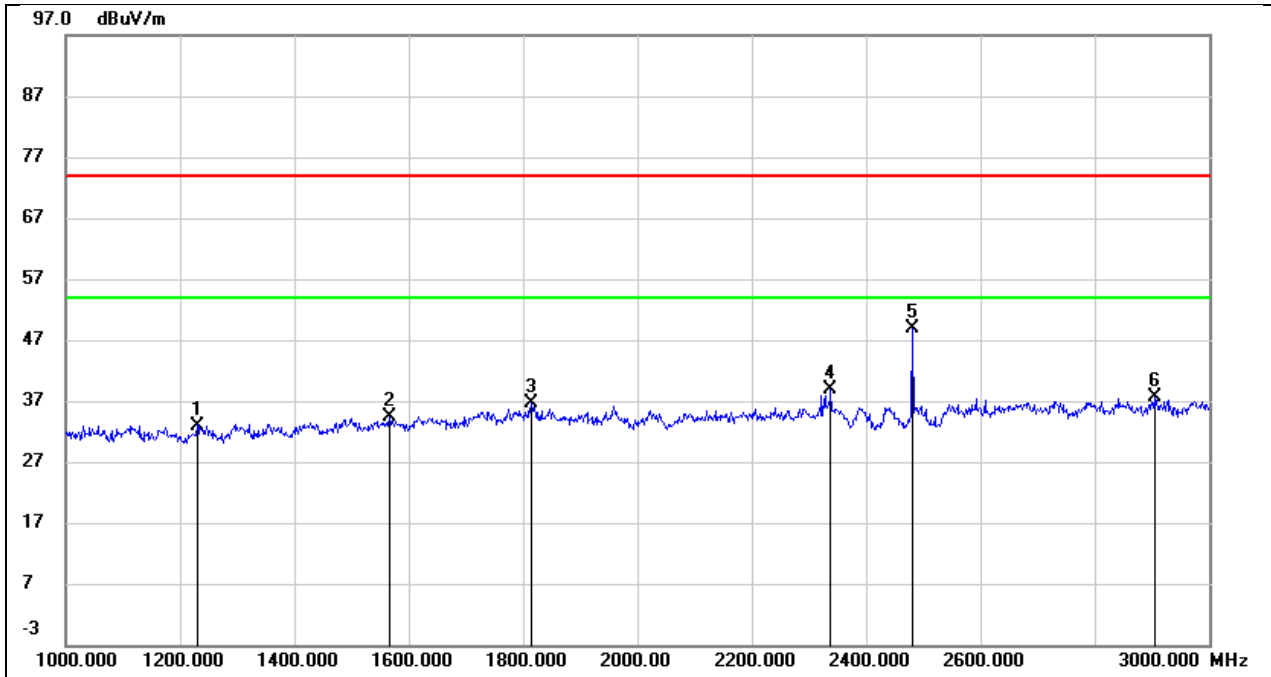

No.	Frequency (MHz)	Reading (dBuV)	Correct (dB/m)	Result (dBuV/m)	Limit (dBuV/m)	Margin (dB)	Remark
1	1230.000	46.31	-13.31	33.00	74.00	-41.00	peak
2	1566.000	45.91	-11.55	34.36	74.00	-39.64	peak
3	1814.000	46.68	-9.97	36.71	74.00	-37.29	peak
4	2338.000	47.76	-8.82	38.94	74.00	-35.06	peak
5	2480.000	57.21	-8.28	48.93	/	/	Fundamental
6	2904.000	44.04	-6.45	37.59	74.00	-36.41	peak

Test Mode:	BLE 1M	Frequency(MHz):	2480
Polarity:	Vertical	Test Voltage:	AC 120V_60Hz

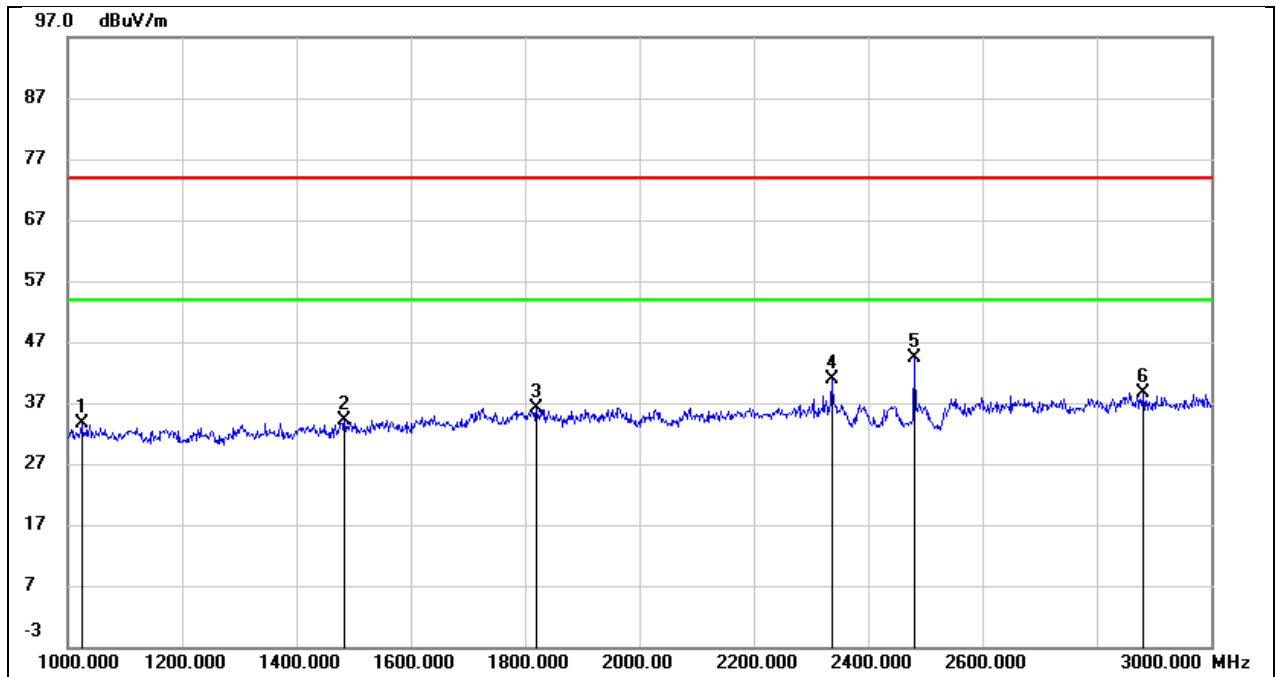

No.	Frequency (MHz)	Reading (dBuV)	Correct (dB/m)	Result (dBuV/m)	Limit (dBuV/m)	Margin (dB)	Remark
1	1024.000	47.22	-13.66	33.56	74.00	-40.44	peak
2	1484.000	45.98	-11.85	34.13	74.00	-39.87	peak
3	1820.000	45.60	-9.36	36.24	74.00	-37.76	peak
4	2336.000	48.82	-8.00	40.82	74.00	-33.18	peak
5	2480.000	51.87	-7.48	44.39	/	/	Fundamental
6	2882.000	44.09	-5.36	38.73	74.00	-35.27	peak

8.3. SPURIOUS EMISSIONS(3 GHZ~18 GHZ)

Test Mode:	BLE 1M	Frequency(MHz):	2402
Polarity:	Horizontal	Test Voltage:	AC 120V_60Hz

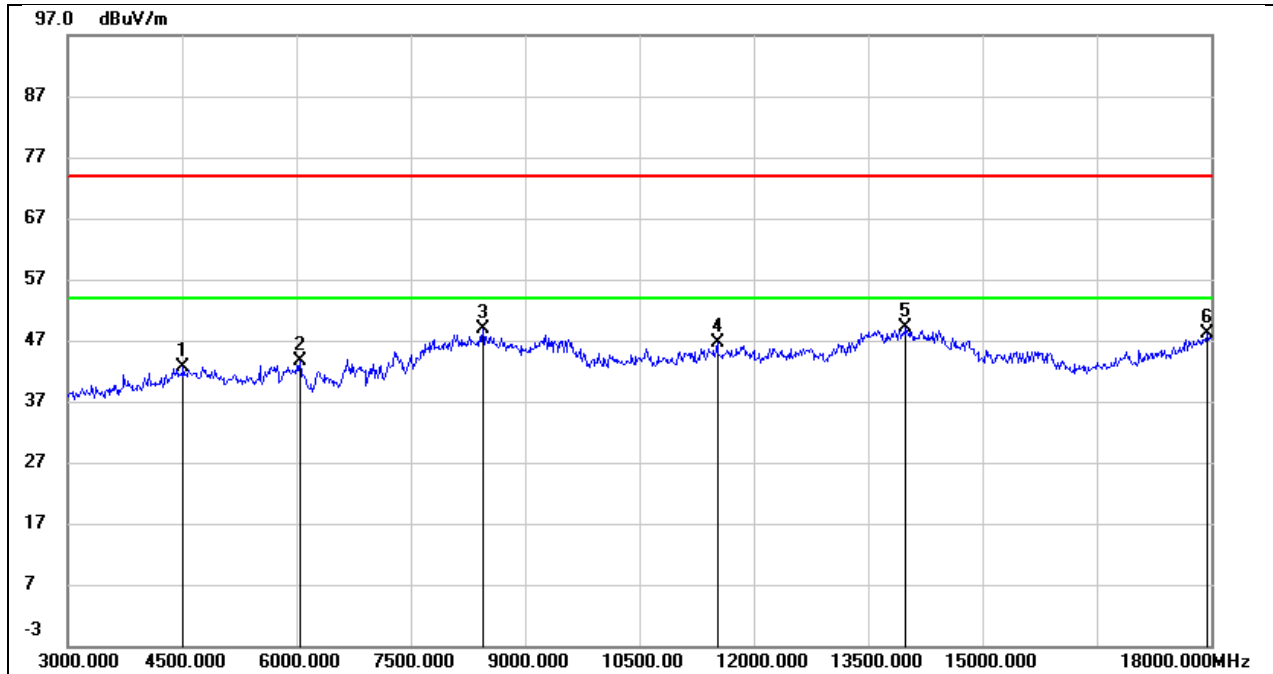

No.	Frequency (MHz)	Reading (dBuV)	Correct (dB/m)	Result (dBuV/m)	Limit (dBuV/m)	Margin (dB)	Remark
1	4515.000	42.97	-0.39	42.58	74.00	-31.42	peak
2	6045.000	40.21	3.33	43.54	74.00	-30.46	peak
3	8445.000	39.92	8.95	48.87	74.00	-25.13	peak
4	11520.000	28.55	18.01	46.56	74.00	-27.44	peak
5	13995.000	25.33	23.78	49.11	74.00	-24.89	peak
6	17955.000	18.84	29.18	48.02	74.00	-25.98	peak

Test Mode:	BLE 1M	Frequency(MHz):	2402
Polarity:	Vertical	Test Voltage:	AC 120V_60Hz

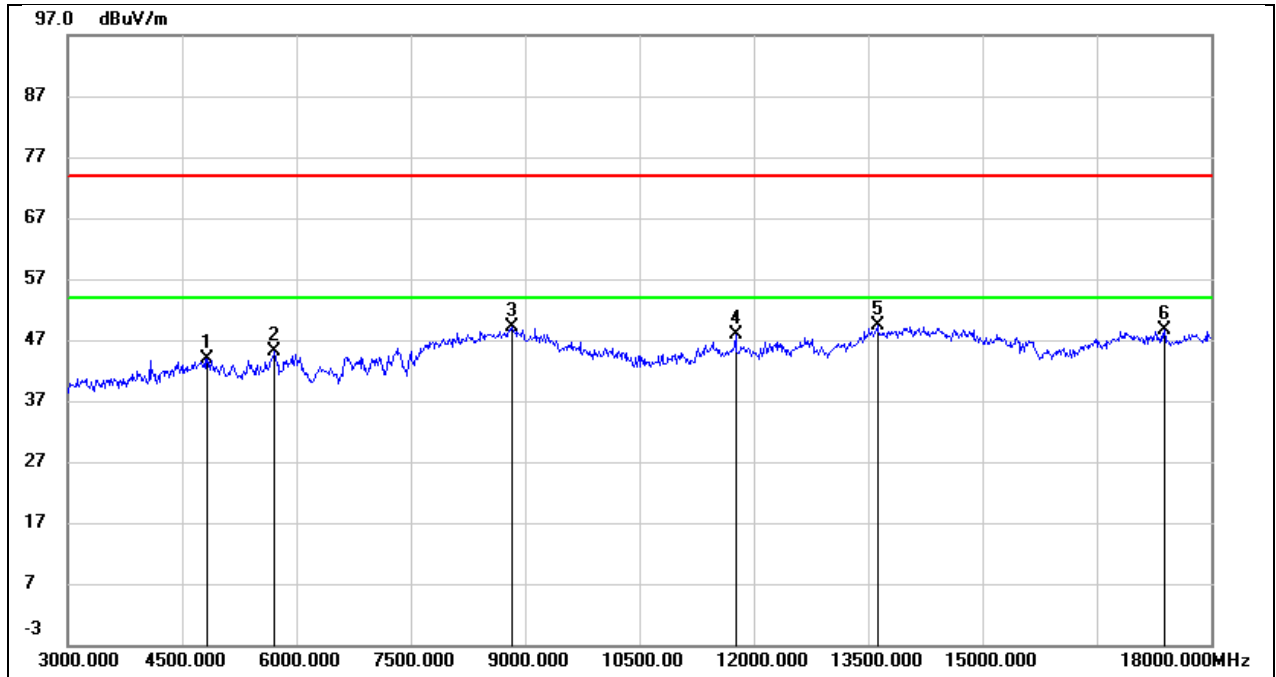

No.	Frequency (MHz)	Reading (dBuV)	Correct (dB/m)	Result (dBuV/m)	Limit (dBuV/m)	Margin (dB)	Remark
1	4830.000	42.32	1.64	43.96	74.00	-30.04	peak
2	5715.000	41.40	3.67	45.07	74.00	-28.93	peak
3	8835.000	39.11	10.14	49.25	74.00	-24.75	peak
4	11760.000	30.65	17.13	47.78	74.00	-26.22	peak
5	13620.000	28.45	20.97	49.42	74.00	-24.58	peak
6	17385.000	23.25	25.38	48.63	74.00	-25.37	peak

Test Mode:	BLE 1M	Frequency(MHz):	2440
Polarity:	Horizontal	Test Voltage:	AC 120V_60Hz

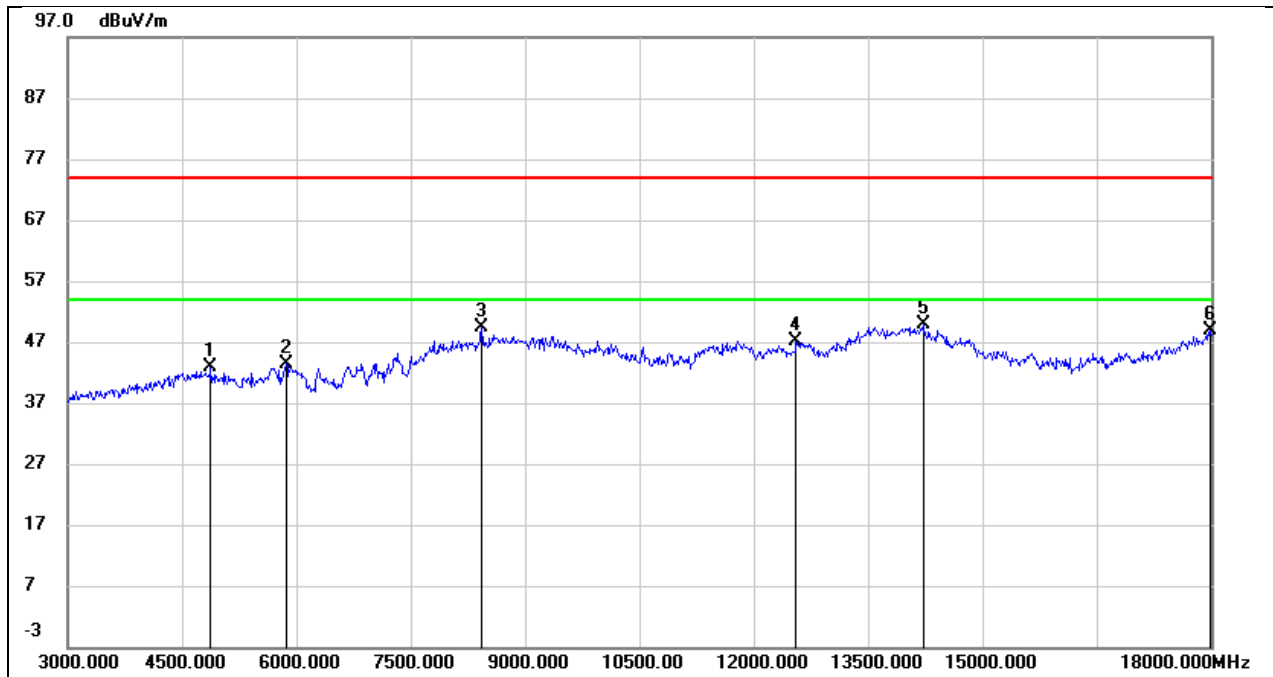

No.	Frequency (MHz)	Reading (dBuV)	Correct (dB/m)	Result (dBuV/m)	Limit (dBuV/m)	Margin (dB)	Remark
1	4875.000	42.17	0.65	42.82	74.00	-31.18	peak
2	5865.000	40.43	2.86	43.29	74.00	-30.71	peak
3	8430.000	40.35	8.93	49.28	74.00	-24.72	peak
4	12555.000	28.29	18.94	47.23	74.00	-26.77	peak
5	14220.000	26.72	23.25	49.97	74.00	-24.03	peak
6	17985.000	19.37	29.49	48.86	74.00	-25.14	peak

Test Mode:	BLE 1M	Frequency(MHz):	2440
Polarity:	Vertical	Test Voltage:	AC 120V_60Hz

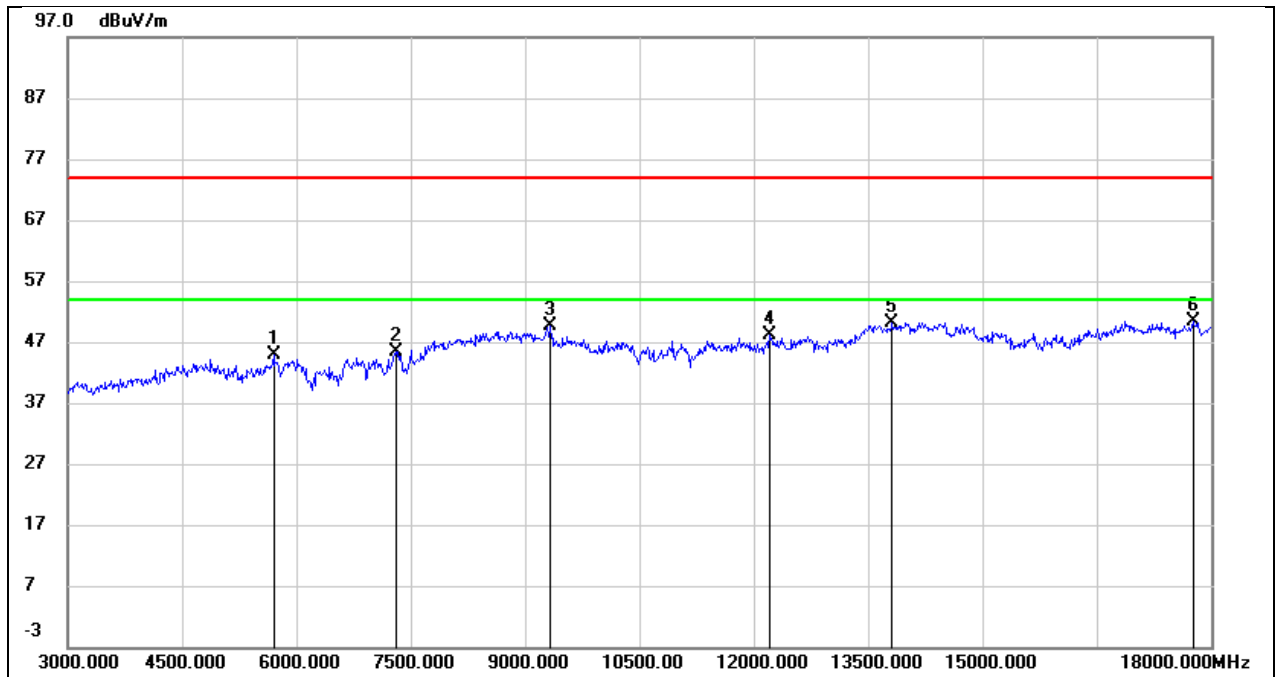

No.	Frequency (MHz)	Reading (dBuV)	Correct (dB/m)	Result (dBuV/m)	Limit (dBuV/m)	Margin (dB)	Remark
1	5700.000	41.19	3.65	44.84	74.00	-29.16	peak
2	7305.000	37.74	7.68	45.42	74.00	-28.58	peak
3	9330.000	37.84	11.78	49.62	74.00	-24.38	peak
4	12210.000	30.41	17.72	48.13	74.00	-25.87	peak
5	13815.000	28.80	21.36	50.16	74.00	-23.84	peak
6	17760.000	24.29	26.16	50.45	74.00	-23.55	peak

Test Mode:	BLE 1M	Frequency(MHz):	2480
Polarity:	Horizontal	Test Voltage:	AC 120V_60Hz

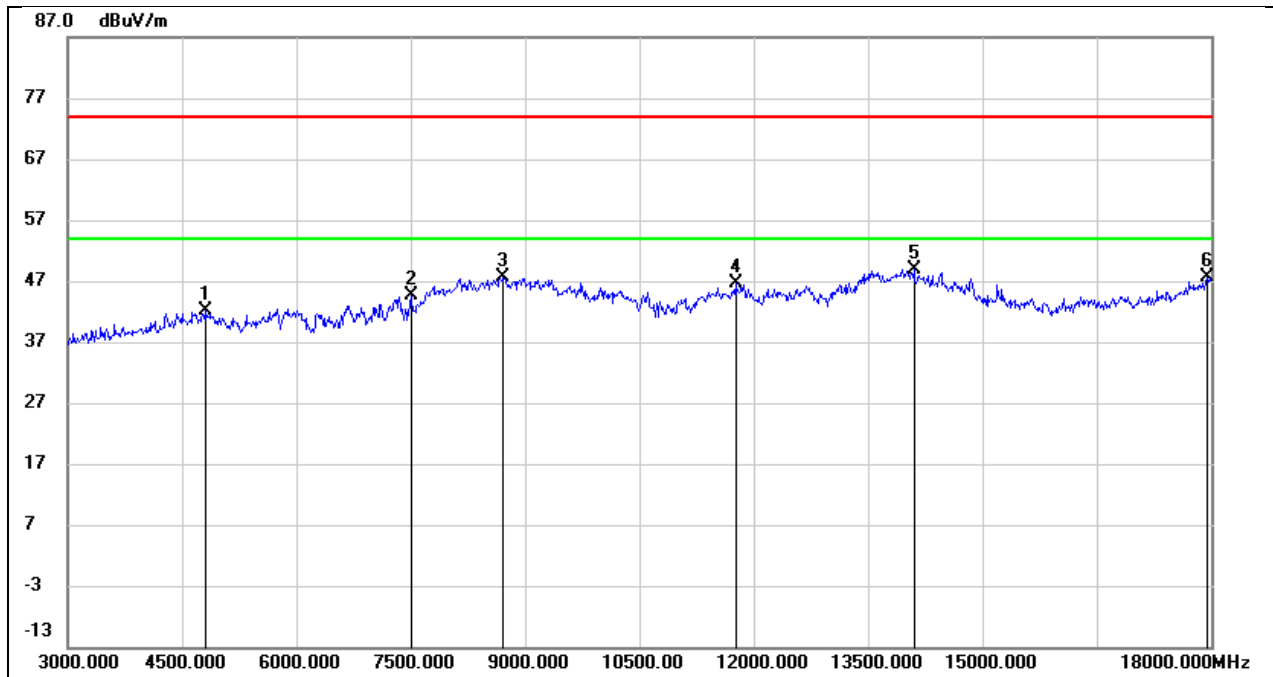

No.	Frequency (MHz)	Reading (dBuV)	Correct (dB/m)	Result (dBuV/m)	Limit (dBuV/m)	Margin (dB)	Remark
1	4800.000	41.64	0.47	42.11	74.00	-31.89	peak
2	7500.000	37.29	7.39	44.68	74.00	-29.32	peak
3	8715.000	38.12	9.46	47.58	74.00	-26.42	peak
4	11760.000	28.21	18.42	46.63	74.00	-27.37	peak
5	14100.000	25.29	23.57	48.86	74.00	-25.14	peak
6	17940.000	18.71	29.03	47.74	74.00	-26.26	peak

Test Mode:	BLE 1M	Frequency(MHz):	2480
Polarity:	Vertical	Test Voltage:	AC 120V_60Hz

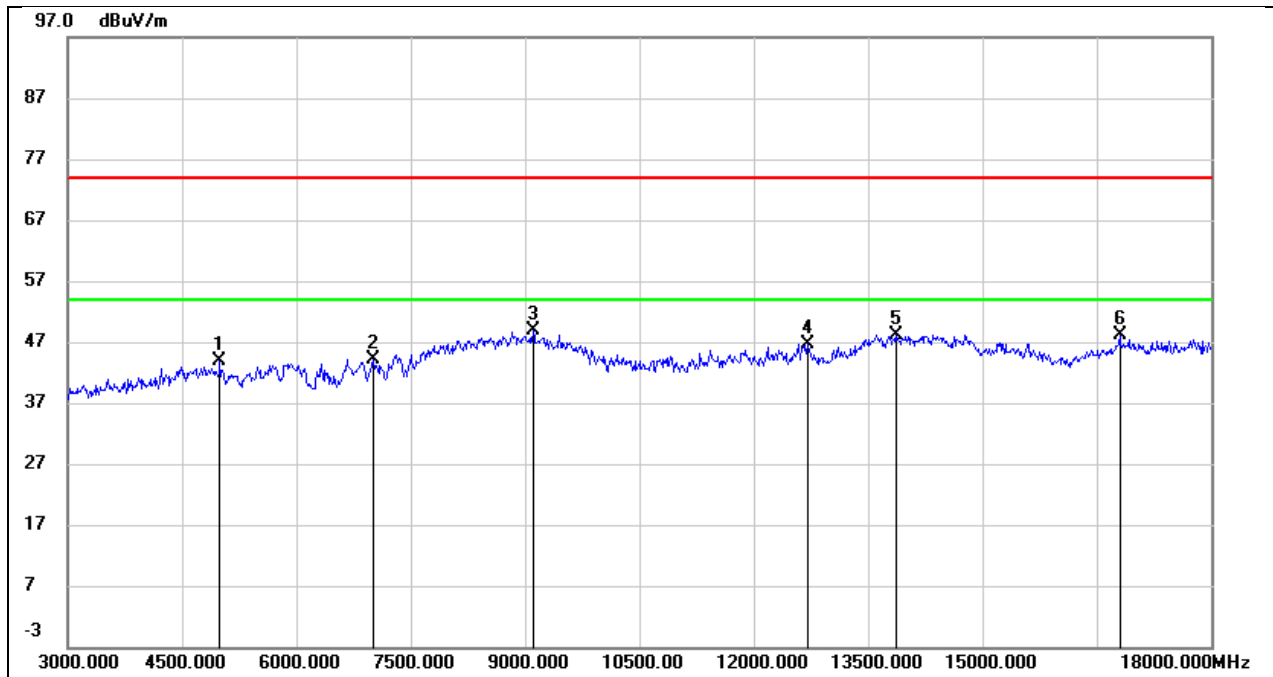

No.	Frequency (MHz)	Reading (dBuV)	Correct (dB/m)	Result (dBuV/m)	Limit (dBuV/m)	Margin (dB)	Remark
1	4995.000	41.75	2.14	43.89	74.00	-30.11	peak
2	7005.000	36.98	7.26	44.24	74.00	-29.76	peak
3	9105.000	37.81	10.97	48.78	74.00	-25.22	peak
4	12705.000	28.46	18.22	46.68	74.00	-27.32	peak
5	13860.000	26.65	21.56	48.21	74.00	-25.79	peak
6	16800.000	23.14	24.93	48.07	74.00	-25.93	peak

8.4. SPURIOUS EMISSIONS(9 KHZ~30 MHZ)

Test Mode:	BLE 1M	Frequency(MHz):	2480
Polarity:	Horizontal	Test Voltage:	AC 120V_60Hz

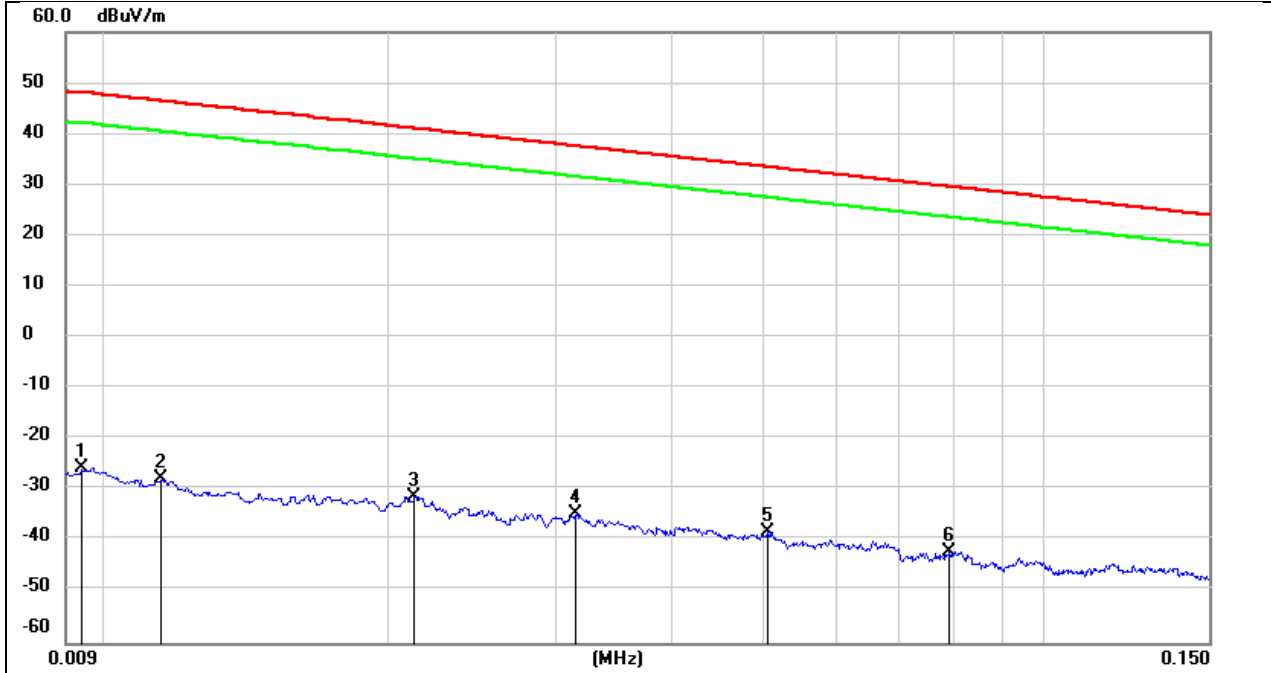

No.	Frequency (MHz)	Reading (dBuV)	Correct (dB/m)	Result (dBuV/m)	Limit (dBuV/m)	Margin (dB)	Remark
1	0.0094	75.66	-101.35	-25.69	48.05	-73.74	peak
2	0.0114	73.50	-101.40	-27.90	46.46	-74.36	peak
3	0.0212	70.04	-101.35	-31.31	41.07	-72.38	peak
4	0.0316	66.74	-101.40	-34.66	37.61	-72.27	peak
5	0.0507	63.21	-101.48	-38.27	33.50	-71.77	peak
6	0.0792	59.50	-101.63	-42.13	29.63	-71.76	peak

Test Mode:	BLE 1M	Frequency(MHz):	2480
Polarity:	Horizontal	Test Voltage:	AC 120V_60Hz

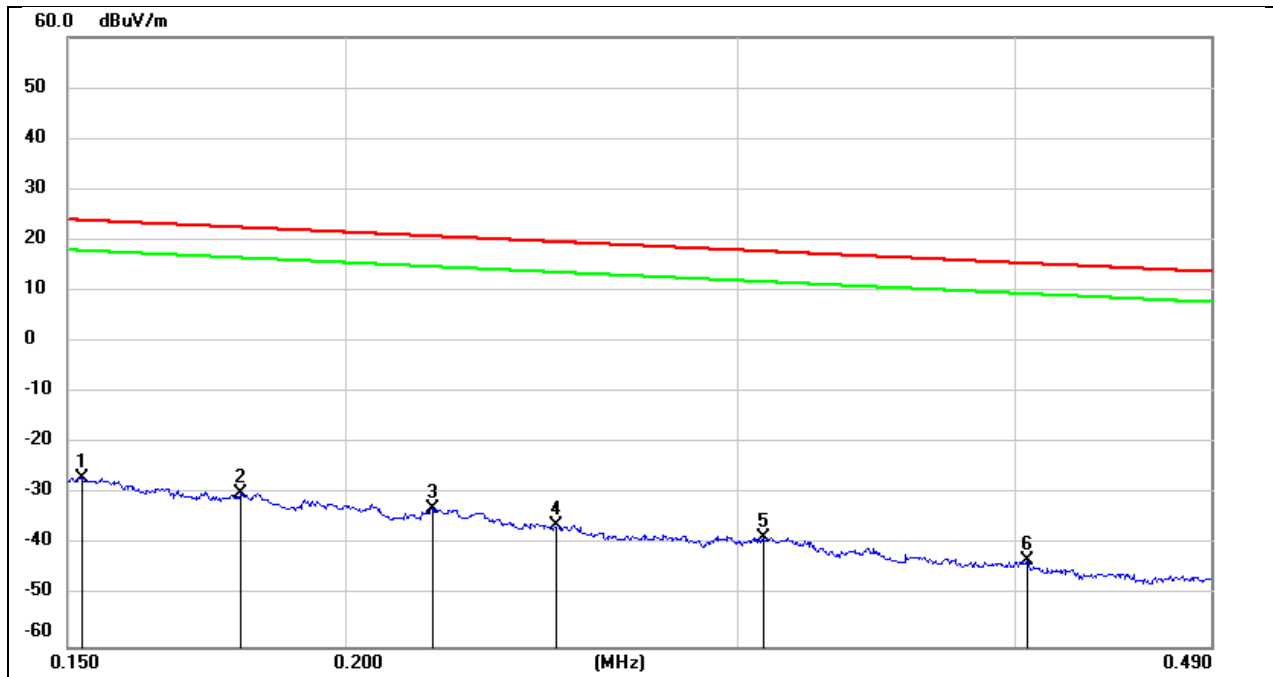

No.	Frequency (MHz)	Reading (dBuV)	Correct (dB/m)	Result (dBuV/m)	Limit (dBuV/m)	Margin (dB)	Remark
1	0.1524	74.80	-101.63	-26.83	23.94	-50.77	peak
2	0.1794	71.77	-101.68	-29.91	22.53	-52.44	peak
3	0.2190	68.77	-101.75	-32.98	20.79	-53.77	peak
4	0.2489	65.69	-101.80	-36.11	19.68	-55.79	peak
5	0.3084	63.45	-101.86	-38.41	17.82	-56.23	peak
6	0.4050	58.85	-101.96	-43.11	15.45	-58.56	peak

Test Mode:	BLE 1M	Frequency(MHz):	2480
Polarity:	Horizontal	Test Voltage:	AC 120V_60Hz

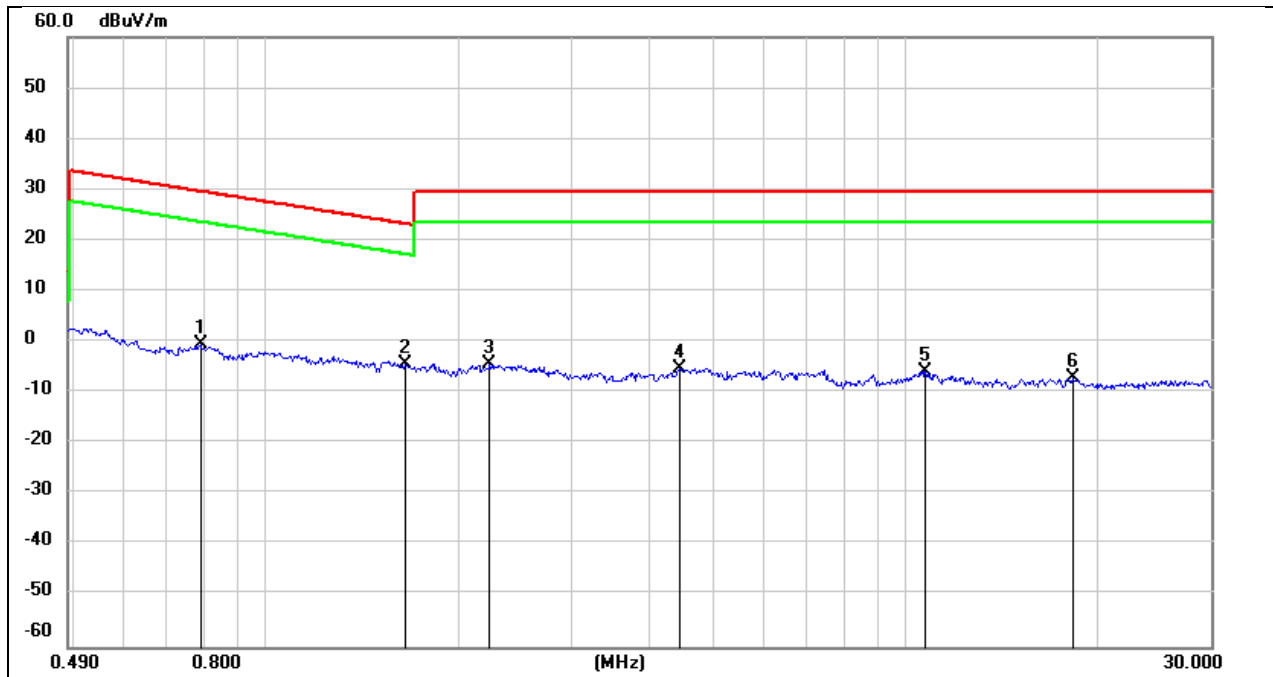

No.	Frequency (MHz)	Reading (dBuV)	Correct (dB/m)	Result (dBuV/m)	Limit (dBuV/m)	Margin (dB)	Remark
1	0.7893	61.68	-62.14	-0.46	29.66	-30.12	peak
2	1.6491	57.55	-61.98	-4.43	23.26	-27.69	peak
3	2.2364	57.30	-61.76	-4.46	29.54	-34.00	peak
4	4.4443	56.29	-61.40	-5.11	29.54	-34.65	peak
5	10.7299	54.98	-60.83	-5.85	29.54	-35.39	peak
6	18.2545	53.93	-60.90	-6.97	29.54	-36.51	peak

8.5. SPURIOUS EMISSIONS(18 GHZ~26 GHZ)

Test Mode:	BLE 1M	Frequency(MHz):	2480
Polarity:	Horizontal	Test Voltage:	AC 120V_60Hz

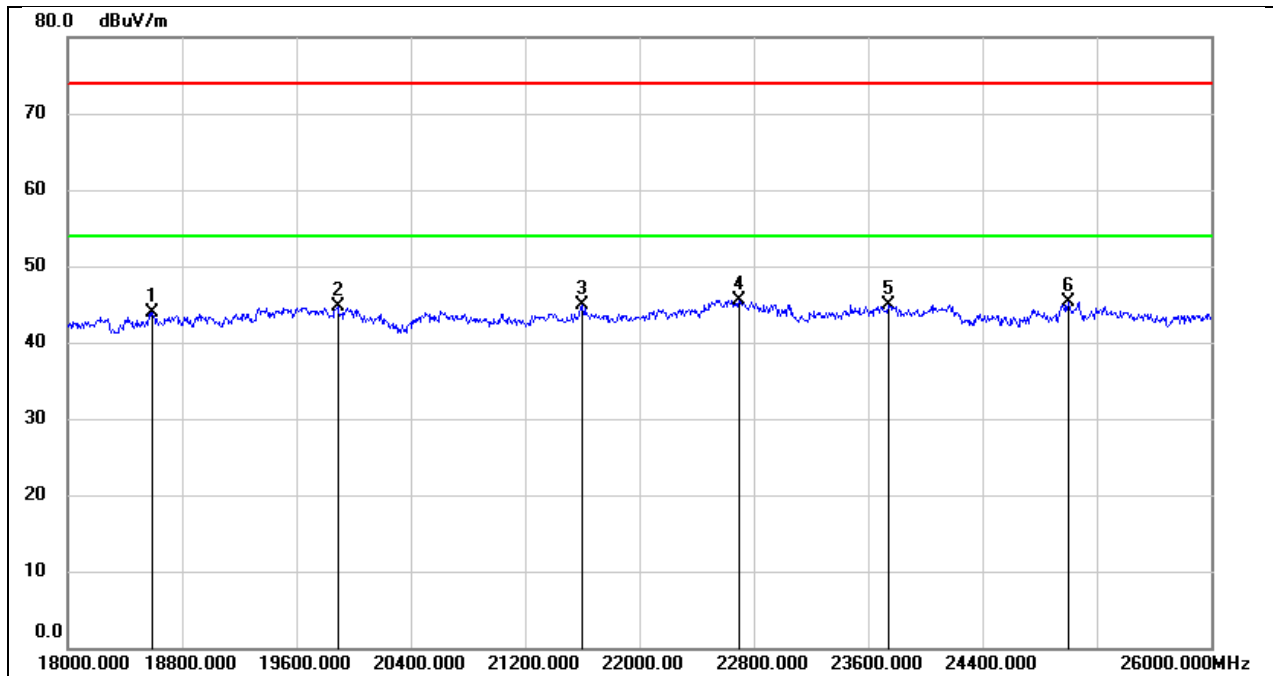

No.	Frequency (MHz)	Reading (dBuV)	Correct (dB/m)	Result (dBuV/m)	Limit (dBuV/m)	Margin (dB)	Remark
1	18592.000	49.25	-5.31	43.94	74.00	-30.06	peak
2	19888.000	50.07	-5.36	44.71	74.00	-29.29	peak
3	21600.000	49.52	-4.54	44.98	74.00	-29.02	peak
4	22696.000	49.28	-3.73	45.55	74.00	-28.45	peak
5	23744.000	48.15	-3.20	44.95	74.00	-29.05	peak
6	25000.000	47.36	-2.10	45.26	74.00	-28.74	peak

Test Mode:	BLE 1M	Frequency(MHz):	2480
Polarity:	Vertical	Test Voltage:	AC 120V_60Hz

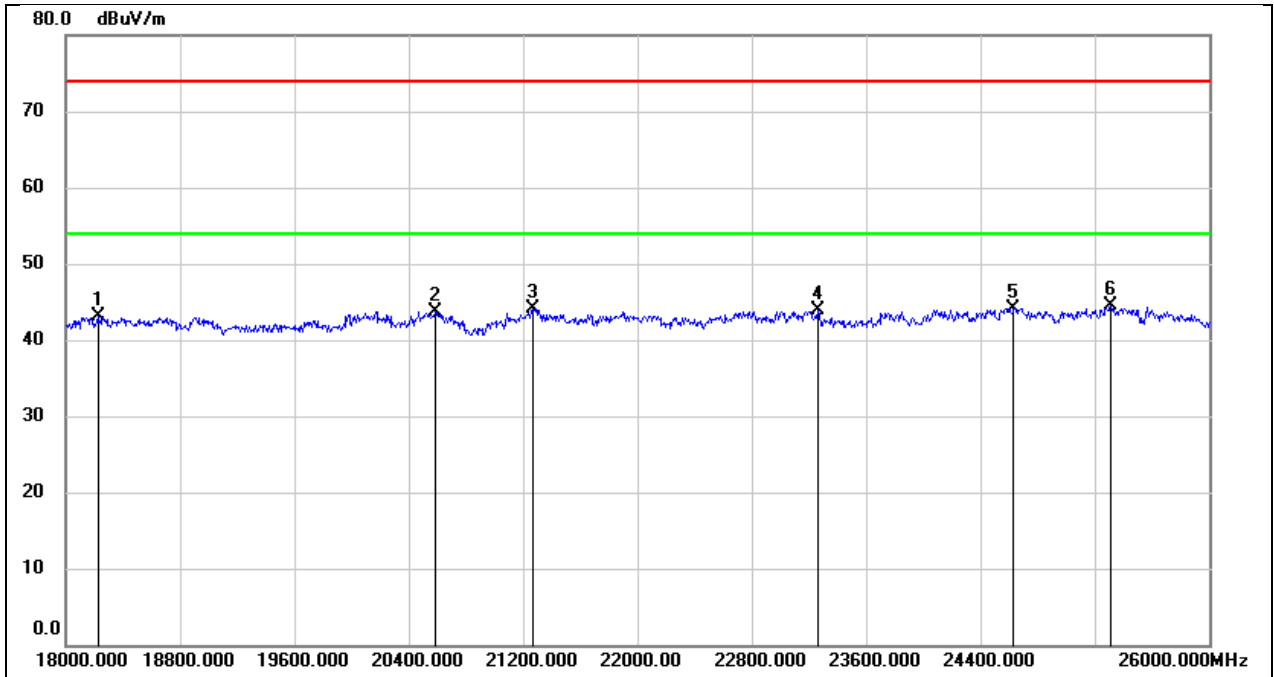

No.	Frequency (MHz)	Reading (dBuV)	Correct (dB/m)	Result (dBuV/m)	Limit (dBuV/m)	Margin (dB)	Remark
1	18224.000	48.58	-5.53	43.05	74.00	-30.95	peak
2	20584.000	49.00	-5.27	43.73	74.00	-30.27	peak
3	21264.000	48.85	-4.76	44.09	74.00	-29.91	peak
4	23264.000	47.26	-3.36	43.90	74.00	-30.10	peak
5	24632.000	46.46	-2.31	44.15	74.00	-29.85	peak
6	25312.000	46.20	-1.70	44.50	74.00	-29.50	peak

8.6. SPURIOUS EMISSIONS(30 MHZ~1 GHZ)

Test Mode:	BLE 1M	Frequency(MHz):	2480
Polarity:	Horizontal	Test Voltage:	AC120V_60Hz

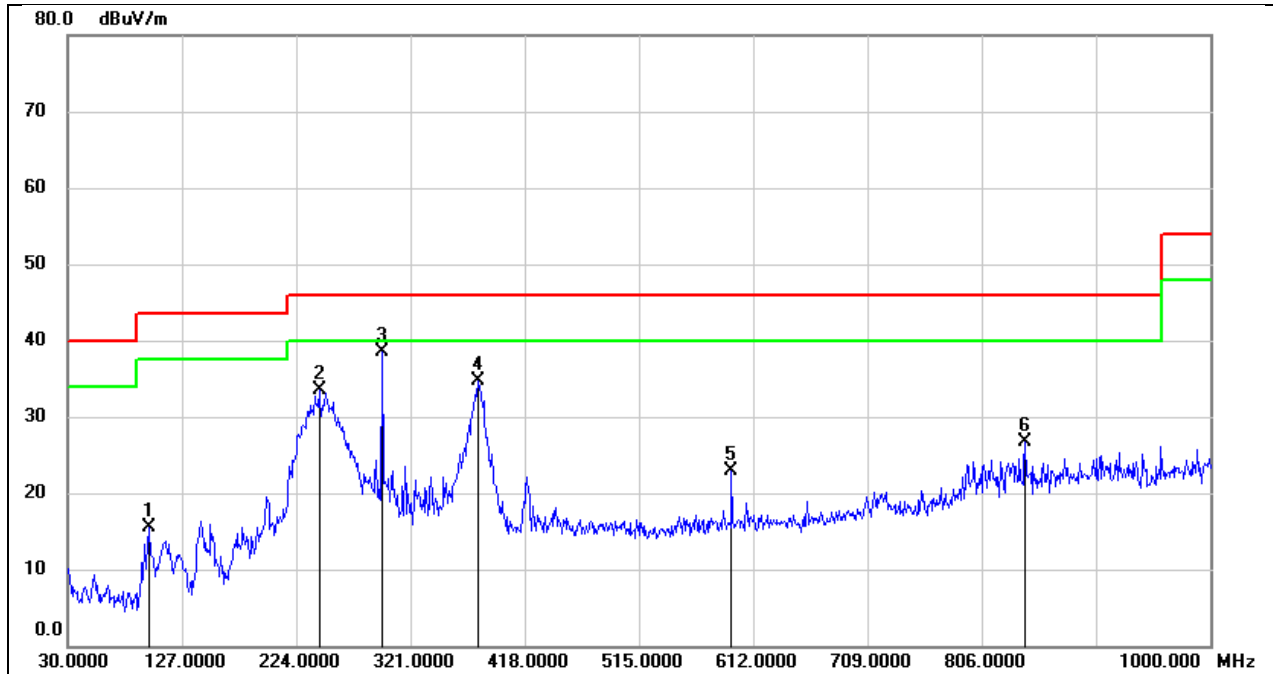

No.	Frequency (MHz)	Reading (dBuV)	Correct (dB/m)	Result (dBuV/m)	Limit (dBuV/m)	Margin (dB)	Remark
1	98.8700	32.41	-16.85	15.56	43.50	-27.94	QP
2	243.4000	48.63	-15.18	33.45	46.00	-12.55	QP
3	296.7500	51.26	-12.79	38.47	46.00	-7.53	QP
4	378.2300	45.59	-10.82	34.77	46.00	-11.23	QP
5	593.5700	30.32	-7.46	22.86	46.00	-23.14	QP
6	842.8600	30.06	-3.33	26.73	46.00	-19.27	QP

Test Mode:	BLE 1M	Frequency(MHz):	2480
Polarity:	Vertical	Test Voltage:	AC120V_60Hz

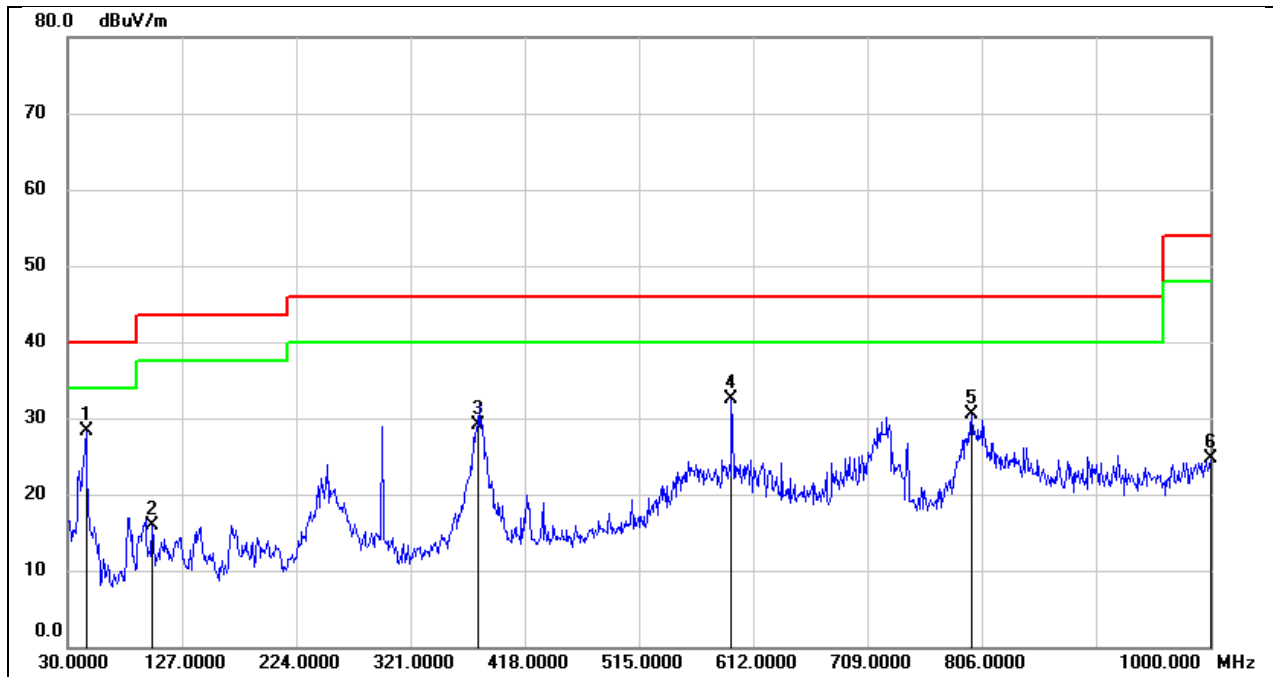

No.	Frequency (MHz)	Reading (dBuV)	Correct (dB/m)	Result (dBuV/m)	Limit (dBuV/m)	Margin (dB)	Remark
1	45.5200	43.55	-15.32	28.23	40.00	-11.77	QP
2	101.7800	32.57	-16.66	15.91	43.50	-27.59	QP
3	378.2300	40.00	-10.82	29.18	46.00	-16.82	QP
4	593.5700	39.93	-7.46	32.47	46.00	-13.53	QP
5	797.2700	34.89	-4.45	30.44	46.00	-15.56	QP
6	1000.0000	26.84	-2.10	24.74	54.00	-29.26	QP

9. ANTENNA REQUIREMENT

REQUIREMENT

Please refer to FCC part 15.203

An intentional radiator shall be designed to ensure that no antenna other than that furnished by the responsible party shall be used with the device. The use of a permanently attached antenna or of an antenna that uses a unique coupling to the intentional radiator shall be considered sufficient to comply with the provisions of this section. The manufacturer may design the unit so that a broken antenna can be replaced by the user, but the use of a standard antenna jack or electrical connector is prohibited.

Please refer to FCC part 15.247(b)(4)

The conducted output power limit specified in paragraph (b) of this section is based on the use of antennas with directional gains that do not exceed 6 dBi. Except as shown in paragraph (c) of this section, if transmitting antennas of directional gain greater than 6 dBi are used, the conducted output power from the intentional radiator shall be reduced below the stated values in paragraphs (b)(1), (b)(2), and (b)(3) of this section, as appropriate, by the amount in dB that the directional gain of the antenna exceeds 6 dBi.

DESCRIPTION

Pass

10. AC POWER LINE CONDUCTED EMISSION

LIMITS

Please refer to CFR 47 FCC §15.207 (a).

FREQUENCY (MHz)	Quasi-peak	Average
0.15 -0.5	66 - 56 *	56 - 46 *
0.50 -5.0	56.00	46.00
5.0 -30.0	60.00	50.00

TEST PROCEDURE

The EUT is put on a table of non-conducting material that is 80 cm high. The vertical conducting wall of shielding is located 40 cm to the rear of the EUT. The power line of the EUT is connected to the AC mains through a Artificial Mains Network (A.M.N.). A EMI Measurement Receiver (R&S Test Receiver ESR3) is used to test the emissions from both sides of AC line. According to the requirements in Section 6.2 of ANSI C63.10-2013. Conducted emissions from the EUT measured in the frequency range between 0.15 MHz and 30 MHz using CISPR Quasi-Peak and average detector mode. The bandwidth of EMI test receiver is set at 9 kHz.

The arrangement of the equipment is installed to meet the standards and operating in a manner, which tends to maximize its emission characteristics in a normal application.

TEST SETUP

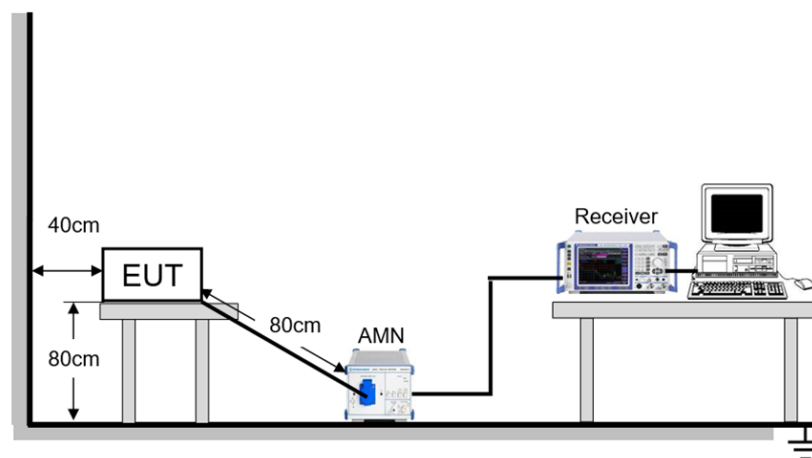

TEST ENVIRONMENT

Temperature	21.6°C	Relative Humidity	55.3%
Atmosphere Pressure	101kPa	Test Voltage	AC 120V 60Hz

TEST DATE / ENGINEER

Test Date	June 26, 2025	Test By	Deacon Tan
-----------	---------------	---------	------------

TEST RESULTS

Test Mode:	BLE 1M	Frequency(MHz):	2480
Line:	Line		

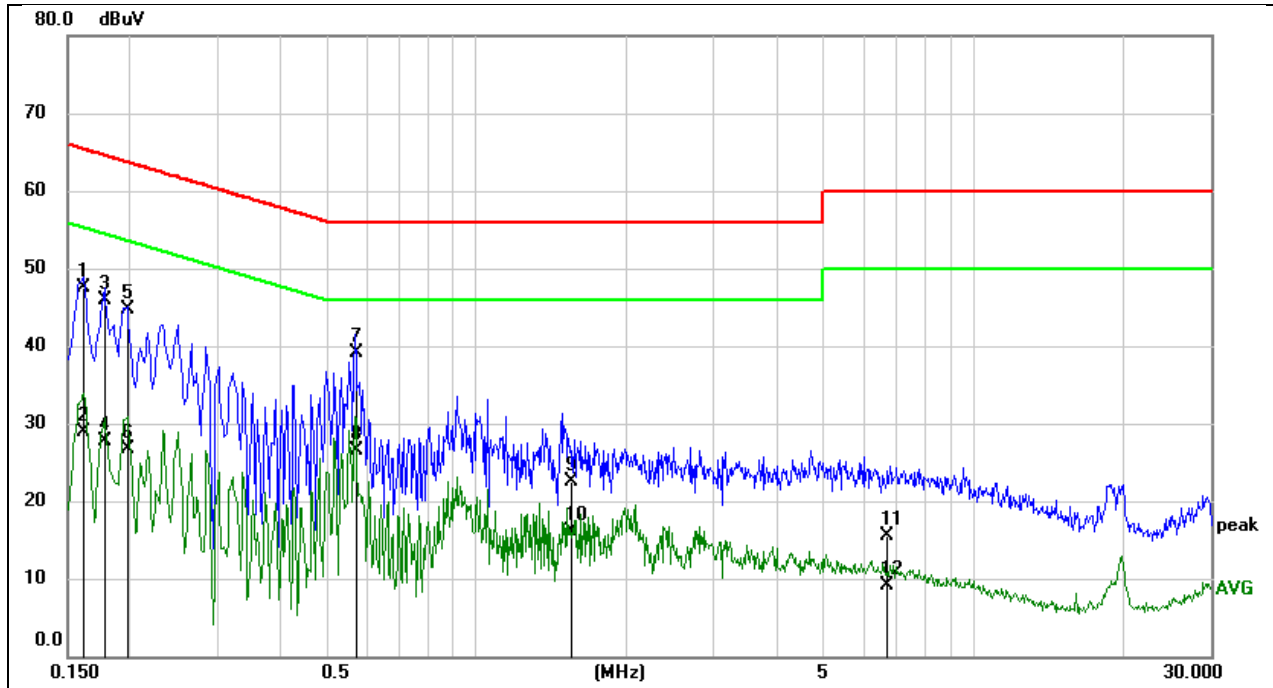

No.	Frequency (MHz)	Reading (dBuV)	Correct (dB)	Result (dBuV)	Limit (dBuV)	Margin (dB)	Remark
1	0.1621	33.28	9.64	42.92	65.36	-22.44	QP
2	0.1621	20.10	9.64	29.74	55.36	-25.62	AVG
3	0.4971	28.13	9.64	37.77	56.05	-18.28	QP
4	0.4971	20.52	9.64	30.16	46.05	-15.89	AVG
5	2.3989	13.64	9.64	23.28	56.00	-32.72	QP
6	2.3989	8.03	9.64	17.67	46.00	-28.33	AVG
7	4.4291	18.99	9.64	28.63	56.00	-27.37	QP
8	4.4291	10.94	9.64	20.58	46.00	-25.42	AVG
9	6.4616	19.50	9.71	29.21	60.00	-30.79	QP
10	6.4616	13.82	9.71	23.53	50.00	-26.47	AVG
11	16.5473	15.93	9.74	25.67	60.00	-34.33	QP
12	16.5473	6.53	9.74	16.27	50.00	-33.73	AVG

Note:

1. Result = Reading + Correct Factor.
2. If QP Result complies with AV limit, AV Result is deemed to comply with AV limit.
3. Test setup: RBW: 200 Hz (9 kHz ~ 150 kHz), 9 kHz (150 kHz ~ 30 MHz).
4. Step size: 80 Hz (0.009 MHz ~ 0.15 MHz), 4 kHz (0.15 MHz ~ 30 MHz), Scan time: auto.

Note: All the modes have been tested, only the worst data was recorded in the report.

Test Mode:	BLE 1M	Frequency(MHz):	2480
Line:	Neutral		

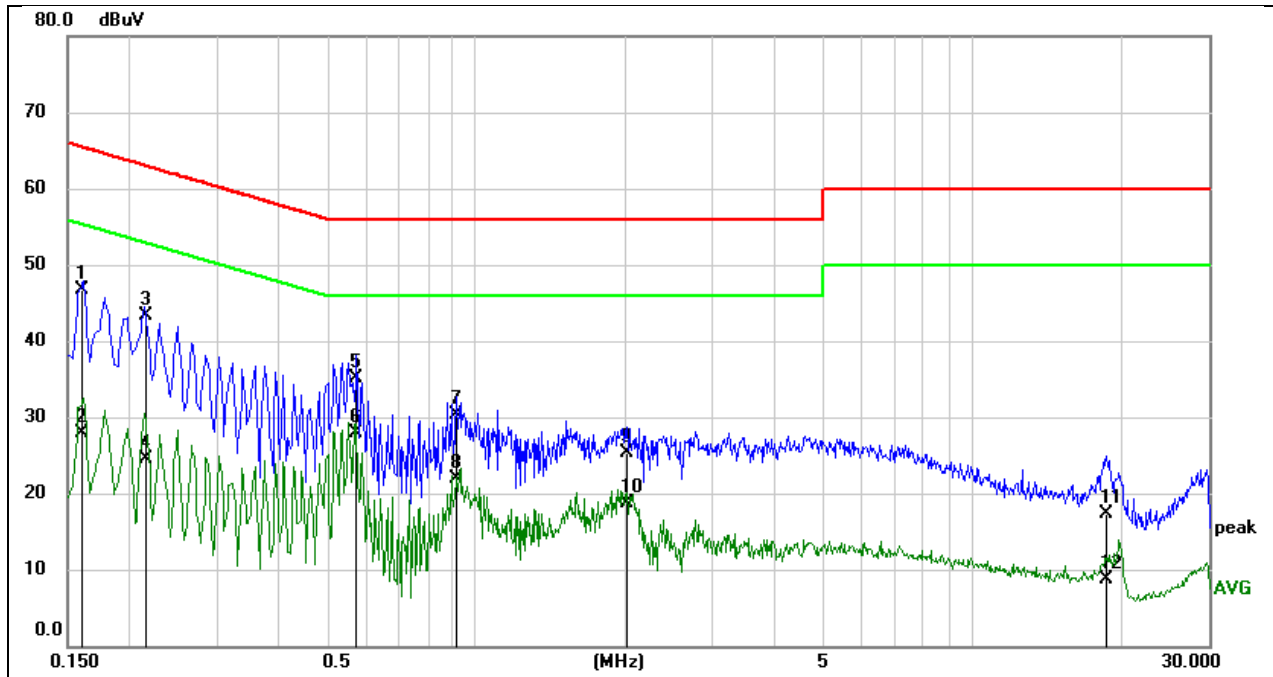

No.	Frequency (MHz)	Reading (dBuV)	Correct (dB)	Result (dBuV)	Limit (dBuV)	Margin (dB)	Remark
1	0.1511	35.28	9.64	44.92	65.94	-21.02	QP
2	0.1511	21.08	9.64	30.72	55.94	-25.22	AVG
3	0.1835	29.58	9.64	39.22	64.33	-25.11	QP
4	0.1835	17.98	9.64	27.62	54.33	-26.71	AVG
5	0.4901	25.38	9.64	35.02	56.17	-21.15	QP
6	0.4901	14.33	9.64	23.97	46.17	-22.20	AVG
7	0.6456	23.17	9.63	32.80	56.00	-23.20	QP
8	0.6456	14.98	9.63	24.61	46.00	-21.39	AVG
9	5.7232	17.39	9.69	27.08	60.00	-32.92	QP
10	5.7232	12.18	9.69	21.87	50.00	-28.13	AVG
11	16.3661	17.95	9.74	27.69	60.00	-32.31	QP
12	16.3661	8.67	9.74	18.41	50.00	-31.59	AVG

Note:

1. Result = Reading + Correct Factor.
2. If QP Result complies with AV limit, AV Result is deemed to comply with AV limit.
3. Test setup: RBW: 200 Hz (9 kHz ~ 150 kHz), 9 kHz (150 kHz ~ 30 MHz).
4. Step size: 80 Hz (0.009 MHz ~ 0.15 MHz), 4 kHz (0.15 MHz ~ 30 MHz), Scan time: auto.

Note: All the modes have been tested, only the worst data was recorded in the report.

11. TEST DATA

11.1. APPENDIX A: DTS BANDWIDTH

11.1.1. Test Result

Test Mode	Antenna	Frequency[MHz]	DTS BW [MHz]	FL[MHz]	FH[MHz]	Limit[MHz]	Verdict
BLE_1M	Ant1	2402	0.70	2401.65	2402.35	≥ 0.5	PASS
		2440	0.69	2439.66	2440.35	≥ 0.5	PASS
		2480	0.69	2479.66	2480.35	≥ 0.5	PASS

11.1.2. Test Graphs

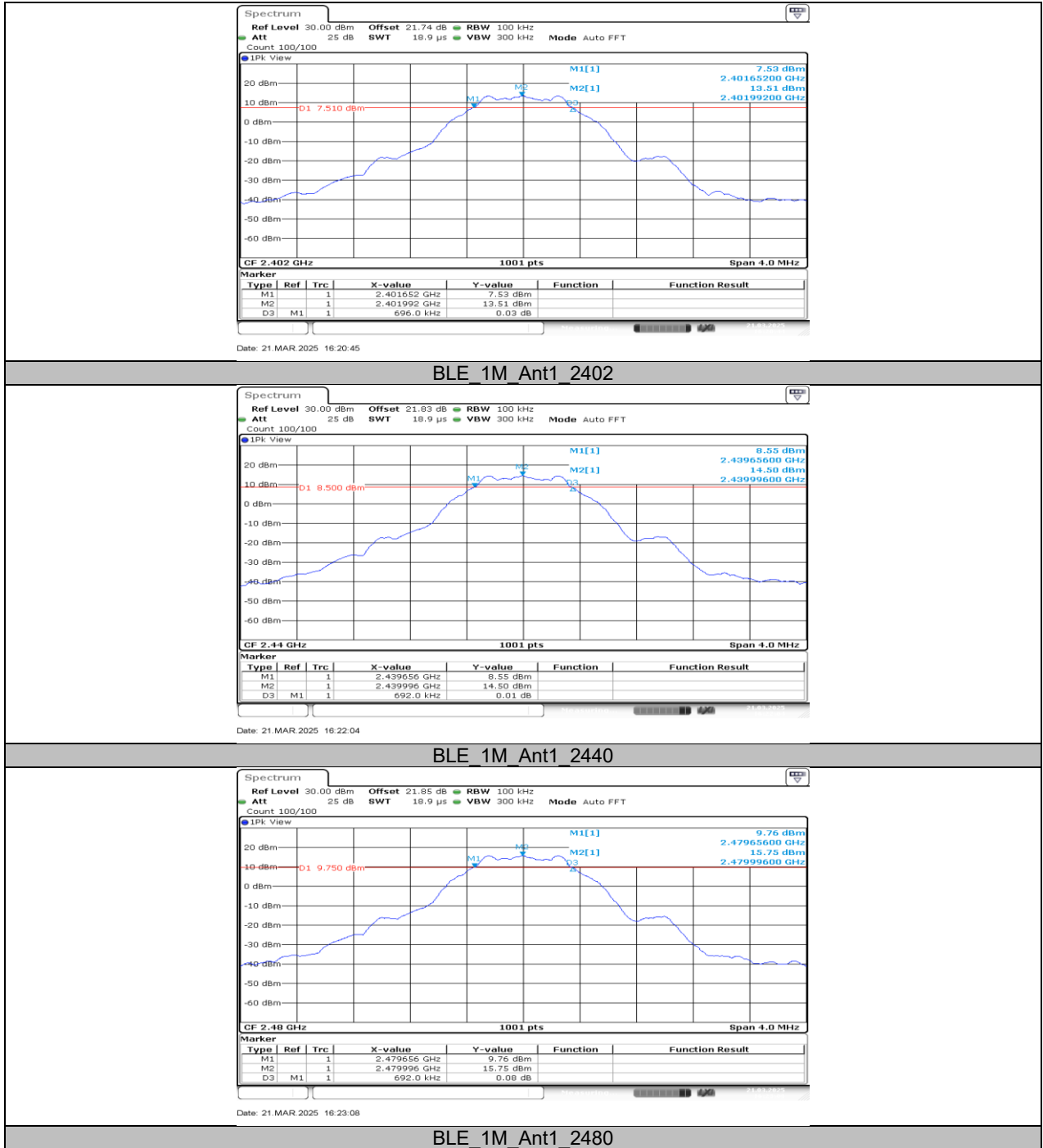

11.2. APPENDIX B: OCCUPIED CHANNEL BANDWIDTH

11.2.1. Test Result

Test Mode	Antenna	Frequency[MHz]	OCB [MHz]	FL[MHz]	FH[MHz]	Verdict
BLE_1M	Ant1	2402	1.031	2401.4685	2402.4995	PASS
		2440	1.031	2439.4685	2440.4995	PASS
		2480	1.031	2479.4685	2480.4995	PASS

11.2.2. Test Graphs

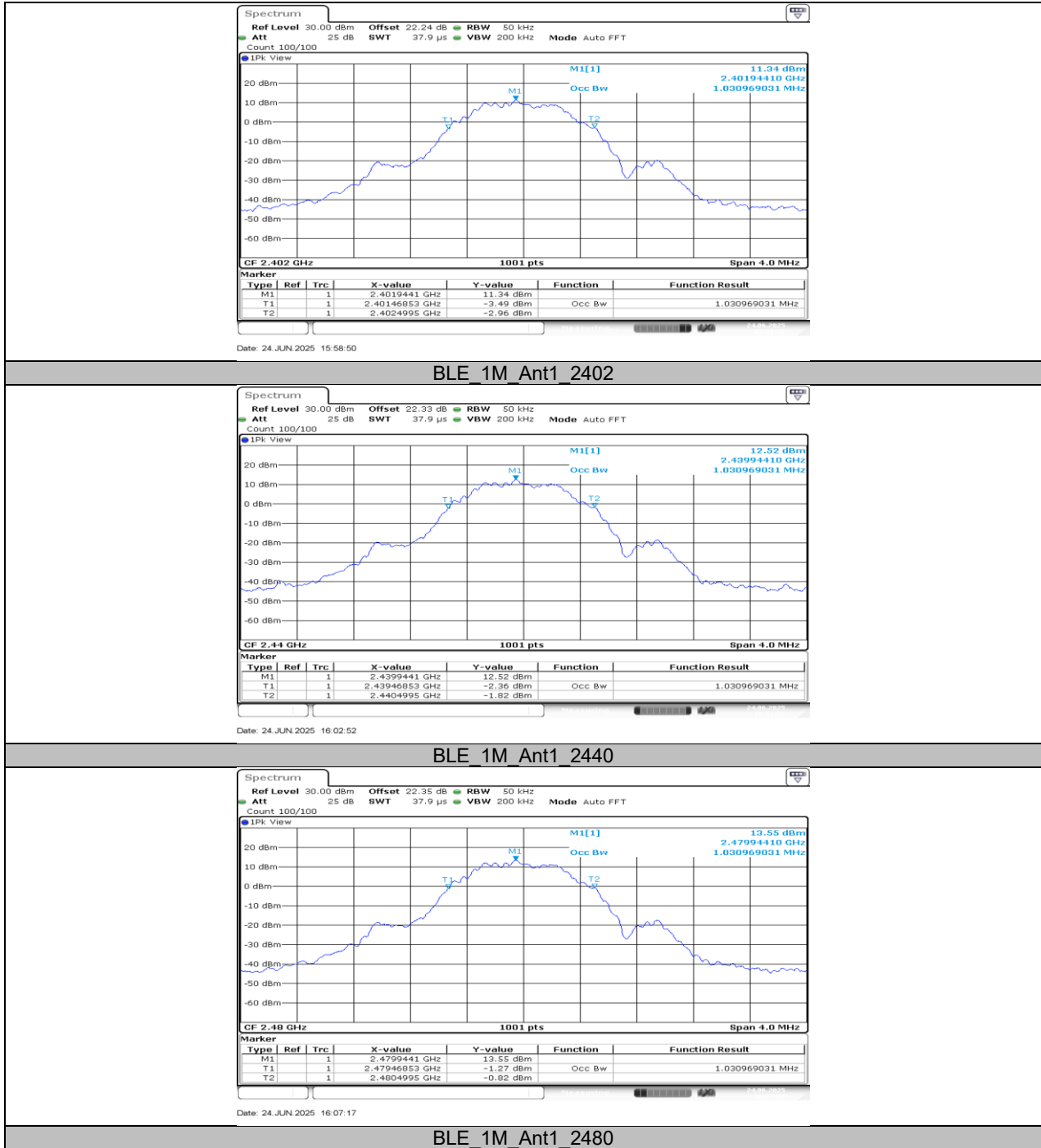

11.3. APPENDIX C: MAXIMUM CONDUCTED OUTPUT POWER

Test Mode	Antenna	Frequency[MHz]	Peak Power Result[dBm]	Limit[dBm]	Verdict
BLE_1M	Ant1	2402	14.30	≤30	PASS
		2440	15.27	≤30	PASS
		2480	16.57	≤30	PASS

Test Mode	Antenna	Frequency[MHz]	AVG Power Result[dBm]	Limit[dBm]	Verdict
BLE_1M	Ant1	2402	14.15	≤30	PASS
		2440	15.03	≤30	PASS
		2480	16.27	≤30	PASS

Note for average power: The Duty Cycle Factor (refer to section 7.5) had already compensated to the test data.

11.4. APPENDIX D: MAXIMUM POWER SPECTRAL DENSITY

11.4.1. Test Result

Test Mode	Antenna	Frequency[MHz]	Result[dBm/3kHz]	Limit[dBm/3kHz]	Verdict
BLE_1M	Ant1	2402	-2.56	≤8.00	PASS
		2440	-1.66	≤8.00	PASS
		2480	-0.49	≤8.00	PASS

11.4.2. Test Graphs

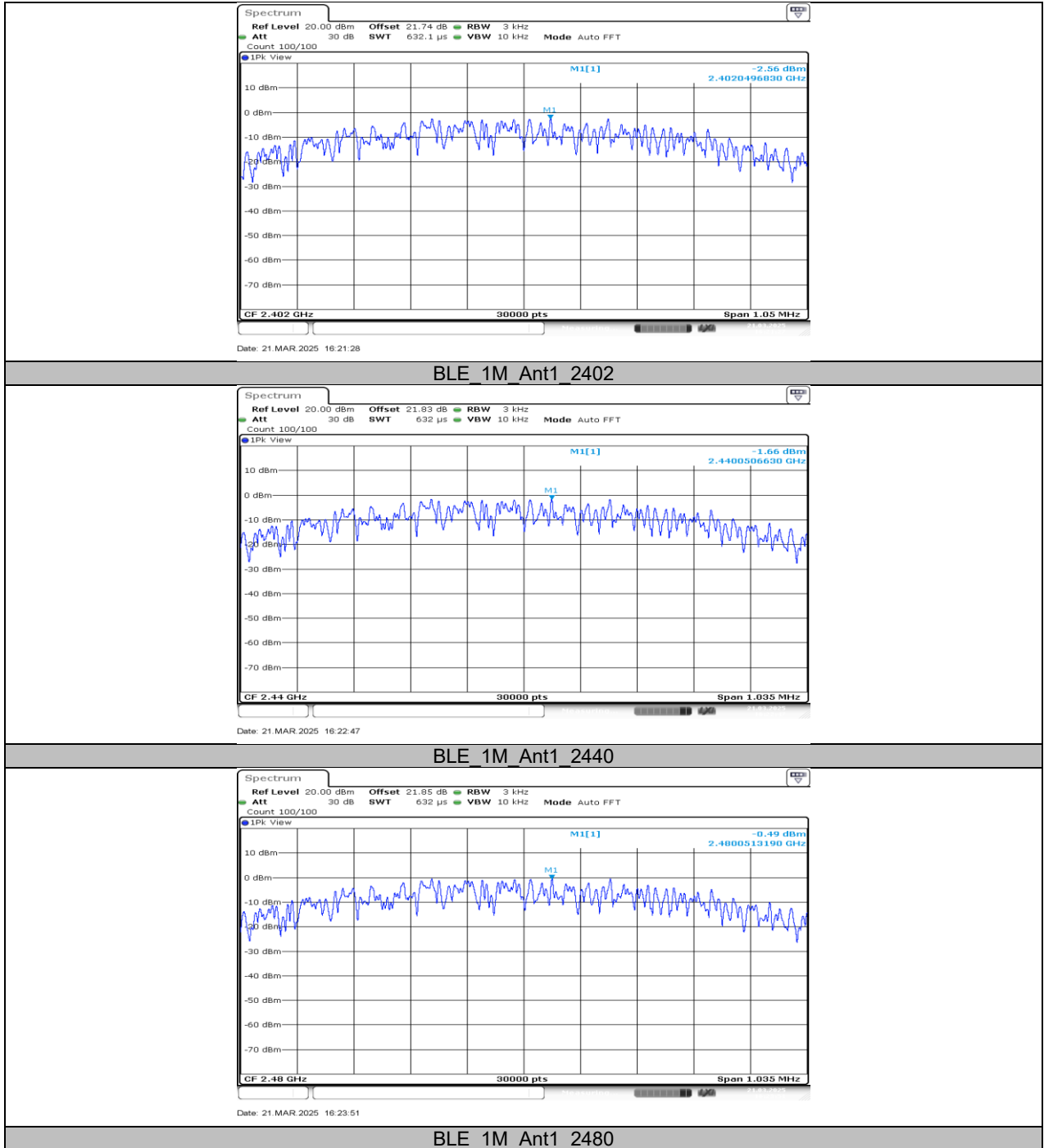

11.5. APPENDIX E: BAND EDGE MEASUREMENTS

11.5.1. Test Result

Test Mode	Antenna	ChName	Frequency [MHz]	RefLevel [dBm]	Result[dBm]	Limit[dBm]	Verdict
BLE_1M	Ant1	Low	2402	12.99	-42.9	≤ -7.01	PASS
		High	2480	15.11	-41	≤ -4.89	PASS

11.5.2. Test Graphs

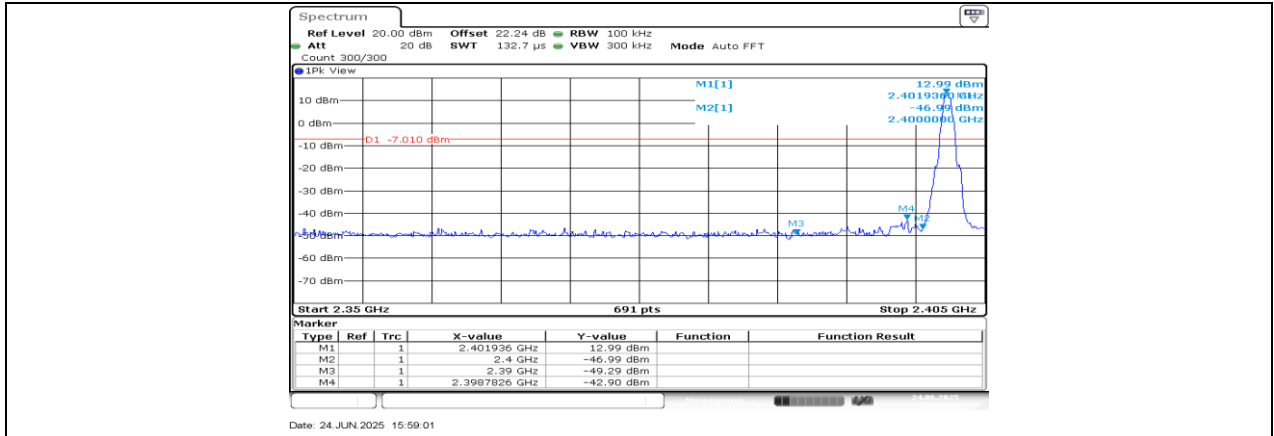

BLE 1M Ant1 Low 2402

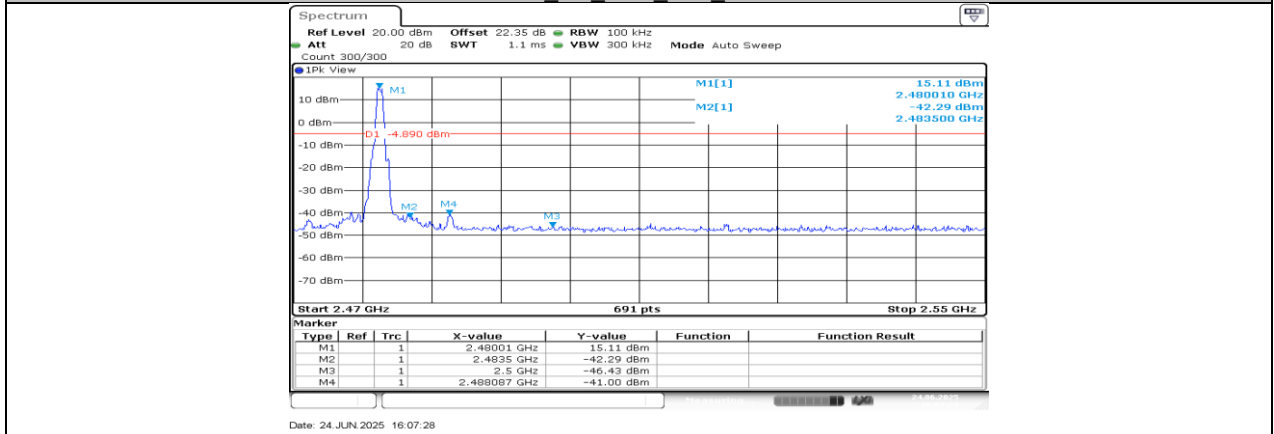

BLE 1M Ant1 High 2480

11.6. APPENDIX F: CONDUCTED SPURIOUS EMISSION
11.6.1. Test Result

Test Mode	Antenna	Frequency[MHz]	FreqRange [MHz]	Result[dBm]	Limit[dBm]	Verdict
BLE_1M	Ant1	2402	Reference	13.00	---	PASS
			30~1000	-45.26	≤-7	PASS
			1000~26500	-40.38	≤-7	PASS
		2440	Reference	14.10	---	PASS
			30~1000	-44.6	≤-5.9	PASS
			1000~26500	-40.68	≤-5.9	PASS
		2480	Reference	15.02	---	PASS
			30~1000	-45.04	≤-4.98	PASS
			1000~26500	-39.84	≤-4.98	PASS

11.6.2. Test Graphs

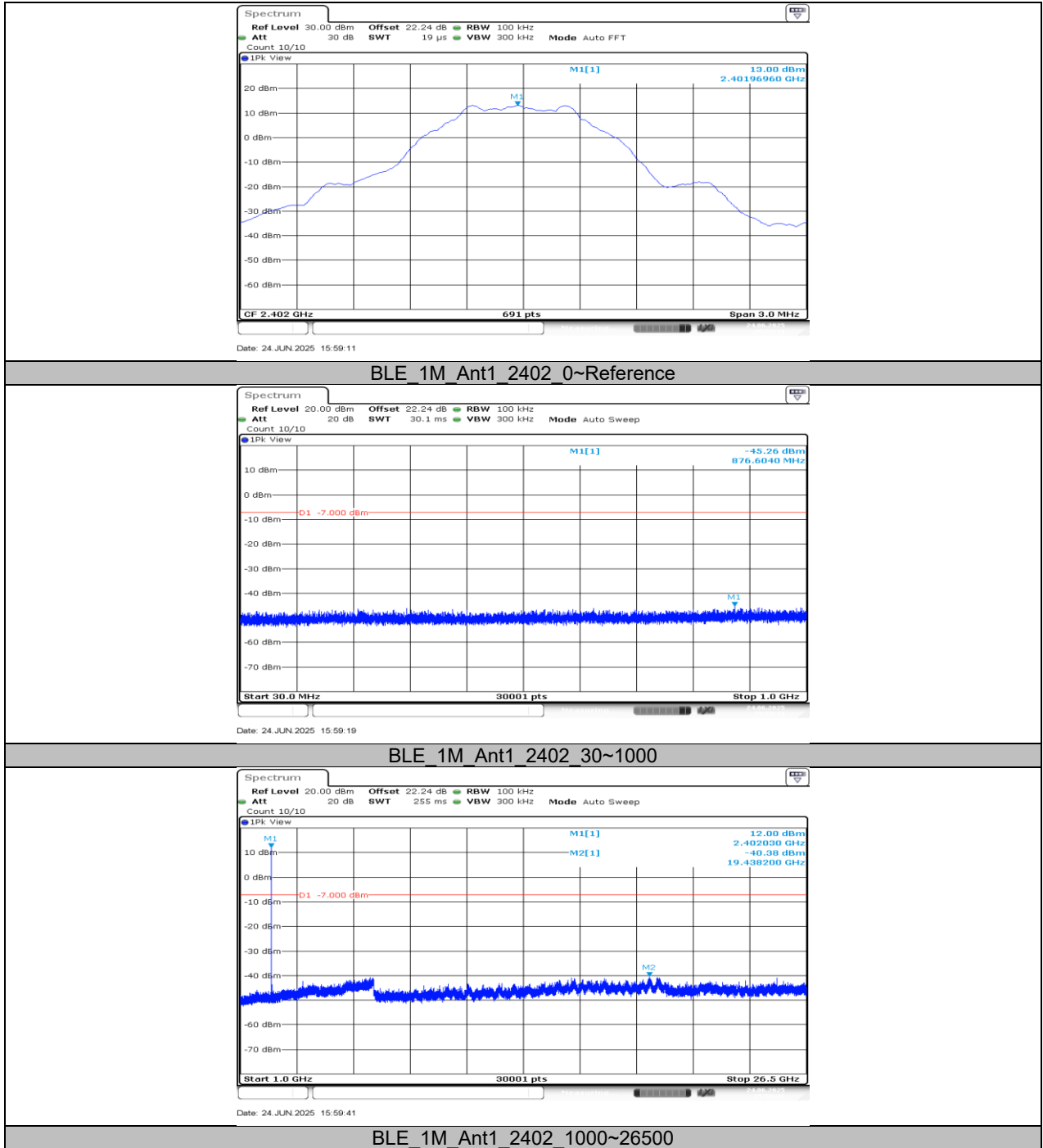

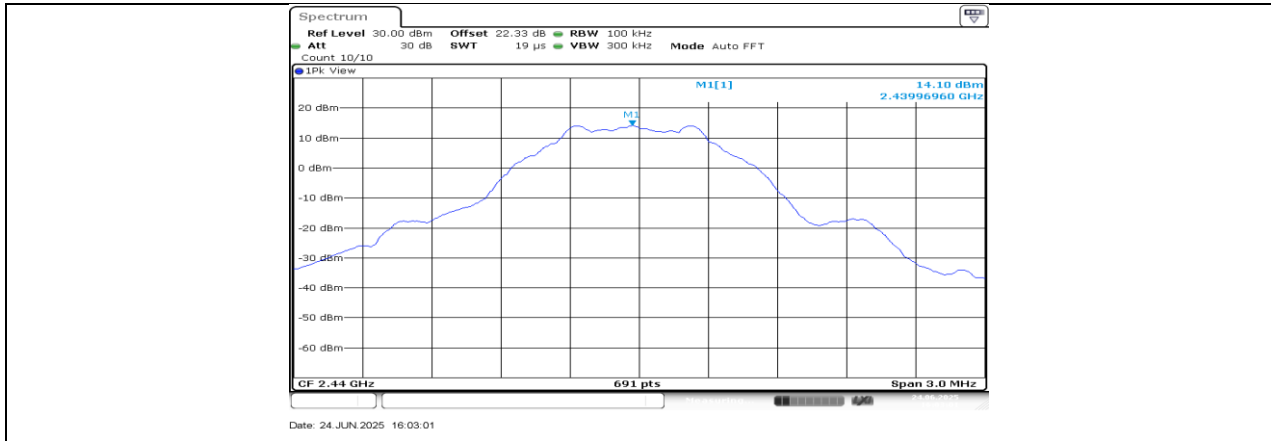

BLE 1M Ant1 2440 0~Reference

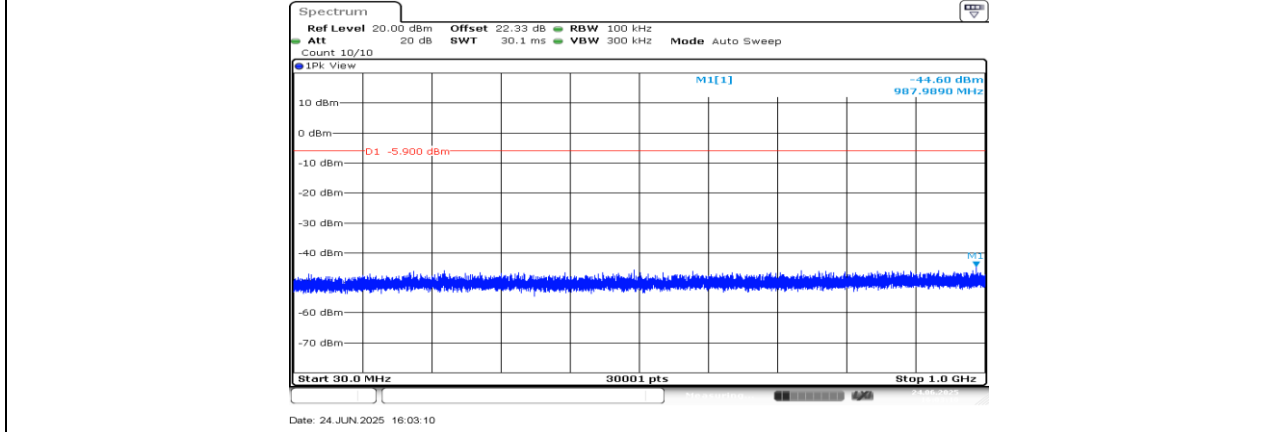

BLE 1M Ant1 2440 30~1000

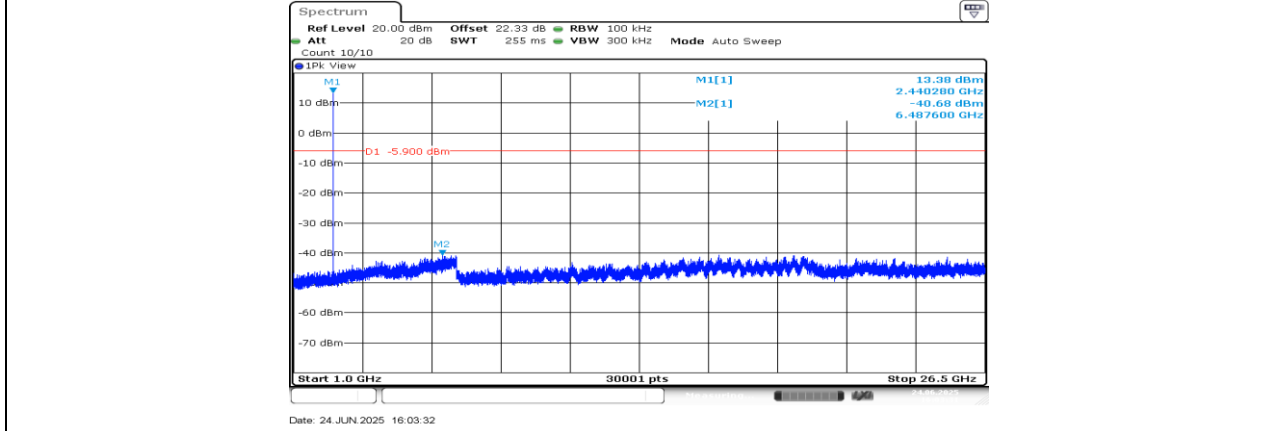

BLE 1M Ant1 2440 1000~26500

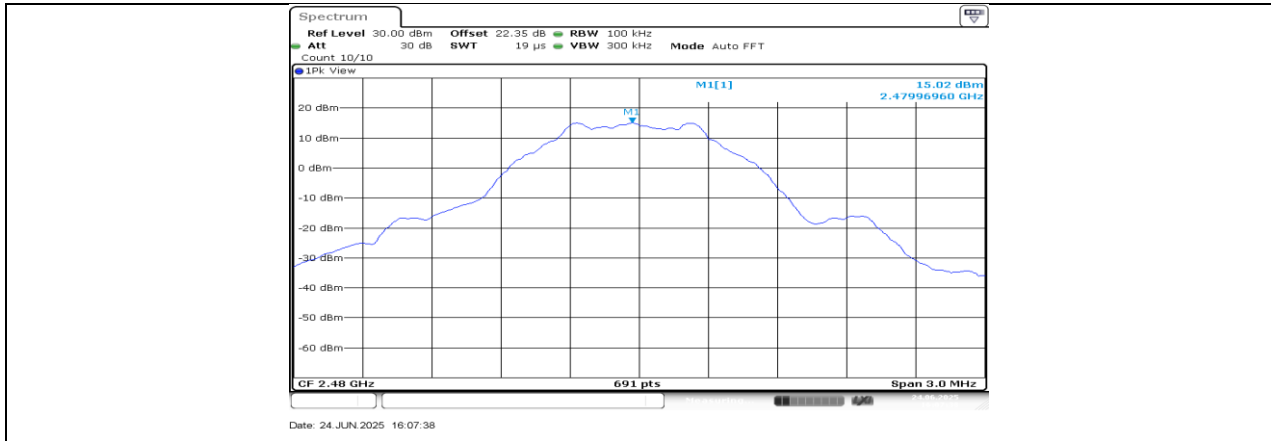

BLE 1M Ant1 2480 0~Reference

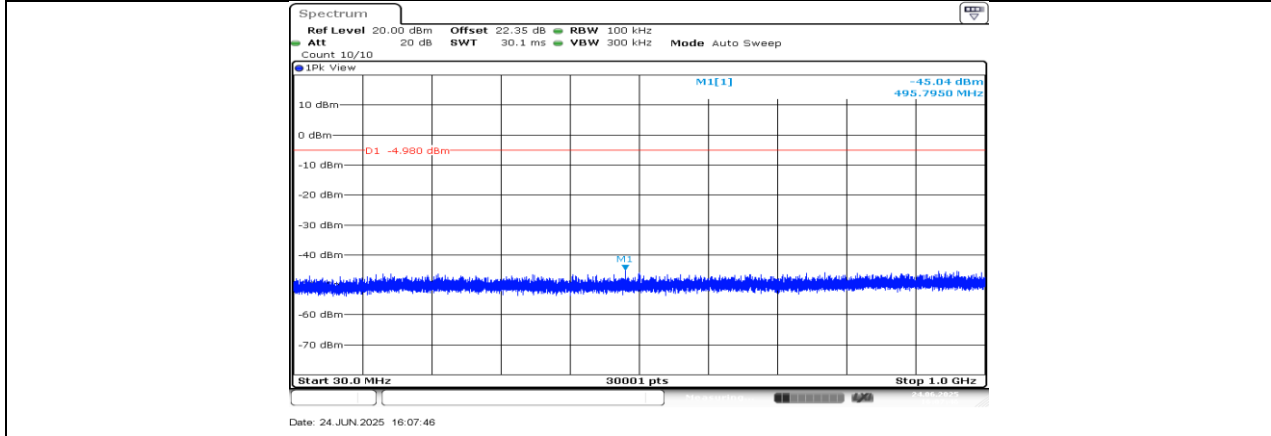

BLE 1M Ant1 2480 30~1000

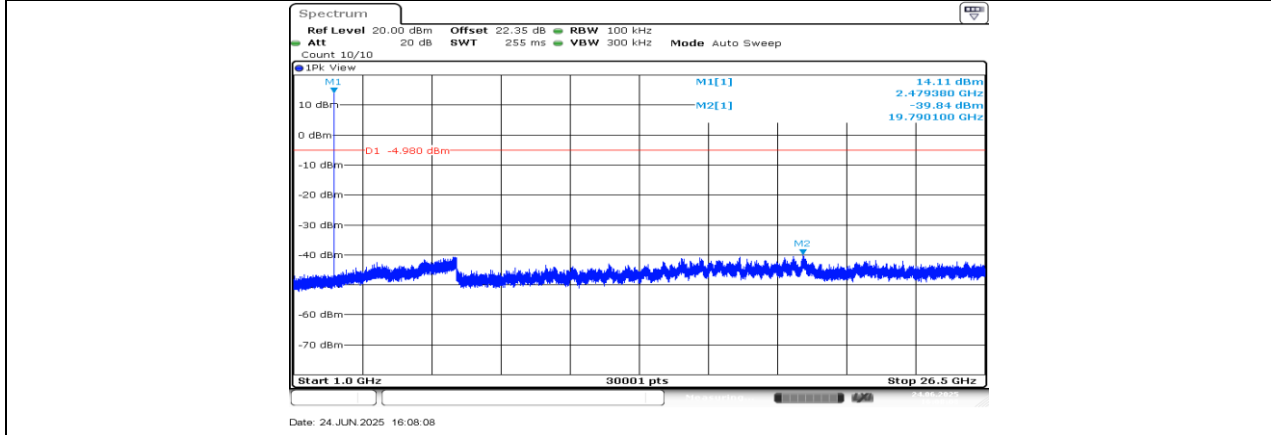

BLE 1M Ant1 2480 1000~26500

11.7. APPENDIX G: DUTY CYCLE

11.7.1. Test Result

Test Mode	On Time (msec)	Period (msec)	Duty Cycle x (Linear)	Duty Cycle (%)	Duty Cycle Correction Factor (dB)	1/T Minimum VBW (kHz)	Final setting For VBW (kHz)
BLE_1M	0.3	0.91	0.3297	32.97	4.82	3.33	4

Note:

Duty Cycle Correction Factor= $10\log(1/x)$.

Where: x is Duty Cycle (Linear)

Where: T is On Time

If that calculated VBW is not available on the analyzer then the next higher value should be used.

11.7.2. Test Graphs

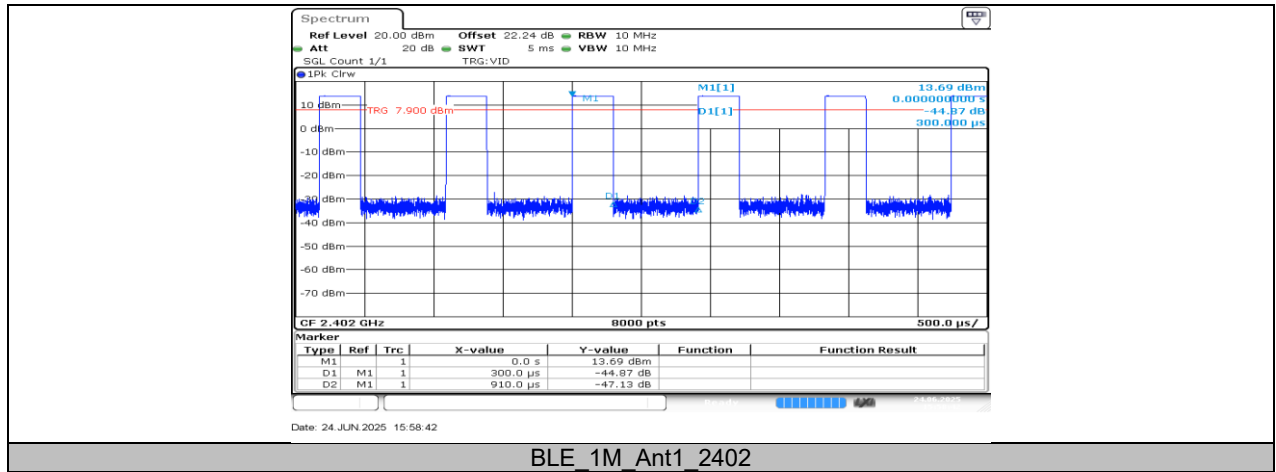

END OF REPORT