

TEST REPORT

FCC ID: 2APJ5-0308

Product: YiDou Translator

Model No.: ET-YiDou 0308

Additional Model No.: N/A

Trade Mark:



Report No.: TCT180328E029

Issued Date: May 11, 2018

Issued for:

Easyto(Beijing)TechnologyCo., Ltd

1904 room, Building #3, Jiuxianqiao Road #4, Chaoyang District, Beijing,
China

Issued By:

Shenzhen Tongce Testing Lab.

1B/F., Building 1, Yibaolai Industrial Park, Qiaotou, Fuyong, Baoan District,
Shenzhen, Guangdong, China

TEL: +86-755-27673339

FAX: +86-755-27673332

Note: This report shall not be reproduced except in full, without the written approval of Shenzhen Tongce Testing Lab.

This document may be altered or revised by Shenzhen Tongce Testing Lab. personnel only, and shall be noted in the revision section of the document. The test results in the report only apply to the tested sample.

TABLE OF CONTENTS

1. Test Certification 3

2. Test Result Summary 4

3. EUT Description..... 5

4. General Information..... 6

 4.1. Test environment and mode..... 6

 4.2. Description of Support Units..... 6

5. Facilities and Accreditations 7

 5.1. Facilities 7

 5.2. Location 7

 5.3. Measurement Uncertainty 7

6. Test Results and Measurement Data 8

 6.1. Antenna requirement..... 8

 6.2. Conducted Emission 9

 6.3. Conducted Output Power 13

 6.4. Emission Bandwidth 16

 6.5. Power Spectral Density..... 19

 6.6. Test Specification 19

 6.7. Conducted Band Edge and Spurious Emission Measurement 22

 6.8. Radiated Spurious Emission Measurement 25

Appendix A: Photographs of Test Setup

Appendix B: Photographs of EUT

1. Test Certification

| | |
|------------------------------|---|
| Product: | YiDou Translator |
| Model No.: | ET-YiDou 0308 |
| Additional Model No.: | N/A |
| Trade Mark: |  |
| Applicant: | Easyto(Beijing)TechnologyCo., Ltd |
| Address: | 1904 room, Building #3, Jiuxianqiao Road #4, Chaoyang District, Beijing, China |
| Manufacturer: | Easyto(Beijing)TechnologyCo., Ltd |
| Address: | 1904 room, Building #3, Jiuxianqiao Road #4, Chaoyang District, Beijing, China |
| Date of Test: | Mar. 29, 2018 – May 10, 2018 |
| Applicable Standards: | FCC CFR Title 47 Part 15 Subpart C Section 15.247 KDB 558074 D01 DTS Meas Guidance v04 |

The above equipment has been tested by Shenzhen Tongce Testing Lab. and found compliance with the requirements set forth in the technical standards mentioned above. The results of testing in this report apply only to the product/system, which was tested. Other similar equipment will not necessarily produce the same results due to production tolerance and measurement uncertainties.

Tested By:



Brews Xu

Date:

May 10, 2018

Reviewed By:



Beryl Zhao

Date:

May 11, 2018

Approved By:



Tomsin

Date:

May 11, 2018

2. Test Result Summary

| Requirement | CFR 47 Section | Result |
|----------------------------------|-------------------------------------|--------|
| Antenna requirement | §15.203/§15.247 (c) | PASS |
| AC Power Line Conducted Emission | §15.207 | PASS |
| Conducted Peak Output Power | §15.247 (b)(3) §2.1046 | PASS |
| 6dB Emission Bandwidth | §15.247 (a)(2) §2.1049 | PASS |
| Power Spectral Density | §15.247 (e) | PASS |
| Band Edge | §15.247(d) §2.1051, §2.1057 | PASS |
| Spurious Emission | §15.205/§15.209 §2.1053, §2.1057 | PASS |

Note:

1. PASS: Test item meets the requirement.
2. Fail: Test item does not meet the requirement.
3. N/A: Test case does not apply to the test object.
4. The test result judgment is decided by the limit of test standard.

3. EUT Description

| | |
|-------------------------------|---|
| Product: | YiDou Translator |
| Model No.: | ET-YiDou 0308 |
| Additional Model No.: | N/A |
| Trade Mark: |  |
| Hardware Version: | 1.0 |
| Software Version: | ET-YiDou_0308_V1.01.000 |
| BT Version: | V4.0 (This report is for BLE) |
| Operation Frequency: | 2402MHz~2480MHz |
| Channel Separation: | 2MHz |
| Number of Channel: | 40 |
| Modulation Technology: | GFSK |
| Antenna Type: | Internal Antenna |
| Antenna Gain: | -1.2dBi |
| Power Supply: | Rechargeable Li-ion battery DC 3.8V |

Operation Frequency each of channel

| Channel | Frequency | Channel | Frequency | Channel | Frequency | Channel | Frequency |
|---------|-----------|---------|-----------|---------|-----------|---------|-----------|
| 0 | 2402MHz | 10 | 2422MHz | 20 | 2442MHz | 30 | 2462MHz |
| 1 | 2404MHz | 11 | 2424MHz | 21 | 2444MHz | 31 | 2464MHz |
| ... | ... | ... | ... | ... | ... | ... | ... |
| 8 | 2418MHz | 18 | 2438MHz | 28 | 2458MHz | 38 | 2478MHz |
| 9 | 2420MHz | 19 | 2440MHz | 29 | 2460MHz | 39 | 2480MHz |

Remark: Channel 0, 19 & 39 have been tested.

4. Genera Information

4.1. Test environment and mode

| Operating Environment: | |
|--|--|
| Temperature: | 25.0 °C |
| Humidity: | 56 % RH |
| Atmospheric Pressure: | 1010 mbar |
| Test Mode: | |
| Engineering mode: | Keep the EUT in continuous transmitting by select channel and modulations(The value of duty cycle is 98.46%) with Fully-charged battery. |
| <p>The sample was placed (0.1m below 1GHz, 1.5m above 1GHz) above the ground plane of 3m chamber. Measurements in both horizontal and vertical polarities were performed. During the test, each emission was maximized by: having the EUT continuously working, investigated all operating modes, rotated about all 3 axis (X, Y & Z) and considered typical configuration to obtain worst position, manipulating interconnecting cables, rotating the turntable, varying antenna height from 1m to 4m in both horizontal and vertical polarizations. The emissions worst-case are shown in Test Results of the following pages.</p> | |

4.2. Description of Support Units

The EUT has been tested as an independent unit together with other necessary accessories or support units. The following support units or accessories were used to form a representative test configuration during the tests.

| Equipment | Model No. | Serial No. | FCC ID | Trade Name |
|-----------|------------|------------|--------|------------|
| Adapter | XTB-050200 | / | / | / |

Note:

1. All the equipment/cables were placed in the worst-case configuration to maximize the emission during the test.
2. Grounding was established in accordance with the manufacturer's requirements and conditions for the intended use.
3. For conducted measurements (Output Power, 6dB Emission Bandwidth, Power Spectral Density, Spurious Emissions), the antenna of EUT is connected to the test equipment via temporary antenna connector, the antenna connector is soldered on the antenna port of EUT, and the temporary antenna connector is listed in the Test Instruments.

5. Facilities and Accreditations

5.1. Facilities

The test facility is recognized, certified, or accredited by the following organizations:

- FCC - Registration No.: 645098

Shenzhen Tongce Testing Lab

The 3m Semi-anechoic chamber has been registered and fully described in a report with the (FCC) Federal Communications Commission. The acceptance letter from the FCC is maintained in our files.

- IC - Registration No.: 10668A-1

The 3m Semi-anechoic chamber of Shenzhen TCT Testing Technology Co., Ltd. has been registered by Certification and Engineering Bureau of Industry Canada for radio equipment testing

5.2. Location

Shenzhen Tongce Testing Lab

Address: 1B/F., Building 1, Yibaolai Industrial Park, Qiaotou, Fuyong, Baoan District, Shenzhen, Guangdong, China

TEL: +86-755-27673339

5.3. Measurement Uncertainty

The reported uncertainty of measurement $y \pm U$, where expanded uncertainty U is based on a standard uncertainty multiplied by a coverage factor of $k=2$, providing a level of confidence of approximately 95 %.

| No. | Item | MU |
|-----|-------------------------------|-------------------------|
| 1 | Conducted Emission | $\pm 2.56\text{dB}$ |
| 2 | RF power, conducted | $\pm 0.12\text{dB}$ |
| 3 | Spurious emissions, conducted | $\pm 0.11\text{dB}$ |
| 4 | All emissions, radiated(<1G) | $\pm 3.92\text{dB}$ |
| 5 | All emissions, radiated(>1G) | $\pm 4.28\text{dB}$ |
| 6 | Temperature | $\pm 0.1^\circ\text{C}$ |
| 7 | Humidity | $\pm 1.0\%$ |

6. Test Results and Measurement Data

6.1. Antenna requirement

Standard requirement:

FCC Part15 C Section 15.203 /247(c)

15.203 requirement:

An intentional radiator shall be designed to ensure that no antenna other than that furnished by the responsible party shall be used with the device. The use of a permanently attached antenna or of an antenna that uses a unique coupling to the intentional radiator, the manufacturer may design the unit so that a broken antenna can be replaced by the user, but the use of a standard antenna jack or electrical connector is prohibited.

15.247(c) (1)(i) requirement:

(i) Systems operating in the 2400-2483.5 MHz band that is used exclusively for fixed. Point-to-point operations may employ transmitting antennas with directional gain greater than 6dBi provided the maximum conducted output power of the intentional radiator is reduced by 1 dB for every 3 dB that the directional gain of the antenna exceeds 6dBi.

E.U.T Antenna:

The Bluetooth antenna is internal antenna which permanently attached, and the best case gain of the antenna is -1.2dBi.



BT/WIFI
Antenna

6.2. Conducted Emission

6.2.1. Test Specification

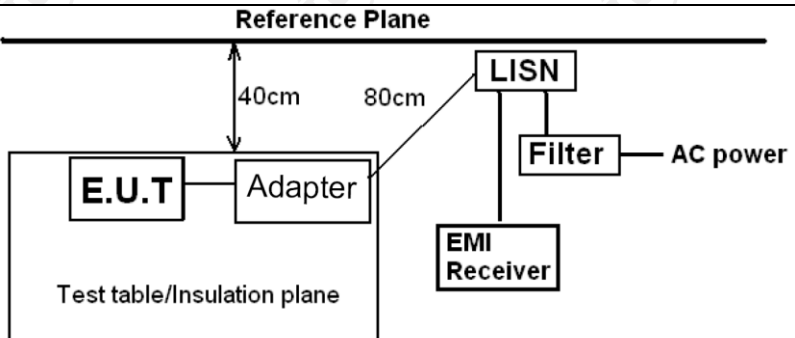
| Test Requirement: | FCC Part15 C Section 15.207 | | | | | | | | | | | | | | |
|--------------------------|---|-----------------------|--------------|--|------------|---------|----------|-----------|-----------|-------|----|----|------|----|----|
| Test Method: | ANSI C63.10:2013 | | | | | | | | | | | | | | |
| Frequency Range: | 150 kHz to 30 MHz | | | | | | | | | | | | | | |
| Receiver setup: | RBW=9 kHz, VBW=30 kHz, Sweep time=auto | | | | | | | | | | | | | | |
| Limits: | <table border="1"> <thead> <tr> <th rowspan="2">Frequency range (MHz)</th> <th colspan="2">Limit (dBuV)</th> </tr> <tr> <th>Quasi-peak</th> <th>Average</th> </tr> </thead> <tbody> <tr> <td>0.15-0.5</td> <td>66 to 56*</td> <td>56 to 46*</td> </tr> <tr> <td>0.5-5</td> <td>56</td> <td>46</td> </tr> <tr> <td>5-30</td> <td>60</td> <td>50</td> </tr> </tbody> </table> | Frequency range (MHz) | Limit (dBuV) | | Quasi-peak | Average | 0.15-0.5 | 66 to 56* | 56 to 46* | 0.5-5 | 56 | 46 | 5-30 | 60 | 50 |
| Frequency range (MHz) | Limit (dBuV) | | | | | | | | | | | | | | |
| | Quasi-peak | Average | | | | | | | | | | | | | |
| 0.15-0.5 | 66 to 56* | 56 to 46* | | | | | | | | | | | | | |
| 0.5-5 | 56 | 46 | | | | | | | | | | | | | |
| 5-30 | 60 | 50 | | | | | | | | | | | | | |
| Test Setup: |  <p><i>Remark:</i> E.U.T: Equipment Under Test LISN: Line Impedance Stabilization Network Test table height=0.8m</p> | | | | | | | | | | | | | | |
| Test Mode: | Charging + Transmitting Mode | | | | | | | | | | | | | | |
| Test Procedure: | <ol style="list-style-type: none"> 1. The E.U.T is connected to an adapter through a line impedance stabilization network (L.I.S.N.). This provides a 50ohm/50uH coupling impedance for the measuring equipment. 2. The peripheral devices are also connected to the main power through a LISN that provides a 50ohm/50uH coupling impedance with 50ohm termination. (Please refer to the block diagram of the test setup and photographs). 3. Both sides of A.C. line are checked for maximum conducted interference. In order to find the maximum emission, the relative positions of equipment and all of the interface cables must be changed according to ANSI C63.10: 2013 on conducted measurement. | | | | | | | | | | | | | | |
| Test Result: | PASS | | | | | | | | | | | | | | |

6.2.2. Test Instruments

| Conducted Emission Shielding Room Test Site (843) | | | | |
|---|-----------------------|-----------|---------------|-----------------|
| Equipment | Manufacturer | Model | Serial Number | Calibration Due |
| Test Receiver | R&S | ESPI | 101401 | Jun. 12, 2018 |
| LISN | Schwarzbeck | NSLK 8126 | 8126453 | Sep. 27, 2018 |
| Coax cable (9KHz-30MHz) | TCT | CE-05 | N/A | Sep. 27, 2018 |
| EMI Test Software | Shurple Technology | EZ-EMC | N/A | N/A |

Note: The calibration interval of the above test instruments is 12 months and the calibrations are traceable to international system unit (SI).

6.2.3. Test data

Please refer to following diagram for individual

Conducted Emission on Line Terminal of the power line (150 kHz to 30MHz)

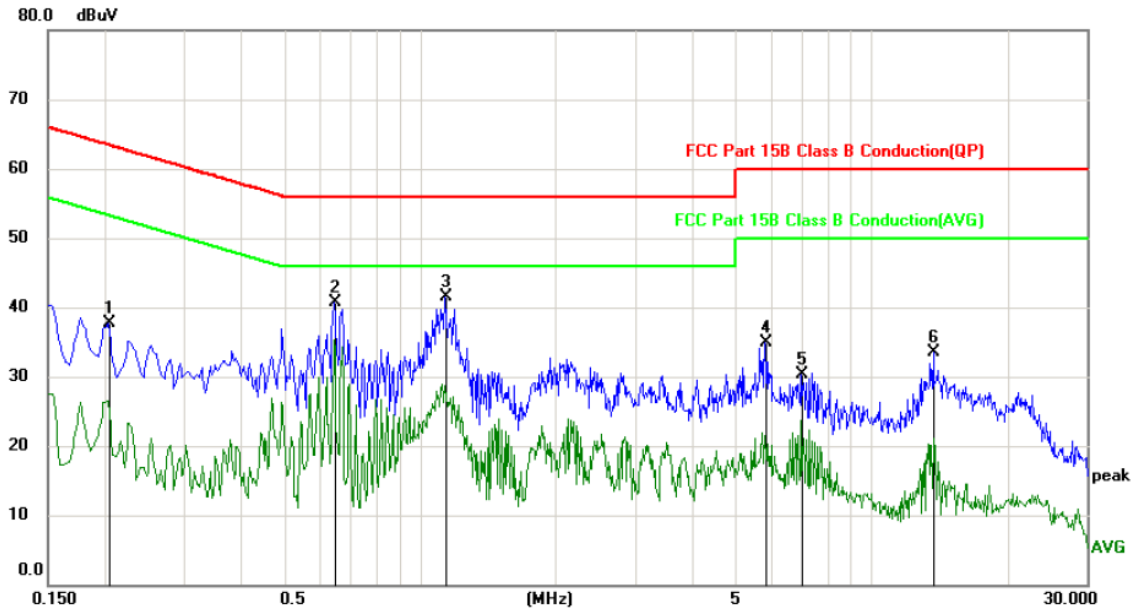

| | | |
|--|---------------------|-----------------|
| Site | Phase: L1 | Temperature: 25 |
| Limit: FCC Part 15B Class B Conduction(QP) | Power: AC 120V/60Hz | Humidity: 55 % |

| No. | Mk. | Freq. | Reading Level | Correct Factor | Measurement | Limit | Over | Detector | Comment |
|-----|-----|---------|---------------|----------------|-------------|-------|--------|----------|---------|
| | | MHz | dBµV | dB | dBµV | dBµV | dB | | |
| 1 | | 0.2040 | 26.30 | 11.37 | 37.67 | 63.45 | -25.78 | peak | |
| 2 | | 0.6449 | 29.48 | 11.15 | 40.63 | 56.00 | -15.37 | peak | |
| 3 | * | 1.1400 | 30.38 | 11.03 | 41.41 | 56.00 | -14.59 | peak | |
| 4 | | 5.8244 | 24.42 | 10.39 | 34.81 | 60.00 | -25.19 | peak | |
| 5 | | 6.9990 | 19.79 | 10.57 | 30.36 | 60.00 | -29.64 | peak | |
| 6 | | 13.7040 | 22.41 | 11.06 | 33.47 | 60.00 | -26.53 | peak | |

Note:

Freq. = Emission frequency in MHz

Reading level (dBµV) = Receiver reading

Corr. Factor (dB) = Antenna factor + Cable loss

Measurement (dBµV) = Reading level (dBµV) + Corr. Factor (dB)

Limit (dBµV) = Limit stated in standard

Margin (dB) = Measurement (dBµV) – Limits (dBµV)

Q.P. =Quasi-Peak

AVG =average

* is meaning the worst frequency has been tested in the frequency range 150 kHz to 30MHz

Conducted Emission on Neutral Terminal of the power line (150 kHz to 30MHz)

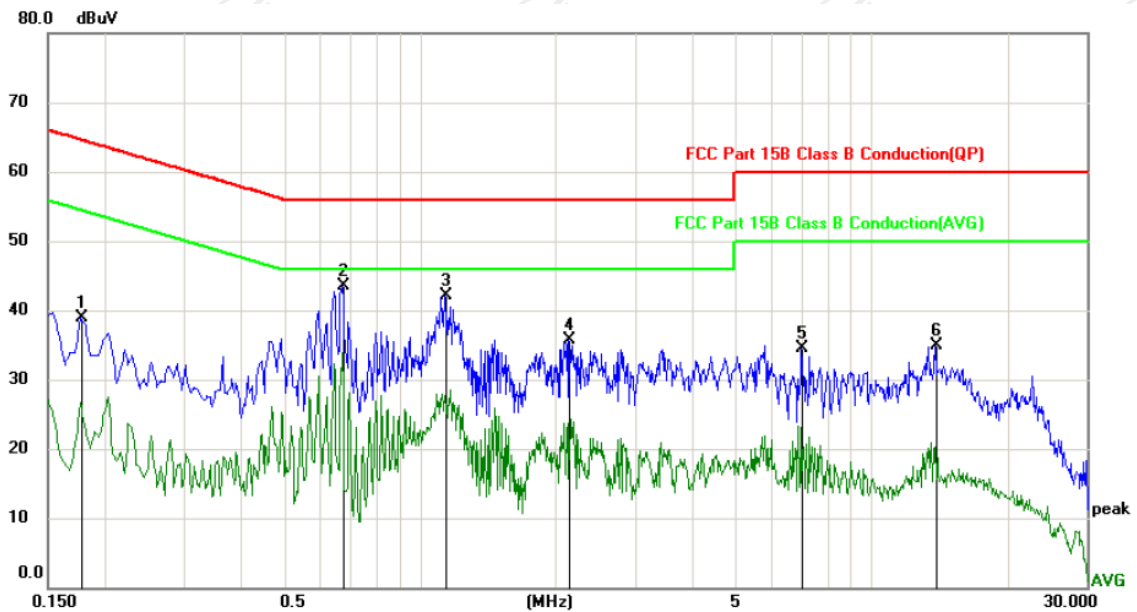

Site: _____ Phase: **N** Temperature: 25
 Limit: FCC Part 15B Class B Conduction(QP) Power: AC 120V/60Hz Humidity: 55 %

| No. | Mk. | Freq. MHz | Reading Level dBuV | Correct Factor dB | Measure- ment dBuV | Limit dBuV | Over dB | Detector | Comment |
|-----|-----|--------------|--------------------------|-------------------------|--------------------------|---------------|------------|----------|---------|
| 1 | | 0.1770 | 27.45 | 11.38 | 38.83 | 64.63 | -25.80 | peak | |
| 2 | * | 0.6719 | 32.46 | 11.13 | 43.59 | 56.00 | -12.41 | peak | |
| 3 | | 1.1400 | 31.00 | 11.03 | 42.03 | 56.00 | -13.97 | peak | |
| 4 | | 2.1389 | 24.34 | 11.32 | 35.66 | 56.00 | -20.34 | peak | |
| 5 | | 6.9990 | 24.01 | 10.57 | 34.58 | 60.00 | -25.42 | peak | |
| 6 | | 13.8975 | 23.80 | 11.06 | 34.86 | 60.00 | -25.14 | peak | |

Note1:

- Freq. = Emission frequency in MHz*
- Reading level (dBuV) = Receiver reading*
- Corr. Factor (dB) = Antenna factor + Cable loss*
- Measurement (dBuV) = Reading level (dBuV) + Corr. Factor (dB)*
- Limit (dBuV) = Limit stated in standard*
- Margin (dB) = Measurement (dBuV) – Limits (dBuV)*
- Q.P. =Quasi-Peak AVG =average*
- * is meaning the worst frequency has been tested in the frequency range 150 kHz to 30MHz.*

6.3. Conducted Output Power

6.3.1. Test Specification

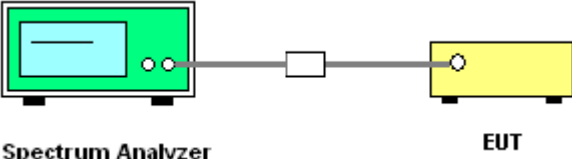
| | |
|--------------------------|---|
| Test Requirement: | FCC Part15 C Section 15.247 (b)(3) |
| Test Method: | KDB558074 |
| Limit: | 30dBm |
| Test Setup: |  <p style="text-align: center;">Spectrum Analyzer EUT</p> |
| Test Mode: | Refer to item 4.1 |
| Test Procedure: | <ol style="list-style-type: none"> 1. The testing follows the Measurement Procedure of FCC KDB No. 558074 DTS D01 Meas. Guidance v04. 2. Set spectrum analyzer as following: <ol style="list-style-type: none"> a) Set the RBW \geq DTS bandwidth. b) Set VBW \geq 3 x RBW. c) Set span \geq 3 x RBW d) Sweep time = auto couple. e) Detector = peak. f) Trace mode = max hold. g) Allow trace to fully stabilize. h) Use peak marker function to determine the peak amplitude level. |
| Test Result: | PASS |

6.3.2. Test Instruments

| Equipment | Manufacturer | Model | Serial Number | Calibration Due |
|----------------------------|--------------|--------|---------------|-----------------|
| Spectrum Analyzer | Agilent | N9020A | MY49100060 | Sep. 27, 2018 |
| RF cable (9kHz-26.5GHz) | TCT | RE-06 | N/A | Sep. 27, 2018 |
| Antenna Connector | TCT | RFC-01 | N/A | Sep. 27, 2018 |

Note: The calibration interval of the above test instruments is 12 months and the calibrations are traceable to international system unit (SI).

6.3.3. Test Data

| BT LE mode | | | |
|--------------|--------------------------------------|-------------|--------|
| Test channel | Maximum Conducted Output Power (dBm) | Limit (dBm) | Result |
| Lowest | -5.07 | 30.00 | PASS |
| Middle | -5.68 | 30.00 | PASS |
| Highest | -6.23 | 30.00 | PASS |

Test plots as follows:



BT LE mode

Lowest channel



Middle channel

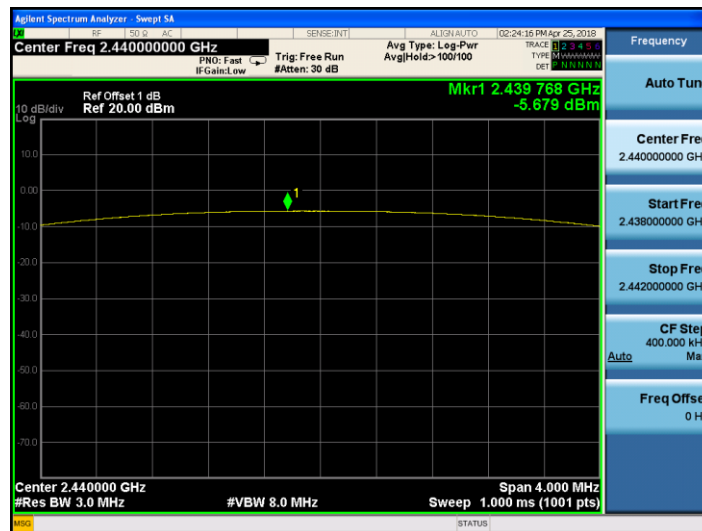

Highest channel

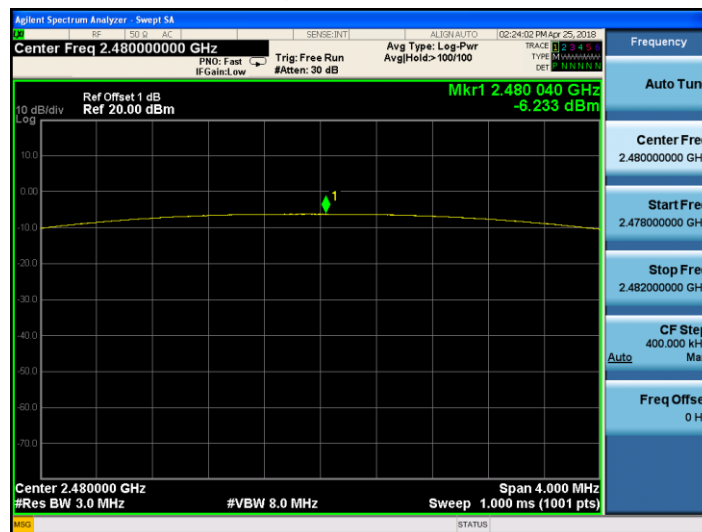

6.4. Emission Bandwidth

6.4.1. Test Specification

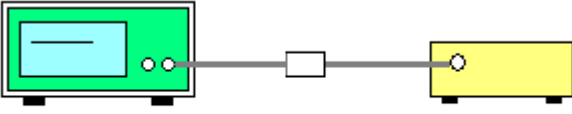
| | |
|--------------------------|--|
| Test Requirement: | FCC Part15 C Section 15.247 (a)(2) |
| Test Method: | KDB558074 |
| Limit: | >500kHz |
| Test Setup: |  <p style="text-align: center;">Spectrum Analyzer EUT</p> |
| Test Mode: | Refer to item 4.1 |
| Test Procedure: | <ol style="list-style-type: none"> 1. The testing follows FCC KDB Publication No. 558074 DTS D01 Meas. Guidance v04. 2. Set to the maximum power setting and enable the EUT transmit continuously. 3. Make the measurement with the spectrum analyzer's resolution bandwidth (RBW) = 100 kHz. Set the Video bandwidth (VBW) = 300 kHz. In order to make an accurate measurement. The 6dB bandwidth must be greater than 500 kHz. 4. Measure and record the results in the test report. |
| Test Result: | PASS |

6.4.2. Test Instruments

| RF Test Room | | | | |
|----------------------------|--------------|--------|---------------|-----------------|
| Equipment | Manufacturer | Model | Serial Number | Calibration Due |
| Spectrum Analyzer | Agilent | N9020A | MY49100060 | Sep. 27, 2018 |
| RF cable (9kHz-26.5GHz) | TCT | RE-06 | N/A | Sep. 27, 2018 |
| Antenna Connector | TCT | RFC-01 | N/A | Sep. 27, 2018 |

Note: The calibration interval of the above test instruments is 12 months and the calibrations are traceable to international system unit (SI).

6.4.3. Test data

| Test channel | 6dB Emission Bandwidth (kHz) | | |
|--------------|------------------------------|-------|--------|
| | BT LE mode | Limit | Result |
| Lowest | 714.8 | >500k | PASS |
| Middle | 714.1 | >500k | |
| Highest | 714.5 | >500k | |

Test plots as follows:



BT LE mode

Lowest channel

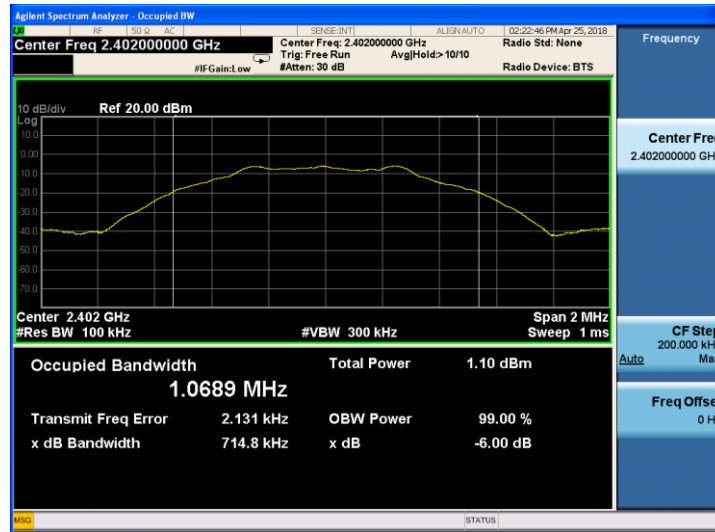

Middle channel



Highest channel

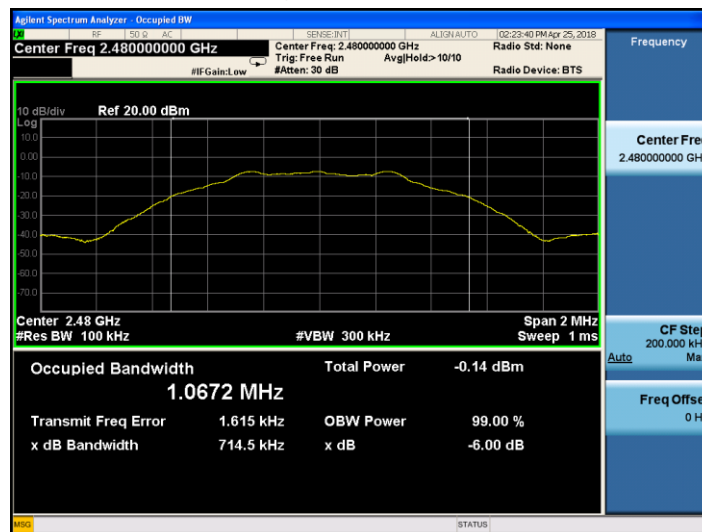

6.5. Power Spectral Density

6.6. Test Specification

| | |
|--------------------------|--|
| Test Requirement: | FCC Part15 C Section 15.247 (e) |
| Test Method: | KDB558074 |
| Limit: | The peak power spectral density shall not be greater than 8dBm in any 3kHz band at any time interval of continuous transmission. |
| Test Setup: |  <p style="text-align: center;">Spectrum Analyzer EUT</p> |
| Test Mode: | Refer to item 4.1 |
| Test Procedure: | <ol style="list-style-type: none"> 1. The testing follows Measurement Procedure 10.2 Method PKPSD of FCC KDB Publication No.558074 D01 DTS Meas. Guidance v04 2. The RF output of EUT was connected to the spectrum analyzer by RF cable and attenuator. The path loss was compensated to the results for each measurement. 3. Set to the maximum power setting and enable the EUT transmit continuously. 4. Make the measurement with the spectrum analyzer's resolution bandwidth (RBW): $3 \text{ kHz} \leq \text{RBW} \leq 100 \text{ kHz}$. Video bandwidth VBW $\geq 3 \times \text{RBW}$. In order to make an accurate measurement, set the span to 1.5 times DTS Channel Bandwidth. (6dB BW) 5. Detector = peak, Sweep time = auto couple, Trace mode = max hold, Allow trace to fully stabilize. Use the peak marker function to determine the maximum power level. 6. Measure and record the results in the test report. |
| Test Result: | PASS |

6.6.1. Test Instruments

| RF Test Room | | | | |
|----------------------------|--------------|--------|---------------|-----------------|
| Equipment | Manufacturer | Model | Serial Number | Calibration Due |
| Spectrum Analyzer | Agilent | N9020A | MY49100060 | Sep. 27, 2018 |
| RF cable (9kHz-26.5GHz) | TCT | RE-06 | N/A | Sep. 27, 2018 |
| Antenna Connector | TCT | RFC-01 | N/A | Sep. 27, 2018 |

Note: The calibration interval of the above test instruments is 12 months and the calibrations are traceable to international system unit (SI).

6.6.2. Test data

| Test channel | Power Spectral Density (dBm/3kHz) | | |
|--------------|-----------------------------------|------------|--------|
| | BT LE mode | Limit | Result |
| Lowest | -20.27 | 8 dBm/3kHz | PASS |
| Middle | -20.88 | 8 dBm/3kHz | |
| Highest | -21.48 | 8 dBm/3kHz | |

Test plots as follows:



BT LE mode

Lowest channel

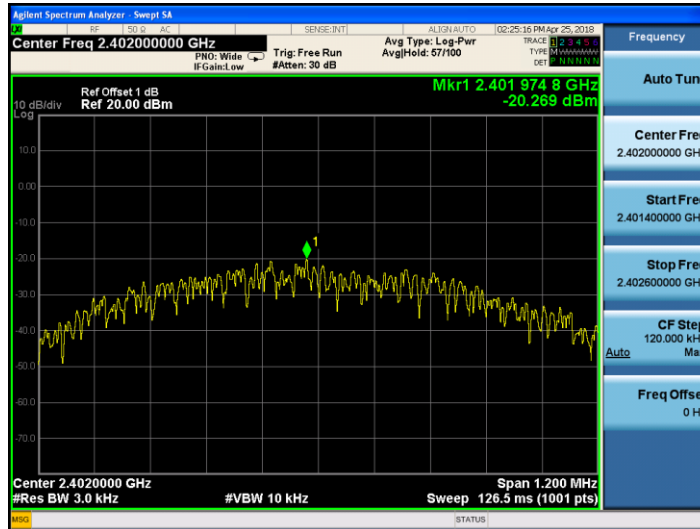

Middle channel

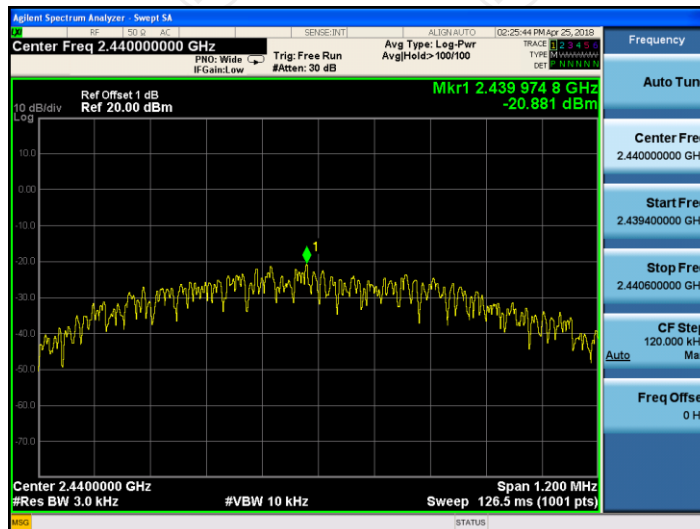

Highest channel

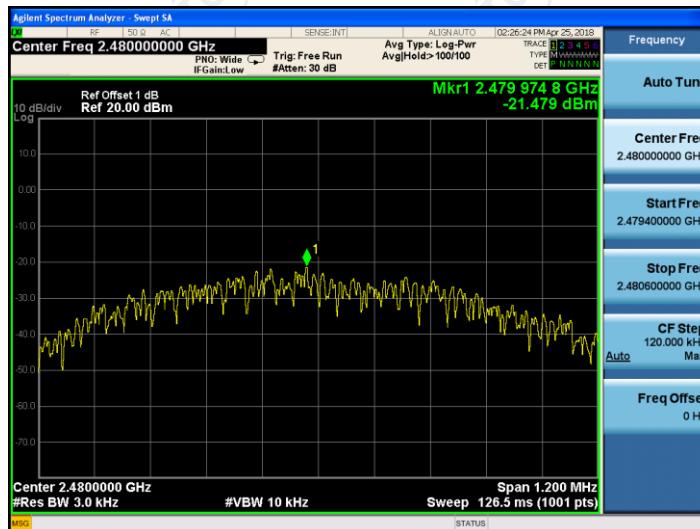

6.7. Conducted Band Edge and Spurious Emission Measurement

6.7.1. Test Specification

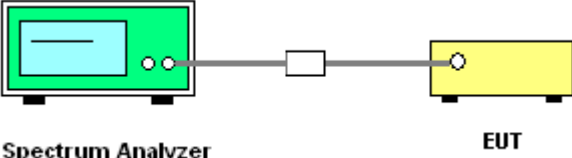
| | |
|--------------------------|---|
| Test Requirement: | FCC Part15 C Section 15.247 (d) |
| Test Method: | KDB558074 |
| Limit: | In any 100 kHz bandwidth outside of the authorized frequency band, the emissions which fall in the non-restricted bands shall be attenuated at least 20 dB / 30dB relative to the maximum PSD level in 100 kHz by RF conducted measurement and radiated emissions which fall in the restricted bands, as defined in Section 15.205(a), must also comply with the radiated emission limits specified in Section 15.209(a). |
| Test Setup: |  <p style="text-align: center;">Spectrum Analyzer EUT</p> |
| Test Mode: | Refer to item 4.1 |
| Test Procedure: | <ol style="list-style-type: none"> 1. The RF output of EUT was connected to the spectrum analyzer by RF cable and attenuator. The path loss was compensated to the results for each measurement. 2. Set to the maximum power setting and enable the EUT transmit continuously. 3. Set RBW = 100 kHz, VBW=300 kHz, Peak Detector. Unwanted Emissions measured in any 100 kHz bandwidth outside of the authorized frequency band shall be attenuated by at least 20 dB relative to the maximum in-band peak PSD level in 100 kHz when maximum peak conducted output power procedure is used. If the transmitter complies with the conducted power limits based on the use of RMS averaging over a time interval, the attenuation required under this paragraph shall be 30 dB instead of 20 dB per 15.247(d). 4. Measure and record the results in the test report. 5. The RF fundamental frequency should be excluded against the limit line in the operating frequency band. |
| Test Result: | PASS |

6.7.2. Test Instruments

| RF Test Room | | | | |
|----------------------------|---------------|--------|---------------|-----------------|
| Equipment | Manufacturer | Model | Serial Number | Calibration Due |
| Spectrum Analyzer | Agilent | N9020A | MY49100060 | Sep. 27, 2018 |
| Spectrum Analyzer | ROHDE&SCHWARZ | FSQ | 200061 | Sep. 27, 2018 |
| RF cable (9kHz-26.5GHz) | TCT | RE-06 | N/A | Sep. 27, 2018 |
| Antenna Connector | TCT | RFC-01 | N/A | Sep. 27, 2018 |

Note: The calibration interval of the above test instruments is 12 months and the calibrations are traceable to international system unit (SI).

6.7.3. Test Data

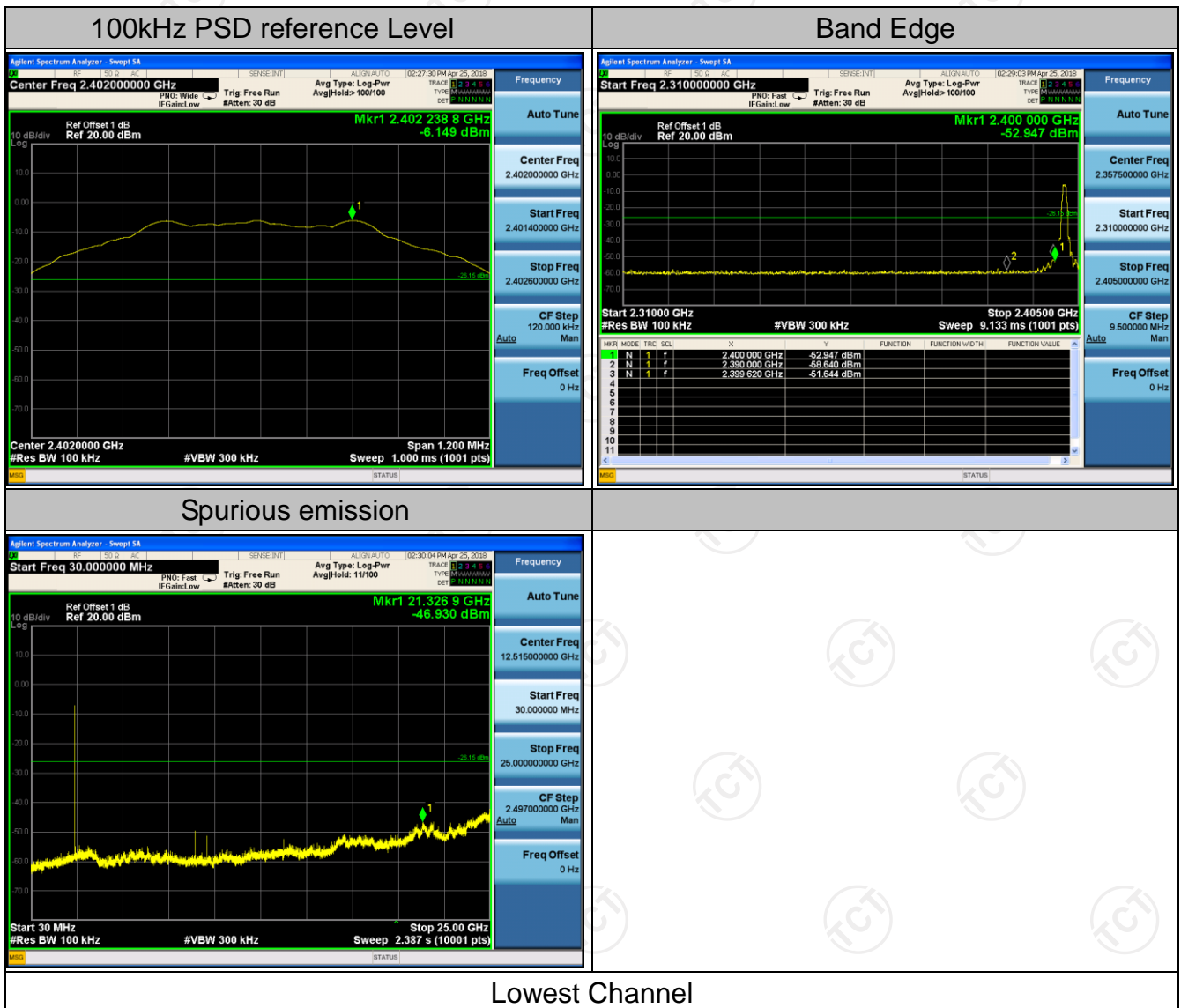

100kHz PSD reference Level

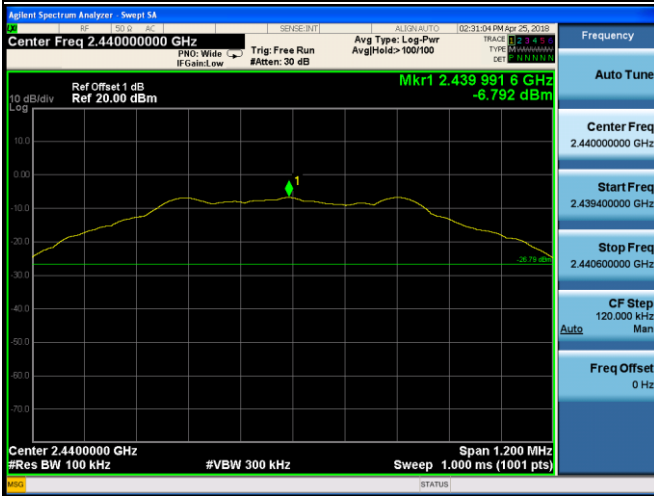

Spurious emission



Middle Channel

100kHz PSD reference Level

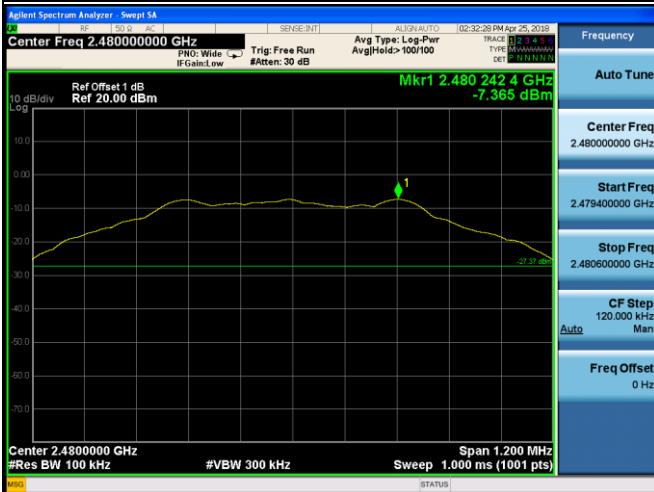

Band Edge

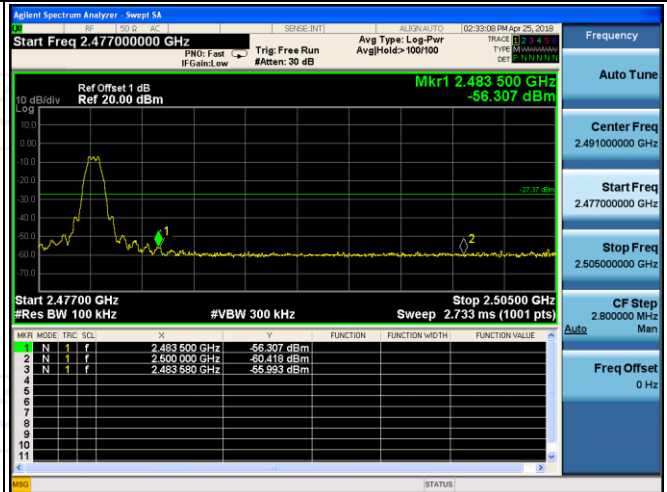

Spurious emission

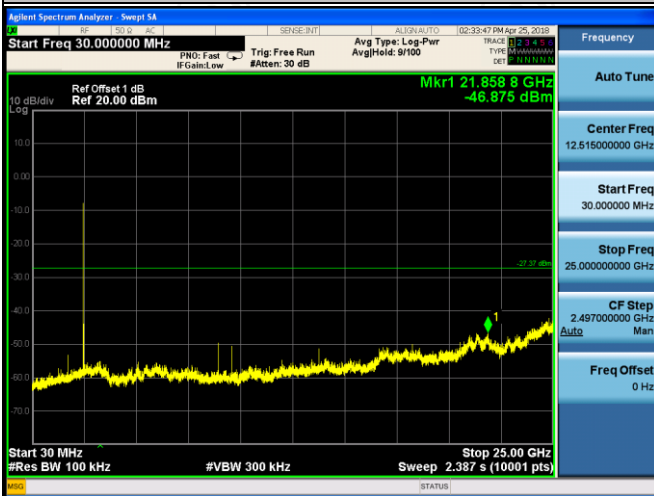

Highest Channel

6.8. Radiated Spurious Emission Measurement

6.8.1. Test Specification

| | | | | | | |
|------------------------------|---|-----------------------------------|-------------------------------|----------|------------------|--|
| Test Requirement: | FCC Part15 C Section 15.209 | | | | | |
| Test Method: | ANSI C63.10: 2013 | | | | | |
| Frequency Range: | 9 kHz to 25 GHz | | | | | |
| Measurement Distance: | 3 m | | | | | |
| Antenna Polarization: | Horizontal & Vertical | | | | | |
| Operation mode: | Refer to item 4.1 | | | | | |
| Receiver Setup: | Frequency | Detector | RBW | VBW | Remark | |
| | 9kHz- 150kHz | Quasi-peak | 200Hz | 1kHz | Quasi-peak Value | |
| | 150kHz- 30MHz | Quasi-peak | 9kHz | 30kHz | Quasi-peak Value | |
| | 30MHz-1GHz | Quasi-peak | 100KHz | 300KHz | Quasi-peak Value | |
| | Above 1GHz | Peak | 1MHz | 3MHz | Peak Value | |
| | | Peak | 1MHz | 10Hz | Average Value | |
| Limit: | Frequency | Field Strength (microvolts/meter) | Measurement Distance (meters) | | | |
| | 0.009-0.490 | 2400/F(KHz) | 300 | | | |
| | 0.490-1.705 | 24000/F(KHz) | 30 | | | |
| | 1.705-30 | 30 | 30 | | | |
| | 30-88 | 100 | 3 | | | |
| | 88-216 | 150 | 3 | | | |
| | 216-960 | 200 | 3 | | | |
| | Above 960 | 500 | 3 | | | |
| | Frequency | Field Strength (microvolts/meter) | Measurement Distance (meters) | Detector | | |
| | Above 1GHz | 500 | 3 | Average | | |
| | 5000 | 3 | Peak | | | |
| Test setup: | For radiated emissions below 30MHz | | | | | |
| | <p>Distance = 3m</p> <p>EUT</p> <p>Turn table</p> <p>Ground Plane</p> <p>Pre -Amplifier</p> <p>Receiver</p> <p>Computer</p> | | | | | |
| | 30MHz to 1GHz | | | | | |

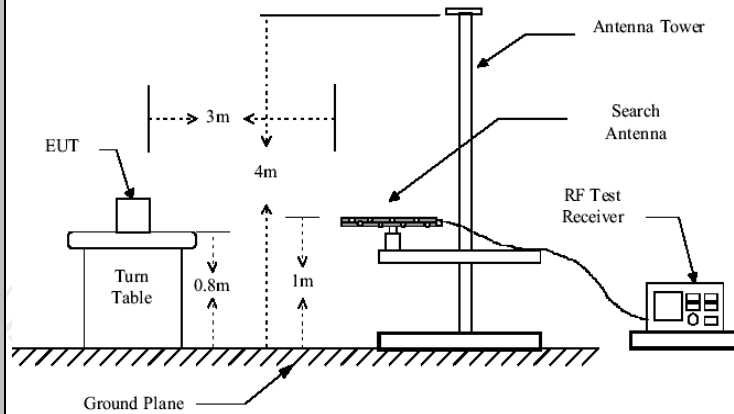

Above 1GHz

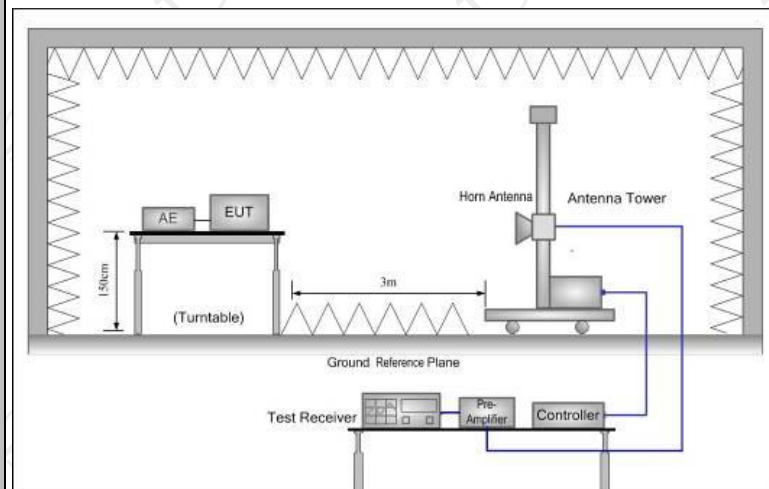

Test Procedure:

1. For the radiated emission test below 1GHz:
The EUT was placed on a turntable with 0.8 meter above ground. The EUT was set 3 meters from the interference receiving antenna, which was mounted on the top of a variable height antenna tower. The EUT was arranged to its worst case and then tune the antenna tower (from 1 m to 4 m) and turntable (from 0 degree to 360 degrees) to find the maximum reading. A pre-amp and a high PASS filter are used for the test in order to get better signal level.
For the radiated emission test above 1GHz:
Place the measurement antenna on a turntable with 1.5 meter above ground, which is away from each area of the EUT determined to be a source of emissions at the specified measurement distance, while keeping the measurement antenna aimed at the source of emissions at each frequency of significant emissions, with polarization oriented for maximum response. The measurement antenna may have to be higher or lower than the EUT, depending on the radiation pattern of the emission and staying aimed at the emission source for receiving the maximum signal. The final

| | |
|----------------------|--|
| | <p>measurement antenna elevation shall be that which maximizes the emissions. The measurement antenna elevation for maximum emissions shall be restricted to a range of heights of from 1 m to 4 m above the ground or reference ground plane.</p> <p>2. Corrected Reading: Antenna Factor + Cable Loss + Read Level - Preamp Factor = Level</p> <p>3. For measurement below 1GHz, If the emission level of the EUT measured by the peak detector is 3 dB lower than the applicable limit, the peak emission level will be reported. Otherwise, the emission measurement will be repeated using the quasi-peak detector and reported.</p> <p>4. Use the following spectrum analyzer settings:</p> <p>(1) Span shall wide enough to fully capture the emission being measured;</p> <p>(2) Set RBW=100 kHz for $f < 1$ GHz; $VBW \geq RBW$; Sweep = auto; Detector function = peak; Trace = max hold;</p> <p>(3) Set RBW = 1 MHz, VBW= 3MHz for $f \geq 1$ GHz for peak measurement.</p> <p>For average measurement: $VBW = 10$ Hz, when duty cycle is no less than 98 percent. $VBW \geq 1/T$, when duty cycle is less than 98 percent where T is the minimum transmission duration over which the transmitter is on and is transmitting at its maximum power control level for the tested mode of operation.</p> |
| Test mode: | Refer to section 4.1 for details |
| Test results: | PASS |

6.8.2. Test Instruments

| Radiated Emission Test Site (966) | | | | |
|-----------------------------------|--|------------|---------------|-----------------|
| Name of Equipment | Manufacturer | Model | Serial Number | Calibration Due |
| Test Receiver | ROHDE&SCHW ARZ | ESVD | 100008 | Sep. 27, 2018 |
| Spectrum Analyzer | ROHDE&SCHW ARZ | FSQ | 200061 | Sep. 27, 2018 |
| Pre-amplifier | EM Electronics Corporation CO.,LTD | EM30265 | 07032613 | Sep. 27, 2018 |
| Pre-amplifier | HP | 8447D | 2727A05017 | Sep. 27, 2018 |
| Loop antenna | ZHINAN | ZN30900A | 12024 | Sep. 27, 2018 |
| Broadband Antenna | Schwarzbeck | VULB9163 | 340 | Sep. 27, 2018 |
| Horn Antenna | Schwarzbeck | BBHA 9120D | 631 | Sep. 27, 2018 |
| Horn Antenna | Schwarzbeck | BBH 9170 | 582 | Jun. 07, 2018 |
| Antenna Mast | Keleto | CC-A-4M | N/A | N/A |
| Coax cable (9KHz-1GHz) | TCT | RE-low-01 | N/A | Sep. 27, 2018 |
| Coax cable (9KHz-40GHz) | TCT | RE-high-02 | N/A | Sep. 27, 2018 |
| Coax cable (9KHz-1GHz) | TCT | RE-low-03 | N/A | Sep. 27, 2018 |
| Coax cable (9KHz-40GHz) | TCT | RE-high-04 | N/A | Sep. 27, 2018 |
| EMI Test Software | Shurple Technology | EZ-EMC | N/A | N/A |

Note: The calibration interval of the above test instruments is 12 months and the calibrations are traceable to international system unit (SI).

6.8.3. Test Data

Please refer to following diagram for individual
Below 1GHz

Horizontal:

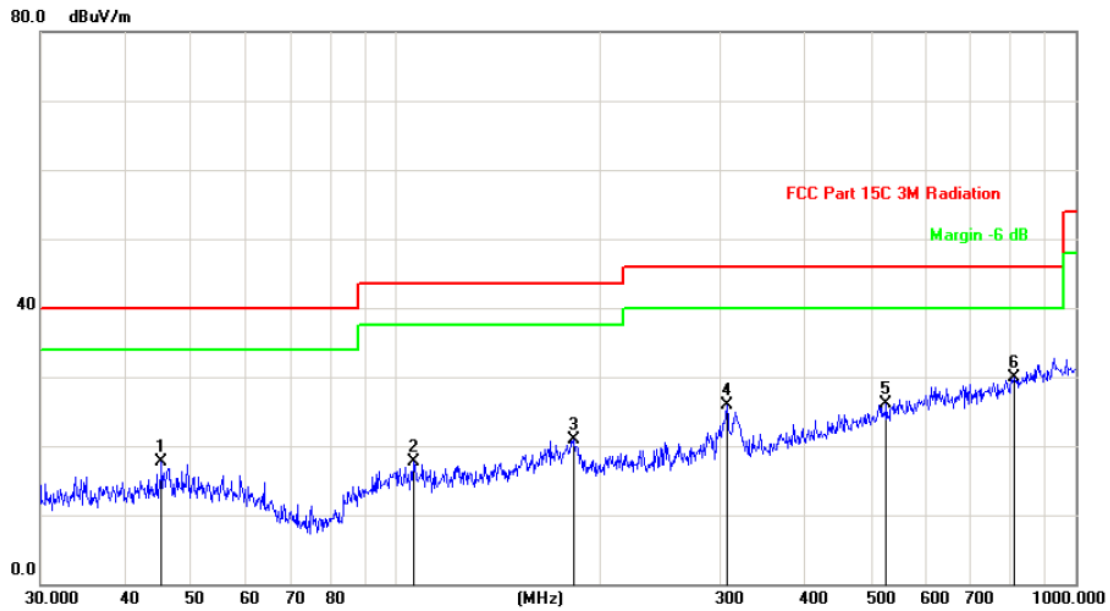

Site: Polarization: *Horizontal* Temperature: 25
Limit: FCC Part 15C 3M Radiation Power: Humidity: 55 %

| No. | Mk. | Freq. | Reading Level | Correct Factor | Measurement | Limit | Over | Antenna Height | Table Degree | |
|-----|-----|----------|---------------|----------------|-------------|-------|--------|----------------|--------------|---------|
| | | MHz | dBuV | dB | dBuV/m | dB/m | dB | cm | degree | Comment |
| 1 | | 45.2166 | 30.39 | -12.73 | 17.66 | 40.00 | -22.34 | peak | | |
| 2 | | 106.0126 | 29.86 | -12.25 | 17.61 | 43.50 | -25.89 | peak | | |
| 3 | | 182.5592 | 34.74 | -13.80 | 20.94 | 43.50 | -22.56 | peak | | |
| 4 | | 306.7537 | 34.49 | -8.50 | 25.99 | 46.00 | -20.01 | peak | | |
| 5 | | 526.3967 | 28.54 | -2.49 | 26.05 | 46.00 | -19.95 | peak | | |
| 6 | * | 813.1115 | 27.76 | 2.09 | 29.85 | 46.00 | -16.15 | peak | | |

Vertical:

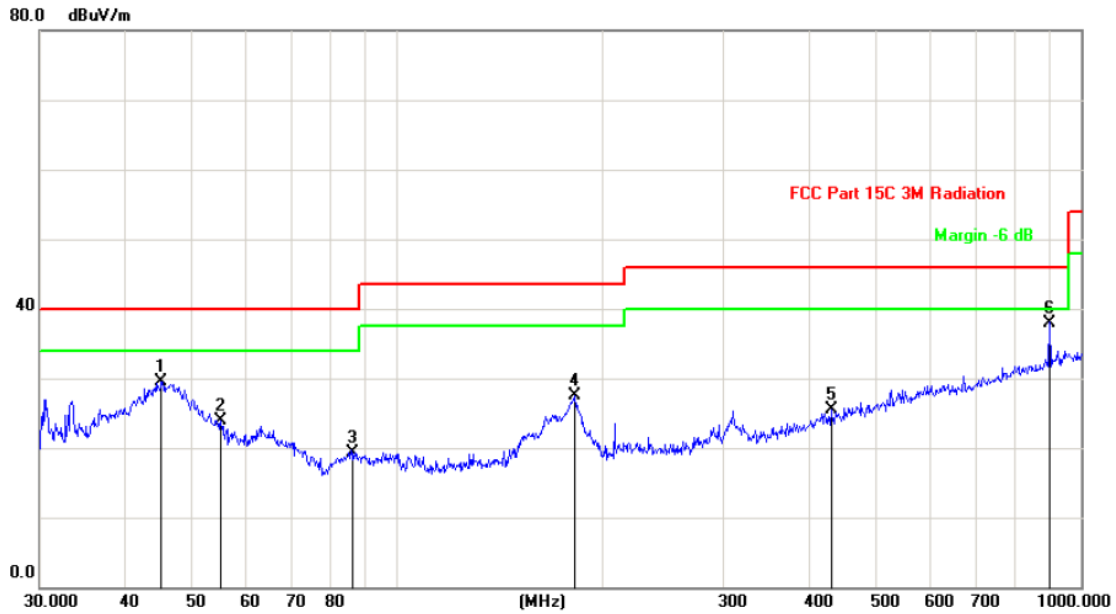

Site: Polarization: **Vertical** Temperature: 25
 Limit: FCC Part 15C 3M Radiation Power: Humidity: 55 %

| No. | Mk. | Freq. MHz | Reading Level dBuV | Correct Factor dB | Measure- ment dBuV/m | Limit dB/m | Over dB | Antenna Height cm | Table Degree | Comment |
|-----|-----|--------------|--------------------------|-------------------------|----------------------------|---------------|------------|-------------------------|-----------------|---------|
| 1 | | 45.2165 | 42.21 | -12.73 | 29.48 | 40.00 | -10.52 | peak | | |
| 2 | | 55.2207 | 36.99 | -13.05 | 23.94 | 40.00 | -16.06 | peak | | |
| 3 | | 86.2001 | 34.42 | -15.05 | 19.37 | 40.00 | -20.63 | peak | | |
| 4 | | 181.9201 | 41.29 | -13.84 | 27.45 | 43.50 | -16.05 | peak | | |
| 5 | | 431.0316 | 30.47 | -4.95 | 25.52 | 46.00 | -20.48 | peak | | |
| 6 | * | 900.1473 | 34.71 | 3.29 | 38.00 | 46.00 | -8.00 | peak | | |

Note: 1. The low frequency, which started from 9KHz~30MHz, was pre-scanned and the result which was 20dB lower than the limit line per 15.31(o) was not reported

2. Measurements were conducted in all three channels (high, middle, low), and the worst case Mode (Lowest channel) was submitted only.

Above 1GHz

| Low channel: 2402 MHz | | | | | | | | | |
|-----------------------|---------------|---------------------------|-------------------------|--------------------------|---------------------|-------------------|---------------------------|-------------------------|-------------|
| Frequency (MHz) | Ant. Pol. H/V | Peak reading (dB μ V) | AV reading (dB μ V) | Correction Factor (dB/m) | Emission Level | | Peak limit (dB μ V/m) | AV limit (dB μ V/m) | Margin (dB) |
| | | | | | Peak (dB μ V/m) | AV (dB μ V/m) | | | |
| 2390 | H | 46.13 | --- | -7.52 | 38.61 | --- | 74 | 54 | -15.39 |
| 4804 | H | 43.08 | --- | 7.44 | 50.52 | --- | 74 | 54 | -3.48 |
| 7206 | H | 37.83 | --- | 13.54 | 51.37 | --- | 74 | 54 | -2.63 |
| --- | H | --- | --- | --- | --- | --- | --- | --- | --- |
| 2390 | V | 45.91 | --- | -7.52 | 38.39 | --- | 74 | 54 | -15.61 |
| 4804 | V | 42.67 | --- | 7.44 | 50.11 | --- | 74 | 54 | -3.89 |
| 7206 | V | 37.68 | --- | 13.54 | 51.22 | --- | 74 | 54 | -2.78 |
| --- | V | --- | --- | --- | --- | --- | --- | --- | --- |

| Middle channel: 2440MHz | | | | | | | | | |
|-------------------------|---------------|---------------------------|-------------------------|--------------------------|---------------------|-------------------|---------------------------|-------------------------|-------------|
| Frequency (MHz) | Ant. Pol. H/V | Peak reading (dB μ V) | AV reading (dB μ V) | Correction Factor (dB/m) | Emission Level | | Peak limit (dB μ V/m) | AV limit (dB μ V/m) | Margin (dB) |
| | | | | | Peak (dB μ V/m) | AV (dB μ V/m) | | | |
| 4880 | H | 42.36 | --- | 7.01 | 49.37 | --- | 74 | 54 | -4.63 |
| 7320 | H | 37.55 | --- | 13.21 | 50.76 | --- | 74 | 54 | -3.24 |
| --- | H | --- | --- | --- | --- | --- | --- | --- | --- |
| 4880 | V | 43.68 | --- | 7.01 | 50.69 | --- | 74 | 54 | -3.31 |
| 7320 | V | 37.26 | --- | 13.21 | 50.47 | --- | 74 | 54 | -3.53 |
| --- | V | --- | --- | --- | --- | --- | --- | --- | --- |

| High channel: 2480 MHz | | | | | | | | | |
|------------------------|---------------|---------------------------|-------------------------|--------------------------|---------------------|-------------------|---------------------------|-------------------------|-------------|
| Frequency (MHz) | Ant. Pol. H/V | Peak reading (dB μ V) | AV reading (dB μ V) | Correction Factor (dB/m) | Emission Level | | Peak limit (dB μ V/m) | AV limit (dB μ V/m) | Margin (dB) |
| | | | | | Peak (dB μ V/m) | AV (dB μ V/m) | | | |
| 2483.5 | H | 46.85 | --- | -7.52 | 39.33 | --- | 74 | 54 | -14.67 |
| 4960 | H | 41.03 | --- | 7.44 | 48.47 | --- | 74 | 54 | -5.53 |
| 7440 | H | 34.94 | --- | 13.54 | 48.48 | --- | 74 | 54 | -5.52 |
| --- | H | --- | --- | --- | --- | --- | --- | --- | --- |
| 2483.5 | V | 48.04 | --- | -7.52 | 40.52 | --- | 74 | 54 | -13.48 |
| 4960 | V | 42.32 | --- | 7.44 | 49.76 | --- | 74 | 54 | -4.24 |
| 7440 | V | 34.85 | --- | 13.54 | 48.39 | --- | 74 | 54 | -5.61 |
| --- | V | --- | --- | --- | --- | --- | --- | --- | --- |

Note:

1. Emission Level=Peak Reading + Correction Factor; Correction Factor=Antenna Factor + Cable loss – Pre-amplifier
2. Margin (dB) = Emission Level (Peak) (dB μ V/m)-Average limit (dB μ V/m)
3. The emission levels of other frequencies are very lower than the limit and not show in test report.
4. Measurements were conducted from 1 GHz to the 10th harmonic of highest fundamental frequency.
5. Data of measurement shown "—" in the above table mean that the reading of emissions is attenuated more than 20 dB below the limits or the field strength is too small to be measured.

Appendix A: Photographs of Test Setup

Refer to test report TCT180328E019

Appendix B: Photographs of EUT

Refer to test report TCT180328E019

*******END OF REPORT*******