

<p><b>MODBUS INTERFACE MODULE</b>                  (Modbus Wired Communication, Modbus-RTU Transparent 900 MHz Band Devices Use)</p>	<p><b>MODEL R3-NMW1F</b></p>
--	------------------------------

**BEFORE USE ....**

Thank you for choosing M-System. Before use, please check contents of the package you received as outlined below. If you have any problems or questions with the product, please contact M-System's Sales Office or representatives.

**■ PACKAGE INCLUDES:**

- Modbus interface module.....(1)
- Antenna .....(1)
- Terminating resistor (110 Ω, 0.25 W).....(1)

**■ MODEL NO.**

Confirm Model No. marking on the product to be exactly what you ordered.

**■ INSTRUCTION MANUAL**

This manual describes necessary points of caution when you use this product, including installation, connection and basic maintenance procedures.

This manual describes necessary points of caution when you use this product, including installation, connection and basic maintenance procedures.

For information on the introduction of wireless device, refer to the 900 MHz band wireless device users manual (EM-9085).

**POINTS OF CAUTION**

**■ POWER INPUT RATING & OPERATIONAL RANGE**

- Locate the power input rating marked on the product and confirm its operational range as indicated below:
  - 100 – 240V AC rating: 85 – 264V, 47 – 66 Hz,  
 approx. 15VA at 100V AC  
 approx. 20VA at 200V AC  
 approx. 21.5VA at 240V AC
  - 24V DC rating: 24V ±10%, approx. 8.5W

**■ HOT-SWAPPABLE MODULES**

- The module can be replaced while the power is ON. Be sure to replace it when the module is not communicating with a host, as it may affect the system. Replacing multiple modules at once may greatly change line voltage levels. We highly recommend to replace them one by one.

**■ ENVIRONMENT**

- Indoor use.
- Attach the antenna to the unit.
- When heavy dust or metal particles are present in the air, install the unit inside proper housing with sufficient ventilation.

- Do not install the unit where it is subjected to continuous vibration. Do not subject the unit to physical impact.
- Environmental temperature must be within -10 to +55°C (14 to 131°F) with relative humidity within 30 to 90% RH in order to ensure adequate life span and operation.
- Attachment and adjustment of sleeve antenna: Loosen the connector (See the below figure), and rotate the antenna. Holding the antenna vertically, tighten the connector by hand. Make sure to fix the antenna firmly.

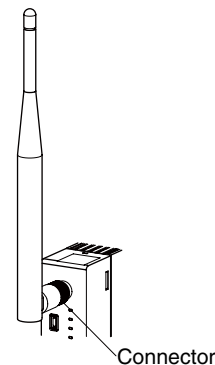

- Attachment of rooftop antenna: The magnet on the bottom face allows the antenna to be attached on a metal box and such. To obtain optimum performance from the antenna, attach it on a metal plate (recommended dimension: 500 mm × 500 mm or more). However, in the case of connecting FE1 or FG of the power supply module to a metal plate, the isolation between FE1 or FG and the internal bus or internal power or antenna connector will be lost. Tighten the connector with a specified torque (0.9 N·m). As a guide, finger-tighten the connector until it stops, and then rotate it 10 to 15 degrees with a wrench. Do not force the cable to bend beyond the acceptable bending radius of 3 cm.
- Please note that using 7.5 m coaxial cable (model: CX-SAC0SAD0Q0750) (OKI) for extension decreases transmission distance.

**■ WIRING**

- Do not install cables close to noise sources (relay drive cable, high frequency line, etc.).
- Do not bind these cables together with those in which noises are present. Do not install them in the same duct.

**■ AND ....**

- The unit is designed to function as soon as power is supplied, however, a warm up for 10 minutes is required for satisfying complete performance described in the data sheet.

## CAUTION REGARDING RADIO FREQUENCY

### ■ FCC NOTICE

- This device complies with part 15 of the FCC Rules. Operation is subject to the following two conditions:  
(1) This device may not cause harmful interference, and  
(2) this device must accept any interference received, including interference that may cause undesired operation.

### ■ FCC CAUTION

- Changes or modifications not expressly approved by the party responsible for compliance could void the user's authority to operate the equipment.

### ■ NOTE

- This equipment has been tested and found to comply with the limits for a Class A digital device, pursuant to part 15 of the FCC Rules. These limits are designed to provide reasonable protection against harmful interference when the equipment is operated in a commercial environment. This equipment generates, uses, and can radiate radio frequency energy and, if not installed and used in accordance with the instruction manual, may cause harmful interference to radio communications. Operation of this equipment in a residential area is likely to cause harmful interference in which case the user will be required to correct the interference at his own expense.
- This transmitter must not be co-located or operated in conjunction with any other antenna or transmitter.

### ■ FCC RF EXPOSURE INFORMATION

- This equipment complies with FCC radiation exposure limits set forth for an uncontrolled environment and meets the FCC radio frequency (RF) Exposure Guidelines. This equipment should be installed and operated keeping the radiator at least 20 cm or more away from person's body.

FCC ID: 2AOTF-0000008 (with no power supply)

FCC ID: 2AOTF-0000009 (24 V DC)

FCC ID: 2AOTF-0000010 (100 – 240 V AC)

Contains FCC ID: 2AKGW-1TD3016A1

## INSTALLATION

Use the Installation Base Model R3-BS, or Model R3-BSW for free I/O address capability.

Before mounting the Network Interface Module onto the Base, please do the following.

### ■ DATA ALLOCATION

Set the DIP switches (SW1, SW2) so as to assign the data area size to each I/O module mounted on the base.

The data sent/received via Modbus is mapped according to the setting.

See "COMPONENT IDENTIFICATION" and "MODBUS I/O ASSIGNMENTS."

### ■ MOUNTING TO THE BASE

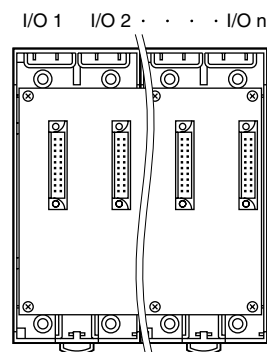

With Model R3-BS base, mount the I/O Modules from the left end (I/O 1) to the right in order that the Network Module assigns data areas from I/O 1.

Network Module(s) and Power Module are mounted basically at the right end though technically they could be mounted in any position.

With Model R3-BSW base, there is no limitation in mounting positions as I/O address can be assigned freely to each module using rotary switches equipped on the base.

## COMPONENT IDENTIFICATION

### FRONT VIEW

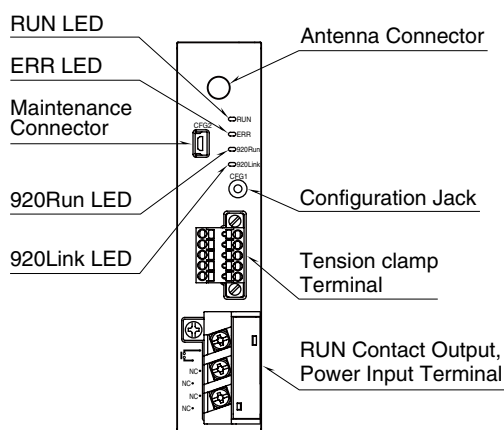

### SIDE VIEW

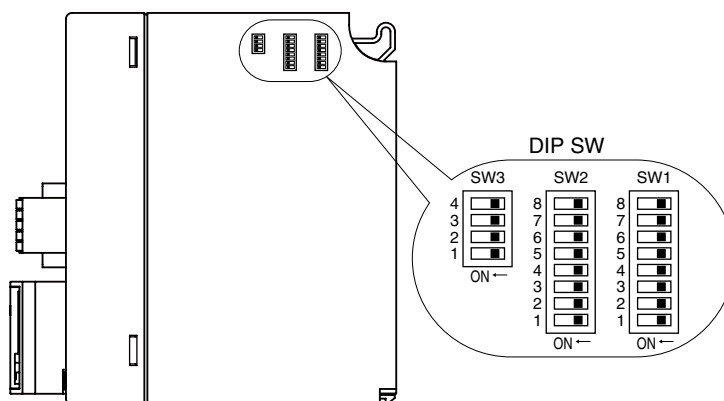

### STATUS INDICATOR LED

ID	STATUS	COLOR	FUNCTION
RUN*1	ON	Green	Output writable port: normal communication
	ON	Red	Wired: receiving data
ERR*1	ON	Green	Output writable port: communication error
	ON	Red	Wired: transmitting data
920Run	ON	Green	Wireless: normal communication
920Link	ON	Green	Wireless: coordinator is connected
	0.5 Hz blinking	Green	Wireless: coordinator connection in process
	Blinking	Red	Network authentication failure
	ON	Red	NO detour

\*1. Refer to "LED Function: SW3-4" below.

### SIDE DIP SW

(\*) Factory setting

#### Data Allocation: SW1, SW2

Data Allocation Type\*2 must be assigned to each I/O module slot position to specify how many data areas (four types) are to be occupied by each module.

Two bits from SW1 and SW2 are assigned to each position, so as to specify data areas for each of the slots No. 1 to 8. Setting for No. 9 and later slots is identical to No. 8.

SW ASSIGNMENT		SLOT
SW1-1	SW1-2	1
SW1-3	SW1-4	2
SW1-5	SW1-6	3
SW1-7	SW1-8	4
SW2-1	SW2-2	5
SW2-3	SW2-4	6
SW2-5	SW2-6	7
SW2-7	SW2-8	8

SW SETTING		DATA ALLOCATION
OFF	OFF	1
ON	OFF	4
OFF	ON	8
ON	ON	16

\*2. Refer to the specifications of the related series for the Data Allocation Type of I/O modules.

#### Dual Communication: SW3-1

When two network modules are mounted, one must be 'Main' (OFF) network and the other must be 'Sub' (ON) network. For single communication, the network module must always be set to 'Main' (OFF).

SW	DUAL COMMUNICATION	
	MAIN (*)	SUB
SW3-1	OFF	ON

#### Input Error Data: SW3-2

**Hold:** When the communication from an input module is lost due to the input module error, the network module holds the signal and stands by until the communication recovers.

**Set to '0':** When the communication from an input module is lost due to the input module error, the network module outputs '0.'

SW	INPUT ERROR DATA	
	HOLD (*)	SET '0'
SW3-2	OFF	ON

#### Main/Sub Switching Control: SW3-3

The host PC or PLC can choose whether 'Main' or 'Sub' bus is used when the switching control is set to 'Host.'

In 'Normal' mode, 'Main' bus is normally used, while 'Sub' bus is when the main communication has failed.

SW	MAIN/SUB SWITCHING CONTROL	
	NORMAL (*)	HOST
SW3-3	OFF	ON

Note 1: Be sure to match this control mode for both network modules in dual communication mode.

Note 2: Must be "OFF" in single communication mode.

#### LED Function: SW3-4

Functions assigned to the front RUN and ERR LEDs can be selected.

SW3-4	LED FUNCTION	
	RUN	ERR
OFF (*)	Green when normal OFF when Timeout	Green ON/blinking when abnormal OFF when normal
ON	Red when receiving	Red when transmitting

## CONFIGURATOR SOFTWARE SETTING

With configurator software, settings shown below are available.  
Refer to the software manual of R3CON for detailed operation.

### ■ WIRED SETTING

ITEM	SETTING RANGE	DEFAULT
Communication timeout	2 – 32000 (100 msec.)	30 (100 msec.)

### ■ MODBUS SETTING

ITEM	SETTING RANGE	DEFAULT
Address	1 – 247	1
Data Mode	RTU / ASCII	RTU
Baud rate	38.4 kbps / 19.2 kbps / 9600 bps / 4800 bps	38.4 kbps
Parity	Odd / Even / None	None
Write enable port	RS-485 / wireless	RS-485
Slave or Relay	Slave / Relay	Slave

### ■ WIRELESS SETTING

ITEM	SETTING RANGE	DEFAULT
PAN-ID	0000 to FFFE (hexadecimal, 4 digits)	0000
Radio channel number	0 (invalid), 1 to 43 (selectable up to 10 channels)	0
Short address	0000 (invalid), 0001 to FFFD (hexadecimal, 4 digits)	0000
Network name	English one-byte characters within 16 characters (one-byte space, “-”, “_”, “.”, “@” are usable.)	Blank
Encryption key	0000...0 to FFFF...F (hexadecimal, 32 digits)	0000...0
Transmitter power output	0.16 mW / 1 mW / 20 mW	20 mW
Communication timeout	0 to 32767 (100 msec.)	30
Number of devices in a network	1 – 30 (devices) / 31 – 60 (devices) / 61 – 100 (devices) / Fixed + Low speed movement	1 – 30
Packet filtering	Disable / Enable	Enable
Filter timeout on polling (100msec)	10 to 600 (100 msec.)	10
Fixed route	Disable / Enable	Disable
Destination short address	0000 to FFFD (hexadecimal, 4 digits)	0000
Temporary detour	Disable / Enable	Enable
Low speed moving mode	Disable / Enable	Disable
Set network quality	Standard / Changing frequency • delaytime middle / Changing frequency • delaytime large	Standard
Network join mode	V3-compatible mode / Fast join mode	V3-compatible mode
Retry times before route switching	1 to 3 (times)	3

## TERMINAL CONNECTIONS

Connect the unit as in the diagram below.

### EXTERNAL DIMENSIONS unit: mm (inch)

#### • WITH SLEEVE ANTENNA

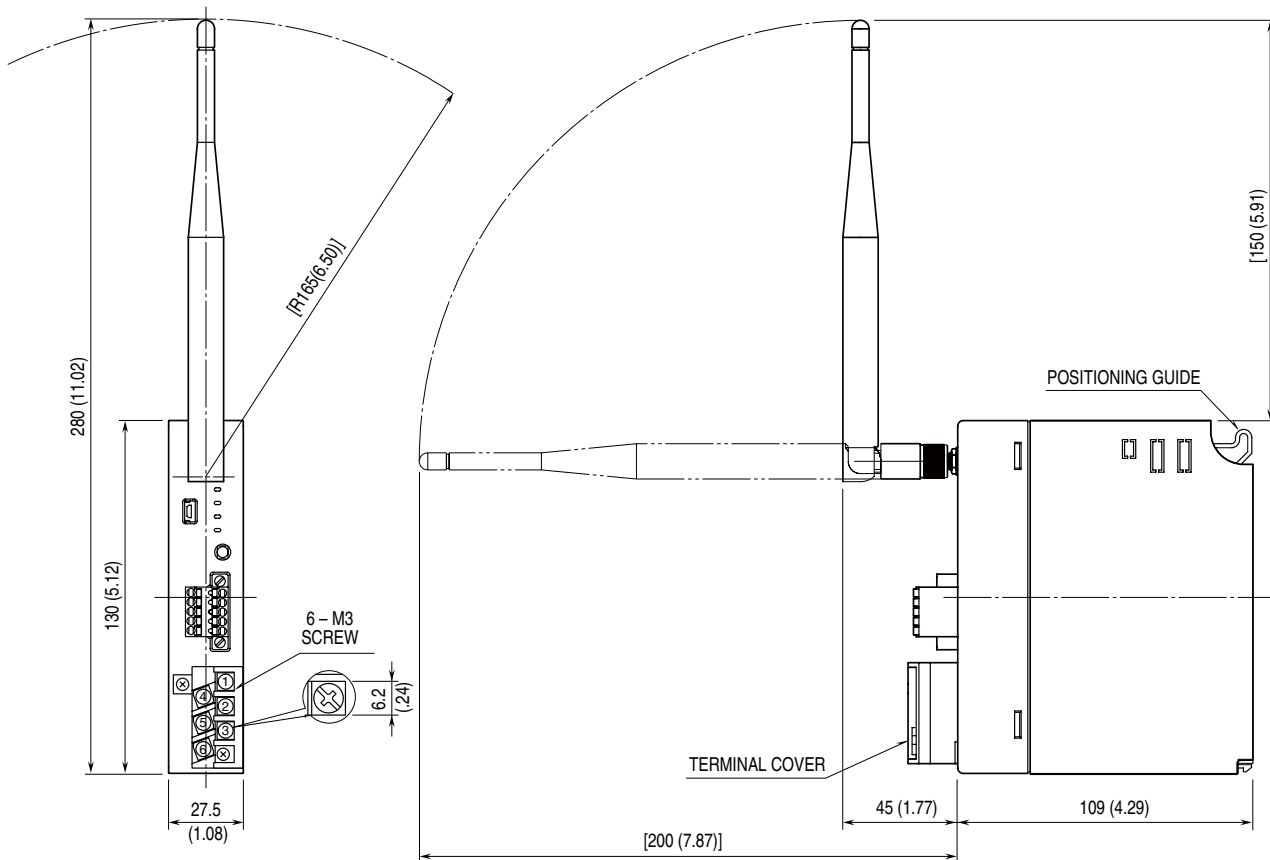

#### • WITH ROOFTOP ANTENNA

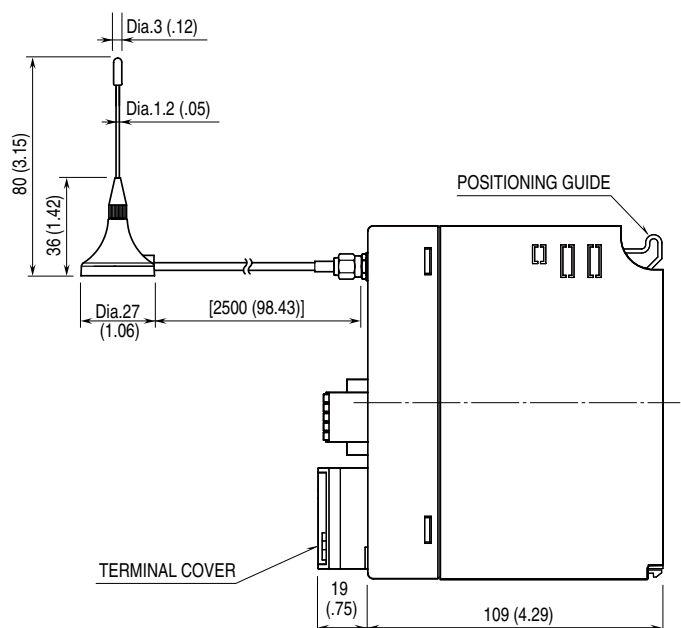

**CONNECTION DIAGRAM**

Caution: FE1 terminal is NOT a protective conductor terminal.

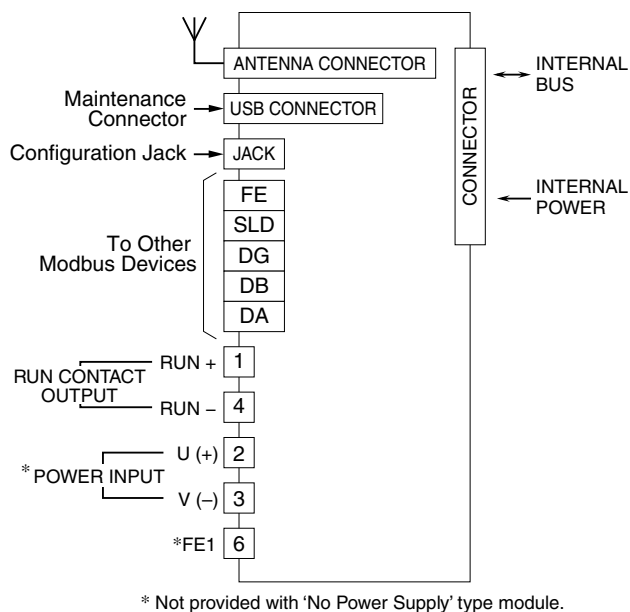

**WIRING INSTRUCTIONS**

**TORQUE**

Terminal wiring screw: 0.5 N·m

**SOLDERLESS TERMINAL**

Refer to the drawing below for recommended ring tongue terminal size. Spade tongue type is also applicable. Solderless terminals with insulation sleeve do not fit.

**Recommended manufacturer:** Japan Solderless Terminal MFG.Co.Ltd, Nichifu Co.,ltd

**Applicable wire size:** 0.75 to 1.25 mm<sup>2</sup>

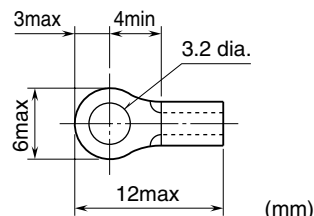

**TENSION CLAMP TERMINAL (Modbus)**

**Applicable Wire size:** 0.2 to 1.5 mm<sup>2</sup>

**Stripped length:** 10 mm

The following Phoenix Contact terminals are recommended:

- AI 0.25-10YE 0.25 mm<sup>2</sup>
- AI 0.34-10TQ 0.34 mm<sup>2</sup>
- AI 0.5-10WH 0.5 mm<sup>2</sup>
- AI 0.75-10GY 0.75 mm<sup>2</sup>

**COMMUNICATION CABLE CONNECTIONS**

**SLAVE MODE**

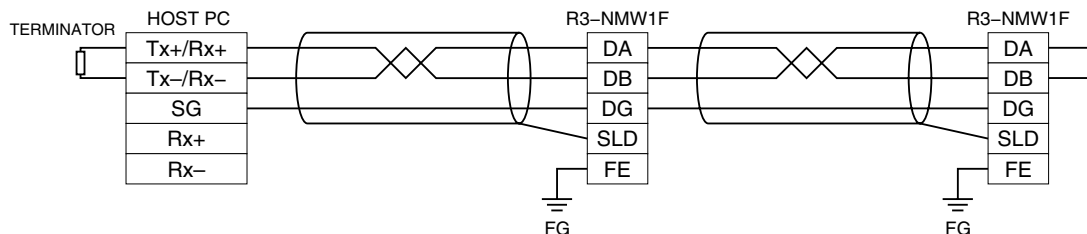

**GATEWAY MODE**

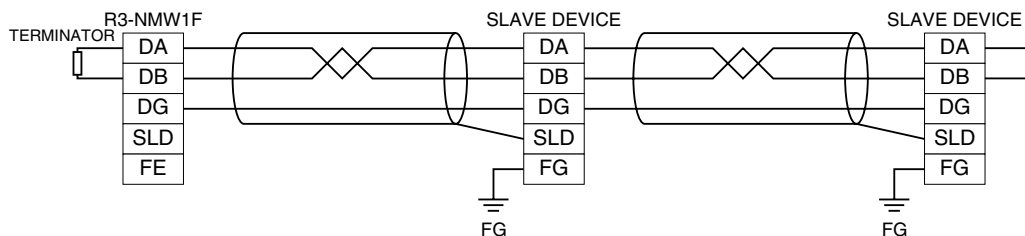

## MODBUS FUNCTION CODES & SUPPORTED CODES

### ■ Data and Control Functions

CODE	NAME		
01	Read Coil Status	X	Digital output from the slave (read/write)
02	Read Input Status	X	Status of digital inputs to the slave (read only)
03	Read Holding Registers	X	General purpose register within the slave (read/write)
04	Read Input Registers	X	Collected data from the field by the slave (read only)
05	Force Single Coil	X	Digital output from the slave (read/write)
06	Preset Single Register	X	General purpose register within the slave (read/write)
07	Read Exception Status		
08	Diagnostics		
09	Program 484		
10	Poll 484		
11	Fetch Comm. Event Counter		
12	Fetch Comm. Event Log		
13	Program Controller		
14	Poll Controller		
15	Force Multiple Coils	X	Digital output from the slave (read/write)
16	Preset Multiple Registers	X	General purpose register within the slave (read/write)
17	Report Slave ID	X	Slave type / 'RUN' status
18	Program 884/M84		
19	Reset Comm. Link		
20	Read General Reference		
21	Write General Reference		
22	Mask Write 4X Register		
23	Read/Write 4X Register		
24	Read FIFO Queue		

### ■ Exception Codes

CODE	NAME		
01	Illegal Function	X	Function code is not allowable for the slave
02	Illegal Data Address	X	Address is not available within the slave
03	Illegal Data Value	X	Data is not valid for the function
04	Slave Device Failure		
05	Acknowledge		
06	Slave Device Busy		
07	Negative Acknowledge		
08	Memory Parity Error		

## MODBUS I/O ASSIGNMENTS

	ADDRESS	DATA FORMAT	NAME
Coil (0X)	1 – 1024		Digital Output (discrete output)
	1025		Main / Sub Switching Command (valid only with SW3-3 set to ON)
Inputs (1X)	1 – 1024		Digital Input (discrete input)
	1025 – 1040		Module Status
	1041 – 1056		Error Status
	1057 – 1072		Data Error Status
Input Registers (3X)	1 – 256	I	Analog Input
	257 – 768	F	Analog Input
Holding Registers (4X)	1 – 256	I	Analog Output
	257 – 768	F	Analog Output

I: Integer, 0 – 10000 (0 – 100%)

F: Floating (32-bit data cannot be accessed using floating addresses.)

Note: DO NOT access addresses other than mentioned above. Such access may cause problems such as inadequate operation.

- Module Status indicates whether individual I/O modules are mounted or not. The bit corresponding to the mounted slot turns to “1,” and the unmounted slot to “0.”
- Error Status indicates error status for each module as described below. The bit corresponding to such module turns to “1.”  
R3-TSx, R3-RSx, R3-US4: Input burnout  
R3-DA16A: Power input in error or disconnected  
R3-YSx: Output current error (e.g. load unconnected)
- Data Error Status indicates overrange (R3-US4: out of -10% to +110%; the other types: out of -15% to +115%) status for each module. The bit corresponding to such module turns to “1.”
- Main / Sub Switching Commands given to the network modules result as follows:

'MAIN' MODULE	'SUB' MODULE	OUTPUT MODE
1	0	Main bus is used; Red LED turns on at RUN LED of the I/O modules.
0	1	Sub bus is used; Green LED turns on at RUN LED of the I/O modules.
1	1	Main bus is used; Amber LED turns on at RUN LED of the I/O modules.
0	0	Output is invalid; RUN LED of the I/O modules turns off.

- Writing to Coil (0X) and Holding Registers (4X) is only available with either Wireless or Modbus communication. It is available to change the configuration with Configurator Software (model: R3CON). Factory default setting is Modbus communication.

## TRANSMISSION DATA ASSIGNMENTS

DIP SW located at the side of the module specifies each I/O module's data allocation (occupied data area).

For example, when the data areas are assigned as shown below:

Module 1	4
Module 2	4
Module 3	4
Module 4	1
Module 5	1
Module 6	1
Module 7	1

Then the I/O data are assigned as in the table below:

	ADDRESS	POSITION
Input Registers (3X)	1 – 4, 257 – 264	Slot 1
Holding Registers (4X)	5 – 8, 265 – 272	Slot 2
	9 – 12, 273 – 280	Slot 3
	13, 281 – 282	Slot 4
	14, 283 – 284	Slot 5
	15, 285 – 286	Slot 6
	16, 287 – 288	Slot 7

	ADDRESS	POSITION
Coil (0X)	1 – 64	Slot 1
Inputs (1X)	65 – 128	Slot 2
	129 – 192	Slot 3
	193 – 208	Slot 4
	209 – 224	Slot 5
	225 – 240	Slot 6
	241 – 256	Slot 7

For Coil (0X) and Inputs (1X), addresses 16 times assigned data areas (Data Allocation Type) are allotted with the Data Allocation Type '1' and '4.' With '8' and '16,' 64 (4 × 16) are automatically allotted.



## MODULE STATUS, ERROR STATUS, DATA ERROR STATUS

Shows each module's availability and error status.

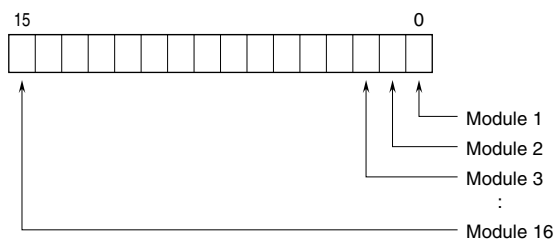

## I/O DATA DESCRIPTIONS

The data allocations for typical I/O modules are shown below.  
Refer to the manual for each module for detailed data allocations.

### ■ ANALOG DATA (16-bit data, models: R3-SV4, YV4, DS4, YS4 and US4, etc.)

16-bit binary data.

Basically, 0 to 100% of the selected I/O range is converted into 0 to 10000 (binary).

-15 to 0 % is a negative range represented in 2's complement.

In case of R3-US4, -10 to 0% is a negative range represented in 2's complement.

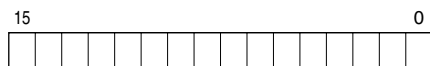

### ■ TEMPERATURE DATA (16-bit data, models: R3-RS4, TS4 and US4, etc.)

16-bit binary data.

With °C temperature unit, raw data is multiplied by 10. For example, 25.5°C is converted into 255.

With °F temperature unit, the integer section of raw data is directly converted into the data. For example, 135.4°F is converted into 135.

Minus temperature is converted into negative values, represented in 2's complements.



### ■ ANALOG DATA (16-bit data, models: R3-CT4A, CT4B, etc.)

16-bit binary data.

Integer obtained by multiplying unit value (A) by 100.

In case of CLSE-R5, integer obtained by multiplying unit value (A) by 1000.

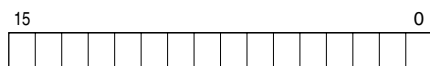

### ■ ACCUMULATED COUNT DATA (32-bit data, models: R3-PA2, PA4A, WT1, WT4, etc.)

32-bit binary data is used for accumulated counts and encoder positions.

Lower 16 bits are allocated from the lowest address to higher ones, higher 16 bits in turn.

32-bit data cannot be accessed using floating addresses.



### ■ BCD DATA (32-bit data, models: R3-BA32A, BC32A, etc.)

32-bit binary data is used for BCD.

Lower 16 bits are allocated from the lowest address to higher ones, higher 16 bits in turn.

32-bit data cannot be accessed using floating addresses.



### ■ 16-POINT, DISCRETE DATA (models: R3-DA16 and DC16, etc.)

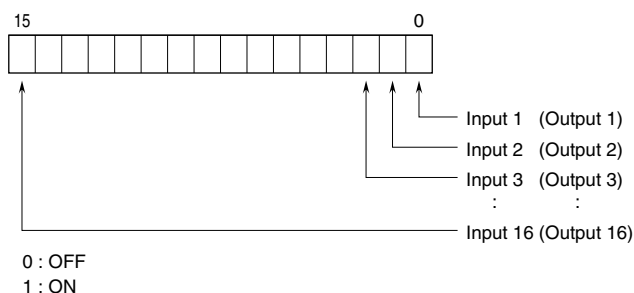

### ■ DUAL COMMUNICATION MODE

RS485 or wireless port set for Write enable port can be dual-redundant.

### ■ MAIN / SUB SWITCHING CONTROL

R3 main network

(main/sub switching control)

Address : 01025 = 1

Address : 01025 = 0

Communication Status

Start

Main Lost

Main Restored

Switching by Host

R3 sub network

(main/sub switching control)

Address : 01025 = 1

Address : 01025 = 0

(1)

(2)

(3)

(4)

(5)

- 1) When the main/sub switching control for both main and sub network is set to '0', all contact outputs are off, and analog output modules output -15%.
- 2) When the main's setting is switched to '1', the output modules are in control of the main host device.
- 3) When a loss of communication is detected in the main network, the output signal is held for the preset time period. (Timer is programmable with the PC Configurator Software, R3CON.) After the time has elapsed, the output control is switched from the main to the sub network. Be sure to set an appropriate output signal to the sub network and switch the sub's setting to '1' before such switching occurs.
- 4) The output modules' control is not automatically switched back to the main's when the main network is restored if the main's setting is '0'. Thus, if the main's setting is '1', the control is back to the main's.
- 5) When both the main and the sub network modules are in communication, the output can be switched without delay.