

FCC SAR EVALUATION REPORT

In accordance with the requirements of
FCC 47 CFR Part 2(2.1093), ANSI/IEEE C95.1-1992 and
IEEE Std 1528-2013

Product Name : Smart Phone

Trademark : OUKITEL

Model Name : C21

Family Model : N/A

Report No. : S20090103501001

FCC ID : 2ANMU-C21

Prepared for

SHENZHEN YUNJI INTELLIGENT TECHNOLOGY CO.,LTD
A2 2F BUILDING ENET NEW INDUSTRIAL PARK, DAFU INDUSTRIAL ZONE,
GUANLAN, LONGHUA SHENZHEN, 518XXX China

Prepared by

Shenzhen NTEK Testing Technology Co., Ltd.
1/F, Building E, Fenda Science Park, Sanwei Community, Xixiang Street,
Bao'an District, Shenzhen 518126 P.R.China.
Tel.: 400-800-6106, 0755-3699 5508
Website: <http://www.ntek.org.cn>

TEST RESULT CERTIFICATION

Applicant's name.....: SHENZHEN YUNJI INTELLIGENT TECHNOLOGY CO.,LTD
 A2 2F BUILDING ENET NEW INDUSTRIAL PARK, DAFU
Address.....: INDUSTRIAL ZONE, GUANLAN, LONGHUA SHENZHEN, 518XXX
 China

Manufacturer's Name.....: SHENZHEN YUNJI INTELLIGENT TECHNOLOGY CO.,LTD
 A2 2F BUILDING ENET NEW INDUSTRIAL PARK, DAFU
Address.....: INDUSTRIAL ZONE, GUANLAN, LONGHUA SHENZHEN, 518XXX
 China

Product description

Product name.....: Smart Phone
Trademark: OUKITEL
Model Name: C21
Family Model.....: N/A
 FCC 47 CFR Part 2(2.1093)

Standards.....: ANSI/IEEE C95.1-1992
 IEEE Std 1528-2013
 Published RF exposure KDB procedures

This device described above has been tested by Shenzhen NTEK. In accordance with the measurement methods and procedures specified in IEEE Std 1528-2013 and KDB 865664 D01. Testing has shown that this device is capable of compliance with localized specific absorption rate (SAR) specified in FCC 47 CFR Part 2(2.1093) and ANSI/IEEE C95.1-1992. The test results in this report apply only to the tested sample of the stated device/equipment. Other similar device/equipment will not necessarily produce the same results due to production tolerance and measurement uncertainties.

This report shall not be reproduced except in full, without the written approval of Shenzhen NTEK, this document may be altered or revised by Shenzhen NTEK, personal only, and shall be noted in the revision of the document.

Date of Test

Date (s) of performance of tests..... : Sep. 02, 2020 ~ Sep. 10, 2020

Date of Issue : Sep. 19, 2020

Test Result : **Pass**

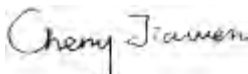
Prepared By : 
 (Test Engineer) : _____
 (Cheng Jiawen)

Approved By : 
 (Lab Manager) : _____
 (Alex Li)

※ ※ Revision History ※ ※

REV.	DESCRIPTION	ISSUED DATE	REMARK
Rev.1.0	Initial Test Report Release	Sep. 19, 2020	Cheng Jiawen

TABLE OF CONTENTS

1.	General Information	6
1.1.	RF exposure limits.....	6
1.2.	Statement of Compliance	7
1.3.	EUT Description	7
1.4.	Test specification(s)	9
1.5.	Ambient Condition.....	9
2.	SAR Measurement System	10
2.1.	SATIMO SAR Measurement Set-up Diagram	10
2.2.	Robot	11
2.3.	E-Field Probe.....	12
2.3.1.	E-Field Probe Calibration	12
2.4.	SAM phantoms	13
2.4.1.	Technical Data	14
2.5.	Device Holder	15
2.6.	Test Equipment List	16
3.	SAR Measurement Procedures	18
3.1.	Power Reference	18
3.2.	Area scan & Zoom scan.....	18
3.3.	Description of interpolation/extrapolation scheme	20
3.4.	Volumetric Scan	20
3.5.	Power Drift	20
4.	System Verification Procedure	21
4.1.	Tissue Verification	21
4.1.1.	Tissue Dielectric Parameter Check Results	22
4.2.	System Verification Procedure	23
4.2.1.	System Verification Results	24
5.	SAR Measurement variability and uncertainty	25
5.1.	SAR measurement variability	25
5.2.	SAR measurement uncertainty	25
6.	RF Exposure Positions.....	26
6.1.	Ear and handset reference point	26
6.2.	Definition of the cheek position	26
6.3.	Definition of the tilt position	28
6.4.	Body Worn Accessory	28
6.5.	Wireless Router Devices	29
7.	RF Output Power	30
7.1.	GSM Conducted Power	30
7.2.	WCDMA Conducted Power	31
7.3.	LTE Conducted Power	32

7.4. WLAN & Bluetooth Output Power	44
7.4.1. Output Power Results Of WLAN	44
7.4.2. Output Power Results Of Bluetooth.....	44
8. Antenna Location.....	45
9. Stand-alone SAR test exclusion.....	46
10. SAR Results	47
10.1. SAR measurement results	47
10.1.1. SAR measurement Result of GSM850.....	47
10.1.2. SAR measurement Result of GSM1900.....	48
10.1.3. SAR measurement Result of WCDMA Band 2.....	49
10.1.4. SAR measurement Result of WCDMA Band 4.....	49
10.1.5. SAR measurement Result of WCDMA Band 5.....	50
10.1.6. SAR measurement Result of LTE Band 2	51
10.1.7. SAR measurement Result of LTE Band 4	52
10.1.8. SAR measurement Result of LTE Band 5	54
10.1.9. SAR measurement Result of LTE Band 7	56
10.1.10. SAR measurement Result of LTE Band 12	58
10.1.11. SAR measurement Result of LTE Band 17	60
10.1.12. SAR measurement Result of WLAN 2.4G	62
10.2. SAR Summation Scenario.....	62
11. Appendix A. Photo documentation	72
12. Appendix B. System Check Plots.....	73
13. Appendix C. Plots of High SAR Measurement.....	98
14. Appendix D. Calibration Certificate	147

1. General Information

1.1. RF exposure limits

(A).Limits for Occupational/Controlled Exposure (W/kg)

Whole-Body	Partial-Body	Hands, Wrists, Feet and Ankles
0.4	8.0	20.0

(B).Limits for General Population/Uncontrolled Exposure (W/kg)

Whole-Body	Partial-Body	Hands, Wrists, Feet and Ankles
0.08	1.6	4.0

NOTE: **Whole-Body SAR** is averaged over the entire body, **partial-body SAR** is averaged over any 1 gram of tissue defined as a tissue volume in the shape of a cube. **SAR for hands, wrists, feet and ankles** is averaged over any 10 grams of tissue defined as a tissue volume in the shape of a cube.

Occupational/Controlled Environments:

Are defined as locations where there is exposure that may be incurred by people who are aware of the potential for exposure, (i.e. as a result of employment or occupation).

General Population/Uncontrolled Environments:

Are defined as locations where there is the exposure of individuals who have no knowledge or control of their exposure.

NOTE
 HEAD AND TRUNK LIMIT
 1.6 W/kg
 APPLIED TO THIS EUT

1.2. Statement of Compliance

The maximum results of Specific Absorption Rate (SAR) found during testing for C21 are as follows.

RF Exposure Conditions		Equipment Class -Highest Reported SAR (W/kg)			
		PCE	DTS	NII	DSS
1-g Head		0.444	0.034	N/A	N/A
1-g Body-Worn (Separation distance of 10mm)		1.046	0.394	N/A	N/A
1-g Hotspot (Separation distance of 10mm)		1.046	0.394	N/A	N/A
Max Simultaneous Tx	Head	0.611	0.478	N/A	0.611
	Body-Worn	1.440	1.440	N/A	1.130
	Hotspot	1.440	1.440	N/A	1.130

Note: The Max Simultaneous Tx is calculated based on the same configuration and test position. This device is in compliance with Specific Absorption Rate (SAR) for general population/uncontrolled exposure limits (1.6 W/kg) specified in FCC 47 CFR Part 2(2.1093) and ANSI/IEEE C95.1-1992, and had been tested in accordance with the measurement methods and procedures specified in IEEE Std 1528-2013 & KDB 865664 D01.

1.3. EUT Description

Device Information			
Product Name	Smart Phone		
Trade Name	OUKITEL		
Model Name	C21		
Family Model	N/A		
FCC ID	2ANMU-C21		
Device Phase	Identical Prototype		
Exposure Category	General population / Uncontrolled environment		
Antenna	PIFA Antenna		
Battery Information	DC 3.85V, 4000mAh		
Device Operating Configurations			
Supporting Mode(s)	GSM 850/1900, WCDMA Band 2/4/5, LTE Band 2/4/5/7/12/17, WLAN 2.4G, Bluetooth		
Test Modulation	GSM(GMSK/8PSK), WCDMA(QPSK), LTE(QPSK/16QAM), WLAN(DSSS/OFDM), Bluetooth(GFSK, $\pi/4$ -DQPSK, 8DPSK)		
Device Class	B		
Operating Frequency Range(s)	Band	Tx (MHz)	Rx (MHz)
	GSM 850	824-849	869-894
	GSM 1900	1850-1910	1930-1990

	WCDMA Band 2	1850-1910	1930-1990
	WCDMA Band 4	1710-1755	2110-2155
	WCDMA Band 5	824-849	869-894
	LTE Band 2	1850-1910	1930-1990
	LTE Band 4	1710-1755	2110-2155
	LTE Band 5	824-849	869-894
	LTE Band 7	2500-2570	2620-2690
	LTE Band 12	699-716	729-746
	LTE Band 17	704-716	734-746
	WLAN 2.4G	2412-2462	
	Bluetooth	2402-2480	
GPRS Multislot Class(12)	Max Number of Timeslots in Uplink		4
	Max Number of Timeslots in Downlink		4
	Max Total Timeslot		5
EDGE Multislot Class(12)	Max Number of Timeslots in Uplink		4
	Max Number of Timeslots in Downlink		4
	Max Total Timeslot		5
Power Class	4, tested with power level 5(GSM 850)		
	1, tested with power level 0(GSM 1900)		
	3, tested with power control "all 1"(WCDMA Band 2)		
	3, tested with power control "all 1"(WCDMA Band 4)		
	3, tested with power control "all 1"(WCDMA Band 5)		
	3, tested with power control all Max.(LTE Band 2)		
	3, tested with power control all Max.(LTE Band 4)		
	3, tested with power control all Max.(LTE Band 5)		
	3, tested with power control all Max.(LTE Band 7)		
	3, tested with power control all Max.(LTE Band 12)		
	3, tested with power control all Max.(LTE Band 17)		
Test Channels (low-mid-high)	128-189-251(GSM 850)		
	512-661-810(GSM 1900)		
	9262-9400-9538(WCDMA Band 2)		
	1312-1413-1513(WCDMA Band 4)		
	4132-4182-4233(WCDMA Band 5)		
	18607-18900-19193(LTE Band 2 BW=1.4MHz)		
	18615-18900-19185(LTE Band 2 BW=3MHz)		
	18625-18900-19175(LTE Band 2 BW=5MHz)		
	18650-18900-19150(LTE Band 2 BW=10MHz)		
	18675-18900-19125(LTE Band 2 BW=15MHz)		
	18700-18900-19100(LTE Band 2 BW=20MHz)		
	19957-20175-20393(LTE Band 4 BW=1.4MHz)		

19965-20175-20385(LTE Band 4 BW=3MHz)
19975-20175-20375(LTE Band 4 BW=5MHz)
20000-20175-20350(LTE Band 4 BW=10MHz)
20025-20175-20325(LTE Band 4 BW=15MHz)
20050-20175-20300(LTE Band 4 BW=20MHz)
20407-20525-20643(LTE Band 5 BW=1.4MHz)
20415-20525-20635(LTE Band 5 BW=3MHz)
20425-20525-20625(LTE Band 5 BW=5MHz)
20450-20525-20600(LTE Band 5 BW=10MHz)
20775-21100-21425(LTE Band 7 BW=5MHz)
20800-21100-21400(LTE Band 7 BW=10MHz)
20825-21100-21375(LTE Band 7 BW=15MHz)
20850-21100-21350(LTE Band 7 BW=20MHz)
23017-23095-23173 (LTE Band 12 BW=1.4MHz)
23025-23095-23165 (LTE Band 12 BW=3MHz)
23035-23095-23155 (LTE Band 12 BW=5MHz)
23060-23095-23130 (LTE Band 12 BW=10MHz)
23755-23790-23825(LTE Band 17 BW=5MHz)
23780-23790-23800(LTE Band 17 BW=10MHz)
1-3-6-9-11(WLAN 2.4G)

1.4. Test specification(s)

FCC 47 CFR Part 2(2.1093)
ANSI/IEEE C95.1-1992
IEEE Std 1528-2013
KDB 865664 D01 SAR measurement 100 MHz to 6 GHz
KDB 865664 D02 RF Exposure Reporting
KDB 447498 D01 General RF Exposure Guidance
KDB 248227 D01 802.11 Wi-Fi SAR
KDB 941225 D01 3G SAR Procedures
KDB 941225 D05 SAR for LTE Devices
KDB 941225 D06 Hotspot SAR
KDB 648474 D04 Handset SAR

1.5. Ambient Condition

Ambient temperature	20°C – 24°C
Relative Humidity	30% – 70%

2. SAR Measurement System

2.1. SATIMO SAR Measurement Set-up Diagram

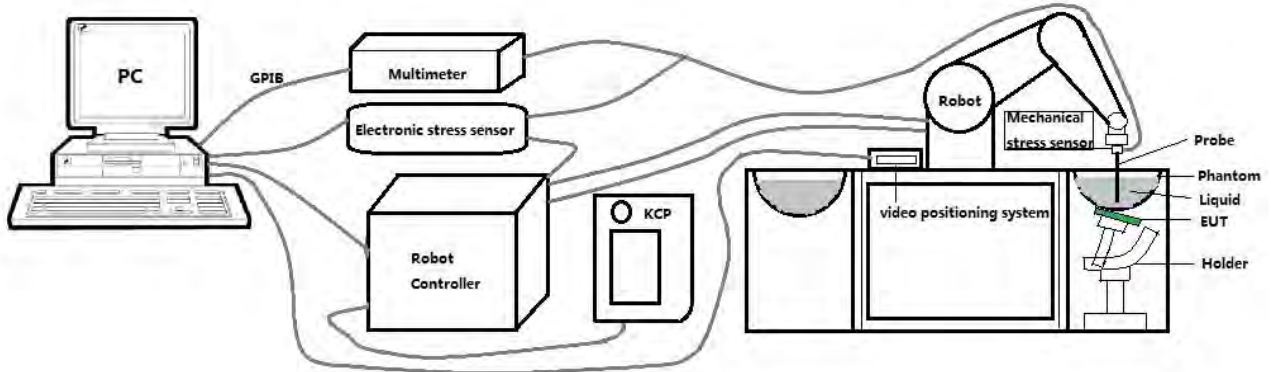

These measurements were performed with the automated near-field scanning system OPENSAR from SATIMO. The system is based on a high precision robot (working range: 901 mm), which positions the probes with a positional repeatability of better than ± 0.03 mm. The SAR measurements were conducted with dosimetric probe (manufactured by SATIMO), designed in the classical triangular configuration and optimized for dosimetric evaluation.

The first step of the field measurement is the evaluation of the voltages induced on the probe by the device under test. Probe diode detectors are nonlinear. Below the diode compression point, the output voltage is proportional to the square of the applied E-field; above the diode compression point, it is linear to the applied E-field. The compression point depends on the diode, and a calibration procedure is necessary for each sensor of the probe.

The Keithley multimeter reads the voltage of each sensor and send these three values to the PC. The corresponding E field value is calculated using the probe calibration factors, which are stored in the working directory. This evaluation includes linearization of the diode characteristics. The field calculation is done separately for each sensor. Each component of the E field is displayed on the "Dipole Area Scan Interface" and the total E field is displayed on the "3D Interface"

2.2. Robot

The SATIMO SAR system uses the high precision robots from KUKA. For the 6-axis controller system, the robot controller version (KUKA) from KUKA is used. The KUKA robot series have many features that are important for our application:



- High precision (repeatability ± 0.03 mm)
- High reliability (industrial design)
- Jerk-free straight movements
- Low ELF interference (the closed metallic construction shields against motor control fields)

2.3. E-Field Probe

This E-field detection probe is composed of three orthogonal dipoles linked to special Schottky diodes with low detection thresholds. The probe allows the measurement of electric fields in liquids such as the one defined in the IEEE and CENELEC standards.

For the measurements the Specific Dosimetric E-Field Probe SN 08/16 EPGO287 with following specifications is used



- Dynamic range: 0.01-100 W/kg
 - Tip Diameter: 2.5 mm
 - Distance between probe tip and sensor center: 1 mm
 - Distance between sensor center and the inner phantom surface: 2 mm (repeatability better than ± 1 mm).
 - Probe linearity: ± 0.08 dB
 - Axial isotropy: 0.06 dB
 - Hemispherical Isotropy: 0.08 dB
 - Calibration range: 650MHz to 5900MHz for head & body simulating liquid.
 - Lower detection limit: 7mW/kg
- Angle between probe axis (evaluation axis) and surface normal line: less than 30° .

2.3.1. E-Field Probe Calibration

Each probe needs to be calibrated according to a dosimetric assessment procedure with accuracy better than $\pm 10\%$. The spherical isotropy shall be evaluated and within ± 0.25 dB. The sensitivity parameters (Norm X, Norm Y, and Norm Z), the diode compression parameter (DCP) and the conversion factor (Conv F) of the probe are tested. The calibration data can be referred to appendix D of this report.

2.4. SAM phantoms

Photo of SAM phantom SN 16/15 SAM119



The SAM phantom is used to measure the SAR relative to people exposed to electro-magnetic field radiated by mobile phones.

2.4.1. Technical Data

Serial Number	Shell thickness	Filling volume	Dimensions	Positionner Material	Permittivity	Loss Tangent
SN 16/15 SAM119	2 mm ±0.2 mm	27 liters	Length:1000 mm Width:500 mm Height:200 mm	Gelcoat with fiberglass	3.4	0.02

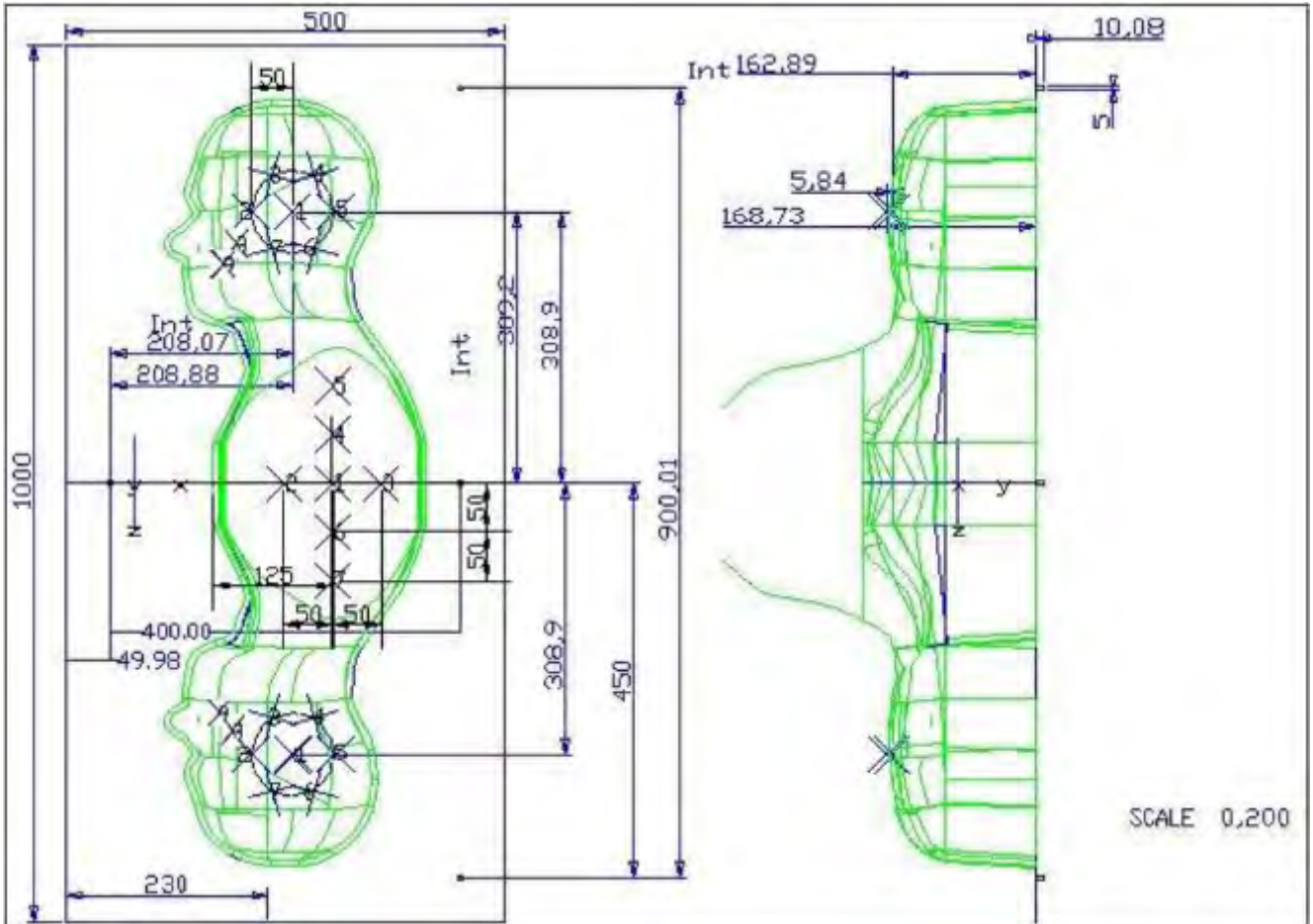

Serial Number	Left Head(mm)		Right Head(mm)		Flat Part(mm)	
	1	2	1	2	1	2
SN 16/15 SAM119	2	2.02	2	2.08	1	2.09
	3	2.05	3	2.06	2	2.06
	4	2.07	4	2.07	3	2.08
	5	2.08	5	2.08	4	2.10
	6	2.05	6	2.07	5	2.10
	7	2.05	7	2.05	6	2.07
	8	2.07	8	2.06	7	2.07
	9	2.08	9	2.06	-	-

The test, based on ultrasonic system, allows measuring the thickness with an accuracy of 10 µm.

2.5. Device Holder

The positioning system allows obtaining cheek and tilting position with a very good accuracy. In compliance with CENELEC, the tilt angle uncertainty is lower than 1 degree.

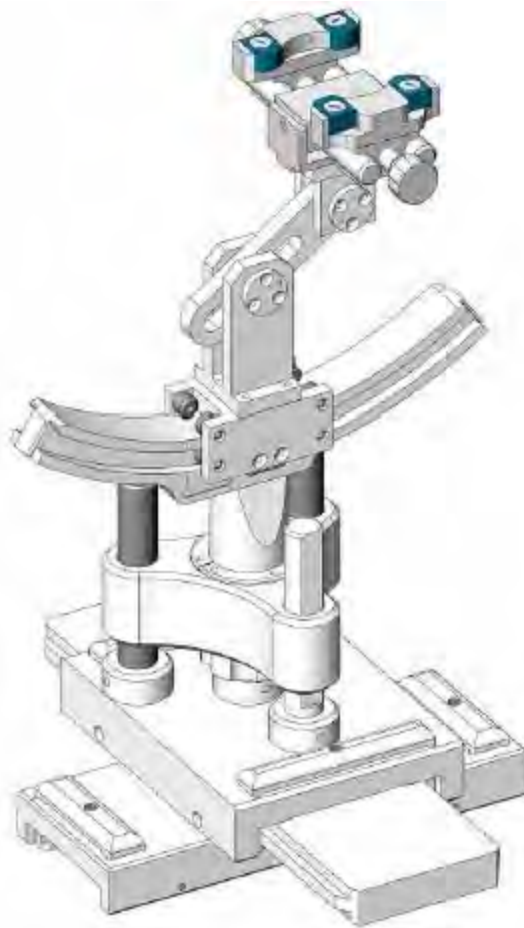

Serial Number	Holder Material	Permittivity	Loss Tangent
SN 16/15 MSH100	Delrin	3.7	0.005

2.6. Test Equipment List

This table gives a complete overview of the SAR measurement equipment.

Devices used during the test described are marked

	Manufacturer	Name of Equipment	Type/Model	Serial Number	Calibration	
					Last Cal.	Due Date
<input checked="" type="checkbox"/>	MVG	E FIELD PROBE	SSE2	SN 08/16 EPGO287	Dec. 27, 2019	Dec. 26, 2020
<input checked="" type="checkbox"/>	MVG	750 MHz Dipole	SID750	SN 03/15 DIP 0G750-355	Apr. 19, 2018	Apr. 18, 2021
<input checked="" type="checkbox"/>	MVG	835 MHz Dipole	SID835	SN 03/15 DIP 0G835-347	Apr. 19, 2018	Apr. 18, 2021
<input type="checkbox"/>	MVG	900 MHz Dipole	SID900	SN 03/15 DIP 0G900-348	Apr. 19, 2018	Apr. 18, 2021
<input checked="" type="checkbox"/>	MVG	1800 MHz Dipole	SID1800	SN 03/15 DIP 1G800-349	Apr. 19, 2018	Apr. 18, 2021
<input checked="" type="checkbox"/>	MVG	1900 MHz Dipole	SID1900	SN 03/15 DIP 1G900-350	Apr. 19, 2018	Apr. 18, 2021
<input type="checkbox"/>	MVG	2000 MHz Dipole	SID2000	SN 03/15 DIP 2G000-351	Apr. 19, 2018	Apr. 18, 2021
<input checked="" type="checkbox"/>	MVG	2450 MHz Dipole	SID2450	SN 03/15 DIP 2G450-352	Apr. 19, 2018	Apr. 18, 2021
<input checked="" type="checkbox"/>	MVG	2600 MHz Dipole	SID2600	SN 03/15 DIP 2G600-356	Apr. 19, 2018	Apr. 18, 2021
<input type="checkbox"/>	MVG	5000 MHz Dipole	SWG5500	SN 13/14 WGA 33	Apr. 19, 2018	Apr. 18, 2021
<input checked="" type="checkbox"/>	MVG	Liquid measurement Kit	SCLMP	SN 21/15 OCPG 72	NCR	NCR
<input checked="" type="checkbox"/>	MVG	Power Amplifier	N.A	AMPLISAR_28/14_003	NCR	NCR
<input checked="" type="checkbox"/>	KEITHLEY	Millivoltmeter	2000	4072790	NCR	NCR
<input checked="" type="checkbox"/>	R&S	Universal radio communication tester	CMU200	117858	Jul. 13, 2020	Jul. 12, 2021
<input checked="" type="checkbox"/>	R&S	Wideband radio communication tester	CMW500	103917	Jul. 13, 2020	Jul. 12, 2021
<input checked="" type="checkbox"/>	HP	Network Analyzer	8753D	3410J01136	Jul. 13, 2020	Jul. 12, 2021
<input checked="" type="checkbox"/>	Agilent	PSG Analog Signal Generator	E8257D	MY51110112	Jul. 13, 2020	Jul. 12, 2021

<input checked="" type="checkbox"/>	Agilent	Power meter	E4419B	MY45102538	Jul. 13, 2020	Jul. 12, 2021
<input checked="" type="checkbox"/>	Agilent	Power sensor	E9301A	MY41495644	Jul. 13, 2020	Jul. 12, 2021
<input checked="" type="checkbox"/>	Agilent	Power sensor	E9301A	US39212148	Jul. 13, 2020	Jul. 12, 2021
<input checked="" type="checkbox"/>	MCLI/USA	Directional Coupler	CB11-20	0D2L51502	Jul. 17, 2020	Jul. 16, 2023

3. SAR Measurement Procedures

The measurement procedures are as follows:

<Conducted power measurement>

- (a) For WWAN power measurement, use base station simulator to configure EUT WWAN transmission in conducted connection with RF cable, at maximum power in each supported wireless interface and frequency band.
- (b) Read the WWAN RF power level from the base station simulator.
- (c) For WLAN/Bluetooth power measurement, use engineering software to configure EUT WLAN/Bluetooth continuously transmission, at maximum RF power in each supported wireless interface and frequency band.
- (d) Connect EUT RF port through RF cable to the power meter, and measure WLAN/Bluetooth output power.

<SAR measurement>

- (a) Use base station simulator to configure EUT WWAN transmission in radiated connection, and engineering software to configure EUT WLAN/Bluetooth continuously transmission, at maximum RF power, in the highest power channel.
- (b) Place the EUT in the positions as Appendix A demonstrates.
- (c) Set scan area, grid size and other setting on the OPENSAR software.
- (d) Measure SAR results for the highest power channel on each testing position.
- (e) Find out the largest SAR result on these testing positions of each band.
- (f) Measure SAR results for other channels in worst SAR testing position if the reported SAR of highest power channel is larger than 0.8 W/kg.

According to the test standard, the recommended procedure for assessing the peak spatial-average SAR value consists of the following steps:

- (a) Power reference measurement
- (b) Area scan
- (c) Zoom scan
- (d) Power drift measurement

3.1. Power Reference

The Power Reference Measurement and Power Drift Measurements are for monitoring the power drift of the device under test in the batch process. The minimum distance of probe sensors to surface determines the closest measurement point to phantom surface. This distance cannot be smaller than the distance of sensor calibration points to probe tip as defined in the probe properties.

3.2. Area scan & Zoom scan

The area scan is a 2D scan to find the hot spot location on the DUT. The zoom scan is a 3D scan above the hot spot to calculate the 1g and 10g SAR value.

Measurement of the SAR distribution with a grid of 8 to 16 mm * 8 to 16 mm and a constant distance to the inner surface of the phantom. Since the sensors cannot directly measure at the inner phantom surface, the values between the sensors and the inner phantom surface are extrapolated. With these values the area of the maximum SAR is calculated by an interpolation scheme. Around this point, a cube of 30 * 30 * 30 mm or 32 * 32 * 32 mm is assessed by measuring 5 or 8 * 5 or 8 * 4 or 5 mm. With these data, the peak spatial-average SAR value can be calculated.

From the scanned SAR distribution, identify the position of the maximum SAR value, in addition identify the positions of any local maxima with SAR values within 2 dB of the maximum value that will not be within the zoom scan of other peaks; additional peaks shall be measured only when the primary peak is within 2 dB of the SAR compliance limit (e.g., 1 W/kg for 1,6 W/kg 1 g limit, or 1,26 W/kg for 2 W/kg, 10 g limit).

Area scan & Zoom scan scan parameters extracted from FCC KDB 865664 D01 SAR measurement 100 MHz to 6 GHz.

		≤ 3 GHz	> 3 GHz	
Maximum distance from closest measurement point (geometric center of probe sensors) to phantom surface		5 ± 1 mm	½·δ·ln(2) ± 0.5 mm	
Maximum probe angle from probe axis to phantom surface normal at the measurement location		30° ± 1°	20° ± 1°	
Maximum area scan spatial resolution: Δx _{Area} , Δy _{Area}		≤ 2 GHz: ≤ 15 mm 2 – 3 GHz: ≤ 12 mm	3 – 4 GHz: ≤ 12 mm 4 – 6 GHz: ≤ 10 mm	
		When the x or y dimension of the test device, in the measurement plane orientation, is smaller than the above, the measurement resolution must be ≤ the corresponding x or y dimension of the test device with at least one measurement point on the test device.		
Maximum zoom scan spatial resolution: Δx _{Zoom} , Δy _{Zoom}		≤ 2 GHz: ≤ 8 mm 2 – 3 GHz: ≤ 5 mm *	3 – 4 GHz: ≤ 5 mm * 4 – 6 GHz: ≤ 4 mm *	
Maximum zoom scan spatial resolution, normal to phantom surface	uniform grid: Δz _{Zoom} (n)	≤ 5 mm	3 – 4 GHz: ≤ 4 mm 4 – 5 GHz: ≤ 3 mm 5 – 6 GHz: ≤ 2 mm	
	graded grid	Δz _{Zoom} (1): between 1 st two points closest to phantom surface	≤ 4 mm	3 – 4 GHz: ≤ 3 mm 4 – 5 GHz: ≤ 2.5 mm 5 – 6 GHz: ≤ 2 mm
		Δz _{Zoom} (n>1): between subsequent points	≤ 1.5·Δz _{Zoom} (n-1)	
Minimum zoom scan volume	x, y, z	≥ 30 mm	3 – 4 GHz: ≥ 28 mm 4 – 5 GHz: ≥ 25 mm 5 – 6 GHz: ≥ 22 mm	

Note: δ is the penetration depth of a plane-wave at normal incidence to the tissue medium; see draft standard IEEE P1528-2011 for details.

* When zoom scan is required and the *reported* SAR from the *area scan based 1-g SAR estimation* procedures of KDB 447498 is ≤ 1.4 W/kg, ≤ 8 mm, ≤ 7 mm and ≤ 5 mm zoom scan resolution may be applied, respectively, for 2 GHz to 3 GHz, 3 GHz to 4 GHz and 4 GHz to 6 GHz.

3.3. Description of interpolation/extrapolation scheme

The local SAR inside the phantom is measured using small dipole sensing elements inside a probe body. The probe tip must not be in contact with the phantom surface in order to minimise measurements errors, but the highest local SAR will occur at the surface of the phantom.

An extrapolation is using to determinate this highest local SAR values. The extrapolation is based on a fourth-order least-square polynomial fit of measured data. The local SAR value is then extrapolated from the liquid surface with a 1 mm step.

The measurements have to be performed over a limited time (due to the duration of the battery) so the step of measurement is high. It could vary between 5 and 8 mm. To obtain an accurate assessment of the maximum SAR averaged over 10 grams and 1 gram requires a very fine resolution in the three dimensional scanned data array.

3.4. Volumetric Scan

The volumetric scan consists to a full 3D scan over a specific area. This 3D scan is useful form multi Tx SAR measurement. Indeed, it is possible with OpenSAR to add, point by point, several volumetric scan to calculate the SAR value of the combined measurement as it is define in the standard IEEE1528 and IEC62209.

3.5. Power Drift

All SAR testing is under the EUT install full charged battery and transmit maximum output power. In OpenSAR measurement software, the power reference measurement and power drift measurement procedures are used for monitoring the power drift of EUT during SAR test. Both these procedures measure the field at a specified reference position before and after the SAR testing. The software will calculate the field difference in V/m. If the power drifts more than $\pm 5\%$, the SAR will be retested.

4. System Verification Procedure

4.1. Tissue Verification

The following tissue formulations are provided for reference only as some of the parameters have not been thoroughly verified. The composition of ingredients may be modified accordingly to achieve the desired target tissue parameters required for routine SAR evaluation.

Ingredients (% of weight)	Head Tissue									
	750	835	900	1800	1900	2000	2450	2600	5200	5800
Frequency Band (MHz)										
Water	34.40	34.40	34.40	55.36	55.36	57.87	57.87	57.87	65.53	65.53
NaCl	0.79	0.79	0.79	0.35	0.35	0.16	0.16	0.16	0.00	0.00
1,2-Propanediol	64.81	64.81	64.81	0.00	0.00	0.00	0.00	0.00	0.00	0.00
Triton X-100	0.00	0.00	0.00	30.45	30.45	19.97	19.97	19.97	24.24	24.24
DGBE	0.00	0.00	0.00	13.84	13.84	22.00	22.00	22.00	10.23	10.23
Ingredients (% of weight)	Body Tissue									
	750	835	900	1800	1900	2000	2450	2600	5200	5800
Frequency Band (MHz)										
Water	50.30	50.30	50.30	69.91	69.91	71.88	71.88	71.88	79.54	79.54
NaCl	0.60	0.60	0.60	0.13	0.13	0.16	0.16	0.16	0.00	0.00
1,2-Propanediol	49.10	49.10	49.10	0.00	0.00	0.00	0.00	0.00	0.00	0.00
Triton X-100	0.00	0.00	0.00	9.99	9.99	19.97	19.97	19.97	11.24	11.24
DGBE	0.00	0.00	0.00	19.97	19.97	7.99	7.99	7.99	9.22	9.22

For SAR measurement of the field distribution inside the phantom, the phantom must be filled with homogeneous tissue simulating liquid to a depth of at least 15 cm. For head SAR testing, the liquid depth from the ear reference point (ERP) of the phantom to the liquid top surface is larger than 15 cm.

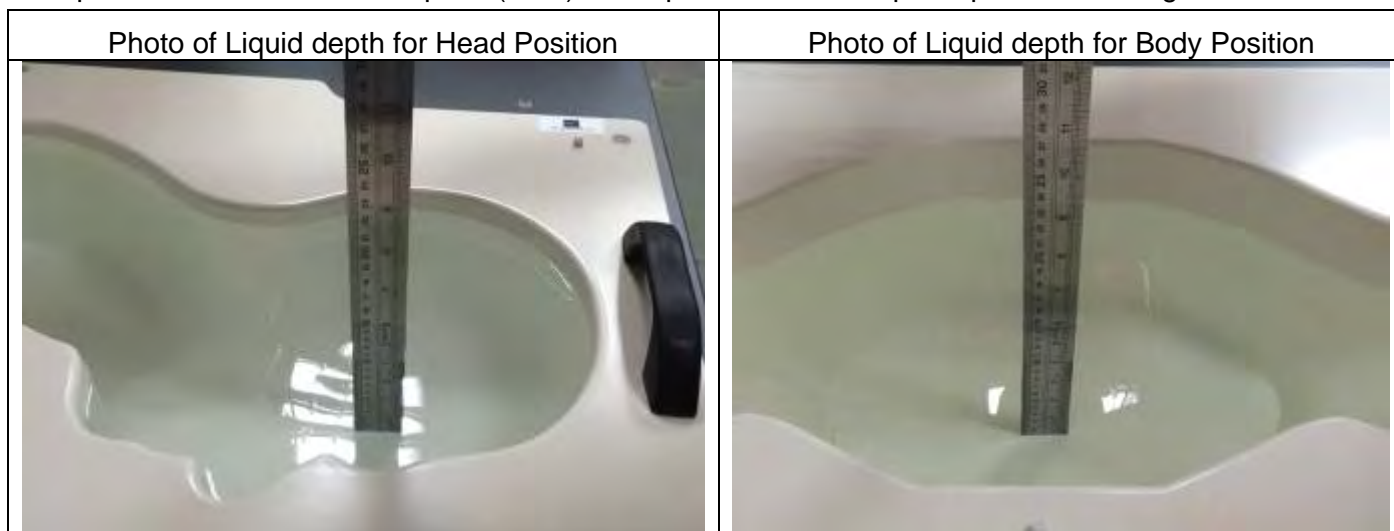

4.1.1. Tissue Dielectric Parameter Check Results

The simulating liquids should be checked at the beginning of a series of SAR measurements to determine if the dielectric parameters are within the tolerances of the specified target values. The measured conductivity and relative permittivity should be within $\pm 5\%$ of the target values.

Tissue Type	Measured Frequency (MHz)	Target Tissue		Measured Tissue		Liquid Temp.	Test Date
		ϵ_r ($\pm 5\%$)	σ (S/m) ($\pm 5\%$)	ϵ_r	σ (S/m)		
Head 750	750	41.96 (39.86~44.06)	0.89 (0.85~0.93)	41.57	0.92	21.5 °C	Sep. 06, 2020
Body 750	750	55.55 (52.77~58.33)	0.96 (0.91~1.01)	55.47	0.97	21.2 °C	Sep. 07, 2020
Head 850	835	41.50 (39.43~43.58)	0.90 (0.86~0.95)	40.78	0.93	21.5 °C	Sep. 06, 2020
Body 850	835	55.20 (52.44~57.96)	0.97 (0.92~1.02)	54.51	0.98	21.3 °C	Sep. 06, 2020
Head 1800	1800	40.00 (38.00~42.00)	1.40 (1.33~1.47)	38.60	1.38	21.7 °C	Sep. 05, 2020
Body 1800	1800	53.30 (50.64~55.97)	1.52 (1.44~1.60)	54.08	1.51	21.2 °C	Sep. 07, 2020
Head 1900	1900	40.00 (38.00~42.00)	1.40 (1.33~1.47)	38.64	1.44	21.4 °C	Sep. 07, 2020
Body 1900	1900	53.30 (50.64~55.97)	1.52 (1.44~1.60)	54.25	1.53	21.4 °C	Sep. 08, 2020
Head 2450	2450	39.20 (37.24~41.16)	1.80 (1.71~1.89)	38.53	1.85	21.5 °C	Sep. 02, 2020
Body 2450	2450	52.70 (50.07~55.34)	1.95 (1.85~2.05)	51.51	1.88	21.2 °C	Sep. 10, 2020
Head 2600	2600	39.01 (37.06~40.96)	1.96 (1.86~2.06)	38.12	2.02	21.4 °C	Sep. 10, 2020
Body 2600	2600	52.51 (49.88~55.14)	2.16 (2.05~2.27)	52.84	2.22	21.6 °C	Sep. 09, 2020

NOTE: The dielectric parameters of the tissue-equivalent liquid should be measured under similar ambient conditions and within 2 °C of the conditions expected during the SAR evaluation to satisfy protocol requirements.

4.2. System Verification Procedure

The system verification is performed for verifying the accuracy of the complete measurement system and performance of the software. The dipole is connected to the signal source consisting of signal generator and amplifier via a directional coupler, N-connector cable and adaption to SMA. It is fed with a power of 100mW (below 5GHz) or 100mW (above 5GHz). To adjust this power a power meter is used. The power sensor is connected to the cable before the system verification to measure the power at this point and do adjustments at the signal generator. At the outputs of the directional coupler both return loss as well as forward power are controlled during the system verification to make sure that emitted power at the dipole is kept constant. This can also be checked by the power drift measurement after the test (result on plot).

The system verification is shown as below picture:

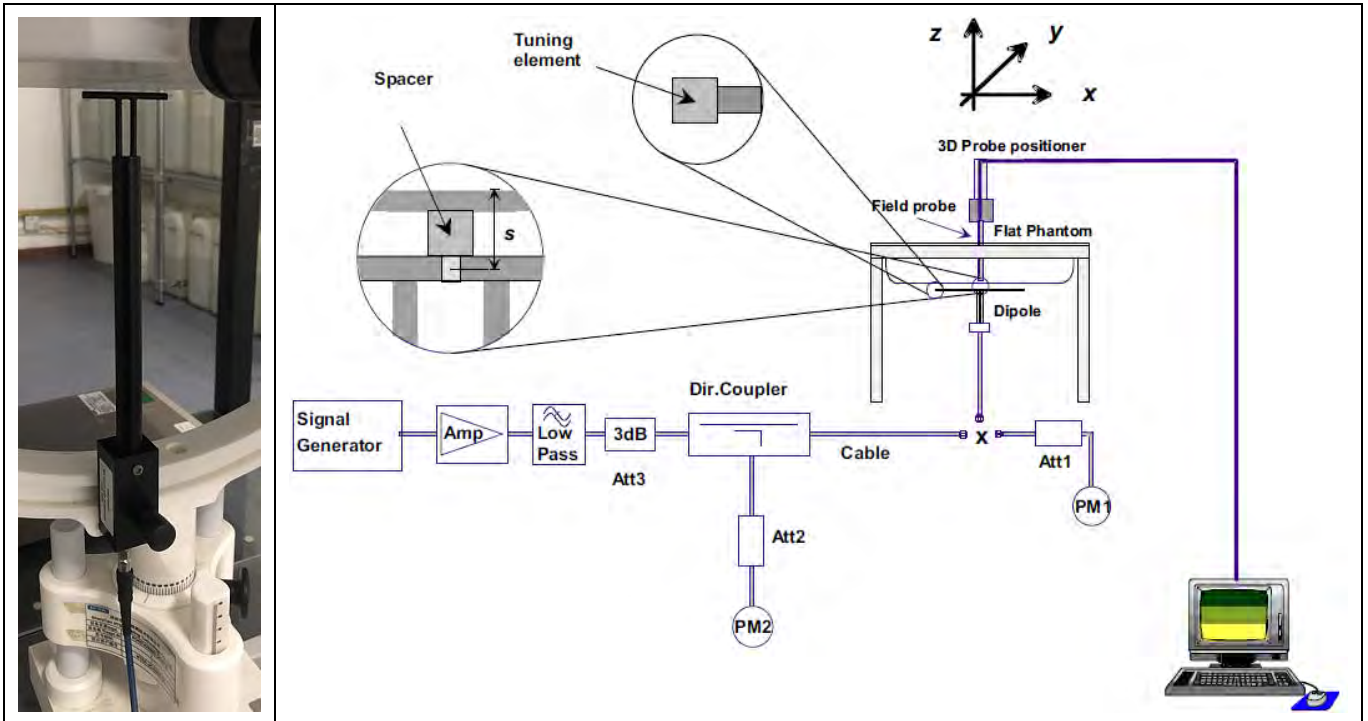

4.2.1. System Verification Results

Comparing to the original SAR value provided by SATIMO, the verification data should be within its specification of $\pm 10\%$. Below table shows the target SAR and measured SAR after normalized to 1W input power. The table below indicates the system performance verification can meet the variation criterion and the plots can be referred to Appendix B of this report.

System Verification	Target SAR (1W) ($\pm 10\%$)		Measured SAR (Normalized to 1W)		Liquid Temp.	Test Date
	1-g (W/Kg)	10-g (W/Kg)	1-g (W/Kg)	10-g (W/Kg)		
750MHz Head	8.56 (7.70~9.42)	5.55 (5.00~6.11)	8.42	5.56	21.5 °C	Sep. 06, 2020
750MHz Body	8.85 (7.97~9.74)	5.91 (5.32~6.50)	8.84	5.90	21.2 °C	Sep. 07, 2020
835MHz Head	9.55 (8.60~10.51)	6.10 (5.49~6.71)	9.86	6.37	21.5 °C	Sep. 06, 2020
835MHz Body	9.83 (8.85~10.81)	6.45 (5.81~7.10)	10.37	6.33	21.3 °C	Sep. 06, 2020
1800MHz Head	38.11 (34.30~41.92)	20.05 (18.05~22.06)	37.31	20.15	21.7 °C	Sep. 05, 2020
1800MHz Body	38.13 (34.32~41.94)	20.65 (18.59~22.72)	40.24	21.15	21.2 °C	Sep. 07, 2020
1900MHz Head	38.92 (35.03~42.81)	20.09 (18.08~22.10)	38.26	19.09	21.4 °C	Sep. 07, 2020
1900MHz Body	39.02 (35.12~42.92)	20.57 (18.51~22.63)	37.20	21.04	21.4 °C	Sep. 08, 2020
2450MHz Head	53.76 (48.38~59.14)	24.12 (21.71~26.53)	56.87	24.71	21.5 °C	Sep. 02, 2020
2450MHz Body	52.90 (47.61~58.19)	24.09 (21.68~26.50)	52.90	24.09	21.2 °C	Sep. 10, 2020
2600MHz Head	55.60 (50.04~61.16)	24.60 (22.14~27.06)	58.90	23.37	21.4 °C	Sep. 10, 2020
2600MHz Body	52.49 (47.24~57.74)	23.74 (21.37~26.11)	50.57	22.80	21.6 °C	Sep. 09, 2020

5. SAR Measurement variability and uncertainty

5.1. SAR measurement variability

Per KDB865664 D01 SAR measurement 100 MHz to 6 GHz, SAR measurement variability must be assessed for each frequency band, which is determined by the SAR probe calibration point and tissue-equivalent medium used for the device measurements. The additional measurements are repeated after the completion of all measurements requiring the same head or body tissue-equivalent medium in a frequency band. The test device should be returned to ambient conditions (normal room temperature) with the battery fully charged before it is re-mounted on the device holder for the repeated measurement(s) to minimize any unexpected variations in the repeated results.

- 1) Repeated measurement is not required when the original highest measured SAR is < 0.80 W/kg; steps 2) through 4) do not apply.
- 2) When the original highest measured SAR is ≥ 0.80 W/kg, repeat that measurement once.
- 3) Perform a second repeated measurement only if the ratio of largest to smallest SAR for the original and first repeated measurements is > 1.20 or when the original or repeated measurement is ≥ 1.45 W/kg (~ 10% from the 1-g SAR limit).
- 4) Perform a third repeated measurement only if the original, first or second repeated measurement is ≥ 1.5 W/kg and the ratio of largest to smallest SAR for the original, first and second repeated measurements is > 1.20 .

5.2. SAR measurement uncertainty

Per KDB865664 D01 SAR Measurement 100 MHz to 6 GHz, when the highest measured 1-g SAR within a frequency band is < 1.5 W/kg, the extensive SAR measurement uncertainty analysis described in IEEE Std 1528-2013 is not required in SAR reports submitted for equipment approval. The equivalent ratio (1.5/1.6) is applied to extremity and occupational exposure conditions.

6. RF Exposure Positions

6.1. Ear and handset reference point

Figure 6.1.1 shows the front, back, and side views of the SAM phantom. The center-of-mouth reference point is labeled “M”, the left ear reference point (ERP) is marked “LE”, and the right ERP is marked “RE”.



Fig 6.1.1 Front, back, and side views of SAM phantom

6.2. Definition of the cheek position

1. Define two imaginary lines on the handset, the vertical centerline and the horizontal line. The vertical centerline passes through two points on the front side of the handset: the midpoint of the width w_t of the handset at the level of the acoustic output (point A in Figure 6.2.1 and Figure 6.2.2), and the midpoint of the width w_b of the bottom of the handset (point B). The horizontal line is perpendicular to the vertical centerline and passes through the center of the acoustic output (see Figure 6.2.1). The two lines intersect at point A. Note that for many handsets, point A coincides with the center of the acoustic output; however, the acoustic output may be located elsewhere on the horizontal line. Also note that the vertical centerline is not necessarily parallel to the front face of the handset (see Figure 6.2.2), especially for clamshell handsets, handsets with flip covers, and other irregularly-shaped handsets.
2. Position the handset close to the surface of the phantom such that point A is on the (virtual) extension of the line passing through points RE and LE on the phantom (see Figure 6.2.3), such that the plane defined by the vertical centerline and the horizontal line of the handset is approximately parallel to the sagittal plane of the phantom.
3. Translate the handset towards the phantom along the line passing through RE and LE until handset point A touches the pinna at the ERP
4. While maintaining the handset in this plane, rotate it around the LE-RE line until the vertical centerline is in the plane normal to the plane containing B-M and N-F lines, i.e., the Reference Plane.
5. Rotate the handset around the vertical centerline until the handset (horizontal line) is parallel to the N-F line.

6. While maintaining the vertical centerline in the Reference Plane, keeping point A on the line passing through RE and LE, and maintaining the handset contact with the pinna, rotate the handset about the N-F line until any point on the handset is in contact with a phantom point below the pinna on the cheek. See Figure 6.2.3. The actual rotation angles should be documented in the test report.

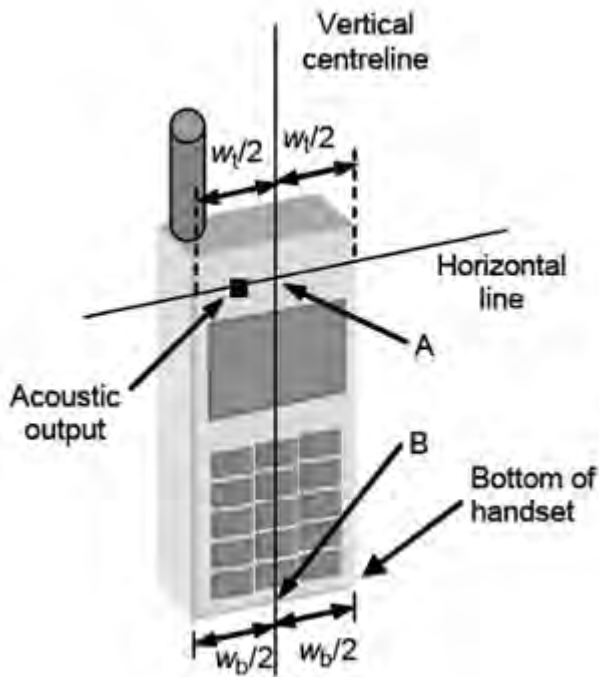

Fig 6.2.1 Handset vertical and horizontal reference lines—"fixed case"

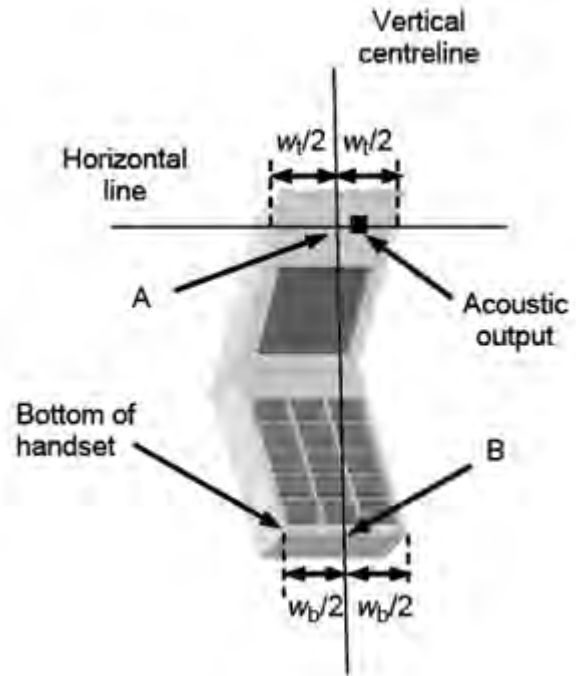

Fig 6.2.2 Handset vertical and horizontal reference lines—"clam-shell case"

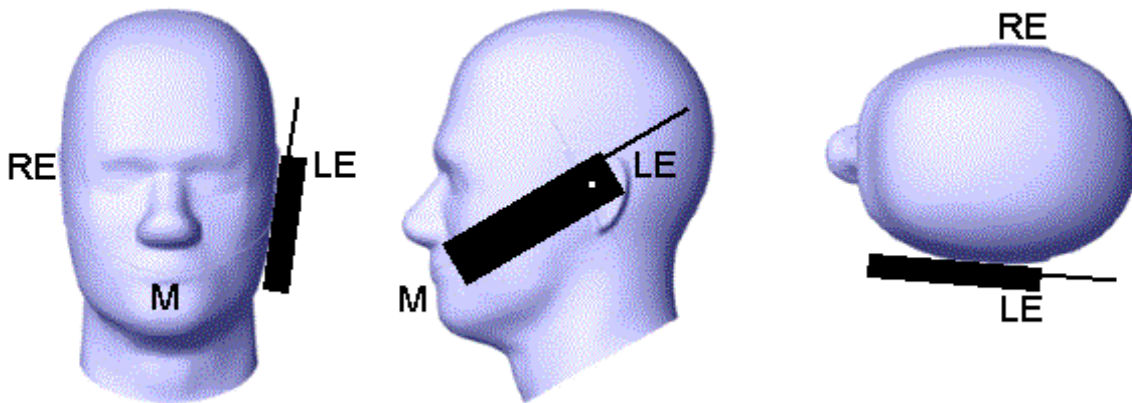

Fig 6.2.3 cheek or touch position. The reference points for the right ear (RE), left ear (LE), and mouth (M), which establish the Reference Plane for handset positioning, are indicated.

6.3. Definition of the tilt position

1. While maintaining the orientation of the handset, retract the handset parallel to the reference plane far enough away from the phantom to enable a rotation of the device by 15 degree.
2. Rotate the Handset around the horizontal line by 15 degree (see Figure 6.3.1).
3. While maintaining the orientation of the handset, move the handset towards the phantom on a line passing through RE and LE until any part of the handset touches the ear. The tilt position is obtained when the contact is on the pinna. If the contact is at any location other than the pinna, e.g., the antenna with the back of the phantom head, the angle of the handset shall be reduced. In this case, the tilt position is obtained if any part of the handset is in contact with the pinna as well as a second part of the handset is in contact with the phantom, e.g., the antenna with the back of the head.

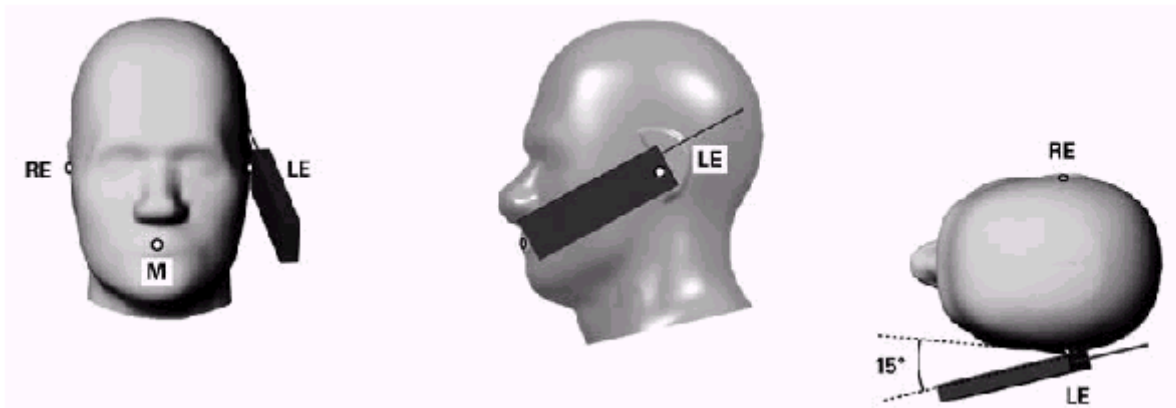

Figure 6.3.1 – Tilt position of the wireless device on the left side of SAM

6.4. Body Worn Accessory

1. Body-worn operating configurations are tested with the belt-clips and holsters attached to the device and positioned against a flat phantom in a normal use configuration (see Figure 6.4.1). Per KDB 648474 D04, body-worn accessory exposure is typically related to voice mode operations when handsets are carried in body-worn accessories. The body-worn accessory procedures in FCC KDB 447498 D01 should be used to test for body-worn accessory SAR compliance, without a headset connected to it. This enables the test results for such configuration to be compatible with that required for hotspot mode when the body-worn accessory test separation distance is greater than or equal to that required for hotspot mode, when applicable. When the reported SAR for body-worn accessory, measured without a headset connected to the handset is < 1.2 W/kg, the highest reported SAR configuration for that wireless mode and frequency band should be repeated for that body-worn accessory with a handset attached to the handset.
2. Accessories for body-worn operation configurations are divided into two categories: those that do not contain metallic components and those that do contain metallic components and those that do contain metallic components. When multiple accessories that do not contain metallic components are supplied with the device, the device is tested with only the accessory that dictates the closest

spacing to the body. Then multiple accessories that contain metallic components are test with the device with each accessory. If multiple accessories share an identical metallic component (i.e. the same metallic belt-clip used with different holsters with no other metallic components) only the accessory that dictates the closest spacing to the body is tested.

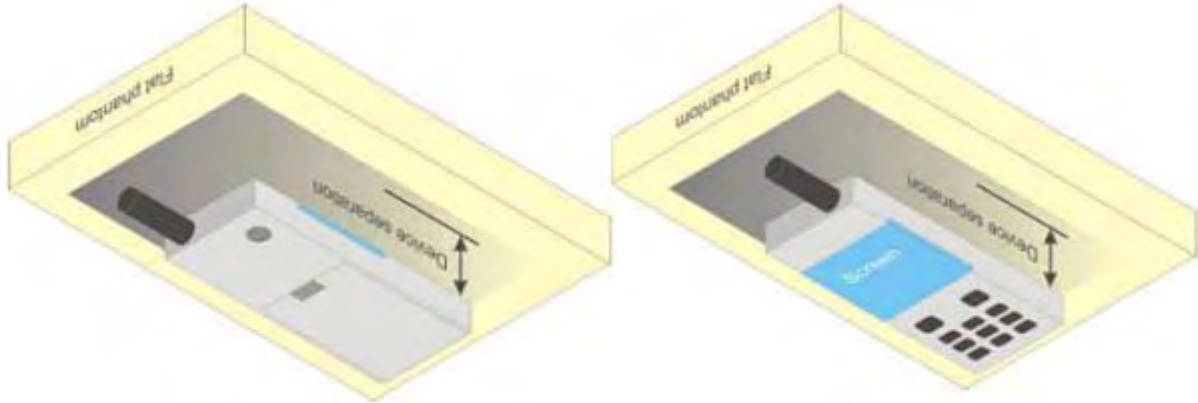

Figure 6.4.1 – Test positions for body-worn devices

6.5. Wireless Router Devices

Some battery-operated handsets have the capability to transmit and receive user through simultaneous transmission of WLAN simultaneously with a separate licensed transmitter. The FCC has provided guidance in FCC KDB Publication 941225 D06 where SAR test considerations for handsets ($L \times W \geq 9 \text{ cm} \times 5 \text{ cm}$) are based on a composite test separation distance of 10mm from the front, back and edges of the device containing transmitting antennas within 2.5cm of their edges, determined from general mixed use conditions for this type of devices. Since the hotspot SAR results may overlap with the body-worn accessory SAR requirements, the more conservative configurations can be considered, thus excluding some body-worn accessory SAR tests.

When the user enables the personal wireless router functions for the handset, actual operations include simultaneous transmission of both the WLAN transmitter and another licensed transmitter. Both transmitters often do not transmit at the same transmitting frequency and thus cannot be evaluated for SAR under actual use conditions due to the limitations of the SAR assessment probes. Therefore, SAR must be evaluated for each frequency transmission and mode separately and spatially summed with the WLAN transmitter according to FCC KDB Publication 447498 D01 publication procedures. The “Portable Hotspot” feature on the handset was NOT activated during SAR assessments, to ensure the SAR measurements were evaluated for a single transmission frequency RF signal at a time.

7. RF Output Power

7.1. GSM Conducted Power

Band GSM850	Burst-Averaged output Power (dBm)				Frame-Averaged output Power (dBm)			
Tx Channel	Tune-up	128	189	251	Tune-up	128	189	251
Frequency (MHz)	(dBm)	824.2	836.4	848.8	(dBm)	824.2	836.4	848.8
GSM (GMSK)	35.00	34.29	34.21	34.02	25.97	25.26	25.18	24.99
GPRS(GMSK, 1 TS)	35.00	34.19	34.28	34.13	25.97	25.16	25.25	25.10
GPRS(GMSK, 2 TS)	34.00	33.51	33.55	33.37	27.98	27.49	27.53	27.35
GPRS(GMSK, 3 TS)	32.00	31.75	31.77	31.62	27.74	27.49	27.51	27.36
GPRS(GMSK, 4 TS)	31.00	30.57	30.60	30.43	27.99	27.56	27.59	27.42
EDGE(GMSK, 1 TS)	30.00	29.01	29.02	29.07	20.97	19.98	19.99	20.04
EDGE(GMSK, 2 TS)	29.00	28.32	28.04	28.08	22.98	22.30	22.02	22.06
EDGE(GMSK, 3 TS)	27.00	25.91	25.76	26.67	22.74	21.65	21.50	22.41
EDGE(GMSK, 4 TS)	25.00	24.78	24.48	24.51	21.99	21.77	21.47	21.50
Band GSM1900	Burst-Averaged output Power (dBm)				Frame-Averaged output Power (dBm)			
Tx Channel	Tune-up	512	661	810	Tune-up	512	661	810
Frequency (MHz)	(dBm)	1850.2	1880.0	1909.8	(dBm)	1850.2	1880.0	1909.8
GSM (GMSK)	32.00	31.63	31.63	31.37	22.97	22.60	22.60	22.34
GPRS(GMSK, 1 TS)	32.00	31.71	31.70	31.45	22.97	22.68	22.67	22.42
GPRS(GMSK, 2 TS)	31.00	30.91	30.88	30.62	24.98	24.89	24.86	24.60
GPRS(GMSK, 3 TS)	30.00	29.07	29.03	28.79	25.74	24.81	24.77	24.53
GPRS(GMSK, 4 TS)	28.00	27.96	27.91	27.69	24.99	24.95	24.90	24.68
EDGE(GMSK, 1 TS)	29.00	28.66	28.34	28.41	19.97	19.63	19.31	19.38
EDGE(GMSK, 2 TS)	29.00	27.37	27.31	28.59	22.98	21.35	21.29	22.57
EDGE(GMSK, 3 TS)	26.00	25.25	25.25	25.47	21.74	20.99	20.99	21.21
EDGE(GMSK, 4 TS)	26.00	24.03	25.15	24.45	22.99	21.02	22.14	21.44

Note: The frame-averaged power is linearly scaled the maximum burst averaged power over 8 time slots.

The calculated method are shown as below:

Frame-averaged power = Maximum burst averaged power (1 TS) - 9.03 dB

Frame-averaged power = Maximum burst averaged power (2 TS) - 6.02 dB

Frame-averaged power = Maximum burst averaged power (3 TS) - 4.26 dB

Frame-averaged power = Maximum burst averaged power (4 TS) - 3.01 dB

7.2. WCDMA Conducted Power

Band	WCDMA Band 2			
Tx Channel	Tune-up	9262	9400	9538
Frequency (MHz)		1852.4	1880	1907.6
RMC 12.2Kbps	25.00	24.26	24.32	24.30
HSDPA Subtest-1	24.00	23.31	23.38	23.34
HSDPA Subtest-2	24.00	22.94	23.13	22.76
HSDPA Subtest-3	23.00	21.46	21.48	22.15
HSDPA Subtest-4	23.00	21.59	22.10	22.18
HSUPA Subtest-1	24.00	23.09	23.12	23.20
HSUPA Subtest-2	24.00	23.21	23.23	23.16
HSUPA Subtest-3	23.00	22.15	22.14	22.28
HSUPA Subtest-4	24.00	23.33	23.39	23.33
HSUPA Subtest-5	23.00	22.73	22.63	22.50
Band	WCDMA Band 4			
Tx Channel	Tune-up	1312	1413	1513
Frequency (MHz)		1712.4	1732.6	1752.6
RMC 12.2Kbps	24.00	23.57	23.47	22.80
HSDPA Subtest-1	23.00	22.12	22.01	21.79
HSDPA Subtest-2	22.00	21.62	21.22	21.27
HSDPA Subtest-3	21.00	20.64	20.38	20.22
HSDPA Subtest-4	21.00	20.67	20.57	20.25
HSUPA Subtest-1	22.00	21.70	21.72	21.47
HSUPA Subtest-2	23.00	22.10	21.93	21.76
HSUPA Subtest-3	21.00	20.96	20.81	20.46
HSUPA Subtest-4	23.00	22.09	21.90	21.71
HSUPA Subtest-5	22.00	21.35	21.11	21.12
Band	WCDMA Band 5			
Tx Channel	Tune-up	4132	4182	4233
Frequency (MHz)		826.4	836.4	846.6
RMC 12.2Kbps	24.00	23.80	23.84	23.72
HSDPA Subtest-1	23.00	22.92	22.95	22.81
HSDPA Subtest-2	23.00	22.33	22.62	22.43
HSDPA Subtest-3	22.00	21.24	21.46	20.96
HSDPA Subtest-4	22.00	21.13	21.34	21.10
HSUPA Subtest-1	23.00	22.70	22.66	22.62
HSUPA Subtest-2	23.00	22.78	22.69	22.70
HSUPA Subtest-3	23.00	21.68	22.02	21.62

HSUPA Subtest-4	23.00	22.88	22.92	22.80
HSUPA Subtest-5	23.00	22.22	22.33	22.14

7.3. LTE Conducted Power

Band	Band Width	Modulation	RB Configuration		Tune-up	Channel/Frequency(MHz)		
			RB Size	RB Offset		18607/1850.7	18900/1880	19193/1909.3
LTE Band 2	1.4MHz	QPSK	1	0	25.00	24.96	24.91	24.93
			1	2	25.00	24.97	24.97	24.89
			1	5	25.00	24.92	24.89	24.99
			3	0	25.00	24.72	24.86	24.72
			3	1	25.00	24.74	24.89	24.78
			3	2	25.00	24.73	24.85	24.68
		16QAM	6	0	25.00	24.00	23.95	24.15
			1	0	24.00	23.64	23.86	23.46
			1	2	24.00	23.79	23.98	23.64
			1	5	24.00	23.66	23.84	23.48
			3	0	24.00	23.77	23.98	23.71
			3	1	24.00	23.79	23.98	23.71
			3	2	24.00	23.75	23.99	23.70
			6	0	23.00	22.90	22.97	22.96
Band	Band Width	Modulation	RB Configuration		Tune-up	Channel/Frequency(MHz)		
			RB Size	RB Offset		18615/1851.5	18900/1880	19185/1908.5
LTE Band 2	3MHz	QPSK	1	0	25.50	24.91	24.95	25.03
			1	7	25.50	24.95	24.96	25.02
			1	14	25.50	24.98	24.93	24.98
			8	0	24.50	23.87	23.88	23.99
			8	4	24.50	23.90	23.92	24.01
			8	7	24.50	23.86	23.85	23.95
			15	0	24.00	23.75	23.84	23.81
		16QAM	1	0	25.00	23.93	23.85	23.56
			1	7	25.00	24.16	24.17	23.58
			1	14	25.00	23.92	23.85	23.49
			8	0	23.00	22.72	22.84	22.78
			8	4	23.00	22.75	22.85	22.78
			8	7	23.00	22.73	22.80	22.74

Band	Band Width	Modulation	RB Configuration		Tune-up	Channel/Frequency(MHz)		
			RB Size	RB Offset		18625/1852.5	18900/1880	19175/1907.5
			15	0	23.00	22.67	22.73	22.74
LTE Band 2	5MHz	QPSK	1	0	25.50	24.75	24.89	24.94
			1	12	25.50	25.02	25.13	25.12
			1	24	25.50	24.69	24.82	24.98
			12	0	24.00	23.70	23.77	23.83
			12	6	24.00	23.78	23.81	23.92
			12	11	24.00	23.71	23.79	23.80
			25	0	24.00	23.68	23.73	23.80
		16QAM	1	0	25.00	23.75	24.07	23.88
			1	12	25.00	24.11	24.41	24.22
			1	24	25.00	23.70	24.04	23.81
			12	0	23.00	22.62	22.70	22.67
			12	6	23.00	22.68	22.80	22.75
			12	11	23.00	22.62	22.74	22.61
			25	0	23.00	22.60	22.72	22.70
Band	Band Width	Modulation	RB Configuration		Tune-up	Channel/Frequency(MHz)		
			RB Size	RB Offset		18650/1855	18900/1880	19150/1905
LTE Band 2	10MHz	QPSK	1	0	25.50	25.03	24.98	25.01
			1	24	25.50	25.08	25.06	25.07
			1	49	25.50	25.00	24.92	25.06
			25	0	24.00	23.68	23.82	23.79
			25	12	24.00	23.71	23.81	23.82
			25	24	24.00	23.72	23.84	23.83
			50	0	24.00	23.63	23.81	23.77
		16QAM	1	0	25.00	23.89	23.82	23.46
			1	24	25.00	24.01	23.97	23.68
			1	49	25.00	23.86	23.77	23.46
			25	0	23.00	22.61	22.78	22.72
			25	12	23.00	22.65	22.79	22.76
			25	24	23.00	22.63	22.80	22.77
			50	0	23.00	22.59	22.81	22.72
Band	Band Width	Modulation	RB Configuration		Tune-up	Channel/Frequency(MHz)		
			RB	RB		18675/1857.5	18900/1880	19125/1902.5

Band	Band Width	Modulation	RB Configuration		Tune-up	Channel/Frequency(MHz)		
			RB Size	RB Offset		18700/1860	18900/1880	19100/1900
LTE Band 2	15MHz	QPSK	1	0	25.50	24.81	24.94	25.01
			1	37	25.50	25.03	25.06	25.02
			1	74	25.50	24.85	24.80	24.86
			36	0	24.50	23.96	24.09	24.14
			36	18	24.50	24.00	24.06	24.11
			36	37	24.50	23.97	23.99	24.10
			75	0	24.50	23.95	24.06	24.06
		16QAM	1	0	25.00	23.86	23.74	23.74
			1	37	25.00	24.18	24.06	24.00
			1	74	25.00	23.80	23.65	23.69
			36	0	23.00	22.75	22.95	22.83
			36	18	23.00	22.81	22.94	22.82
			36	37	23.00	22.77	22.94	22.83
			75	0	23.00	22.76	22.90	22.93

Band	Band Width	Modulation	RB Configuration		Tune-up	Channel/Frequency(MHz)		
			RB Size	RB Offset		19957/1710.7	20175/1732.5	20393/1754.3
LTE Band	1.4MHz	QPSK	1	0	25.00	24.29	24.46	24.26
			1	2	25.00	24.43	24.56	24.36

4			1	5	25.00	24.30	24.39	24.24
			3	0	25.00	24.30	24.29	24.34
			3	1	25.00	24.31	24.32	24.37
			3	2	25.00	24.28	24.29	24.31
			6	0	24.00	23.36	23.32	23.30
			6	0	24.00	23.03	23.26	23.37
		16QAM	1	2	24.00	23.16	23.40	23.51
			1	5	24.00	23.05	23.28	23.37
			3	0	24.00	23.36	23.34	23.46
			3	1	24.00	23.38	23.35	23.49
			3	2	24.00	23.38	23.31	23.48
			6	0	23.00	22.49	22.44	22.42
			6	0	23.00	22.49	22.44	22.42
Band	Band Width	Modulation	RB Configuration		Tune-up	Channel/Frequency(MHz)		
			RB Size	RB Offset		19965/1711.5	20175/1732.5	20385/1753.5
LTE Band 4	3MHz	QPSK	1	0	25.00	24.36	24.34	24.34
			1	7	25.00	24.68	24.61	24.61
			1	14	25.00	24.37	24.29	24.32
			8	0	24.00	23.34	23.33	23.35
			8	4	24.00	23.39	23.30	23.36
			8	7	24.00	23.35	23.33	23.32
			15	0	24.00	23.25	23.26	23.28
		16QAM	1	0	24.00	23.11	23.56	23.44
			1	7	24.00	23.38	23.78	23.72
			1	14	24.00	23.09	23.54	23.42
			8	0	23.00	22.29	22.31	22.31
			8	4	23.00	22.34	22.30	22.32
			8	7	23.00	22.30	22.30	22.29
			15	0	23.00	22.33	22.26	22.22
Band	Band Width	Modulation	RB Configuration		Tune-up	Channel/Frequency(MHz)		
			RB Size	RB Offset		19975/1712.5	20175/1732.5	20375/1752.5
LTE Band 4	5MHz	QPSK	1	0	25.00	24.25	24.29	24.24
			1	12	25.00	24.49	24.56	24.52
			1	24	25.00	24.27	24.22	24.20
			12	0	24.00	23.23	23.25	23.33
			12	6	24.00	23.33	23.31	23.34
			12	11	24.00	23.28	23.23	23.23

Band	Band Width	Modulation	RB Configuration		Tune-up	Channel/Frequency(MHz)		
			RB Size	RB Offset		20000/1715	20175/1732.5	20350/1750
		16QAM	25	0	24.00	23.26	23.21	23.27
			1	0	25.00	23.59	23.39	23.44
			1	12	25.00	24.01	23.62	23.79
			1	24	25.00	23.65	23.38	23.43
			12	0	23.00	22.25	22.17	22.31
			12	6	23.00	22.34	22.25	22.37
			12	11	23.00	22.31	22.15	22.21
			25	0	23.00	22.27	22.25	22.24
LTE Band 4	10MHz	QPSK	1	0	25.00	24.30	24.31	24.32
			1	24	25.00	24.46	24.43	24.46
			1	49	25.00	24.35	24.30	24.30
			25	0	24.00	23.26	23.29	23.36
			25	12	24.00	23.32	23.27	23.31
			25	24	24.00	23.30	23.22	23.23
			50	0	24.00	23.25	23.22	23.27
		16QAM	1	0	24.00	23.07	23.54	23.34
			1	24	24.00	23.21	23.64	23.50
			1	49	24.00	23.11	23.60	23.39
			25	0	23.00	22.28	22.28	22.38
			25	12	23.00	22.33	22.30	22.25
			25	24	23.00	22.33	22.24	22.19
			50	0	23.00	22.31	22.24	22.29
	Band Width	Modulation	RB Configuration		Tune-up	Channel/Frequency(MHz)		
			RB Size	RB Offset		20025/1717.5	20175/1732.5	20325/1747.5
LTE Band 4	15MHz	QPSK	1	0	25.00	24.20	24.25	24.20
			1	37	25.00	24.46	24.65	24.50
			1	74	25.00	24.17	24.26	24.12
			36	0	24.00	23.42	23.44	23.46
			36	18	24.00	23.44	23.46	23.49
			36	37	24.00	23.41	23.43	23.39
			75	0	24.00	23.39	23.41	23.43
		16QAM	1	0	24.00	23.51	23.28	23.26
			1	37	24.00	23.80	23.47	23.60
			1	74	24.00	23.41	23.26	23.25

Band	Band Width	Modulation	RB Configuration		Tune-up	Channel/Frequency(MHz)		
			RB Size	RB Offset		20050/1720	20175/1732.5	20300/1745
			36	0	23.00	22.37	22.39	22.35
			36	18	23.00	22.40	22.44	22.37
			36	37	23.00	22.41	22.41	22.22
			75	0	23.00	22.35	22.33	22.42
LTE Band 4	20MHz	QPSK	1	0	25.00	24.06	24.10	24.07
			1	49	25.00	24.81	24.47	24.48
			1	99	25.00	24.12	24.10	24.03
			50	0	24.00	23.23	23.30	23.40
			50	24	24.00	23.29	23.24	23.31
			50	49	24.00	23.25	23.20	23.23
			100	0	24.00	23.24	23.23	23.32
		16QAM	1	0	25.00	23.88	23.23	23.12
			1	49	25.00	24.17	23.59	23.50
			1	99	25.00	23.96	23.26	23.18
			50	0	23.00	22.29	22.31	22.40
			50	24	23.00	22.36	22.29	22.30
			50	49	23.00	22.30	22.27	22.14
			100	0	23.00	22.28	22.24	22.32

Band	Band Width	Modulation	RB Configuration		Tune-up	Channel/Frequency(MHz)		
			RB Size	RB Offset		20407/824.7	20525/836.5	20643/848.3
LTE Band 5	1.4MHz	QPSK	1	0	25.00	24.49	24.52	24.27
			1	2	25.00	24.60	24.65	24.35
			1	5	25.00	24.49	24.49	24.26
			3	0	25.00	24.34	24.46	24.24
			3	1	25.00	24.37	24.47	24.24
			3	2	25.00	24.32	24.46	24.21
			6	0	24.00	23.54	23.40	23.30
		16QAM	1	0	24.00	23.09	23.38	23.23
			1	2	24.00	23.23	23.49	23.32
			1	5	24.00	23.11	23.36	23.18
			3	0	24.00	23.36	23.48	23.32
			3	1	24.00	23.38	23.52	23.33
			3	2	24.00	23.40	23.46	23.30

Band	Band Width	Modulation	RB Configuration		Tune-up	Channel/Frequency(MHz)		
			RB Size	RB Offset		20415/825.5	20525/836.5	20635/847.5
			6	0	23.00	22.55	22.53	22.39
LTE Band 5	3MHz	QPSK	1	0	25.00	24.55	24.47	24.34
			1	7	25.00	24.81	24.71	24.52
			1	14	25.00	24.54	24.37	24.29
			8	0	24.00	23.45	23.42	23.27
			8	4	24.00	23.50	23.43	23.30
			8	7	24.00	23.48	23.44	23.24
			15	0	24.00	23.35	23.37	23.19
		16QAM	1	0	24.00	23.19	23.69	23.31
			1	7	24.00	23.38	23.91	23.56
			1	14	24.00	23.13	23.66	23.23
			8	0	23.00	22.35	22.39	22.20
			8	4	23.00	22.36	22.41	22.20
			8	7	23.00	22.33	22.39	22.16
			15	0	23.00	22.37	22.35	22.11
LTE Band 5	5MHz	QPSK	1	0	25.00	24.45	24.39	24.31
			1	12	25.00	24.71	24.75	24.59
			1	24	25.00	24.42	24.37	24.25
			12	0	24.00	23.36	23.38	23.26
			12	6	24.00	23.44	23.46	23.27
			12	11	24.00	23.38	23.40	23.20
			25	0	24.00	23.32	23.39	23.22
		16QAM	1	0	24.00	23.48	23.49	23.53
			1	12	24.00	23.79	23.83	23.81
			1	24	24.00	23.50	23.48	23.46
			12	0	23.00	22.25	22.35	22.18
			12	6	23.00	22.28	22.41	22.24
			12	11	23.00	22.25	22.38	22.13
			25	0	23.00	22.33	22.34	22.19
Band	Band Width	Modulation	RB Configuration		Tune-up	Channel/Frequency(MHz)		
			RB	RB		20450/829	20525/836.5	20600/844

			Size	Offset				
LTE Band 5	10MHz	QPSK	1	0	25.00	24.53	24.47	24.42
			1	24	25.00	24.63	24.54	24.49
			1	49	25.00	24.49	24.43	24.31
			25	0	24.00	23.42	23.47	23.42
			25	12	24.00	23.41	23.40	23.31
			25	24	24.00	23.43	23.43	23.26
		16QAM	50	0	24.00	23.40	23.44	23.32
			1	0	24.00	23.16	23.69	23.41
			1	24	24.00	23.29	23.78	23.38
			1	49	24.00	23.17	23.60	23.24
			25	0	23.00	22.38	22.46	22.39
			25	12	23.00	22.37	22.45	22.26
			25	24	23.00	22.41	22.43	22.21
			50	0	23.00	22.35	22.42	22.33

Band	Band Width	Modulation	RB Configuration		Tune-up	Channel/Frequency(MHz)		
			RB Size	RB Offset		20775/2502.5	21100/2535	21425/2567.5
LTE Band 7	5MHz	QPSK	1	0	21.00	20.29	20.99	20.83
			1	12	21.00	20.85	20.99	20.90
			1	24	21.00	20.47	20.93	20.90
			12	0	21.00	19.44	20.02	20.15
			12	6	21.00	19.53	20.11	20.19
			12	11	21.00	19.58	20.04	20.08
			25	0	21.00	19.52	20.04	20.12
		16QAM	1	0	21.00	19.78	20.53	20.32
			1	12	21.00	20.24	20.94	20.61
			1	24	21.00	19.85	20.50	20.40
			12	0	20.00	18.53	19.05	19.05
			12	6	20.00	18.60	19.13	19.15
			12	11	20.00	18.64	19.05	19.11
			25	0	20.00	18.49	19.07	19.20

Band	Band Width	Modulation	RB Configuration		Tune-up	Channel/Frequency(MHz)		
			RB Size	RB Offset		20800/2505	21100/2535	21400/2565
LTE Band	10MHz	QPSK	1	0	21.00	20.49	20.84	20.44
			1	24	21.00	20.76	20.99	20.01

7			1	49	21.00	20.69	20.99	20.20
			25	0	21.00	19.51	20.14	20.22
			25	12	21.00	19.67	20.15	20.06
			25	24	21.00	19.81	20.16	20.04
			50	0	21.00	19.67	20.13	20.10
		16QAM	1	0	21.00	19.39	20.47	20.27
			1	24	21.00	19.69	20.64	20.15
			1	49	21.00	19.61	20.47	20.36
			25	0	20.00	18.56	19.18	19.24
			25	12	20.00	18.69	19.21	19.18
			25	24	20.00	18.80	19.20	19.18
			50	0	20.00	18.69	19.14	19.25
Band	Band Width	Modulation	RB Configuration		Tune-up	Channel/Frequency(MHz)		
			RB Size	RB Offset		20825/2507.5	21100/2535	21375/2562.5
LTE Band 7	15MHz	QPSK	1	0	21.00	20.42	20.37	20.58
			1	37	21.00	20.96	20.77	19.95
			1	74	21.00	20.62	20.93	20.08
			36	0	21.00	19.46	20.06	20.15
			36	18	21.00	19.66	20.06	20.07
			36	37	21.00	19.76	20.09	20.00
			75	0	21.00	19.65	20.05	20.13
		16QAM	1	0	21.00	19.89	20.18	20.10
			1	37	21.00	20.48	20.46	20.09
			1	74	21.00	20.08	20.12	20.17
			36	0	20.00	18.57	19.14	19.10
			36	18	20.00	18.69	19.14	19.10
			36	37	20.00	18.81	19.15	19.06
			75	0	20.00	18.64	19.06	19.09
Band	Band Width	Modulation	RB Configuration		Tune-up	Channel/Frequency(MHz)		
			RB Size	RB Offset		20850/2510	21100/2535	21350/2560
LTE Band 7	20MHz	QPSK	1	0	21.00	20.24	19.69	20.53
			1	49	21.00	20.79	20.47	19.88
			1	99	21.00	20.47	20.83	19.64
			50	0	21.00	20.47	19.92	20.01
			50	24	21.00	20.72	20.10	19.99
			50	49	21.00	20.76	20.11	19.69

			100	0	21.00	20.64	20.14	19.96
		16QAM	1	0	21.00	20.56	19.67	20.17
			1	49	21.00	20.15	20.49	20.18
			1	99	21.00	20.94	20.08	19.90
			50	0	20.00	19.50	19.21	19.11
			50	24	20.00	19.76	19.20	19.24
			50	49	20.00	19.81	19.18	19.07
			100	0	20.00	19.69	19.20	19.07

Band	Band Width	Modulation	RB Configuration		Tune-up	Channel/Frequency(MHz)		
			RB Size	RB Offset		23017/699.7	23095/707.5	23173/715.3
LTE Band 12	1.4MHz	QPSK	1	0	22.00	21.79	21.00	21.10
			1	2	22.00	21.92	21.41	21.45
			1	5	22.00	21.75	21.07	21.03
			3	0	22.00	21.89	21.23	21.24
			3	1	22.00	21.89	21.34	21.35
			3	2	22.00	21.92	21.23	21.19
		16QAM	6	0	21.00	20.73	20.67	20.82
			1	0	22.00	21.00	20.98	20.76
			1	2	22.00	21.13	21.07	20.86
			1	5	22.00	21.03	21.00	20.67
			3	0	22.00	21.09	21.09	21.00
			3	1	22.00	21.08	21.10	21.01
			3	2	22.00	21.11	21.13	21.09
			6	0	21.00	20.04	19.95	20.07

Band	Band Width	Modulation	RB Configuration		Tune-up	Channel/Frequency(MHz)		
			RB Size	RB Offset		23025/700.5	23095/707.5	23165/714.5
LTE Band 12	3MHz	QPSK	1	0	22.00	21.83	21.21	21.35
			1	7	22.00	21.99	21.54	21.51
			1	14	22.00	21.84	21.31	21.09
			8	0	21.00	20.74	20.71	20.84
			8	4	21.00	20.80	20.78	20.86
			8	7	21.00	20.76	20.73	20.85
			15	0	21.00	20.77	20.72	20.80
			16QAM	1	0	22.00	20.77	21.28
		1		7	22.00	21.07	21.57	21.39

Band	Band Width	Modulation	RB Configuration		Tune-up	Channel/Frequency(MHz)		
			RB Size	RB Offset		23035/701.5	23095/707.5	23155/713.5
			1	14	22.00	20.76	21.25	21.07
			8	0	20.00	19.83	19.87	19.95
			8	4	20.00	19.90	19.90	19.94
			8	7	20.00	19.87	19.88	19.95
			15	0	20.00	19.97	19.85	19.90
LTE Band 12	5MHz	QPSK	1	0	22.00	21.75	21.55	21.74
			1	12	22.00	21.99	21.25	21.43
			1	24	22.00	21.79	21.53	21.35
			12	0	21.00	20.80	20.76	21.00
			12	6	21.00	20.87	20.81	20.91
			12	11	21.00	20.77	20.79	20.92
			25	0	21.00	20.83	20.77	20.95
		16QAM	1	0	22.00	21.34	21.14	21.17
			1	12	22.00	21.78	21.53	21.50
			1	24	22.00	21.36	21.09	21.16
			12	0	21.00	19.95	19.77	20.10
			12	6	21.00	19.96	19.86	20.05
			12	11	21.00	19.93	19.79	19.96
			25	0	21.00	19.92	19.86	20.04
			RB Configuration		Tune-up	Channel/Frequency(MHz)		
			RB Size	RB Offset		23060/704	23095/707.5	23130/711
LTE Band 12	10MHz	QPSK	1	0	22.00	21.82	21.84	21.57
			1	24	22.00	21.98	21.35	21.61
			1	49	22.00	21.62	21.54	21.30
			25	0	21.00	20.91	20.83	20.87
			25	12	21.00	20.90	20.82	20.84
			25	24	21.00	20.94	20.74	20.77
			50	0	21.00	20.94	20.79	20.85
		16QAM	1	0	22.00	20.69	21.27	21.01
			1	24	22.00	20.88	21.39	21.16
			1	49	22.00	20.73	21.29	21.08
			25	0	21.00	20.01	19.92	19.96
			25	12	21.00	19.99	19.95	19.99
			25	24	21.00	20.03	19.85	19.81

			50	0	21.00	20.04	19.93	19.99
--	--	--	----	---	-------	-------	-------	-------

Band	Band Width	Modulation	RB Configuration		Tune-up	Channel/Frequency(MHz)		
			RB Size	RB Offset		23755/706.5	23790/710	23825/713.5
LTE Band 17	5MHz	QPSK	1	0	25.00	23.88	23.81	23.85
			1	12	25.00	24.34	24.28	24.25
			1	24	25.00	23.82	23.78	23.85
			12	0	24.00	22.99	23.01	23.06
			12	6	24.00	23.08	23.07	23.06
			12	11	24.00	23.01	22.87	23.00
		16QAM	25	0	24.00	23.01	22.97	23.05
			1	0	24.00	23.28	23.18	23.39
			1	12	24.00	23.63	23.55	23.75
			1	24	24.00	23.23	23.18	23.37
			12	0	23.00	21.96	22.02	22.08
			12	6	23.00	22.02	22.11	22.05
			12	11	23.00	21.97	21.92	22.03
			25	0	23.00	22.03	21.98	22.05
Band	Band Width	Modulation	RB Configuration		Tune-up	Channel/Frequency(MHz)		
			RB Size	RB Offset		23780/709	23790/710	23800/711
LTE Band 17	10MHz	QPSK	1	0	25.00	24.14	23.91	23.88
			1	24	25.00	24.33	23.89	23.93
			1	49	25.00	24.21	23.88	23.90
			25	0	24.00	23.00	23.05	23.11
			25	12	24.00	23.00	23.03	23.00
			25	24	24.00	22.84	22.91	22.99
			50	0	24.00	22.97	23.00	23.06
		16QAM	1	0	24.00	22.89	23.37	22.81
			1	24	24.00	22.89	23.42	22.97
			1	49	24.00	22.82	23.36	22.76
			25	0	23.00	22.02	22.07	21.68
			25	12	23.00	22.00	22.06	21.56
			25	24	23.00	21.84	21.95	21.49
			50	0	22.00	21.97	21.99	21.64

7.4. WLAN & Bluetooth Output Power

7.4.1. Output Power Results Of WLAN

Mode	Channel	Frequency (MHz)	Tune-up	Output Power (dBm)
802.11b	1	2412	12.00	10.70
	6	2437	12.00	11.28
	11	2462	12.00	11.61
802.11g	1	2412	12.00	11.14
	6	2437	12.00	11.08
	11	2462	12.00	10.83
802.11n HT20	1	2412	11.00	10.96
	6	2437	11.00	10.91
	11	2462	11.00	10.96
802.11n HT40	3	2422	12.00	10.64
	6	2437	12.00	10.27
	9	2452	12.00	11.02

NOTE: Power measurement results of WLAN 2.4G.

7.4.2. Output Power Results Of Bluetooth

BR+EDR	Output Power (dBm)				
	Channel	Tune-up	Data Rates		
			1M	2M	3M
	0CH	6.000	5.541	4.627	4.723
	39CH	4.000	3.698	2.846	2.974
	78CH	4.000	3.938	2.861	3.190

BLE	Channel	Data Rates	Tune-up	Output Power (dBm)
	0CH	1M	-1.000	-1.826
	19CH		-1.000	-1.639
	39CH		-1.000	-1.769

8. Antenna Location

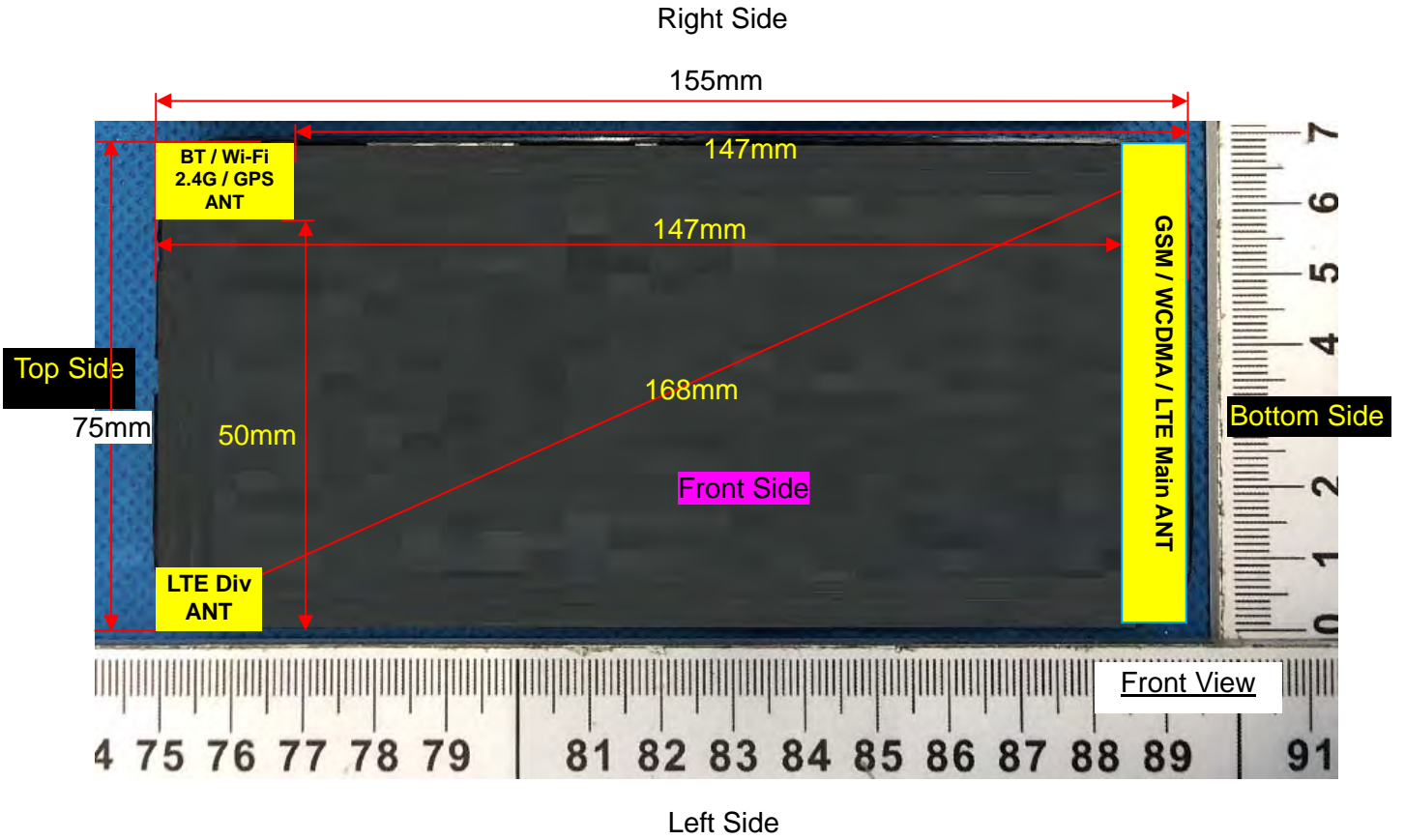

Distance of the Antenna to the EUT surface/edge						
Antennas	Front Side	Back Side	Left Side	Right Side	Top Side	Bottom Side
WWAN Main	≤ 25mm	≤ 25mm	≤ 25mm	≤ 25mm	>25mm	≤ 25mm
WLAN & Bluetooth	≤ 25mm	≤ 25mm	>25mm	≤ 25mm	≤ 25mm	>25mm
Positions for SAR tests						
Antennas	Front Side	Back Side	Left Side	Right Side	Top Side	Bottom Side
WWAN Main	Yes	Yes	Yes	Yes	NO	Yes
WLAN & Bluetooth	Yes	Yes	NO	Yes	Yes	NO

9. Stand-alone SAR test exclusion

Refer to FCC KDB 447498D01, the 1-g SAR and 10-g SAR test exclusion thresholds for 100 MHz to 6 GHz at test separation distances ≤ 50 mm are determined by:

$[(\text{max. power of channel, including tune-up tolerance, mW}) / (\text{min. test separation distance, mm})] \cdot [\sqrt{f_{(\text{GHz})}}] \leq 3.0$ for 1-g SAR and ≤ 7.5 for 10-g extremity SAR, where:

- $f_{(\text{GHz})}$ is the RF channel transmit frequency in GHz
- Power and distance are rounded to the nearest mW and mm before calculation
- The result is rounded to one decimal place for comparison

When the minimum test separation distance is < 5 mm, a distance of 5 mm is applied to determine SAR test exclusion.

Mode	P_{max} (dBm)	P_{max} (mW)	Distance (mm)	f (GHz)	Calculation Result	SAR Exclusion threshold	SAR test exclusion
Bluetooth	6	3.98	5	2.480	1.25	3.0	Yes

NOTE: Standalone SAR test exclusion for Bluetooth

When standalone SAR test exclusion applies to an antenna that transmits simultaneously with other antennas, the standalone SAR must be estimated according to following to determine simultaneous transmission SAR test exclusion:

$[(\text{max. power of channel, including tune-up tolerance, mW}) / (\text{min. test separation distance, mm})] \cdot [\sqrt{f_{(\text{GHz})} / x}] \text{ W/kg}$ for test separation distances ≤ 50 mm, where $x = 7.5$ for 1-g SAR and $x = 18.75$ for 10-g SAR.

When the minimum test separation distance is < 5 mm, a distance of 5 mm is applied to determine SAR test exclusion.

Mode	Position	P_{max} (dBm)	P_{max} (mW)	Distance (mm)	f (GHz)	x	Estimated SAR (W/Kg)
Bluetooth	Head	6	3.98	5	2.480	7.5	0.167
Bluetooth	Body	6	3.98	10	2.480	7.5	0.084
Bluetooth	Hotspot	6	3.98	10	2.480	7.5	0.084

NOTE: Estimated SAR calculation for Bluetooth

10. SAR Results

10.1. SAR measurement results

10.1.1. SAR measurement Result of GSM850

Test Position of Head	Test channel /Freq.	Test Mode	SAR Value (W/kg)		Power Drift ($\pm 5\%$)	Conducted power (dBm)	Tune-up power (dBm)	Scaled SAR 1g (W/Kg)
			1g	10g				
Left Cheek	189/836.4	GPRS(GMSK 4TS)	0.125	0.093	2.31	30.60	31.00	0.137
Left Tilt 15 Degree	189/836.4	GPRS(GMSK 4TS)	0.067	0.048	3.31	30.60	31.00	0.073
Right Cheek	189/836.4	GPRS(GMSK 4TS)	0.111	0.085	1.75	30.60	31.00	0.122
Right Tilt 15 Degree	189/836.4	GPRS(GMSK 4TS)	0.059	0.046	-1.61	30.60	31.00	0.065

NOTE: Head SAR test results of GSM850.

Test Position of Body-Worn with 10mm	Test channel /Freq.	Test Mode	SAR Value (W/kg)		Power Drift ($\pm 5\%$)	Conducted power (dBm)	Tune-up power (dBm)	Scaled SAR 1g (W/Kg)
			1g	10g				
Front Side	189/836.4	GPRS(GMSK 4TS)	0.182	0.126	2.13	30.60	31.00	0.200
Back Side	189/836.4	GPRS(GMSK 4TS)	0.240	0.167	-3.48	30.60	31.00	0.263

NOTE: Body-Worn SAR test results of GSM850

Test Position of Hotspot with 10mm	Test channel /Freq.	Test Mode	SAR Value (W/kg)		Power Drift ($\pm 5\%$)	Conducted power (dBm)	Tune-up power (dBm)	Scaled SAR 1g (W/Kg)
			1g	10g				
Front Side	189/836.4	GPRS(GMSK 4TS)	0.182	0.126	2.13	30.60	31.00	0.200
Back Side	189/836.4	GPRS(GMSK 4TS)	0.240	0.167	-3.48	30.60	31.00	0.263
Left Side	189/836.4	GPRS(GMSK 4TS)	0.192	0.130	3.65	30.60	31.00	0.211
Right Side	189/836.4	GPRS(GMSK 4TS)	0.119	0.080	1.79	30.60	31.00	0.130
Bottom Side	189/836.4	GPRS(GMSK 4TS)	0.086	0.064	2.29	30.60	31.00	0.094

NOTE: Hotspot SAR test results of GSM850

10.1.2. SAR measurement Result of GSM1900

Test Position of Head	Test channel /Freq.	Test Mode	SAR Value (W/kg)		Power Drift ($\pm 5\%$)	Conducted power (dBm)	Tune-up power (dBm)	Scaled SAR 1g (W/Kg)
			1g	10g				
Left Cheek	661/1880	GPRS(GMSK 3TS)	0.053	0.036	-2.39	29.03	30.00	0.066
Left Tilt 15 Degree	661/1880	GPRS(GMSK 3TS)	0.031	0.026	-2.29	29.03	30.00	0.039
Right Cheek	661/1880	GPRS(GMSK 3TS)	0.046	0.030	4.85	29.03	30.00	0.058
Right Tilt 15 Degree	661/1880	GPRS(GMSK 3TS)	0.021	0.015	-2.54	29.03	30.00	0.026

NOTE: Head SAR test results of GSM1900

Test Position of Body-Worn with 10mm	Test channel /Freq.	Test Mode	SAR Value (W/kg)		Power Drift ($\pm 5\%$)	Conducted power (dBm)	Tune-up power (dBm)	Scaled SAR 1g (W/Kg)
			1g	10g				
Front Side	661/1880	GPRS(GMSK 3TS)	0.232	0.122	-0.75	29.03	30.00	0.290
Back Side	661/1880	GPRS(GMSK 3TS)	0.296	0.161	-3.62	29.03	30.00	0.370

NOTE: Body-Worn SAR test results of GSM1900

Test Position of Hotspot with 10mm	Test channel /Freq.	Test Mode	SAR Value (W/kg)		Power Drift ($\pm 5\%$)	Conducted power (dBm)	Tune-up power (dBm)	Scaled SAR 1g (W/Kg)
			1g	10g				
Front Side	661/1880	GPRS(GMSK 3TS)	0.232	0.122	-0.75	29.03	30.00	0.290
Back Side	661/1880	GPRS(GMSK 3TS)	0.296	0.161	-3.62	29.03	30.00	0.370
Left Side	661/1880	GPRS(GMSK 3TS)	0.225	0.126	-0.14	29.03	30.00	0.281
Right Side	661/1880	GPRS(GMSK 3TS)	0.137	0.079	4.45	29.03	28.00	0.108
Bottom Side	661/1880	GPRS(GMSK 3TS)	0.111	0.064	4.86	29.03	30.00	0.139

NOTE: Hotspot SAR test results of GSM1900

10.1.3. SAR measurement Result of WCDMA Band 2

Test Position of Head	Test channel /Freq.	Test Mode	SAR Value (W/kg)		Power Drift (±5%)	Conducted power (dBm)	Tune-up power (dBm)	Scaled SAR 1g (W/Kg)
			1g	10g				
Left Cheek	9400/1880	RMC12.2K	0.069	0.046	-1.31	24.32	25.00	0.081
Left Tilt 15 Degree	9400/1880	RMC12.2K	0.036	0.025	-1.57	24.32	25.00	0.042
Right Cheek	9400/1880	RMC12.2K	0.063	0.043	-2.74	24.32	25.00	0.074
Right Tilt 15 Degree	9400/1880	RMC12.2K	0.030	0.023	-3.31	24.32	25.00	0.035

NOTE: Head SAR test results of WCDMA Band 2

Test Position of Body-Worn with 10mm	Test channel /Freq.	Test Mode	SAR Value (W/kg)		Power Drift (±5%)	Conducted power (dBm)	Tune-up power (dBm)	Scaled SAR 1g (W/Kg)
			1g	10g				
Front Side	9400/1880	RMC12.2K	0.339	0.178	4.35	24.32	25.00	0.396
Back Side	9400/1880	RMC12.2K	0.447	0.241	-2.79	24.32	25.00	0.523

NOTE: Body-Worn SAR test results of WCDMA Band 2

Test Position of Hotspot with 10mm	Test channel /Freq.	Test Mode	SAR Value (W/kg)		Power Drift (±5%)	Conducted power (dBm)	Tune-up power (dBm)	Scaled SAR 1g (W/Kg)
			1g	10g				
Front Side	9400/1880	RMC12.2K	0.339	0.178	4.35	24.32	25.00	0.396
Back Side	9400/1880	RMC12.2K	0.447	0.241	-2.79	24.32	25.00	0.523
Left Side	9400/1880	RMC12.2K	0.326	0.172	-2.87	24.32	25.00	0.381
Right Side	9400/1880	RMC12.2K	0.199	0.103	-0.02	24.32	25.00	0.233
Bottom Side	9400/1880	RMC12.2K	0.164	0.087	-1.61	24.32	25.00	0.192

NOTE: Hotspot SAR test results of WCDMA Band 2

10.1.4. SAR measurement Result of WCDMA Band 4

Test Position of Head	Test channel /Freq.	Test Mode	SAR Value (W/kg)		Power Drift (±5%)	Conducted power (dBm)	Tune-up power (dBm)	Scaled SAR 1g (W/Kg)
			1g	10g				
Left Cheek	1413/1732.6	RMC12.2K	0.204	0.132	2.00	23.47	24.00	0.230
Left Tilt 15 Degree	1413/1732.6	RMC12.2K	0.123	0.075	3.21	23.47	24.00	0.139
Right Cheek	1413/1732.6	RMC12.2K	0.192	0.117	1.02	23.47	24.00	0.217
Right Tilt 15	1413/1732.6	RMC12.2K	0.109	0.068	0.57	23.47	24.00	0.123

Degree								
--------	--	--	--	--	--	--	--	--

NOTE: Head SAR test results of WCDMA Band 4

Test Position of Body-Worn with 10mm	Test channel /Freq.	Test Mode	SAR Value (W/kg)		Power Drift (±5%)	Conducted power (dBm)	Tune-up power (dBm)	Scaled SAR 1g (W/Kg)
			1g	10g				
Front Side	1413/1732.6	RMC12.2K	0.462	0.276	-0.89	23.47	24.00	0.522
Back Side	1413/1732.6	RMC12.2K	0.529	0.321	-0.91	23.47	24.00	0.598

NOTE: Body-Worn SAR test results of WCDMA Band 4

Test Position of Hotspot with 10mm	Test channel /Freq.	Test Mode	SAR Value (W/kg)		Power Drift (±5%)	Conducted power (dBm)	Tune-up power (dBm)	Scaled SAR 1g (W/Kg)
			1g	10g				
Front Side	1413/1732.6	RMC12.2K	0.462	0.276	-0.89	23.47	24.00	0.522
Back Side	1413/1732.6	RMC12.2K	0.529	0.321	-0.91	23.47	24.00	0.598
Left Side	1413/1732.6	RMC12.2K	0.252	0.168	1.25	23.47	24.00	0.285
Right Side	1413/1732.6	RMC12.2K	0.129	0.105	0.01	23.47	24.00	0.146
Bottom Side	1413/1732.6	RMC12.2K	0.511	0.306	-0.04	23.47	24.00	0.577

NOTE: Hotspot SAR test results of WCDMA Band 4

10.1.5. SAR measurement Result of WCDMA Band 5

Test Position of Head	Test channel /Freq.	Test Mode	SAR Value (W/kg)		Power Drift (±5%)	Conducted power (dBm)	Tune-up power (dBm)	Scaled SAR 1g (W/Kg)
			1g	10g				
Left Cheek	4182/836.4	RMC12.2K	0.067	0.053	-0.10	23.84	24.00	0.070
Left Tilt 15 Degree	4182/836.4	RMC12.2K	0.038	0.030	-4.28	23.84	24.00	0.039
Right Cheek	4182/836.4	RMC12.2K	0.058	0.049	-3.39	23.84	24.00	0.060
Right Tilt 15 Degree	4182/836.4	RMC12.2K	0.028	0.025	-3.71	23.84	24.00	0.029

NOTE: Head SAR test results of WCDMA Band 5

Test Position of Body-Worn with 10mm	Test channel /Freq.	Test Mode	SAR Value (W/kg)		Power Drift (±5%)	Conducted power (dBm)	Tune-up power (dBm)	Scaled SAR 1g (W/Kg)
			1g	10g				
Front Side	4182/836.4	RMC12.2K	0.090	0.062	0.55	23.84	24.00	0.093
Back Side	4182/836.4	RMC12.2K	0.106	0.076	-1.36	23.84	24.00	0.110

NOTE: Body-Worn SAR test results of WCDMA Band 5

Test Position of Hotspot with	Test channel	Test Mode	SAR Value (W/kg)	Power Drift	Conducted power	Tune-up power	Scaled SAR 1g
-------------------------------	--------------	-----------	------------------	-------------	-----------------	---------------	---------------

10mm	/Freq.		1g	10g	(±5%)	(dBm)	(dBm)	(W/Kg)
Front Side	4182/836.4	RMC12.2K	0.090	0.062	0.55	23.84	24.00	0.093
Back Side	4182/836.4	RMC12.2K	0.106	0.076	-1.36	23.84	24.00	0.110
Left Side	4182/836.4	RMC12.2K	0.077	0.059	4.12	23.84	24.00	0.080
Right Side	4182/836.4	RMC12.2K	0.046	0.034	-4.62	23.84	24.00	0.048
Bottom Side	4182/836.4	RMC12.2K	0.041	0.025	3.77	23.84	24.00	0.043

NOTE: Hotspot SAR test results of WCDMA Band 5

10.1.6. SAR measurement Result of LTE Band 2

Test Position of Head	Test channel /Freq.	Test Mode	SAR Value (W/kg)		Power Drift (±5%)	Conducted power (dBm)	Tune-up power (dBm)	Scaled SAR 1g (W/Kg)
			1g	10g				
1RB								
Left Cheek	18900/1880	20M QPSK(1,49)	0.066	0.044	2.01	25.08	25.50	0.073
Left Tilt 15 Degree	18900/1880	20M QPSK(1,49)	0.036	0.020	3.05	25.08	25.50	0.040
Right Cheek	18900/1880	20M QPSK(1,49)	0.060	0.035	3.46	25.08	25.50	0.066
Right Tilt 15 Degree	18900/1880	20M QPSK(1,49)	0.031	0.024	2.45	25.08	25.50	0.034
50%RB								
Left Cheek	18900/1880	1.4M QPSK(3,1)	0.062	0.038	4.41	24.89	25.00	0.064
Left Tilt 15 Degree	18900/1880	1.4M QPSK(3,1)	0.033	0.019	-1.13	24.89	25.00	0.034
Right Cheek	18900/1880	1.4M QPSK(3,1)	0.052	0.030	1.98	24.89	25.00	0.053
Right Tilt 15 Degree	18900/1880	1.4M QPSK(3,1)	0.028	0.022	2.11	24.89	25.00	0.029

NOTE: Head SAR test results of LTE Band 2

Test Position of Body-Wor	Test channel /Freq.	Test Mode	SAR Value (W/kg)		Power Drift (±5%)	Conducted power	Tune-up power	Scaled SAR 1g (W/Kg)
			1g	10g				

n with 10mm						(dBm)	(dBm)	
1RB								
Front Side	18900/1880	20M QPSK(1,49)	0.332	0.182	4.71	25.08	25.50	0.366
Back Side	18900/1880	20M QPSK(1,49)	0.394	0.215	-0.73	25.08	25.50	0.434
50%RB								
Front Side	18900/1880	1.4M QPSK(3,1)	0.311	0.166	-2.52	24.89	25.00	0.319
Back Side	18900/1880	1.4M QPSK(3,1)	0.365	0.188	1.47	24.89	25.00	0.374

NOTE: Body-Worn SAR test results of LTE Band 2

Test Position of Hotspot with 10mm	Test channel /Freq.	Test Mode	SAR Value (W/kg)		Power Drift (±5%)	Conduc ted power (dBm)	Tune-u p power (dBm)	Scaled SAR 1g (W/Kg)
			1g	10g				
1RB								
Front Side	18900/1880	20M QPSK(1,49)	0.332	0.182	4.71	25.08	25.50	0.366
Back Side	18900/1880	20M QPSK(1,49)	0.394	0.215	-0.73	25.08	25.50	0.434
Left Side	18900/1880	20M QPSK(1,49)	0.314	0.171	4.77	25.08	25.50	0.346
Right Side	18900/1880	20M QPSK(1,49)	0.185	0.103	-2.49	25.08	25.50	0.204
Bottom Side	18900/1880	20M QPSK(1,49)	0.145	0.075	-0.64	25.08	25.50	0.160
50%RB								
Front Side	18900/1880	1.4M QPSK(3,1)	0.311	0.166	-2.52	24.89	25.00	0.319
Back Side	18900/1880	1.4M QPSK(3,1)	0.365	0.188	1.47	24.89	25.00	0.374
Left Side	18900/1880	1.4M QPSK(3,1)	0.293	0.162	-0.15	24.89	25.00	0.301
Right Side	18900/1880	1.4M QPSK(3,1)	0.175	0.091	-4.45	24.89	25.00	0.179
Bottom Side	18900/1880	1.4M QPSK(3,1)	0.126	0.068	-4.40	24.89	25.00	0.129

NOTE: Hotspot SAR test results of LTE Band 2

10.1.7. SAR measurement Result of LTE Band 4

Test Position of Head	Test channel /Freq.	Test Mode	SAR Value (W/kg)		Power Drift (±5%)	Conducted power (dBm)	Tune-up power (dBm)	Scaled SAR 1g (W/Kg)
			1g	10g				
1RB								

Left Cheek	20175/1732.5	20M QPSK(1,49)	0.090	0.061	1.44	24.47	25.00	0.102
Left Tilt 15 Degree	20175/1732.5	20M QPSK(1,49)	0.052	0.037	3.40	24.47	25.00	0.059
Right Cheek	20175/1732.5	20M QPSK(1,49)	0.082	0.057	-4.10	24.47	25.00	0.093
Right Tilt 15 Degree	20175/1732.5	20M QPSK(1,49)	0.043	0.033	-4.66	24.47	25.00	0.049
50%RB								
Left Cheek	20175/1732.5	1.4M QPSK(3,1)	0.084	0.053	4.42	24.32	25.00	0.098
Left Tilt 15 Degree	20175/1732.5	1.4M QPSK(3,1)	0.048	0.034	1.69	24.32	25.00	0.056
Right Cheek	20175/1732.5	1.4M QPSK(3,1)	0.075	0.052	-2.75	24.32	25.00	0.088
Right Tilt 15 Degree	20175/1732.5	1.4M QPSK(3,1)	0.039	0.029	2.42	24.32	25.00	0.046

NOTE: Head SAR test results of LTE Band 4

Test Position of Body-Worn with 10mm	Test channel /Freq.	Test Mode	SAR Value (W/kg)		Power Drift (±5%)	Conducted power (dBm)	Tune-up power (dBm)	Scaled SAR 1g (W/Kg)
			1g	10g				
1RB								
Front Side	20175/1732.5	20M QPSK(1,49)	0.253	0.142	-4.05	24.47	25.00	0.286
Back Side	20175/1732.5	20M QPSK(1,49)	0.323	0.183	-2.99	24.47	25.00	0.365
50%RB								
Front Side	20175/1732.5	1.4M QPSK(3,1)	0.215	0.125	-3.63	24.32	25.00	0.251
Back Side	20175/1732.5	1.4M QPSK(3,1)	0.289	0.165	-1.84	24.32	25.00	0.338

NOTE: Body-Worn SAR test results of LTE Band 4

Test Position of	Test channel /Freq.	Test Mode	SAR Value (W/kg)	Power Drift	Conducted	Tune-up	Scaled SAR 1g
------------------	---------------------	-----------	------------------	-------------	-----------	---------	---------------

Hotspot with 10mm			1g	10g	(±5%)	power (dBm)	power (dBm)	(W/Kg)
1RB								
Front Side	20175/1732.5	20M QPSK(1,49)	0.253	0.142	-4.05	24.47	25.00	0.286
Back Side	20175/1732.5	20M QPSK(1,49)	0.323	0.183	-2.99	24.47	25.00	0.365
Left Side	20175/1732.5	20M QPSK(1,49)	0.258	0.149	1.42	24.47	25.00	0.291
Right Side	20175/1732.5	20M QPSK(1,49)	0.143	0.085	4.67	24.47	25.00	0.162
Bottom Side	20175/1732.5	20M QPSK(1,49)	0.124	0.066	2.86	24.47	25.00	0.140
50%RB								
Front Side	20175/1732.5	1.4M QPSK(3,1)	0.215	0.125	-3.63	24.32	25.00	0.251
Back Side	20175/1732.5	1.4M QPSK(3,1)	0.289	0.165	-1.84	24.32	25.00	0.338
Left Side	20175/1732.5	1.4M QPSK(3,1)	0.226	0.139	2.98	24.32	25.00	0.264
Right Side	20175/1732.5	1.4M QPSK(3,1)	0.123	0.080	0.69	24.32	25.00	0.144
Bottom Side	20175/1732.5	1.4M QPSK(3,1)	0.116	0.057	-0.07	24.32	25.00	0.136

NOTE: Hotspot SAR test results of LTE Band 4

10.1.8. SAR measurement Result of LTE Band 5

Test Position of Head	Test channel /Freq.	Test Mode	SAR Value (W/kg)		Power Drift (±5%)	Conducted power (dBm)	Tune-up power (dBm)	Scaled SAR 1g (W/Kg)
			1g	10g				
1RB								
Left Cheek	20525/836.5	10M QPSK(1,24)	0.064	0.052	1.24	24.54	25.00	0.071
Left Tilt 15 Degree	20525/836.5	10M QPSK(1,24)	0.037	0.025	3.76	24.54	25.00	0.041
Right Cheek	20525/836.5	10M QPSK(1,24)	0.060	0.045	3.19	24.54	25.00	0.067
Right Tilt	20525/836.5	10M QPSK(1,24)	0.029	0.026	-1.26	24.54	25.00	0.032

15 Degree								
50%RB								
Left Cheek	20525/836.5	1.4M QPSK(3,1)	0.060	0.048	-2.40	24.47	25.00	0.068
Left Tilt 15 Degree	20525/836.5	1.4M QPSK(3,1)	0.033	0.021	-2.26	24.47	25.00	0.037
Right Cheek	20525/836.5	1.4M QPSK(3,1)	0.052	0.042	4.36	24.47	25.00	0.059
Right Tilt 15 Degree	20525/836.5	1.4M QPSK(3,1)	0.026	0.022	4.18	24.47	25.00	0.029

NOTE: Head SAR test results of LTE Band 5

Test Position of Body-Worn with 10mm	Test channel /Freq.	Test Mode	SAR Value (W/kg)		Power Drift ($\pm 5\%$)	Conducted power (dBm)	Tune-up power (dBm)	Scaled SAR 1g (W/Kg)
			1g	10g				
1RB								
Front Side	20525/836.5	10M QPSK(1,24)	0.107	0.082	-1.85	24.54	25.00	0.119
Back Side	20525/836.5	10M QPSK(1,24)	0.129	0.093	-0.65	24.54	25.00	0.143
50%RB								
Front Side	20525/836.5	1.4M QPSK(3,1)	0.099	0.075	-1.91	24.47	25.00	0.112
Back Side	20525/836.5	1.4M QPSK(3,1)	0.121	0.079	4.37	24.47	25.00	0.137

NOTE: Body-Worn SAR test results of LTE Band 5

Test Position of Hotspot with 10mm	Test channel /Freq.	Test Mode	SAR Value (W/kg)		Power Drift ($\pm 5\%$)	Conducted power (dBm)	Tune-up power (dBm)	Scaled SAR 1g (W/Kg)
			1g	10g				
1RB								
Front Side	20525/836.5	10M QPSK(1,24)	0.107	0.082	-1.85	24.54	25.00	0.119
Back Side	20525/836.5	10M QPSK(1,24)	0.129	0.093	-0.65	24.54	25.00	0.143
Left Side	20525/836.5	10M	0.095	0.064	1.40	24.54	25.00	0.106

		QPSK(1,24)						
Right Side	20525/836.5	10M QPSK(1,24)	0.061	0.042	1.93	24.54	25.00	0.068
Bottom Side	20525/836.5	10M QPSK(1,24)	0.045	0.029	-2.62	24.54	25.00	0.050
50%RB								
Front Side	20525/836.5	1.4M QPSK(3,1)	0.099	0.075	-1.91	24.47	25.00	0.112
Back Side	20525/836.5	1.4M QPSK(3,1)	0.121	0.079	4.37	24.47	25.00	0.137
Left Side	20525/836.5	1.4M QPSK(3,1)	0.081	0.057	4.91	24.47	25.00	0.092
Right Side	20525/836.5	1.4M QPSK(3,1)	0.055	0.037	2.08	24.47	25.00	0.062
Bottom Side	20525/836.5	1.4M QPSK(3,1)	0.041	0.027	1.51	24.47	25.00	0.046

NOTE: Hotspot SAR test results of LTE Band 5

10.1.9. SAR measurement Result of LTE Band 7

Test Position of Head	Test channel /Freq.	Test Mode	SAR Value (W/kg)		Power Drift (±5%)	Conducted power (dBm)	Tune-up power (dBm)	Scaled SAR 1g (W/Kg)
			1g	10g				
1RB								
Left Cheek	21100/2535	20M QPSK(1,99)	0.397	0.224	-1.26	20.83	21.00	0.413
Left Tilt 15 Degree	21100/2535	20M QPSK(1,99)	0.232	0.133	1.62	20.83	21.00	0.241
Right Cheek	21100/2535	20M QPSK(1,99)	0.342	0.189	4.14	20.83	21.00	0.356
Right Tilt 15 Degree	21100/2535	20M QPSK(1,99)	0.169	0.092	2.20	20.83	21.00	0.176
50%RB								
Left Cheek	21100/2535	20M QPSK(50,49)	0.362	0.203	0.31	20.11	21.00	0.444
Left Tilt 15 Degree	21100/2535	20M QPSK(50,49)	0.212	0.125	4.59	20.11	21.00	0.260
Right	21100/2535	20M	0.317	0.175	4.34	20.11	21.00	0.389

Cheek		QPSK(50,49)						
Right Tilt 15 Degree	21100/2535	20M QPSK(50,49)	0.157	0.079	-3.72	20.11	21.00	0.193

NOTE: Head SAR test results of LTE Band 7

Test Position of Body-Worn with 10mm	Test channel /Freq.	Test Mode	SAR Value (W/kg)		Power Drift (±5%)	Conducted power (dBm)	Tune-up power (dBm)	Scaled SAR 1g (W/Kg)
			1g	10g				
1RB								
Front Side	21100/2535	20M QPSK(1,99)	0.608	0.322	-0.50	20.83	21.00	0.632
Back Side	21100/2535	20M QPSK(1,99)	1.006	0.604	-1.15	20.83	21.00	1.046
Back Side Repeated	21100/2535	20M QPSK(1,99)	1.004	0.602	-1.33	20.83	21.00	1.044
Back Side	20850/2510	20M QPSK(1,99)	0.788	0.401	2.01	20.47	21.00	0.890
Back Side	21350/2560	20M QPSK(1,99)	0.764	0.392	1.47	19.64	21.00	1.045
50%RB								
Front Side	21100/2535	20M QPSK(50,49)	0.361	0.183	-2.24	20.11	21.00	0.443
Back Side	21100/2535	20M QPSK(50,49)	0.607	0.304	0.73	20.11	21.00	0.745
100%RB								
Back Side	21100/2535	20M QPSK(100,0)	0.438	0.220	-3.94	20.14	21.00	0.534

NOTE: Body-Worn SAR test results of LTE Band 7

Test Position of Hotspot with 10mm	Test channel /Freq.	Test Mode	SAR Value (W/kg)		Power Drift (±5%)	Conducted power (dBm)	Tune-up power (dBm)	Scaled SAR 1g (W/Kg)
			1g	10g				
1RB								
Front Side	21100/2535	20M QPSK(1,99)	0.608	0.322	-0.50	20.83	21.00	0.632
Back Side	21100/2535	20M QPSK(1,99)	1.006	0.604	-1.15	20.83	21.00	1.046
Back Side Repeated	21100/2535	20M QPSK(1,99)	1.004	0.602	-1.33	20.83	21.00	1.044
Left Side	21100/2535	20M QPSK(1,99)	0.461	0.235	1.03	20.83	21.00	0.479

Right Side	21100/2535	20M QPSK(1,99)	0.463	0.236	-2.40	20.83	21.00	0.481
Bottom Side	21100/2535	20M QPSK(1,99)	0.429	0.211	3.59	20.83	21.00	0.446
Back Side	20850/2510	20M QPSK(1,99)	0.788	0.401	2.01	20.47	21.00	0.890
Back Side	21350/2560	20M QPSK(1,99)	0.764	0.392	1.47	19.64	21.00	1.045
50%RB								
Front Side	21100/2535	20M QPSK(50,49)	0.361	0.183	-2.24	20.11	21.00	0.443
Back Side	21100/2535	20M QPSK(50,49)	0.607	0.304	0.73	20.11	21.00	0.745
Left Side	21100/2535	20M QPSK(50,49)	0.267	0.127	0.33	20.11	21.00	0.328
Right Side	21100/2535	20M QPSK(50,49)	0.245	0.127	3.61	20.11	21.00	0.301
Bottom Side	21100/2535	20M QPSK(50,49)	0.215	0.126	-0.53	20.11	21.00	0.264
100%RB								
Back Side	21100/2535	20M QPSK(100,0)	0.438	0.220	-3.94	20.14	21.00	0.534

NOTE: Hotspot SAR test results of LTE Band 7

10.1.10. SAR measurement Result of LTE Band 12

Test Position of Head	Test channel /Freq.	Test Mode	SAR Value (W/kg)		Power Drift (±5%)	Conducted power (dBm)	Tune-up power (dBm)	Scaled SAR 1g (W/Kg)
			1g	10g				
1RB								
Left Cheek	23095/707.5	10M QPSK(1,24)	0.031	0.027	-0.21	21.35	22.00	0.036
Left Tilt 15 Degree	23095/707.5	10M QPSK(1,24)	0.018	0.013	4.56	21.35	22.00	0.021
Right Cheek	23095/707.5	10M QPSK(1,24)	0.028	0.025	4.79	21.35	22.00	0.033
Right Tilt 15 Degree	23095/707.5	10M QPSK(1,24)	0.014	0.011	2.15	21.35	22.00	0.016

50%RB								
Left Cheek	23095/707.5	1.4M QPSK(3,2)	0.027	0.024	-0.18	21.23	22.00	0.032
Left Tilt 15 Degree	23095/707.5	1.4M QPSK(3,2)	0.017	0.012	1.96	21.23	22.00	0.020
Right Cheek	23095/707.5	1.4M QPSK(3,2)	0.025	0.023	-1.81	21.23	22.00	0.030
Right Tilt 15 Degree	23095/707.5	1.4M QPSK(3,2)	0.013	0.010	1.00	21.23	22.00	0.016

NOTE: Head SAR test results of LTE Band 12

Test Position of Body-Worn with 10mm	Test channel /Freq.	Test Mode	SAR Value (W/kg)		Power Drift (±5%)	Conducted power (dBm)	Tune-up power (dBm)	Scaled SAR 1g (W/Kg)
			1g	10g				
1RB								
Front Side	23095/707.5	10M QPSK(1,24)	0.048	0.038	-0.33	21.35	22.00	0.056
Back Side	23095/707.5	10M QPSK(1,24)	0.060	0.048	-2.49	21.35	22.00	0.070
50%RB								
Front Side	23095/707.5	1.4M QPSK(3,2)	0.043	0.034	-3.18	21.23	22.00	0.051
Back Side	23095/707.5	1.4M QPSK(3,2)	0.057	0.044	0.17	21.23	22.00	0.068

NOTE: Body-Worn SAR test results of LTE Band 12

Test Position of Hotspot with 10mm	Test channel /Freq.	Test Mode	SAR Value (W/kg)		Power Drift (±5%)	Conducted power (dBm)	Tune-up power (dBm)	Scaled SAR 1g (W/Kg)
			1g	10g				
1RB								
Front Side	23095/707.5	10M QPSK(1,24)	0.048	0.038	-0.33	21.35	22.00	0.056
Back Side	23095/707.5	10M QPSK(1,24)	0.060	0.048	-2.49	21.35	22.00	0.070
Left Side	23095/707.5	10M QPSK(1,24)	0.045	0.040	-2.84	21.35	22.00	0.052
Right Side	23095/707.5	10M QPSK(1,24)	0.029	0.023	0.93	21.35	22.00	0.034
Bottom Side	23095/707.5	10M QPSK(1,24)	0.023	0.015	-3.97	21.35	22.00	0.027

50%RB								
Front Side	23095/707.5	1.4M QPSK(3,2)	0.043	0.034	-3.18	21.23	22.00	0.051
Back Side	23095/707.5	1.4M QPSK(3,2)	0.057	0.044	0.17	21.23	22.00	0.068
Left Side	23095/707.5	1.4M QPSK(3,2)	0.040	0.034	-2.34	21.23	22.00	0.048
Right Side	23095/707.5	1.4M QPSK(3,2)	0.027	0.021	1.59	21.23	22.00	0.032
Bottom Side	23095/707.5	1.4M QPSK(3,2)	0.022	0.014	-2.94	21.23	22.00	0.026

NOTE: Hotspot SAR test results of LTE Band 12

10.1.11. SAR measurement Result of LTE Band 17

Test Position of Head	Test channel /Freq.	Test Mode	SAR Value (W/kg)		Power Drift (±5%)	Conducted power (dBm)	Tune-up power (dBm)	Scaled SAR 1g (W/Kg)
			1g	10g				
1RB								
Left Cheek	23790/710	10M QPSK(1,24)	0.042	0.027	2.25	23.89	25.00	0.054
Left Tilt 15 Degree	23790/710	10M QPSK(1,24)	0.023	0.010	3.05	23.89	25.00	0.030
Right Cheek	23790/710	10M QPSK(1,24)	0.037	0.024	2.10	23.89	25.00	0.048
Right Tilt 15 Degree	23790/710	10M QPSK(1,24)	0.019	0.016	4.66	23.89	25.00	0.025
50%RB								
Left Cheek	23790/710	10M QPSK(25,0)	0.040	0.025	1.04	23.05	24.00	0.050
Left Tilt 15 Degree	23790/710	10M QPSK(25,0)	0.021	0.009	-3.25	23.05	24.00	0.026
Right Cheek	23790/710	10M QPSK(25,0)	0.032	0.021	1.70	23.05	24.00	0.040
Right Tilt 15 Degree	23790/710	10M QPSK(25,0)	0.017	0.014	3.10	23.05	24.00	0.021

NOTE: Head SAR test results of LTE Band 17

Test Position of Body-Worn with 10mm	Test channel /Freq.	Test Mode	SAR Value (W/kg)		Power Drift (±5%)	Conducted power (dBm)	Tune-up power (dBm)	Scaled SAR 1g (W/Kg)
			1g	10g				
1RB								
Front Side	23790/710	10M QPSK(1,24)	0.044	0.035	-2.38	23.89	25.00	0.057
Back Side	23790/710	10M QPSK(1,24)	0.055	0.044	-1.20	23.89	25.00	0.071
50%RB								
Front Side	23790/710	10M QPSK(25,0)	0.040	0.032	-3.06	23.05	24.00	0.050
Back Side	23790/710	10M QPSK(25,0)	0.049	0.041	-2.50	23.05	24.00	0.061

NOTE: Body-Worn SAR test results of LTE Band 17

Test Position of Hotspot with 10mm	Test channel /Freq.	Test Mode	SAR Value (W/kg)		Power Drift (±5%)	Conducted power (dBm)	Tune-up power (dBm)	Scaled SAR 1g (W/Kg)
			1g	10g				
1RB								
Front Side	23790/710	10M QPSK(1,24)	0.044	0.035	-2.38	23.89	25.00	0.057
Back Side	23790/710	10M QPSK(1,24)	0.055	0.044	-1.20	23.89	25.00	0.071
Left Side	23790/710	10M QPSK(1,24)	0.041	0.029	2.69	23.89	25.00	0.053
Right Side	23790/710	10M QPSK(1,24)	0.027	0.022	2.06	23.89	25.00	0.035
Bottom Side	23790/710	10M QPSK(1,24)	0.020	0.012	4.74	23.89	25.00	0.026
50%RB								
Front Side	23790/710	10M QPSK(25,0)	0.040	0.032	-3.06	23.05	24.00	0.050
Back Side	23790/710	10M QPSK(25,0)	0.049	0.041	-2.50	23.05	24.00	0.061
Left Side	23790/710	10M QPSK(25,0)	0.036	0.025	0.17	23.05	24.00	0.045
Right Side	23790/710	10M QPSK(25,0)	0.025	0.019	-3.64	23.05	24.00	0.031
Bottom Side	23790/710	10M QPSK(25,0)	0.018	0.011	1.24	23.05	24.00	0.022

NOTE: Hotspot SAR test results of LTE Band 17

10.1.12. SAR measurement Result of WLAN 2.4G

Test Position of Head	Test channel /Freq.	Test Mode	SAR Value (W/kg)		Power Drift (±5%)	Conducted power (dBm)	Tune-up power (dBm)	Scaled SAR 1g (W/Kg)
			1g	10g				
Left Cheek	6/2437	802.11 b	0.029	0.024	-2.29	11.28	12.00	0.034
Left Tilt 15 Degree	6/2437	802.11 b	0.015	0.013	0.29	11.28	12.00	0.018
Right Cheek	6/2437	802.11 b	0.026	0.020	-4.45	11.28	12.00	0.031
Right Tilt 15 Degree	6/2437	802.11 b	0.012	0.012	3.25	11.28	12.00	0.014

NOTE: Head SAR test results of WLAN 2.4G

Test Position of Body-Worn with 10mm	Test channel /Freq.	Test Mode	SAR Value (W/kg)		Power Drift (±5%)	Conducted power (dBm)	Tune-up power (dBm)	Scaled SAR 1g (W/Kg)
			1g	10g				
Front Side	6/2437	802.11 b	0.206	0.111	-0.49	11.28	12.00	0.243
Back Side	6/2437	802.11 b	0.334	0.172	-4.01	11.28	12.00	0.394

NOTE: Body-Worn SAR test results of WLAN 2.4G

Test Position of Hotspot with 10mm	Test channel /Freq.	Test Mode	SAR Value (W/kg)		Power Drift (±5%)	Conducted power (dBm)	Tune-up power (dBm)	Scaled SAR 1g (W/Kg)
			1g	10g				
Front Side	6/2437	802.11 b	0.206	0.111	-0.49	11.28	12.00	0.243
Back Side	6/2437	802.11 b	0.334	0.172	-4.01	11.28	12.00	0.394
Right Side	6/2437	802.11 b	0.074	0.040	3.70	11.28	12.00	0.087
Top Side	6/2437	802.11 b	0.102	0.054	-4.46	11.28	12.00	0.120

NOTE: Hotspot SAR test results of WLAN 2.4G

10.2. SAR Summation Scenario

Per KDB 447498 D01, simultaneous transmission SAR is compliant if,

- Scalar SAR summation < 1.6W/kg.
- $SPLSR = (SAR_1 + SAR_2)^{1.5} / (\text{min. separation distance, mm})$, and the peak separation distance is determined from the square root of $[(x_1-x_2)^2 + (y_1-y_2)^2 + (z_1-z_2)^2]$, where (x_1, y_1, z_1) and (x_2, y_2, z_2) are the coordinates of the extrapolated peak SAR locations in the zoom scan. If $SPLSR \leq 0.04$, simultaneously transmission SAR measurement is not necessary.

Test Position	Scaled SAR _{MAX}	∑ 1-g SAR	SPLSR	Remark
---------------	---------------------------	-----------	-------	--------

		GSM 850	WLAN 2.4G	(W/Kg)		
Head	Left Cheek	0.137	0.034	0.171	N/A	N/A
	Left Tilt 15 Degree	0.073	0.018	0.091	N/A	N/A
	Right Cheek	0.122	0.031	0.153	N/A	N/A
	Right Tilt 15 Degree	0.065	0.014	0.079	N/A	N/A
Body-Worn	Front Side	0.200	0.243	0.443	N/A	N/A
	Back Side	0.263	0.394	0.657	N/A	N/A
Hotspot	Front Side	0.200	0.243	0.443	N/A	N/A
	Back Side	0.263	0.394	0.657	N/A	N/A
	Left Side	0.211	N/A	0.211	N/A	N/A
	Right Side	0.130	0.087	0.217	N/A	N/A
	Top Side	N/A	0.120	0.120	N/A	N/A
	Bottom Side	0.094	N/A	0.094	N/A	N/A

NOTE: 1-g SAR Simultaneous Tx Combination of GSM850 and WLAN 2.4G.

Test Position		Scaled SAR _{MAX}		Σ 1-g SAR (W/Kg)	SPLSR	Remark
		GSM 1900	WLAN 2.4G			
Head	Left Cheek	0.066	0.034	0.100	N/A	N/A
	Left Tilt 15 Degree	0.039	0.018	0.057	N/A	N/A
	Right Cheek	0.058	0.031	0.089	N/A	N/A
	Right Tilt 15 Degree	0.026	0.014	0.040	N/A	N/A
Body-Worn	Front Side	0.290	0.243	0.533	N/A	N/A
	Back Side	0.370	0.394	0.764	N/A	N/A
Hotspot	Front Side	0.290	0.243	0.533	N/A	N/A
	Back Side	0.370	0.394	0.764	N/A	N/A
	Left Side	0.281	N/A	0.281	N/A	N/A
	Right Side	0.108	0.087	0.195	N/A	N/A
	Top Side	N/A	0.120	0.120	N/A	N/A
	Bottom Side	0.139	N/A	0.139	N/A	N/A

NOTE: 1-g SAR Simultaneous Tx Combination of GSM1900 and WLAN 2.4G.

Test Position		Scaled SAR _{MAX}		Σ 1-g SAR (W/Kg)	SPLSR	Remark
		WCDMA Band 2	WLAN 2.4G			
Head	Left Cheek	0.081	0.034	0.115	N/A	N/A
	Left Tilt 15 Degree	0.042	0.018	0.060	N/A	N/A
	Right Cheek	0.074	0.031	0.105	N/A	N/A
	Right Tilt 15 Degree	0.035	0.014	0.049	N/A	N/A
Body-Worn	Front Side	0.396	0.243	0.639	N/A	N/A

	Back Side	0.523	0.394	0.917	N/A	N/A
Hotspot	Front Side	0.396	0.243	0.639	N/A	N/A
	Back Side	0.523	0.394	0.917	N/A	N/A
	Left Side	0.381	N/A	0.381	N/A	N/A
	Right Side	0.233	0.087	0.320	N/A	N/A
	Top Side	N/A	0.120	0.120	N/A	N/A
	Bottom Side	0.192	N/A	0.192	N/A	N/A

NOTE: 1-g SAR Simultaneous Tx Combination of WCDMA Band 2 and WLAN 2.4G.

Test Position		Scaled SAR _{MAX}		Σ 1-g SAR (W/Kg)	SPLSR	Remark
		WCDMA Band 4	WLAN 2.4G			
Head	Left Cheek	0.230	0.034	0.264	N/A	N/A
	Left Tilt 15 Degree	0.139	0.018	0.157	N/A	N/A
	Right Cheek	0.217	0.031	0.248	N/A	N/A
	Right Tilt 15 Degree	0.123	0.014	0.137	N/A	N/A
Body-Worn	Front Side	0.522	0.243	0.765	N/A	N/A
	Back Side	0.598	0.394	0.992	N/A	N/A
Hotspot	Front Side	0.522	0.243	0.765	N/A	N/A
	Back Side	0.598	0.394	0.992	N/A	N/A
	Left Side	0.285	N/A	0.285	N/A	N/A
	Right Side	0.146	0.087	0.233	N/A	N/A
	Top Side	N/A	0.120	0.120	N/A	N/A
	Bottom Side	0.577	N/A	0.577	N/A	N/A

NOTE: 1-g SAR Simultaneous Tx Combination of WCDMA Band 4 and WLAN 2.4G.

Test Position		Scaled SAR _{MAX}		Σ 1-g SAR (W/Kg)	SPLSR	Remark
		WCDMA Band 5	WLAN 2.4G			
Head	Left Cheek	0.070	0.034	0.104	N/A	N/A
	Left Tilt 15 Degree	0.039	0.018	0.057	N/A	N/A
	Right Cheek	0.060	0.031	0.091	N/A	N/A
	Right Tilt 15 Degree	0.029	0.014	0.043	N/A	N/A
Body-Worn	Front Side	0.093	0.243	0.336	N/A	N/A
	Back Side	0.110	0.394	0.504	N/A	N/A
Hotspot	Front Side	0.093	0.243	0.336	N/A	N/A
	Back Side	0.110	0.394	0.504	N/A	N/A
	Left Side	0.080	N/A	0.080	N/A	N/A
	Right Side	0.048	0.087	0.135	N/A	N/A
	Top Side	N/A	0.120	0.120	N/A	N/A

	Bottom Side	0.043	N/A	0.043	N/A	N/A
--	-------------	-------	-----	-------	-----	-----

NOTE: 1-g SAR Simultaneous Tx Combination of WCDMA Band 5 and WLAN 2.4G.

Test Position		Scaled SAR _{MAX}		Σ 1-g SAR (W/Kg)	SPLSR	Remark
		LTE Band 2	WLAN 2.4G			
Head	Left Cheek	0.073	0.034	0.107	N/A	N/A
	Left Tilt 15 Degree	0.040	0.018	0.058	N/A	N/A
	Right Cheek	0.066	0.031	0.097	N/A	N/A
	Right Tilt 15 Degree	0.034	0.014	0.048	N/A	N/A
Body-Worn	Front Side	0.366	0.243	0.609	N/A	N/A
	Back Side	0.434	0.394	0.828	N/A	N/A
Hotspot	Front Side	0.366	0.243	0.609	N/A	N/A
	Back Side	0.434	0.394	0.828	N/A	N/A
	Left Side	0.346	N/A	0.346	N/A	N/A
	Right Side	0.204	0.087	0.291	N/A	N/A
	Top Side	N/A	0.120	0.120	N/A	N/A
	Bottom Side	0.160	N/A	0.160	N/A	N/A

NOTE: 1-g SAR Simultaneous Tx Combination of LTE Band 2 and WLAN 2.4G.

Test Position		Scaled SAR _{MAX}		Σ 1-g SAR (W/Kg)	SPLSR	Remark
		LTE Band 4	WLAN 2.4G			
Head	Left Cheek	0.102	0.034	0.136	N/A	N/A
	Left Tilt 15 Degree	0.059	0.018	0.077	N/A	N/A
	Right Cheek	0.093	0.031	0.124	N/A	N/A
	Right Tilt 15 Degree	0.049	0.014	0.063	N/A	N/A
Body-Worn	Front Side	0.286	0.243	0.529	N/A	N/A
	Back Side	0.365	0.394	0.759	N/A	N/A
Hotspot	Front Side	0.286	0.243	0.529	N/A	N/A
	Back Side	0.365	0.394	0.759	N/A	N/A
	Left Side	0.291	N/A	0.291	N/A	N/A
	Right Side	0.162	0.087	0.249	N/A	N/A
	Top Side	N/A	0.120	0.120	N/A	N/A
	Bottom Side	0.140	N/A	0.140	N/A	N/A

NOTE: 1-g SAR Simultaneous Tx Combination of LTE Band 4 and WLAN 2.4G.

Test Position		Scaled SAR _{MAX}		Σ 1-g SAR (W/Kg)	SPLSR	Remark
		LTE Band 5	WLAN 2.4G			
Head	Left Cheek	0.071	0.034	0.105	N/A	N/A
	Left Tilt 15 Degree	0.041	0.018	0.059	N/A	N/A

	Right Cheek	0.067	0.031	0.098	N/A	N/A
	Right Tilt 15 Degree	0.032	0.014	0.046	N/A	N/A
Body-Worn	Front Side	0.119	0.243	0.362	N/A	N/A
	Back Side	0.143	0.394	0.537	N/A	N/A
Hotspot	Front Side	0.119	0.243	0.362	N/A	N/A
	Back Side	0.143	0.394	0.537	N/A	N/A
	Left Side	0.106	N/A	0.106	N/A	N/A
	Right Side	0.068	0.087	0.155	N/A	N/A
	Top Side	N/A	0.120	0.120	N/A	N/A
	Bottom Side	0.050	N/A	0.050	N/A	N/A

NOTE: 1-g SAR Simultaneous Tx Combination of LTE Band 5 and WLAN 2.4G.

Test Position		Scaled SAR _{MAX}		Σ 1-g SAR (W/Kg)	SPLSR	Remark
		LTE Band 7	WLAN 2.4G			
Head	Left Cheek	0.444	0.034	0.478	N/A	N/A
	Left Tilt 15 Degree	0.260	0.018	0.278	N/A	N/A
	Right Cheek	0.389	0.031	0.420	N/A	N/A
	Right Tilt 15 Degree	0.193	0.014	0.207	N/A	N/A
Body-Worn	Front Side	0.632	0.243	0.875	N/A	N/A
	Back Side	1.046	0.394	1.440	N/A	N/A
Hotspot	Front Side	0.632	0.243	0.875	N/A	N/A
	Back Side	1.046	0.394	1.440	N/A	N/A
	Left Side	0.479	N/A	0.479	N/A	N/A
	Right Side	0.481	0.087	0.568	N/A	N/A
	Top Side	N/A	0.120	0.120	N/A	N/A
	Bottom Side	0.446	N/A	0.446	N/A	N/A

NOTE: 1-g SAR Simultaneous Tx Combination of LTE Band 7 and WLAN 2.4G.

Test Position		Scaled SAR _{MAX}		Σ 1-g SAR (W/Kg)	SPLSR	Remark
		LTE Band 12	WLAN 2.4G			
Head	Left Cheek	0.036	0.034	0.070	N/A	N/A
	Left Tilt 15 Degree	0.021	0.018	0.039	N/A	N/A
	Right Cheek	0.033	0.031	0.064	N/A	N/A
	Right Tilt 15 Degree	0.016	0.014	0.030	N/A	N/A
Body-Worn	Front Side	0.056	0.243	0.299	N/A	N/A
	Back Side	0.070	0.394	0.464	N/A	N/A
Hotspot	Front Side	0.056	0.243	0.299	N/A	N/A
	Back Side	0.070	0.394	0.464	N/A	N/A

	Left Side	0.052	N/A	0.052	N/A	N/A
	Right Side	0.034	0.087	0.121	N/A	N/A
	Top Side	N/A	0.120	0.120	N/A	N/A
	Bottom Side	0.027	N/A	0.027	N/A	N/A

NOTE: 1-g SAR Simultaneous Tx Combination of LTE Band 12 and WLAN 2.4G.

Test Position		Scaled SAR _{MAX}		Σ 1-g SAR (W/Kg)	SPLSR	Remark
		LTE Band 17	WLAN 2.4G			
Head	Left Cheek	0.054	0.034	0.088	N/A	N/A
	Left Tilt 15 Degree	0.030	0.018	0.048	N/A	N/A
	Right Cheek	0.048	0.031	0.079	N/A	N/A
	Right Tilt 15 Degree	0.025	0.014	0.039	N/A	N/A
Body-Worn	Front Side	0.057	0.243	0.300	N/A	N/A
	Back Side	0.071	0.394	0.465	N/A	N/A
Hotspot	Front Side	0.057	0.243	0.300	N/A	N/A
	Back Side	0.071	0.394	0.465	N/A	N/A
	Left Side	0.053	N/A	0.053	N/A	N/A
	Right Side	0.035	0.087	0.122	N/A	N/A
	Top Side	N/A	0.120	0.120	N/A	N/A
	Bottom Side	0.026	N/A	0.026	N/A	N/A

NOTE: 1-g SAR Simultaneous Tx Combination of LTE Band 17 and WLAN 2.4G.

Test Position		Scaled SAR _{MAX}		Σ 1-g SAR (W/Kg)	SPLSR	Remark
		GSM 850	Bluetooth			
Head	Left Cheek	0.137	0.167	0.304	N/A	N/A
	Left Tilt 15 Degree	0.073	0.167	0.240	N/A	N/A
	Right Cheek	0.122	0.167	0.289	N/A	N/A
	Right Tilt 15 Degree	0.065	0.167	0.232	N/A	N/A
Body-Worn	Front Side	0.200	0.084	0.284	N/A	N/A
	Back Side	0.263	0.084	0.347	N/A	N/A
Hotspot	Front Side	0.200	0.084	0.284	N/A	N/A
	Back Side	0.263	0.084	0.347	N/A	N/A
	Left Side	0.211	N/A	0.211	N/A	N/A
	Right Side	0.130	0.084	0.214	N/A	N/A
	Top Side	N/A	0.084	0.084	N/A	N/A
	Bottom Side	0.094	N/A	0.094	N/A	N/A

NOTE: 1-g SAR Simultaneous Tx Combination of GSM850 and Bluetooth.

Test Position		Scaled SAR _{MAX}		Σ 1-g SAR (W/Kg)	SPLSR	Remark
		GSM 1900	Bluetooth			
Head	Left Cheek	0.066	0.167	0.233	N/A	N/A
	Left Tilt 15 Degree	0.039	0.167	0.206	N/A	N/A
	Right Cheek	0.058	0.167	0.225	N/A	N/A
	Right Tilt 15 Degree	0.026	0.167	0.193	N/A	N/A
Body-Worn	Front Side	0.290	0.084	0.374	N/A	N/A
	Back Side	0.370	0.084	0.454	N/A	N/A
Hotspot	Front Side	0.290	0.084	0.374	N/A	N/A
	Back Side	0.370	0.084	0.454	N/A	N/A
	Left Side	0.281	N/A	0.281	N/A	N/A
	Right Side	0.108	0.084	0.192	N/A	N/A
	Top Side	N/A	0.084	0.084	N/A	N/A
	Bottom Side	0.139	N/A	0.139	N/A	N/A

NOTE: 1-g SAR Simultaneous Tx Combination of GSM1900 and Bluetooth.

Test Position		Scaled SAR _{MAX}		Σ 1-g SAR (W/Kg)	SPLSR	Remark
		WCDMA Band 2	Bluetooth			
Head	Left Cheek	0.081	0.167	0.248	N/A	N/A
	Left Tilt 15 Degree	0.042	0.167	0.209	N/A	N/A
	Right Cheek	0.074	0.167	0.241	N/A	N/A
	Right Tilt 15 Degree	0.035	0.167	0.202	N/A	N/A
Body-Worn	Front Side	0.396	0.084	0.480	N/A	N/A
	Back Side	0.523	0.084	0.607	N/A	N/A
Hotspot	Front Side	0.396	0.084	0.480	N/A	N/A
	Back Side	0.523	0.084	0.607	N/A	N/A
	Left Side	0.381	N/A	0.381	N/A	N/A
	Right Side	0.233	0.084	0.317	N/A	N/A
	Top Side	N/A	0.084	0.084	N/A	N/A
	Bottom Side	0.192	N/A	0.192	N/A	N/A

NOTE: 1-g SAR Simultaneous Tx Combination of WCDMA Band 2 and Bluetooth.

Test Position		Scaled SAR _{MAX}		Σ 1-g SAR (W/Kg)	SPLSR	Remark
		WCDMA Band 4	Bluetooth			
Head	Left Cheek	0.230	0.167	0.397	N/A	N/A
	Left Tilt 15 Degree	0.139	0.167	0.306	N/A	N/A
	Right Cheek	0.217	0.167	0.384	N/A	N/A

	Right Tilt 15 Degree	0.123	0.167	0.290	N/A	N/A
Body-Worn	Front Side	0.522	0.084	0.606	N/A	N/A
	Back Side	0.598	0.084	0.682	N/A	N/A
Hotspot	Front Side	0.522	0.084	0.606	N/A	N/A
	Back Side	0.598	0.084	0.682	N/A	N/A
	Left Side	0.285	N/A	0.285	N/A	N/A
	Right Side	0.146	0.084	0.230	N/A	N/A
	Top Side	N/A	0.084	0.084	N/A	N/A
	Bottom Side	0.577	N/A	0.577	N/A	N/A

NOTE: 1-g SAR Simultaneous Tx Combination of WCDMA Band 4 and Bluetooth.

Test Position		Scaled SAR _{MAX}		Σ 1-g SAR (W/Kg)	SPLSR	Remark
		WCDMA Band 5	Bluetooth			
Head	Left Cheek	0.070	0.167	0.237	N/A	N/A
	Left Tilt 15 Degree	0.039	0.167	0.206	N/A	N/A
	Right Cheek	0.060	0.167	0.227	N/A	N/A
	Right Tilt 15 Degree	0.029	0.167	0.196	N/A	N/A
Body-Worn	Front Side	0.093	0.084	0.177	N/A	N/A
	Back Side	0.110	0.084	0.194	N/A	N/A
Hotspot	Front Side	0.093	0.084	0.177	N/A	N/A
	Back Side	0.110	0.084	0.194	N/A	N/A
	Left Side	0.080	N/A	0.080	N/A	N/A
	Right Side	0.048	0.084	0.132	N/A	N/A
	Top Side	N/A	0.084	0.084	N/A	N/A
	Bottom Side	0.043	N/A	0.043	N/A	N/A

NOTE: 1-g SAR Simultaneous Tx Combination of WCDMA Band 5 and Bluetooth.

Test Position		Scaled SAR _{MAX}		Σ 1-g SAR (W/Kg)	SPLSR	Remark
		LTE Band 2	Bluetooth			
Head	Left Cheek	0.073	0.167	0.240	N/A	N/A
	Left Tilt 15 Degree	0.040	0.167	0.207	N/A	N/A
	Right Cheek	0.066	0.167	0.233	N/A	N/A
	Right Tilt 15 Degree	0.034	0.167	0.201	N/A	N/A
Body-Worn	Front Side	0.366	0.084	0.450	N/A	N/A
	Back Side	0.434	0.084	0.518	N/A	N/A
Hotspot	Front Side	0.366	0.084	0.450	N/A	N/A
	Back Side	0.434	0.084	0.518	N/A	N/A
	Left Side	0.346	N/A	0.346	N/A	N/A

	Right Side	0.204	0.084	0.288	N/A	N/A
	Top Side	N/A	0.084	0.084	N/A	N/A
	Bottom Side	0.160	N/A	0.160	N/A	N/A

NOTE: 1-g SAR Simultaneous Tx Combination of LTE Band 2 and Bluetooth.

Test Position		Scaled SAR _{MAX}		Σ 1-g SAR (W/Kg)	SPLSR	Remark
		LTE Band 4	Bluetooth			
Head	Left Cheek	0.102	0.167	0.269	N/A	N/A
	Left Tilt 15 Degree	0.059	0.167	0.226	N/A	N/A
	Right Cheek	0.093	0.167	0.260	N/A	N/A
	Right Tilt 15 Degree	0.049	0.167	0.216	N/A	N/A
Body-Worn	Front Side	0.286	0.084	0.370	N/A	N/A
	Back Side	0.365	0.084	0.449	N/A	N/A
Hotspot	Front Side	0.286	0.084	0.370	N/A	N/A
	Back Side	0.365	0.084	0.449	N/A	N/A
	Left Side	0.291	N/A	0.291	N/A	N/A
	Right Side	0.162	0.084	0.246	N/A	N/A
	Top Side	N/A	0.084	0.084	N/A	N/A
	Bottom Side	0.140	N/A	0.140	N/A	N/A

NOTE: 1-g SAR Simultaneous Tx Combination of LTE Band 4 and Bluetooth.

Test Position		Scaled SAR _{MAX}		Σ 1-g SAR (W/Kg)	SPLSR	Remark
		LTE Band 5	Bluetooth			
Head	Left Cheek	0.071	0.167	0.238	N/A	N/A
	Left Tilt 15 Degree	0.041	0.167	0.208	N/A	N/A
	Right Cheek	0.067	0.167	0.234	N/A	N/A
	Right Tilt 15 Degree	0.032	0.167	0.199	N/A	N/A
Body-Worn	Front Side	0.119	0.084	0.203	N/A	N/A
	Back Side	0.143	0.084	0.227	N/A	N/A
Hotspot	Front Side	0.119	0.084	0.203	N/A	N/A
	Back Side	0.143	0.084	0.227	N/A	N/A
	Left Side	0.106	N/A	0.106	N/A	N/A
	Right Side	0.068	0.084	0.152	N/A	N/A
	Top Side	N/A	0.084	0.084	N/A	N/A
	Bottom Side	0.050	N/A	0.050	N/A	N/A

NOTE: 1-g SAR Simultaneous Tx Combination of LTE Band 5 and Bluetooth.

Test Position	Scaled SAR _{MAX}		Σ 1-g SAR	SPLSR	Remark
---------------	---------------------------	--	-----------	-------	--------

		LTE Band 7	Bluetooth	(W/Kg)		
Head	Left Cheek	0.444	0.167	0.611	N/A	N/A
	Left Tilt 15 Degree	0.260	0.167	0.427	N/A	N/A
	Right Cheek	0.389	0.167	0.556	N/A	N/A
	Right Tilt 15 Degree	0.193	0.167	0.360	N/A	N/A
Body-Worn	Front Side	0.632	0.084	0.716	N/A	N/A
	Back Side	1.046	0.084	1.130	N/A	N/A
Hotspot	Front Side	0.632	0.084	0.716	N/A	N/A
	Back Side	1.046	0.084	1.130	N/A	N/A
	Left Side	0.479	N/A	0.479	N/A	N/A
	Right Side	0.481	0.084	0.565	N/A	N/A
	Top Side	N/A	0.084	0.084	N/A	N/A
	Bottom Side	0.446	N/A	0.446	N/A	N/A

NOTE: 1-g SAR Simultaneous Tx Combination of LTE Band 7 and Bluetooth.

Test Position		Scaled SAR _{MAX}		Σ 1-g SAR (W/Kg)	SPLSR	Remark
		LTE Band 12	Bluetooth			
Head	Left Cheek	0.036	0.167	0.203	N/A	N/A
	Left Tilt 15 Degree	0.021	0.167	0.188	N/A	N/A
	Right Cheek	0.033	0.167	0.200	N/A	N/A
	Right Tilt 15 Degree	0.016	0.167	0.183	N/A	N/A
Body-Worn	Front Side	0.056	0.084	0.140	N/A	N/A
	Back Side	0.070	0.084	0.154	N/A	N/A
Hotspot	Front Side	0.056	0.084	0.140	N/A	N/A
	Back Side	0.070	0.084	0.154	N/A	N/A
	Left Side	0.052	N/A	0.052	N/A	N/A
	Right Side	0.034	0.084	0.118	N/A	N/A
	Top Side	N/A	0.084	0.084	N/A	N/A
	Bottom Side	0.027	N/A	0.027	N/A	N/A

NOTE: 1-g SAR Simultaneous Tx Combination of LTE Band 12 and Bluetooth.

Test Position		Scaled SAR _{MAX}		Σ 1-g SAR (W/Kg)	SPLSR	Remark
		LTE Band 17	Bluetooth			
Head	Left Cheek	0.054	0.167	0.221	N/A	N/A
	Left Tilt 15 Degree	0.030	0.167	0.197	N/A	N/A
	Right Cheek	0.048	0.167	0.215	N/A	N/A
	Right Tilt 15	0.025	0.167	0.192	N/A	N/A

	Degree					
Body-Worn	Front Side	0.057	0.084	0.141	N/A	N/A
	Back Side	0.071	0.084	0.155	N/A	N/A
Hotspot	Front Side	0.057	0.084	0.141	N/A	N/A
	Back Side	0.071	0.084	0.155	N/A	N/A
	Left Side	0.053	N/A	0.053	N/A	N/A
	Right Side	0.035	0.084	0.119	N/A	N/A
	Top Side	N/A	0.084	0.084	N/A	N/A
	Bottom Side	0.026	N/A	0.026	N/A	N/A

NOTE: 1-g SAR Simultaneous Tx Combination of LTE Band 17 and Bluetooth.

11. Appendix A. Photo documentation

Refer to appendix Test Setup photo---SAR

12. Appendix B. System Check Plots

Table of contents
MEASUREMENT 1 System Performance Check - SID750 - Head
MEASUREMENT 2 System Performance Check - SID750 - Body
MEASUREMENT 3 System Performance Check - SID835 - Head
MEASUREMENT 4 System Performance Check - SID835 - Body
MEASUREMENT 5 System Performance Check - SID1800 - Head
MEASUREMENT 6 System Performance Check - SID1800 - Body
MEASUREMENT 7 System Performance Check - SID1900 - Head
MEASUREMENT 8 System Performance Check - SID1900 - Body
MEASUREMENT 9 System Performance Check - SID2450 - Head
MEASUREMENT 10 System Performance Check - SID2450 - Body
MEASUREMENT 11 System Performance Check - SID2600 - Head
MEASUREMENT 12 System Performance Check - SID2600 - Body

MEASUREMENT 1

A. Experimental conditions.

Area Scan	<u>dx=15mm dy=15mm, h= 5.00 mm</u>
ZoomScan	<u>5x5x7, dx=8mm dy=8mm dz=5mm</u>
Phantom	<u>Validation plane</u>
Device Position	<u>Dipole</u>
Band	<u>CW750</u>
Channels	<u>Middle</u>
Signal	<u>CW (Crest factor: 1.0)</u>

B. SAR Measurement Results

Frequency (MHz)	750.000000
Relative permittivity (real part)	41.573162
Relative permittivity (imaginary part)	22.091263
Conductivity (S/m)	0.922262
Variation (%)	-1.810000

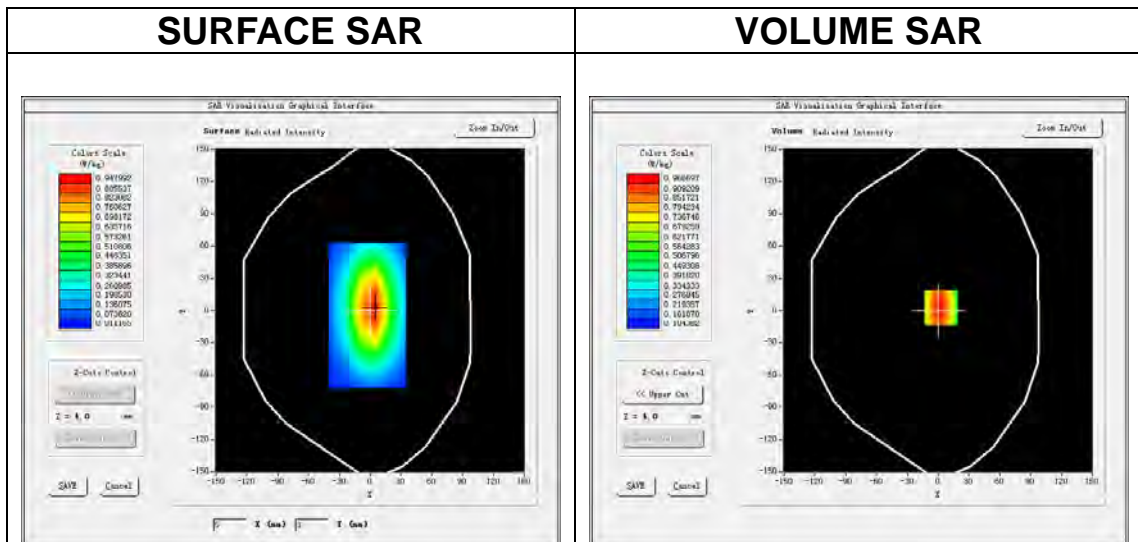

Maximum location: X=3.00, Y=3.00

SAR Peak: 1.30 W/kg

SAR 10g (W/Kg)	0.556218
SAR 1g (W/Kg)	0.842362

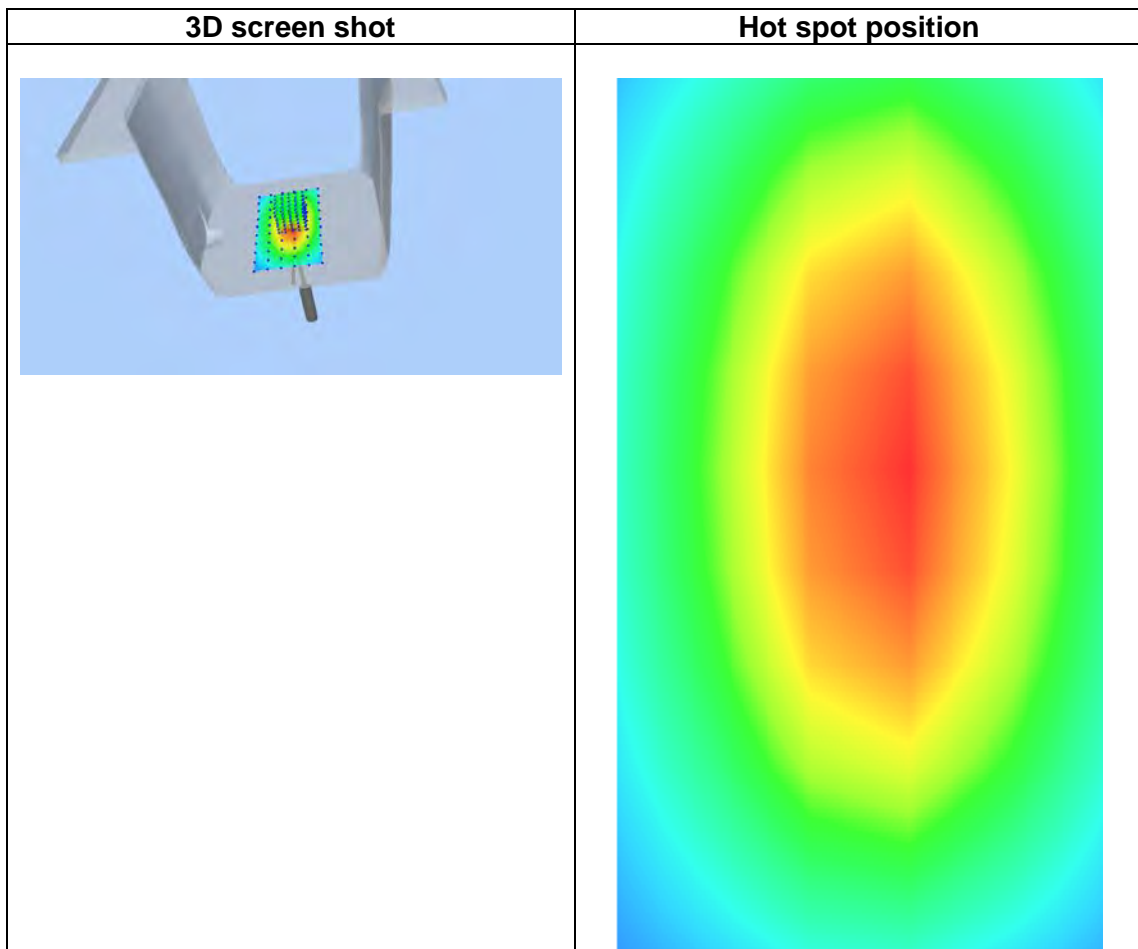
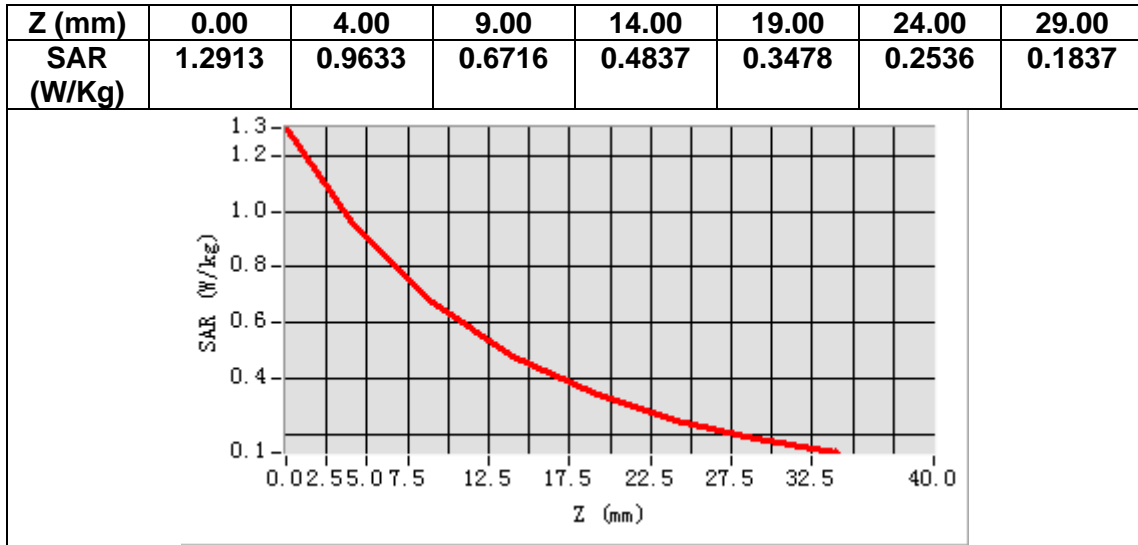

MEASUREMENT 2

A. Experimental conditions.

Area Scan	<u>dx=15mm dy=15mm, h= 5.00 mm</u>
ZoomScan	<u>5x5x7,dx=8mm dy=8mm dz=5mm</u>
Phantom	<u>Validation plane</u>
Device Position	<u>Dipole</u>
Band	<u>CW750</u>
Channels	<u>Middle</u>
Signal	<u>CW (Crest factor: 1.0)</u>

B. SAR Measurement Results

Frequency (MHz)	750.000000
Relative permittivity (real part)	55.470248
Relative permittivity (imaginary part)	23.173842
Conductivity (S/m)	0.970318
Variation (%)	-0.490000

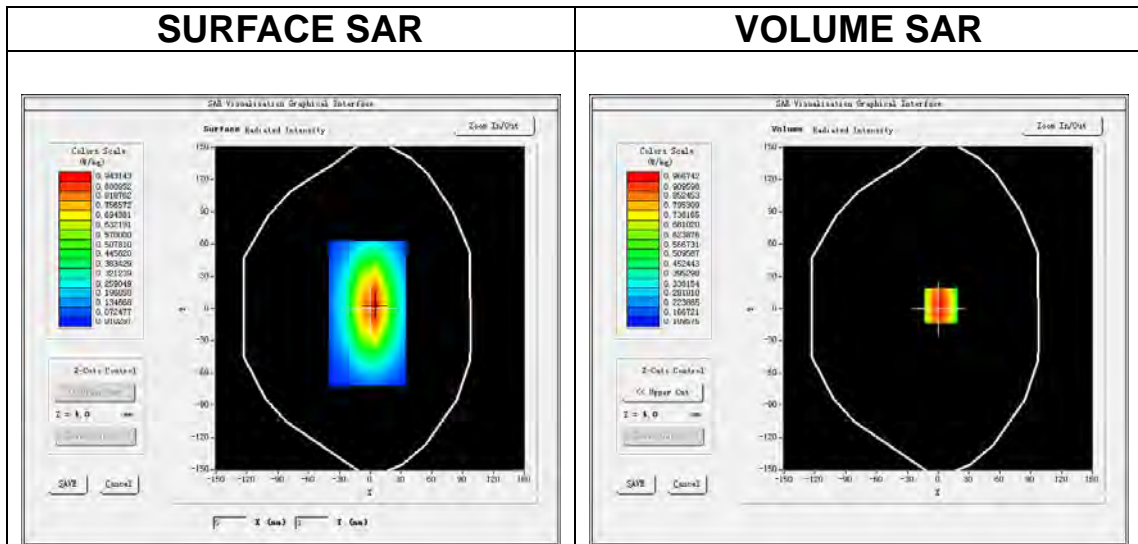

Maximum location: X=3.00, Y=3.00

SAR Peak: 1.30 W/kg

SAR 10g (W/Kg)	0.590281
SAR 1g (W/Kg)	0.884263

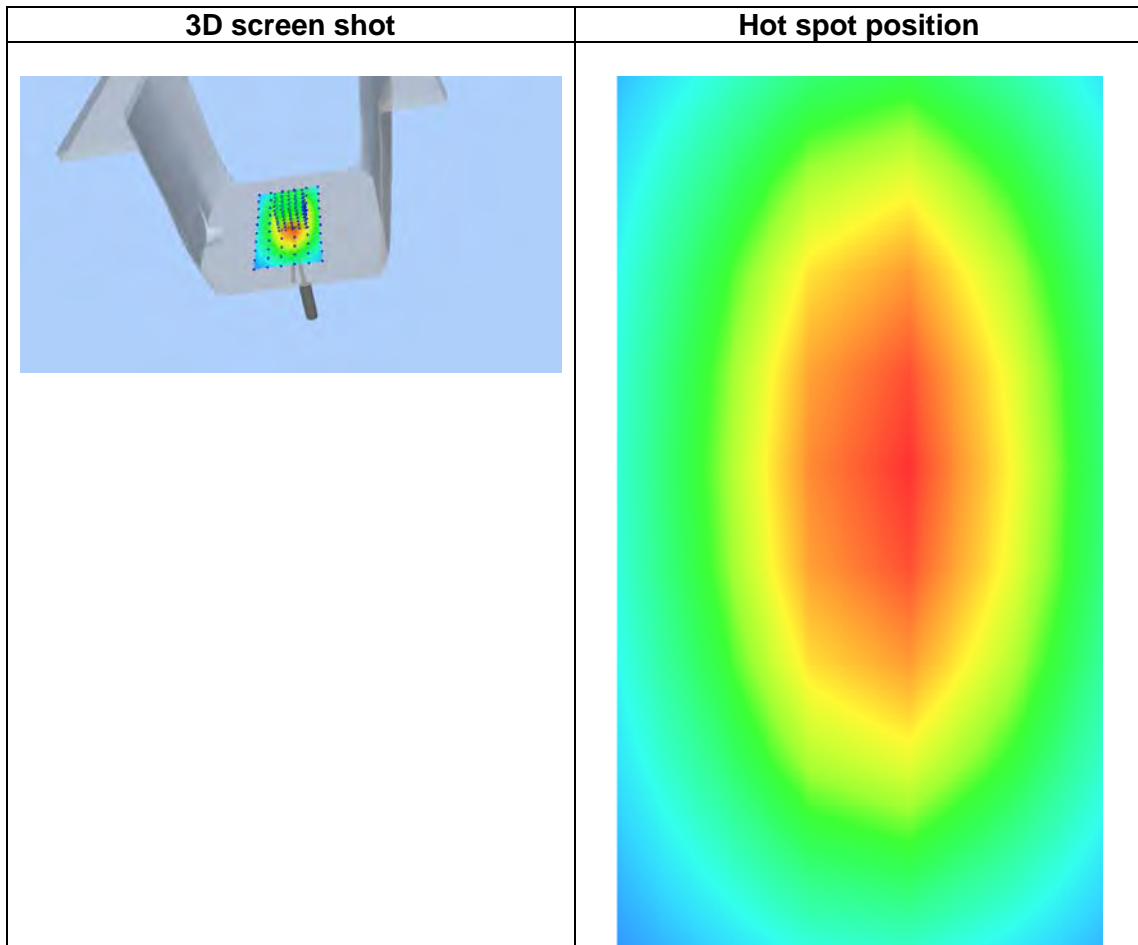
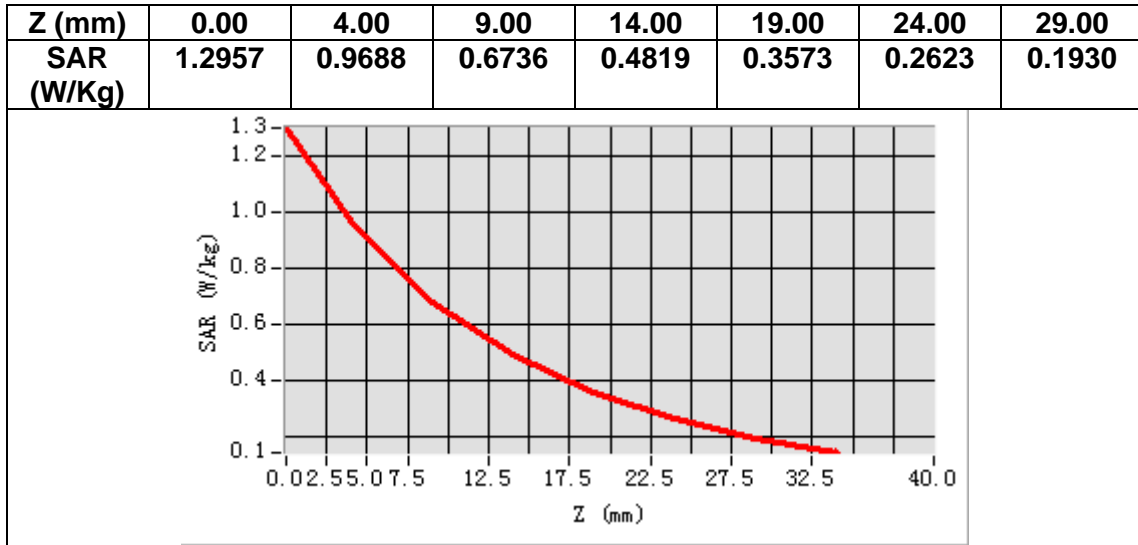

MEASUREMENT 3

A. Experimental conditions.

Area Scan	<u>dx=15mm dy=15mm, h= 5.00 mm</u>
ZoomScan	<u>5x5x7,dx=8mm dy=8mm dz=5mm</u>
Phantom	<u>Validation plane</u>
Device Position	<u>Dipole</u>
Band	<u>CW835</u>
Channels	<u>Middle</u>
Signal	<u>CW (Crest factor: 1.0)</u>

B. SAR Measurement Results

Frequency (MHz)	835.000000
Relative permittivity (real part)	40.783541
Relative permittivity (imaginary part)	19.951613
Conductivity (S/m)	0.930542
Variation (%)	1.870000

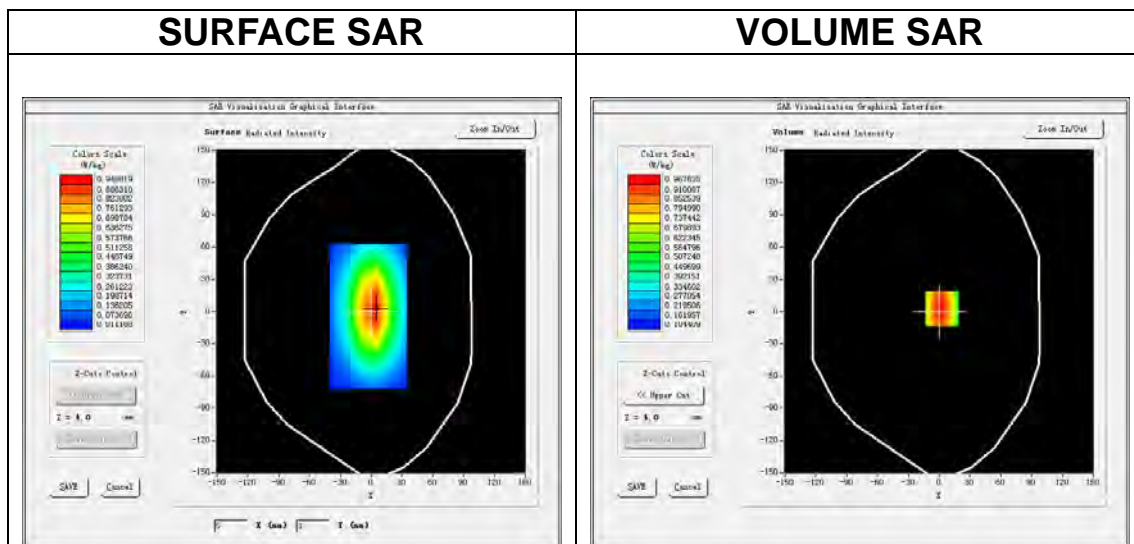

Maximum location: X=3.00, Y=3.00

SAR Peak: 1.30 W/kg

SAR 10g (W/Kg)	0.637466
SAR 1g (W/Kg)	0.986035

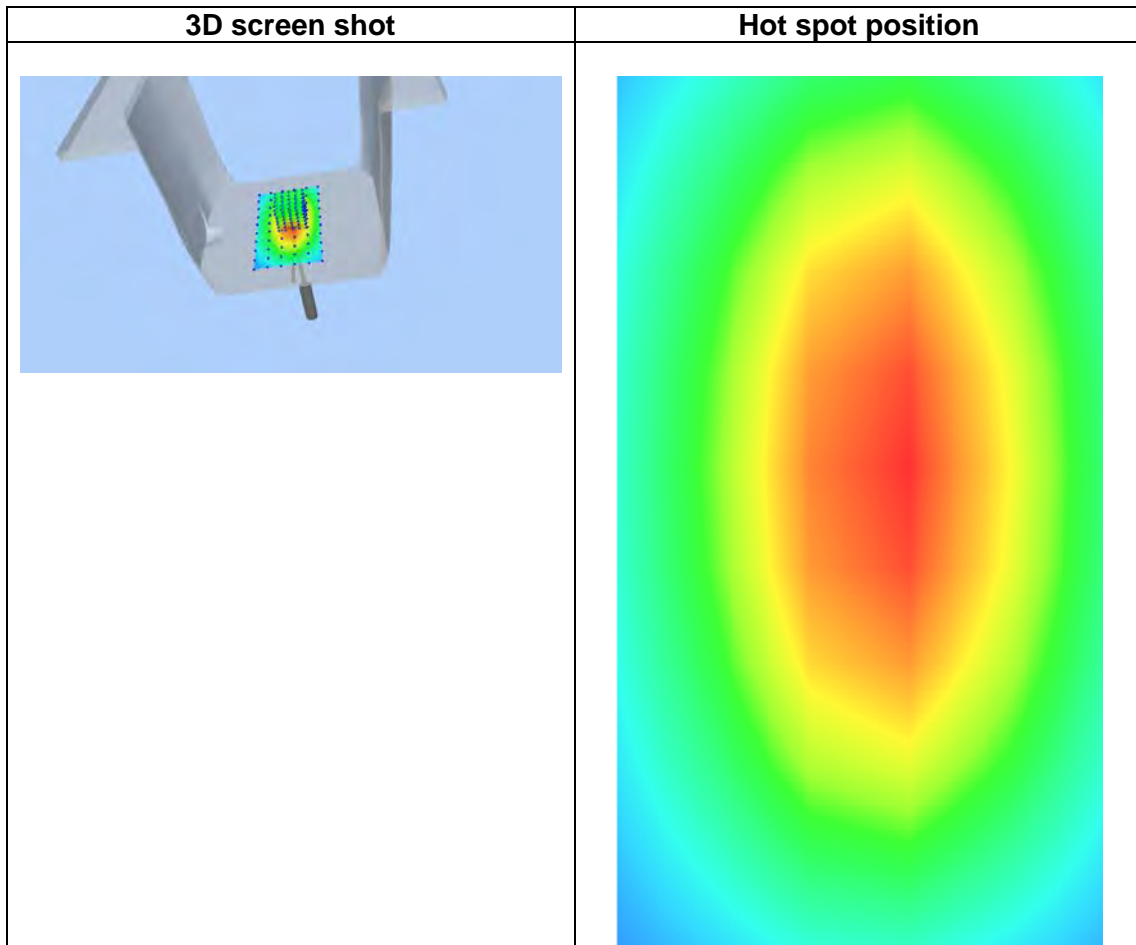
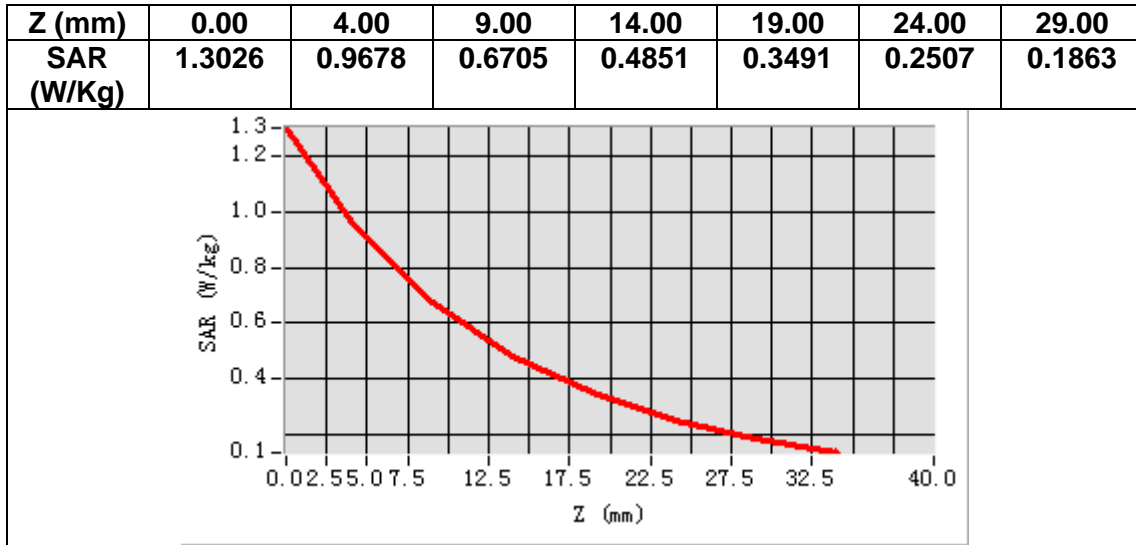

MEASUREMENT 4

A. Experimental conditions.

Area Scan	<u>dx=15mm dy=15mm, h= 5.00 mm</u>
ZoomScan	<u>5x5x7,dx=8mm dy=8mm dz=5mm</u>
Phantom	<u>Validation plane</u>
Device Position	<u>Dipole</u>
Band	<u>CW835</u>
Channels	<u>Middle</u>
Signal	<u>CW (Crest factor: 1.0)</u>

B. SAR Measurement Results

Frequency (MHz)	835.000000
Relative permittivity (real part)	54.511101
Relative permittivity (imaginary part)	21.193359
Conductivity (S/m)	0.981236
Variation (%)	-1.210000

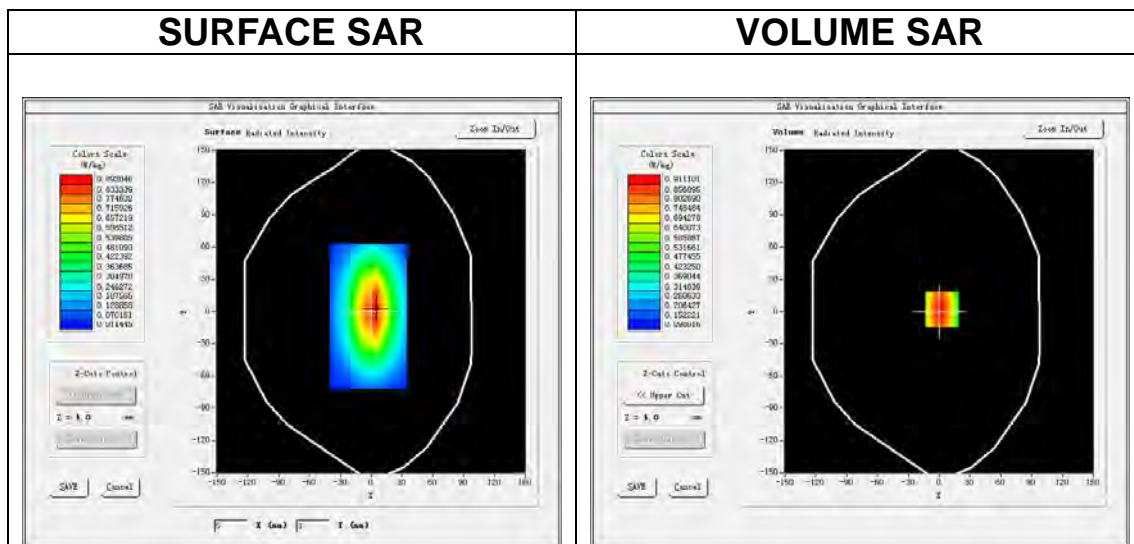

Maximum location: X=3.00, Y=2.00

SAR Peak: 1.23 W/kg

SAR 10g (W/Kg)	0.633123
SAR 1g (W/Kg)	1.037356

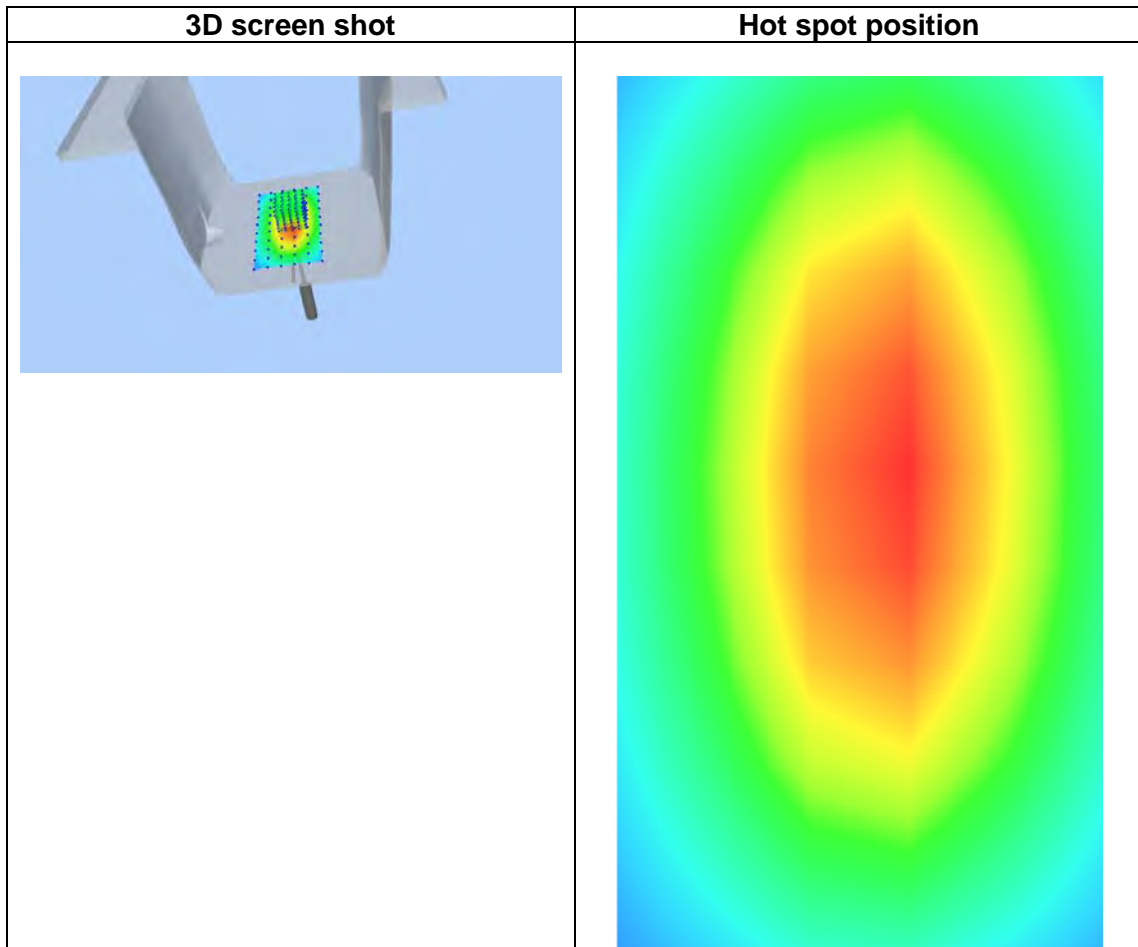
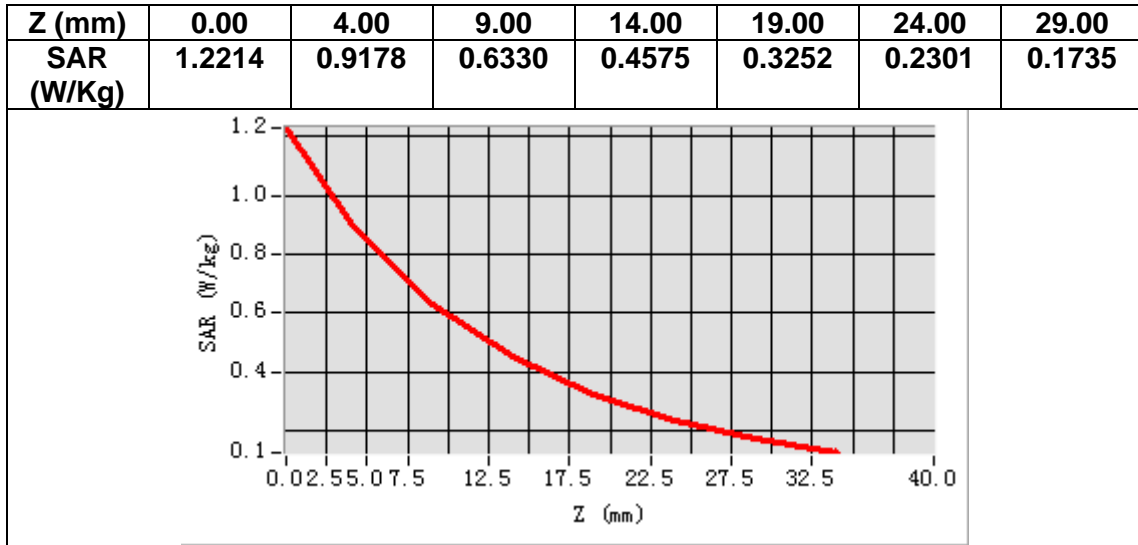

MEASUREMENT 5

A. Experimental conditions.

Area Scan	<u>dx=15mm dy=15mm, h= 5.00 mm</u>
ZoomScan	<u>5x5x7,dx=8mm dy=8mm dz=5mm</u>
Phantom	<u>Validation plane</u>
Device Position	<u>Dipole</u>
Band	<u>CW1800</u>
Channels	<u>Middle</u>
Signal	<u>CW (Crest factor: 1.0)</u>

B. SAR Measurement Results

Frequency (MHz)	1800.000000
Relative permittivity (real part)	38.601237
Relative permittivity (imaginary part)	13.823229
Conductivity (S/m)	1.381367
Variation (%)	-2.113000

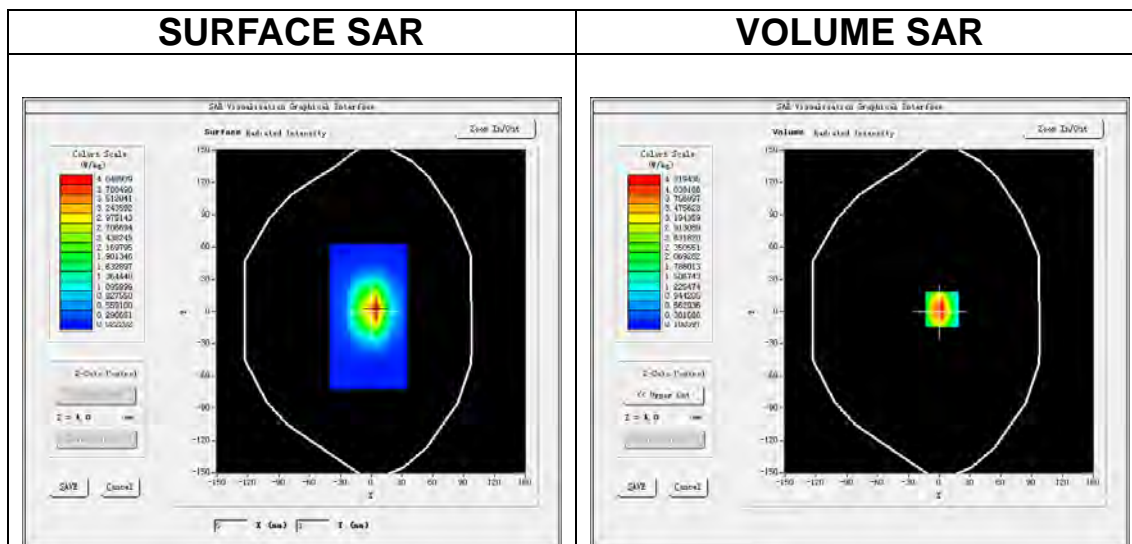

Maximum location: X=3.00, Y=2.00

SAR Peak: 6.82 W/kg

SAR 10g (W/Kg)	2.015397
SAR 1g (W/Kg)	3.731451

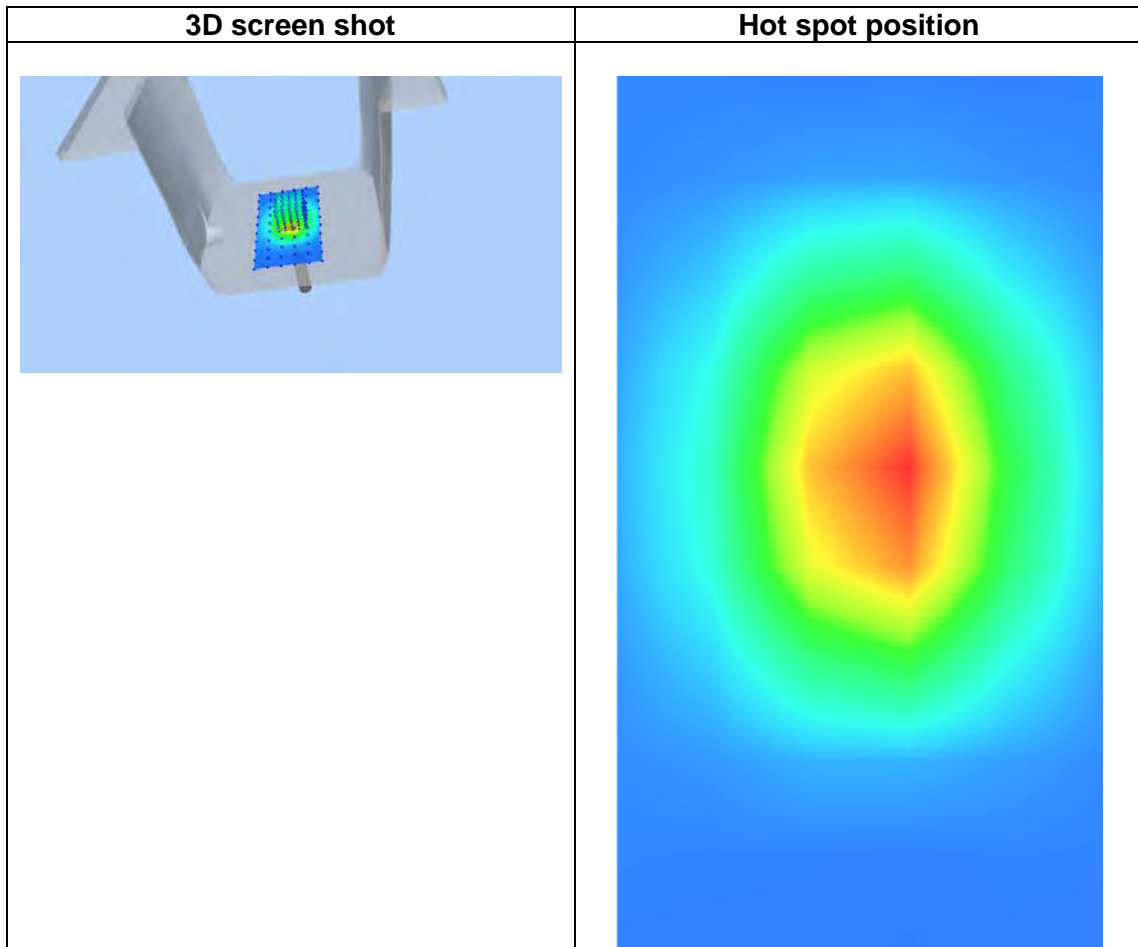
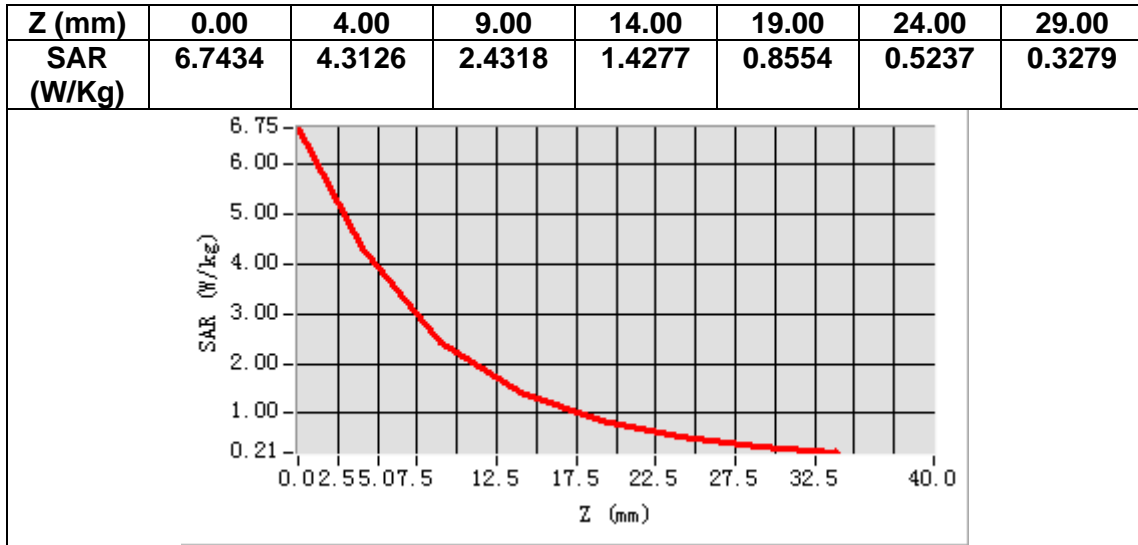

MEASUREMENT 6

A. Experimental conditions.

Area Scan	<u>dx=15mm dy=15mm, h= 5.00 mm</u>
ZoomScan	<u>5x5x7,dx=8mm dy=8mm dz=5mm</u>
Phantom	<u>Validation plane</u>
Device Position	<u>Dipole</u>
Band	<u>CW1800</u>
Channels	<u>Middle</u>
Signal	<u>CW (Crest factor: 1.0)</u>

B. SAR Measurement Results

Frequency (MHz)	1800.000000
Relative permittivity (real part)	54.083510
Relative permittivity (imaginary part)	15.124016
Conductivity (S/m)	1.513096
Variation (%)	2.020000

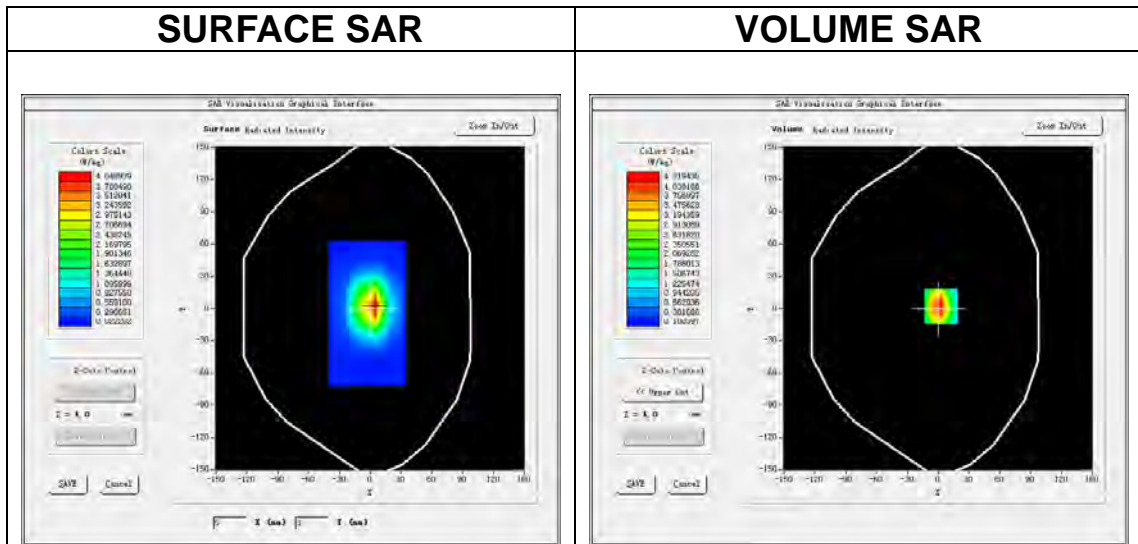

Maximum location: X=3.00, Y=2.00

SAR Peak: 6.82 W/kg

SAR 10g (W/Kg)	2.115379
SAR 1g (W/Kg)	4.024268

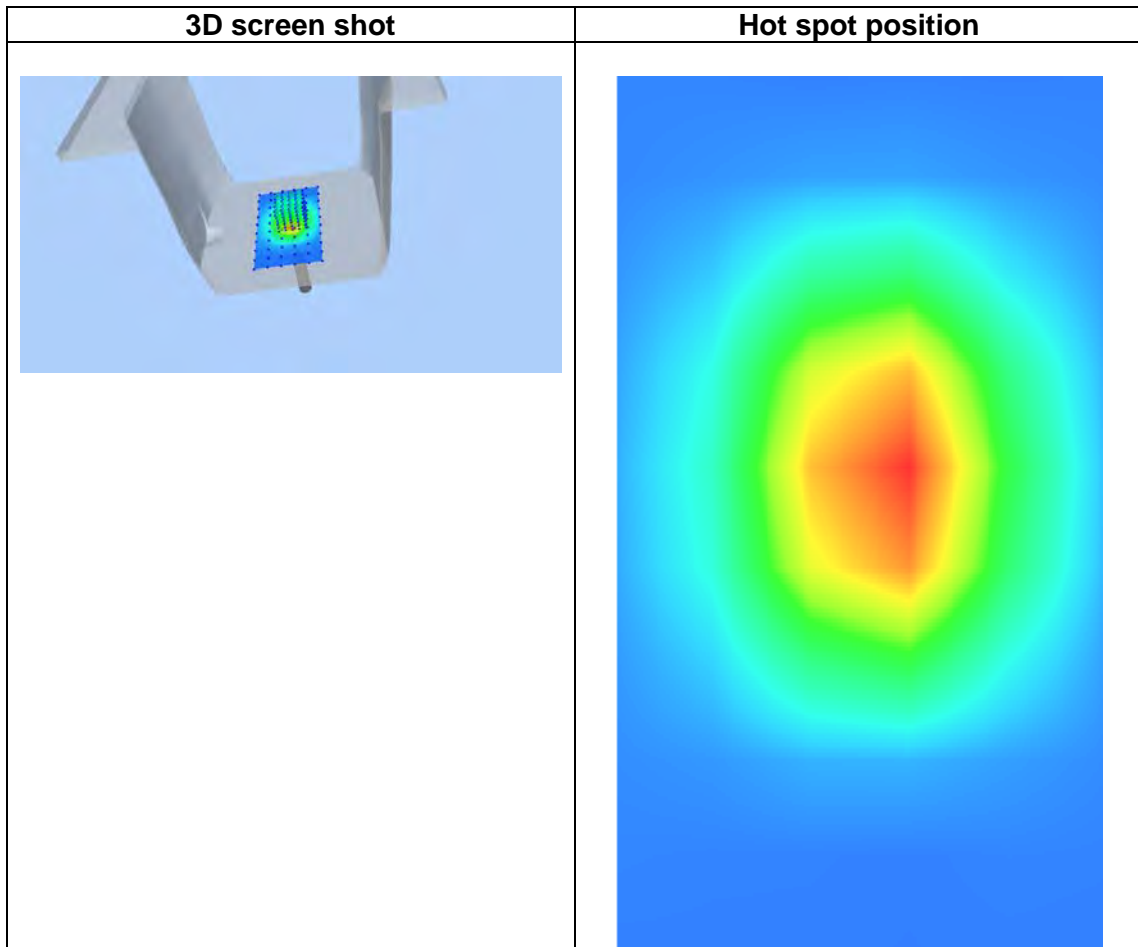
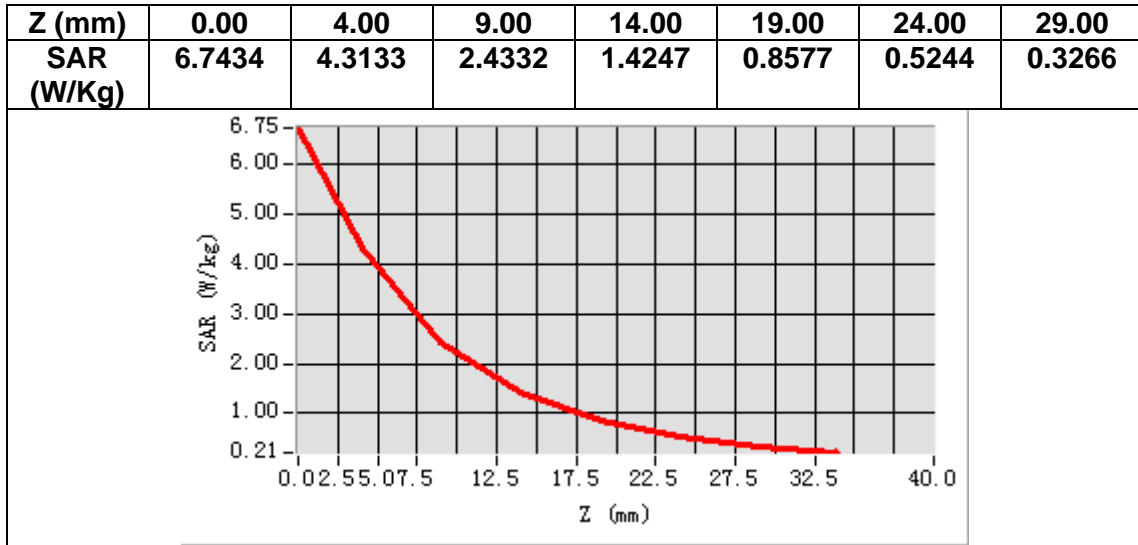

MEASUREMENT 7

A. Experimental conditions.

Area Scan	<u>dx=15mm dy=15mm, h= 5.00 mm</u>
ZoomScan	<u>5x5x7,dx=8mm dy=8mm dz=5mm</u>
Phantom	<u>Validation plane</u>
Device Position	<u>Dipole</u>
Band	<u>CW1900</u>
Channels	<u>Middle</u>
Signal	<u>CW (Crest factor: 1.0)</u>

B. SAR Measurement Results

Frequency (MHz)	1900.000000
Relative permittivity (real part)	38.641287
Relative permittivity (imaginary part)	13.613008
Conductivity (S/m)	1.440336
Variation (%)	-1.430000

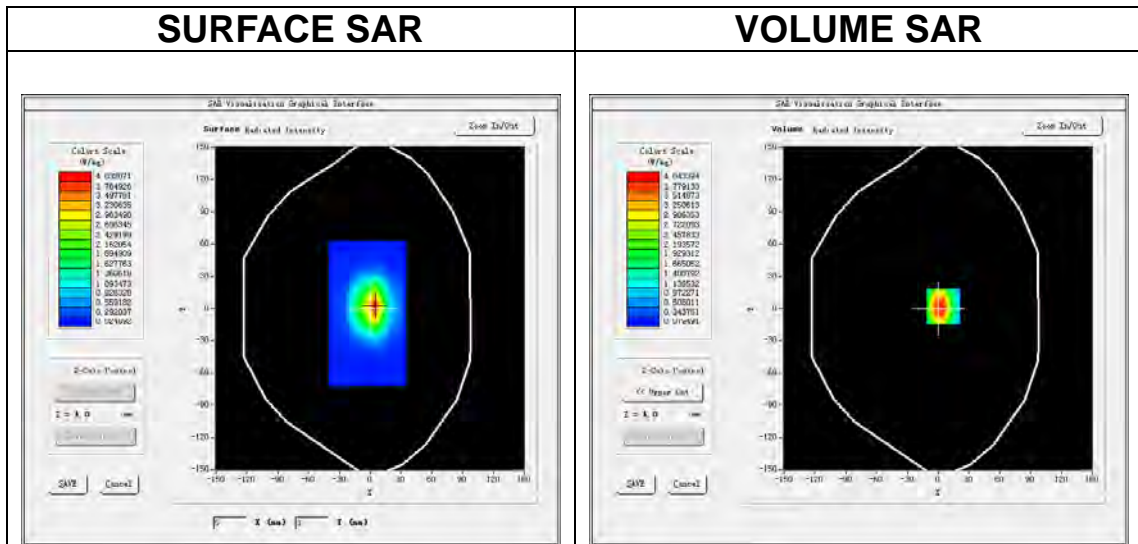

Maximum location: X=5.00, Y=2.00

SAR Peak: 6.70 W/kg

SAR 10g (W/Kg)	1.909456
SAR 1g (W/Kg)	3.826365

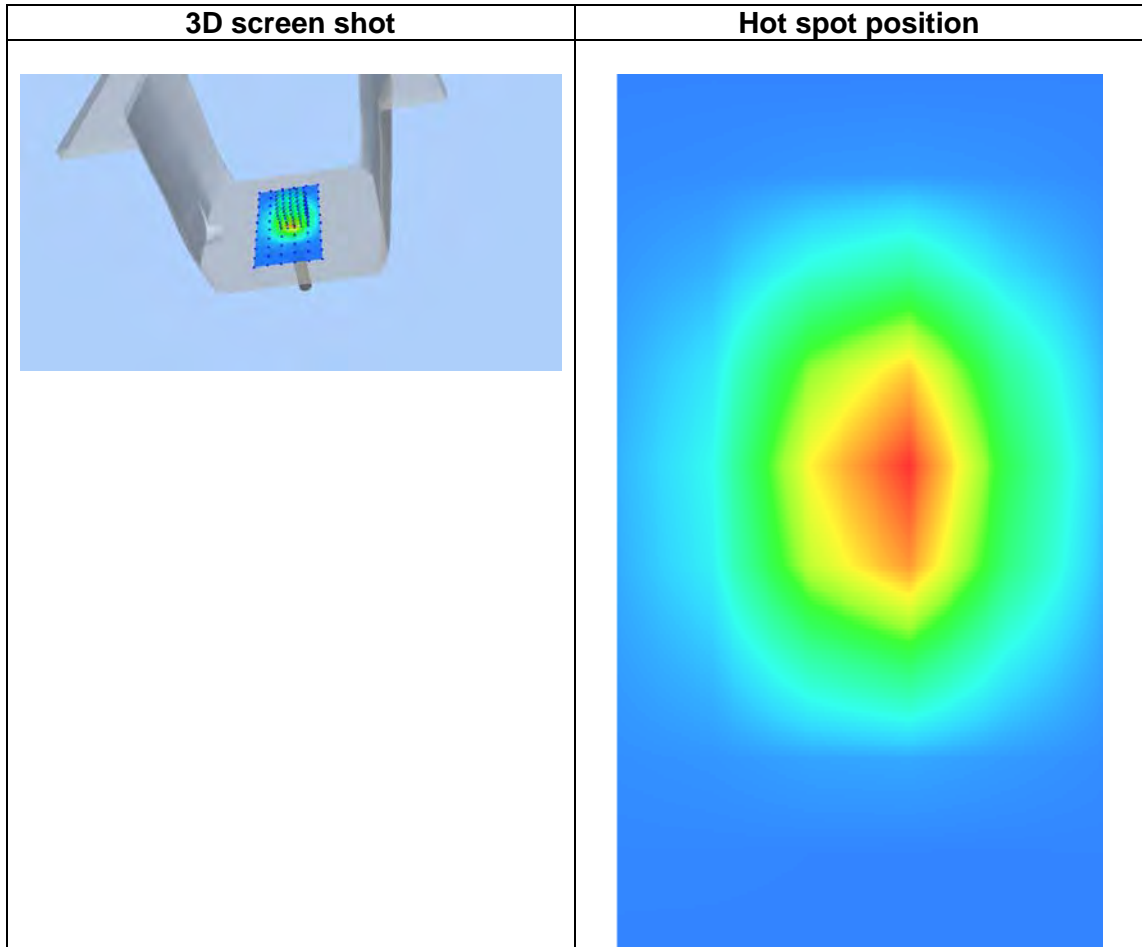
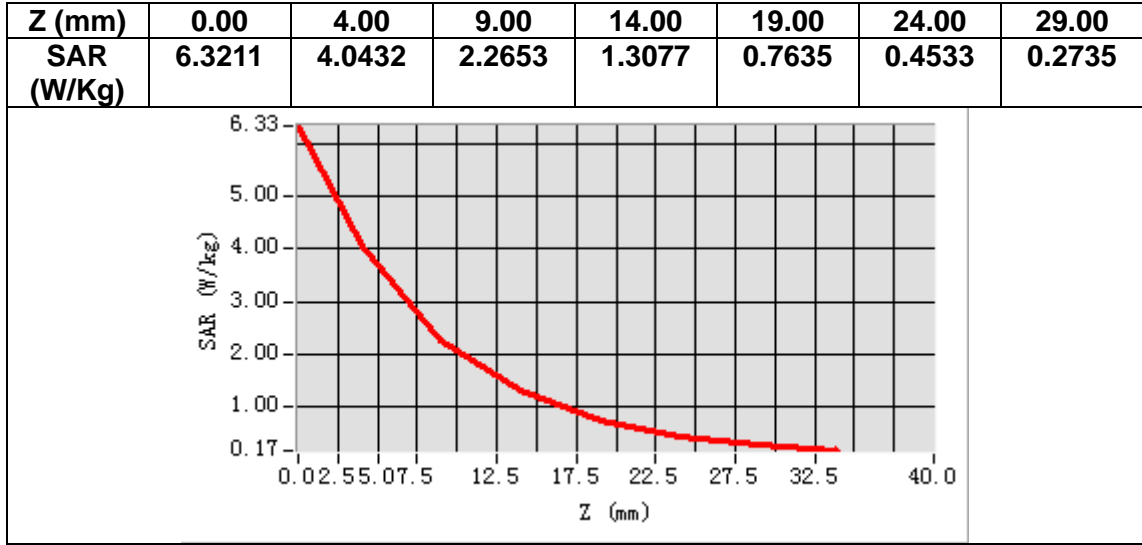

MEASUREMENT 8

A. Experimental conditions.

Area Scan	<u>dx=15mm dy=15mm, h= 5.00 mm</u>
ZoomScan	<u>5x5x7,dx=8mm dy=8mm dz=5mm</u>
Phantom	<u>Validation plane</u>
Device Position	<u>Dipole</u>
Band	<u>CW1900</u>
Channels	<u>Middle</u>
Signal	<u>CW (Crest factor: 1.0)</u>

B. SAR Measurement Results

Frequency (MHz)	1900.000000
Relative permittivity (real part)	54.253335
Relative permittivity (imaginary part)	14.493503
Conductivity (S/m)	1.533566
Variation (%)	0.120000

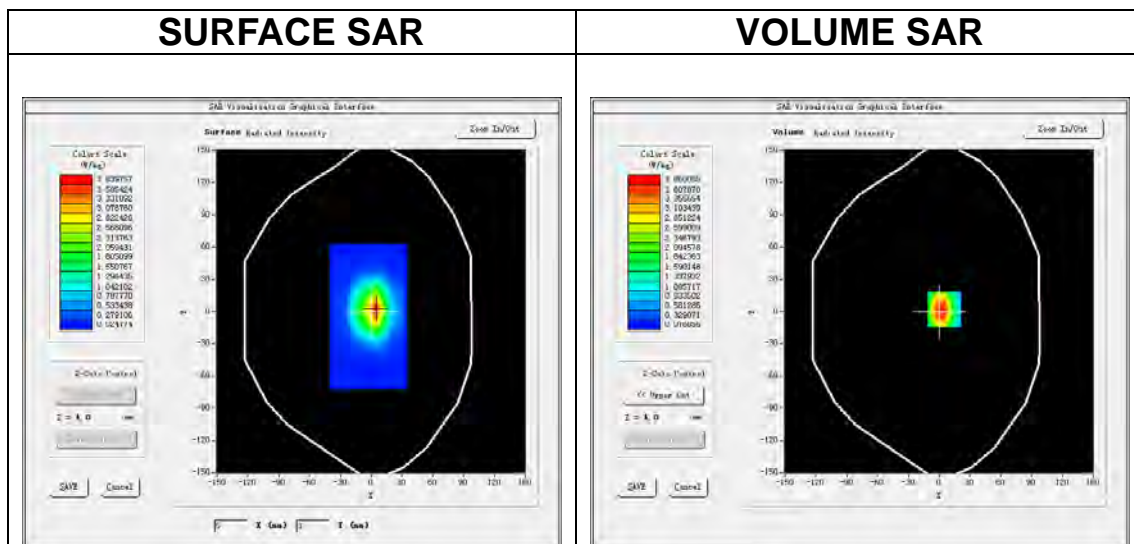

Maximum location: X=5.00, Y=2.00

SAR Peak: 6.39 W/kg

SAR 10g (W/Kg)	2.104329
SAR 1g (W/Kg)	3.720402

Z (mm)	0.00	4.00	9.00	14.00	19.00	24.00	29.00
SAR (W/Kg)	6.0345	3.8665	2.1619	1.2445	0.7255	0.4326	0.2634

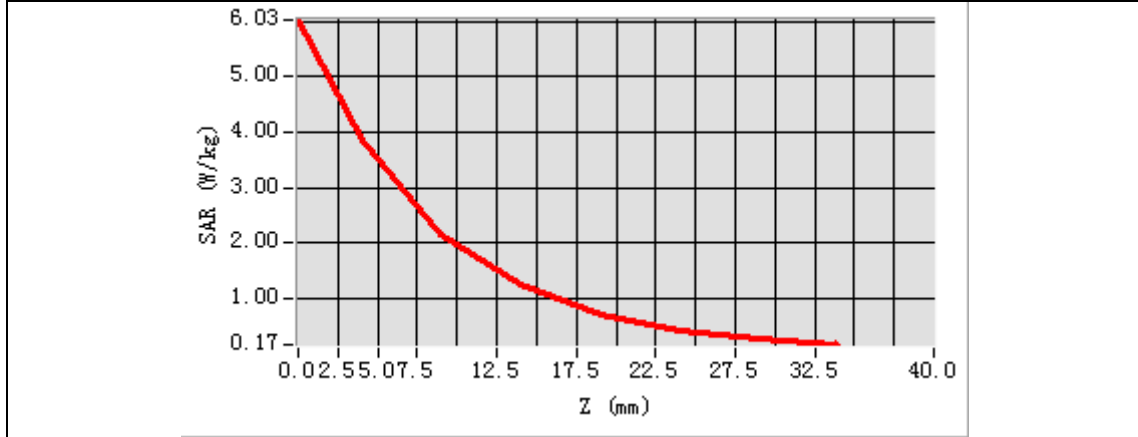

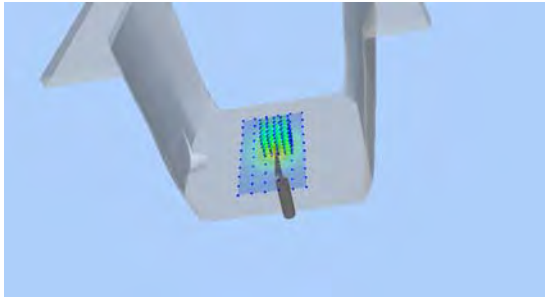
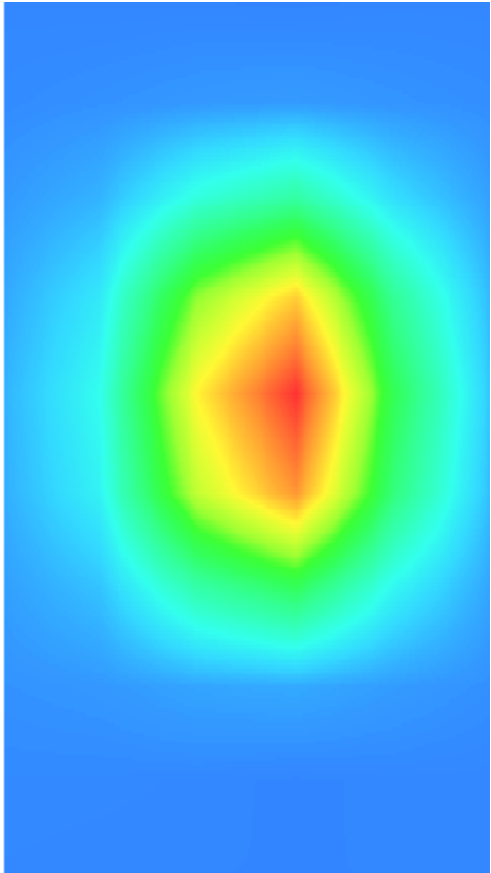
3D screen shot	Hot spot position
	

MEASUREMENT 9

A. Experimental conditions.

Area Scan	<u>dx=12mm dy=12mm, h= 5.00 mm</u>
ZoomScan	<u>7x7x7,dx=5mm dy=5mm dz=5mm</u>
Phantom	<u>Validation plane</u>
Device Position	<u>Dipole</u>
Band	<u>CW2450</u>
Channels	<u>Middle</u>
Signal	<u>CW (Crest factor: 1.0)</u>

B. SAR Measurement Results

Frequency (MHz)	2450.000000
Relative permittivity (real part)	38.531421
Relative permittivity (imaginary part)	13.562631
Conductivity (S/m)	1.850663
Variation (%)	-3.350000

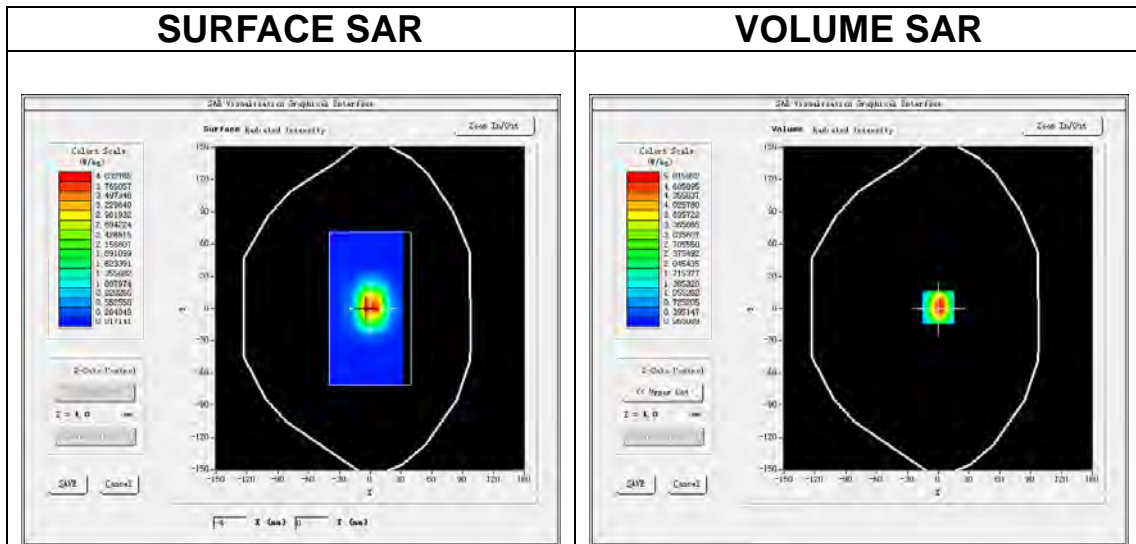

Maximum location: X=0.00, Y=1.00

SAR Peak: 8.14 W/kg

SAR 10g (W/Kg)	2.471375
SAR 1g (W/Kg)	5.687435

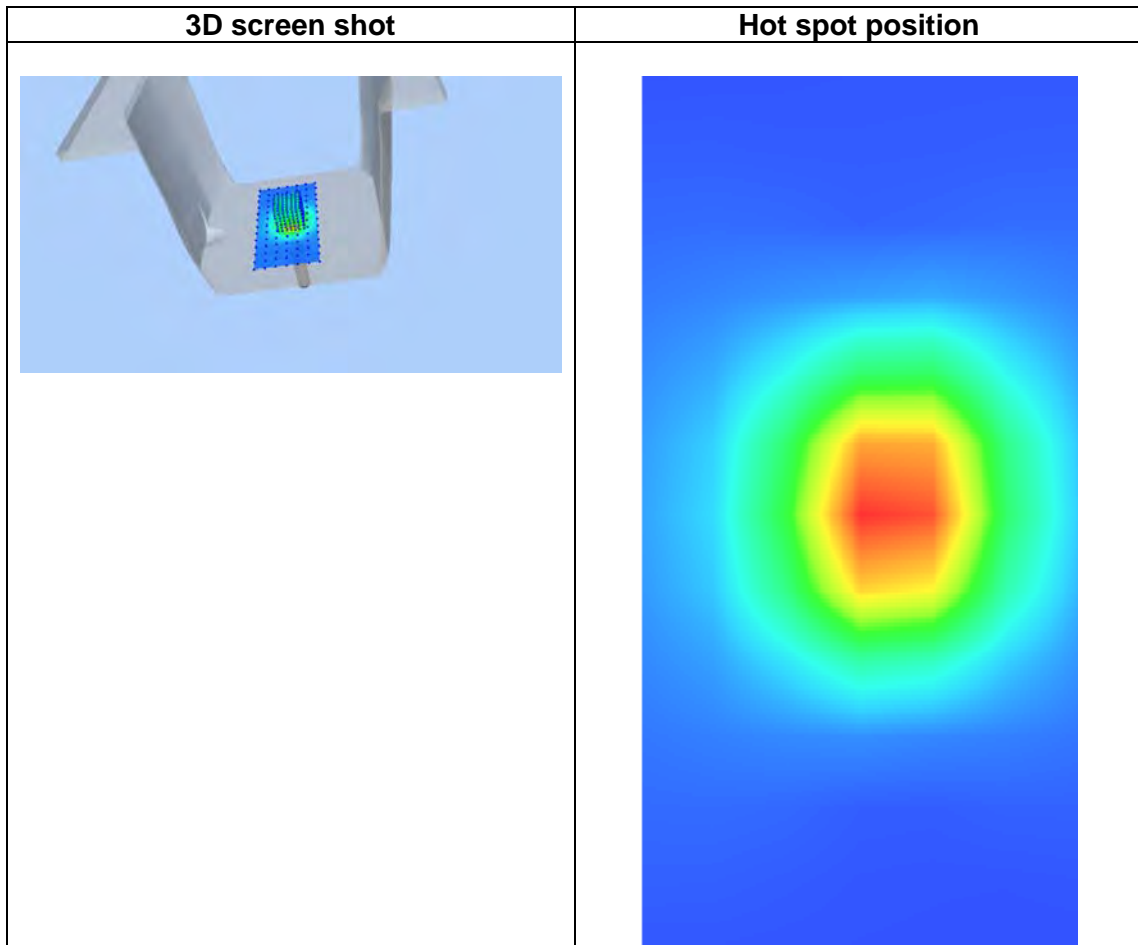
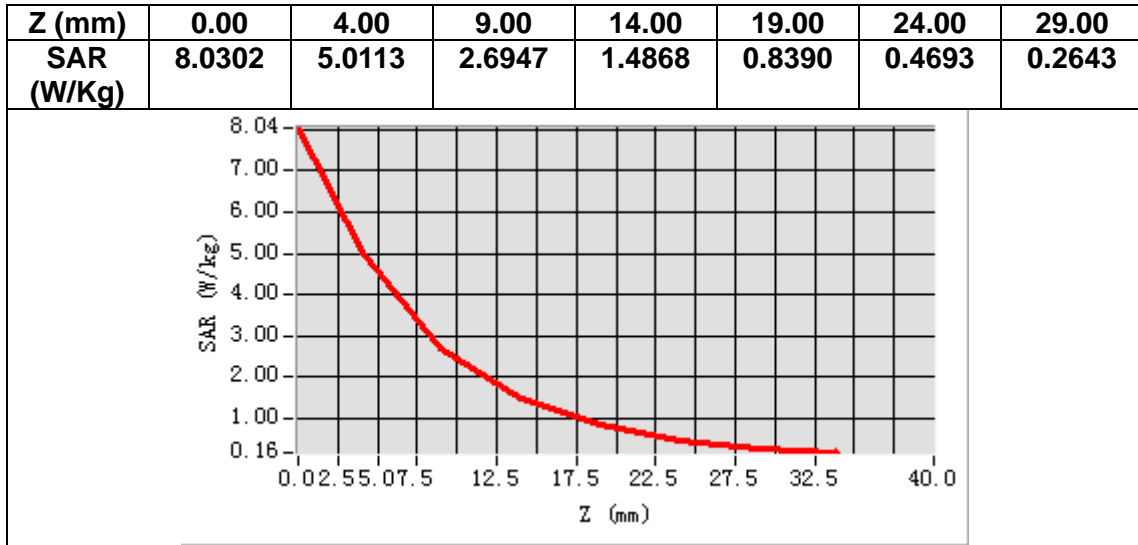

MEASUREMENT 10

A. Experimental conditions.

Area Scan	<u>dx=12mm dy=12mm, h= 5.00 mm</u>
ZoomScan	<u>7x7x7, dx=5mm dy=5mm dz=5mm</u>
Phantom	<u>Validation plane</u>
Device Position	<u>Dipole</u>
Band	<u>CW2450</u>
Channels	<u>Middle</u>
Signal	<u>CW (Crest factor: 1.0)</u>

B. SAR Measurement Results

Frequency (MHz)	2450.000000
Relative permittivity (real part)	51.511497
Relative permittivity (imaginary part)	13.843566
Conductivity (S/m)	1.882816
Variation (%)	0.420000

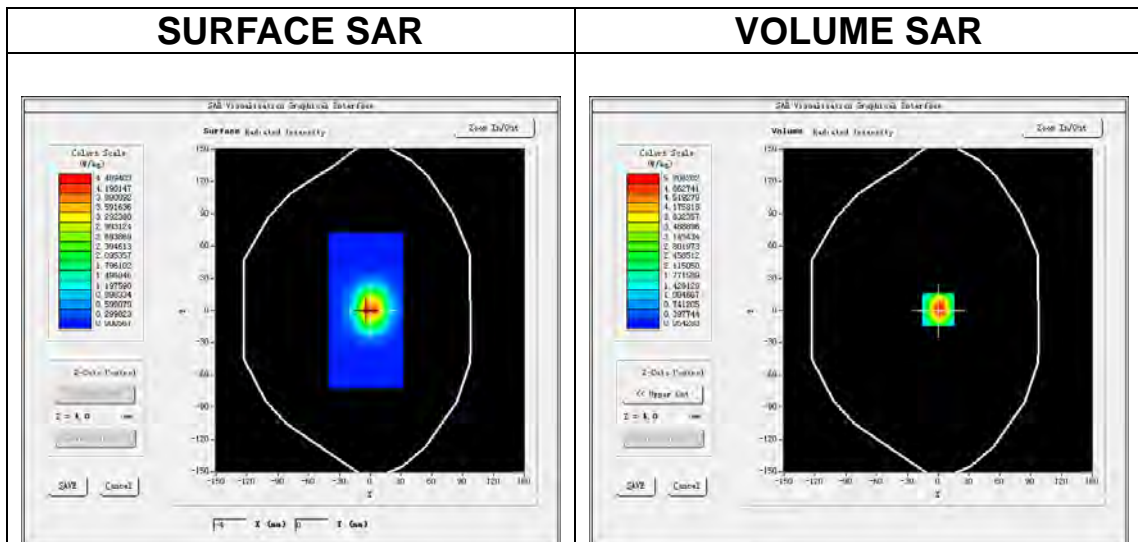

Maximum location: X=0.00, Y=1.00

SAR Peak: 8.46 W/kg

SAR 10g (W/Kg)	2.409285
SAR 1g (W/Kg)	5.290270

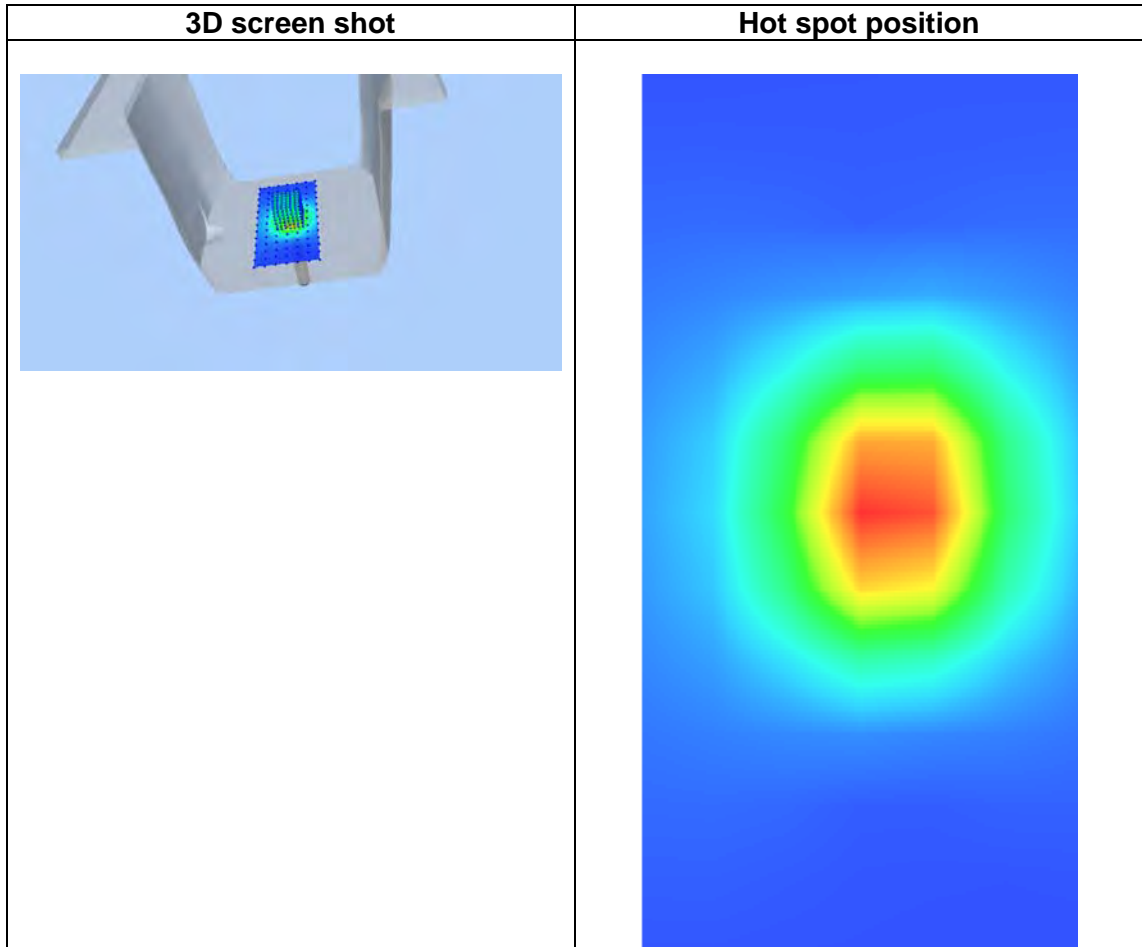
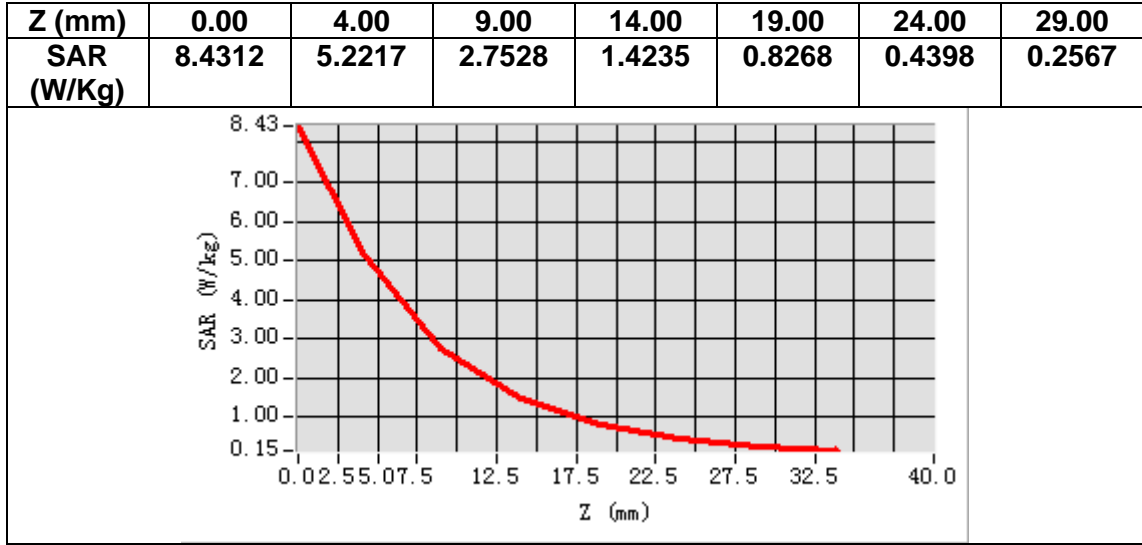

MEASUREMENT 11

A. Experimental conditions.

Area Scan	<u>dx=12mm dy=12mm, h= 5.00 mm</u>
ZoomScan	<u>7x7x7,dx=5mm dy=5mm dz=5mm</u>
Phantom	<u>Validation plane</u>
Device Position	<u>Dipole</u>
Band	<u>CW2600</u>
Channels	<u>Middle</u>
Signal	<u>CW (Crest factor: 1.0)</u>

B. SAR Measurement Results

Frequency (MHz)	2600.000000
Relative permittivity (real part)	38.122638
Relative permittivity (imaginary part)	14.003997
Conductivity (S/m)	2.023631
Variation (%)	-0.040000

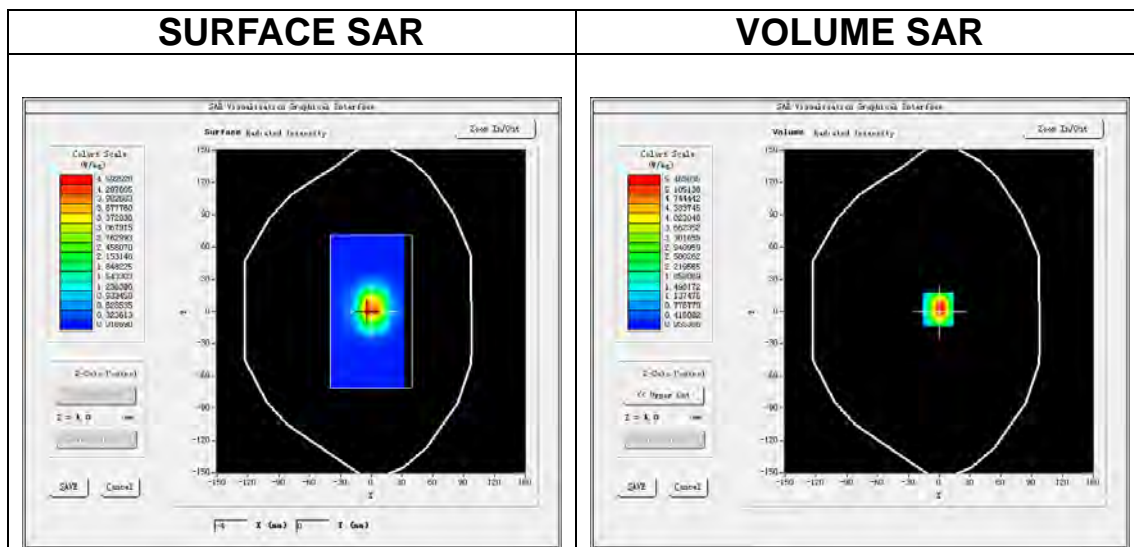

Maximum location: X=-1.00, Y=2.00

SAR Peak: 9.07 W/kg

SAR 10g (W/Kg)	2.337205
SAR 1g (W/Kg)	5.890267

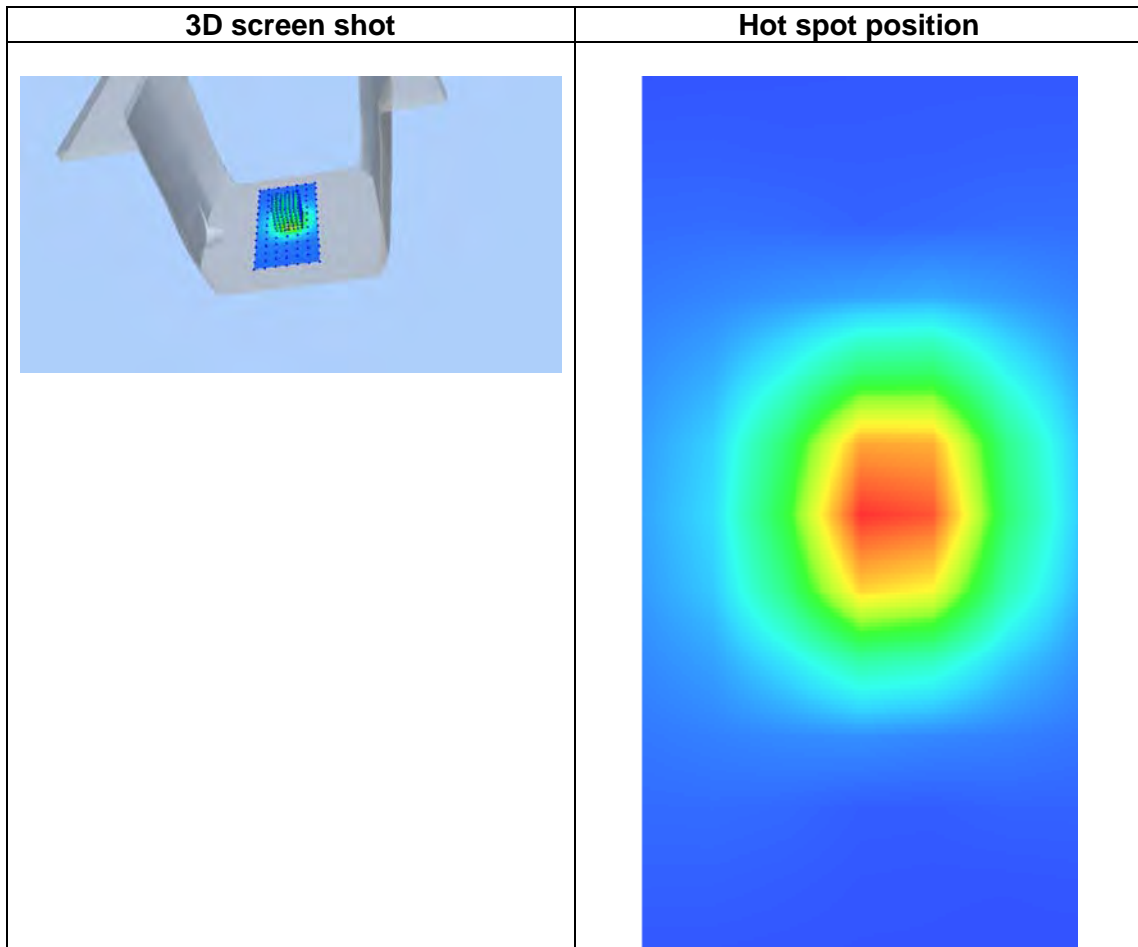
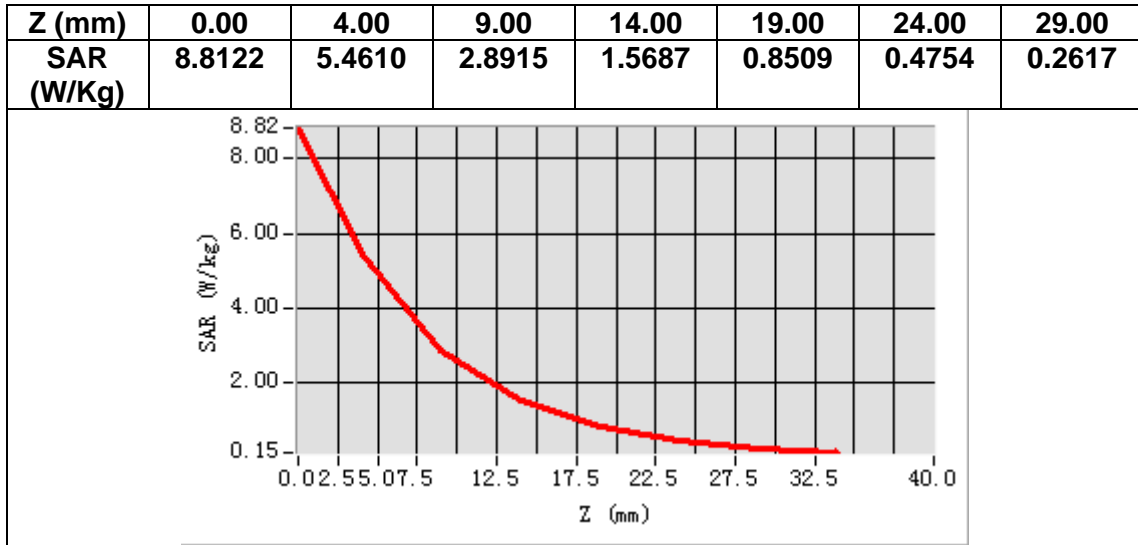

MEASUREMENT 12

A. Experimental conditions.

Area Scan	<u>dx=12mm dy=12mm, h= 5.00 mm</u>
ZoomScan	<u>7x7x7,dx=5mm dy=5mm dz=5mm</u>
Phantom	<u>Validation plane</u>
Device Position	<u>Dipole</u>
Band	<u>CW2600</u>
Channels	<u>Middle</u>
Signal	<u>CW (Crest factor: 1.0)</u>

B. SAR Measurement Results

Frequency (MHz)	2600.000000
Relative permittivity (real part)	52.842866
Relative permittivity (imaginary part)	15.340101
Conductivity (S/m)	2.223465
Variation (%)	-1.220000

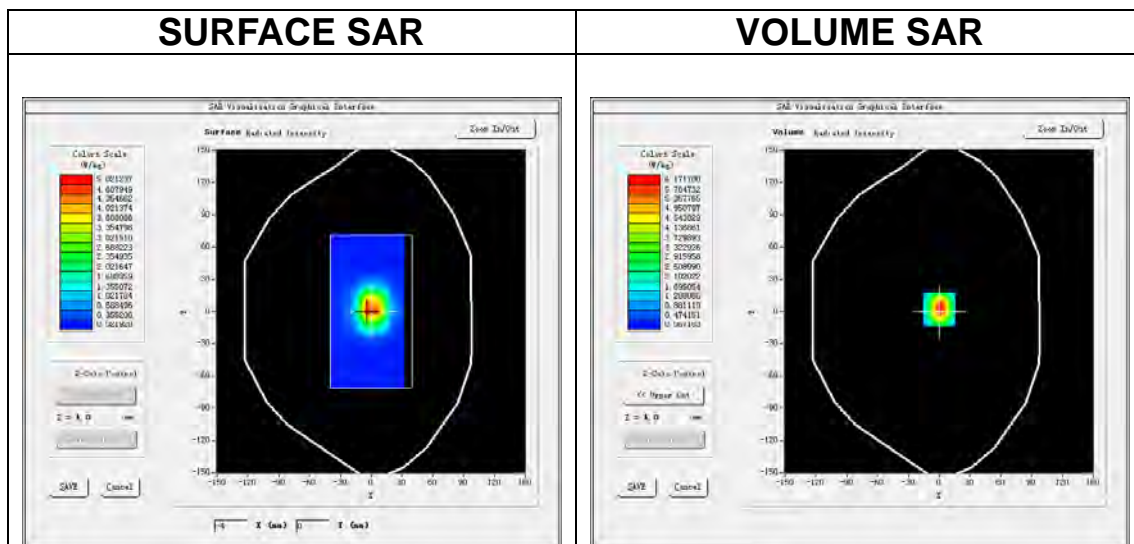

Maximum location: X=0.00, Y=2.00

SAR Peak: 9.99 W/kg

SAR 10g (W/Kg)	2.280324
SAR 1g (W/Kg)	5.057188

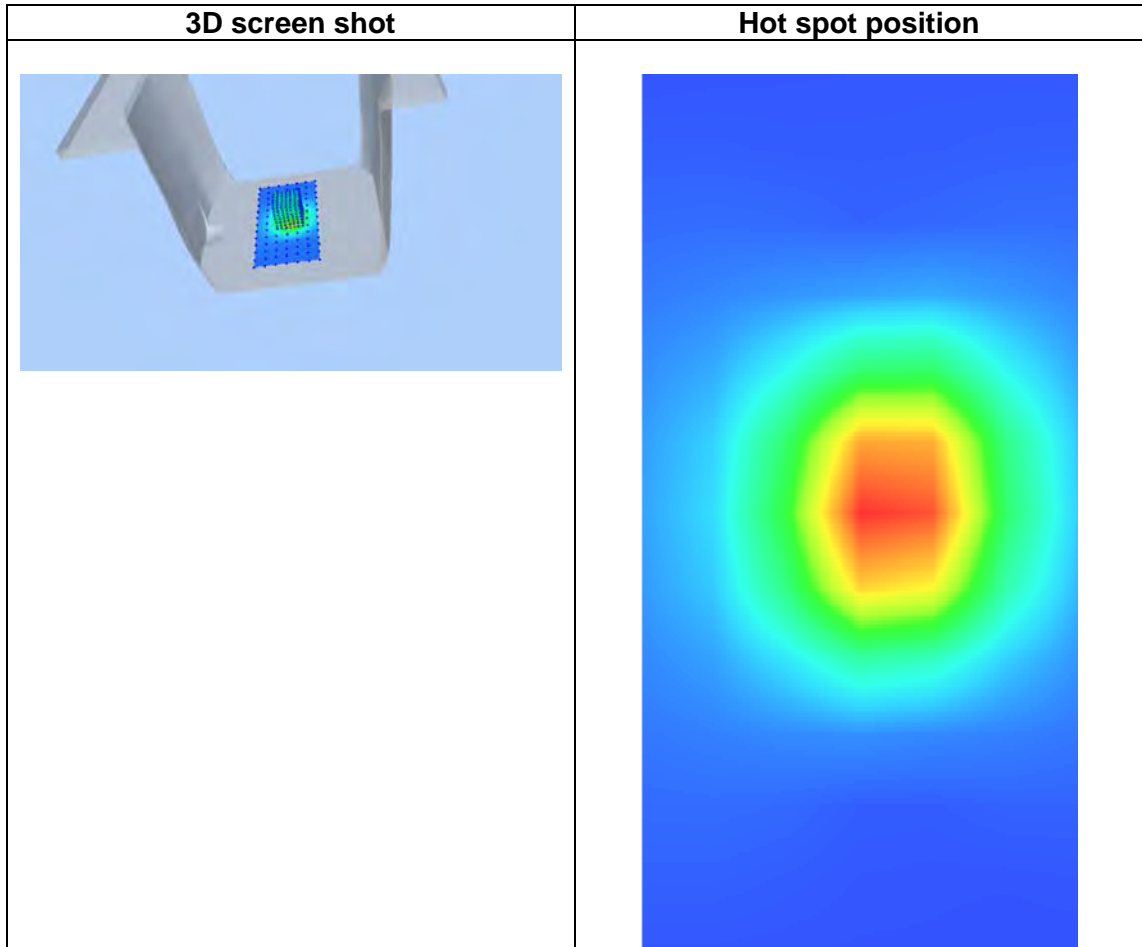
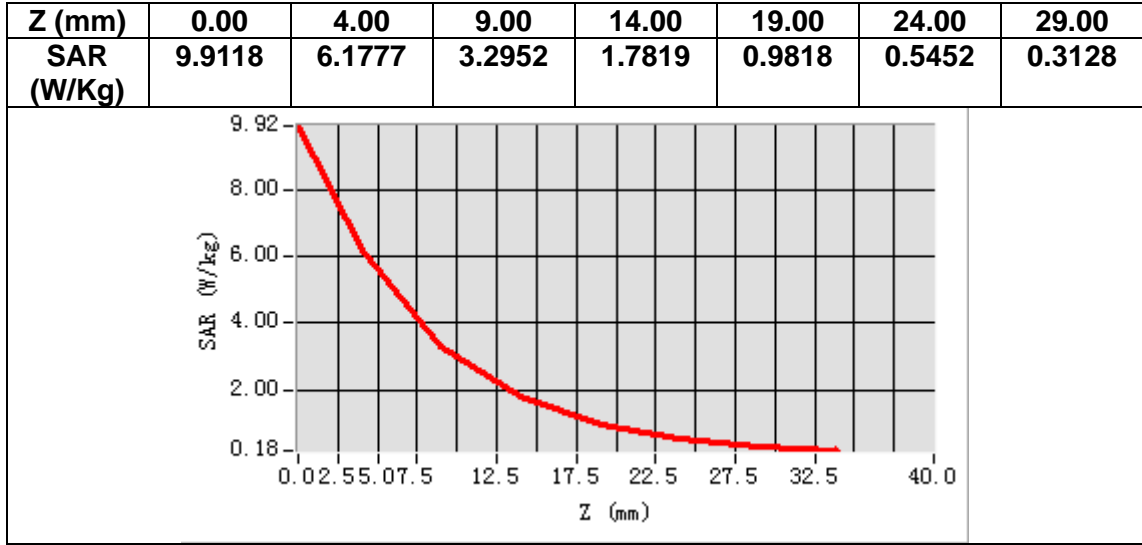

13. Appendix C. Plots of High SAR Measurement

Table of contents
MEASUREMENT 1 GSM 850 Head
MEASUREMENT 2 GSM 850 Body
MEASUREMENT 3 GSM 1900 Head
MEASUREMENT 4 GSM 1900 Body
MEASUREMENT 5 WCDMA Band 2 Head
MEASUREMENT 6 WCDMA Band 2 Body
MEASUREMENT 7 WCDMA Band 4 Head
MEASUREMENT 8 WCDMA Band 4 Body
MEASUREMENT 9 WCDMA Band 5 Head
MEASUREMENT 10 WCDMA Band 5 Body
MEASUREMENT 11 WLAN 2.4G Head
MEASUREMENT 12 WLAN 2.4G Body
MEASUREMENT 13 LTE Band 2 Head
MEASUREMENT 14 LTE Band 2 Body
MEASUREMENT 15 LTE Band 4 Head
MEASUREMENT 16 LTE Band 4 Body
MEASUREMENT 17 LTE Band 5 Head
MEASUREMENT 18 LTE Band 5 Body
MEASUREMENT 19 LTE Band 7 Head
MEASUREMENT 20 LTE Band 7 Body
MEASUREMENT 21 LTE Band 12 Head
MEASUREMENT 22 LTE Band 12 Body
MEASUREMENT 23 LTE Band 17 Head
MEASUREMENT 24 LTE Band 17 Body

MEASUREMENT 1

A. Experimental conditions.

Area Scan	<u>dx=15mm dy=15mm, h= 5.00 mm</u>
ZoomScan	<u>5x5x7,dx=8mm dy=8mm dz=5mm</u>
Phantom	<u>Left head</u>
Device Position	<u>Cheek</u>
Band	<u>GSM850</u>
Channels	<u>Middle</u>
Signal	<u>TDMA (Crest factor: 2.0)</u>

B. SAR Measurement Results

Frequency (MHz)	836.400000
Relative permittivity (real part)	40.690960
Relative permittivity (imaginary part)	19.971540
Conductivity (S/m)	0.928011
Variation (%)	2.310000

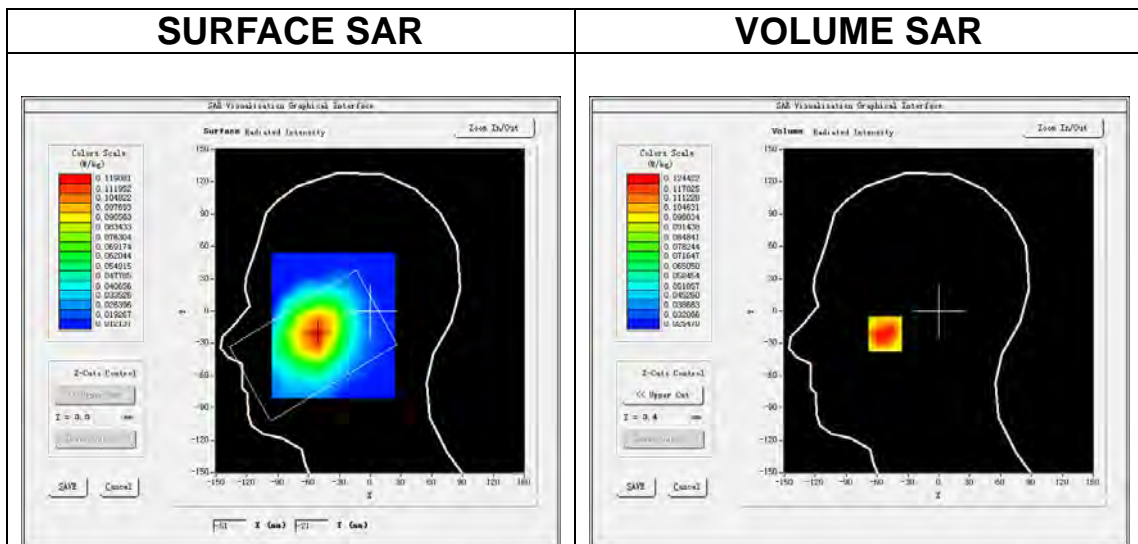

Maximum location: X=-52.00, Y=-21.00

SAR Peak: 0.16 W/kg

SAR 10g (W/Kg)	0.093053
SAR 1g (W/Kg)	0.124986

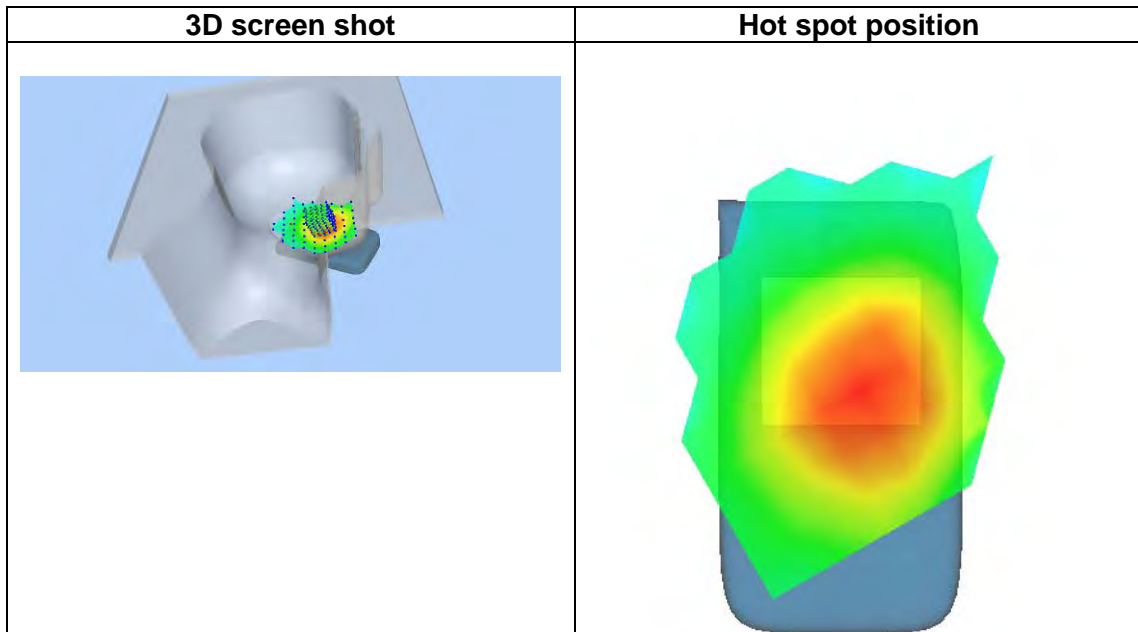
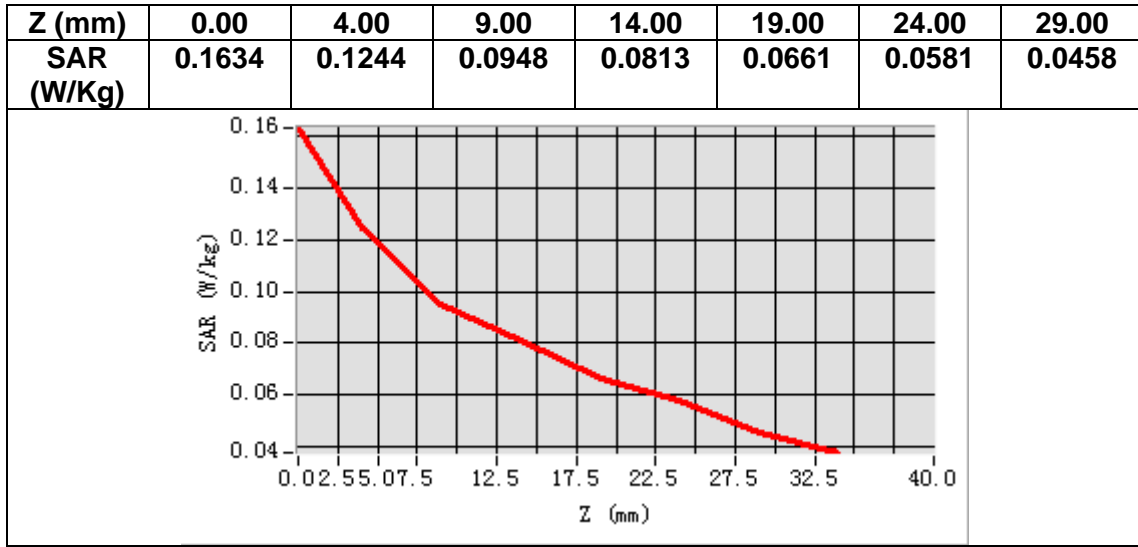

MEASUREMENT 2

A. Experimental conditions.

Area Scan	<u>dx=15mm dy=15mm, h= 5.00 mm</u>
ZoomScan	<u>5x5x7,dx=8mm dy=8mm dz=5mm</u>
Phantom	<u>Validation plane</u>
Device Position	<u>Body</u>
Band	<u>GSM850</u>
Channels	<u>Middle</u>
Signal	<u>TDMA (Crest factor: 2.0)</u>

B. SAR Measurement Results

Frequency (MHz)	836.400000
Relative permittivity (real part)	54.519581
Relative permittivity (imaginary part)	21.172741
Conductivity (S/m)	0.983827
Variation (%)	-3.480000

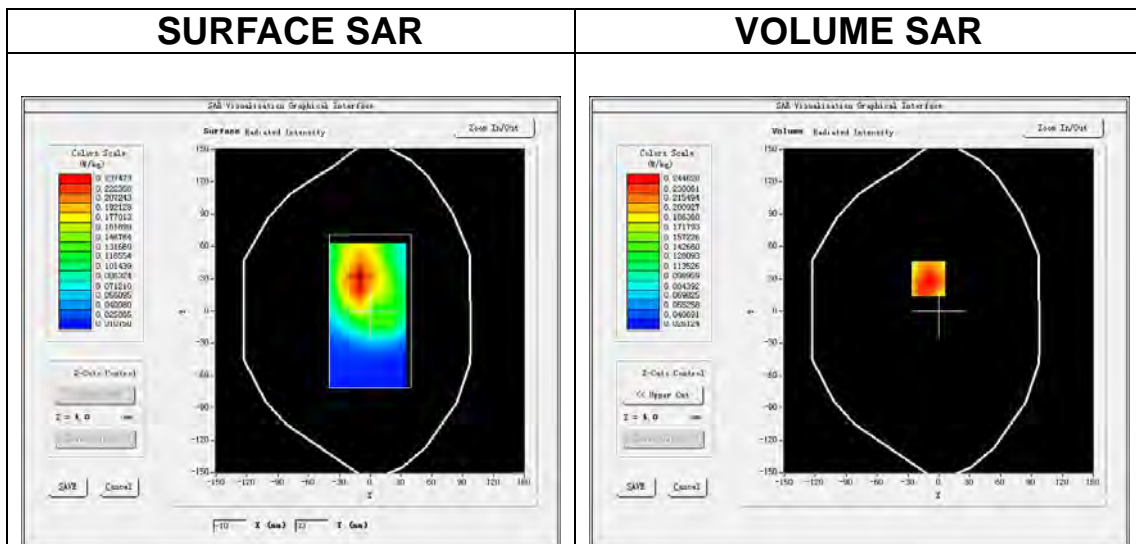

Maximum location: X=-10.00, Y=30.00

SAR Peak: 0.33 W/kg

SAR 10g (W/Kg)	0.167282
SAR 1g (W/Kg)	0.240334

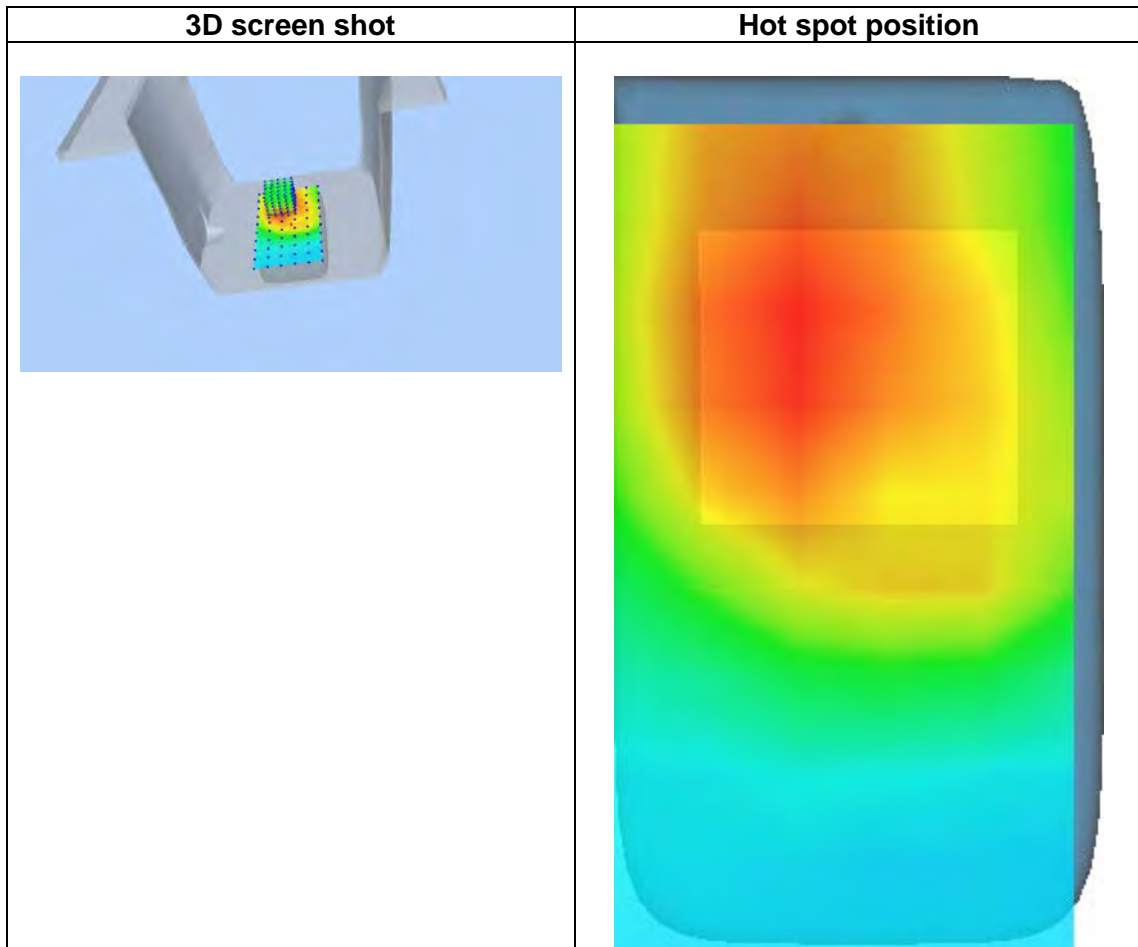
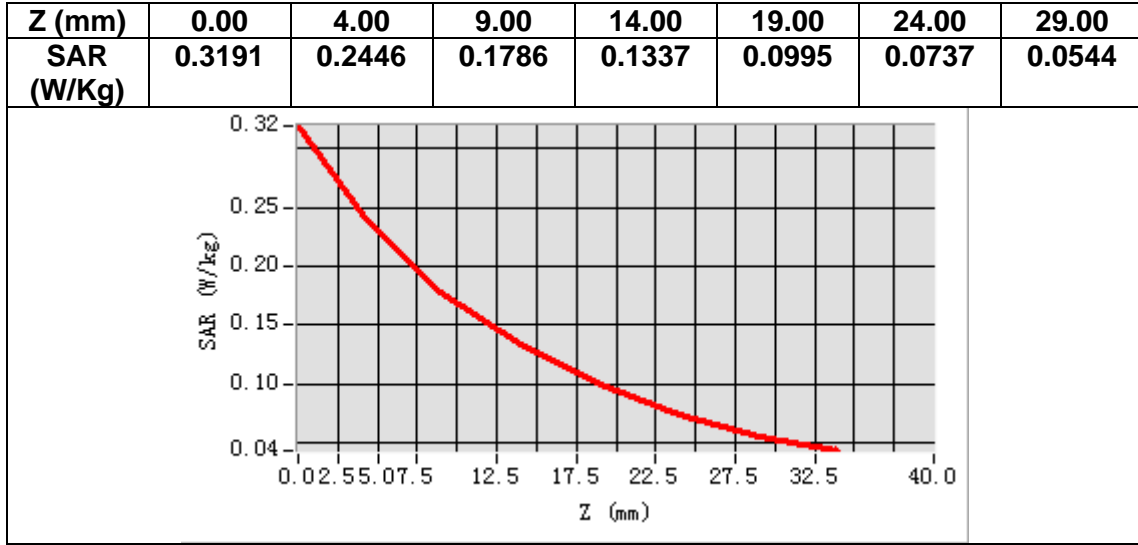

MEASUREMENT 3

A. Experimental conditions.

Area Scan	<u>dx=15mm dy=15mm, h= 5.00 mm</u>
ZoomScan	<u>5x5x7,dx=8mm dy=8mm dz=5mm</u>
Phantom	<u>Left head</u>
Device Position	<u>Cheek</u>
Band	<u>GSM1900</u>
Channels	<u>Middle</u>
Signal	<u>TDMA (Crest factor: 2.7)</u>

B. SAR Measurement Results

Frequency (MHz)	1880.000000
Relative permittivity (real part)	39.016998
Relative permittivity (imaginary part)	13.260200
Conductivity (S/m)	1.384954
Variation (%)	-2.390000

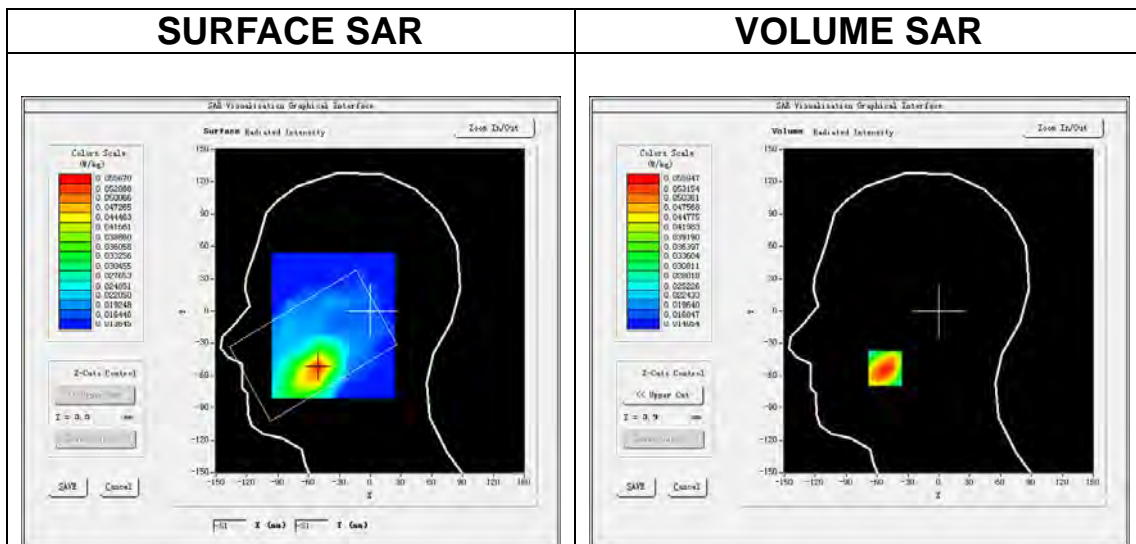

Maximum location: X=-52.00, Y=-53.00

SAR Peak: 0.07 W/kg

SAR 10g (W/Kg)	0.036473
SAR 1g (W/Kg)	0.053066

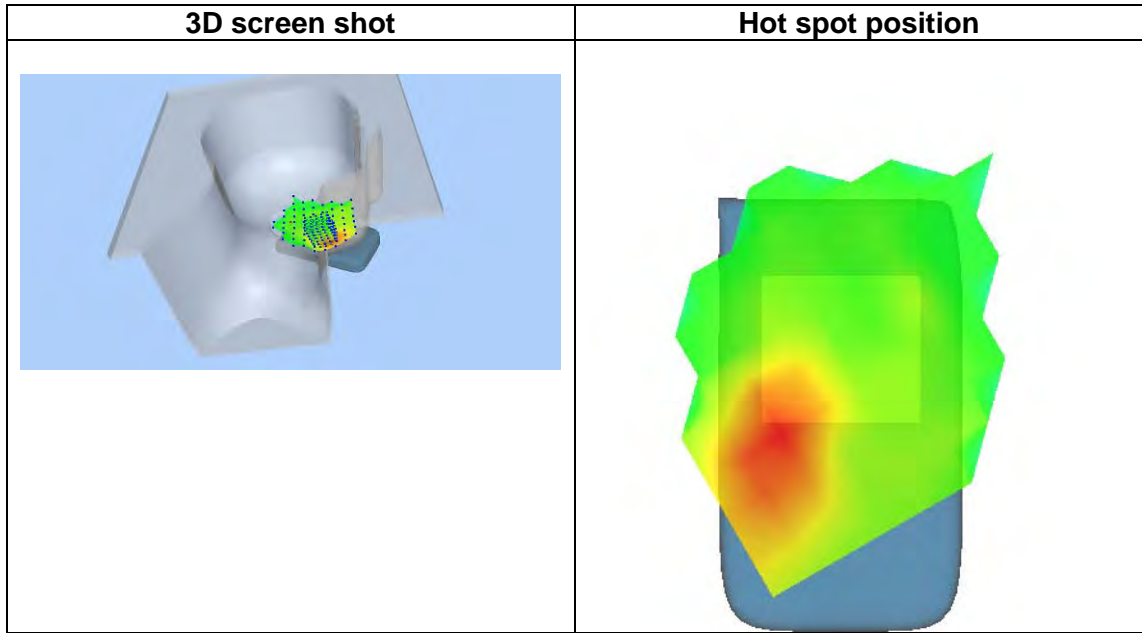
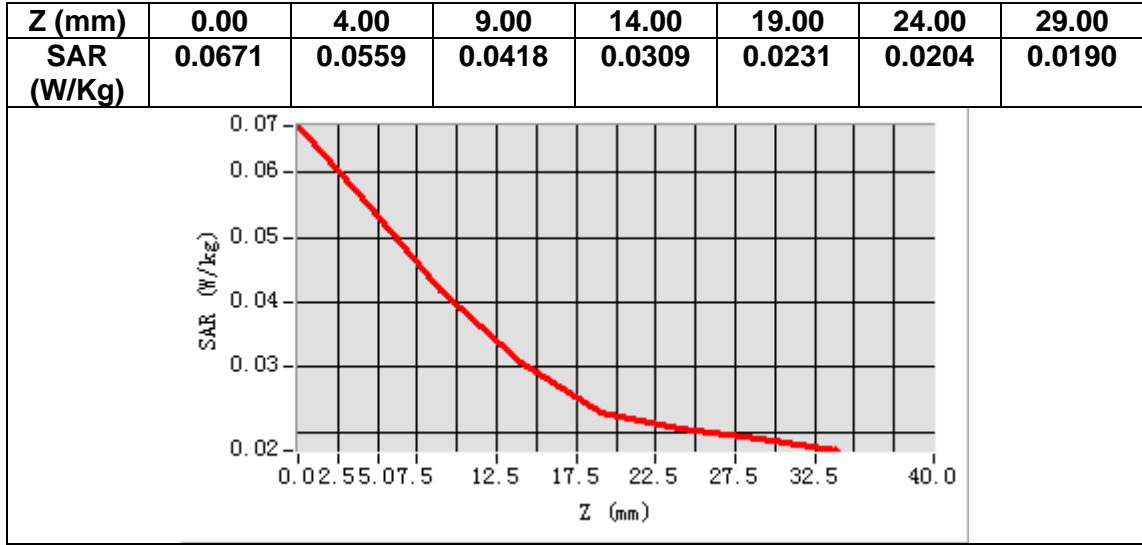

MEASUREMENT 4

A. Experimental conditions.

Area Scan	<u>dx=15mm dy=15mm, h= 5.00 mm</u>
ZoomScan	<u>5x5x7,dx=8mm dy=8mm dz=5mm</u>
Phantom	<u>Validation plane</u>
Device Position	<u>Body</u>
Band	<u>GSM1900</u>
Channels	<u>Middle</u>
Signal	<u>TDMA (Crest factor: 2.7)</u>

B. SAR Measurement Results

Frequency (MHz)	1880.000000
Relative permittivity (real part)	54.323898
Relative permittivity (imaginary part)	14.577700
Conductivity (S/m)	1.522560
Variation (%)	-3.620000

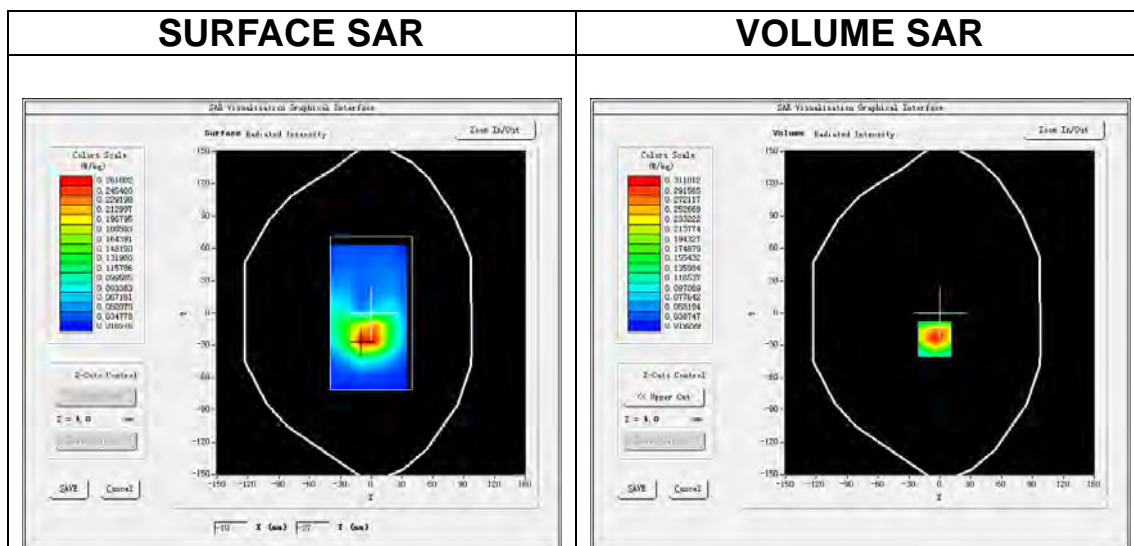

Maximum location: X=-5.00, Y=-24.00

SAR Peak: 0.49 W/kg

SAR 10g (W/Kg)	0.161419
SAR 1g (W/Kg)	0.295738

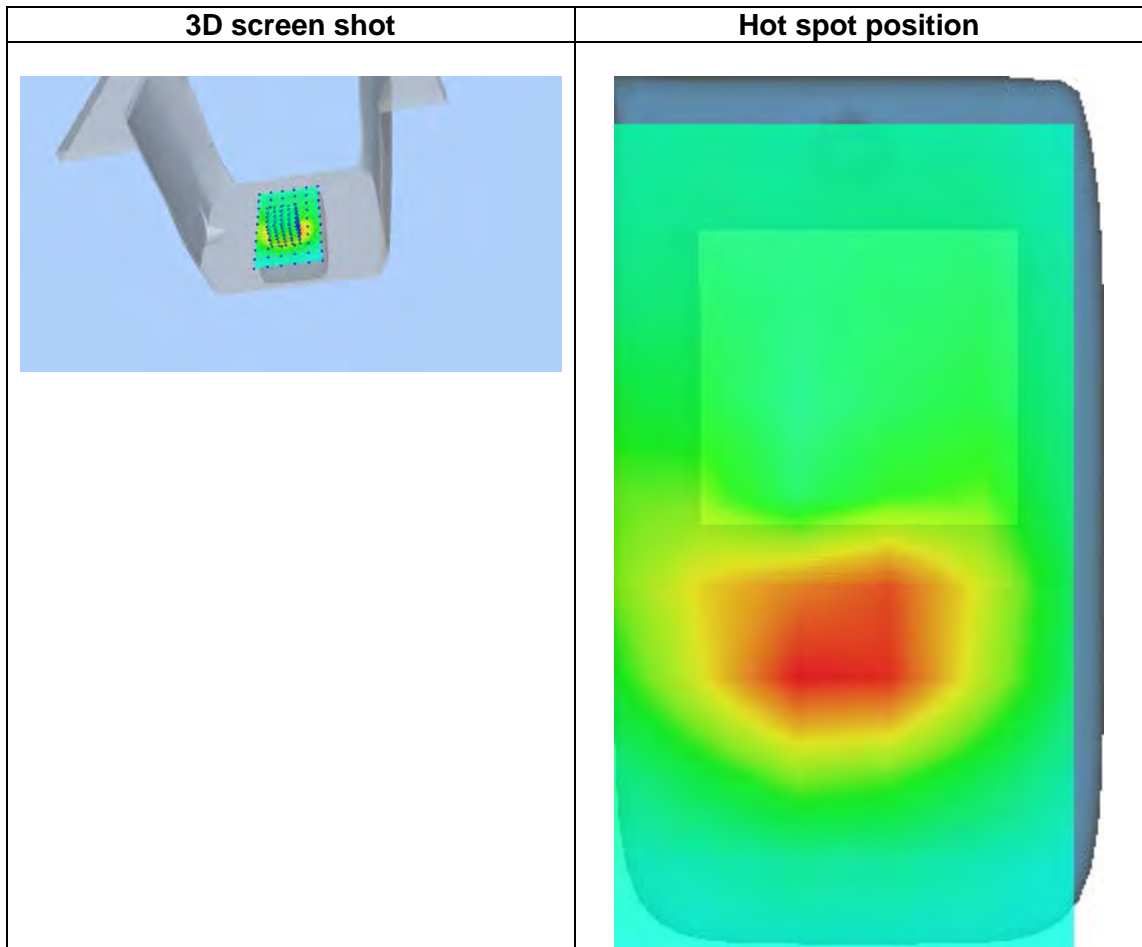
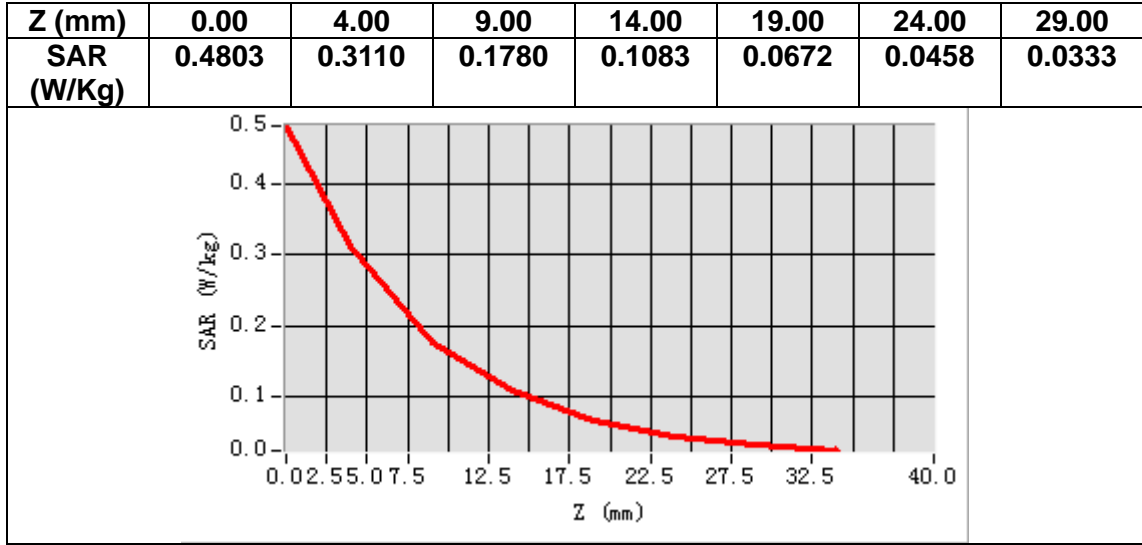

MEASUREMENT 5

A. Experimental conditions.

Area Scan	<u>dx=15mm dy=15mm, h= 5.00 mm</u>
ZoomScan	<u>5x5x7,dx=8mm dy=8mm dz=5mm</u>
Phantom	<u>Left head</u>
Device Position	<u>Cheek</u>
Band	<u>Band2_WCDMA1900</u>
Channels	<u>Middle</u>
Signal	<u>WCDMA (Crest factor: 1.0)</u>

B. SAR Measurement Results

Frequency (MHz)	1880.000000
Relative permittivity (real part)	39.016998
Relative permittivity (imaginary part)	13.260200
Conductivity (S/m)	1.384954
Variation (%)	-1.310000

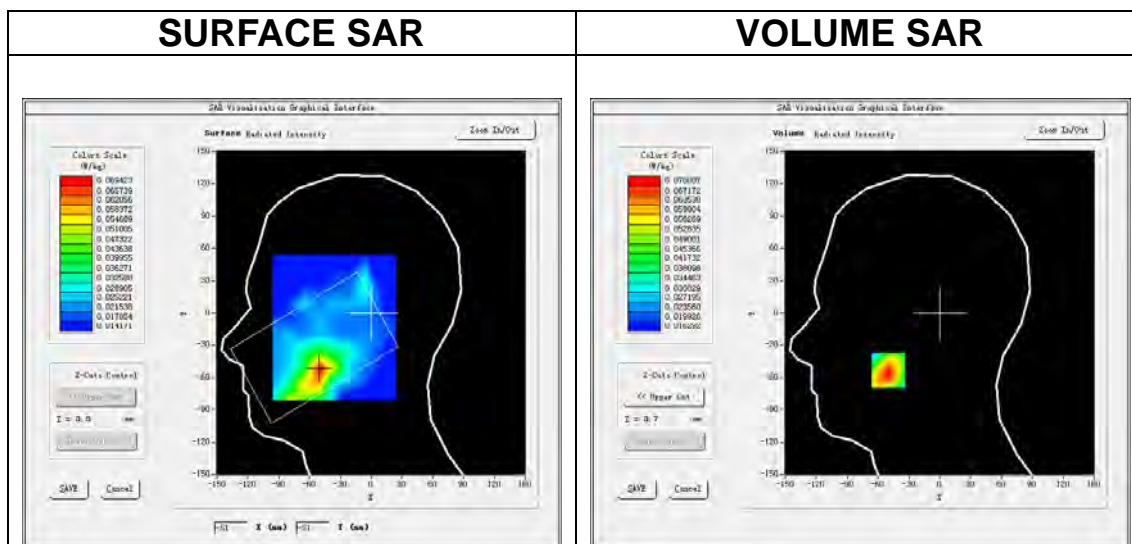

Maximum location: X=-50.00, Y=-53.00

SAR Peak: 0.11 W/kg

SAR 10g (W/Kg)	0.045634
SAR 1g (W/Kg)	0.069391

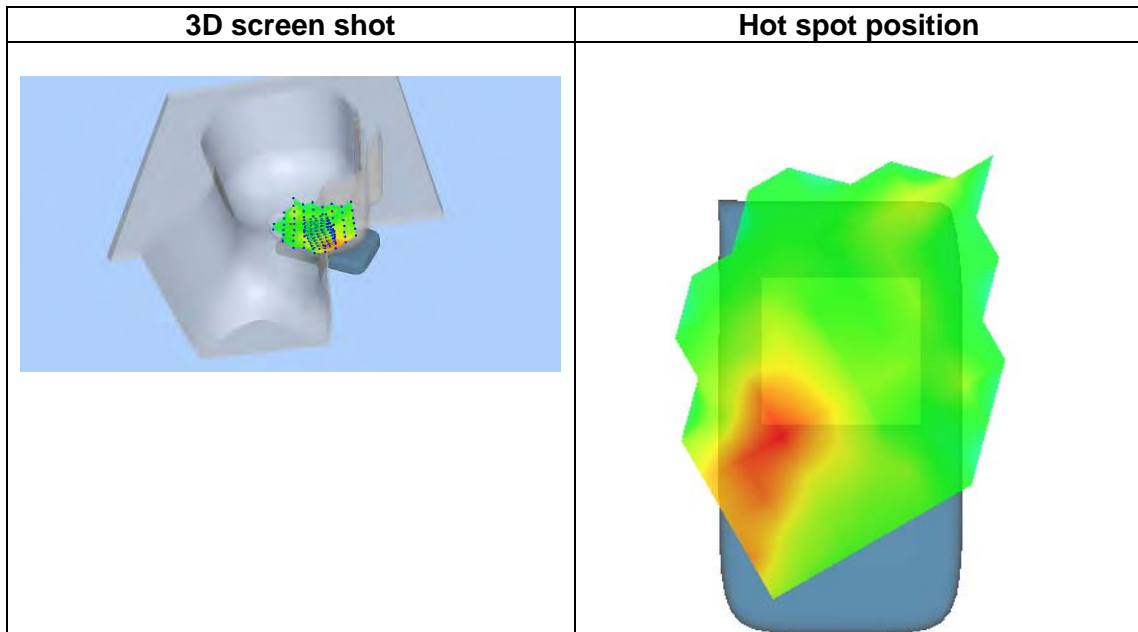
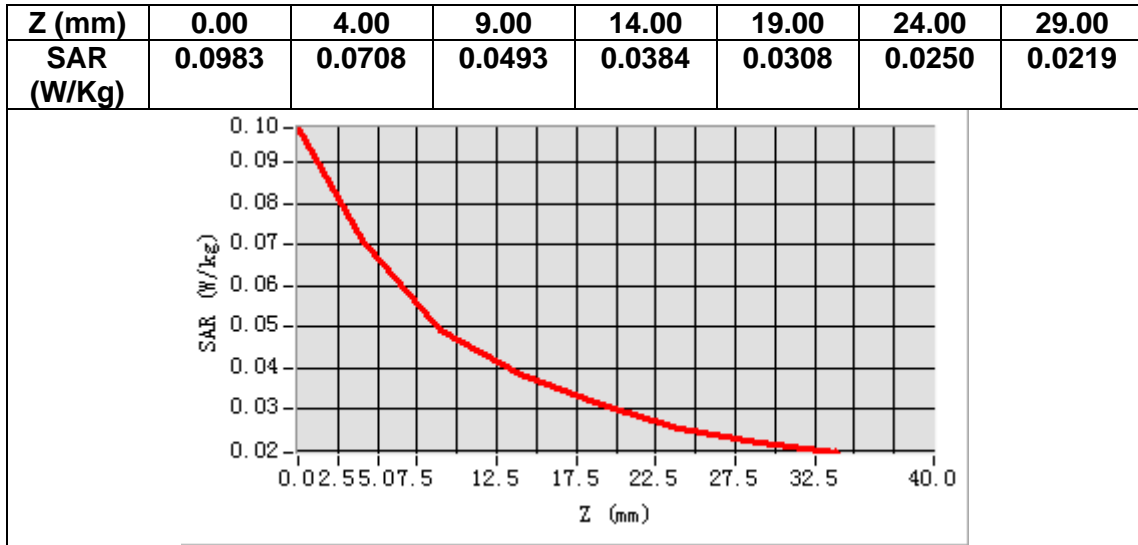

MEASUREMENT 6

A. Experimental conditions.

Area Scan	<u>dx=15mm dy=15mm, h= 5.00 mm</u>
ZoomScan	<u>5x5x7,dx=8mm dy=8mm dz=5mm</u>
Phantom	<u>Validation plane</u>
Device Position	<u>Body</u>
Band	<u>Band2_WCDMA1900</u>
Channels	<u>Middle</u>
Signal	<u>WCDMA (Crest factor: 1.0)</u>

B. SAR Measurement Results

Frequency (MHz)	1880.000000
Relative permittivity (real part)	54.323898
Relative permittivity (imaginary part)	14.577700
Conductivity (S/m)	1.522560
Variation (%)	-2.790000

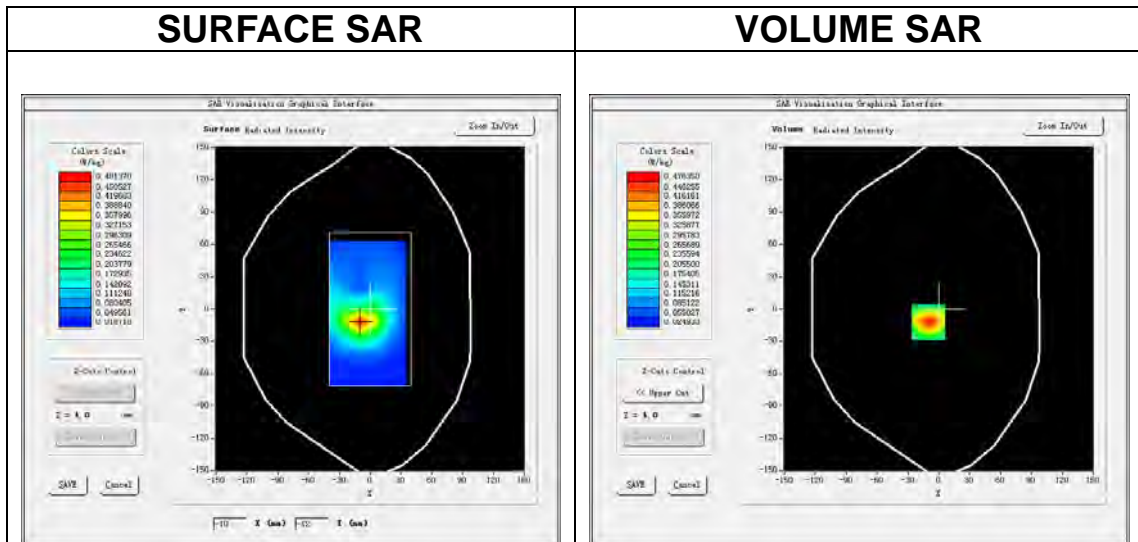

Maximum location: X=-10.00, Y=-12.00

SAR Peak: 0.73 W/kg

SAR 10g (W/Kg)	0.241157
SAR 1g (W/Kg)	0.446901

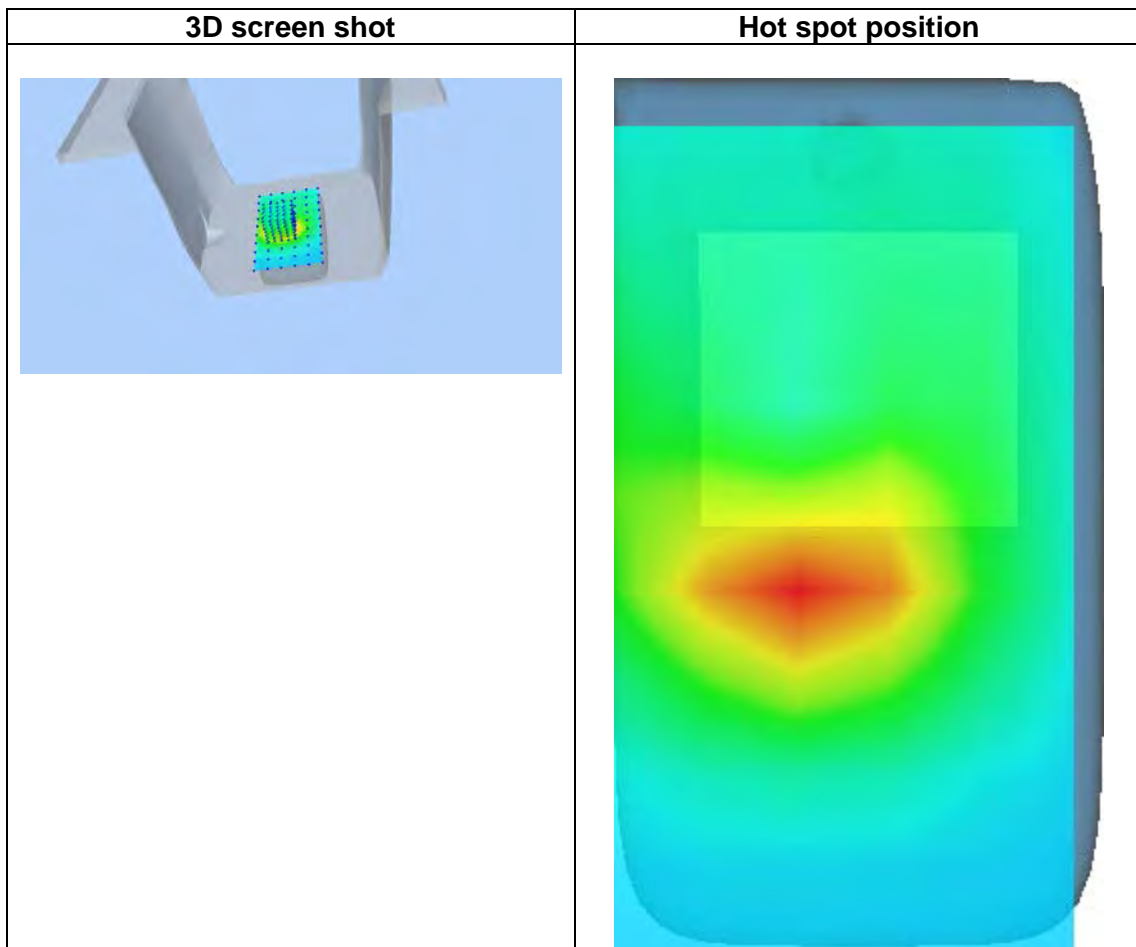
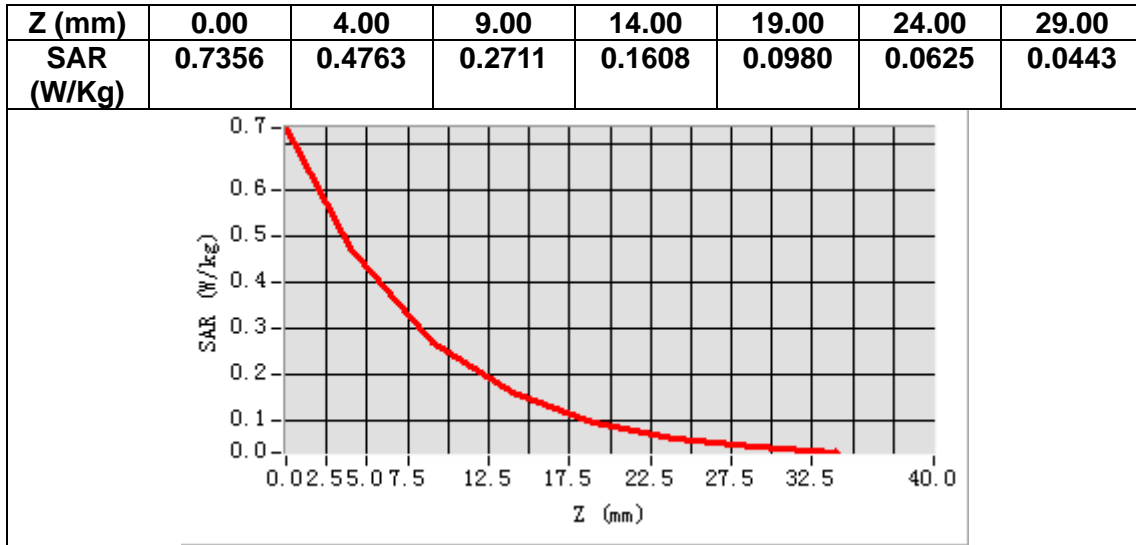

MEASUREMENT 7

A. Experimental conditions.

Area Scan	<u>dx=15mm dy=15mm, h= 5.00 mm</u>
ZoomScan	<u>5x5x7,dx=8mm dy=8mm dz=5mm</u>
Phantom	<u>Left head</u>
Device Position	<u>Cheek</u>
Band	<u>Band4 WCDMA1700</u>
Channels	<u>Middle</u>
Signal	<u>WCDMA (Crest factor: 1.0)</u>

B. SAR Measurement Results

Frequency (MHz)	1732.600000
Relative permittivity (real part)	39.065289
Relative permittivity (imaginary part)	13.760592
Conductivity (S/m)	1.324457
Variation (%)	2.000000

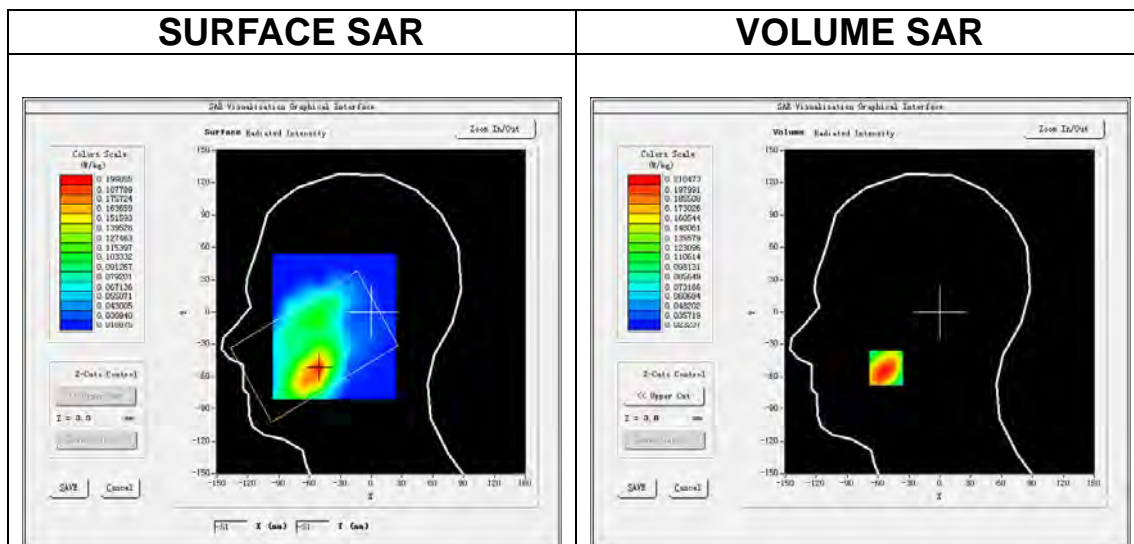

Maximum location: X=-52.00, Y=-52.00

SAR Peak: 0.29 W/kg

SAR 10g (W/Kg)	0.132413
SAR 1g (W/Kg)	0.204045

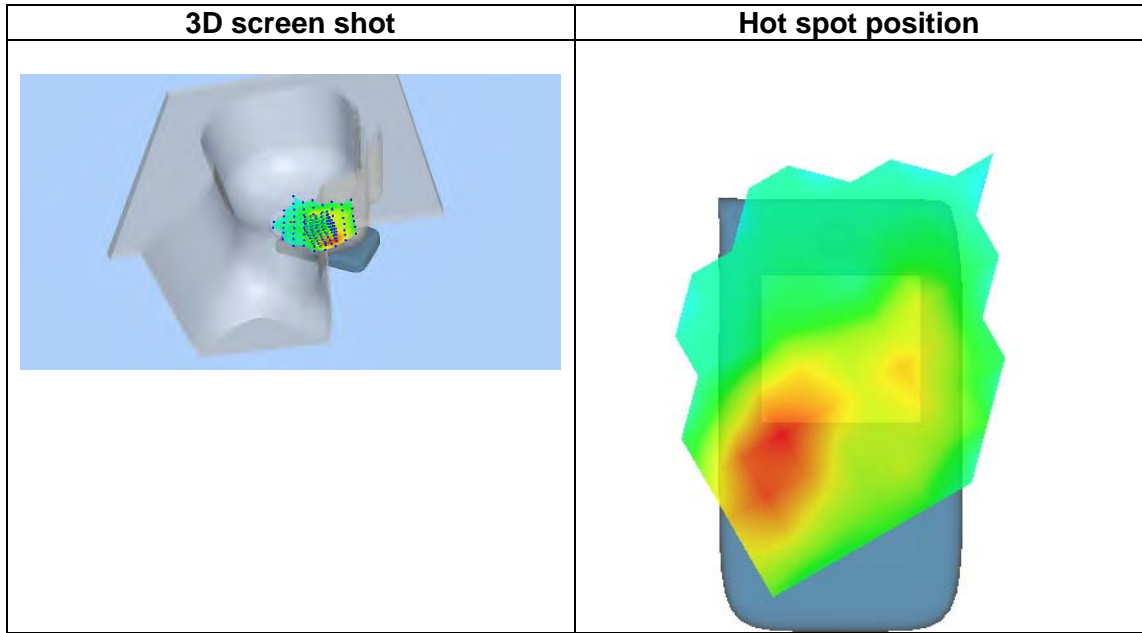
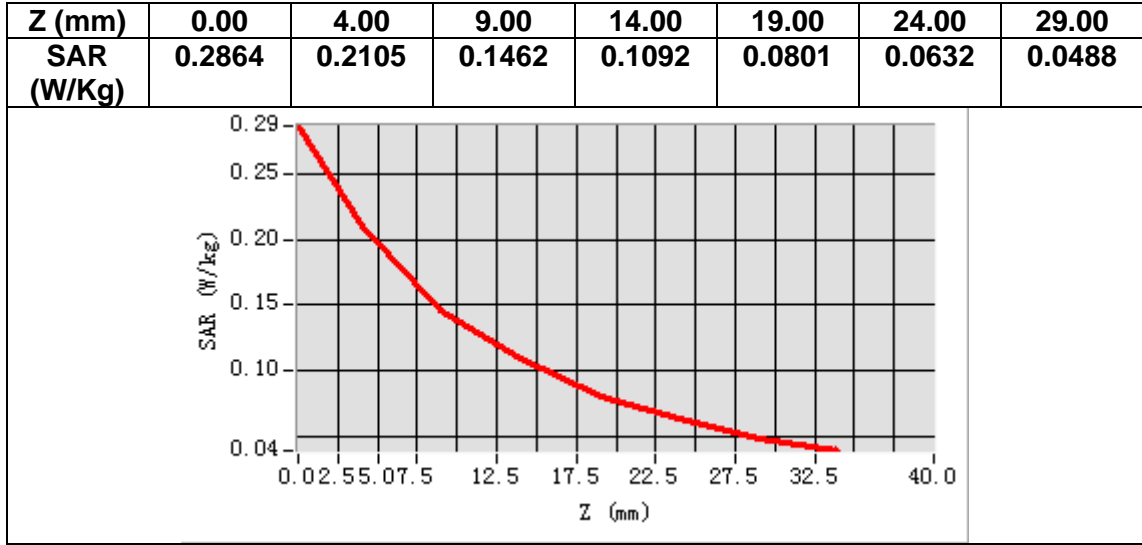

MEASUREMENT 8

A. Experimental conditions.

Area Scan	<u>dx=15mm dy=15mm, h= 5.00 mm</u>
ZoomScan	<u>5x5x7,dx=8mm dy=8mm dz=5mm</u>
Phantom	<u>Validation plane</u>
Device Position	<u>Body</u>
Band	<u>Band4 WCDMA1700</u>
Channels	<u>Middle</u>
Signal	<u>WCDMA (Crest factor: 1.0)</u>

B. SAR Measurement Results

Frequency (MHz)	1732.600000
Relative permittivity (real part)	54.468365
Relative permittivity (imaginary part)	15.148220
Conductivity (S/m)	1.458016
Variation (%)	-0.910000

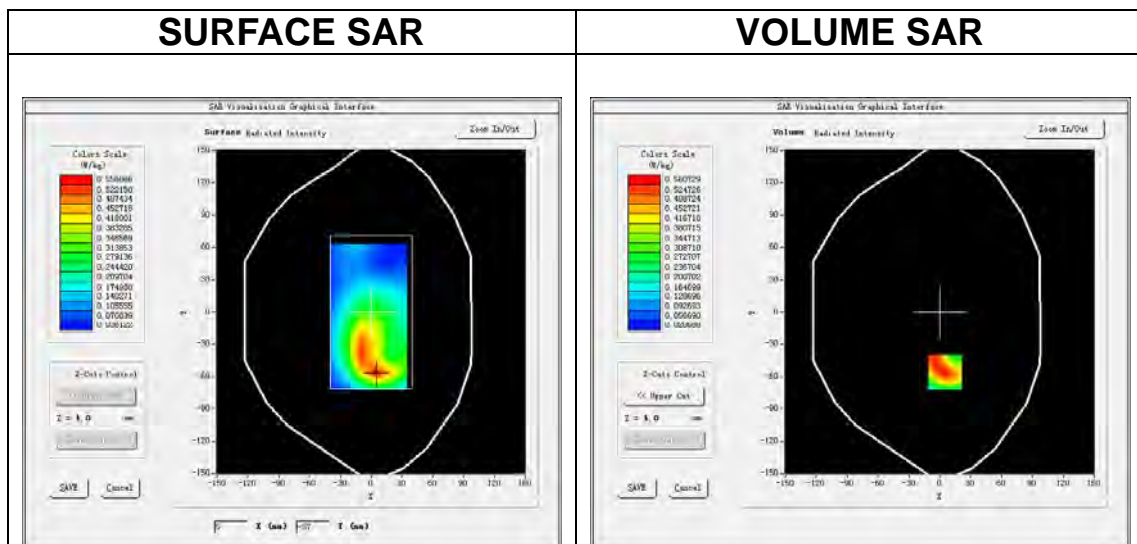

Maximum location: X=5.00, Y=-56.00

SAR Peak: 0.79 W/kg

SAR 10g (W/Kg)	0.321306
SAR 1g (W/Kg)	0.528993

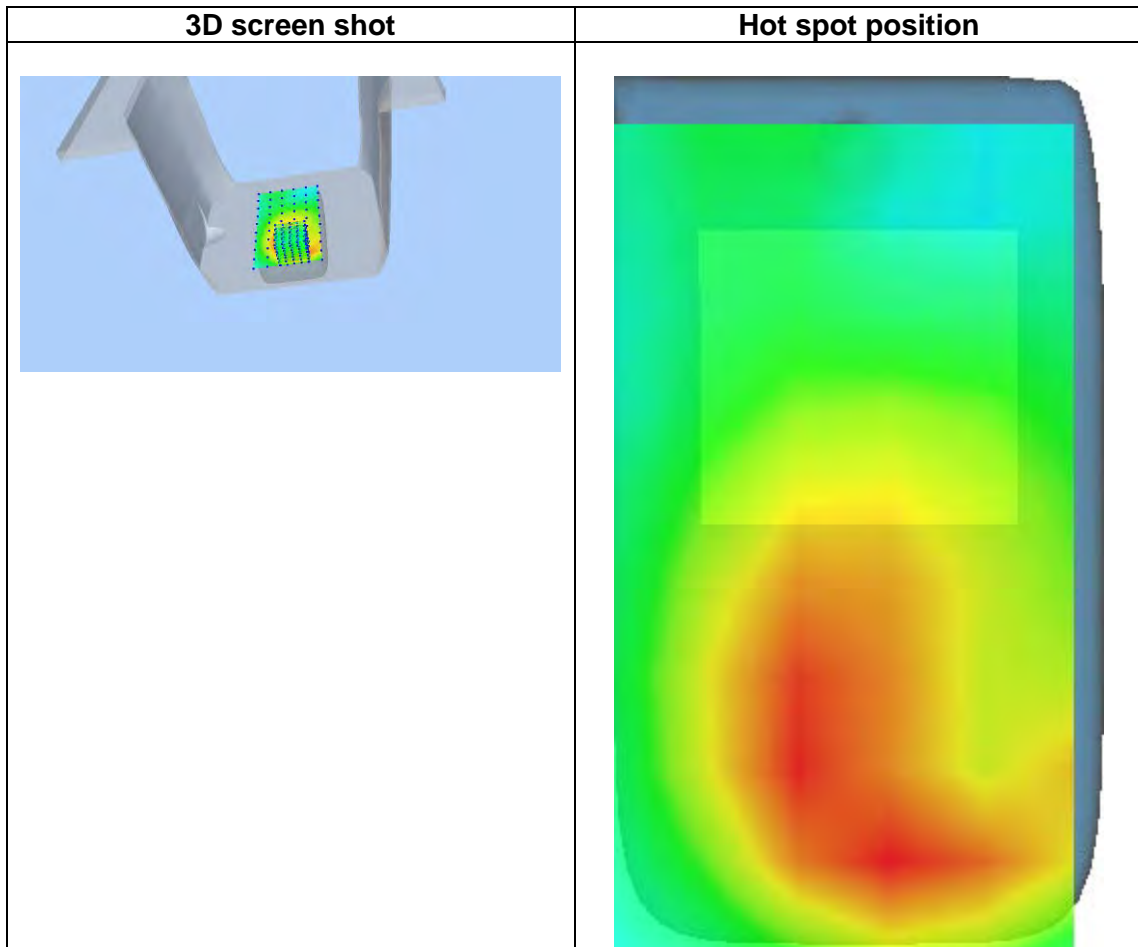
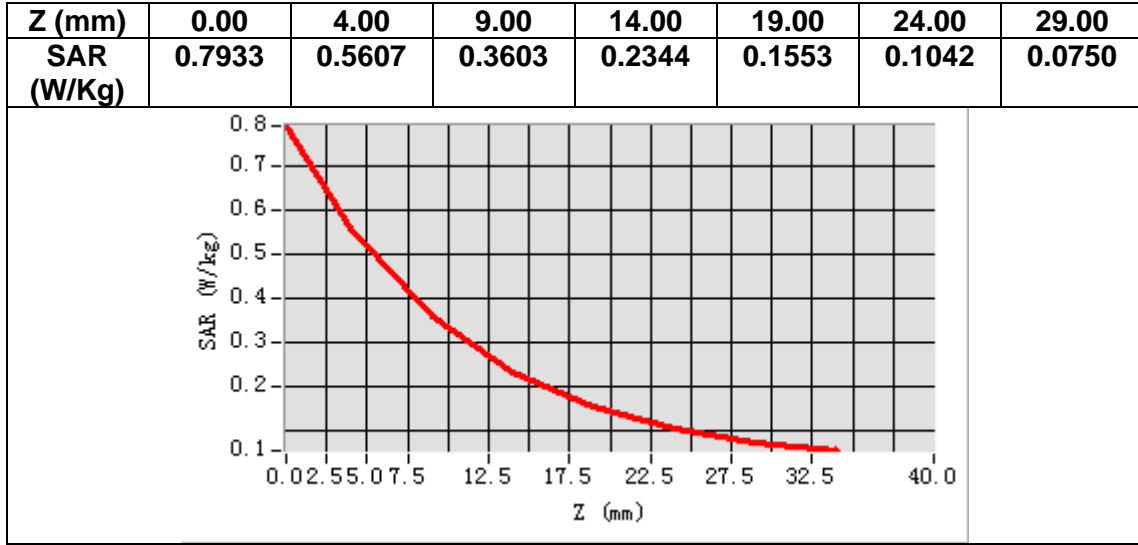

MEASUREMENT 9

A. Experimental conditions.

Area Scan	<u>dx=15mm dy=15mm, h= 5.00 mm</u>
ZoomScan	<u>5x5x7,dx=8mm dy=8mm dz=5mm</u>
Phantom	<u>Left head</u>
Device Position	<u>Cheek</u>
Band	<u>Band5_WCDMA850</u>
Channels	<u>Middle</u>
Signal	<u>WCDMA (Crest factor: 1.0)</u>

B. SAR Measurement Results

Frequency (MHz)	836.400000
Relative permittivity (real part)	40.690960
Relative permittivity (imaginary part)	19.971540
Conductivity (S/m)	0.928011
Variation (%)	-0.100000

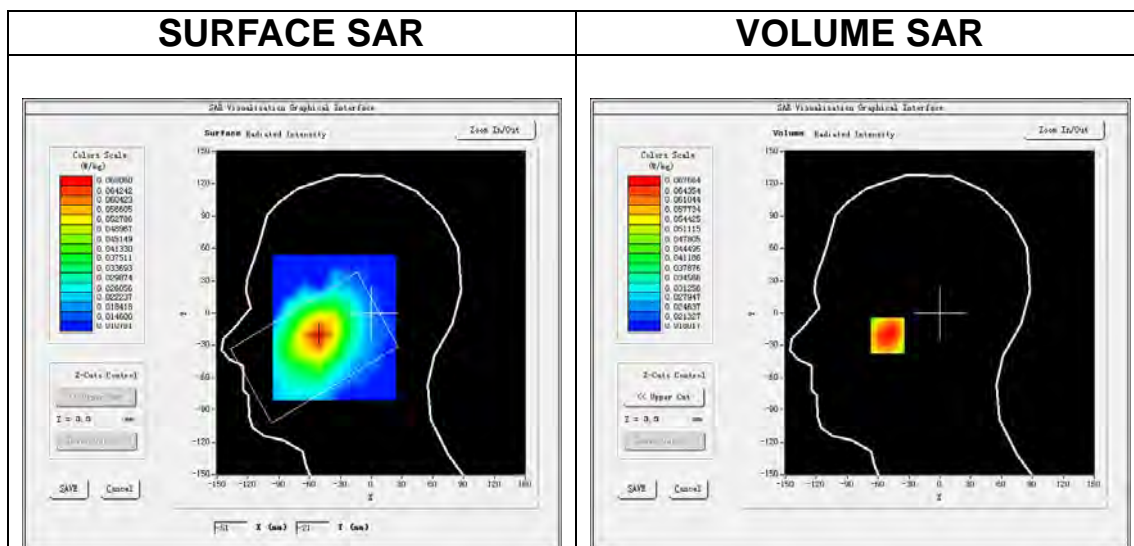

Maximum location: X=-51.00, Y=-21.00

SAR Peak: 0.08 W/kg

SAR 10g (W/Kg)	0.052893
SAR 1g (W/Kg)	0.066860

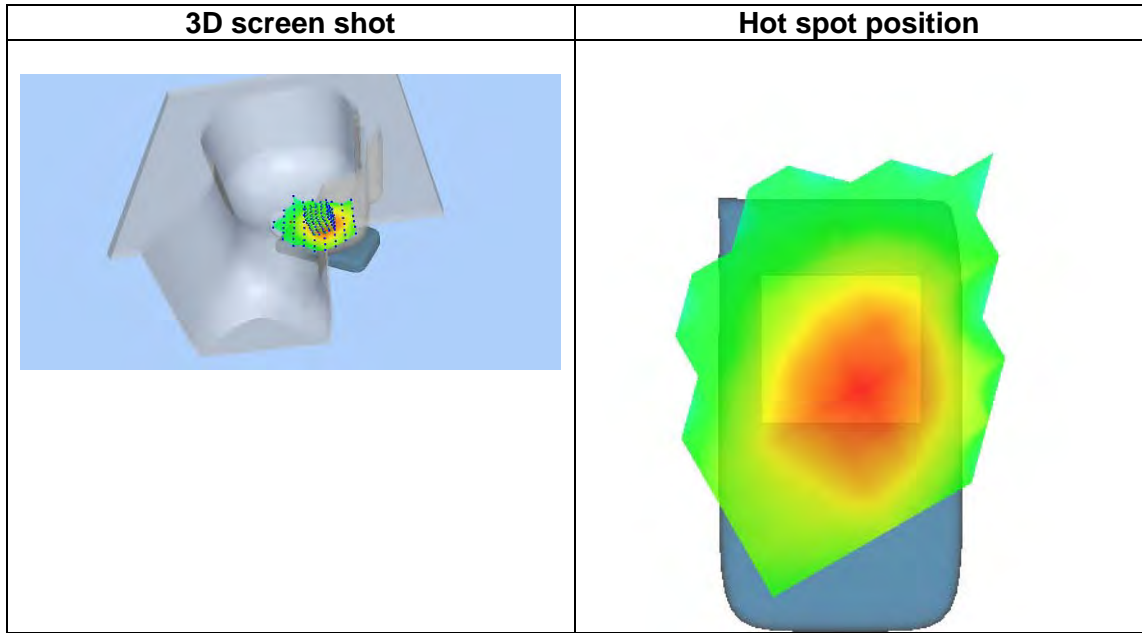
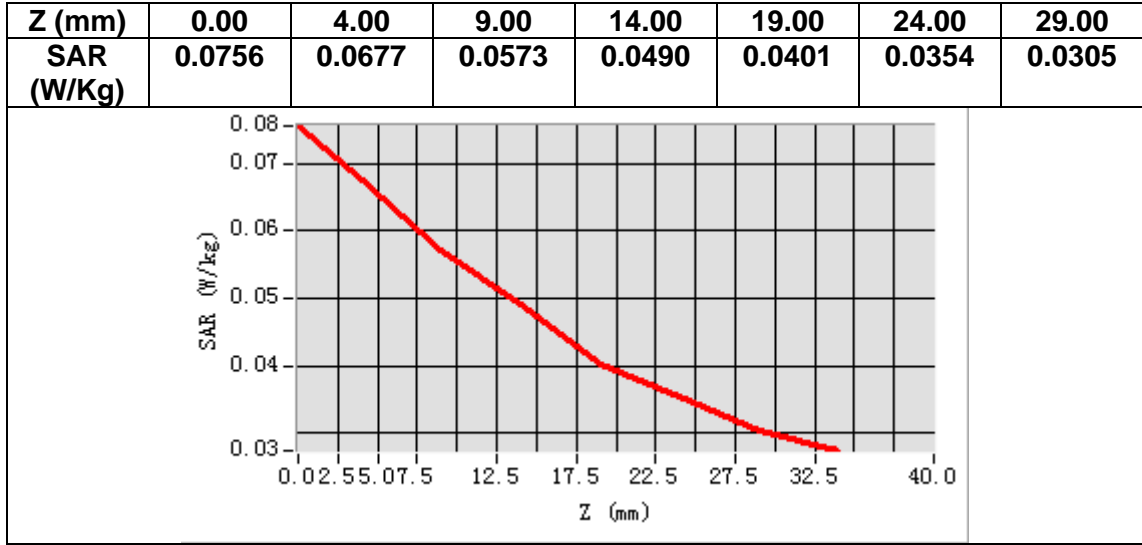

MEASUREMENT 10

A. Experimental conditions.

Area Scan	<u>dx=15mm dy=15mm, h= 5.00 mm</u>
ZoomScan	<u>5x5x7,dx=8mm dy=8mm dz=5mm</u>
Phantom	<u>Validation plane</u>
Device Position	<u>Body</u>
Band	<u>Band5_WCDMA850</u>
Channels	<u>Middle</u>
Signal	<u>WCDMA (Crest factor: 1.0)</u>

B. SAR Measurement Results

Frequency (MHz)	836.400000
Relative permittivity (real part)	54.519581
Relative permittivity (imaginary part)	21.172741
Conductivity (S/m)	0.983827
Variation (%)	-1.360000

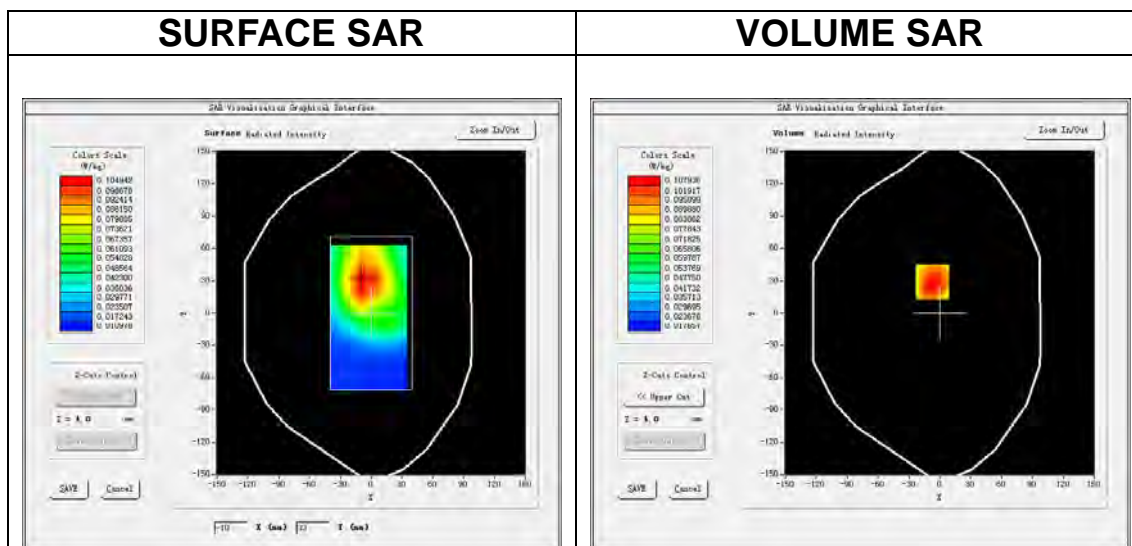

Maximum location: X=-7.00, Y=29.00

SAR Peak: 0.14 W/kg

SAR 10g (W/Kg)	0.076309
SAR 1g (W/Kg)	0.105778

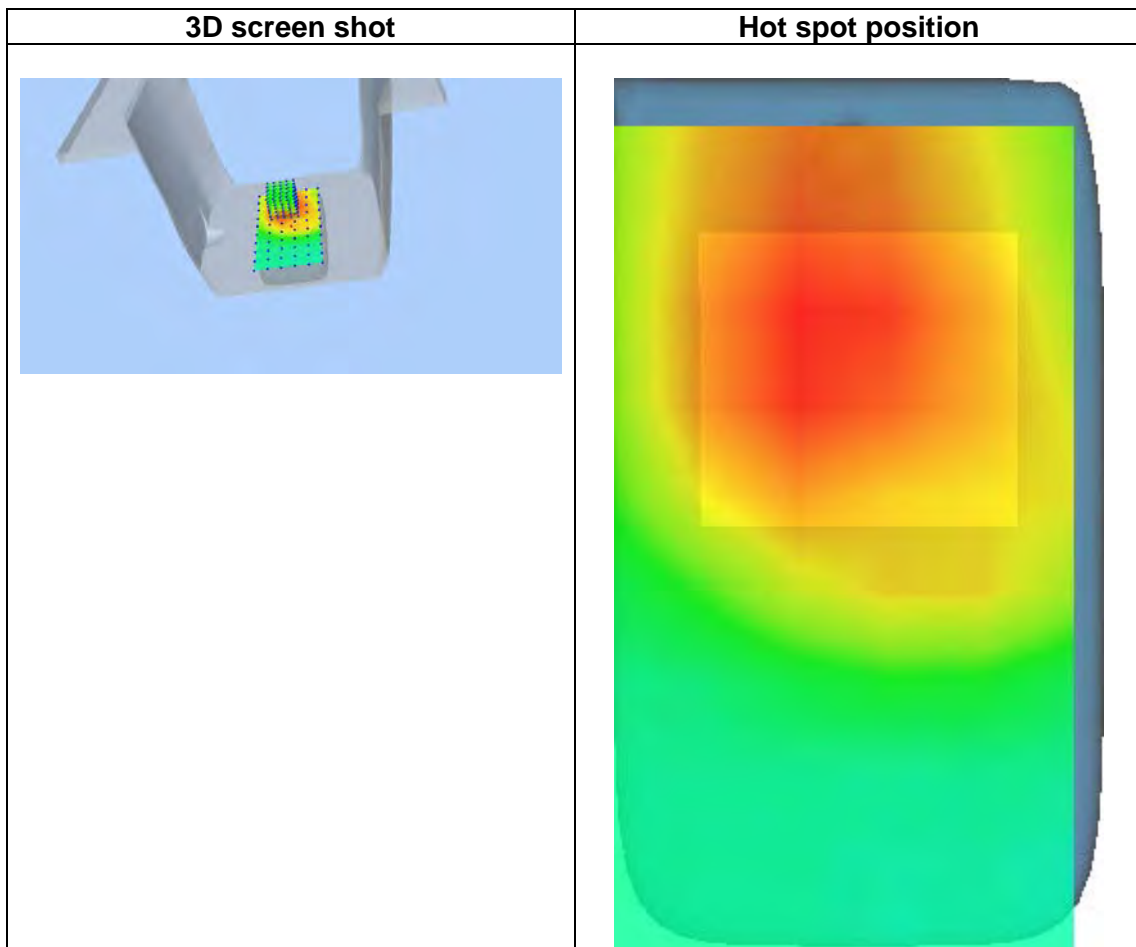
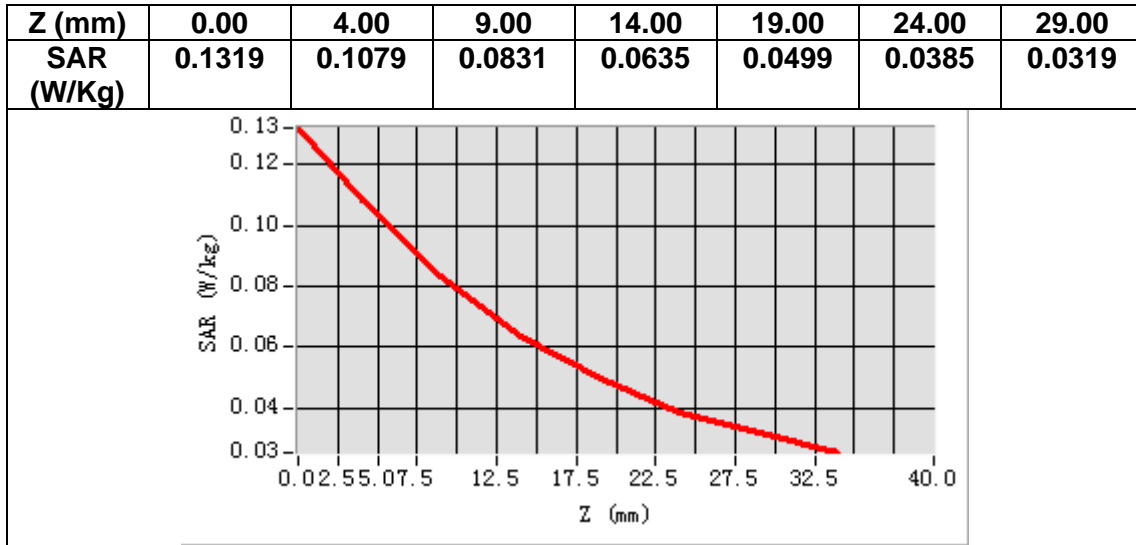

MEASUREMENT 11

A. Experimental conditions.

Area Scan	<u>dx=12mm dy=12mm, h= 5.00 mm</u>
ZoomScan	<u>7x7x7,dx=5mm dy=5mm dz=5mm</u>
Phantom	<u>Left head</u>
Device Position	<u>Cheek</u>
Band	<u>IEEE 802.11b ISM</u>
Channels	<u>Middle</u>
Signal	<u>IEEE802.11b (Crest factor: 1.0)</u>

B. SAR Measurement Results

Frequency (MHz)	2437.000000
Relative permittivity (real part)	38.577999
Relative permittivity (imaginary part)	13.480300
Conductivity (S/m)	1.825083
Variation (%)	-2.290000

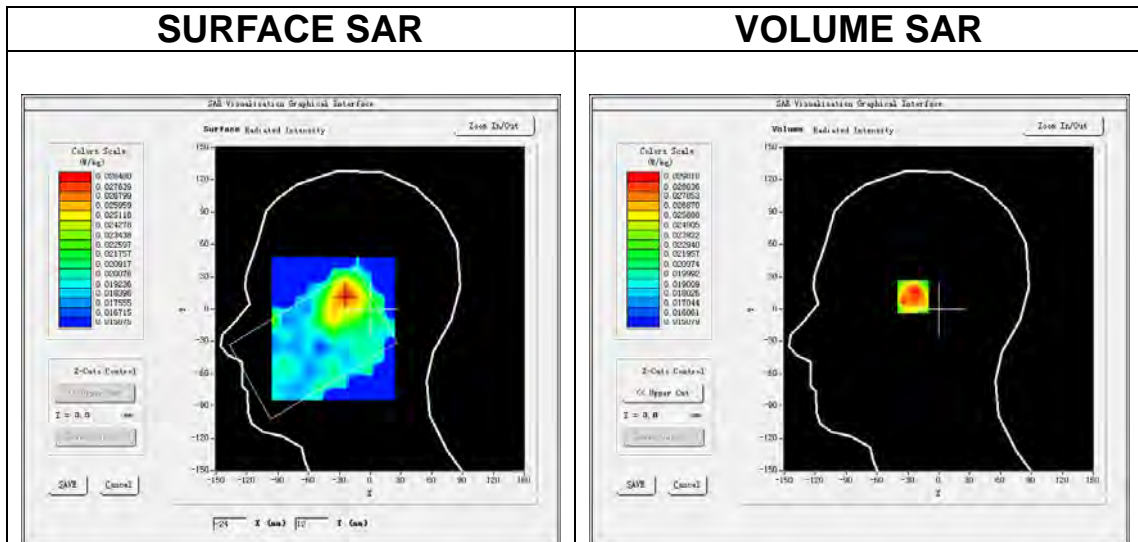

Maximum location: X=-24.00, Y=13.00

SAR Peak: 0.04 W/kg

SAR 10g (W/Kg)	0.023672
SAR 1g (W/Kg)	0.028757

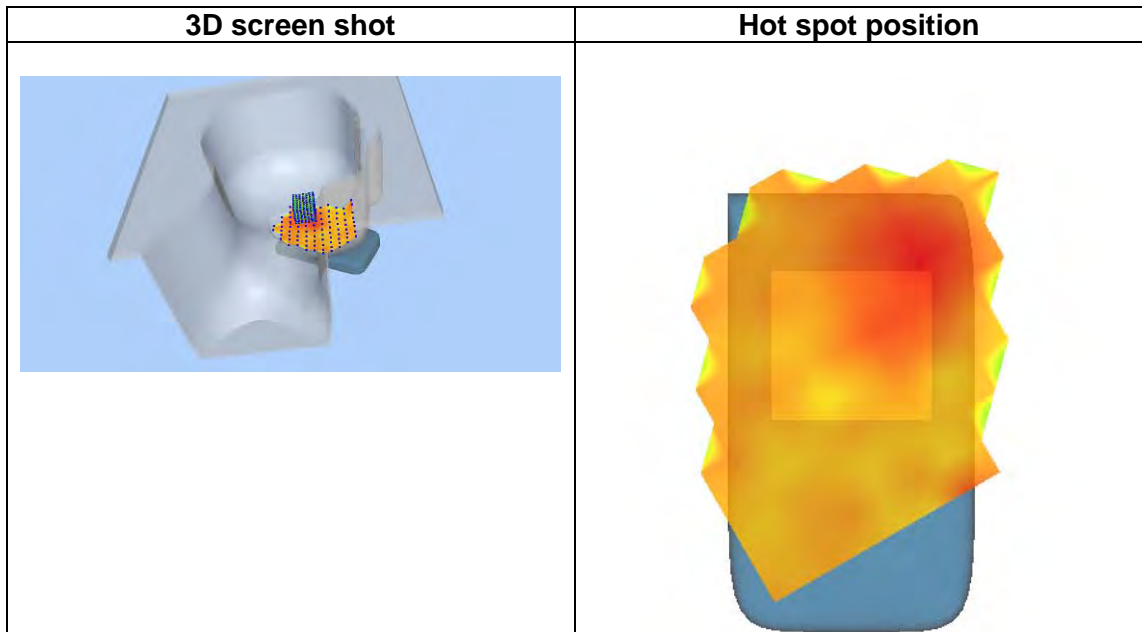
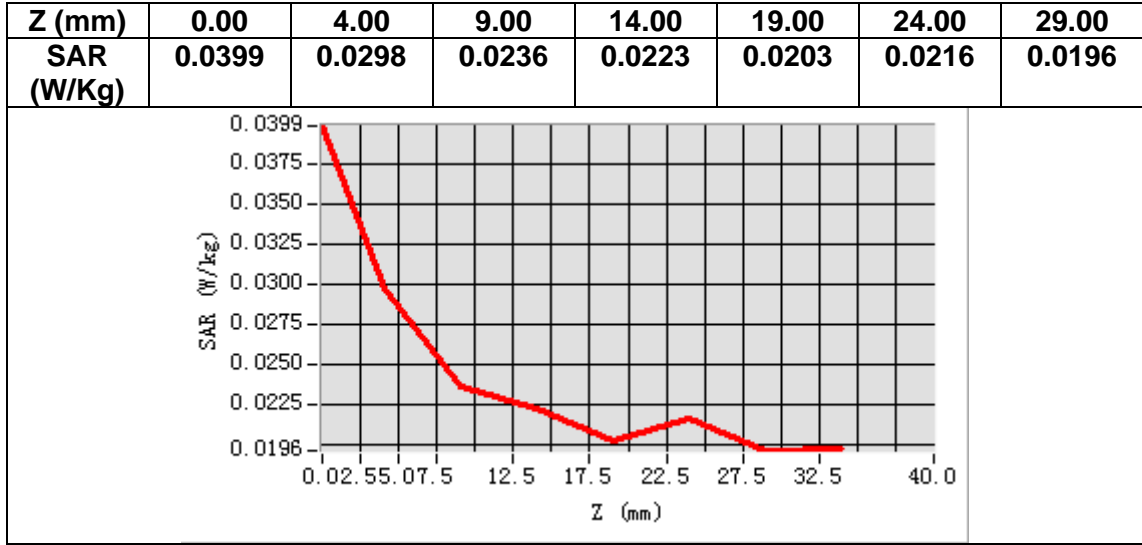

MEASUREMENT 12

A. Experimental conditions.

Area Scan	<u>dx=12mm dy=12mm, h= 5.00 mm</u>
ZoomScan	<u>7x7x7,dx=5mm dy=5mm dz=5mm</u>
Phantom	<u>Validation plane</u>
Device Position	<u>Body</u>
Band	<u>IEEE 802.11b ISM</u>
Channels	<u>Middle</u>
Signal	<u>IEEE802.11b (Crest factor: 1.0)</u>

B. SAR Measurement Results

Frequency (MHz)	2437.000000
Relative permittivity (real part)	51.643700
Relative permittivity (imaginary part)	13.914400
Conductivity (S/m)	1.883855
Variation (%)	-4.010000

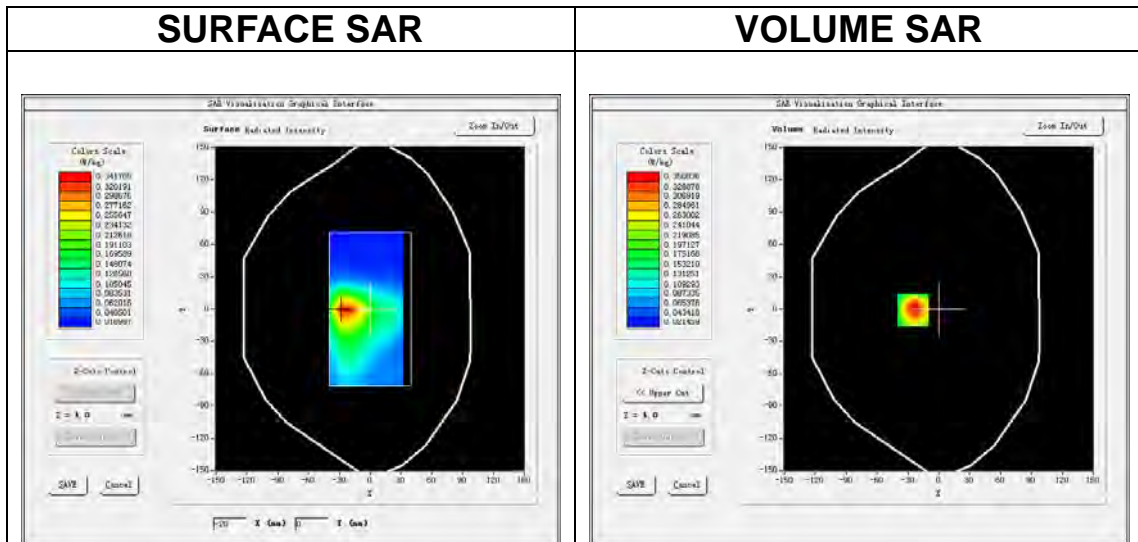

Maximum location: X=-25.00, Y=-1.00

SAR Peak: 0.60 W/kg

SAR 10g (W/Kg)	0.171647
SAR 1g (W/Kg)	0.334463

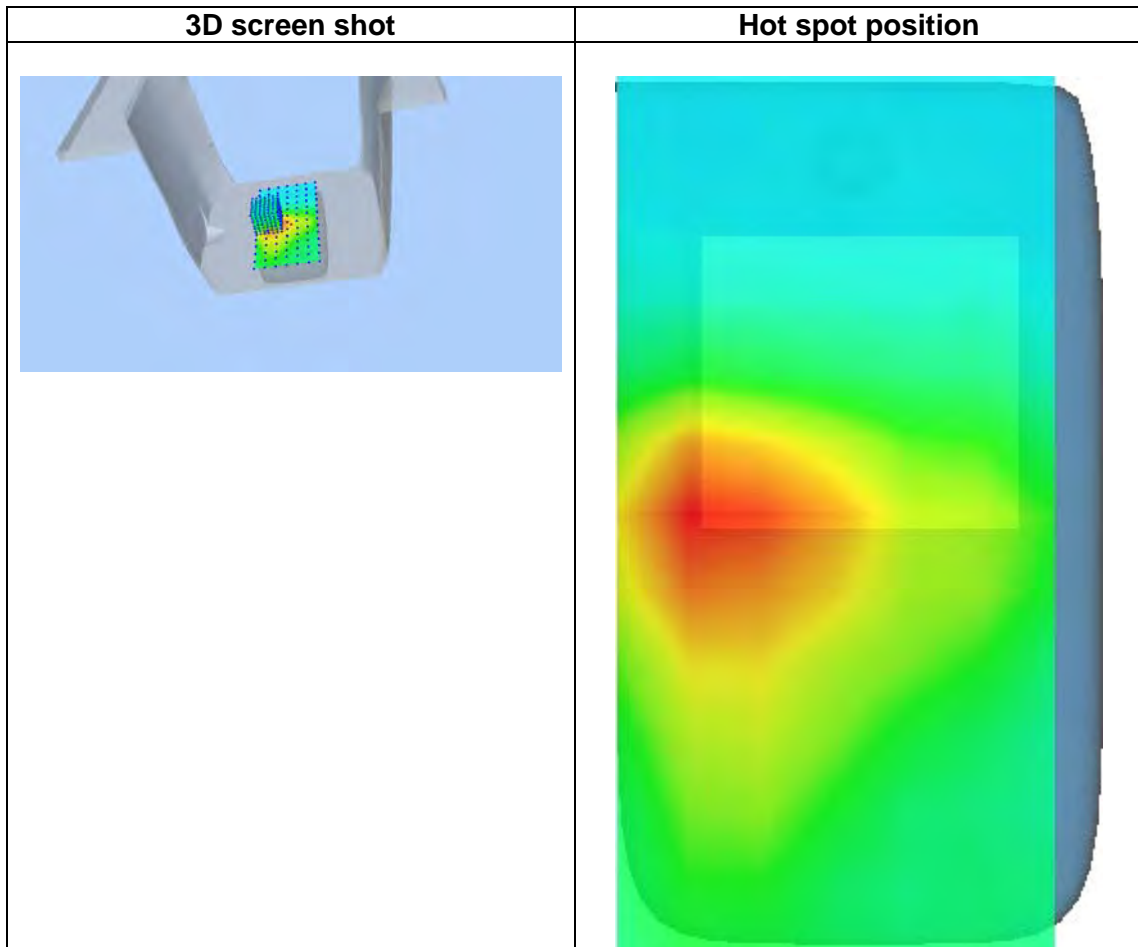
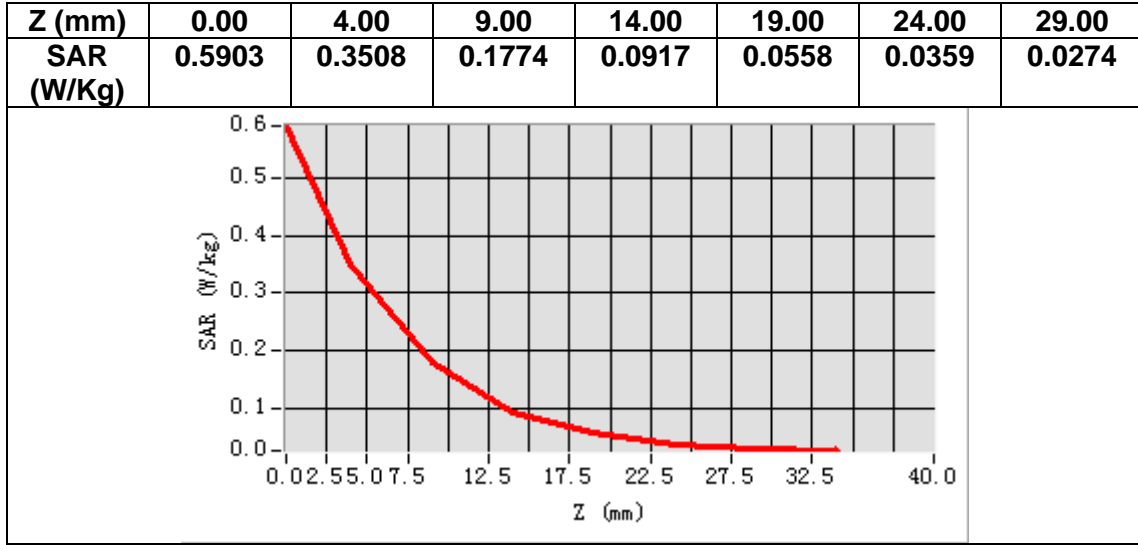

MEASUREMENT 13

A. Experimental conditions.

Area Scan	<u>dx=15mm dy=15mm, h= 5.00 mm</u>
ZoomScan	<u>5x5x7,dx=8mm dy=8mm dz=5mm</u>
Phantom	<u>Left head</u>
Device Position	<u>Cheek</u>
Band	<u>LTE band 2</u>
Channels	<u>Middle</u>
Signal	<u>LTE (Crest factor: 1.0)</u>

B. SAR Measurement Results

Frequency (MHz)	1880.000000
Relative permittivity (real part)	39.016998
Relative permittivity (imaginary part)	13.260200
Conductivity (S/m)	1.384954
Variation (%)	2.010000

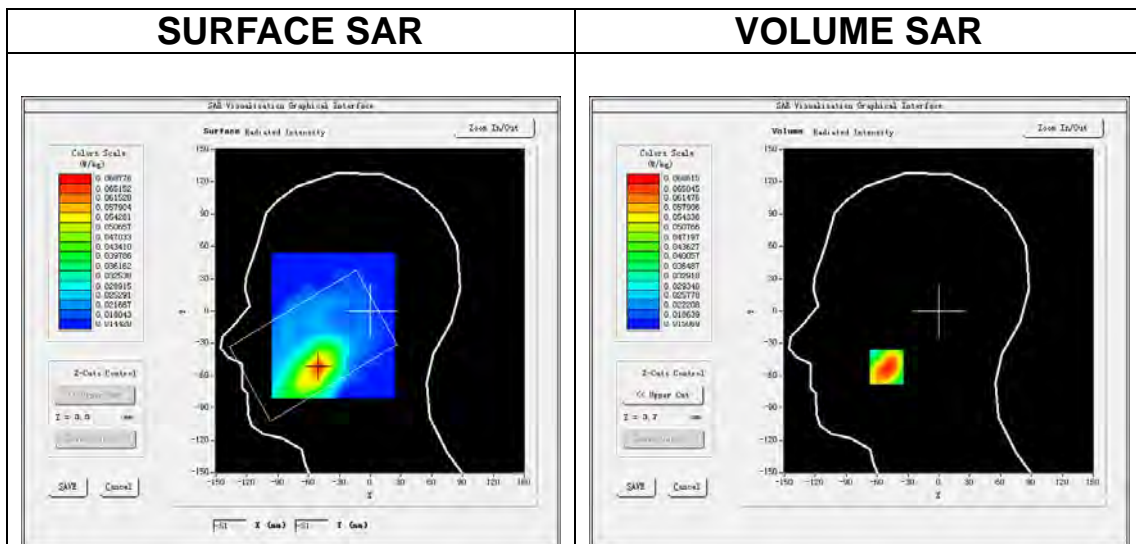

Maximum location: X=-51.00, Y=-52.00

SAR Peak: 0.10 W/kg

SAR 10g (W/Kg)	0.044205
SAR 1g (W/Kg)	0.065979

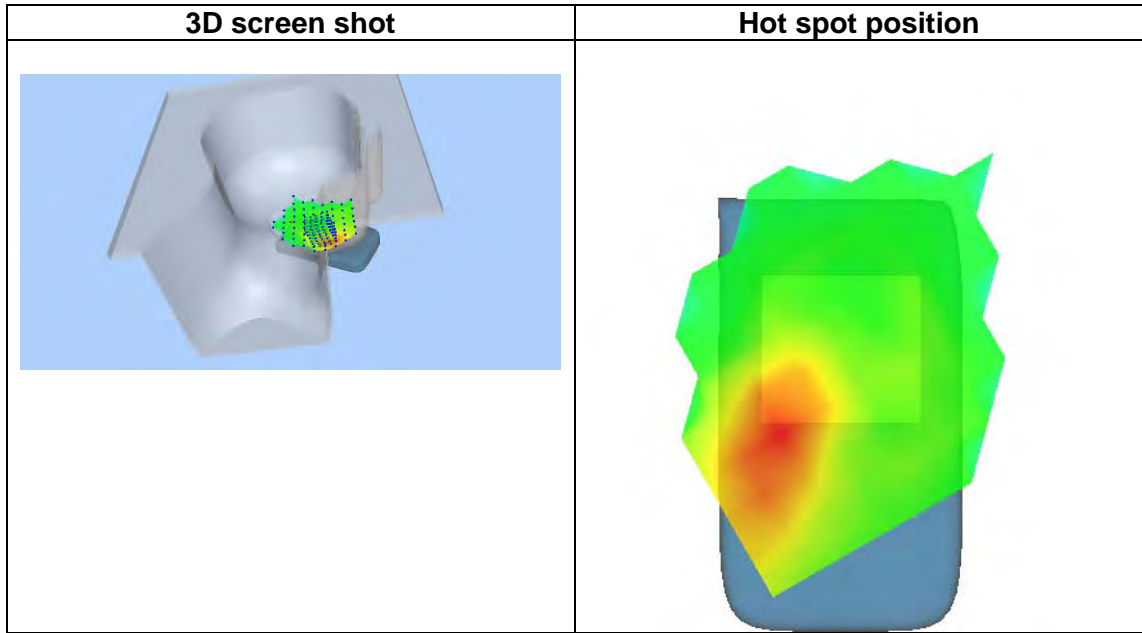
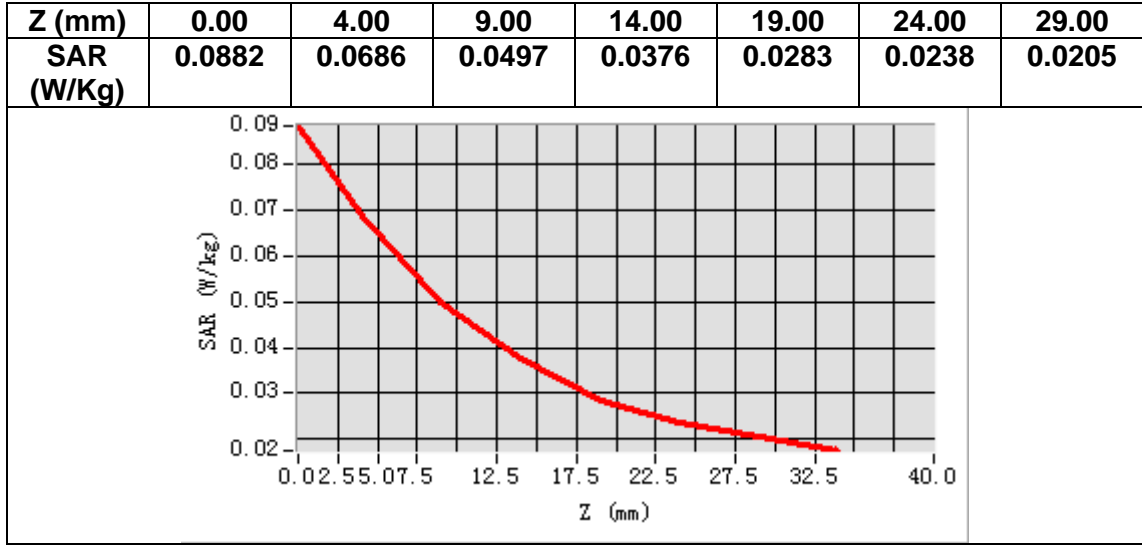

MEASUREMENT 14

A. Experimental conditions.

Area Scan	<u>dx=15mm dy=15mm, h= 5.00 mm</u>
ZoomScan	<u>5x5x7,dx=8mm dy=8mm dz=5mm</u>
Phantom	<u>Validation plane</u>
Device Position	<u>Body</u>
Band	<u>LTE band 2</u>
Channels	<u>Middle</u>
Signal	<u>LTE (Crest factor: 1.0)</u>

B. SAR Measurement Results

Frequency (MHz)	1880.000000
Relative permittivity (real part)	54.323898
Relative permittivity (imaginary part)	14.577700
Conductivity (S/m)	1.522560
Variation (%)	-0.730000

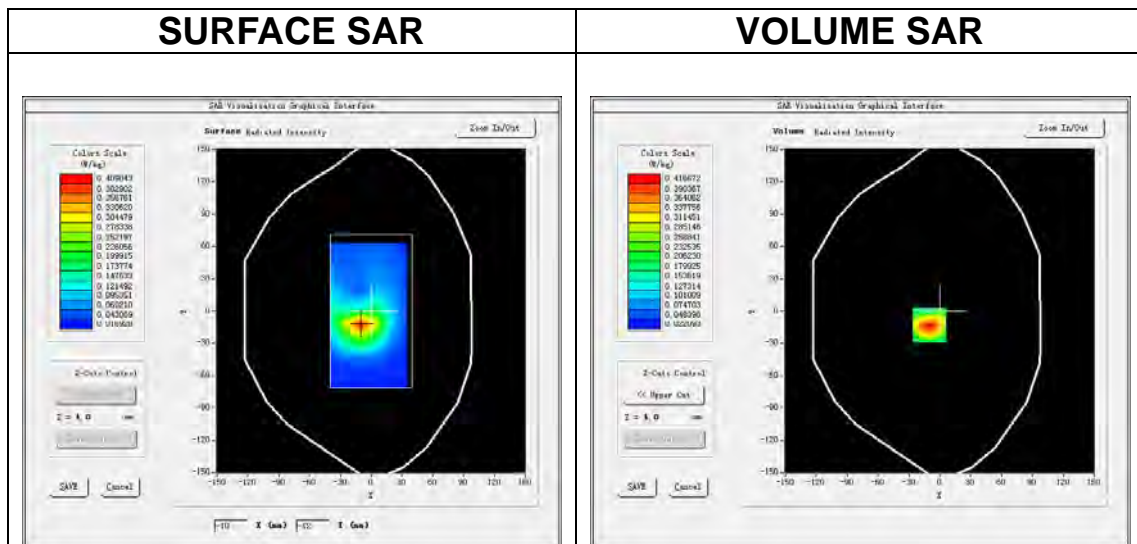

Maximum location: X=-10.00, Y=-13.00

SAR Peak: 0.64 W/kg

SAR 10g (W/Kg)	0.214665
SAR 1g (W/Kg)	0.394115

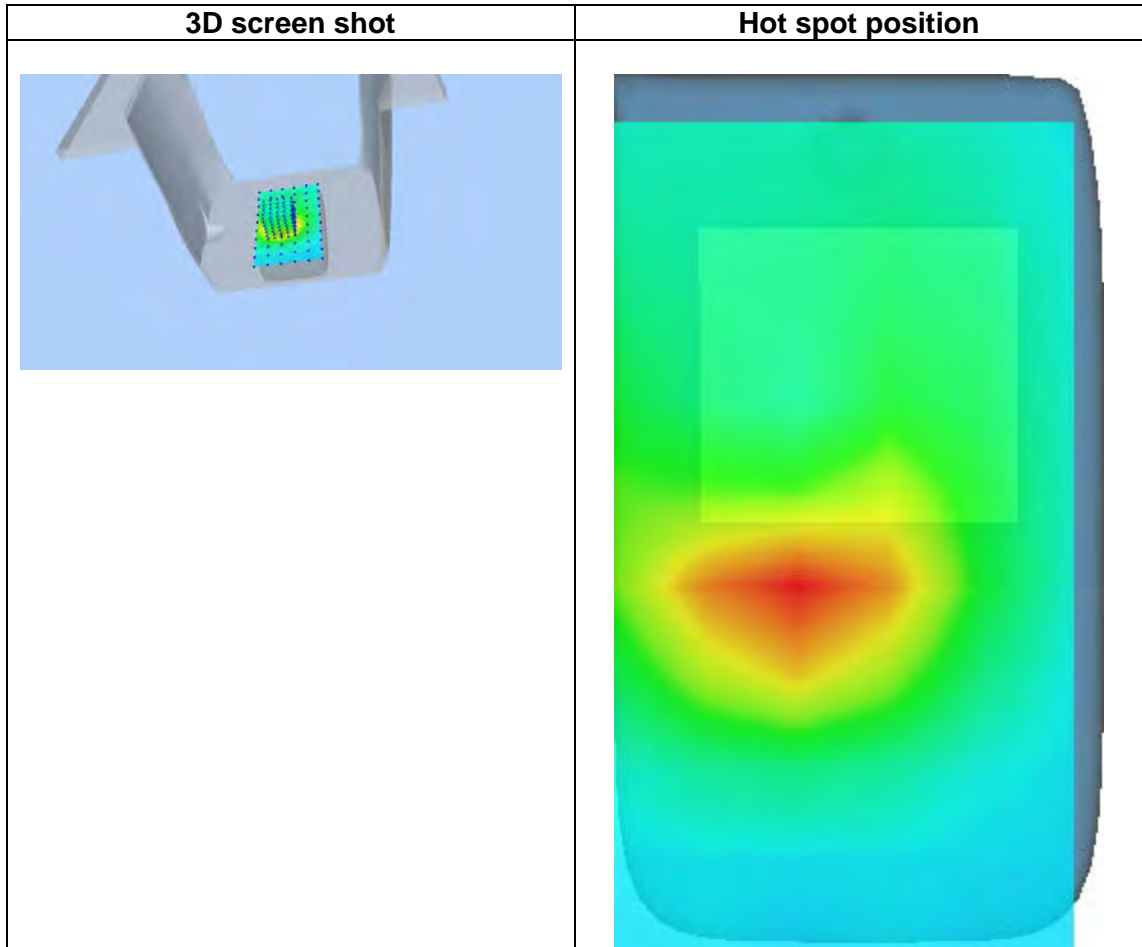
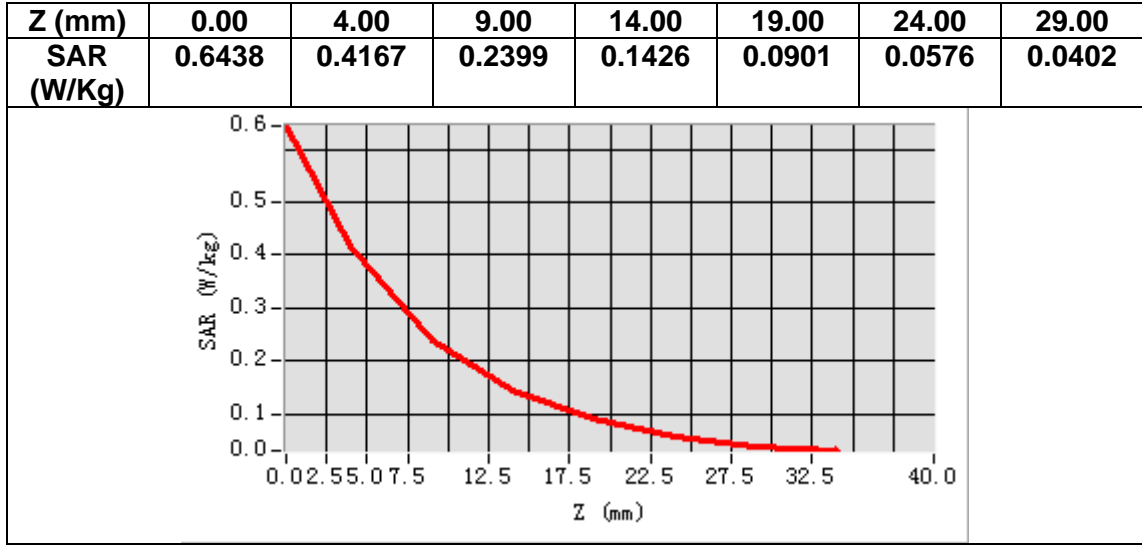

MEASUREMENT 15

A. Experimental conditions.

Area Scan	<u>dx=15mm dy=15mm, h= 5.00 mm</u>
ZoomScan	<u>5x5x7,dx=8mm dy=8mm dz=5mm</u>
Phantom	<u>Left head</u>
Device Position	<u>Cheek</u>
Band	<u>LTE band 4</u>
Channels	<u>Middle</u>
Signal	<u>LTE (Crest factor: 1.0)</u>

B. SAR Measurement Results

Frequency (MHz)	1732.500000
Relative permittivity (real part)	39.065289
Relative permittivity (imaginary part)	13.760592
Conductivity (S/m)	1.324457
Variation (%)	1.440000

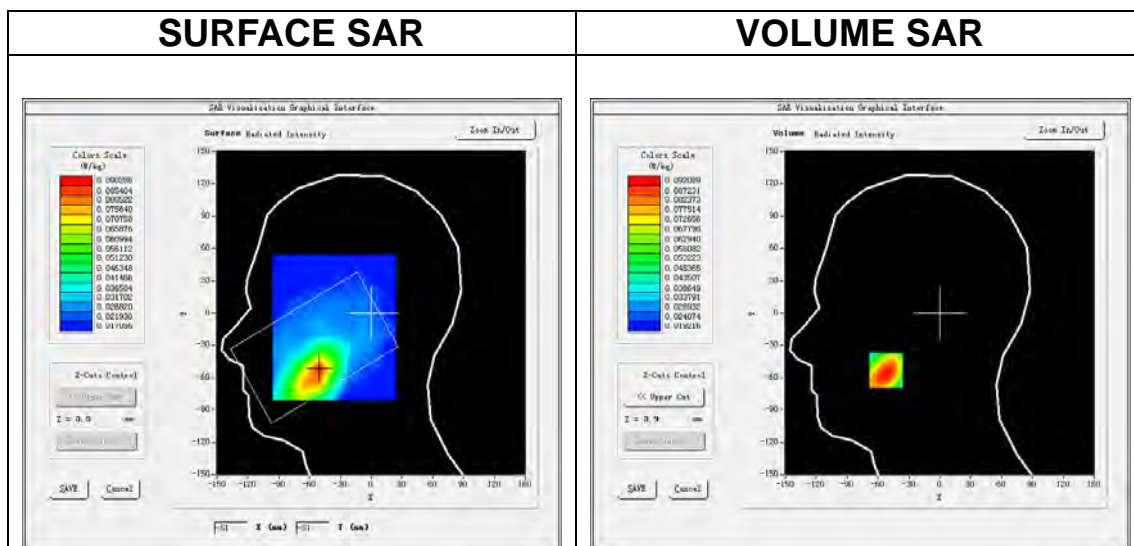

Maximum location: X=-52.00, Y=-53.00

SAR Peak: 0.13 W/kg

SAR 10g (W/Kg)	0.060720
SAR 1g (W/Kg)	0.090348

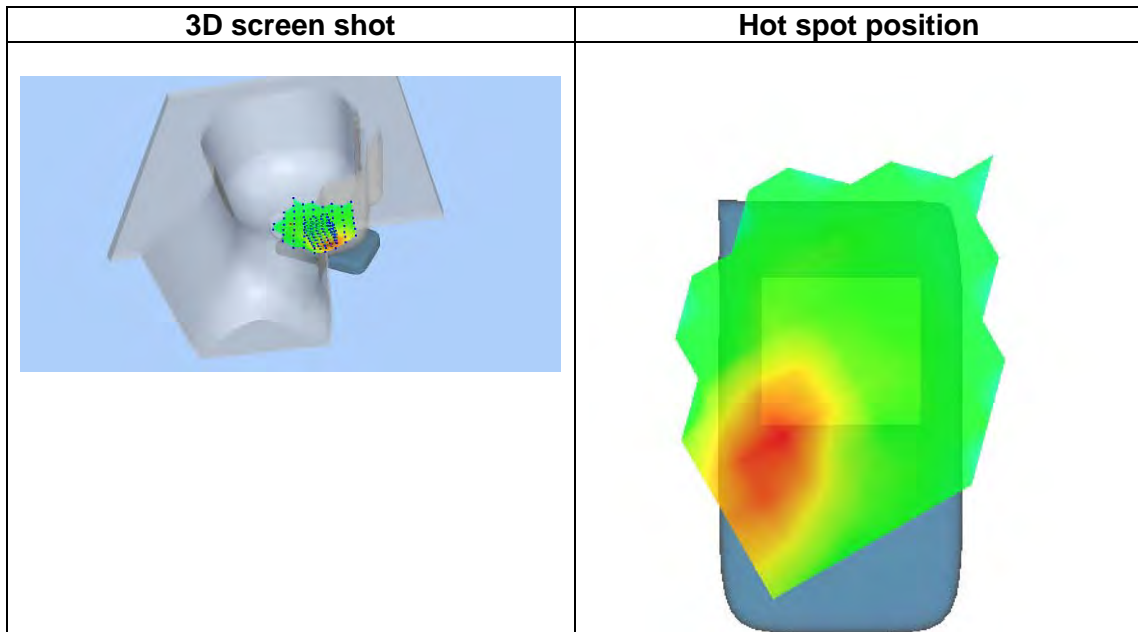
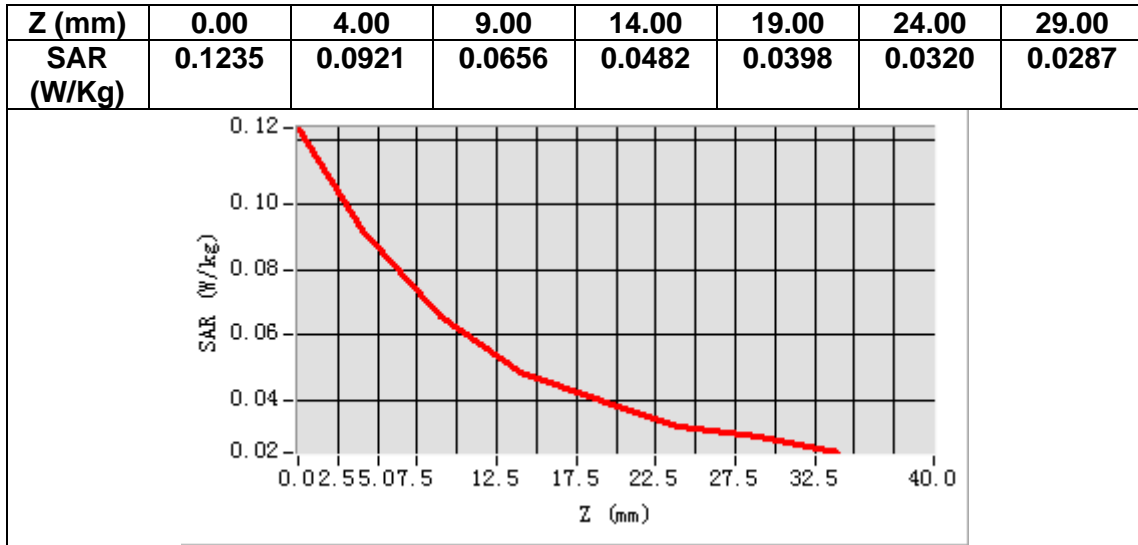

MEASUREMENT 16

A. Experimental conditions.

Area Scan	<u>dx=15mm dy=15mm, h= 5.00 mm</u>
ZoomScan	<u>5x5x7,dx=8mm dy=8mm dz=5mm</u>
Phantom	<u>Validation plane</u>
Device Position	<u>Body</u>
Band	<u>LTE band 4</u>
Channels	<u>Middle</u>
Signal	<u>LTE (Crest factor: 1.0)</u>

B. SAR Measurement Results

Frequency (MHz)	1732.500000
Relative permittivity (real part)	54.468365
Relative permittivity (imaginary part)	15.148220
Conductivity (S/m)	1.458016
Variation (%)	-2.990000

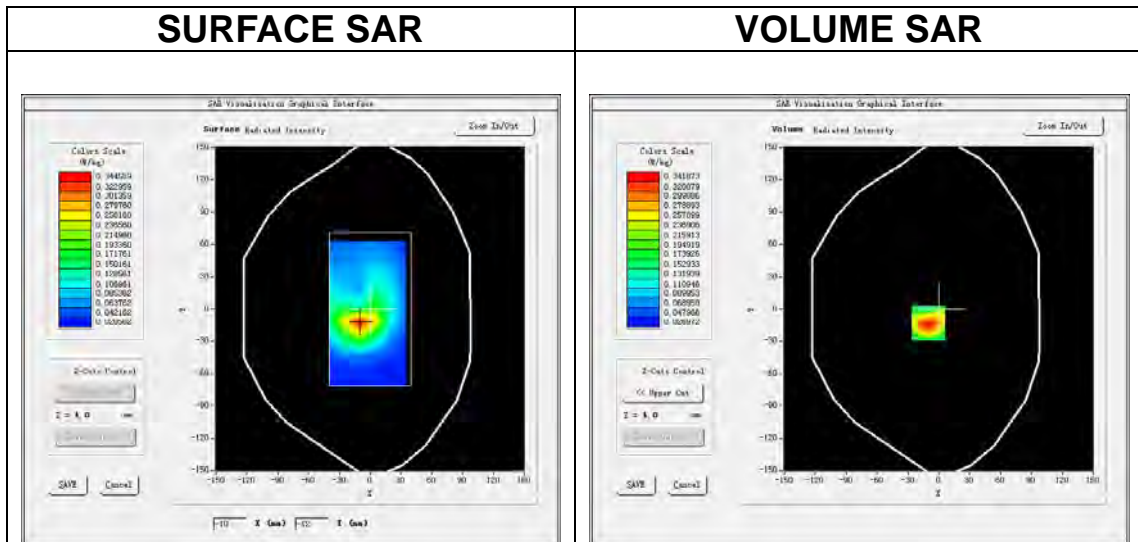

Maximum location: X=-10.00, Y=-13.00

SAR Peak: 0.51 W/kg

SAR 10g (W/Kg)	0.183185
SAR 1g (W/Kg)	0.323163

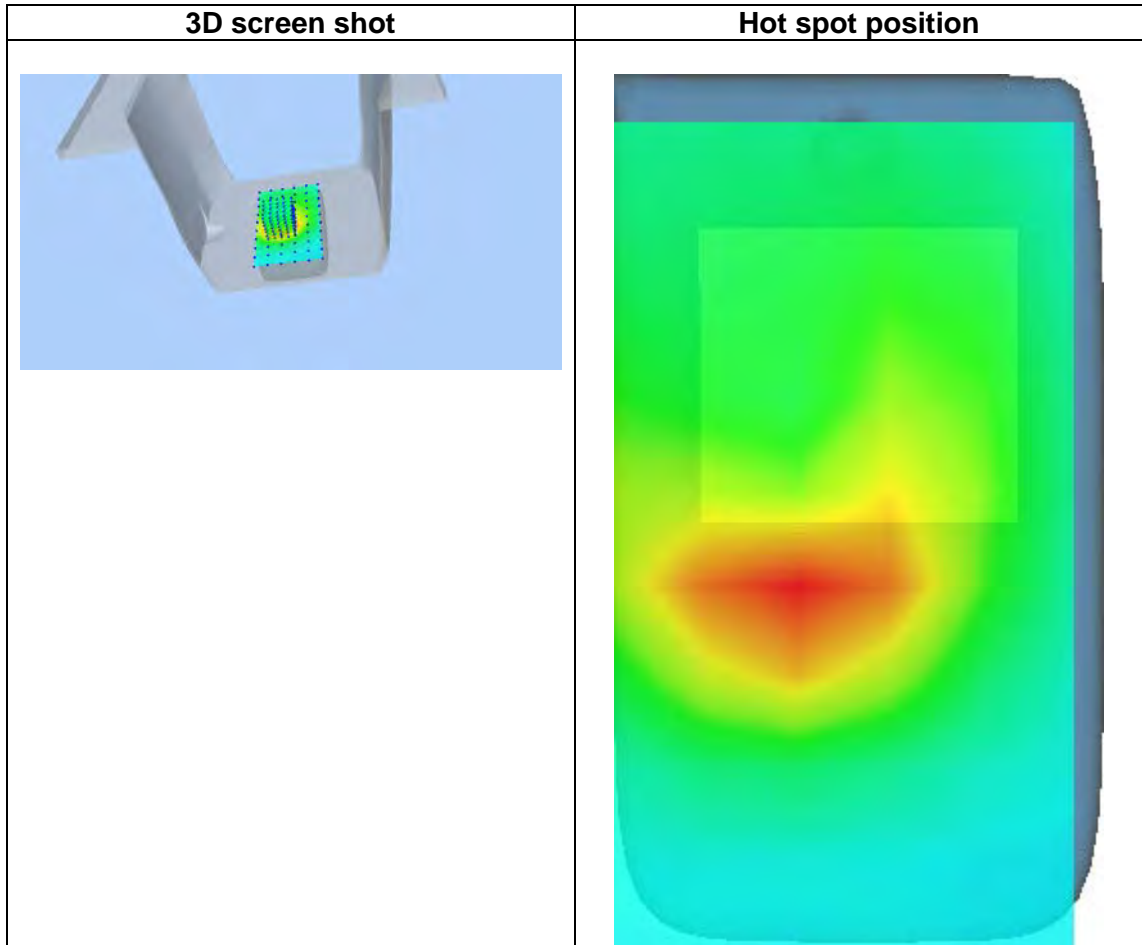
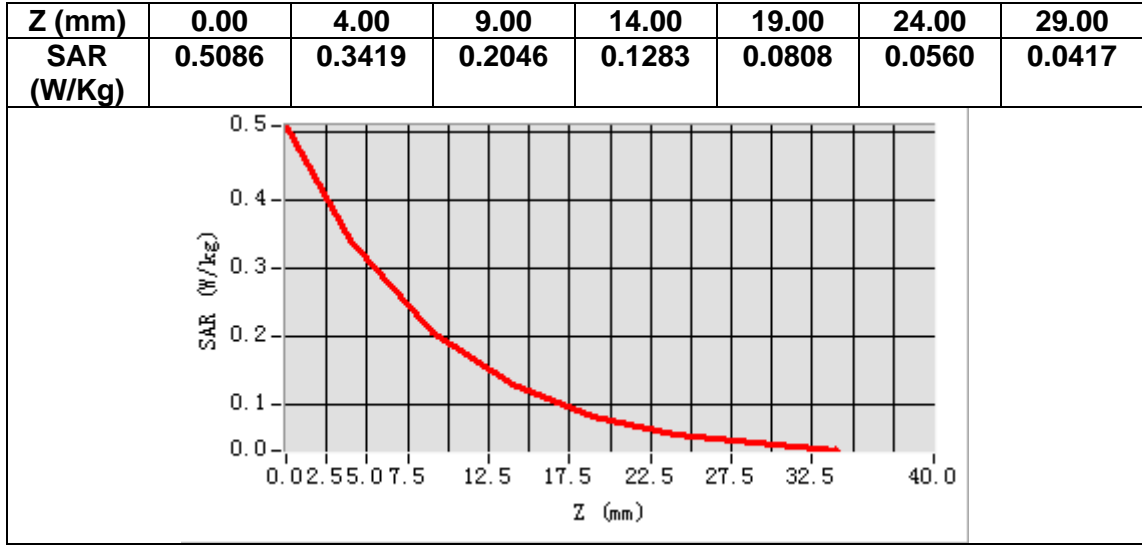

MEASUREMENT 17

A. Experimental conditions.

Area Scan	<u>dx=15mm dy=15mm, h= 5.00 mm</u>
ZoomScan	<u>5x5x7,dx=8mm dy=8mm dz=5mm</u>
Phantom	<u>Left head</u>
Device Position	<u>Cheek</u>
Band	<u>LTE band 5</u>
Channels	<u>Middle</u>
Signal	<u>LTE (Crest factor: 1.0)</u>

B. SAR Measurement Results

Frequency (MHz)	836.500000
Relative permittivity (real part)	40.693550
Relative permittivity (imaginary part)	19.970200
Conductivity (S/m)	0.928060
Variation (%)	1.240000

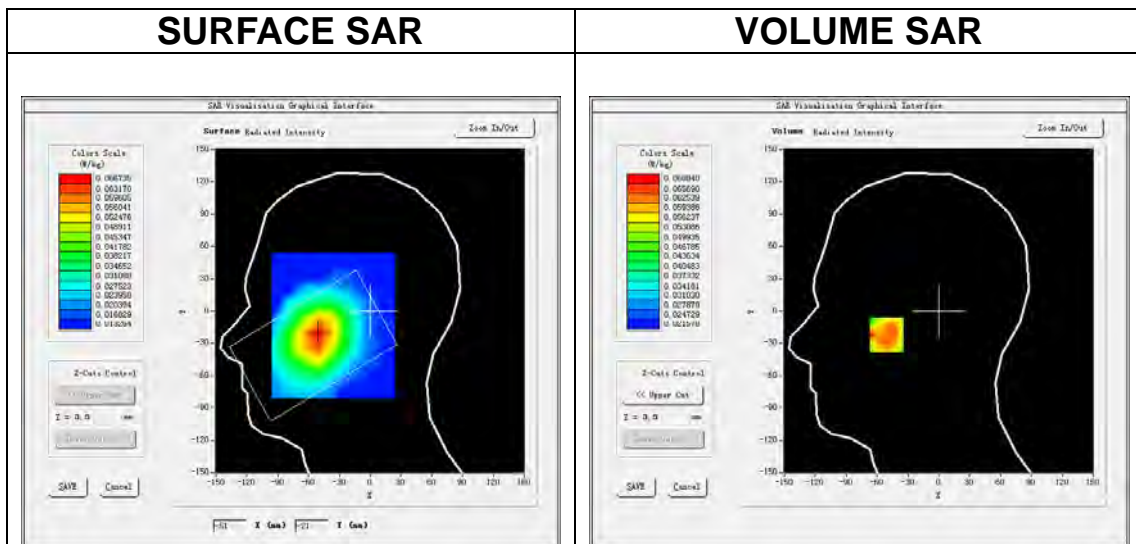

Maximum location: X=-51.00, Y=-22.00

SAR Peak: 0.10 W/kg

SAR 10g (W/Kg)	0.052216
SAR 1g (W/Kg)	0.064137

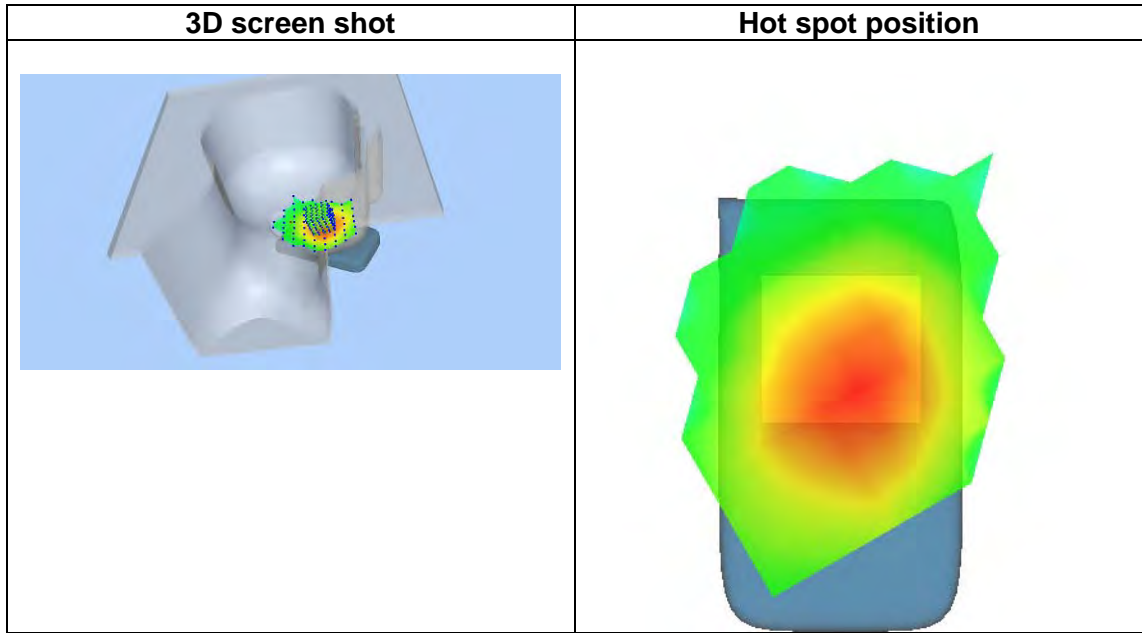
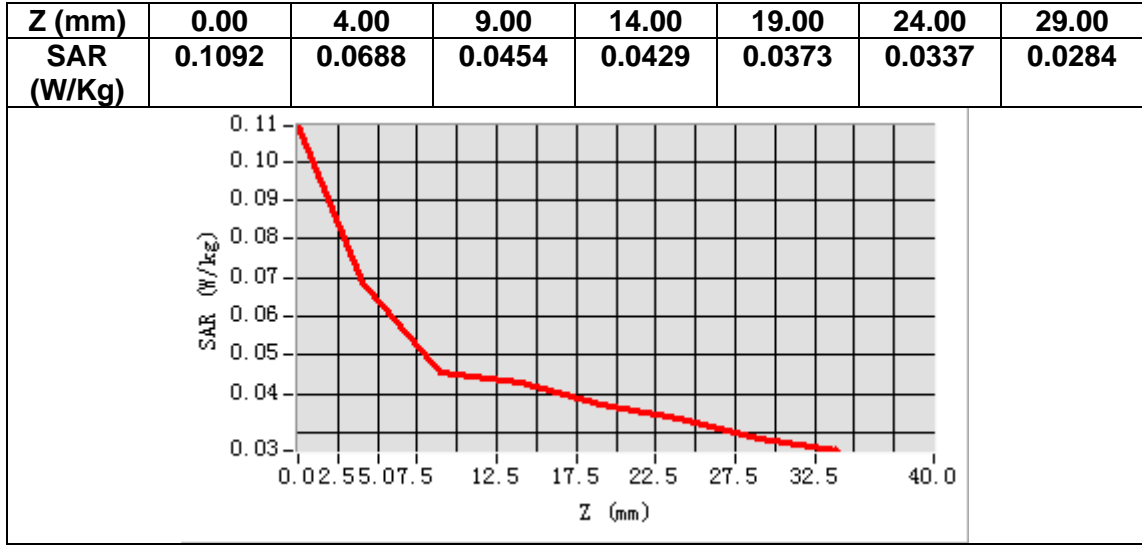

MEASUREMENT 18

A. Experimental conditions.

Area Scan	<u>dx=15mm dy=15mm, h= 5.00 mm</u>
ZoomScan	<u>5x5x7,dx=8mm dy=8mm dz=5mm</u>
Phantom	<u>Validation plane</u>
Device Position	<u>Body</u>
Band	<u>LTE band 5</u>
Channels	<u>Middle</u>
Signal	<u>LTE (Crest factor: 1.0)</u>

B. SAR Measurement Results

Frequency (MHz)	836.500000
Relative permittivity (real part)	54.523499
Relative permittivity (imaginary part)	21.167000
Conductivity (S/m)	0.983678
Variation (%)	-0.650000

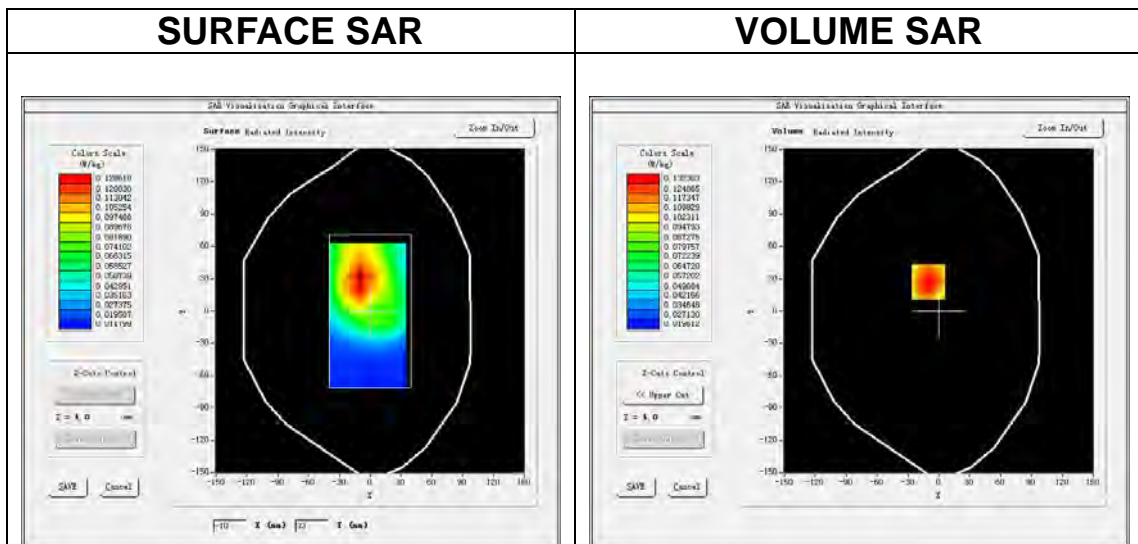

Maximum location: X=-10.00, Y=27.00

SAR Peak: 0.17 W/kg

SAR 10g (W/Kg)	0.093008
SAR 1g (W/Kg)	0.129341

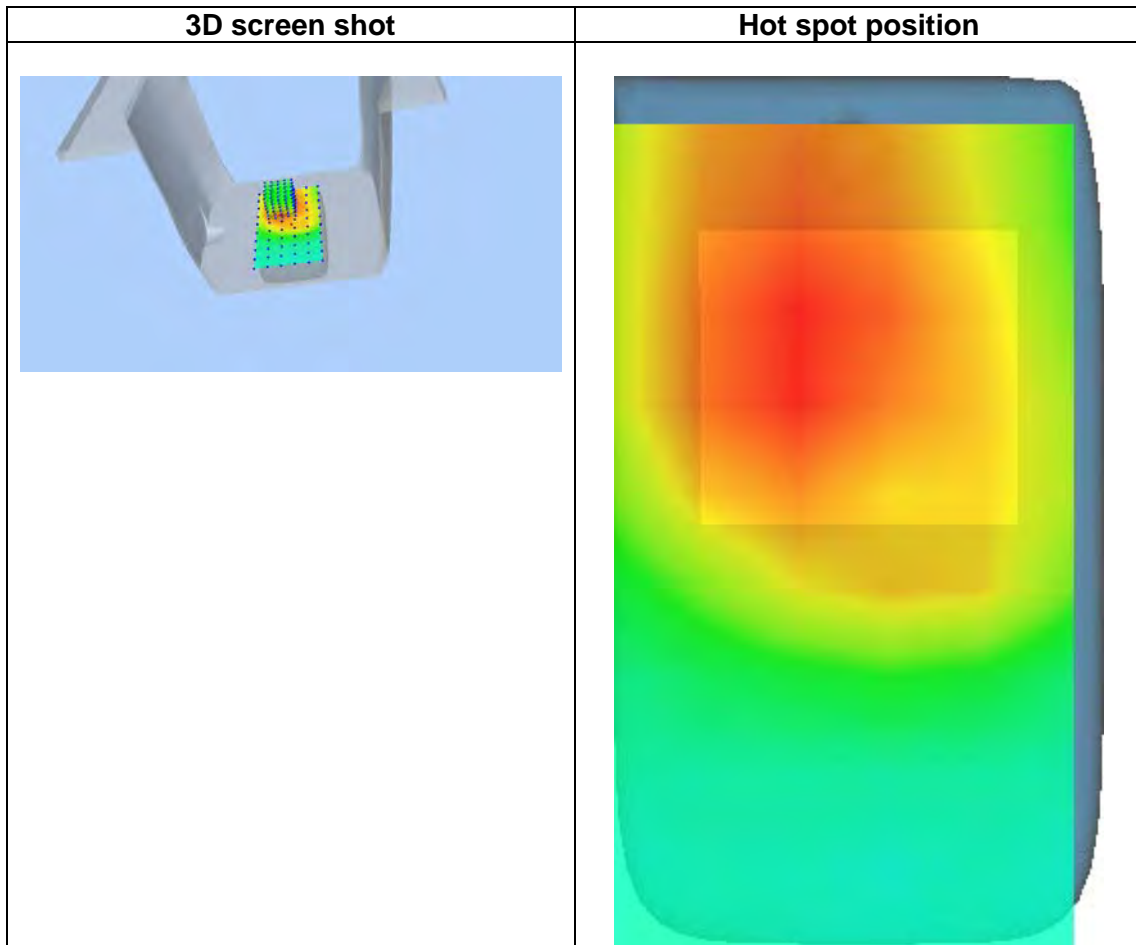
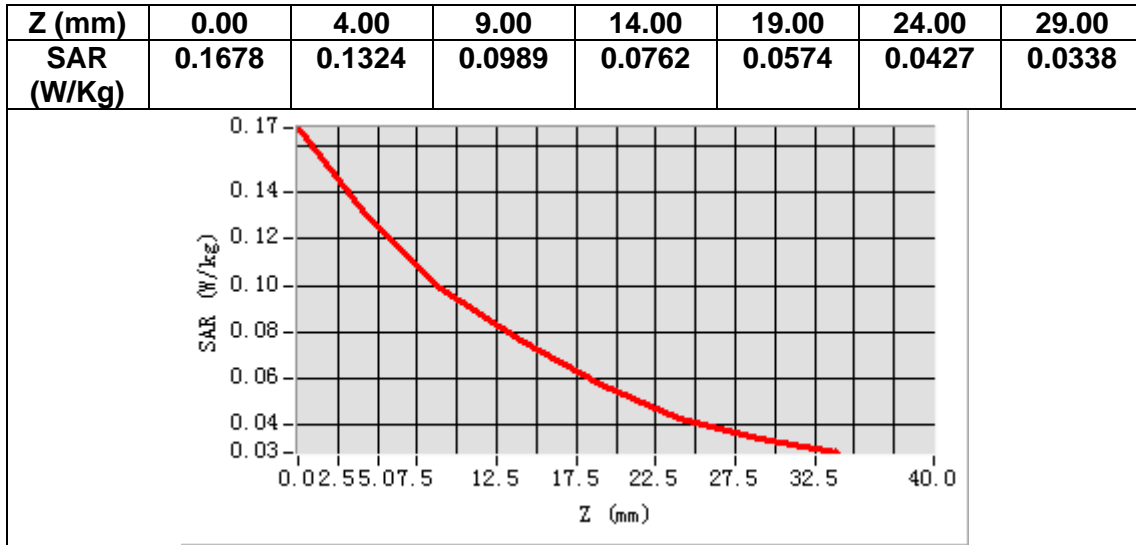

MEASUREMENT 19

A. Experimental conditions.

Area Scan	<u>dx=12mm dy=12mm, h= 5.00 mm</u>
ZoomScan	<u>7x7x7,dx=5mm dy=5mm dz=5mm</u>
Phantom	<u>Left head</u>
Device Position	<u>Cheek</u>
Band	<u>LTE band 7</u>
Channels	<u>Middle</u>
Signal	<u>LTE (Crest factor: 1.0)</u>

B. SAR Measurement Results

Frequency (MHz)	2535.000000
Relative permittivity (real part)	38.452484
Relative permittivity (imaginary part)	13.871160
Conductivity (S/m)	1.953522
Variation (%)	-1.260000

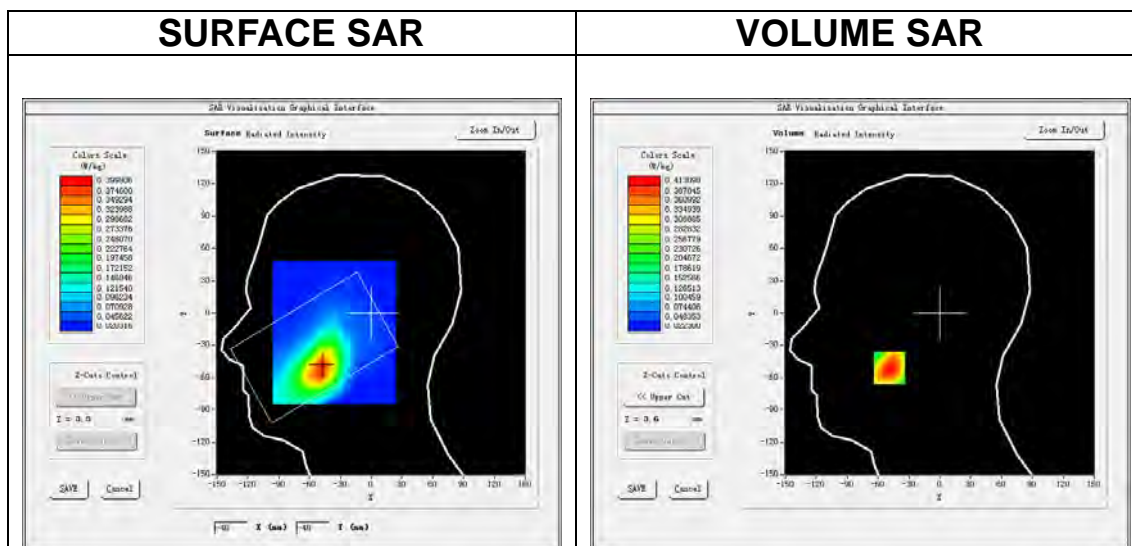

Maximum location: X=-49.00, Y=-51.00

SAR Peak: 0.64 W/kg

SAR 10g (W/Kg)	0.223928
SAR 1g (W/Kg)	0.397296

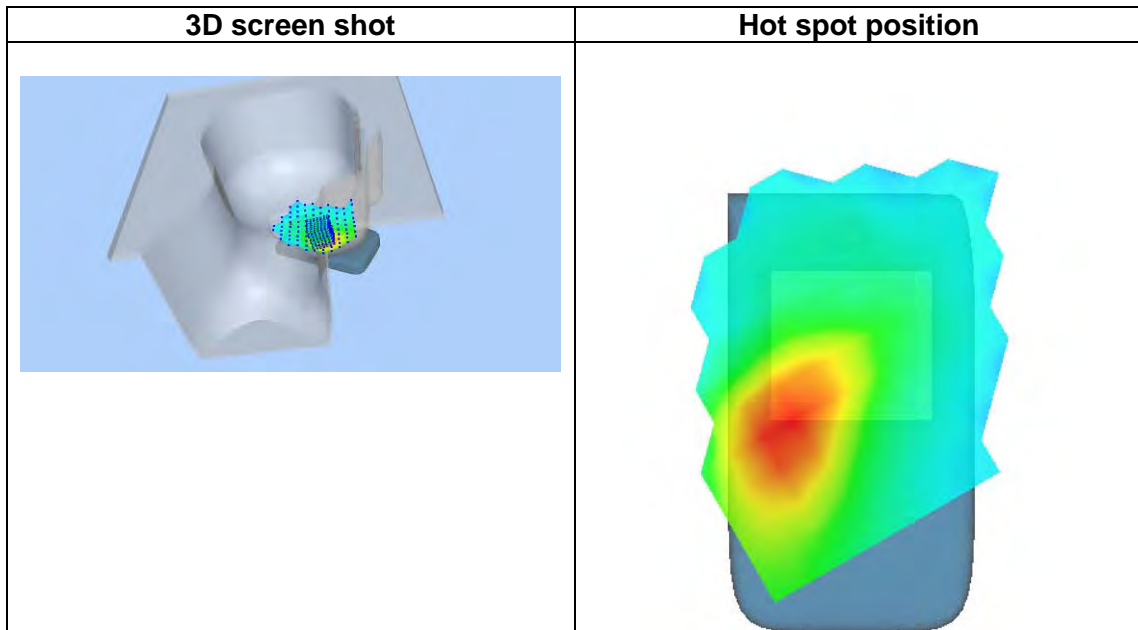
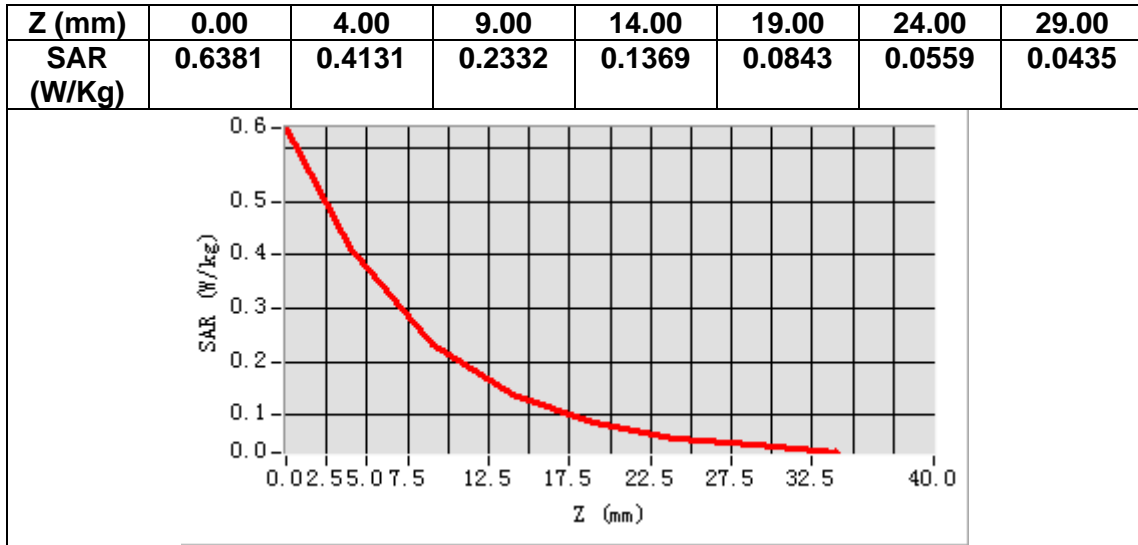

MEASUREMENT 20

A. Experimental conditions.

Area Scan	<u>dx=12mm dy=12mm, h= 5.00 mm</u>
ZoomScan	<u>7x7x7,dx=5mm dy=5mm dz=5mm</u>
Phantom	<u>Validation plane</u>
Device Position	<u>Body</u>
Band	<u>LTE band 7</u>
Channels	<u>Middle</u>
Signal	<u>LTE (Crest factor: 1.0)</u>

B. SAR Measurement Results

Frequency (MHz)	2535.000000
Relative permittivity (real part)	53.176945
Relative permittivity (imaginary part)	15.207840
Conductivity (S/m)	2.141771
Variation (%)	-1.150000

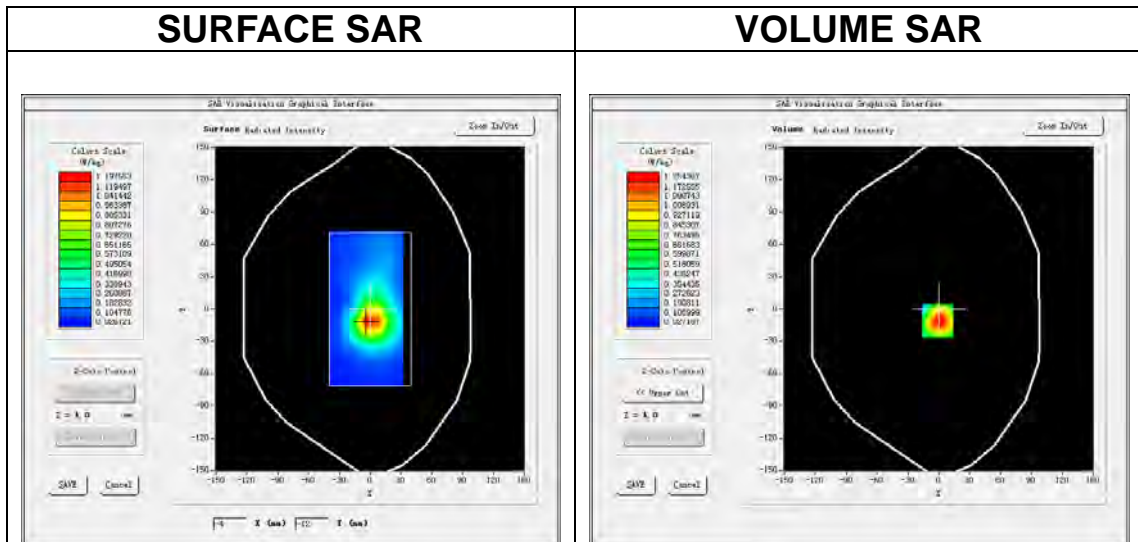

Maximum location: X=-1.00, Y=-11.00

SAR Peak: 2.08 W/kg

SAR 10g (W/Kg)	0.604165
SAR 1g (W/Kg)	1.005784

Z (mm)	0.00	4.00	9.00	14.00	19.00	24.00	29.00
SAR (W/Kg)	2.0924	1.2544	0.6282	0.3225	0.1688	0.0957	0.0594

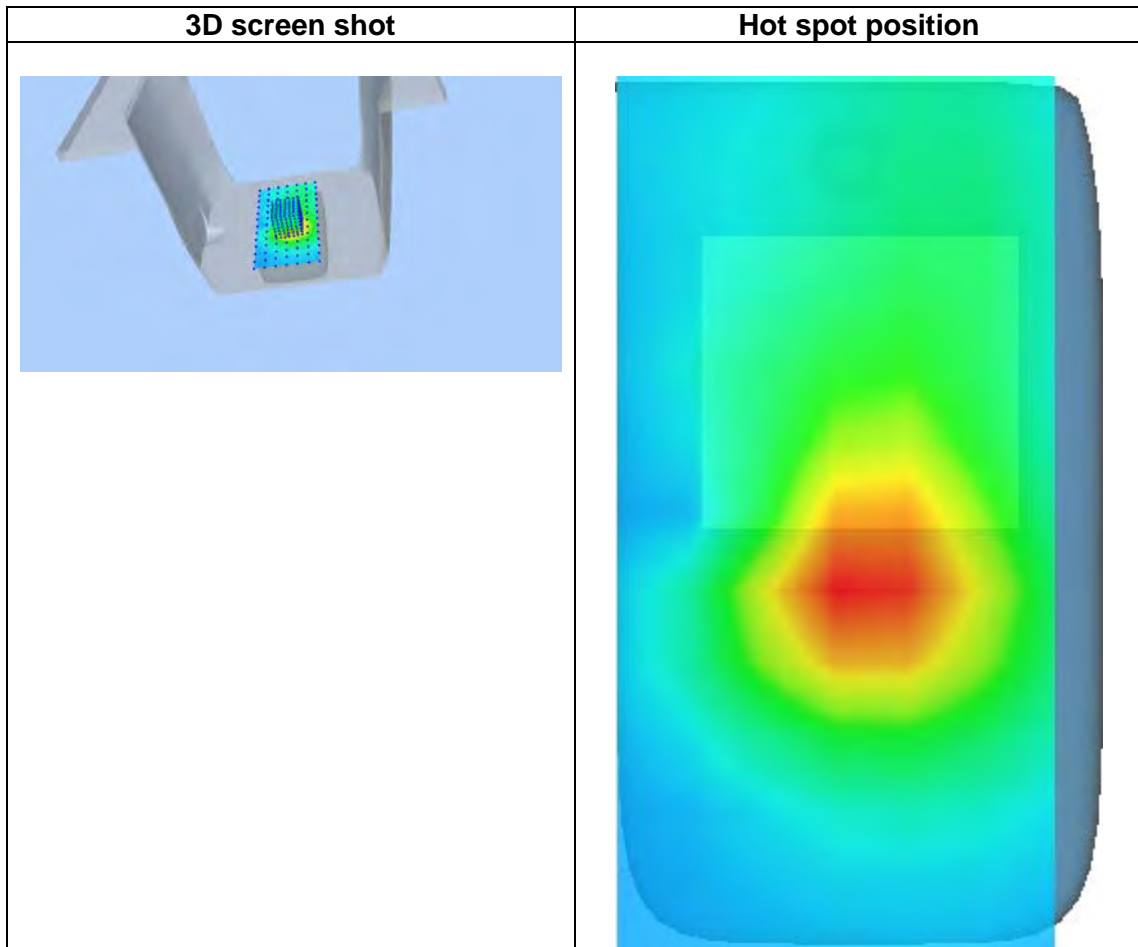
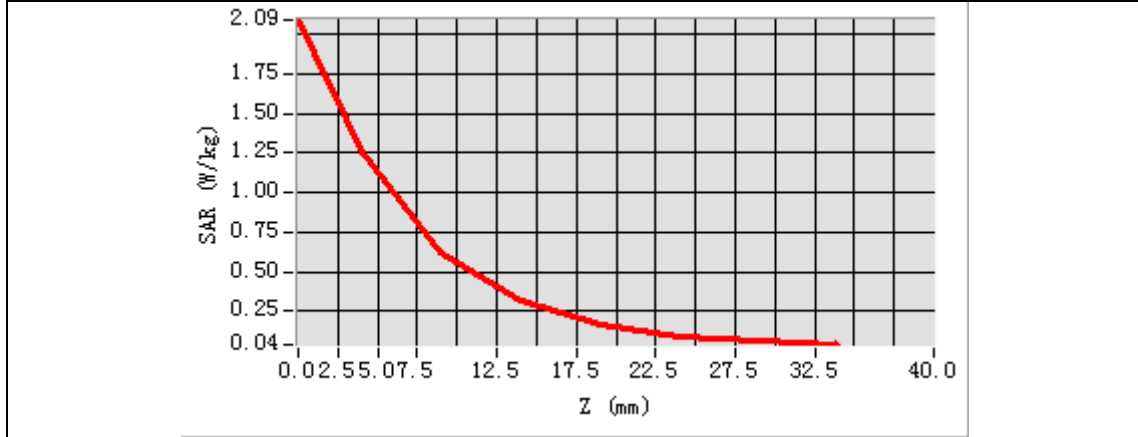

MEASUREMENT 21

A. Experimental conditions.

Area Scan	<u>dx=15mm dy=15mm, h= 5.00 mm</u>
ZoomScan	<u>5x5x7,dx=8mm dy=8mm dz=5mm</u>
Phantom	<u>Left head</u>
Device Position	<u>Cheek</u>
Band	<u>LTE band 12</u>
Channels	<u>Middle</u>
Signal	<u>LTE (Crest factor: 1.0)</u>

B. SAR Measurement Results

Frequency (MHz)	707.500000
Relative permittivity (real part)	42.077961
Relative permittivity (imaginary part)	22.097778
Conductivity (S/m)	0.868565
Variation (%)	-0.210000

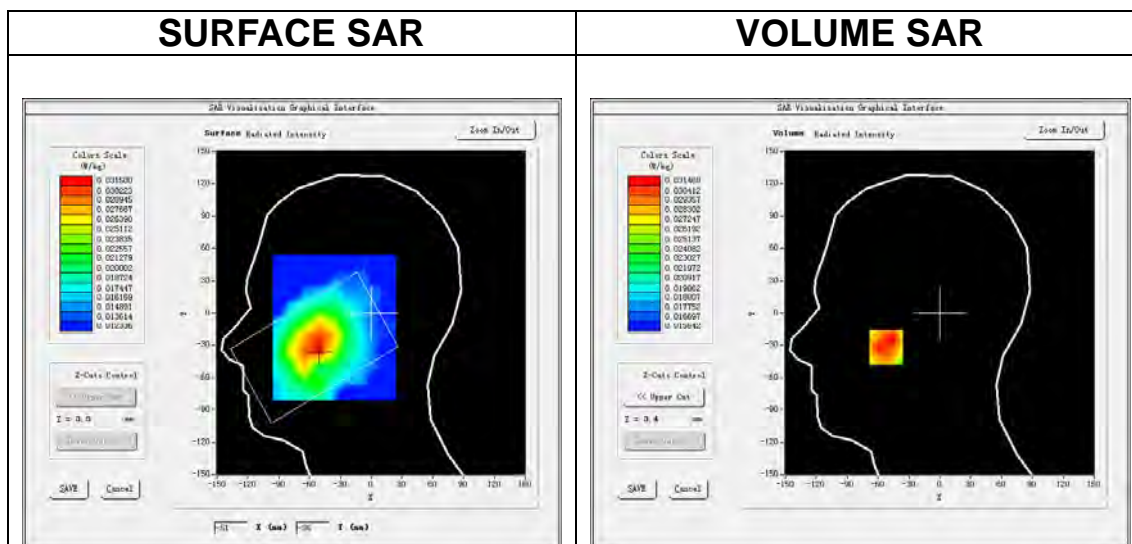

Maximum location: X=-52.00, Y=-32.00

SAR Peak: 0.04 W/kg

SAR 10g (W/Kg)	0.026571
SAR 1g (W/Kg)	0.031119

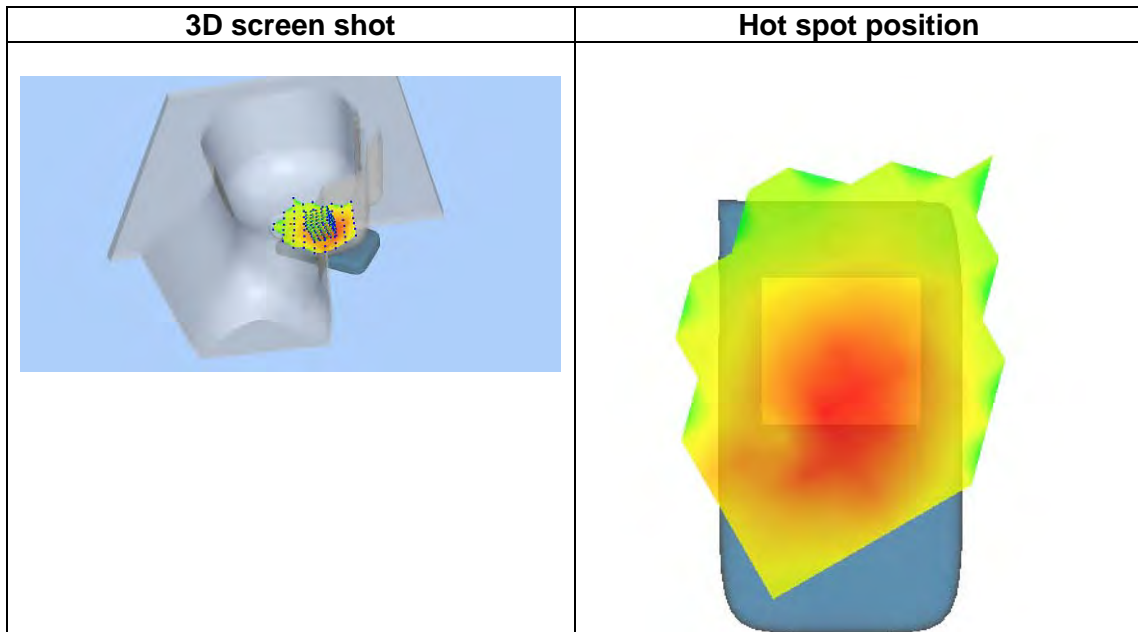
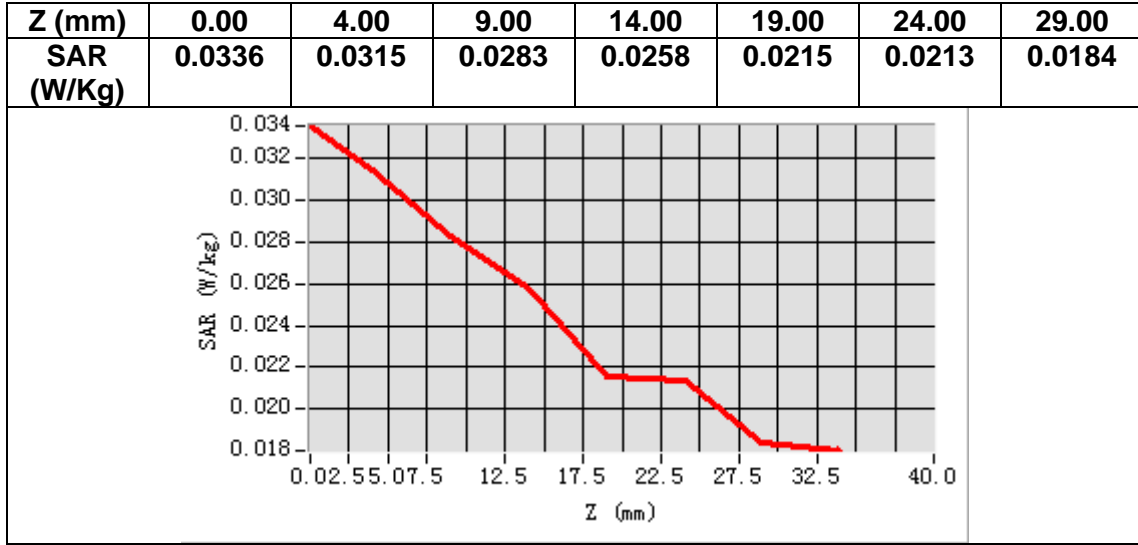

MEASUREMENT 22

A. Experimental conditions.

Area Scan	<u>dx=15mm dy=15mm, h= 5.00 mm</u>
ZoomScan	<u>5x5x7,dx=8mm dy=8mm dz=5mm</u>
Phantom	<u>Validation plane</u>
Device Position	<u>Body</u>
Band	<u>LTE band 12</u>
Channels	<u>Middle</u>
Signal	<u>LTE (Crest factor: 1.0)</u>

B. SAR Measurement Results

Frequency (MHz)	707.500000
Relative permittivity (real part)	55.977959
Relative permittivity (imaginary part)	23.531300
Conductivity (S/m)	0.924911
Variation (%)	-2.490000

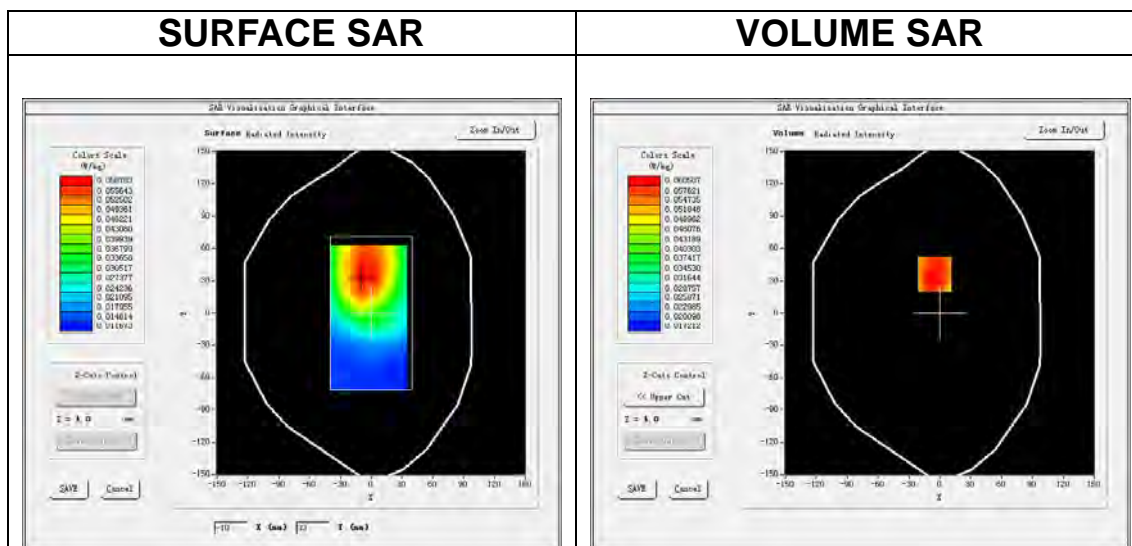

Maximum location: X=-5.00, Y=36.00

SAR Peak: 0.07 W/kg

SAR 10g (W/Kg)	0.047821
SAR 1g (W/Kg)	0.059578

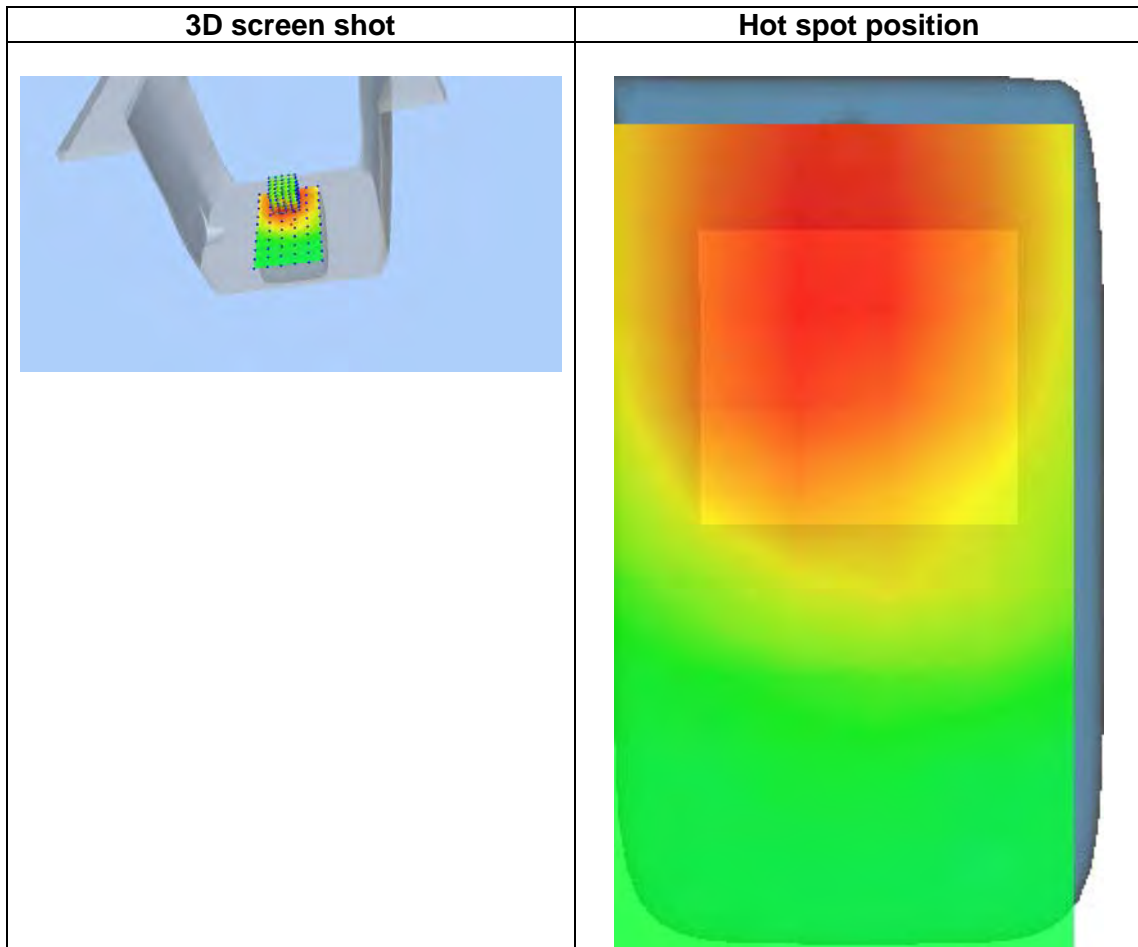
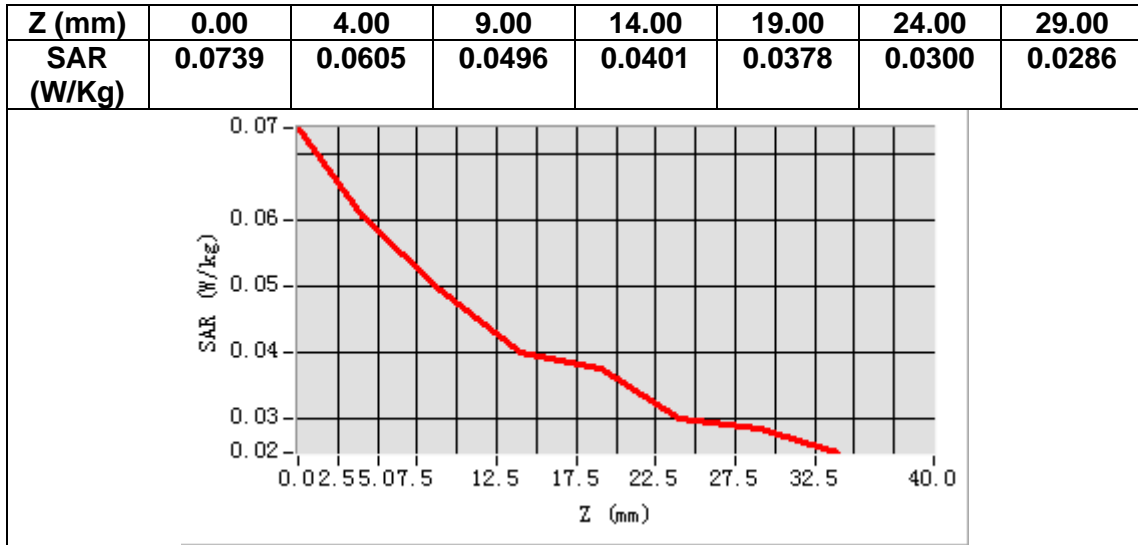

MEASUREMENT 23

A. Experimental conditions.

Area Scan	<u>dx=15mm dy=15mm, h= 5.00 mm</u>
ZoomScan	<u>5x5x7,dx=8mm dy=8mm dz=5mm</u>
Phantom	<u>Left head</u>
Device Position	<u>Cheek</u>
Band	<u>LTE band 17</u>
Channels	<u>Middle</u>
Signal	<u>LTE (Crest factor: 1.0)</u>

B. SAR Measurement Results

Frequency (MHz)	710.000000
Relative permittivity (real part)	42.056709
Relative permittivity (imaginary part)	22.126179
Conductivity (S/m)	0.872755
Variation (%)	2.250000

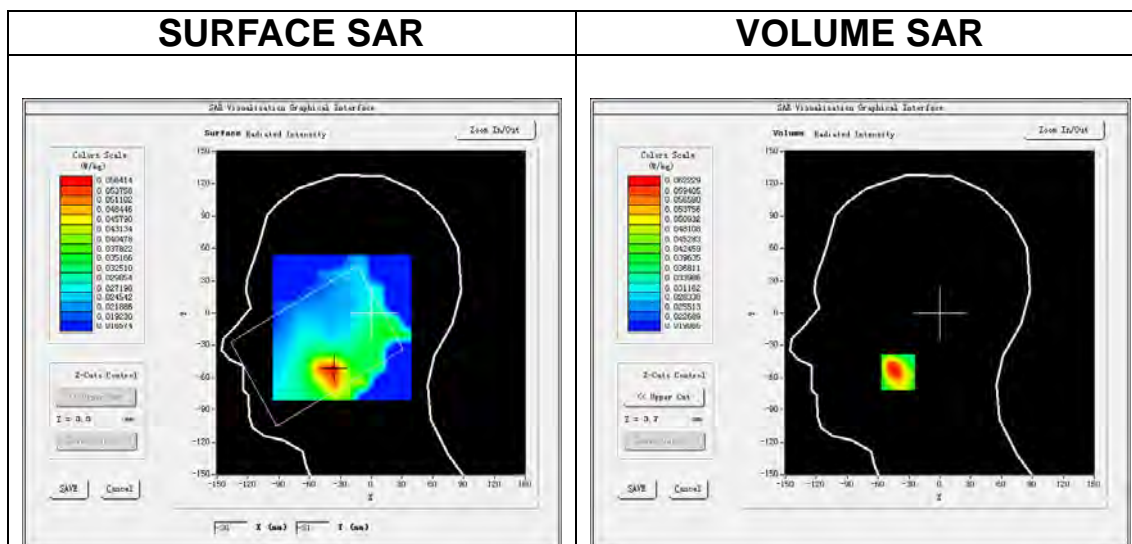

Maximum location: X=-39.00, Y=-55.00

SAR Peak: 0.10 W/kg

SAR 10g (W/Kg)	0.026980
SAR 1g (W/Kg)	0.042301

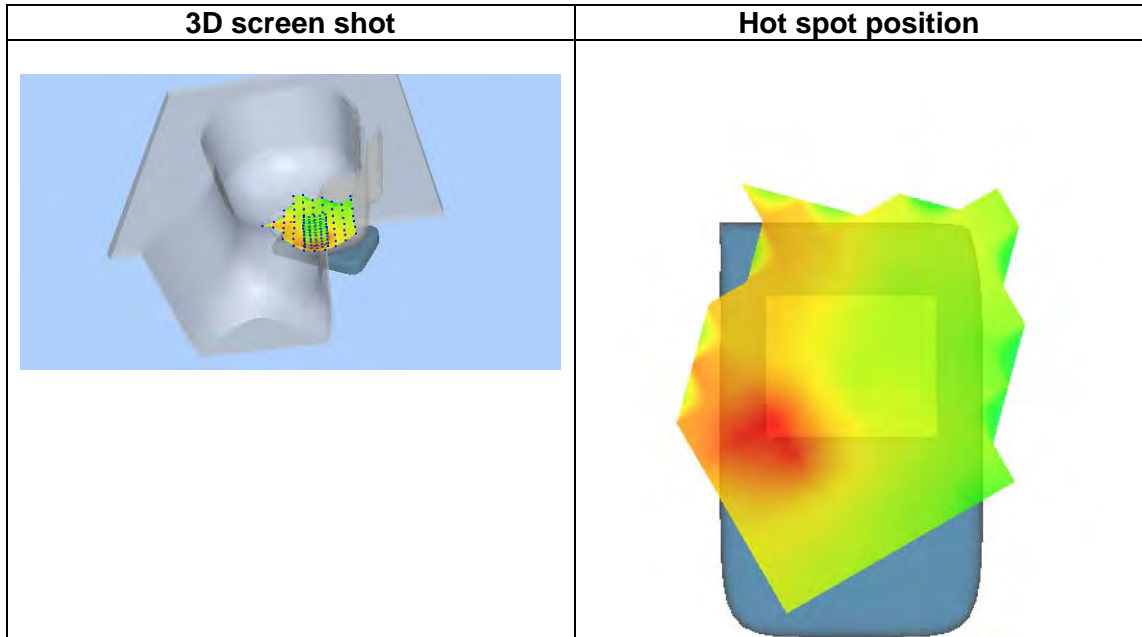
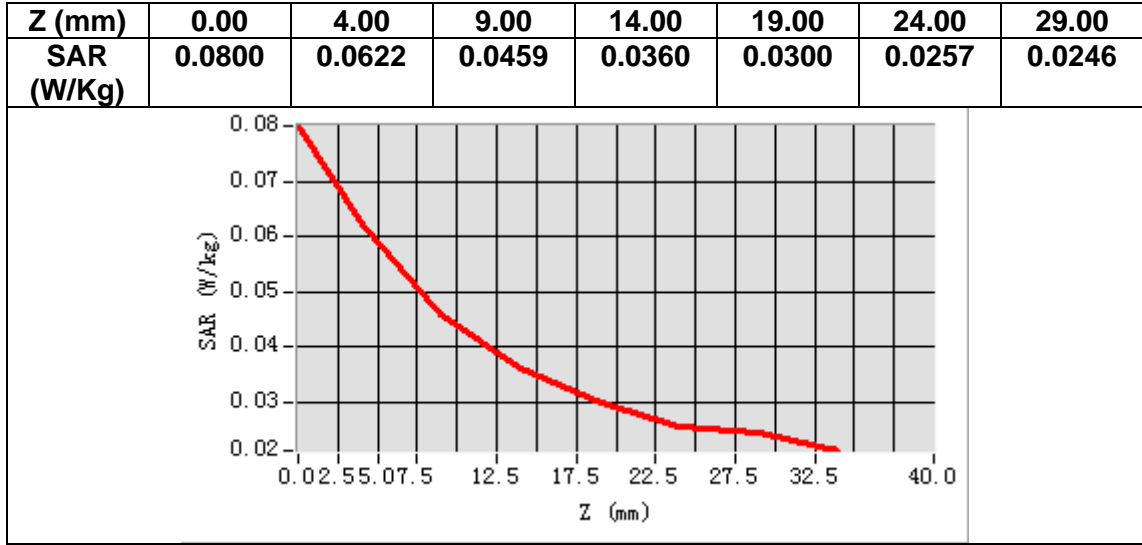

MEASUREMENT 24

A. Experimental conditions.

Area Scan	<u>dx=15mm dy=15mm, h= 5.00 mm</u>
ZoomScan	<u>5x5x7,dx=8mm dy=8mm dz=5mm</u>
Phantom	<u>Validation plane</u>
Device Position	<u>Body</u>
Band	<u>LTE band 17</u>
Channels	<u>Middle</u>
Signal	<u>LTE (Crest factor: 1.0)</u>

B. SAR Measurement Results

Frequency (MHz)	710.000000
Relative permittivity (real part)	55.956711
Relative permittivity (imaginary part)	23.550501
Conductivity (S/m)	0.928936
Variation (%)	-1.200000

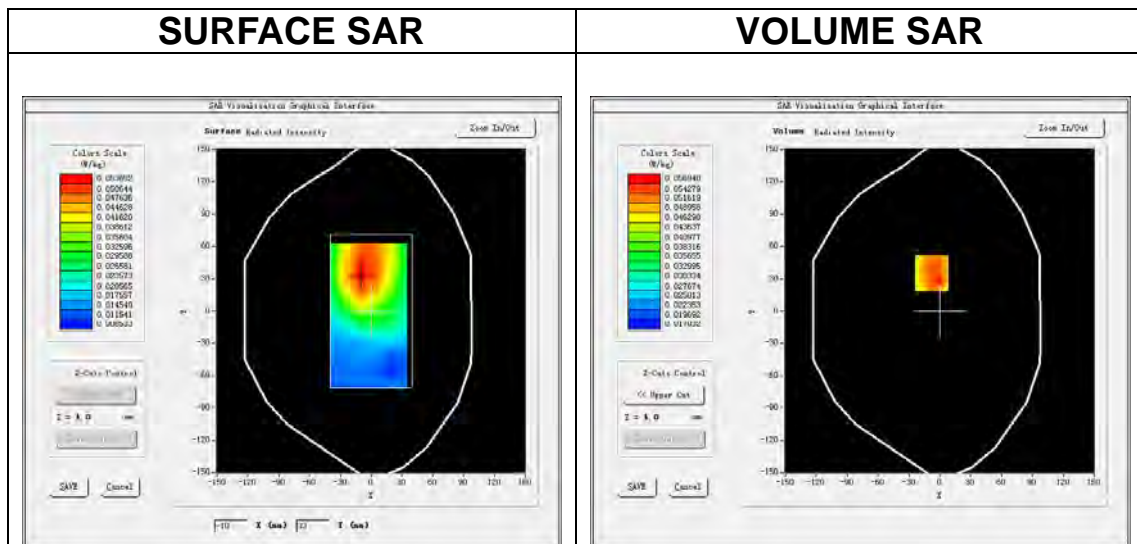

Maximum location: X=-8.00, Y=35.00

SAR Peak: 0.08 W/kg

SAR 10g (W/Kg)	0.043584
SAR 1g (W/Kg)	0.055362

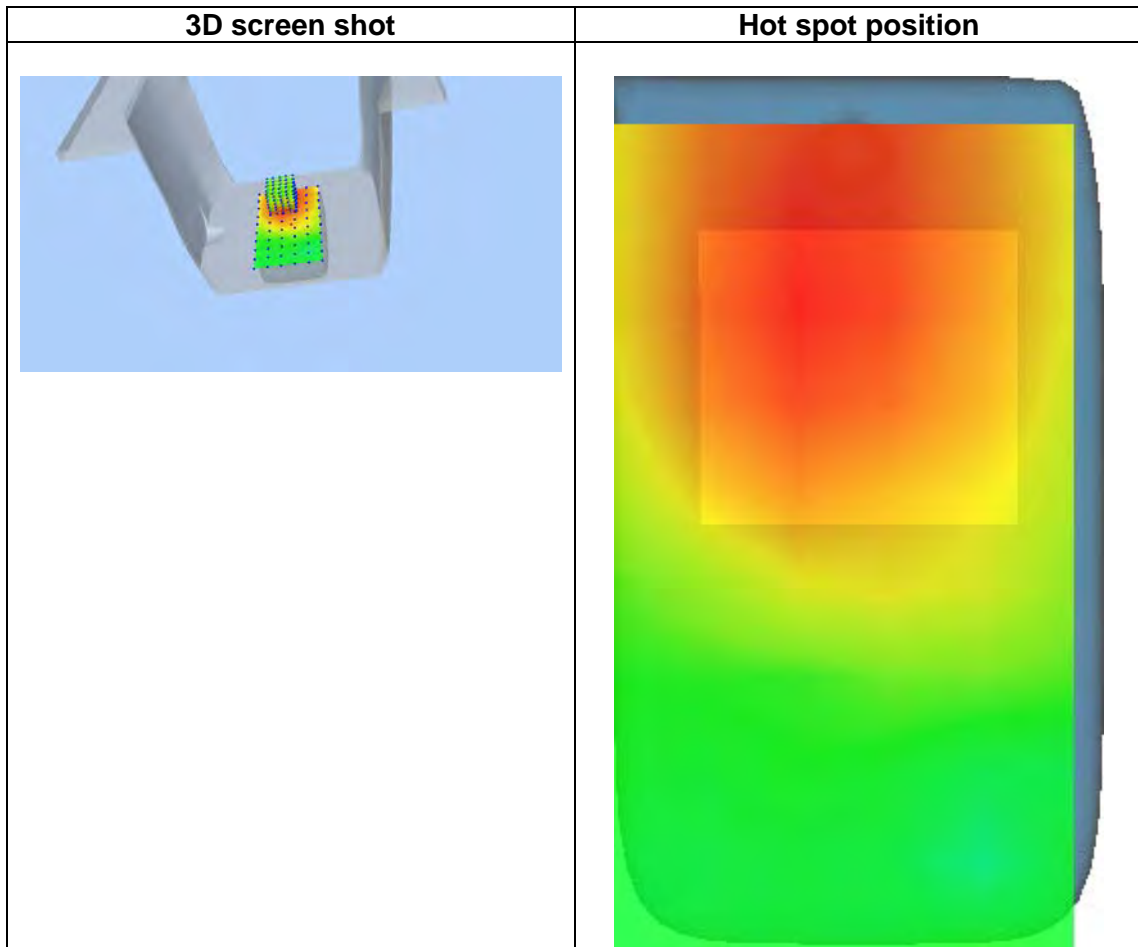
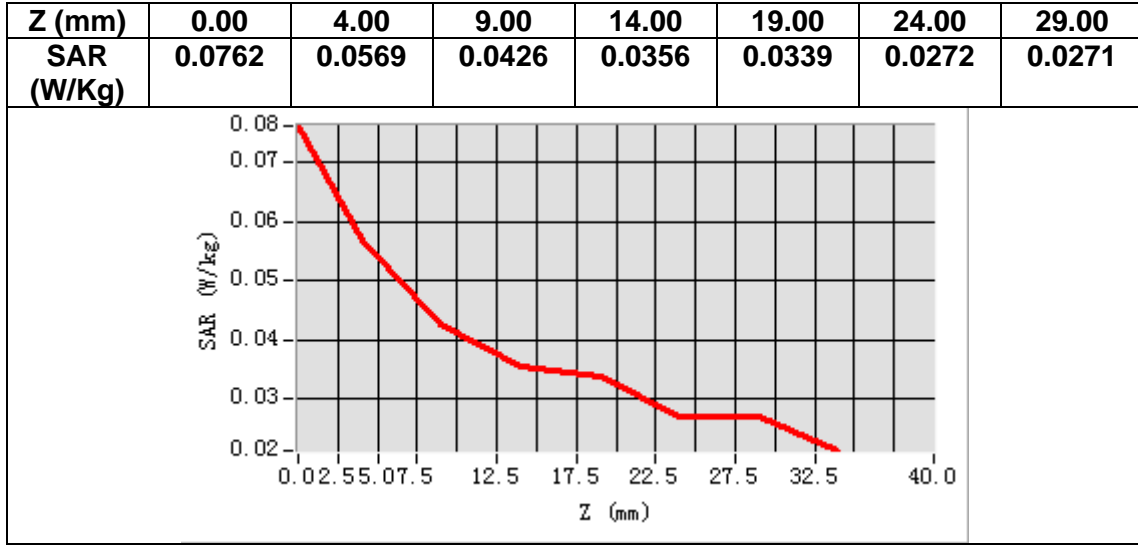

14. Appendix D. Calibration Certificate

Table of contents
E Field Probe - SN 08/16 EPGO287
750 MHz Dipole - SN 03/15 DIP 0G750-355
835 MHz Dipole - SN 03/15 DIP 0G835-347
1800 MHz Dipole - SN 03/15 DIP 1G800-349
1900 MHz Dipole - SN 03/15 DIP 1G900-350
2450 MHz Dipole - SN 03/15 DIP 2G450-352
2600 MHz Dipole - SN 03/15 DIP 2G600-356
Extended Calibration Certificate



COMOSAR E-Field Probe Calibration Report

Ref : ACR.260.1.18.SATU.A

**SHENZHEN NTEK TESTING TECHNOLOGY
CO., LTD.**

**BUILDING E, FENDA SCIENCE PARK, SANWEI
COMMUNITY, XIXIANG STREET,
BAO'AN DISTRICT, SHENZHEN GUANGDONG, CHINA
MVG COMOSAR DOSIMETRIC E-FIELD PROBE**

SERIAL NO.: SN 08/16 EPGO287

Calibrated at MVG US

2105 Barrett Park Dr. - Kennesaw, GA 30144



Calibration Date: 12/27/2019

Summary:

This document presents the method and results from an accredited COMOSAR Dosimetric E-Field Probe calibration performed in MVG USA using the CALISAR / CALIBAIR test bench, for use with a COMOSAR system only. All calibration results are traceable to national metrology institutions.



COMOSAR E-FIELD PROBE CALIBRATION REPORT

Ref: ACR.260.1.18.SATU.A

	<i>Name</i>	<i>Function</i>	<i>Date</i>	<i>Signature</i>
<i>Prepared by :</i>	Jérôme LUC	Product Manager	12/27/2019	<i>JL</i>
<i>Checked by :</i>	Jérôme LUC	Product Manager	12/27/2019	<i>JL</i>
<i>Approved by :</i>	Kim RUTKOWSKI	Quality Manager	12/27/2019	<i>Kim Rutkowski</i>

	<i>Customer Name</i>
<i>Distribution :</i>	SHENZHEN NTEK TESTING TECHNOLOGY CO., LTD.

<i>Issue</i>	<i>Date</i>	<i>Modifications</i>
A	12/27/2019	Initial release



COMOSAR E-FIELD PROBE CALIBRATION REPORT

Ref: ACR.260.1.18.SATU.A

TABLE OF CONTENTS

1 Device Under Test 4

2 Product Description 4

 2.1 General Information 4

3 Measurement Method 4

 3.1 Linearity 4

 3.2 Sensitivity 5

 3.3 Lower Detection Limit 5

 3.4 Isotropy 5

 3.5 Boundary Effect 5

4 Measurement Uncertainty 5

5 Calibration Measurement Results 6

 5.1 Sensitivity in air 6

 5.2 Linearity 7

 5.3 Sensitivity in liquid 7

 5.4 Isotropy 8

6 List of Equipment 10



COMOSAR E-FIELD PROBE CALIBRATION REPORT

Ref: ACR.260.1.18.SATU.A

1 DEVICE UNDER TEST

Device Under Test	
Device Type	COMOSAR DOSIMETRIC E FIELD PROBE
Manufacturer	MVG
Model	SSE2
Serial Number	SN 08/16 EPGO287
Product Condition (new / used)	Used
Frequency Range of Probe	0.15 GHz-6GHz
Resistance of Three Dipoles at Connector	Dipole 1: R1=0.209 MΩ Dipole 2: R2=0.196 MΩ Dipole 3: R3=0.197 MΩ

A yearly calibration interval is recommended.

2 PRODUCT DESCRIPTION

2.1 GENERAL INFORMATION

MVG’s COMOSAR E field Probes are built in accordance to the IEEE 1528, OET 65 Bulletin C and CEI/IEC 62209 standards.



Figure 1 – MVG COMOSAR Dosimetric E field Dipole

Probe Length	330 mm
Length of Individual Dipoles	2 mm
Maximum external diameter	8 mm
Probe Tip External Diameter	2.5 mm
Distance between dipoles / probe extremity	1 mm

3 MEASUREMENT METHOD

The IEEE 1528, OET 65 Bulletin C, CENELEC EN50361 and CEI/IEC 62209 standards provide recommended practices for the probe calibrations, including the performance characteristics of interest and methods by which to assess their affect. All calibrations / measurements performed meet the fore mentioned standards.

3.1 LINEARITY

The evaluation of the linearity was done in free space using the waveguide, performing a power sweep to cover the SAR range 0.01W/kg to 100W/kg.



COMOSAR E-FIELD PROBE CALIBRATION REPORT

Ref: ACR.260.1.18.SATU.A

3.2 SENSITIVITY

The sensitivity factors of the three dipoles were determined using a two step calibration method (air and tissue simulating liquid) using waveguides as outlined in the standards.

3.3 LOWER DETECTION LIMIT

The lower detection limit was assessed using the same measurement set up as used for the linearity measurement. The required lower detection limit is 10 mW/kg.

3.4 ISOTROPY

The axial isotropy was evaluated by exposing the probe to a reference wave from a standard dipole with the dipole mounted under the flat phantom in the test configuration suggested for system validations and checks. The probe was rotated along its main axis from 0 - 360 degrees in 15 degree steps. The hemispherical isotropy is determined by inserting the probe in a thin plastic box filled with tissue-equivalent liquid, with the plastic box illuminated with the fields from a half wave dipole. The dipole is rotated about its axis (0°–180°) in 15° increments. At each step the probe is rotated about its axis (0°–360°).

3.5 BOUNDARY EFFECT

The boundary effect is defined as the deviation between the SAR measured data and the expected exponential decay in the liquid when the probe is oriented normal to the interface. To evaluate this effect, the liquid filled flat phantom is exposed to fields from either a reference dipole or waveguide. With the probe normal to the phantom surface, the peak spatial average SAR is measured and compared to the analytical value at the surface.

4 MEASUREMENT UNCERTAINTY

The guidelines outlined in the IEEE 1528, OET 65 Bulletin C, CENELEC EN50361 and CEI/IEC 62209 standards were followed to generate the measurement uncertainty associated with an E-field probe calibration using the waveguide technique. All uncertainties listed below represent an expanded uncertainty expressed at approximately the 95% confidence level using a coverage factor of k=2, traceable to the Internationally Accepted Guides to Measurement Uncertainty.

Uncertainty analysis of the probe calibration in waveguide					
ERROR SOURCES	Uncertainty value (%)	Probability Distribution	Divisor	ci	Standard Uncertainty (%)
Incident or forward power	3.00%	Rectangular	$\sqrt{3}$	1	1.732%
Reflected power	3.00%	Rectangular	$\sqrt{3}$	1	1.732%
Liquid conductivity	5.00%	Rectangular	$\sqrt{3}$	1	2.887%
Liquid permittivity	4.00%	Rectangular	$\sqrt{3}$	1	2.309%
Field homogeneity	3.00%	Rectangular	$\sqrt{3}$	1	1.732%
Field probe positioning	5.00%	Rectangular	$\sqrt{3}$	1	2.887%
Field probe linearity	3.00%	Rectangular	$\sqrt{3}$	1	1.732%
Combined standard uncertainty					5.831%
Expanded uncertainty 95 % confidence level k = 2					12.0%



COMOSAR E-FIELD PROBE CALIBRATION REPORT

Ref: ACR.260.1.18.SATU.A

5 CALIBRATION MEASUREMENT RESULTS

Calibration Parameters	
Liquid Temperature	21 °C
Lab Temperature	21 °C
Lab Humidity	45 %

5.1 SENSITIVITY IN AIR

Normx dipole 1 ($\mu\text{V}/(\text{V}/\text{m})^2$)	Normy dipole 2 ($\mu\text{V}/(\text{V}/\text{m})^2$)	Normz dipole 3 ($\mu\text{V}/(\text{V}/\text{m})^2$)
0.66	0.75	0.58

DCP dipole 1 (mV)	DCP dipole 2 (mV)	DCP dipole 3 (mV)
93	93	98

Calibration curves $e_i=f(V)$ ($i=1,2,3$) allow to obtain H-field value using the formula:

$$E = \sqrt{E_1^2 + E_2^2 + E_3^2}$$

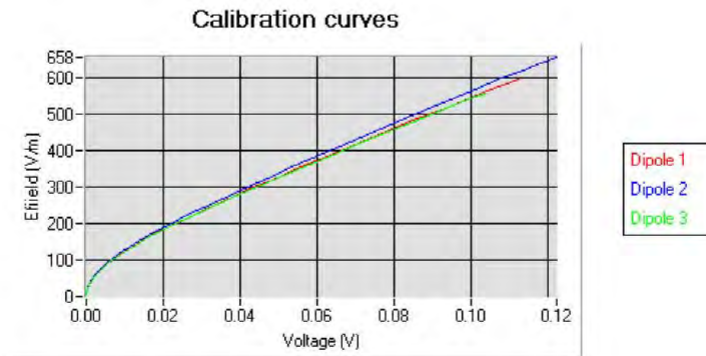



COMOSAR E-FIELD PROBE CALIBRATION REPORT

Ref: ACR.260.1.18.SATU.A

5.2 LINEARITY

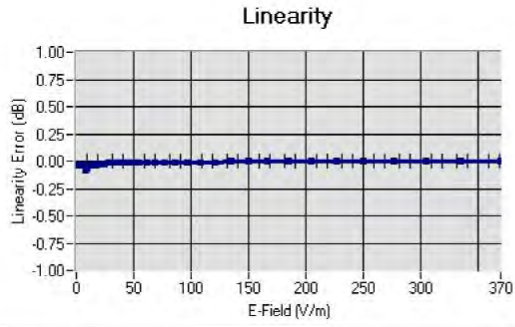

Linearity: $\pm 1.89\%$ ($\pm 0.08\text{dB}$)

5.3 SENSITIVITY IN LIQUID

Liquid	Frequency (MHz +/- 100MHz)	Permittivity	Epsilon (S/m)	ConvF
HL750	750	40.03	0.93	1.45
BL750	750	56.83	1.00	1.49
HL850	835	42.19	0.90	1.50
BL850	835	54.67	1.01	1.56
HL900	900	42.08	1.01	1.51
HL1800	1800	41.68	1.46	1.71
BL1800	1800	53.86	1.46	1.77
HL1900	1900	38.45	1.45	2.03
BL1900	1900	53.32	1.56	2.07
HL2000	2000	38.26	1.38	1.76
HL2450	2450	37.50	1.80	2.00
BL2450	2450	53.22	1.89	2.08
HL2600	2600	39.80	1.99	2.12
BL2600	2600	52.52	2.23	2.19
HL5200	5200	35.64	4.67	2.55
BL5200	5200	48.64	5.51	2.62
HL5400	5400	36.44	4.87	2.53
BL5400	5400	46.52	5.77	2.59
HL5600	5600	36.66	5.17	2.64
BL5600	5600	46.79	5.77	2.73
HL5800	5800	35.31	5.31	2.72
BL5800	5800	47.04	6.10	2.81

LOWER DETECTION LIMIT: 7mW/kg



COMOSAR E-FIELD PROBE CALIBRATION REPORT

Ref: ACR.260.1.18.SATU.A

5.4 ISOTROPY

HL900 MHz

- Axial isotropy: 0.04 dB
- Hemispherical isotropy: 0.07 dB

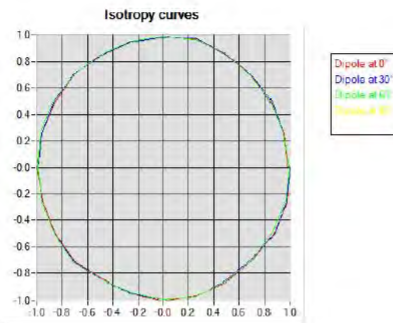

HL1800 MHz

- Axial isotropy: 0.06 dB
- Hemispherical isotropy: 0.08 dB

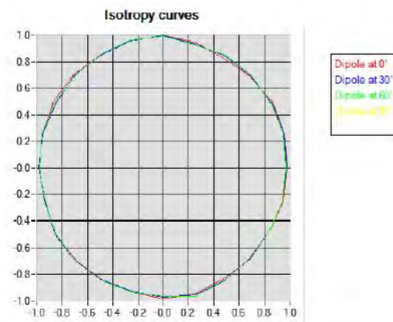



COMOSAR E-FIELD PROBE CALIBRATION REPORT

Ref: ACR.260.1.18.SATU.A

HL5600 MHz

- Axial isotropy: 0.06 dB
- Hemispherical isotropy: 0.08 dB

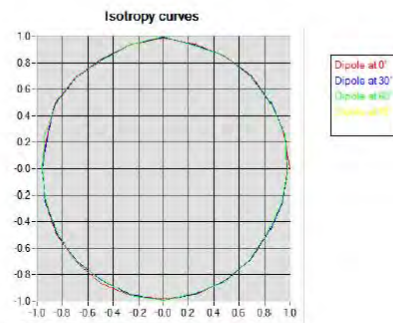



COMOSAR E-FIELD PROBE CALIBRATION REPORT

Ref: ACR.260.1.18.SATU.A

6 LIST OF EQUIPMENT

Equipment Summary Sheet				
Equipment Description	Manufacturer / Model	Identification No.	Current Calibration Date	Next Calibration Date
Flat Phantom	MVG	SN-20/09-SAM71	Validated. No cal required.	Validated. No cal required.
COMOSAR Test Bench	Version 3	NA	Validated. No cal required.	Validated. No cal required.
Network Analyzer	Rhode & Schwarz ZVA	SN100132	02/2019	02/2022
Reference Probe	MVG	EP 94 SN 37/08	10/2019	10/2020
Multimeter	Keithley 2000	1188656	01/2017	01/2020
Signal Generator	Agilent E4438C	MY49070581	01/2017	01/2020
Amplifier	Aethercomm	SN 046	Characterized prior to test. No cal required.	Characterized prior to test. No cal required.
Power Meter	HP E4418A	US38261498	01/2017	01/2020
Power Sensor	HP ECP-E26A	US37181460	01/2017	01/2020
Directional Coupler	Narda 4216-20	01386	Characterized prior to test. No cal required.	Characterized prior to test. No cal required.
Waveguide	Mega Industries	069Y7-158-13-712	Validated. No cal required.	Validated. No cal required.
Waveguide Transition	Mega Industries	069Y7-158-13-701	Validated. No cal required.	Validated. No cal required.
Waveguide Termination	Mega Industries	069Y7-158-13-701	Validated. No cal required.	Validated. No cal required.
Temperature / Humidity Sensor	Control Company	150798832	11/2017	11/2020



SAR Reference Dipole Calibration Report

Ref : ACR.109.1.18.SATU.A

**SHENZHEN NTEK TESTING TECHNOLOGY
CO., LTD.**

**BUILDING E, FENDA SCIENCE PARK, SANWEI
COMMUNITY, XIXIANG STREET,
BAO'AN DISTRICT, SHENZHEN GUANGDONG, CHINA
MVG COMOSAR REFERENCE DIPOLE**

FREQUENCY: 750 MHZ

SERIAL NO.: SN 03/15 DIP 0G750-355

Calibrated at MVG US

2105 Barrett Park Dr. - Kennesaw, GA 30144



Calibration Date: 04/19/2018

Summary:

This document presents the method and results from an accredited SAR reference dipole calibration performed in MVG USA using the COMOSAR test bench. All calibration results are traceable to national metrology institutions.



SAR REFERENCE DIPOLE CALIBRATION REPORT

Ref: ACR.109.1.18.SATU.A

	<i>Name</i>	<i>Function</i>	<i>Date</i>	<i>Signature</i>
<i>Prepared by :</i>	Jérôme LUC	Product Manager	4/19/2018	<i>JS</i>
<i>Checked by :</i>	Jérôme LUC	Product Manager	4/19/2018	<i>JS</i>
<i>Approved by :</i>	Kim RUTKOWSKI	Quality Manager	4/19/2018	<i>Kim Rutkowski</i>

	<i>Customer Name</i>
<i>Distribution :</i>	SHENZHEN NTEK TESTING TECHNOLOGY CO., LTD.

<i>Issue</i>	<i>Date</i>	<i>Modifications</i>
A	4/19/2018	Initial release



SAR REFERENCE DIPOLE CALIBRATION REPORT

Ref: ACR.109.1.18.SATU.A

TABLE OF CONTENTS

1	Introduction	4
2	Device Under Test	4
3	Product Description	4
3.1	General Information	4
4	Measurement Method	5
4.1	Return Loss Requirements	5
4.2	Mechanical Requirements	5
5	Measurement Uncertainty	5
5.1	Return Loss	5
5.2	Dimension Measurement	5
5.3	Validation Measurement	5
6	Calibration Measurement Results	6
6.1	Return Loss and Impedance In Head Liquid	6
6.2	Return Loss and Impedance In Body Liquid	6
6.3	Mechanical Dimensions	6
7	Validation measurement	7
7.1	Head Liquid Measurement	7
7.2	SAR Measurement Result With Head Liquid	8
7.3	Body Liquid Measurement	9
7.4	SAR Measurement Result With Body Liquid	10
8	List of Equipment	11